

旧上瀬谷通信施設地区
土地区画整理事業

環境影響評価書

【 資料編 】

2分冊の2

令和4年3月

横 浜 市

本書に掲載した地図の下図は、国土地理院発行の電子地形図 25000 又は電子地形図 (タイル) を加工して作成したものである。

総目次

【2分冊の1】

第1章 都市計画決定権者の名称等.....	1-1
第2章 都市計画対象事業の目的及び内容.....	2-1
第3章 対象事業実施区域及びその周辺の概況.....	3-1
第4章 計画段階配慮事項並びに調査、予測及び評価の方法.....	4-1
第5章 計画段階配慮事項の調査、予測及び評価の結果.....	5-1
第6章 配慮書についての意見及びそれに対する都市計画決定権者の見解.....	6-1
第7章 方法書についての意見及びそれに対する都市計画決定権者の見解.....	7-1

【2分冊の2】

第8章 環境影響評価の項目並びに調査、予測及び評価の方法.....	8-1
第9章 環境影響評価の調査結果並びに予測及び評価の結果.....	9.1 (大気) -1
第10章 環境保全措置の検討.....	10-1
第11章 事後調査等.....	11-1
第12章 総合評価.....	12-1
第13章 環境影響を受ける範囲と認められる地域.....	13-1
第14章 準備書についての意見及びそれに対する都市計画決定権者の見解.....	14-1
第15章 環境影響評価準備書からの相違点.....	15-1
第16章 評価書についての意見及び都市計画決定権者の対応.....	16-1
第17章 評価書の補正.....	17-1
第18章 環境影響評価の受託者の名称.....	18-1

資料編

【2分冊の1】

資料 9.1 大気質.....	資料 大気-1
資料 9.2 騒音.....	資料 騒音-1
資料 9.3 振動.....	資料 振動-1
資料 9.6 地下水.....	資料 地下水-1
資料 9.9 土壌汚染.....	資料 土壌汚染-1
資料 9.11 植物.....	資料 植物-1

【2分冊の2】

資料 9.17 地域社会.....	資料 地域-1
資料 14.1 審査会に提出した資料.....	資料 審査会-1

【2分冊の2】 目 次

資料 9.17 地域社会	資料	地域-1
9.17-1 自動車交通量現地調査結果.....	資料	地域-1
9.17-2 交差点における横断歩道部歩行者等調査結果.....	資料	地域-599
9.17-3 渋滞長調査結果.....	資料	地域-846
9.17-4 信号現示調査結果.....	資料	地域-889
9.17-5 飽和交通流率調査結果.....	資料	地域-911
9.17-6 将来交通量の算定について.....	資料	地域-962
9.17-7 交差点需要率.....	資料	地域-994
9.17-8 工事用車両の運行に係る環境保全措置実施後の交差点需要率.....	資料	地域-1044
資料 14.1 審査会に提出した資料	資料	審査会-1
14.1-1 審査会に提出した資料.....	資料	審査会-1

資料 9.17 地域社会

9.17-1 自動車交通量現地調査結果

対象事業実施区域周辺の主要交差点（7交差点）において、平日・休日・混雑時に実施した調査結果は、平日はP.資料 地域-2～200、休日はP.資料 地域-201～399、混雑時はP.資料 地域-400～598 に示すとおりです。

方向別自動車交通量調査表

調査地点：地域社会1 目黒

調査年月日：令和元年 5月14日(火) 天候：雨のち曇り

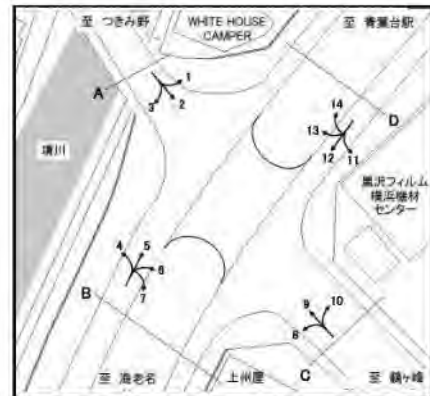

方向 時間帯	1						2					
	種別 小型車 (台)	大型車 (台)	合計 (台)	大型車 混入率 (%)	時係 数 (%)	二輪車 (台)	種別 小型車 (台)	大型車 (台)	合計 (台)	大型車 混入率 (%)	時係 数 (%)	二輪車 (台)
7:00-7:15	17	4	21	19.0	1.1	0	61	27	88	30.7	1.5	7
7:15-7:30	24	6	30	20.0	1.6	1	59	18	77	23.4	1.3	11
7:30-7:45	20	8	28	28.6	1.5	3	58	19	77	24.7	1.3	2
7:45-8:00	21	3	24	12.5	1.3	0	72	12	84	14.3	1.5	13
1時間計	82	21	103	20.4	5.6	4	250	76	326	23.3	5.6	33
8:00-8:15	18	7	25	28.0	1.4	0	63	11	74	14.9	1.3	15
8:15-8:30	24	6	30	20.0	1.6	1	58	25	83	30.1	1.4	9
8:30-8:45	20	3	23	13.0	1.3	2	66	15	81	18.5	1.4	8
8:45-9:00	21	8	29	27.6	1.6	0	51	17	68	25.0	1.2	3
1時間計	83	24	107	22.4	5.8	3	238	68	306	22.2	5.3	35
9:00-9:15	15	10	25	40.0	1.4	0	54	24	78	30.8	1.4	2
9:15-9:30	9	4	13	30.8	0.7	0	32	9	41	22.0	0.7	0
9:30-9:45	24	7	31	22.6	1.7	0	47	28	75	37.3	1.3	2
9:45-10:00	12	11	23	47.8	1.3	0	45	23	68	33.8	1.2	2
1時間計	60	32	92	34.8	5.0	0	178	84	262	32.1	4.5	6
10:00-10:15	23	13	36	36.1	2.0	1	45	22	67	32.8	1.2	4
10:15-10:30	25	6	31	19.4	1.7	0	51	25	76	32.9	1.3	1
10:30-10:45	21	7	28	25.0	1.5	0	48	25	73	34.2	1.3	0
10:45-11:00	14	7	21	33.3	1.1	0	44	27	71	38.0	1.2	0
1時間計	83	33	116	28.4	6.3	1	188	99	287	34.5	5.0	5
11:00-11:15	15	8	23	34.8	1.3	0	54	27	81	33.3	1.4	1
11:15-11:30	17	8	25	32.0	1.4	0	53	28	81	34.6	1.4	2
11:30-11:45	18	9	27	33.3	1.5	1	63	23	86	26.7	1.5	0
11:45-12:00	13	8	21	38.1	1.1	0	62	23	85	27.1	1.5	0
1時間計	63	33	96	34.4	5.2	1	232	101	333	30.3	5.8	3
12:00-12:15	9	4	13	30.8	0.7	1	40	20	60	33.3	1.0	0
12:15-12:30	13	4	17	23.5	0.9	0	58	19	77	24.7	1.3	3
12:30-12:45	24	7	31	22.6	1.7	0	53	17	70	24.3	1.2	2
12:45-13:00	21	7	28	25.0	1.5	0	63	11	74	14.9	1.3	1
1時間計	67	22	89	24.7	4.9	1	214	67	281	23.8	4.9	6
13:00-13:15	25	5	30	16.7	1.6	0	54	15	69	21.7	1.2	0
13:15-13:30	16	5	21	23.8	1.1	0	47	12	59	20.3	1.0	0
13:30-13:45	20	5	25	20.0	1.4	0	57	17	74	23.0	1.3	3
13:45-14:00	21	11	32	34.4	1.7	0	64	13	77	16.9	1.3	1
1時間計	82	26	108	24.1	5.9	0	222	57	279	20.4	4.8	4
14:00-14:15	21	4	25	16.0	1.4	0	49	23	72	31.9	1.2	0
14:15-14:30	11	3	14	21.4	0.8	0	64	22	86	25.6	1.5	1
14:30-14:45	25	7	32	21.9	1.7	0	53	21	74	28.4	1.3	2
14:45-15:00	16	4	20	20.0	1.1	0	65	18	83	21.7	1.4	4
1時間計	73	18	91	19.8	5.0	0	231	84	315	26.7	5.5	7

方向別自動車交通量調査表

調査地点：地域社会1 目黒

調査年月日：令和元年 5月14日(火) 天候：雨のち曇り

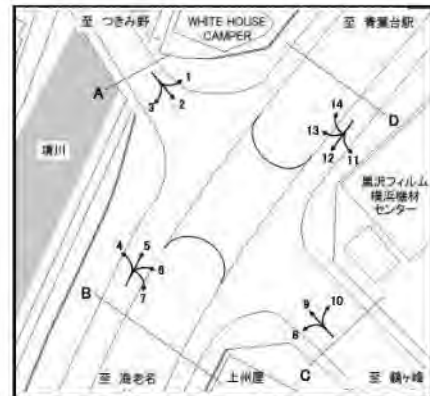

方向 種別 時間帯	1						2					
	小型車 (台)	大型車 (台)	合計 (台)	大型車 混入率 (%)	時 間 係 数 (%)	二輪車 (台)	小型車 (台)	大型車 (台)	合計 (台)	大型車 混入率 (%)	時 間 係 数 (%)	二輪車 (台)
15:00-15:15	29	7	36	19.4	2.0	0	60	16	76	21.1	1.3	0
15:15-15:30	22	6	28	21.4	1.5	0	72	17	89	19.1	1.5	1
15:30-15:45	24	1	25	4.0	1.4	0	55	16	71	22.5	1.2	1
15:45-16:00	20	7	27	25.9	1.5	0	54	19	73	26.0	1.3	2
1時間計	95	21	116	18.1	6.3	0	241	68	309	22.0	5.4	4
16:00-16:15	22	6	28	21.4	1.5	1	66	16	82	19.5	1.4	2
16:15-16:30	25	4	29	13.8	1.6	0	80	18	98	18.4	1.7	0
16:30-16:45	22	8	30	26.7	1.6	0	54	13	67	19.4	1.2	1
16:45-17:00	27	5	32	15.6	1.7	1	64	16	80	20.0	1.4	4
1時間計	96	23	119	19.3	6.5	2	264	63	327	19.3	5.7	7
17:00-17:15	29	3	32	9.4	1.7	0	66	21	87	24.1	1.5	6
17:15-17:30	16	1	17	5.9	0.9	0	79	8	87	9.2	1.5	8
17:30-17:45	28	5	33	15.2	1.8	0	78	13	91	14.3	1.6	6
17:45-18:00	29	5	34	14.7	1.9	0	79	11	90	12.2	1.6	3
1時間計	102	14	116	12.1	6.3	0	302	53	355	14.9	6.2	23
18:00-18:15	26	3	29	10.3	1.6	0	73	7	80	8.8	1.4	1
18:15-18:30	24	1	25	4.0	1.4	0	68	10	78	12.8	1.4	1
18:30-18:45	16	2	18	11.1	1.0	1	63	12	75	16.0	1.3	1
18:45-19:00	14	2	16	12.5	0.9	0	59	6	65	9.2	1.1	2
1時間計	80	8	88	9.1	4.8	1	263	35	298	11.7	5.2	5
昼12時間計	966	275	1241	22.2	67.7	13	2823	855	3678	23.2	63.7	138
19:00-19:15	21	0	21	0.0	1.1	2	61	13	74	17.6	1.3	5
19:15-19:30	23	1	24	4.2	1.3	1	74	6	80	7.5	1.4	3
19:30-19:45	22	3	25	12.0	1.4	0	59	7	66	10.6	1.1	4
19:45-20:00	21	3	24	12.5	1.3	0	62	4	66	6.1	1.1	3
1時間計	87	7	94	7.4	5.1	3	256	30	286	10.5	5.0	15
20:00-20:15	16	2	18	11.1	1.0	1	71	3	74	4.1	1.3	5
20:15-20:30	11	2	13	15.4	0.7	0	57	9	66	13.6	1.1	3
20:30-20:45	18	1	19	5.3	1.0	1	55	6	61	9.8	1.1	2
20:45-21:00	16	1	17	5.9	0.9	0	79	4	83	4.8	1.4	5
1時間計	61	6	67	9.0	3.7	2	262	22	284	7.7	4.9	15
21:00-21:15	16	1	17	5.9	0.9	0	46	6	52	11.5	0.9	2
21:15-21:30	17	0	17	0.0	0.9	0	53	5	58	8.6	1.0	1
21:30-21:45	7	1	8	12.5	0.4	0	43	6	49	12.2	0.8	3
21:45-22:00	6	0	6	0.0	0.3	0	32	7	39	17.9	0.7	3
1時間計	46	2	48	4.2	2.6	0	174	24	198	12.1	3.4	9
22:00-22:15	12	3	15	20.0	0.8	0	49	10	59	16.9	1.0	0
22:15-22:30	10	1	11	9.1	0.6	2	37	4	41	9.8	0.7	0
22:30-22:45	7	0	7	0.0	0.4	0	40	11	51	21.6	0.9	0
22:45-23:00	16	1	17	5.9	0.9	1	27	7	34	20.6	0.6	1
1時間計	45	5	50	10.0	2.7	3	153	32	185	17.3	3.2	1

方向別自動車交通量調査表

調査地点：地域社会1 目黒

調査年月日：令和元年 5月14日(火) 天候：雨のち曇り

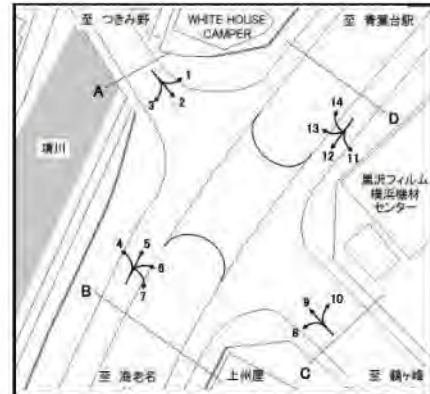

方向 時間帯	1						2					
	種別 小型車 (台)	大型車 (台)	合計 (台)	大型車 混入率 (%)	時係 数 (%)	二輪車 (台)	種別 小型車 (台)	大型車 (台)	合計 (台)	大型車 混入率 (%)	時係 数 (%)	二輪車 (台)
23:00-23:15	4	2	6	33.3	0.3	0	24	4	28	14.3	0.5	2
23:15-23:30	5	2	7	28.6	0.4	0	25	9	34	26.5	0.6	0
23:30-23:45	6	1	7	14.3	0.4	1	22	5	27	18.5	0.5	4
23:45-24:00	10	4	14	28.6	0.8	0	19	5	24	20.8	0.4	1
1時間計	25	9	34	26.5	1.9	1	90	23	113	20.4	2.0	7
0:00-0:15	5	0	5	0.0	0.3	0	15	7	22	31.8	0.4	0
0:15-0:30	1	0	1	0.0	0.1	0	19	7	26	26.9	0.5	1
0:30-0:45	5	1	6	16.7	0.3	0	6	10	16	62.5	0.3	0
0:45-1:00	2	0	2	0.0	0.1	0	8	7	15	46.7	0.3	0
1時間計	13	1	14	7.1	0.8	0	48	31	79	39.2	1.4	1
1:00-1:15	2	1	3	33.3	0.2	0	10	12	22	54.5	0.4	1
1:15-1:30	2	0	2	0.0	0.1	0	9	6	15	40.0	0.3	1
1:30-1:45	1	1	2	50.0	0.1	0	8	3	11	27.3	0.2	1
1:45-2:00	1	1	2	50.0	0.1	0	3	6	9	66.7	0.2	0
1時間計	6	3	9	33.3	0.5	0	30	27	57	47.4	1.0	3
2:00-2:15	2	1	3	33.3	0.2	0	5	7	12	58.3	0.2	0
2:15-2:30	3	2	5	40.0	0.3	0	8	5	13	38.5	0.2	0
2:30-2:45	2	2	4	50.0	0.2	0	5	6	11	54.5	0.2	1
2:45-3:00	4	1	5	20.0	0.3	0	10	14	24	58.3	0.4	0
1時間計	11	6	17	35.3	0.9	0	28	32	60	53.3	1.0	1
3:00-3:15	1	0	1	0.0	0.1	0	10	15	25	60.0	0.4	2
3:15-3:30	1	2	3	66.7	0.2	0	11	13	24	54.2	0.4	2
3:30-3:45	2	2	4	50.0	0.2	0	12	10	22	45.5	0.4	1
3:45-4:00	2	6	8	75.0	0.4	0	7	7	14	50.0	0.2	1
1時間計	6	10	16	62.5	0.9	0	40	45	85	52.9	1.5	6
4:00-4:15	7	2	9	22.2	0.5	0	17	16	33	48.5	0.6	1
4:15-4:30	2	1	3	33.3	0.2	0	14	5	19	26.3	0.3	0
4:30-4:45	3	5	8	62.5	0.4	0	16	16	32	50.0	0.6	3
4:45-5:00	7	2	9	22.2	0.5	0	24	17	41	41.5	0.7	6
1時間計	19	10	29	34.5	1.6	0	71	54	125	43.2	2.2	10
5:00-5:15	16	8	24	33.3	1.3	1	27	19	46	41.3	0.8	1
5:15-5:30	11	8	19	42.1	1.0	0	60	30	90	33.3	1.6	4
5:30-5:45	19	6	25	24.0	1.4	0	44	19	63	30.2	1.1	7
5:45-6:00	22	7	29	24.1	1.6	0	45	32	77	41.6	1.3	3
1時間計	68	29	97	29.9	5.3	1	176	100	276	36.2	4.8	15
6:00-6:15	28	4	32	12.5	1.7	0	50	26	76	34.2	1.3	3
6:15-6:30	22	7	29	24.1	1.6	1	72	13	85	15.3	1.5	5
6:30-6:45	26	8	34	23.5	1.9	0	71	20	91	22.0	1.6	7
6:45-7:00	14	9	23	39.1	1.3	0	67	27	94	28.7	1.6	8
1時間計	90	28	118	23.7	6.4	1	260	86	346	24.9	6.0	23
夜12時間計	477	116	593	19.6	32.3	11	1588	506	2094	24.2	36.3	106
全時間合計	1443	391	1834	21.3	100.0	24	4411	1361	5772	23.6	100.0	244
昼夜率	1.49	1.42	1.48	-	-	1.85	1.56	1.59	1.57	-	-	1.77

方向別自動車交通量調査表

調査地点：地域社会1 目黒

調査年月日：令和元年 5月14日(火) 天候：雨のち曇り

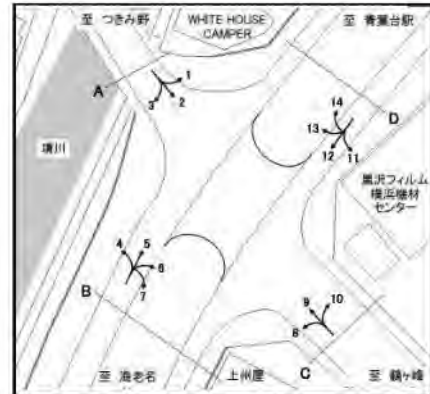

時間帯	種別	3						A 合計 (1+2+3)					
		小型車 (台)	大型車 (台)	合計 (台)	大型車 混入率 (%)	時係 数 (%)	二輪車 (台)	小型車 (台)	大型車 (台)	合計 (台)	大型車 混入率 (%)	時係 数 (%)	二輪車 (台)
7:00-7:15		10	4	14	28.6	1.1	2	88	35	123	28.5	1.4	9
7:15-7:30		10	8	18	44.4	1.4	3	93	32	125	25.6	1.4	15
7:30-7:45		4	6	10	60.0	0.8	3	82	33	115	28.7	1.3	8
7:45-8:00		20	11	31	35.5	2.4	2	113	26	139	18.7	1.6	15
1時間計		44	29	73	39.7	5.8	10	376	126	502	25.1	5.7	47
8:00-8:15		10	7	17	41.2	1.3	4	91	25	116	21.6	1.3	19
8:15-8:30		5	3	8	37.5	0.6	2	87	34	121	28.1	1.4	12
8:30-8:45		12	4	16	25.0	1.3	0	98	22	120	18.3	1.4	10
8:45-9:00		8	3	11	27.3	0.9	1	80	28	108	25.9	1.2	4
1時間計		35	17	52	32.7	4.1	7	356	109	465	23.4	5.2	45
9:00-9:15		11	6	17	35.3	1.3	1	80	40	120	33.3	1.4	3
9:15-9:30		6	3	9	33.3	0.7	0	47	16	63	25.4	0.7	0
9:30-9:45		5	3	8	37.5	0.6	2	76	38	114	33.3	1.3	4
9:45-10:00		15	10	25	40.0	2.0	2	72	44	116	37.9	1.3	4
1時間計		37	22	59	37.3	4.7	5	275	138	413	33.4	4.7	11
10:00-10:15		10	7	17	41.2	1.3	0	78	42	120	35.0	1.4	5
10:15-10:30		11	7	18	38.9	1.4	0	87	38	125	30.4	1.4	1
10:30-10:45		14	4	18	22.2	1.4	0	83	36	119	30.3	1.3	0
10:45-11:00		7	11	18	61.1	1.4	0	65	45	110	40.9	1.2	0
1時間計		42	29	71	40.8	5.6	0	313	161	474	34.0	5.3	6
11:00-11:15		13	3	16	18.8	1.3	0	82	38	120	31.7	1.4	1
11:15-11:30		8	7	15	46.7	1.2	0	78	43	121	35.5	1.4	2
11:30-11:45		10	7	17	41.2	1.3	0	91	39	130	30.0	1.5	1
11:45-12:00		14	3	17	17.6	1.3	0	89	34	123	27.6	1.4	0
1時間計		45	20	65	30.8	5.1	0	340	154	494	31.2	5.6	4
12:00-12:15		8	5	13	38.5	1.0	0	57	29	86	33.7	1.0	1
12:15-12:30		12	4	16	25.0	1.3	0	83	27	110	24.5	1.2	3
12:30-12:45		11	2	13	15.4	1.0	0	88	26	114	22.8	1.3	2
12:45-13:00		8	3	11	27.3	0.9	0	92	21	113	18.6	1.3	1
1時間計		39	14	53	26.4	4.2	0	320	103	423	24.3	4.8	7
13:00-13:15		12	2	14	14.3	1.1	1	91	22	113	19.5	1.3	1
13:15-13:30		9	7	16	43.8	1.3	0	72	24	96	25.0	1.1	0
13:30-13:45		12	7	19	36.8	1.5	1	89	29	118	24.6	1.3	4
13:45-14:00		7	9	16	56.3	1.3	0	92	33	125	26.4	1.4	1
1時間計		40	25	65	38.5	5.1	2	344	108	452	23.9	5.1	6
14:00-14:15		10	7	17	41.2	1.3	0	80	34	114	29.8	1.3	0
14:15-14:30		9	6	15	40.0	1.2	0	84	31	115	27.0	1.3	1
14:30-14:45		18	2	20	10.0	1.6	0	96	30	126	23.8	1.4	2
14:45-15:00		16	9	25	36.0	2.0	0	97	31	128	24.2	1.4	4
1時間計		53	24	77	31.2	6.1	0	357	126	483	26.1	5.4	7

方向別自動車交通量調査表

調査地点：地域社会1 目黒

調査年月日：令和元年 5月14日(火) 天候：雨のち曇り

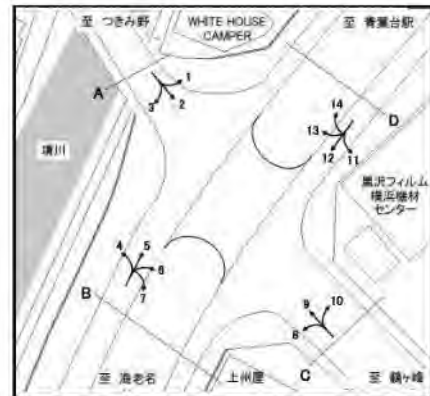

時間帯	種別	3						A 合計 (1+2+3)					
		小型車 (台)	大型車 (台)	合計 (台)	大型車 混入率 (%)	時 間 係 数 (%)	二輪車 (台)	小型車 (台)	大型車 (台)	合計 (台)	大型車 混入率 (%)	時 間 係 数 (%)	二輪車 (台)
15:00-15:15		13	3	16	18.8	1.3	0	102	26	128	20.3	1.4	0
15:15-15:30		23	10	33	30.3	2.6	0	117	33	150	22.0	1.7	1
15:30-15:45		18	20	38	52.6	3.0	1	97	37	134	27.6	1.5	2
15:45-16:00		7	5	12	41.7	0.9	0	81	31	112	27.7	1.3	2
1時間計		61	38	99	38.4	7.8	1	397	127	524	24.2	5.9	5
16:00-16:15		6	1	7	14.3	0.6	0	94	23	117	19.7	1.3	3
16:15-16:30		11	2	13	15.4	1.0	5	116	24	140	17.1	1.6	5
16:30-16:45		11	3	14	21.4	1.1	1	87	24	111	21.6	1.3	2
16:45-17:00		6	3	9	33.3	0.7	1	97	24	121	19.8	1.4	6
1時間計		34	9	43	20.9	3.4	7	394	95	489	19.4	5.5	16
17:00-17:15		11	6	17	35.3	1.3	1	106	30	136	22.1	1.5	7
17:15-17:30		10	3	13	23.1	1.0	0	105	12	117	10.3	1.3	8
17:30-17:45		9	7	16	43.8	1.3	0	115	25	140	17.9	1.6	6
17:45-18:00		13	2	15	13.3	1.2	1	121	18	139	12.9	1.6	4
1時間計		43	18	61	29.5	4.8	2	447	85	532	16.0	6.0	25
18:00-18:15		20	1	21	4.8	1.7	0	119	11	130	8.5	1.5	1
18:15-18:30		14	1	15	6.7	1.2	1	106	12	118	10.2	1.3	2
18:30-18:45		9	4	13	30.8	1.0	1	88	18	106	17.0	1.2	3
18:45-19:00		10	1	11	9.1	0.9	2	83	9	92	9.8	1.0	4
1時間計		53	7	60	11.7	4.7	4	396	50	446	11.2	5.0	10
昼12時間計		526	252	778	32.4	61.5	38	4315	1382	5697	24.3	64.2	189
19:00-19:15		3	2	5	40.0	0.4	1	85	15	100	15.0	1.1	8
19:15-19:30		15	1	16	6.3	1.3	0	112	8	120	6.7	1.4	4
19:30-19:45		6	0	6	0.0	0.5	0	87	10	97	10.3	1.1	4
19:45-20:00		10	0	10	0.0	0.8	0	93	7	100	7.0	1.1	3
1時間計		34	3	37	8.1	2.9	1	377	40	417	9.6	4.7	19
20:00-20:15		19	1	20	5.0	1.6	0	106	6	112	5.4	1.3	6
20:15-20:30		12	0	12	0.0	0.9	2	80	11	91	12.1	1.0	5
20:30-20:45		10	4	14	28.6	1.1	1	83	11	94	11.7	1.1	4
20:45-21:00		30	2	32	6.3	2.5	2	125	7	132	5.3	1.5	7
1時間計		71	7	78	9.0	6.2	5	394	35	429	8.2	4.8	22
21:00-21:15		26	1	27	3.7	2.1	0	88	8	96	8.3	1.1	2
21:15-21:30		19	1	20	5.0	1.6	0	89	6	95	6.3	1.1	1
21:30-21:45		11	0	11	0.0	0.9	0	61	7	68	10.3	0.8	3
21:45-22:00		9	1	10	10.0	0.8	0	47	8	55	14.5	0.6	3
1時間計		65	3	68	4.4	5.4	0	285	29	314	9.2	3.5	9
22:00-22:15		11	0	11	0.0	0.9	0	72	13	85	15.3	1.0	0
22:15-22:30		11	2	13	15.4	1.0	0	58	7	65	10.8	0.7	2
22:30-22:45		9	1	10	10.0	0.8	0	56	12	68	17.6	0.8	0
22:45-23:00		6	0	6	0.0	0.5	0	49	8	57	14.0	0.6	2
1時間計		37	3	40	7.5	3.2	0	235	40	275	14.5	3.1	4

方向別自動車交通量調査表

調査地点：地域社会1 目黒

調査年月日：令和元年 5月14日(火) 天候：雨のち曇り

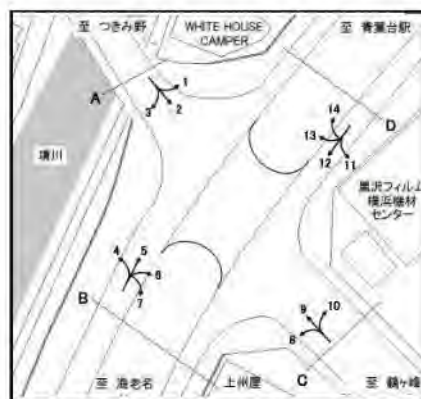

時間帯	3						A 合計 (1+2+3)					
	種別 小型車 (台)	大型車 (台)	合計 (台)	大型車 混入率 (%)	時 間 係 数 (%)	二輪車 (台)	種別 小型車 (台)	大型車 (台)	合計 (台)	大型車 混入率 (%)	時 間 係 数 (%)	二輪車 (台)
23:00-23:15	8	1	9	11.1	0.7	1	36	7	43	16.3	0.5	3
23:15-23:30	4	2	6	33.3	0.5	0	34	13	47	27.7	0.5	0
23:30-23:45	5	2	7	28.6	0.6	0	33	8	41	19.5	0.5	5
23:45-24:00	4	2	6	33.3	0.5	1	33	11	44	25.0	0.5	2
1 時間計	21	7	28	25.0	2.2	2	136	39	175	22.3	2.0	10
0:00-0:15	5	2	7	28.6	0.6	1	25	9	34	26.5	0.4	1
0:15-0:30	2	6	8	75.0	0.6	0	22	13	35	37.1	0.4	1
0:30-0:45	4	6	10	60.0	0.8	0	15	17	32	53.1	0.4	0
0:45-1:00	7	10	17	58.8	1.3	0	17	17	34	50.0	0.4	0
1 時間計	18	24	42	57.1	3.3	1	79	56	135	41.5	1.5	2
1:00-1:15	3	0	3	0.0	0.2	0	15	13	28	46.4	0.3	1
1:15-1:30	2	1	3	33.3	0.2	0	13	7	20	35.0	0.2	1
1:30-1:45	4	1	5	20.0	0.4	0	13	5	18	27.8	0.2	1
1:45-2:00	3	1	4	25.0	0.3	0	7	8	15	53.3	0.2	0
1 時間計	12	3	15	20.0	1.2	0	48	33	81	40.7	0.9	3
2:00-2:15	1	0	1	0.0	0.1	0	8	8	16	50.0	0.2	0
2:15-2:30	2	2	4	50.0	0.3	0	13	9	22	40.9	0.2	0
2:30-2:45	1	2	3	66.7	0.2	0	8	10	18	55.6	0.2	1
2:45-3:00	4	4	8	50.0	0.6	3	18	19	37	51.4	0.4	3
1 時間計	8	8	16	50.0	1.3	3	47	46	93	49.5	1.0	4
3:00-3:15	3	10	13	76.9	1.0	0	14	25	39	64.1	0.4	2
3:15-3:30	2	6	8	75.0	0.6	0	14	21	35	60.0	0.4	2
3:30-3:45	4	7	11	63.6	0.9	1	18	19	37	51.4	0.4	2
3:45-4:00	4	6	10	60.0	0.8	0	13	19	32	59.4	0.4	1
1 時間計	13	29	42	69.0	3.3	1	59	84	143	58.7	1.6	7
4:00-4:15	10	5	15	33.3	1.2	0	34	23	57	40.4	0.6	1
4:15-4:30	5	6	11	54.5	0.9	0	21	12	33	36.4	0.4	0
4:30-4:45	1	6	7	85.7	0.6	0	20	27	47	57.4	0.5	3
4:45-5:00	8	4	12	33.3	0.9	0	39	23	62	37.1	0.7	6
1 時間計	24	21	45	46.7	3.6	0	114	85	199	42.7	2.2	10
5:00-5:15	1	4	5	80.0	0.4	0	44	31	75	41.3	0.8	2
5:15-5:30	1	4	5	80.0	0.4	0	72	42	114	36.8	1.3	4
5:30-5:45	4	2	6	33.3	0.5	1	67	27	94	28.7	1.1	8
5:45-6:00	1	8	9	88.9	0.7	1	68	47	115	40.9	1.3	4
1 時間計	7	18	25	72.0	2.0	2	251	147	398	36.9	4.5	18
6:00-6:15	7	5	12	41.7	0.9	2	85	35	120	29.2	1.4	5
6:15-6:30	6	12	18	66.7	1.4	0	100	32	132	24.2	1.5	6
6:30-6:45	6	2	8	25.0	0.6	3	103	30	133	22.6	1.5	10
6:45-7:00	9	5	14	35.7	1.1	2	90	41	131	31.3	1.5	10
1 時間計	28	24	52	46.2	4.1	7	378	138	516	26.7	5.8	31
夜12時間計	338	150	488	30.7	38.5	22	2403	772	3175	24.3	35.8	139
全時間合計	864	402	1266	31.8	100.0	60	6718	2154	8872	24.3	100.0	328
昼 夜 率	1.64	1.60	1.63	-	-	1.58	1.56	1.56	1.56	-	-	1.74

方向別自動車交通量調査表

調査地点：地域社会1 目黒

調査年月日：令和元年 5月14日(火) 天候：雨のち曇り

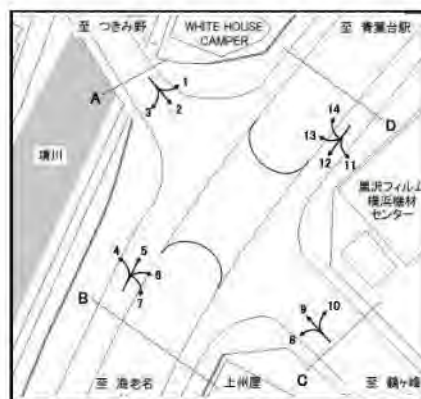

方向 時間帯	4						5					
	種別 小型車 (台)	大型車 (台)	合計 (台)	大型車 混入率 (%)	時係 数 (%)	二輪車 (台)	種別 小型車 (台)	大型車 (台)	合計 (台)	大型車 混入率 (%)	時係 数 (%)	二輪車 (台)
7:00-7:15	7	7	14	50.0	1.0	1	18	3	21	14.3	1.9	2
7:15-7:30	4	4	8	50.0	0.6	0	15	5	20	25.0	1.8	1
7:30-7:45	6	12	18	66.7	1.3	0	21	3	24	12.5	2.1	1
7:45-8:00	12	6	18	33.3	1.3	1	18	2	20	10.0	1.8	1
1時間計	29	29	58	50.0	4.2	2	72	13	85	15.3	7.5	5
8:00-8:15	7	6	13	46.2	0.9	0	21	0	21	0.0	1.9	1
8:15-8:30	13	18	31	58.1	2.2	2	16	4	20	20.0	1.8	1
8:30-8:45	15	10	25	40.0	1.8	0	18	1	19	5.3	1.7	0
8:45-9:00	7	6	13	46.2	0.9	1	12	2	14	14.3	1.2	0
1時間計	42	40	82	48.8	5.9	3	67	7	74	9.5	6.6	2
9:00-9:15	6	5	11	45.5	0.8	0	9	1	10	10.0	0.9	0
9:15-9:30	5	3	8	37.5	0.6	0	11	0	11	0.0	1.0	0
9:30-9:45	5	3	8	37.5	0.6	2	8	2	10	20.0	0.9	1
9:45-10:00	8	3	11	27.3	0.8	1	9	2	11	18.2	1.0	1
1時間計	24	14	38	36.8	2.7	3	37	5	42	11.9	3.7	2
10:00-10:15	6	6	12	50.0	0.9	1	7	2	9	22.2	0.8	0
10:15-10:30	19	4	23	17.4	1.7	0	15	6	21	28.6	1.9	0
10:30-10:45	8	7	15	46.7	1.1	0	12	0	12	0.0	1.1	1
10:45-11:00	15	9	24	37.5	1.7	0	13	2	15	13.3	1.3	0
1時間計	48	26	74	35.1	5.3	1	47	10	57	17.5	5.1	1
11:00-11:15	14	11	25	44.0	1.8	1	11	4	15	26.7	1.3	1
11:15-11:30	13	5	18	27.8	1.3	1	12	2	14	14.3	1.2	2
11:30-11:45	10	7	17	41.2	1.2	0	13	1	14	7.1	1.2	0
11:45-12:00	9	3	12	25.0	0.9	0	14	6	20	30.0	1.8	0
1時間計	46	26	72	36.1	5.2	2	50	13	63	20.6	5.6	3
12:00-12:15	19	3	22	13.6	1.6	0	11	2	13	15.4	1.2	0
12:15-12:30	20	6	26	23.1	1.9	0	14	5	19	26.3	1.7	0
12:30-12:45	22	8	30	26.7	2.2	0	12	7	19	36.8	1.7	0
12:45-13:00	21	4	25	16.0	1.8	0	7	1	8	12.5	0.7	0
1時間計	82	21	103	20.4	7.4	0	44	15	59	25.4	5.2	0
13:00-13:15	21	13	34	38.2	2.5	0	10	3	13	23.1	1.2	0
13:15-13:30	15	8	23	34.8	1.7	0	6	2	8	25.0	0.7	0
13:30-13:45	15	13	28	46.4	2.0	0	4	3	7	42.9	0.6	0
13:45-14:00	13	4	17	23.5	1.2	0	8	5	13	38.5	1.2	0
1時間計	64	38	102	37.3	7.4	0	28	13	41	31.7	3.6	0
14:00-14:15	18	10	28	35.7	2.0	0	9	4	13	30.8	1.2	0
14:15-14:30	19	3	22	13.6	1.6	0	14	2	16	12.5	1.4	0
14:30-14:45	18	5	23	21.7	1.7	0	11	4	15	26.7	1.3	0
14:45-15:00	13	4	17	23.5	1.2	0	10	4	14	28.6	1.2	0
1時間計	68	22	90	24.4	6.5	0	44	14	58	24.1	5.1	0

方向別自動車交通量調査表

調査地点：地域社会1 目黒

調査年月日：令和元年 5月14日(火) 天候：雨のち曇り

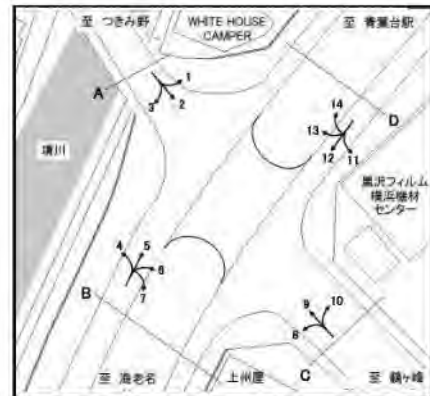

方向 種別 時間帯	4						5					
	小型車 (台)	大型車 (台)	合計 (台)	大型車 混入率 (%)	時 間 係 数 (%)	二輪車 (台)	小型車 (台)	大型車 (台)	合計 (台)	大型車 混入率 (%)	時 間 係 数 (%)	二輪車 (台)
15:00-15:15	15	14	29	48.3	2.1	0	13	5	18	27.8	1.6	1
15:15-15:30	6	3	9	33.3	0.6	0	5	3	8	37.5	0.7	0
15:30-15:45	13	3	16	18.8	1.2	0	12	2	14	14.3	1.2	0
15:45-16:00	11	2	13	15.4	0.9	0	9	0	9	0.0	0.8	1
1時間計	45	22	67	32.8	4.8	0	39	10	49	20.4	4.3	2
16:00-16:15	9	4	13	30.8	0.9	0	11	2	13	15.4	1.2	0
16:15-16:30	10	2	12	16.7	0.9	1	13	2	15	13.3	1.3	0
16:30-16:45	14	2	16	12.5	1.2	0	6	2	8	25.0	0.7	0
16:45-17:00	21	4	25	16.0	1.8	0	11	3	14	21.4	1.2	0
1時間計	54	12	66	18.2	4.8	1	41	9	50	18.0	4.4	0
17:00-17:15	25	2	27	7.4	1.9	1	10	1	11	9.1	1.0	1
17:15-17:30	28	2	30	6.7	2.2	0	11	0	11	0.0	1.0	0
17:30-17:45	18	1	19	5.3	1.4	1	17	0	17	0.0	1.5	0
17:45-18:00	23	1	24	4.2	1.7	3	8	3	11	27.3	1.0	1
1時間計	94	6	100	6.0	7.2	5	46	4	50	8.0	4.4	2
18:00-18:15	37	1	38	2.6	2.7	0	16	3	19	15.8	1.7	0
18:15-18:30	26	0	26	0.0	1.9	0	15	0	15	0.0	1.3	0
18:30-18:45	29	2	31	6.5	2.2	0	22	0	22	0.0	2.0	1
18:45-19:00	11	3	14	21.4	1.0	0	7	2	9	22.2	0.8	0
1時間計	103	6	109	5.5	7.9	0	60	5	65	7.7	5.8	1
昼12時間計	699	262	961	27.3	69.3	17	575	118	693	17.0	61.4	18
19:00-19:15	23	2	25	8.0	1.8	1	13	0	13	0.0	1.2	0
19:15-19:30	33	0	33	0.0	2.4	1	12	0	12	0.0	1.1	0
19:30-19:45	16	2	18	11.1	1.3	0	12	0	12	0.0	1.1	0
19:45-20:00	12	1	13	7.7	0.9	2	14	0	14	0.0	1.2	0
1時間計	84	5	89	5.6	6.4	4	51	0	51	0.0	4.5	0
20:00-20:15	22	0	22	0.0	1.6	1	9	1	10	10.0	0.9	0
20:15-20:30	23	0	23	0.0	1.7	1	10	0	10	0.0	0.9	0
20:30-20:45	10	0	10	0.0	0.7	3	7	1	8	12.5	0.7	0
20:45-21:00	17	0	17	0.0	1.2	0	6	0	6	0.0	0.5	0
1時間計	72	0	72	0.0	5.2	5	32	2	34	5.9	3.0	0
21:00-21:15	11	1	12	8.3	0.9	0	7	2	9	22.2	0.8	0
21:15-21:30	11	0	11	0.0	0.8	1	11	3	14	21.4	1.2	0
21:30-21:45	2	0	2	0.0	0.1	0	2	0	2	0.0	0.2	0
21:45-22:00	10	0	10	0.0	0.7	0	1	0	1	0.0	0.1	0
1時間計	34	1	35	2.9	2.5	1	21	5	26	19.2	2.3	0
22:00-22:15	10	0	10	0.0	0.7	2	2	2	4	50.0	0.4	0
22:15-22:30	10	1	11	9.1	0.8	0	6	0	6	0.0	0.5	0
22:30-22:45	13	0	13	0.0	0.9	0	7	0	7	0.0	0.6	0
22:45-23:00	12	0	12	0.0	0.9	0	5	0	5	0.0	0.4	0
1時間計	45	1	46	2.2	3.3	2	20	2	22	9.1	2.0	0

方向別自動車交通量調査表

調査地点：地域社会1 目黒

調査年月日：令和元年 5月14日(火) 天候：雨のち曇り

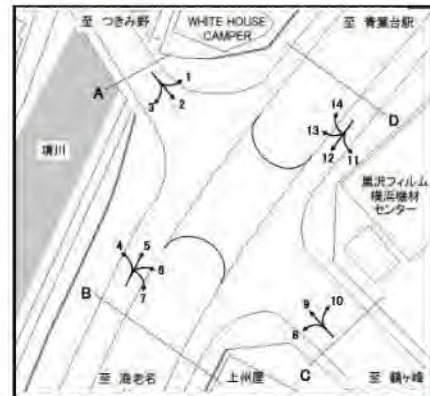

方向 種別 時間帯	4						5					
	小型車 (台)	大型車 (台)	合計 (台)	大型車 混入率 (%)	時間 係数 (%)	二輪車 (台)	小型車 (台)	大型車 (台)	合計 (台)	大型車 混入率 (%)	時間 係数 (%)	二輪車 (台)
23:00-23:15	8	2	10	20.0	0.7	0	3	1	4	25.0	0.4	0
23:15-23:30	6	0	6	0.0	0.4	0	2	0	2	0.0	0.2	0
23:30-23:45	3	0	3	0.0	0.2	0	2	1	3	33.3	0.3	0
23:45-24:00	3	0	3	0.0	0.2	1	3	0	3	0.0	0.3	0
1時間計	20	2	22	9.1	1.6	1	10	2	12	16.7	1.1	0
0:00-0:15	8	1	9	11.1	0.6	0	2	0	2	0.0	0.2	0
0:15-0:30	16	3	19	15.8	1.4	0	2	0	2	0.0	0.2	0
0:30-0:45	3	0	3	0.0	0.2	0	5	0	5	0.0	0.4	0
0:45-1:00	3	2	5	40.0	0.4	0	0	0	0	0.0	0.0	0
1時間計	30	6	36	16.7	2.6	0	9	0	9	0.0	0.8	0
1:00-1:15	4	2	6	33.3	0.4	0	4	0	4	0.0	0.4	0
1:15-1:30	3	4	7	57.1	0.5	0	1	1	2	50.0	0.2	0
1:30-1:45	5	2	7	28.6	0.5	0	2	3	5	60.0	0.4	0
1:45-2:00	2	0	2	0.0	0.1	0	2	1	3	33.3	0.3	0
1時間計	14	8	22	36.4	1.6	0	9	5	14	35.7	1.2	0
2:00-2:15	2	0	2	0.0	0.1	0	2	0	2	0.0	0.2	0
2:15-2:30	4	1	5	20.0	0.4	0	3	1	4	25.0	0.4	1
2:30-2:45	2	6	8	75.0	0.6	0	1	0	1	0.0	0.1	0
2:45-3:00	2	1	3	33.3	0.2	0	2	0	2	0.0	0.2	0
1時間計	10	8	18	44.4	1.3	0	8	1	9	11.1	0.8	1
3:00-3:15	1	0	1	0.0	0.1	0	1	0	1	0.0	0.1	0
3:15-3:30	1	2	3	66.7	0.2	0	1	1	2	50.0	0.2	0
3:30-3:45	2	1	3	33.3	0.2	0	0	0	0	0.0	0.0	0
3:45-4:00	0	3	3	100.0	0.2	0	1	5	6	83.3	0.5	0
1時間計	4	6	10	60.0	0.7	0	3	6	9	66.7	0.8	0
4:00-4:15	0	3	3	100.0	0.2	0	3	1	4	25.0	0.4	0
4:15-4:30	0	1	1	100.0	0.1	0	1	2	3	66.7	0.3	0
4:30-4:45	0	2	2	100.0	0.1	0	0	3	3	100.0	0.3	2
4:45-5:00	2	1	3	33.3	0.2	0	3	2	5	40.0	0.4	1
1時間計	2	7	9	77.8	0.6	0	7	8	15	53.3	1.3	3
5:00-5:15	3	1	4	25.0	0.3	0	7	1	8	12.5	0.7	0
5:15-5:30	4	1	5	20.0	0.4	0	14	4	18	22.2	1.6	1
5:30-5:45	1	3	4	75.0	0.3	0	28	9	37	24.3	3.3	0
5:45-6:00	4	8	12	66.7	0.9	0	36	5	41	12.2	3.6	1
1時間計	12	13	25	52.0	1.8	0	85	19	104	18.3	9.2	2
6:00-6:15	10	4	14	28.6	1.0	0	40	7	47	14.9	4.2	0
6:15-6:30	3	3	6	50.0	0.4	0	19	4	23	17.4	2.0	1
6:30-6:45	7	6	13	46.2	0.9	0	23	4	27	14.8	2.4	2
6:45-7:00	4	4	8	50.0	0.6	0	29	4	33	12.1	2.9	1
1時間計	24	17	41	41.5	3.0	0	111	19	130	14.6	11.5	4
夜12時間計	351	74	425	17.4	30.7	13	366	69	435	15.9	38.6	10
全時間合計	1050	336	1386	24.2	100.0	30	941	187	1128	16.6	100.0	28
昼夜率	1.50	1.28	1.44	-	-	1.76	1.64	1.58	1.63	-	-	1.56

方向別自動車交通量調査表

調査地点：地域社会1 目黒

調査年月日：令和元年 5月14日(火) 天候：雨のち曇り

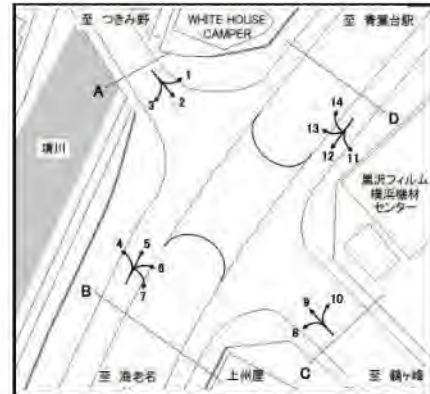

方向	6						7						
	種別	小型車 (台)	大型車 (台)	合計 (台)	大型車 混入率 (%)	時 間 係 数 (%)	二輪車 (台)	小型車 (台)	大型車 (台)	合計 (台)	大型車 混入率 (%)	時 間 係 数 (%)	二輪車 (台)
7:00-7:15		23	19	42	45.2	1.1	2	0	0	0	0.0	0.0	0
7:15-7:30		20	17	37	45.9	0.9	3	0	0	0	0.0	0.0	0
7:30-7:45		24	17	41	41.5	1.0	2	0	0	0	0.0	0.0	0
7:45-8:00		28	19	47	40.4	1.2	3	0	0	0	0.0	0.0	0
1時間計		95	72	167	43.1	4.2	10	0	0	0	0.0	0.0	0
8:00-8:15		34	10	44	22.7	1.1	2	0	0	0	0.0	0.0	0
8:15-8:30		23	23	46	50.0	1.2	4	0	0	0	0.0	0.0	0
8:30-8:45		26	16	42	38.1	1.1	2	0	0	0	0.0	0.0	0
8:45-9:00		24	18	42	42.9	1.1	2	0	0	0	0.0	0.0	0
1時間計		107	67	174	38.5	4.4	10	0	0	0	0.0	0.0	0
9:00-9:15		21	26	47	55.3	1.2	0	0	1	1	100.0	3.1	0
9:15-9:30		14	23	37	62.2	0.9	1	0	0	0	0.0	0.0	0
9:30-9:45		16	23	39	59.0	1.0	0	0	1	1	100.0	3.1	0
9:45-10:00		9	24	33	72.7	0.8	0	0	2	2	100.0	6.3	0
1時間計		60	96	156	61.5	4.0	1	0	4	4	100.0	12.5	0
10:00-10:15		18	24	42	57.1	1.1	0	0	1	1	100.0	3.1	0
10:15-10:30		16	28	44	63.6	1.1	0	0	0	0	0.0	0.0	0
10:30-10:45		16	32	48	66.7	1.2	0	1	0	1	0.0	3.1	0
10:45-11:00		18	37	55	67.3	1.4	0	0	0	0	0.0	0.0	0
1時間計		68	121	189	64.0	4.8	0	1	1	2	50.0	6.3	0
11:00-11:15		33	27	60	45.0	1.5	0	1	0	1	0.0	3.1	0
11:15-11:30		23	24	47	51.1	1.2	1	0	0	0	0.0	0.0	0
11:30-11:45		24	31	55	56.4	1.4	1	2	0	2	0.0	6.3	0
11:45-12:00		19	29	48	60.4	1.2	1	0	0	0	0.0	0.0	0
1時間計		99	111	210	52.9	5.3	3	3	0	3	0.0	9.4	0
12:00-12:15		23	43	66	65.2	1.7	0	0	0	0	0.0	0.0	0
12:15-12:30		26	24	50	48.0	1.3	0	1	0	1	0.0	3.1	0
12:30-12:45		24	25	49	51.0	1.2	0	1	0	1	0.0	3.1	0
12:45-13:00		35	29	64	45.3	1.6	1	0	0	0	0.0	0.0	0
1時間計		108	121	229	52.8	5.8	1	2	0	2	0.0	6.3	0
13:00-13:15		27	26	53	49.1	1.3	0	0	0	0	0.0	0.0	0
13:15-13:30		36	20	56	35.7	1.4	0	0	0	0	0.0	0.0	0
13:30-13:45		30	24	54	44.4	1.4	2	0	0	0	0.0	0.0	0
13:45-14:00		27	25	52	48.1	1.3	0	2	2	4	50.0	12.5	0
1時間計		120	95	215	44.2	5.5	2	2	2	4	50.0	12.5	0
14:00-14:15		30	27	57	47.4	1.4	0	0	0	0	0.0	0.0	0
14:15-14:30		22	32	54	59.3	1.4	0	1	0	1	0.0	3.1	0
14:30-14:45		38	23	61	37.7	1.5	1	0	0	0	0.0	0.0	0
14:45-15:00		31	27	58	46.6	1.5	0	1	0	1	0.0	3.1	0
1時間計		121	109	230	47.4	5.8	1	2	0	2	0.0	6.3	0

方向別自動車交通量調査表

調査地点：地域社会1 目黒

調査年月日：令和元年 5月14日(火) 天候：雨のち曇り

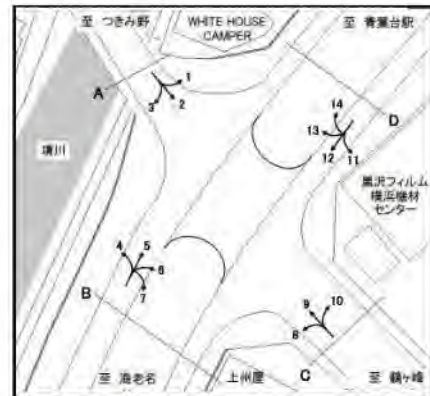

方向 時間帯	6						7					
	種別 小型車 (台)	大型車 (台)	合計 (台)	大型車 混入率 (%)	時 間 係 数 (%)	二輪車 (台)	小型車 (台)	大型車 (台)	合計 (台)	大型車 混入率 (%)	時 間 係 数 (%)	二輪車 (台)
15:00-15:15	24	19	43	44.2	1.1	1	0	0	0	0.0	0.0	0
15:15-15:30	30	14	44	31.8	1.1	1	0	1	1	100.0	3.1	0
15:30-15:45	37	14	51	27.5	1.3	1	0	0	0	0.0	0.0	0
15:45-16:00	32	22	54	40.7	1.4	0	0	0	0	0.0	0.0	0
1時間計	123	69	192	35.9	4.9	3	0	1	1	100.0	3.1	0
16:00-16:15	29	15	44	34.1	1.1	2	1	0	1	0.0	3.1	0
16:15-16:30	29	18	47	38.3	1.2	0	0	0	0	0.0	0.0	0
16:30-16:45	38	22	60	36.7	1.5	0	2	1	3	33.3	9.4	0
16:45-17:00	48	23	71	32.4	1.8	2	0	0	0	0.0	0.0	0
1時間計	144	78	222	35.1	5.6	4	3	1	4	25.0	12.5	0
17:00-17:15	43	14	57	24.6	1.4	0	0	1	1	100.0	3.1	0
17:15-17:30	40	8	48	16.7	1.2	1	2	0	2	0.0	6.3	0
17:30-17:45	32	7	39	17.9	1.0	2	1	0	1	0.0	3.1	0
17:45-18:00	44	13	57	22.8	1.4	5	0	0	0	0.0	0.0	0
1時間計	159	42	201	20.9	5.1	8	3	1	4	25.0	12.5	0
18:00-18:15	62	18	80	22.5	2.0	1	1	0	1	0.0	3.1	0
18:15-18:30	40	11	51	21.6	1.3	3	0	0	0	0.0	0.0	0
18:30-18:45	35	14	49	28.6	1.2	2	0	0	0	0.0	0.0	0
18:45-19:00	25	5	30	16.7	0.8	1	1	0	1	0.0	3.1	0
1時間計	162	48	210	22.9	5.3	7	2	0	2	0.0	6.3	0
昼12時間計	1366	1029	2395	43.0	60.7	50	18	10	28	35.7	87.5	0
19:00-19:15	38	13	51	25.5	1.3	1	0	0	0	0.0	0.0	0
19:15-19:30	37	8	45	17.8	1.1	3	0	0	0	0.0	0.0	0
19:30-19:45	36	5	41	12.2	1.0	3	0	0	0	0.0	0.0	0
19:45-20:00	38	4	42	9.5	1.1	1	0	0	0	0.0	0.0	0
1時間計	149	30	179	16.8	4.5	8	0	0	0	0.0	0.0	0
20:00-20:15	39	14	53	26.4	1.3	2	2	0	2	0.0	6.3	0
20:15-20:30	41	17	58	29.3	1.5	2	1	0	1	0.0	3.1	0
20:30-20:45	43	5	48	10.4	1.2	1	0	0	0	0.0	0.0	0
20:45-21:00	25	11	36	30.6	0.9	2	0	0	0	0.0	0.0	0
1時間計	148	47	195	24.1	4.9	7	3	0	3	0.0	9.4	0
21:00-21:15	32	5	37	13.5	0.9	0	0	0	0	0.0	0.0	0
21:15-21:30	36	10	46	21.7	1.2	1	0	0	0	0.0	0.0	0
21:30-21:45	18	3	21	14.3	0.5	1	0	0	0	0.0	0.0	0
21:45-22:00	19	6	25	24.0	0.6	0	0	0	0	0.0	0.0	0
1時間計	105	24	129	18.6	3.3	2	0	0	0	0.0	0.0	0
22:00-22:15	20	17	37	45.9	0.9	1	0	0	0	0.0	0.0	0
22:15-22:30	23	13	36	36.1	0.9	0	0	0	0	0.0	0.0	0
22:30-22:45	21	7	28	25.0	0.7	1	0	0	0	0.0	0.0	0
22:45-23:00	18	12	30	40.0	0.8	1	0	0	0	0.0	0.0	0
1時間計	82	49	131	37.4	3.3	3	0	0	0	0.0	0.0	0

方向別自動車交通量調査表

調査地点：地域社会1 目黒

調査年月日：令和元年 5月14日(火) 天候：雨のち曇り

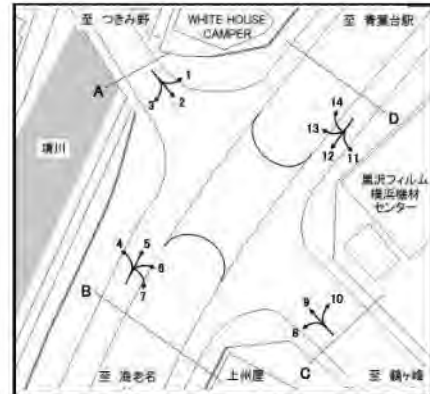

方向	6						7							
	種別	小型車 (台)	大型車 (台)	合計 (台)	大型車 混入率 (%)	時間 係数 (%)	二輪車 (台)	種別	小型車 (台)	大型車 (台)	合計 (台)	大型車 混入率 (%)	時間 係数 (%)	二輪車 (台)
23:00-23:15		20	11	31	35.5	0.8	1		0	0	0	0.0	0.0	0
23:15-23:30		11	9	20	45.0	0.5	1		0	0	0	0.0	0.0	0
23:30-23:45		13	9	22	40.9	0.6	0		0	0	0	0.0	0.0	0
23:45-24:00		4	12	16	75.0	0.4	0		0	0	0	0.0	0.0	0
1時間計		48	41	89	46.1	2.3	2		0	0	0	0.0	0.0	0
0:00-0:15		7	6	13	46.2	0.3	0		0	0	0	0.0	0.0	0
0:15-0:30		17	15	32	46.9	0.8	0		0	0	0	0.0	0.0	0
0:30-0:45		2	9	11	81.8	0.3	0		0	0	0	0.0	0.0	0
0:45-1:00		9	8	17	47.1	0.4	0		0	0	0	0.0	0.0	0
1時間計		35	38	73	52.1	1.9	0		0	0	0	0.0	0.0	0
1:00-1:15		11	13	24	54.2	0.6	0		0	0	0	0.0	0.0	0
1:15-1:30		10	9	19	47.4	0.5	0		0	0	0	0.0	0.0	0
1:30-1:45		11	8	19	42.1	0.5	0		0	0	0	0.0	0.0	0
1:45-2:00		6	5	11	45.5	0.3	0		0	0	0	0.0	0.0	0
1時間計		38	35	73	47.9	1.9	0		0	0	0	0.0	0.0	0
2:00-2:15		2	7	9	77.8	0.2	0		0	0	0	0.0	0.0	0
2:15-2:30		5	14	19	73.7	0.5	0		0	0	0	0.0	0.0	0
2:30-2:45		6	16	22	72.7	0.6	1		0	0	0	0.0	0.0	0
2:45-3:00		5	11	16	68.8	0.4	0		0	0	0	0.0	0.0	0
1時間計		18	48	66	72.7	1.7	1		0	0	0	0.0	0.0	0
3:00-3:15		7	14	21	66.7	0.5	1		0	0	0	0.0	0.0	0
3:15-3:30		4	6	10	60.0	0.3	0		0	0	0	0.0	0.0	0
3:30-3:45		11	12	23	52.2	0.6	0		0	0	0	0.0	0.0	0
3:45-4:00		6	19	25	76.0	0.6	0		0	0	0	0.0	0.0	0
1時間計		28	51	79	64.6	2.0	1		0	0	0	0.0	0.0	0
4:00-4:15		6	16	22	72.7	0.6	0		0	0	0	0.0	0.0	0
4:15-4:30		4	14	18	77.8	0.5	0		0	0	0	0.0	0.0	0
4:30-4:45		6	16	22	72.7	0.6	1		1	0	1	0.0	3.1	0
4:45-5:00		9	23	32	71.9	0.8	1		0	0	0	0.0	0.0	0
1時間計		25	69	94	73.4	2.4	2		1	0	1	0.0	3.1	0
5:00-5:15		25	27	52	51.9	1.3	0		0	0	0	0.0	0.0	0
5:15-5:30		21	23	44	52.3	1.1	6		0	0	0	0.0	0.0	0
5:30-5:45		33	27	60	45.0	1.5	3		0	0	0	0.0	0.0	0
5:45-6:00		38	25	63	39.7	1.6	1		0	0	0	0.0	0.0	0
1時間計		117	102	219	46.6	5.6	10		0	0	0	0.0	0.0	0
6:00-6:15		33	22	55	40.0	1.4	3		0	0	0	0.0	0.0	0
6:15-6:30		29	25	54	46.3	1.4	5		0	0	0	0.0	0.0	0
6:30-6:45		18	32	50	64.0	1.3	1		0	0	0	0.0	0.0	0
6:45-7:00		35	28	63	44.4	1.6	2		0	0	0	0.0	0.0	0
1時間計		115	107	222	48.2	5.6	11		0	0	0	0.0	0.0	0
夜12時間計		908	641	1549	41.4	39.3	47		4	0	4	0.0	12.5	0
全時間合計		2274	1670	3944	42.3	100.0	97		22	10	32	31.3	100.0	0
昼夜率		1.66	1.62	1.65	-	-	1.94		1.22	1.00	1.14	-	-	0.00

方向別自動車交通量調査表

調査地点：地域社会1 目黒

調査年月日：令和元年 5月14日(火) 天候：雨のち曇り

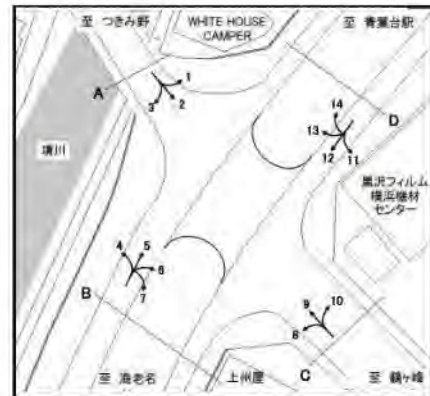

時間帯	方向 種別							B 合計 (4+ 5+ 6+ 7)					
		小型車 (台)	大型車 (台)	合計 (台)	大型車 混入率 (%)	時間 係数 (%)	二輪車 (台)	小型車 (台)	大型車 (台)	合計 (台)	大型車 混入率 (%)	時間 係数 (%)	二輪車 (台)
7:00- 7:15							48	29	77	37.7	1.2	5	
7:15- 7:30							39	26	65	40.0	1.0	4	
7:30- 7:45							51	32	83	38.6	1.3	3	
7:45- 8:00							58	27	85	31.8	1.3	5	
1 時間計							196	114	310	36.8	4.8	17	
8:00- 8:15							62	16	78	20.5	1.2	3	
8:15- 8:30							52	45	97	46.4	1.5	7	
8:30- 8:45							59	27	86	31.4	1.3	2	
8:45- 9:00							43	26	69	37.7	1.1	3	
1 時間計							216	114	330	34.5	5.1	15	
9:00- 9:15							36	33	69	47.8	1.1	0	
9:15- 9:30							30	26	56	46.4	0.9	1	
9:30- 9:45							29	29	58	50.0	0.9	3	
9:45-10:00							26	31	57	54.4	0.9	2	
1 時間計							121	119	240	49.6	3.7	6	
10:00-10:15							31	33	64	51.6	1.0	1	
10:15-10:30							50	38	88	43.2	1.4	0	
10:30-10:45							37	39	76	51.3	1.2	1	
10:45-11:00							46	48	94	51.1	1.4	0	
1 時間計							164	158	322	49.1	5.0	2	
11:00-11:15							59	42	101	41.6	1.6	2	
11:15-11:30							48	31	79	39.2	1.2	4	
11:30-11:45							49	39	88	44.3	1.4	1	
11:45-12:00							42	38	80	47.5	1.2	1	
1 時間計							198	150	348	43.1	5.4	8	
12:00-12:15							53	48	101	47.5	1.6	0	
12:15-12:30							61	35	96	36.5	1.5	0	
12:30-12:45							59	40	99	40.4	1.5	0	
12:45-13:00							63	34	97	35.1	1.5	1	
1 時間計							236	157	393	39.9	6.1	1	
13:00-13:15							58	42	100	42.0	1.5	0	
13:15-13:30							57	30	87	34.5	1.3	0	
13:30-13:45							49	40	89	44.9	1.4	2	
13:45-14:00							50	36	86	41.9	1.3	0	
1 時間計							214	148	362	40.9	5.6	2	
14:00-14:15							57	41	98	41.8	1.5	0	
14:15-14:30							56	37	93	39.8	1.4	0	
14:30-14:45							67	32	99	32.3	1.5	1	
14:45-15:00							55	35	90	38.9	1.4	0	
1 時間計							235	145	380	38.2	5.9	1	

方向別自動車交通量調査表

調査地点：地域社会1 目黒

調査年月日：令和元年 5月14日(火) 天候：雨のち曇り

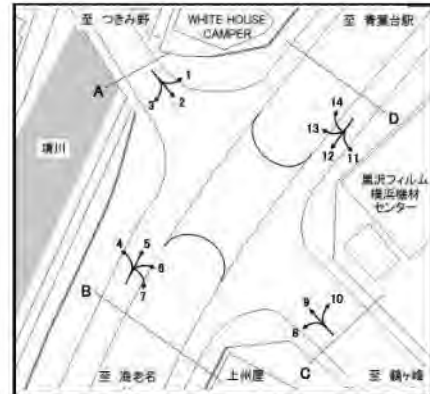

方向 時間帯	種別						B 合計 (4+ 5+ 6+ 7)					
		小型車 (台)	大型車 (台)	合計 (台)	大型車 混入率 (%)	時間 係数 (%)	二輪車 (台)	小型車 (台)	大型車 (台)	合計 (台)	大型車 混入率 (%)	時間 係数 (%)
15:00-15:15							52	38	90	42.2	1.4	2
15:15-15:30							41	21	62	33.9	1.0	1
15:30-15:45							62	19	81	23.5	1.2	1
15:45-16:00							52	24	76	31.6	1.2	1
1時間計							207	102	309	33.0	4.8	5
16:00-16:15							50	21	71	29.6	1.1	2
16:15-16:30							52	22	74	29.7	1.1	1
16:30-16:45							60	27	87	31.0	1.3	0
16:45-17:00							80	30	110	27.3	1.7	2
1時間計							242	100	342	29.2	5.3	5
17:00-17:15							78	18	96	18.8	1.5	2
17:15-17:30							81	10	91	11.0	1.4	1
17:30-17:45							68	8	76	10.5	1.2	3
17:45-18:00							75	17	92	18.5	1.4	9
1時間計							302	53	355	14.9	5.5	15
18:00-18:15							116	22	138	15.9	2.1	1
18:15-18:30							81	11	92	12.0	1.4	3
18:30-18:45							86	16	102	15.7	1.6	3
18:45-19:00							44	10	54	18.5	0.8	1
1時間計							327	59	386	15.3	5.9	8
昼12時間計							2658	1419	4077	34.8	62.8	85
19:00-19:15							74	15	89	16.9	1.4	2
19:15-19:30							82	8	90	8.9	1.4	4
19:30-19:45							64	7	71	9.9	1.1	3
19:45-20:00							64	5	69	7.2	1.1	3
1時間計							284	35	319	11.0	4.9	12
20:00-20:15							72	15	87	17.2	1.3	3
20:15-20:30							75	17	92	18.5	1.4	3
20:30-20:45							60	6	66	9.1	1.0	4
20:45-21:00							48	11	59	18.6	0.9	2
1時間計							255	49	304	16.1	4.7	12
21:00-21:15							50	8	58	13.8	0.9	0
21:15-21:30							58	13	71	18.3	1.1	2
21:30-21:45							22	3	25	12.0	0.4	1
21:45-22:00							30	6	36	16.7	0.6	0
1時間計							160	30	190	15.8	2.9	3
22:00-22:15							32	19	51	37.3	0.8	3
22:15-22:30							39	14	53	26.4	0.8	0
22:30-22:45							41	7	48	14.6	0.7	1
22:45-23:00							35	12	47	25.5	0.7	1
1時間計							147	52	199	26.1	3.1	5

方向別自動車交通量調査表

調査地点：地域社会1 目黒

調査年月日：令和元年 5月14日(火) 天候：雨のち曇り

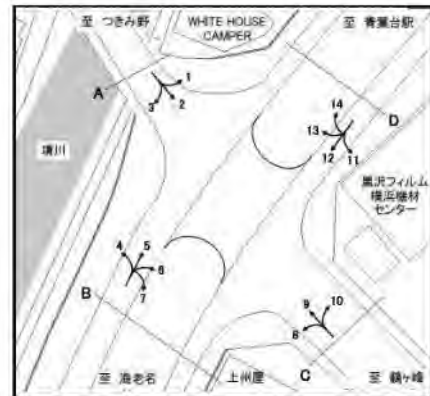

時間帯	方向 種別							B 合計 (4+ 5+ 6+ 7)					
		小型車 (台)	大型車 (台)	合計 (台)	大型車 混入率 (%)	時間 係数 (%)	二輪車 (台)	小型車 (台)	大型車 (台)	合計 (台)	大型車 混入率 (%)	時間 係数 (%)	二輪車 (台)
23:00-23:15							31	14	45	31.1	0.7	1	
23:15-23:30							19	9	28	32.1	0.4	1	
23:30-23:45							18	10	28	35.7	0.4	0	
23:45-24:00							10	12	22	54.5	0.3	1	
1 時間計							78	45	123	36.6	1.9	3	
0:00- 0:15							17	7	24	29.2	0.4	0	
0:15- 0:30							35	18	53	34.0	0.8	0	
0:30- 0:45							10	9	19	47.4	0.3	0	
0:45- 1:00							12	10	22	45.5	0.3	0	
1 時間計							74	44	118	37.3	1.8	0	
1:00- 1:15							19	15	34	44.1	0.5	0	
1:15- 1:30							14	14	28	50.0	0.4	0	
1:30- 1:45							18	13	31	41.9	0.5	0	
1:45- 2:00							10	6	16	37.5	0.2	0	
1 時間計							61	48	109	44.0	1.7	0	
2:00- 2:15							6	7	13	53.8	0.2	0	
2:15- 2:30							12	16	28	57.1	0.4	1	
2:30- 2:45							9	22	31	71.0	0.5	1	
2:45- 3:00							9	12	21	57.1	0.3	0	
1 時間計							36	57	93	61.3	1.4	2	
3:00- 3:15							9	14	23	60.9	0.4	1	
3:15- 3:30							6	9	15	60.0	0.2	0	
3:30- 3:45							13	13	26	50.0	0.4	0	
3:45- 4:00							7	27	34	79.4	0.5	0	
1 時間計							35	63	98	64.3	1.5	1	
4:00- 4:15							9	20	29	69.0	0.4	0	
4:15- 4:30							5	17	22	77.3	0.3	0	
4:30- 4:45							7	21	28	75.0	0.4	3	
4:45- 5:00							14	26	40	65.0	0.6	2	
1 時間計							35	84	119	70.6	1.8	5	
5:00- 5:15							35	29	64	45.3	1.0	0	
5:15- 5:30							39	28	67	41.8	1.0	7	
5:30- 5:45							62	39	101	38.6	1.6	3	
5:45- 6:00							78	38	116	32.8	1.8	2	
1 時間計							214	134	348	38.5	5.4	12	
6:00- 6:15							83	33	116	28.4	1.8	3	
6:15- 6:30							51	32	83	38.6	1.3	6	
6:30- 6:45							48	42	90	46.7	1.4	3	
6:45- 7:00							68	36	104	34.6	1.6	3	
1 時間計							250	143	393	36.4	6.1	15	
夜12時間計							1629	784	2413	32.5	37.2	70	
全時間合計							4287	2203	6490	33.9	100.0	155	
昼夜率							1.61	1.55	1.59	-	-	1.82	

方向別自動車交通量調査表

調査地点：地域社会1 目黒

調査年月日：令和元年 5月14日(火) 天候：雨のち曇り

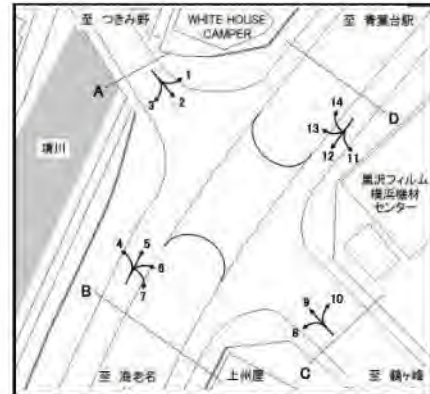

時間帯	種別	8						9					
		小型車 (台)	大型車 (台)	合計 (台)	大型車 混入率 (%)	時間 係数 (%)	二輪車 (台)	小型車 (台)	大型車 (台)	合計 (台)	大型車 混入率 (%)	時間 係数 (%)	二輪車 (台)
7:00-7:15		36	35	71	49.3	1.2	2	94	37	131	28.2	1.8	1
7:15-7:30		49	30	79	38.0	1.4	2	98	22	120	18.3	1.7	11
7:30-7:45		54	41	95	43.2	1.6	4	85	32	117	27.4	1.6	12
7:45-8:00		47	32	79	40.5	1.4	7	82	27	109	24.8	1.5	9
1時間計		186	138	324	42.6	5.5	15	359	118	477	24.7	6.6	33
8:00-8:15		52	23	75	30.7	1.3	1	80	16	96	16.7	1.3	4
8:15-8:30		31	29	60	48.3	1.0	3	66	18	84	21.4	1.2	7
8:30-8:45		30	34	64	53.1	1.1	0	53	21	74	28.4	1.0	2
8:45-9:00		46	35	81	43.2	1.4	2	99	35	134	26.1	1.9	5
1時間計		159	121	280	43.2	4.8	6	298	90	388	23.2	5.4	18
9:00-9:15		29	32	61	52.5	1.0	1	72	26	98	26.5	1.4	1
9:15-9:30		31	35	66	53.0	1.1	0	73	18	91	19.8	1.3	2
9:30-9:45		33	32	65	49.2	1.1	2	68	28	96	29.2	1.3	4
9:45-10:00		25	35	60	58.3	1.0	0	76	23	99	23.2	1.4	0
1時間計		118	134	252	53.2	4.3	3	289	95	384	24.7	5.3	7
10:00-10:15		32	33	65	50.8	1.1	3	58	30	88	34.1	1.2	4
10:15-10:30		27	34	61	55.7	1.0	1	66	30	96	31.3	1.3	1
10:30-10:45		40	44	84	52.4	1.4	0	62	26	88	29.5	1.2	2
10:45-11:00		28	38	66	57.6	1.1	1	66	23	89	25.8	1.2	5
1時間計		127	149	276	54.0	4.7	5	252	109	361	30.2	5.0	12
11:00-11:15		25	37	62	59.7	1.1	0	56	19	75	25.3	1.0	3
11:15-11:30		40	40	80	50.0	1.4	1	84	35	119	29.4	1.6	4
11:30-11:45		26	43	69	62.3	1.2	0	52	26	78	33.3	1.1	2
11:45-12:00		18	47	65	72.3	1.1	2	76	20	96	20.8	1.3	2
1時間計		109	167	276	60.5	4.7	3	268	100	368	27.2	5.1	11
12:00-12:15		24	55	79	69.6	1.4	0	73	18	91	19.8	1.3	1
12:15-12:30		28	48	76	63.2	1.3	0	65	33	98	33.7	1.4	1
12:30-12:45		40	30	70	42.9	1.2	1	70	20	90	22.2	1.2	3
12:45-13:00		37	27	64	42.2	1.1	0	58	17	75	22.7	1.0	4
1時間計		129	160	289	55.4	4.9	1	266	88	354	24.9	4.9	9
13:00-13:15		40	36	76	47.4	1.3	0	62	11	73	15.1	1.0	3
13:15-13:30		42	34	76	44.7	1.3	1	70	23	93	24.7	1.3	0
13:30-13:45		43	31	74	41.9	1.3	3	62	20	82	24.4	1.1	2
13:45-14:00		34	43	77	55.8	1.3	0	62	12	74	16.2	1.0	0
1時間計		159	144	303	47.5	5.2	4	256	66	322	20.5	4.5	5
14:00-14:15		55	46	101	45.5	1.7	0	93	18	111	16.2	1.5	5
14:15-14:30		34	23	57	40.4	1.0	0	60	8	68	11.8	0.9	0
14:30-14:45		32	42	74	56.8	1.3	0	71	21	92	22.8	1.3	2
14:45-15:00		28	45	73	61.6	1.2	2	55	15	70	21.4	1.0	2
1時間計		149	156	305	51.1	5.2	2	279	62	341	18.2	4.7	9

方向別自動車交通量調査表

調査地点：地域社会1 目黒

調査年月日：令和元年 5月14日(火) 天候：雨のち曇り



方向 時間帯	8						9					
	種別 小型車 (台)	大型車 (台)	合計 (台)	大型車 混入率 (%)	時係 数 (%)	二輪車 (台)	種別 小型車 (台)	大型車 (台)	合計 (台)	大型車 混入率 (%)	時係 数 (%)	二輪車 (台)
15:00-15:15	38	35	73	47.9	1.2	1	78	23	101	22.8	1.4	2
15:15-15:30	40	40	80	50.0	1.4	0	91	10	101	9.9	1.4	2
15:30-15:45	47	29	76	38.2	1.3	2	76	17	93	18.3	1.3	0
15:45-16:00	42	35	77	45.5	1.3	0	58	18	76	23.7	1.1	6
1時間計	167	139	306	45.4	5.2	3	303	68	371	18.3	5.1	10
16:00-16:15	44	36	80	45.0	1.4	1	85	20	105	19.0	1.5	2
16:15-16:30	46	32	78	41.0	1.3	1	96	15	111	13.5	1.5	4
16:30-16:45	49	39	88	44.3	1.5	2	86	17	103	16.5	1.4	10
16:45-17:00	57	30	87	34.5	1.5	0	98	16	114	14.0	1.6	4
1時間計	196	137	333	41.1	5.7	4	365	68	433	15.7	6.0	20
17:00-17:15	58	28	86	32.6	1.5	1	103	8	111	7.2	1.5	3
17:15-17:30	70	20	90	22.2	1.5	2	114	4	118	3.4	1.6	8
17:30-17:45	61	34	95	35.8	1.6	5	121	10	131	7.6	1.8	8
17:45-18:00	60	16	76	21.1	1.3	3	108	11	119	9.2	1.6	5
1時間計	249	98	347	28.2	5.9	11	446	33	479	6.9	6.6	24
18:00-18:15	50	29	79	36.7	1.4	3	126	11	137	8.0	1.9	12
18:15-18:30	50	24	74	32.4	1.3	3	122	12	134	9.0	1.9	11
18:30-18:45	59	26	85	30.6	1.5	3	109	14	123	11.4	1.7	3
18:45-19:00	51	11	62	17.7	1.1	2	95	10	105	9.5	1.5	1
1時間計	210	90	300	30.0	5.1	11	452	47	499	9.4	6.9	27
昼12時間計	1958	1633	3591	45.5	61.5	68	3833	944	4777	19.8	66.1	185
19:00-19:15	69	22	91	24.2	1.6	3	110	15	125	12.0	1.7	10
19:15-19:30	45	14	59	23.7	1.0	0	107	7	114	6.1	1.6	3
19:30-19:45	48	11	59	18.6	1.0	1	116	5	121	4.1	1.7	8
19:45-20:00	69	14	83	16.9	1.4	1	105	12	117	10.3	1.6	6
1時間計	231	61	292	20.9	5.0	5	438	39	477	8.2	6.6	27
20:00-20:15	62	9	71	12.7	1.2	1	76	12	88	13.6	1.2	4
20:15-20:30	60	13	73	17.8	1.2	1	83	5	88	5.7	1.2	7
20:30-20:45	49	11	60	18.3	1.0	1	76	8	84	9.5	1.2	3
20:45-21:00	35	14	49	28.6	0.8	3	72	6	78	7.7	1.1	2
1時間計	206	47	253	18.6	4.3	6	307	31	338	9.2	4.7	16
21:00-21:15	50	18	68	26.5	1.2	0	61	11	72	15.3	1.0	0
21:15-21:30	58	21	79	26.6	1.4	2	81	11	92	12.0	1.3	4
21:30-21:45	45	22	67	32.8	1.1	1	53	12	65	18.5	0.9	2
21:45-22:00	51	21	72	29.2	1.2	1	55	10	65	15.4	0.9	6
1時間計	204	82	286	28.7	4.9	4	250	44	294	15.0	4.1	12
22:00-22:15	38	7	45	15.6	0.8	1	47	10	57	17.5	0.8	5
22:15-22:30	51	12	63	19.0	1.1	1	54	7	61	11.5	0.8	2
22:30-22:45	50	12	62	19.4	1.1	1	43	6	49	12.2	0.7	4
22:45-23:00	32	7	39	17.9	0.7	1	38	5	43	11.6	0.6	1
1時間計	171	38	209	18.2	3.6	4	182	28	210	13.3	2.9	12

方向別自動車交通量調査表

調査地点：地域社会1 目黒

調査年月日：令和元年 5月14日(火) 天候：雨のち曇り

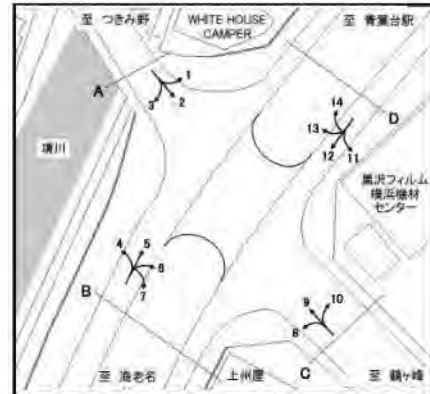

時間帯	8						9					
	小型車 (台)	大型車 (台)	合計 (台)	大型車 混入率 (%)	時 間 係 数 (%)	二輪車 (台)	小型車 (台)	大型車 (台)	合計 (台)	大型車 混入率 (%)	時 間 係 数 (%)	二輪車 (台)
23:00-23:15	30	16	46	34.8	0.8	1	35	12	47	25.5	0.7	1
23:15-23:30	24	14	38	36.8	0.7	0	13	8	21	38.1	0.3	0
23:30-23:45	27	13	40	32.5	0.7	0	20	6	26	23.1	0.4	0
23:45-24:00	19	9	28	32.1	0.5	0	15	7	22	31.8	0.3	1
1 時間計	100	52	152	34.2	2.6	1	83	33	116	28.4	1.6	2
0:00-0:15	18	10	28	35.7	0.5	0	15	9	24	37.5	0.3	1
0:15-0:30	12	8	20	40.0	0.3	1	13	6	19	31.6	0.3	1
0:30-0:45	16	11	27	40.7	0.5	0	15	9	24	37.5	0.3	0
0:45-1:00	8	3	11	27.3	0.2	1	31	15	46	32.6	0.6	0
1 時間計	54	32	86	37.2	1.5	2	74	39	113	34.5	1.6	2
1:00-1:15	22	16	38	42.1	0.7	1	23	10	33	30.3	0.5	3
1:15-1:30	12	9	21	42.9	0.4	0	6	8	14	57.1	0.2	3
1:30-1:45	10	13	23	56.5	0.4	0	11	6	17	35.3	0.2	0
1:45-2:00	8	10	18	55.6	0.3	1	3	5	8	62.5	0.1	0
1 時間計	52	48	100	48.0	1.7	2	43	29	72	40.3	1.0	6
2:00-2:15	9	11	20	55.0	0.3	0	12	11	23	47.8	0.3	1
2:15-2:30	10	15	25	60.0	0.4	1	14	16	30	53.3	0.4	0
2:30-2:45	9	15	24	62.5	0.4	0	3	13	16	81.3	0.2	1
2:45-3:00	6	19	25	76.0	0.4	0	8	13	21	61.9	0.3	1
1 時間計	34	60	94	63.8	1.6	1	37	53	90	58.9	1.2	3
3:00-3:15	7	29	36	80.6	0.6	0	8	13	21	61.9	0.3	0
3:15-3:30	4	9	13	69.2	0.2	0	2	9	11	81.8	0.2	0
3:30-3:45	15	26	41	63.4	0.7	0	13	20	33	60.6	0.5	0
3:45-4:00	6	10	16	62.5	0.3	0	2	15	17	88.2	0.2	0
1 時間計	32	74	106	69.8	1.8	0	25	57	82	69.5	1.1	0
4:00-4:15	8	17	25	68.0	0.4	0	9	16	25	64.0	0.3	0
4:15-4:30	7	20	27	74.1	0.5	1	12	7	19	36.8	0.3	1
4:30-4:45	5	18	23	78.3	0.4	0	6	9	15	60.0	0.2	0
4:45-5:00	17	24	41	58.5	0.7	1	15	8	23	34.8	0.3	0
1 時間計	37	79	116	68.1	2.0	2	42	40	82	48.8	1.1	1
5:00-5:15	12	26	38	68.4	0.7	1	15	11	26	42.3	0.4	1
5:15-5:30	16	44	60	73.3	1.0	1	22	18	40	45.0	0.6	1
5:30-5:45	25	44	69	63.8	1.2	2	28	18	46	39.1	0.6	1
5:45-6:00	31	57	88	64.8	1.5	0	45	20	65	30.8	0.9	1
1 時間計	84	171	255	67.1	4.4	4	110	67	177	37.9	2.4	4
6:00-6:15	41	34	75	45.3	1.3	1	49	26	75	34.7	1.0	2
6:15-6:30	49	41	90	45.6	1.5	0	78	29	107	27.1	1.5	7
6:30-6:45	36	26	62	41.9	1.1	6	85	23	108	21.3	1.5	7
6:45-7:00	43	33	76	43.4	1.3	0	88	21	109	19.3	1.5	8
1 時間計	169	134	303	44.2	5.2	7	300	99	399	24.8	5.5	24
夜12時間計	1374	878	2252	39.0	38.5	38	1891	559	2450	22.8	33.9	109
全時間合計	3332	2511	5843	43.0	100.0	106	5724	1503	7227	20.8	100.0	294
昼 夜 率	1.70	1.54	1.63	-	-	1.56	1.49	1.59	1.51	-	-	1.59

方向別自動車交通量調査表

調査地点：地域社会1 目黒

調査年月日：令和元年 5月14日(火) 天候：雨のち曇り



時間帯	種別	10						C 合計 (8+ 9+10)					
		小型車 (台)	大型車 (台)	合計 (台)	大型車 混入率 (%)	時 間 係 数 (%)	二輪車 (台)	小型車 (台)	大型車 (台)	合計 (台)	大型車 混入率 (%)	時 間 係 数 (%)	二輪車 (台)
7:00- 7:15		17	8	25	32.0	1.3	2	147	80	227	35.2	1.5	5
7:15- 7:30		23	2	25	8.0	1.3	4	170	54	224	24.1	1.5	17
7:30- 7:45		31	13	44	29.5	2.3	3	170	86	256	33.6	1.7	19
7:45- 8:00		22	6	28	21.4	1.5	1	151	65	216	30.1	1.4	17
1 時間計		93	29	122	23.8	6.5	10	638	285	923	30.9	6.2	58
8:00- 8:15		29	11	40	27.5	2.1	2	161	50	211	23.7	1.4	7
8:15- 8:30		25	9	34	26.5	1.8	1	122	56	178	31.5	1.2	11
8:30- 8:45		16	13	29	44.8	1.5	1	99	68	167	40.7	1.1	3
8:45- 9:00		20	12	32	37.5	1.7	1	165	82	247	33.2	1.7	8
1 時間計		90	45	135	33.3	7.2	5	547	256	803	31.9	5.4	29
9:00- 9:15		19	10	29	34.5	1.5	0	120	68	188	36.2	1.3	2
9:15- 9:30		15	7	22	31.8	1.2	1	119	60	179	33.5	1.2	3
9:30- 9:45		14	12	26	46.2	1.4	0	115	72	187	38.5	1.3	6
9:45-10:00		19	17	36	47.2	1.9	0	120	75	195	38.5	1.3	0
1 時間計		67	46	113	40.7	6.0	1	474	275	749	36.7	5.0	11
10:00-10:15		19	14	33	42.4	1.8	0	109	77	186	41.4	1.2	7
10:15-10:30		15	10	25	40.0	1.3	1	108	74	182	40.7	1.2	3
10:30-10:45		12	11	23	47.8	1.2	0	114	81	195	41.5	1.3	2
10:45-11:00		15	10	25	40.0	1.3	1	109	71	180	39.4	1.2	7
1 時間計		61	45	106	42.5	5.7	2	440	303	743	40.8	5.0	19
11:00-11:15		16	8	24	33.3	1.3	0	97	64	161	39.8	1.1	3
11:15-11:30		12	8	20	40.0	1.1	0	136	83	219	37.9	1.5	5
11:30-11:45		9	10	19	52.6	1.0	1	87	79	166	47.6	1.1	3
11:45-12:00		12	16	28	57.1	1.5	0	106	83	189	43.9	1.3	4
1 時間計		49	42	91	46.2	4.9	1	426	309	735	42.0	4.9	15
12:00-12:15		15	13	28	46.4	1.5	1	112	86	198	43.4	1.3	2
12:15-12:30		11	9	20	45.0	1.1	2	104	90	194	46.4	1.3	3
12:30-12:45		12	14	26	53.8	1.4	1	122	64	186	34.4	1.2	5
12:45-13:00		19	6	25	24.0	1.3	0	114	50	164	30.5	1.1	4
1 時間計		57	42	99	42.4	5.3	4	452	290	742	39.1	5.0	14
13:00-13:15		20	15	35	42.9	1.9	1	122	62	184	33.7	1.2	4
13:15-13:30		9	6	15	40.0	0.8	0	121	63	184	34.2	1.2	1
13:30-13:45		13	3	16	18.8	0.9	0	118	54	172	31.4	1.2	5
13:45-14:00		15	10	25	40.0	1.3	0	111	65	176	36.9	1.2	0
1 時間計		57	34	91	37.4	4.9	1	472	244	716	34.1	4.8	10
14:00-14:15		25	16	41	39.0	2.2	0	173	80	253	31.6	1.7	5
14:15-14:30		10	5	15	33.3	0.8	1	104	36	140	25.7	0.9	1
14:30-14:45		29	11	40	27.5	2.1	0	132	74	206	35.9	1.4	2
14:45-15:00		13	5	18	27.8	1.0	0	96	65	161	40.4	1.1	4
1 時間計		77	37	114	32.5	6.1	1	505	255	760	33.6	5.1	12

方向別自動車交通量調査表

調査地点：地域社会1 目黒

調査年月日：令和元年 5月14日(火) 天候：雨のち曇り

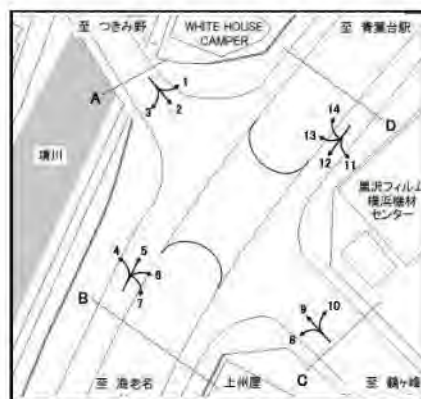

時間帯	種別	10					C 合計 (8+9+10)						
		小型車 (台)	大型車 (台)	合計 (台)	大型車 混入率 (%)	時 間 係 数 (%)	二輪車 (台)	小型車 (台)	大型車 (台)	合計 (台)	大型車 混入率 (%)	時 間 係 数 (%)	二輪車 (台)
15:00-15:15		19	5	24	20.8	1.3	0	135	63	198	31.8	1.3	3
15:15-15:30		23	7	30	23.3	1.6	1	154	57	211	27.0	1.4	3
15:30-15:45		15	6	21	28.6	1.1	0	138	52	190	27.4	1.3	2
15:45-16:00		28	4	32	12.5	1.7	0	128	57	185	30.8	1.2	6
1時間計		85	22	107	20.6	5.7	1	555	229	784	29.2	5.2	14
16:00-16:15		22	5	27	18.5	1.4	0	151	61	212	28.8	1.4	3
16:15-16:30		25	5	30	16.7	1.6	0	167	52	219	23.7	1.5	5
16:30-16:45		20	4	24	16.7	1.3	0	155	60	215	27.9	1.4	12
16:45-17:00		17	4	21	19.0	1.1	1	172	50	222	22.5	1.5	5
1時間計		84	18	102	17.6	5.4	1	645	223	868	25.7	5.8	25
17:00-17:15		30	2	32	6.3	1.7	2	191	38	229	16.6	1.5	6
17:15-17:30		23	6	29	20.7	1.5	1	207	30	237	12.7	1.6	11
17:30-17:45		18	1	19	5.3	1.0	1	200	45	245	18.4	1.6	14
17:45-18:00		22	6	28	21.4	1.5	0	190	33	223	14.8	1.5	8
1時間計		93	15	108	13.9	5.8	4	788	146	934	15.6	6.3	39
18:00-18:15		31	8	39	20.5	2.1	1	207	48	255	18.8	1.7	16
18:15-18:30		32	3	35	8.6	1.9	0	204	39	243	16.0	1.6	14
18:30-18:45		40	1	41	2.4	2.2	1	208	41	249	16.5	1.7	7
18:45-19:00		18	1	19	5.3	1.0	1	164	22	186	11.8	1.2	4
1時間計		121	13	134	9.7	7.2	3	783	150	933	16.1	6.2	41
昼12時間計		934	388	1322	29.3	70.5	34	6725	2965	9690	30.6	64.8	287
19:00-19:15		27	2	29	6.9	1.5	2	206	39	245	15.9	1.6	15
19:15-19:30		16	2	18	11.1	1.0	0	168	23	191	12.0	1.3	3
19:30-19:45		21	3	24	12.5	1.3	1	185	19	204	9.3	1.4	10
19:45-20:00		23	3	26	11.5	1.4	1	197	29	226	12.8	1.5	8
1時間計		87	10	97	10.3	5.2	4	756	110	866	12.7	5.8	36
20:00-20:15		15	1	16	6.3	0.9	1	153	22	175	12.6	1.2	6
20:15-20:30		16	1	17	5.9	0.9	0	159	19	178	10.7	1.2	8
20:30-20:45		29	3	32	9.4	1.7	1	154	22	176	12.5	1.2	5
20:45-21:00		14	0	14	0.0	0.7	0	121	20	141	14.2	0.9	5
1時間計		74	5	79	6.3	4.2	2	587	83	670	12.4	4.5	24
21:00-21:15		16	0	16	0.0	0.9	0	127	29	156	18.6	1.0	0
21:15-21:30		13	1	14	7.1	0.7	0	152	33	185	17.8	1.2	6
21:30-21:45		24	4	28	14.3	1.5	0	122	38	160	23.8	1.1	3
21:45-22:00		17	1	18	5.6	1.0	0	123	32	155	20.6	1.0	7
1時間計		70	6	76	7.9	4.1	0	524	132	656	20.1	4.4	16
22:00-22:15		17	2	19	10.5	1.0	0	102	19	121	15.7	0.8	6
22:15-22:30		20	1	21	4.8	1.1	0	125	20	145	13.8	1.0	3
22:30-22:45		13	3	16	18.8	0.9	0	106	21	127	16.5	0.8	5
22:45-23:00		12	3	15	20.0	0.8	1	82	15	97	15.5	0.6	3
1時間計		62	9	71	12.7	3.8	1	415	75	490	15.3	3.3	17

方向別自動車交通量調査表

調査地点 : 地域社会1 目黒

調査年月日 : 令和元年 5月14日(火) 天候: 雨のち曇り

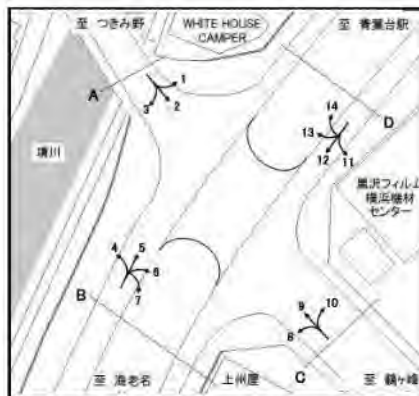

時間帯	方向 種別	10						C 合計 (8+ 9+10)					
		小型車 (台)	大型車 (台)	合計 (台)	大型車 混入率 (%)	時 間 係 数 (%)	二輪車 (台)	小型車 (台)	大型車 (台)	合計 (台)	大型車 混入率 (%)	時 間 係 数 (%)	二輪車 (台)
23:00-23:15		5	2	7	28.6	0.4	0	70	30	100	30.0	0.7	2
23:15-23:30		7	1	8	12.5	0.4	0	44	23	67	34.3	0.4	0
23:30-23:45		2	2	4	50.0	0.2	0	49	21	70	30.0	0.5	0
23:45-24:00		5	6	11	54.5	0.6	0	39	22	61	36.1	0.4	1
1 時間計		19	11	30	36.7	1.6	0	202	96	298	32.2	2.0	3
0:00- 0:15		1	1	2	50.0	0.1	1	34	20	54	37.0	0.4	2
0:15- 0:30		7	0	7	0.0	0.4	0	32	14	46	30.4	0.3	2
0:30- 0:45		6	3	9	33.3	0.5	1	37	23	60	38.3	0.4	1
0:45- 1:00		8	3	11	27.3	0.6	1	47	21	68	30.9	0.5	2
1 時間計		22	7	29	24.1	1.5	3	150	78	228	34.2	1.5	7
1:00- 1:15		6	1	7	14.3	0.4	0	51	27	78	34.6	0.5	4
1:15- 1:30		0	0	0	0.0	0.0	0	18	17	35	48.6	0.2	3
1:30- 1:45		0	5	5	100.0	0.3	0	21	24	45	53.3	0.3	0
1:45- 2:00		1	4	5	80.0	0.3	1	12	19	31	61.3	0.2	2
1 時間計		7	10	17	58.8	0.9	1	102	87	189	46.0	1.3	9
2:00- 2:15		3	3	6	50.0	0.3	1	24	25	49	51.0	0.3	2
2:15- 2:30		0	2	2	100.0	0.1	0	24	33	57	57.9	0.4	1
2:30- 2:45		1	1	2	50.0	0.1	0	13	29	42	69.0	0.3	1
2:45- 3:00		0	1	1	100.0	0.1	0	14	33	47	70.2	0.3	1
1 時間計		4	7	11	63.6	0.6	1	75	120	195	61.5	1.3	5
3:00- 3:15		1	3	4	75.0	0.2	0	16	45	61	73.8	0.4	0
3:15- 3:30		1	1	2	50.0	0.1	0	7	19	26	73.1	0.2	0
3:30- 3:45		1	6	7	85.7	0.4	1	29	52	81	64.2	0.5	1
3:45- 4:00		0	3	3	100.0	0.2	0	8	28	36	77.8	0.2	0
1 時間計		3	13	16	81.3	0.9	1	60	144	204	70.6	1.4	1
4:00- 4:15		2	4	6	66.7	0.3	0	19	37	56	66.1	0.4	0
4:15- 4:30		1	3	4	75.0	0.2	0	20	30	50	60.0	0.3	2
4:30- 4:45		3	5	8	62.5	0.4	0	14	32	46	69.6	0.3	0
4:45- 5:00		0	3	3	100.0	0.2	0	32	35	67	52.2	0.4	1
1 時間計		6	15	21	71.4	1.1	0	85	134	219	61.2	1.5	3
5:00- 5:15		2	5	7	71.4	0.4	0	29	42	71	59.2	0.5	2
5:15- 5:30		7	6	13	46.2	0.7	0	45	68	113	60.2	0.8	2
5:30- 5:45		9	7	16	43.8	0.9	0	62	69	131	52.7	0.9	3
5:45- 6:00		6	3	9	33.3	0.5	1	82	80	162	49.4	1.1	2
1 時間計		24	21	45	46.7	2.4	1	218	259	477	54.3	3.2	9
6:00- 6:15		3	5	8	62.5	0.4	0	93	65	158	41.1	1.1	3
6:15- 6:30		5	10	15	66.7	0.8	0	132	80	212	37.7	1.4	7
6:30- 6:45		10	5	15	33.3	0.8	2	131	54	185	29.2	1.2	15
6:45- 7:00		15	7	22	31.8	1.2	0	146	61	207	29.5	1.4	8
1 時間計		33	27	60	45.0	3.2	2	502	260	762	34.1	5.1	33
夜12時間計		411	141	552	25.5	29.5	16	3676	1578	5254	30.0	35.2	163
全時間合計		1345	529	1874	28.2	100.0	50	10401	4543	14944	30.4	100.0	450
昼 夜 率		1.44	1.36	1.42	-	-	1.47	1.55	1.53	1.54	-	-	1.57

方向別自動車交通量調査表

調査地点：地域社会1 目黒

調査年月日：令和元年 5月14日(火) 天候：雨のち曇り

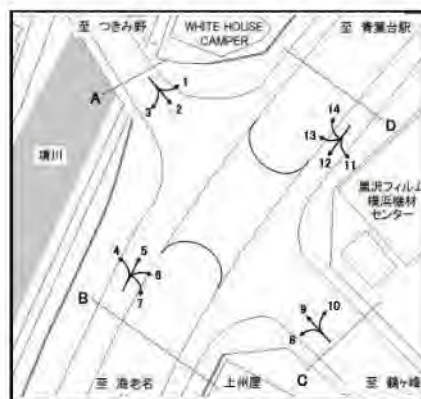

方向 時間帯	11						12					
	種別 小型車 (台)	大型車 (台)	合計 (台)	大型車 混入率 (%)	時 間 係 数 (%)	二輪車 (台)	小型車 (台)	大型車 (台)	合計 (台)	大型車 混入率 (%)	時 間 係 数 (%)	二輪車 (台)
7:00-7:15	11	3	14	21.4	0.9	0	8	1	9	11.1	1.3	1
7:15-7:30	19	6	25	24.0	1.7	0	2	3	5	60.0	0.7	0
7:30-7:45	16	4	20	20.0	1.4	1	7	2	9	22.2	1.3	1
7:45-8:00	9	8	17	47.1	1.1	0	6	2	8	25.0	1.1	1
1時間計	55	21	76	27.6	5.1	1	23	8	31	25.8	4.4	3
8:00-8:15	13	5	18	27.8	1.2	1	15	1	16	6.3	2.3	0
8:15-8:30	10	9	19	47.4	1.3	0	10	1	11	9.1	1.6	1
8:30-8:45	11	6	17	35.3	1.1	0	9	1	10	10.0	1.4	0
8:45-9:00	20	13	33	39.4	2.2	0	11	2	13	15.4	1.9	1
1時間計	54	33	87	37.9	5.9	1	45	5	50	10.0	7.2	2
9:00-9:15	19	7	26	26.9	1.8	1	10	3	13	23.1	1.9	0
9:15-9:30	21	7	28	25.0	1.9	0	9	1	10	10.0	1.4	0
9:30-9:45	15	14	29	48.3	2.0	0	11	1	12	8.3	1.7	1
9:45-10:00	11	15	26	57.7	1.8	0	11	1	12	8.3	1.7	0
1時間計	66	43	109	39.4	7.4	1	41	6	47	12.8	6.7	1
10:00-10:15	22	9	31	29.0	2.1	0	8	2	10	20.0	1.4	1
10:15-10:30	11	4	15	26.7	1.0	0	10	2	12	16.7	1.7	0
10:30-10:45	9	4	13	30.8	0.9	0	6	0	6	0.0	0.9	0
10:45-11:00	11	5	16	31.3	1.1	0	5	1	6	16.7	0.9	1
1時間計	53	22	75	29.3	5.1	0	29	5	34	14.7	4.9	2
11:00-11:15	20	10	30	33.3	2.0	0	10	2	12	16.7	1.7	0
11:15-11:30	20	8	28	28.6	1.9	0	4	2	6	33.3	0.9	0
11:30-11:45	18	18	36	50.0	2.4	0	8	2	10	20.0	1.4	0
11:45-12:00	8	10	18	55.6	1.2	0	7	0	7	0.0	1.0	0
1時間計	66	46	112	41.1	7.6	0	29	6	35	17.1	5.0	0
12:00-12:15	6	4	10	40.0	0.7	0	11	0	11	0.0	1.6	1
12:15-12:30	14	15	29	51.7	2.0	0	5	1	6	16.7	0.9	2
12:30-12:45	17	7	24	29.2	1.6	0	8	2	10	20.0	1.4	0
12:45-13:00	7	8	15	53.3	1.0	0	8	2	10	20.0	1.4	0
1時間計	44	34	78	43.6	5.3	0	32	5	37	13.5	5.3	3
13:00-13:15	13	8	21	38.1	1.4	0	4	0	4	0.0	0.6	1
13:15-13:30	11	11	22	50.0	1.5	0	6	1	7	14.3	1.0	0
13:30-13:45	9	13	22	59.1	1.5	0	9	0	9	0.0	1.3	0
13:45-14:00	8	14	22	63.6	1.5	0	9	1	10	10.0	1.4	0
1時間計	41	46	87	52.9	5.9	0	28	2	30	6.7	4.3	1
14:00-14:15	12	7	19	36.8	1.3	0	12	1	13	7.7	1.9	1
14:15-14:30	16	15	31	48.4	2.1	0	12	2	14	14.3	2.0	0
14:30-14:45	6	14	20	70.0	1.4	0	7	1	8	12.5	1.1	0
14:45-15:00	13	8	21	38.1	1.4	0	10	2	12	16.7	1.7	0
1時間計	47	44	91	48.4	6.2	0	41	6	47	12.8	6.7	1

方向別自動車交通量調査表

調査地点：地域社会1 目黒

調査年月日：令和元年 5月14日(火) 天候：雨のち曇り

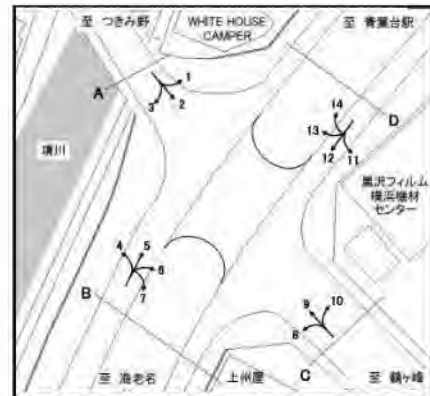

方向 種別 時間帯	11						12					
	小型車 (台)	大型車 (台)	合計 (台)	大型車 混入率 (%)	時間 係数 (%)	二輪車 (台)	小型車 (台)	大型車 (台)	合計 (台)	大型車 混入率 (%)	時間 係数 (%)	二輪車 (台)
15:00-15:15	11	8	19	42.1	1.3	0	8	2	10	20.0	1.4	0
15:15-15:30	11	7	18	38.9	1.2	0	5	1	6	16.7	0.9	0
15:30-15:45	10	3	13	23.1	0.9	0	3	2	5	40.0	0.7	0
15:45-16:00	13	7	20	35.0	1.4	0	6	1	7	14.3	1.0	0
1時間計	45	25	70	35.7	4.7	0	22	6	28	21.4	4.0	0
16:00-16:15	29	17	46	37.0	3.1	2	17	3	20	15.0	2.9	0
16:15-16:30	18	10	28	35.7	1.9	0	12	1	13	7.7	1.9	1
16:30-16:45	11	7	18	38.9	1.2	0	11	0	11	0.0	1.6	0
16:45-17:00	7	10	17	58.8	1.1	0	4	2	6	33.3	0.9	0
1時間計	65	44	109	40.4	7.4	2	44	6	50	12.0	7.2	1
17:00-17:15	17	8	25	32.0	1.7	2	19	0	19	0.0	2.7	3
17:15-17:30	15	9	24	37.5	1.6	1	17	1	18	5.6	2.6	1
17:30-17:45	10	8	18	44.4	1.2	0	6	1	7	14.3	1.0	0
17:45-18:00	14	5	19	26.3	1.3	0	14	0	14	0.0	2.0	2
1時間計	56	30	86	34.9	5.8	3	56	2	58	3.4	8.3	6
18:00-18:15	13	8	21	38.1	1.4	1	14	0	14	0.0	2.0	1
18:15-18:30	19	7	26	26.9	1.8	1	22	1	23	4.3	3.3	0
18:30-18:45	11	5	16	31.3	1.1	0	14	2	16	12.5	2.3	1
18:45-19:00	16	7	23	30.4	1.6	1	11	1	12	8.3	1.7	0
1時間計	59	27	86	31.4	5.8	3	61	4	65	6.2	9.3	2
昼12時間計	651	415	1066	38.9	72.1	11	451	61	512	11.9	73.2	22
19:00-19:15	15	3	18	16.7	1.2	3	19	0	19	0.0	2.7	3
19:15-19:30	17	7	24	29.2	1.6	2	8	0	8	0.0	1.1	1
19:30-19:45	8	4	12	33.3	0.8	1	10	1	11	9.1	1.6	1
19:45-20:00	10	7	17	41.2	1.1	2	11	0	11	0.0	1.6	0
1時間計	50	21	71	29.6	4.8	8	48	1	49	2.0	7.0	5
20:00-20:15	11	2	13	15.4	0.9	0	10	1	11	9.1	1.6	1
20:15-20:30	8	8	16	50.0	1.1	0	9	0	9	0.0	1.3	0
20:30-20:45	22	12	34	35.3	2.3	0	7	0	7	0.0	1.0	0
20:45-21:00	19	11	30	36.7	2.0	1	7	0	7	0.0	1.0	0
1時間計	60	33	93	35.5	6.3	1	33	1	34	2.9	4.9	1
21:00-21:15	3	5	8	62.5	0.5	0	9	0	9	0.0	1.3	0
21:15-21:30	12	4	16	25.0	1.1	0	4	5	9	55.6	1.3	1
21:30-21:45	9	3	12	25.0	0.8	0	2	0	2	0.0	0.3	0
21:45-22:00	5	3	8	37.5	0.5	0	4	0	4	0.0	0.6	0
1時間計	29	15	44	34.1	3.0	0	19	5	24	20.8	3.4	1
22:00-22:15	2	2	4	50.0	0.3	1	2	0	2	0.0	0.3	0
22:15-22:30	2	4	6	66.7	0.4	0	2	0	2	0.0	0.3	0
22:30-22:45	2	1	3	33.3	0.2	0	2	0	2	0.0	0.3	1
22:45-23:00	3	1	4	25.0	0.3	0	7	0	7	0.0	1.0	0
1時間計	9	8	17	47.1	1.1	1	13	0	13	0.0	1.9	1

方向別自動車交通量調査表

調査地点：地域社会1 目黒

調査年月日：令和元年 5月14日(火) 天候：雨のち曇り

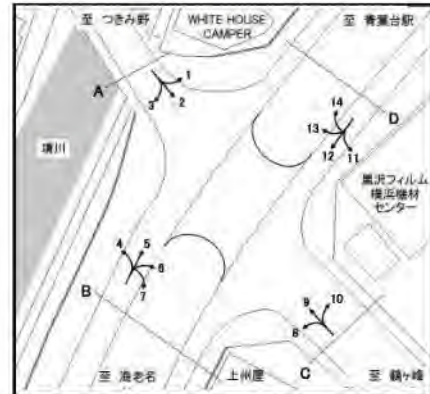

方向 時間帯	11						12					
	種別 小型車 (台)	大型車 (台)	合計 (台)	大型車 混入率 (%)	時係 数 (%)	二輪車 (台)	小型車 (台)	大型車 (台)	合計 (台)	大型車 混入率 (%)	時係 数 (%)	二輪車 (台)
23:00-23:15	5	3	8	37.5	0.5	0	3	0	3	0.0	0.4	0
23:15-23:30	1	2	3	66.7	0.2	0	1	0	1	0.0	0.1	0
23:30-23:45	5	2	7	28.6	0.5	0	1	0	1	0.0	0.1	0
23:45-24:00	1	4	5	80.0	0.3	0	1	0	1	0.0	0.1	0
1時間計	12	11	23	47.8	1.6	0	6	0	6	0.0	0.9	0
0:00-0:15	2	3	5	60.0	0.3	0	0	0	0	0.0	0.0	0
0:15-0:30	4	3	7	42.9	0.5	0	1	0	1	0.0	0.1	0
0:30-0:45	0	2	2	100.0	0.1	0	0	0	0	0.0	0.0	0
0:45-1:00	1	1	2	50.0	0.1	0	0	1	1	100.0	0.1	0
1時間計	7	9	16	56.3	1.1	0	1	1	2	50.0	0.3	0
1:00-1:15	0	2	2	100.0	0.1	1	3	0	3	0.0	0.4	0
1:15-1:30	3	3	6	50.0	0.4	0	1	0	1	0.0	0.1	0
1:30-1:45	2	2	4	50.0	0.3	0	4	0	4	0.0	0.6	0
1:45-2:00	3	2	5	40.0	0.3	0	1	0	1	0.0	0.1	0
1時間計	8	9	17	52.9	1.1	1	9	0	9	0.0	1.3	0
2:00-2:15	3	0	3	0.0	0.2	1	2	0	2	0.0	0.3	0
2:15-2:30	1	1	2	50.0	0.1	0	0	0	0	0.0	0.0	0
2:30-2:45	2	2	4	50.0	0.3	0	0	0	0	0.0	0.0	0
2:45-3:00	1	2	3	66.7	0.2	0	0	0	0	0.0	0.0	0
1時間計	7	5	12	41.7	0.8	1	2	0	2	0.0	0.3	0
3:00-3:15	2	0	2	0.0	0.1	0	1	1	2	50.0	0.3	0
3:15-3:30	2	5	7	71.4	0.5	0	2	0	2	0.0	0.3	0
3:30-3:45	0	0	0	0.0	0.0	2	1	1	2	50.0	0.3	0
3:45-4:00	4	1	5	20.0	0.3	0	0	1	1	100.0	0.1	0
1時間計	8	6	14	42.9	0.9	2	4	3	7	42.9	1.0	0
4:00-4:15	2	1	3	33.3	0.2	0	3	2	5	40.0	0.7	0
4:15-4:30	1	3	4	75.0	0.3	0	2	1	3	33.3	0.4	0
4:30-4:45	4	8	12	66.7	0.8	1	2	1	3	33.3	0.4	0
4:45-5:00	3	10	13	76.9	0.9	1	2	1	3	33.3	0.4	0
1時間計	10	22	32	68.8	2.2	2	9	5	14	35.7	2.0	0
5:00-5:15	4	7	11	63.6	0.7	0	0	0	0	0.0	0.0	0
5:15-5:30	3	3	6	50.0	0.4	0	1	0	1	0.0	0.1	0
5:30-5:45	1	2	3	66.7	0.2	0	1	1	2	50.0	0.3	0
5:45-6:00	2	8	10	80.0	0.7	0	2	0	2	0.0	0.3	0
1時間計	10	20	30	66.7	2.0	0	4	1	5	20.0	0.7	0
6:00-6:15	3	4	7	57.1	0.5	1	0	2	2	100.0	0.3	0
6:15-6:30	1	5	6	83.3	0.4	0	6	1	7	14.3	1.0	0
6:30-6:45	7	9	16	56.3	1.1	1	7	0	7	0.0	1.0	0
6:45-7:00	8	7	15	46.7	1.0	2	4	2	6	33.3	0.9	2
1時間計	19	25	44	56.8	3.0	4	17	5	22	22.7	3.1	2
夜12時間計	229	184	413	44.6	27.9	20	165	22	187	11.8	26.8	10
全時間合計	880	599	1479	40.5	100.0	31	616	83	699	11.9	100.0	32
昼夜率	1.35	1.44	1.39	-	-	2.82	1.37	1.36	1.37	-	-	1.45

方向別自動車交通量調査表

調査地点：地域社会1 目黒

調査年月日：令和元年 5月14日(火) 天候：雨のち曇り

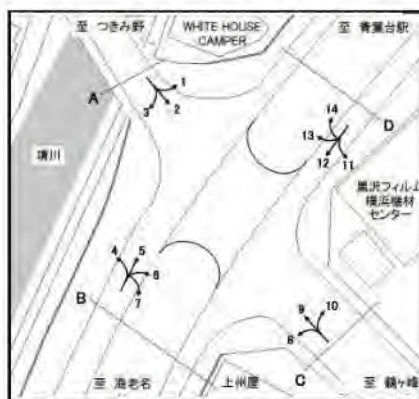

時間帯	種別	13						14					
		小型車 (台)	大型車 (台)	合計 (台)	大型車 混入率 (%)	時 間 係 数 (%)	二輪車 (台)	小型車 (台)	大型車 (台)	合計 (台)	大型車 混入率 (%)	時 間 係 数 (%)	二輪車 (台)
7:00-7:15		37	7	44	15.9	1.3	2	1	1	2	50.0	1.5	0
7:15-7:30		30	8	38	21.1	1.1	3	1	1	2	50.0	1.5	0
7:30-7:45		35	7	42	16.7	1.2	3	1	0	1	0.0	0.8	0
7:45-8:00		39	6	45	13.3	1.3	2	0	1	1	100.0	0.8	0
1時間計		141	28	169	16.6	4.9	10	3	3	6	50.0	4.6	0
8:00-8:15		43	5	48	10.4	1.4	6	0	1	1	100.0	0.8	0
8:15-8:30		39	10	49	20.4	1.4	2	0	1	1	100.0	0.8	0
8:30-8:45		31	9	40	22.5	1.2	1	2	1	3	33.3	2.3	0
8:45-9:00		57	7	64	10.9	1.8	0	1	1	2	50.0	1.5	0
1時間計		170	31	201	15.4	5.8	9	3	4	7	57.1	5.4	0
9:00-9:15		40	8	48	16.7	1.4	2	0	0	0	0.0	0.0	0
9:15-9:30		45	13	58	22.4	1.7	3	1	0	1	0.0	0.8	0
9:30-9:45		45	12	57	21.1	1.6	0	0	0	0	0.0	0.0	0
9:45-10:00		36	16	52	30.8	1.5	0	0	1	1	100.0	0.8	0
1時間計		166	49	215	22.8	6.2	5	1	1	2	50.0	1.5	0
10:00-10:15		41	20	61	32.8	1.8	2	2	1	3	33.3	2.3	0
10:15-10:30		34	9	43	20.9	1.2	2	0	0	0	0.0	0.0	0
10:30-10:45		46	6	52	11.5	1.5	1	1	1	2	50.0	1.5	1
10:45-11:00		26	18	44	40.9	1.3	1	1	0	1	0.0	0.8	0
1時間計		147	53	200	26.5	5.8	6	4	2	6	33.3	4.6	1
11:00-11:15		35	13	48	27.1	1.4	0	3	1	4	25.0	3.1	0
11:15-11:30		31	10	41	24.4	1.2	0	2	1	3	33.3	2.3	0
11:30-11:45		39	8	47	17.0	1.4	0	1	3	4	75.0	3.1	0
11:45-12:00		46	9	55	16.4	1.6	1	2	1	3	33.3	2.3	0
1時間計		151	40	191	20.9	5.5	1	8	6	14	42.9	10.8	0
12:00-12:15		34	10	44	22.7	1.3	1	2	0	2	0.0	1.5	0
12:15-12:30		68	11	79	13.9	2.3	0	1	0	1	0.0	0.8	0
12:30-12:45		42	3	45	6.7	1.3	1	3	1	4	25.0	3.1	0
12:45-13:00		42	8	50	16.0	1.4	1	1	1	2	50.0	1.5	0
1時間計		186	32	218	14.7	6.3	3	7	2	9	22.2	6.9	0
13:00-13:15		33	8	41	19.5	1.2	1	0	1	1	100.0	0.8	0
13:15-13:30		30	4	34	11.8	1.0	2	1	0	1	0.0	0.8	0
13:30-13:45		30	6	36	16.7	1.0	0	1	2	3	66.7	2.3	0
13:45-14:00		30	6	36	16.7	1.0	1	1	2	3	66.7	2.3	0
1時間計		123	24	147	16.3	4.2	4	3	5	8	62.5	6.2	0
14:00-14:15		38	12	50	24.0	1.4	1	2	2	4	50.0	3.1	0
14:15-14:30		38	10	48	20.8	1.4	1	1	2	3	66.7	2.3	0
14:30-14:45		32	15	47	31.9	1.4	0	1	1	2	50.0	1.5	0
14:45-15:00		42	17	59	28.8	1.7	0	2	0	2	0.0	1.5	0
1時間計		150	54	204	26.5	5.9	2	6	5	11	45.5	8.5	0

方向別自動車交通量調査表

調査地点：地域社会1 目黒

調査年月日：令和元年 5月14日(火) 天候：雨のち曇り

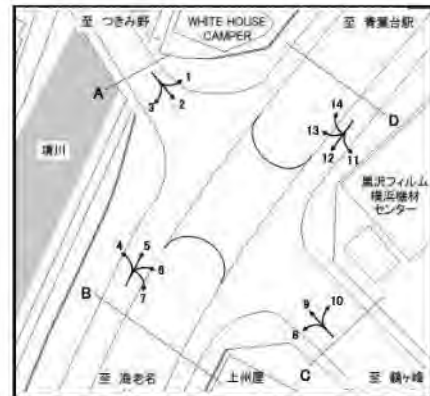

方向 時間帯	13						14					
	小型車 (台)	大型車 (台)	合計 (台)	大型車 混入率 (%)	時間 係数 (%)	二輪車 (台)	小型車 (台)	大型車 (台)	合計 (台)	大型車 混入率 (%)	時間 係数 (%)	二輪車 (台)
15:00-15:15	53	14	67	20.9	1.9	1	4	3	7	42.9	5.4	0
15:15-15:30	37	5	42	11.9	1.2	2	0	0	0	0.0	0.0	0
15:30-15:45	33	7	40	17.5	1.2	4	4	1	5	20.0	3.8	1
15:45-16:00	35	6	41	14.6	1.2	0	2	0	2	0.0	1.5	0
1時間計	158	32	190	16.8	5.5	7	10	4	14	28.6	10.8	1
16:00-16:15	65	17	82	20.7	2.4	1	2	0	2	0.0	1.5	1
16:15-16:30	48	16	64	25.0	1.8	3	1	0	1	0.0	0.8	0
16:30-16:45	38	6	44	13.6	1.3	1	0	1	1	100.0	0.8	0
16:45-17:00	45	7	52	13.5	1.5	4	1	1	2	50.0	1.5	0
1時間計	196	46	242	19.0	7.0	9	4	2	6	33.3	4.6	1
17:00-17:15	64	14	78	17.9	2.3	2	2	1	3	33.3	2.3	0
17:15-17:30	47	3	50	6.0	1.4	3	1	0	1	0.0	0.8	0
17:30-17:45	42	2	44	4.5	1.3	3	1	1	2	50.0	1.5	0
17:45-18:00	58	2	60	3.3	1.7	2	0	0	0	0.0	0.0	0
1時間計	211	21	232	9.1	6.7	10	4	2	6	33.3	4.6	0
18:00-18:15	56	8	64	12.5	1.8	6	0	0	0	0.0	0.0	0
18:15-18:30	64	2	66	3.0	1.9	1	1	1	2	50.0	1.5	0
18:30-18:45	51	4	55	7.3	1.6	5	1	0	1	0.0	0.8	0
18:45-19:00	53	5	58	8.6	1.7	4	3	1	4	25.0	3.1	0
1時間計	224	19	243	7.8	7.0	16	5	2	7	28.6	5.4	0
昼12時間計	2023	429	2452	17.5	70.9	82	58	38	96	39.6	73.8	3
19:00-19:15	66	3	69	4.3	2.0	6	2	0	2	0.0	1.5	0
19:15-19:30	46	0	46	0.0	1.3	2	1	0	1	0.0	0.8	0
19:30-19:45	36	1	37	2.7	1.1	2	0	0	0	0.0	0.0	0
19:45-20:00	26	2	28	7.1	0.8	3	3	0	3	0.0	2.3	0
1時間計	174	6	180	3.3	5.2	13	6	0	6	0.0	4.6	0
20:00-20:15	29	2	31	6.5	0.9	3	0	0	0	0.0	0.0	0
20:15-20:30	37	1	38	2.6	1.1	2	0	0	0	0.0	0.0	0
20:30-20:45	32	1	33	3.0	1.0	2	2	0	2	0.0	1.5	0
20:45-21:00	49	6	55	10.9	1.6	0	0	0	0	0.0	0.0	0
1時間計	147	10	157	6.4	4.5	7	2	0	2	0.0	1.5	0
21:00-21:15	24	4	28	14.3	0.8	2	0	0	0	0.0	0.0	0
21:15-21:30	29	3	32	9.4	0.9	0	2	0	2	0.0	1.5	0
21:30-21:45	20	1	21	4.8	0.6	3	0	0	0	0.0	0.0	0
21:45-22:00	22	4	26	15.4	0.8	1	0	0	0	0.0	0.0	0
1時間計	95	12	107	11.2	3.1	6	2	0	2	0.0	1.5	0
22:00-22:15	30	2	32	6.3	0.9	0	2	0	2	0.0	1.5	0
22:15-22:30	20	2	22	9.1	0.6	2	2	0	2	0.0	1.5	0
22:30-22:45	22	4	26	15.4	0.8	1	0	0	0	0.0	0.0	0
22:45-23:00	10	0	10	0.0	0.3	1	1	0	1	0.0	0.8	0
1時間計	82	8	90	8.9	2.6	4	5	0	5	0.0	3.8	0

方向別自動車交通量調査表

調査地点：地域社会1 目黒

調査年月日：令和元年 5月14日(火) 天候：雨のち曇り

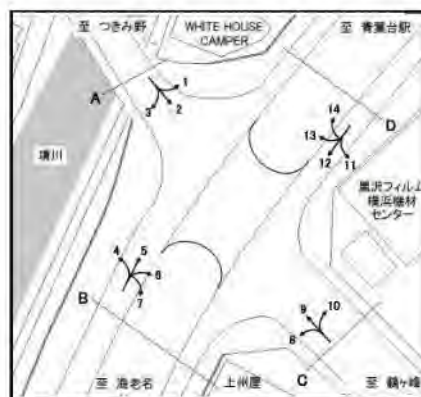

方向	13						14						
	種別	小型車 (台)	大型車 (台)	合計 (台)	大型車 混入率 (%)	時間 係数 (%)	二輪車 (台)	小型車 (台)	大型車 (台)	合計 (台)	大型車 混入率 (%)	時間 係数 (%)	二輪車 (台)
23:00-23:15		13	4	17	23.5	0.5	0	0	0	0	0.0	0.0	0
23:15-23:30		17	3	20	15.0	0.6	2	0	0	0	0.0	0.0	0
23:30-23:45		14	1	15	6.7	0.4	2	0	0	0	0.0	0.0	0
23:45-24:00		11	3	14	21.4	0.4	1	0	0	0	0.0	0.0	0
1時間計		55	11	66	16.7	1.9	5	0	0	0	0.0	0.0	0
0:00-0:15		8	0	8	0.0	0.2	1	0	0	0	0.0	0.0	0
0:15-0:30		4	0	4	0.0	0.1	1	0	0	0	0.0	0.0	0
0:30-0:45		9	3	12	25.0	0.3	0	0	0	0	0.0	0.0	0
0:45-1:00		3	1	4	25.0	0.1	1	0	0	0	0.0	0.0	2
1時間計		24	4	28	14.3	0.8	3	0	0	0	0.0	0.0	2
1:00-1:15		7	2	9	22.2	0.3	0	0	0	0	0.0	0.0	0
1:15-1:30		6	1	7	14.3	0.2	0	2	0	2	0.0	1.5	0
1:30-1:45		6	1	7	14.3	0.2	0	0	0	0	0.0	0.0	0
1:45-2:00		1	0	1	0.0	0.0	0	0	1	1	100.0	0.8	0
1時間計		20	4	24	16.7	0.7	0	2	1	3	33.3	2.3	0
2:00-2:15		5	3	8	37.5	0.2	1	0	0	0	0.0	0.0	0
2:15-2:30		5	7	12	58.3	0.3	0	0	0	0	0.0	0.0	0
2:30-2:45		1	5	6	83.3	0.2	0	0	0	0	0.0	0.0	0
2:45-3:00		6	5	11	45.5	0.3	0	0	1	1	100.0	0.8	0
1時間計		17	20	37	54.1	1.1	1	0	1	1	100.0	0.8	0
3:00-3:15		4	9	13	69.2	0.4	0	1	0	1	0.0	0.8	0
3:15-3:30		6	4	10	40.0	0.3	0	0	0	0	0.0	0.0	0
3:30-3:45		3	1	4	25.0	0.1	0	0	0	0	0.0	0.0	0
3:45-4:00		3	4	7	57.1	0.2	0	0	0	0	0.0	0.0	0
1時間計		16	18	34	52.9	1.0	0	1	0	1	0.0	0.8	0
4:00-4:15		10	4	14	28.6	0.4	0	0	0	0	0.0	0.0	0
4:15-4:30		6	5	11	45.5	0.3	0	0	1	1	100.0	0.8	0
4:30-4:45		12	9	21	42.9	0.6	1	0	1	1	100.0	0.8	0
4:45-5:00		15	16	31	51.6	0.9	2	1	1	2	50.0	1.5	0
1時間計		43	34	77	44.2	2.2	3	1	3	4	75.0	3.1	0
5:00-5:15		5	3	8	37.5	0.2	1	0	1	1	100.0	0.8	0
5:15-5:30		8	4	12	33.3	0.3	1	0	1	1	100.0	0.8	0
5:30-5:45		7	9	16	56.3	0.5	1	1	1	2	50.0	1.5	0
5:45-6:00		8	8	16	50.0	0.5	0	1	3	4	75.0	3.1	0
1時間計		28	24	52	46.2	1.5	3	2	6	8	75.0	6.2	0
6:00-6:15		8	11	19	57.9	0.5	0	0	0	0	0.0	0.0	0
6:15-6:30		30	10	40	25.0	1.2	3	0	2	2	100.0	1.5	0
6:30-6:45		42	10	52	19.2	1.5	4	0	0	0	0.0	0.0	0
6:45-7:00		35	10	45	22.2	1.3	4	0	0	0	0.0	0.0	0
1時間計		115	41	156	26.3	4.5	11	0	2	2	100.0	1.5	0
夜12時間計		816	192	1008	19.0	29.1	56	21	13	34	38.2	26.2	2
全時間合計		2839	621	3460	17.9	100.0	138	79	51	130	39.2	100.0	5
昼夜率		1.40	1.45	1.41	-	-	1.68	1.36	1.34	1.35	-	-	1.67

方向別自動車交通量調査表

調査地点：地域社会1 目黒

調査年月日：令和元年 5月14日(火) 天候：雨のち曇り

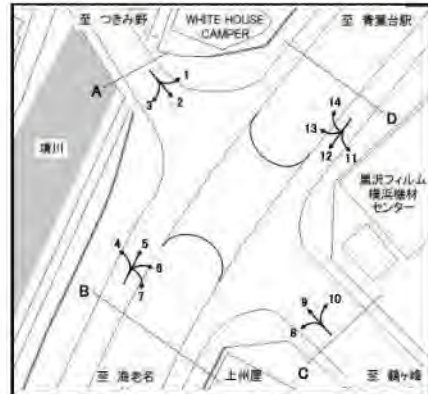

方向 時間帯	種別						D 合計 (11+12+13+14)					
		小型車 (台)	大型車 (台)	合計 (台)	大型車 混入率 (%)	時間 係数 (%)	二輪車 (台)	小型車 (台)	大型車 (台)	合計 (台)	大型車 混入率 (%)	時間 係数 (%)
7:00-7:15							57	12	69	17.4	1.2	3
7:15-7:30							52	18	70	25.7	1.2	3
7:30-7:45							59	13	72	18.1	1.2	5
7:45-8:00							54	17	71	23.9	1.2	3
1時間計							222	60	282	21.3	4.9	14
8:00-8:15							71	12	83	14.5	1.4	7
8:15-8:30							59	21	80	26.3	1.4	3
8:30-8:45							53	17	70	24.3	1.2	1
8:45-9:00							89	23	112	20.5	1.9	1
1時間計							272	73	345	21.2	6.0	12
9:00-9:15							69	18	87	20.7	1.5	3
9:15-9:30							76	21	97	21.6	1.7	3
9:30-9:45							71	27	98	27.6	1.7	1
9:45-10:00							58	33	91	36.3	1.6	0
1時間計							274	99	373	26.5	6.5	7
10:00-10:15							73	32	105	30.5	1.8	3
10:15-10:30							55	15	70	21.4	1.2	2
10:30-10:45							62	11	73	15.1	1.3	2
10:45-11:00							43	24	67	35.8	1.2	2
1時間計							233	82	315	26.0	5.5	9
11:00-11:15							68	26	94	27.7	1.6	0
11:15-11:30							57	21	78	26.9	1.4	0
11:30-11:45							66	31	97	32.0	1.7	0
11:45-12:00							63	20	83	24.1	1.4	1
1時間計							254	98	352	27.8	6.1	1
12:00-12:15							53	14	67	20.9	1.2	2
12:15-12:30							88	27	115	23.5	2.0	2
12:30-12:45							70	13	83	15.7	1.4	1
12:45-13:00							58	19	77	24.7	1.3	1
1時間計							269	73	342	21.3	5.9	6
13:00-13:15							50	17	67	25.4	1.2	2
13:15-13:30							48	16	64	25.0	1.1	2
13:30-13:45							49	21	70	30.0	1.2	0
13:45-14:00							48	23	71	32.4	1.2	1
1時間計							195	77	272	28.3	4.7	5
14:00-14:15							64	22	86	25.6	1.5	2
14:15-14:30							67	29	96	30.2	1.7	1
14:30-14:45							46	31	77	40.3	1.3	0
14:45-15:00							67	27	94	28.7	1.6	0
1時間計							244	109	353	30.9	6.1	3

方向別自動車交通量調査表

調査地点：地域社会1 目黒

調査年月日：令和元年 5月14日(火) 天候：雨のち曇り

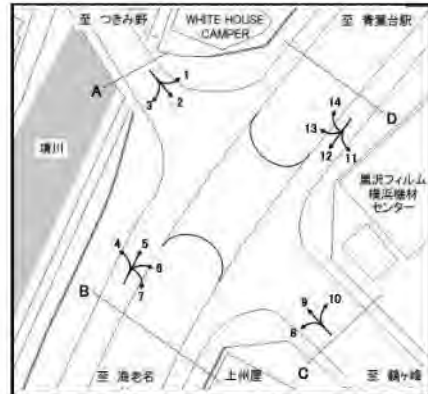

方向							D 合計 (11+12+13+14)					
	種別	小型車 (台)	大型車 (台)	合計 (台)	大型車 混入率 (%)	時間 係数 (%)	二輪車 (台)	小型車 (台)	大型車 (台)	合計 (台)	大型車 混入率 (%)	時間 係数 (%)
15:00-15:15							76	27	103	26.2	1.8	1
15:15-15:30							53	13	66	19.7	1.1	2
15:30-15:45							50	13	63	20.6	1.1	5
15:45-16:00							56	14	70	20.0	1.2	0
1時間計							235	67	302	22.2	5.2	8
16:00-16:15							113	37	150	24.7	2.6	4
16:15-16:30							79	27	106	25.5	1.8	4
16:30-16:45							60	14	74	18.9	1.3	1
16:45-17:00							57	20	77	26.0	1.3	4
1時間計							309	98	407	24.1	7.1	13
17:00-17:15							102	23	125	18.4	2.2	7
17:15-17:30							80	13	93	14.0	1.6	5
17:30-17:45							59	12	71	16.9	1.2	3
17:45-18:00							86	7	93	7.5	1.6	4
1時間計							327	55	382	14.4	6.6	19
18:00-18:15							83	16	99	16.2	1.7	8
18:15-18:30							106	11	117	9.4	2.0	2
18:30-18:45							77	11	88	12.5	1.5	6
18:45-19:00							83	14	97	14.4	1.7	5
1時間計							349	52	401	13.0	7.0	21
昼12時間計							3183	943	4126	22.9	71.5	118
19:00-19:15							102	6	108	5.6	1.9	12
19:15-19:30							72	7	79	8.9	1.4	5
19:30-19:45							54	6	60	10.0	1.0	4
19:45-20:00							50	9	59	15.3	1.0	5
1時間計							278	28	306	9.2	5.3	26
20:00-20:15							50	5	55	9.1	1.0	4
20:15-20:30							54	9	63	14.3	1.1	2
20:30-20:45							63	13	76	17.1	1.3	2
20:45-21:00							75	17	92	18.5	1.6	1
1時間計							242	44	286	15.4	5.0	9
21:00-21:15							36	9	45	20.0	0.8	2
21:15-21:30							47	12	59	20.3	1.0	1
21:30-21:45							31	4	35	11.4	0.6	3
21:45-22:00							31	7	38	18.4	0.7	1
1時間計							145	32	177	18.1	3.1	7
22:00-22:15							36	4	40	10.0	0.7	1
22:15-22:30							26	6	32	18.8	0.6	2
22:30-22:45							26	5	31	16.1	0.5	2
22:45-23:00							21	1	22	4.5	0.4	1
1時間計							109	16	125	12.8	2.2	6

方向別自動車交通量調査表

調査地点：地域社会1 目黒

調査年月日：令和元年 5月14日(火) 天候：雨のち曇り

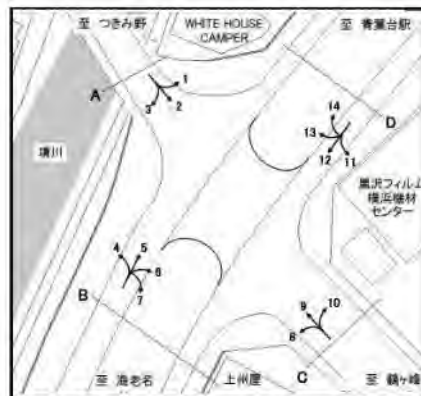

方向 時間帯	種別							D 合計 (11+12+13+14)					
		小型車 (台)	大型車 (台)	合計 (台)	大型車 混入率 (%)	時間 係数 (%)	二輪車 (台)	小型車 (台)	大型車 (台)	合計 (台)	大型車 混入率 (%)	時間 係数 (%)	二輪車 (台)
23:00-23:15							21	7	28	25.0	0.5	0	
23:15-23:30							19	5	24	20.8	0.4	2	
23:30-23:45							20	3	23	13.0	0.4	2	
23:45-24:00							13	7	20	35.0	0.3	1	
1 時間計							73	22	95	23.2	1.6	5	
0:00- 0:15							10	3	13	23.1	0.2	1	
0:15- 0:30							9	3	12	25.0	0.2	1	
0:30- 0:45							9	5	14	35.7	0.2	0	
0:45- 1:00							4	3	7	42.9	0.1	3	
1 時間計							32	14	46	30.4	0.8	5	
1:00- 1:15							10	4	14	28.6	0.2	1	
1:15- 1:30							12	4	16	25.0	0.3	0	
1:30- 1:45							12	3	15	20.0	0.3	0	
1:45- 2:00							5	3	8	37.5	0.1	0	
1 時間計							39	14	53	26.4	0.9	1	
2:00- 2:15							10	3	13	23.1	0.2	2	
2:15- 2:30							6	8	14	57.1	0.2	0	
2:30- 2:45							3	7	10	70.0	0.2	0	
2:45- 3:00							7	8	15	53.3	0.3	0	
1 時間計							26	26	52	50.0	0.9	2	
3:00- 3:15							8	10	18	55.6	0.3	0	
3:15- 3:30							10	9	19	47.4	0.3	0	
3:30- 3:45							4	2	6	33.3	0.1	2	
3:45- 4:00							7	6	13	46.2	0.2	0	
1 時間計							29	27	56	48.2	1.0	2	
4:00- 4:15							15	7	22	31.8	0.4	0	
4:15- 4:30							9	10	19	52.6	0.3	0	
4:30- 4:45							18	19	37	51.4	0.6	2	
4:45- 5:00							21	28	49	57.1	0.8	3	
1 時間計							63	64	127	50.4	2.2	5	
5:00- 5:15							9	11	20	55.0	0.3	1	
5:15- 5:30							12	8	20	40.0	0.3	1	
5:30- 5:45							10	13	23	56.5	0.4	1	
5:45- 6:00							13	19	32	59.4	0.6	0	
1 時間計							44	51	95	53.7	1.6	3	
6:00- 6:15							11	17	28	60.7	0.5	1	
6:15- 6:30							37	18	55	32.7	1.0	3	
6:30- 6:45							56	19	75	25.3	1.3	5	
6:45- 7:00							47	19	66	28.8	1.1	8	
1 時間計							151	73	224	32.6	3.9	17	
夜12時間計							1231	411	1642	25.0	28.5	88	
全時間合計							4414	1354	5768	23.5	100.0	206	
昼夜率							1.39	1.44	1.40	-	-	1.75	

方向別自動車交通量調査表

調査地点：地域社会2 目黒交番前

調査年月日：令和元年 5月14日(火) 天候：雨のち曇り

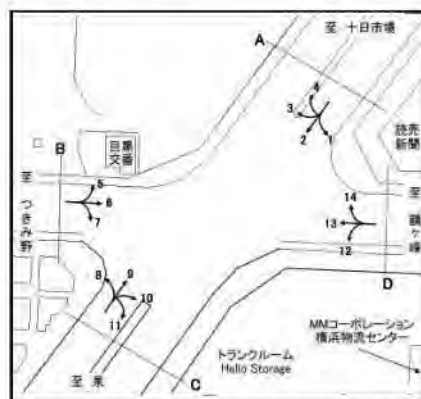

方向	1						2							
	種別	小型車 (台)	大型車 (台)	合計 (台)	大型車 混入率 (%)	時間 係数 (%)	二輪車 (台)	種別	小型車 (台)	大型車 (台)	合計 (台)	大型車 混入率 (%)	時間 係数 (%)	二輪車 (台)
7:00-7:15		0	1	1	100.0	0.9	0		62	6	68	8.8	1.6	4
7:15-7:30		1	1	2	50.0	1.9	0		61	7	68	10.3	1.6	9
7:30-7:45		0	2	2	100.0	1.9	0		87	8	95	8.4	2.2	4
7:45-8:00		1	1	2	50.0	1.9	0		58	9	67	13.4	1.6	2
1時間計		2	5	7	71.4	6.5	0		268	30	298	10.1	7.0	19
8:00-8:15		1	1	2	50.0	1.9	0		71	6	77	7.8	1.8	2
8:15-8:30		1	1	2	50.0	1.9	0		46	8	54	14.8	1.3	2
8:30-8:45		2	0	2	0.0	1.9	0		63	5	68	7.4	1.6	2
8:45-9:00		1	1	2	50.0	1.9	0		56	6	62	9.7	1.4	0
1時間計		5	3	8	37.5	7.4	0		236	25	261	9.6	6.1	6
9:00-9:15		3	0	3	0.0	2.8	0		55	8	63	12.7	1.5	1
9:15-9:30		0	1	1	100.0	0.9	0		45	8	53	15.1	1.2	1
9:30-9:45		0	2	2	100.0	1.9	0		46	13	59	22.0	1.4	0
9:45-10:00		1	3	4	75.0	3.7	0		65	11	76	14.5	1.8	3
1時間計		4	6	10	60.0	9.3	0		211	40	251	15.9	5.9	5
10:00-10:15		1	1	2	50.0	1.9	0		48	8	56	14.3	1.3	1
10:15-10:30		1	1	2	50.0	1.9	0		48	10	58	17.2	1.4	1
10:30-10:45		2	2	4	50.0	3.7	0		37	12	49	24.5	1.1	1
10:45-11:00		0	1	1	100.0	0.9	0		50	8	58	13.8	1.4	2
1時間計		4	5	9	55.6	8.3	0		183	38	221	17.2	5.2	5
11:00-11:15		0	0	0	0.0	0.0	0		34	14	48	29.2	1.1	1
11:15-11:30		0	0	0	0.0	0.0	0		51	6	57	10.5	1.3	2
11:30-11:45		1	1	2	50.0	1.9	0		55	12	67	17.9	1.6	0
11:45-12:00		0	1	1	100.0	0.9	0		39	6	45	13.3	1.1	2
1時間計		1	2	3	66.7	2.8	0		179	38	217	17.5	5.1	5
12:00-12:15		1	1	2	50.0	1.9	0		48	11	59	18.6	1.4	1
12:15-12:30		0	1	1	100.0	0.9	0		47	11	58	19.0	1.4	1
12:30-12:45		2	1	3	33.3	2.8	0		43	11	54	20.4	1.3	1
12:45-13:00		0	2	2	100.0	1.9	0		51	13	64	20.3	1.5	1
1時間計		3	5	8	62.5	7.4	0		189	46	235	19.6	5.5	4
13:00-13:15		1	2	3	66.7	2.8	0		42	10	52	19.2	1.2	0
13:15-13:30		1	1	2	50.0	1.9	0		39	6	45	13.3	1.1	1
13:30-13:45		1	1	2	50.0	1.9	0		46	13	59	22.0	1.4	0
13:45-14:00		2	1	3	33.3	2.8	0		51	11	62	17.7	1.4	0
1時間計		5	5	10	50.0	9.3	0		178	40	218	18.3	5.1	1
14:00-14:15		2	1	3	33.3	2.8	0		59	6	65	9.2	1.5	1
14:15-14:30		1	0	1	0.0	0.9	0		43	10	53	18.9	1.2	4
14:30-14:45		1	0	1	0.0	0.9	0		50	11	61	18.0	1.4	0
14:45-15:00		1	0	1	0.0	0.9	0		39	6	45	13.3	1.1	1
1時間計		5	1	6	16.7	5.6	0		191	33	224	14.7	5.2	6

方向別自動車交通量調査表

調査地点：地域社会2 目黒交番前

調査年月日：令和元年 5月14日(火) 天候：雨のち曇り

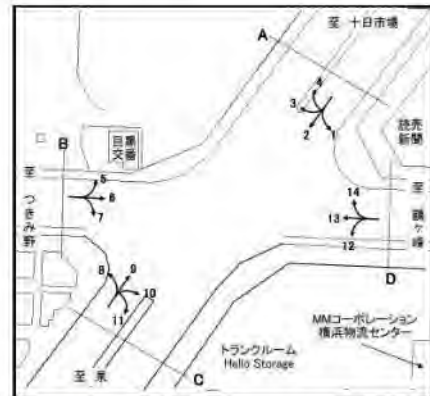

方向 種別 時間帯	1						2					
	小型車 (台)	大型車 (台)	合計 (台)	大型車 混入率 (%)	時間 係数 (%)	二輪車 (台)	小型車 (台)	大型車 (台)	合計 (台)	大型車 混入率 (%)	時間 係数 (%)	二輪車 (台)
15:00-15:15	0	0	0	0.0	0.0	0	76	7	83	8.4	1.9	2
15:15-15:30	0	0	0	0.0	0.0	0	47	15	62	24.2	1.4	0
15:30-15:45	3	0	3	0.0	2.8	0	64	7	71	9.9	1.7	1
15:45-16:00	0	0	0	0.0	0.0	1	48	9	57	15.8	1.3	2
1時間計	3	0	3	0.0	2.8	1	235	38	273	13.9	6.4	5
16:00-16:15	1	0	1	0.0	0.9	0	86	10	96	10.4	2.2	3
16:15-16:30	1	1	2	50.0	1.9	0	92	11	103	10.7	2.4	6
16:30-16:45	0	1	1	100.0	0.9	0	47	5	52	9.6	1.2	1
16:45-17:00	1	2	3	66.7	2.8	0	60	11	71	15.5	1.7	2
1時間計	3	4	7	57.1	6.5	0	285	37	322	11.5	7.5	12
17:00-17:15	2	0	2	0.0	1.9	0	61	5	66	7.6	1.5	0
17:15-17:30	0	0	0	0.0	0.0	0	78	3	81	3.7	1.9	1
17:30-17:45	2	0	2	0.0	1.9	0	79	4	83	4.8	1.9	4
17:45-18:00	0	0	0	0.0	0.0	0	73	5	78	6.4	1.8	5
1時間計	4	0	4	0.0	3.7	0	291	17	308	5.5	7.2	10
18:00-18:15	0	0	0	0.0	0.0	0	66	4	70	5.7	1.6	4
18:15-18:30	2	0	2	0.0	1.9	0	77	3	80	3.8	1.9	7
18:30-18:45	0	0	0	0.0	0.0	0	93	5	98	5.1	2.3	2
18:45-19:00	0	0	0	0.0	0.0	0	67	2	69	2.9	1.6	4
1時間計	2	0	2	0.0	1.9	0	303	14	317	4.4	7.4	17
昼12時間計	41	36	77	46.8	71.3	1	2749	396	3145	12.6	73.4	95
19:00-19:15	1	1	2	50.0	1.9	0	65	3	68	4.4	1.6	3
19:15-19:30	2	1	3	33.3	2.8	0	67	3	70	4.3	1.6	4
19:30-19:45	0	0	0	0.0	0.0	0	71	1	72	1.4	1.7	2
19:45-20:00	0	0	0	0.0	0.0	0	64	0	64	0.0	1.5	6
1時間計	3	2	5	40.0	4.6	0	267	7	274	2.6	6.4	15
20:00-20:15	0	0	0	0.0	0.0	0	53	0	53	0.0	1.2	1
20:15-20:30	2	0	2	0.0	1.9	0	48	3	51	5.9	1.2	0
20:30-20:45	1	0	1	0.0	0.9	0	52	0	52	0.0	1.2	3
20:45-21:00	1	0	1	0.0	0.9	0	45	0	45	0.0	1.1	3
1時間計	4	0	4	0.0	3.7	0	198	3	201	1.5	4.7	7
21:00-21:15	0	0	0	0.0	0.0	0	48	1	49	2.0	1.1	3
21:15-21:30	0	0	0	0.0	0.0	0	36	0	36	0.0	0.8	1
21:30-21:45	0	0	0	0.0	0.0	0	23	1	24	4.2	0.6	1
21:45-22:00	1	0	1	0.0	0.9	0	35	2	37	5.4	0.9	5
1時間計	1	0	1	0.0	0.9	0	142	4	146	2.7	3.4	10
22:00-22:15	0	0	0	0.0	0.0	0	24	1	25	4.0	0.6	1
22:15-22:30	0	0	0	0.0	0.0	0	19	1	20	5.0	0.5	1
22:30-22:45	1	0	1	0.0	0.9	0	19	0	19	0.0	0.4	2
22:45-23:00	0	0	0	0.0	0.0	0	13	0	13	0.0	0.3	0
1時間計	1	0	1	0.0	0.9	0	75	2	77	2.6	1.8	4

方向別自動車交通量調査表

調査地点：地域社会2 目黒交番前

調査年月日：令和元年 5月14日(火) 天候：雨のち曇り

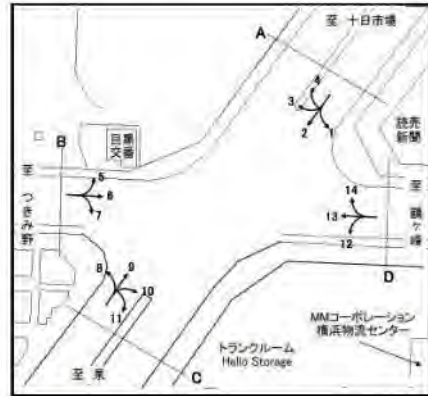

方向 時間帯	1						2					
	種別 小型車 (台)	大型車 (台)	合計 (台)	大型車 混入率 (%)	時間 係数 (%)	二輪車 (台)	小型車 (台)	大型車 (台)	合計 (台)	大型車 混入率 (%)	時間 係数 (%)	二輪車 (台)
23:00-23:15	0	0	0	0.0	0.0	0	14	2	16	12.5	0.4	1
23:15-23:30	0	0	0	0.0	0.0	0	17	0	17	0.0	0.4	0
23:30-23:45	0	0	0	0.0	0.0	0	11	0	11	0.0	0.3	1
23:45-24:00	0	0	0	0.0	0.0	0	9	0	9	0.0	0.2	0
1時間計	0	0	0	0.0	0.0	0	51	2	53	3.8	1.2	2
0:00-0:15	0	1	1	100.0	0.9	0	13	0	13	0.0	0.3	1
0:15-0:30	0	1	1	100.0	0.9	0	8	0	8	0.0	0.2	1
0:30-0:45	0	0	0	0.0	0.0	0	11	0	11	0.0	0.3	0
0:45-1:00	0	0	0	0.0	0.0	0	4	2	6	33.3	0.1	0
1時間計	0	2	2	100.0	1.9	0	36	2	38	5.3	0.9	2
1:00-1:15	0	0	0	0.0	0.0	0	2	1	3	33.3	0.1	0
1:15-1:30	0	0	0	0.0	0.0	0	5	2	7	28.6	0.2	0
1:30-1:45	0	0	0	0.0	0.0	0	3	1	4	25.0	0.1	0
1:45-2:00	0	1	1	100.0	0.9	0	3	3	6	50.0	0.1	0
1時間計	0	1	1	100.0	0.9	0	13	7	20	35.0	0.5	0
2:00-2:15	1	3	4	75.0	3.7	0	2	1	3	33.3	0.1	0
2:15-2:30	0	2	2	100.0	1.9	0	3	0	3	0.0	0.1	0
2:30-2:45	0	0	0	0.0	0.0	0	4	1	5	20.0	0.1	0
2:45-3:00	0	2	2	100.0	1.9	0	3	1	4	25.0	0.1	1
1時間計	1	7	8	87.5	7.4	0	12	3	15	20.0	0.4	1
3:00-3:15	0	2	2	100.0	1.9	0	4	1	5	20.0	0.1	0
3:15-3:30	0	0	0	0.0	0.0	0	3	3	6	50.0	0.1	0
3:30-3:45	0	1	1	100.0	0.9	0	2	1	3	33.3	0.1	1
3:45-4:00	0	1	1	100.0	0.9	0	6	1	7	14.3	0.2	3
1時間計	0	4	4	100.0	3.7	0	15	6	21	28.6	0.5	4
4:00-4:15	0	0	0	0.0	0.0	0	4	0	4	0.0	0.1	1
4:15-4:30	0	0	0	0.0	0.0	0	10	0	10	0.0	0.2	1
4:30-4:45	0	0	0	0.0	0.0	1	10	2	12	16.7	0.3	1
4:45-5:00	0	0	0	0.0	0.0	0	11	3	14	21.4	0.3	0
1時間計	0	0	0	0.0	0.0	1	35	5	40	12.5	0.9	3
5:00-5:15	1	0	1	0.0	0.9	0	8	3	11	27.3	0.3	0
5:15-5:30	0	0	0	0.0	0.0	0	14	1	15	6.7	0.4	0
5:30-5:45	1	0	1	0.0	0.9	0	19	0	19	0.0	0.4	2
5:45-6:00	0	0	0	0.0	0.0	0	27	3	30	10.0	0.7	0
1時間計	2	0	2	0.0	1.9	0	68	7	75	9.3	1.8	2
6:00-6:15	0	0	0	0.0	0.0	3	18	3	21	14.3	0.5	2
6:15-6:30	0	2	2	100.0	1.9	0	48	9	57	15.8	1.3	2
6:30-6:45	0	1	1	100.0	0.9	0	35	3	38	7.9	0.9	5
6:45-7:00	0	0	0	0.0	0.0	0	57	4	61	6.6	1.4	2
1時間計	0	3	3	100.0	2.8	3	158	19	177	10.7	4.1	11
夜12時間計	12	19	31	61.3	28.7	4	1070	67	1137	5.9	26.6	61
全時間合計	53	55	108	50.9	100.0	5	3819	463	4282	10.8	100.0	156
昼夜率	1.29	1.53	1.40	-	-	5.00	1.39	1.17	1.36	-	-	1.64

方向別自動車交通量調査表

調査地点：地域社会2 目黒交番前

調査年月日：令和元年 5月14日(火) 天候：雨のち曇り

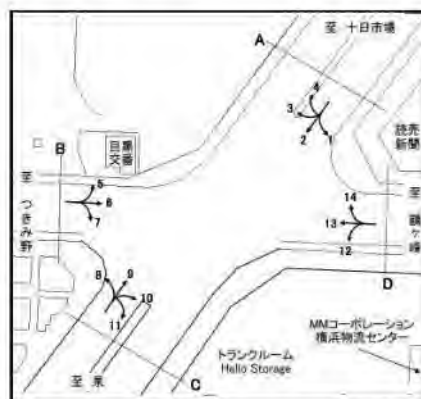

方向	3						4						
	種別	小型車 (台)	大型車 (台)	合計 (台)	大型車 混入率 (%)	時 間 係 数 (%)	二輪車 (台)	小型車 (台)	大型車 (台)	合計 (台)	大型車 混入率 (%)	時 間 係 数 (%)	二輪車 (台)
7:00-7:15		34	6	40	15.0	1.6	2	0	0	0	0.0	0.0	0
7:15-7:30		38	2	40	5.0	1.6	0	0	0	0	0.0	0.0	0
7:30-7:45		36	11	47	23.4	1.9	5	0	0	0	0.0	0.0	0
7:45-8:00		35	6	41	14.6	1.7	4	0	0	0	0.0	0.0	0
1時間計		143	25	168	14.9	6.8	11	0	0	0	0.0	0.0	0
8:00-8:15		43	5	48	10.4	1.9	2	0	0	0	0.0	0.0	0
8:15-8:30		28	7	35	20.0	1.4	3	0	0	0	0.0	0.0	0
8:30-8:45		36	7	43	16.3	1.7	2	0	0	0	0.0	0.0	0
8:45-9:00		31	8	39	20.5	1.6	3	0	0	0	0.0	0.0	0
1時間計		138	27	165	16.4	6.7	10	0	0	0	0.0	0.0	0
9:00-9:15		33	5	38	13.2	1.5	1	0	0	0	0.0	0.0	0
9:15-9:30		25	10	35	28.6	1.4	1	0	0	0	0.0	0.0	0
9:30-9:45		27	11	38	28.9	1.5	0	0	0	0	0.0	0.0	0
9:45-10:00		37	12	49	24.5	2.0	0	0	0	0	0.0	0.0	0
1時間計		122	38	160	23.8	6.5	2	0	0	0	0.0	0.0	0
10:00-10:15		20	12	32	37.5	1.3	2	0	0	0	0.0	0.0	0
10:15-10:30		26	9	35	25.7	1.4	1	0	0	0	0.0	0.0	0
10:30-10:45		30	6	36	16.7	1.5	0	0	0	0	0.0	0.0	0
10:45-11:00		28	11	39	28.2	1.6	1	0	0	0	0.0	0.0	0
1時間計		104	38	142	26.8	5.8	4	0	0	0	0.0	0.0	0
11:00-11:15		25	10	35	28.6	1.4	0	0	0	0	0.0	0.0	0
11:15-11:30		33	5	38	13.2	1.5	0	0	0	0	0.0	0.0	0
11:30-11:45		31	14	45	31.1	1.8	0	1	0	1	0.0	14.3	0
11:45-12:00		29	9	38	23.7	1.5	0	0	0	0	0.0	0.0	0
1時間計		118	38	156	24.4	6.3	0	1	0	1	0.0	14.3	0
12:00-12:15		29	6	35	17.1	1.4	0	0	0	0	0.0	0.0	0
12:15-12:30		20	3	23	13.0	0.9	0	0	0	0	0.0	0.0	0
12:30-12:45		22	10	32	31.3	1.3	0	2	0	2	0.0	28.6	0
12:45-13:00		30	8	38	21.1	1.5	2	0	0	0	0.0	0.0	0
1時間計		101	27	128	21.1	5.2	2	2	0	2	0.0	28.6	0
13:00-13:15		31	5	36	13.9	1.5	0	1	0	1	0.0	14.3	0
13:15-13:30		27	15	42	35.7	1.7	0	1	0	1	0.0	14.3	0
13:30-13:45		24	9	33	27.3	1.3	0	0	0	0	0.0	0.0	0
13:45-14:00		26	13	39	33.3	1.6	1	0	0	0	0.0	0.0	0
1時間計		108	42	150	28.0	6.1	1	2	0	2	0.0	28.6	0
14:00-14:15		35	6	41	14.6	1.7	1	0	0	0	0.0	0.0	0
14:15-14:30		25	8	33	24.2	1.3	0	0	0	0	0.0	0.0	0
14:30-14:45		27	5	32	15.6	1.3	0	1	0	1	0.0	14.3	0
14:45-15:00		26	7	33	21.2	1.3	0	0	0	0	0.0	0.0	0
1時間計		113	26	139	18.7	5.6	1	1	0	1	0.0	14.3	0

方向別自動車交通量調査表

調査地点：地域社会2 目黒交番前

調査年月日：令和元年 5月14日(火) 天候：雨のち曇り

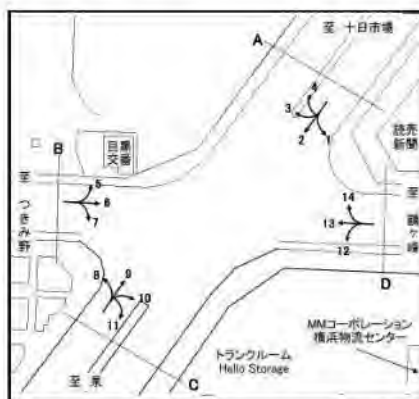

方向 時間帯	3						4					
	種別 小型車 (台)	大型車 (台)	合計 (台)	大型車 混入率 (%)	時間 係数 (%)	二輪車 (台)	種別 小型車 (台)	大型車 (台)	合計 (台)	大型車 混入率 (%)	時間 係数 (%)	二輪車 (台)
15:00-15:15	31	8	39	20.5	1.6	1	0	0	0	0.0	0.0	0
15:15-15:30	21	6	27	22.2	1.1	0	0	0	0	0.0	0.0	0
15:30-15:45	29	6	35	17.1	1.4	0	0	0	0	0.0	0.0	0
15:45-16:00	27	6	33	18.2	1.3	1	0	0	0	0.0	0.0	0
1時間計	108	26	134	19.4	5.4	2	0	0	0	0.0	0.0	0
16:00-16:15	33	11	44	25.0	1.8	0	0	0	0	0.0	0.0	0
16:15-16:30	31	9	40	22.5	1.6	0	0	0	0	0.0	0.0	0
16:30-16:45	25	6	31	19.4	1.3	1	0	0	0	0.0	0.0	0
16:45-17:00	35	10	45	22.2	1.8	1	0	0	0	0.0	0.0	0
1時間計	124	36	160	22.5	6.5	2	0	0	0	0.0	0.0	0
17:00-17:15	41	2	43	4.7	1.7	0	0	0	0	0.0	0.0	0
17:15-17:30	34	5	39	12.8	1.6	2	0	0	0	0.0	0.0	0
17:30-17:45	38	8	46	17.4	1.9	2	0	0	0	0.0	0.0	0
17:45-18:00	31	4	35	11.4	1.4	1	0	0	0	0.0	0.0	0
1時間計	144	19	163	11.7	6.6	5	0	0	0	0.0	0.0	0
18:00-18:15	40	5	45	11.1	1.8	1	0	0	0	0.0	0.0	0
18:15-18:30	40	1	41	2.4	1.7	3	0	0	0	0.0	0.0	0
18:30-18:45	55	2	57	3.5	2.3	3	0	0	0	0.0	0.0	0
18:45-19:00	36	1	37	2.7	1.5	1	0	0	0	0.0	0.0	0
1時間計	171	9	180	5.0	7.3	8	0	0	0	0.0	0.0	0
昼12時間計	1494	351	1845	19.0	74.9	48	6	0	6	0.0	85.7	0
19:00-19:15	46	2	48	4.2	1.9	4	0	0	0	0.0	0.0	0
19:15-19:30	45	4	49	8.2	2.0	1	0	0	0	0.0	0.0	0
19:30-19:45	41	1	42	2.4	1.7	2	0	0	0	0.0	0.0	0
19:45-20:00	32	5	37	13.5	1.5	3	0	0	0	0.0	0.0	0
1時間計	164	12	176	6.8	7.1	10	0	0	0	0.0	0.0	0
20:00-20:15	23	4	27	14.8	1.1	0	0	0	0	0.0	0.0	0
20:15-20:30	25	2	27	7.4	1.1	4	0	0	0	0.0	0.0	0
20:30-20:45	25	4	29	13.8	1.2	3	0	0	0	0.0	0.0	0
20:45-21:00	16	1	17	5.9	0.7	1	0	0	0	0.0	0.0	0
1時間計	89	11	100	11.0	4.1	8	0	0	0	0.0	0.0	0
21:00-21:15	22	1	23	4.3	0.9	1	0	0	0	0.0	0.0	0
21:15-21:30	18	1	19	5.3	0.8	2	0	0	0	0.0	0.0	0
21:30-21:45	10	1	11	9.1	0.4	0	0	0	0	0.0	0.0	0
21:45-22:00	11	1	12	8.3	0.5	0	0	0	0	0.0	0.0	0
1時間計	61	4	65	6.2	2.6	3	0	0	0	0.0	0.0	0
22:00-22:15	10	2	12	16.7	0.5	2	0	0	0	0.0	0.0	0
22:15-22:30	7	1	8	12.5	0.3	0	0	0	0	0.0	0.0	0
22:30-22:45	11	0	11	0.0	0.4	0	0	0	0	0.0	0.0	0
22:45-23:00	14	2	16	12.5	0.6	1	0	0	0	0.0	0.0	0
1時間計	42	5	47	10.6	1.9	3	0	0	0	0.0	0.0	0

方向別自動車交通量調査表

調査地点：地域社会2 目黒交番前

調査年月日：令和元年 5月14日(火) 天候：雨のち曇り

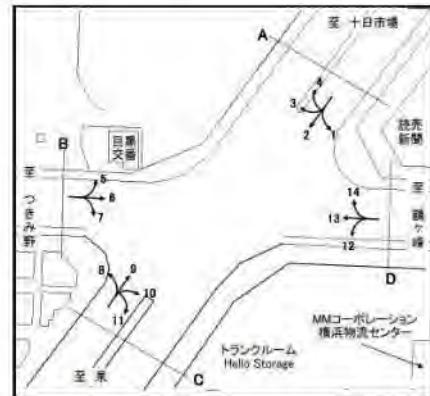

方向 時間帯	3						4					
	種別 小型車 (台)	大型車 (台)	合計 (台)	大型車 混入率 (%)	時間 係数 (%)	二輪車 (台)	小型車 (台)	大型車 (台)	合計 (台)	大型車 混入率 (%)	時間 係数 (%)	二輪車 (台)
23:00-23:15	8	1	9	11.1	0.4	1	0	0	0	0.0	0.0	0
23:15-23:30	6	2	8	25.0	0.3	0	0	0	0	0.0	0.0	0
23:30-23:45	3	0	3	0.0	0.1	0	0	0	0	0.0	0.0	0
23:45-24:00	3	1	4	25.0	0.2	0	0	0	0	0.0	0.0	0
1時間計	20	4	24	16.7	1.0	1	0	0	0	0.0	0.0	0
0:00-0:15	2	2	4	50.0	0.2	0	0	0	0	0.0	0.0	0
0:15-0:30	2	3	5	60.0	0.2	0	0	0	0	0.0	0.0	0
0:30-0:45	8	1	9	11.1	0.4	0	0	0	0	0.0	0.0	0
0:45-1:00	2	1	3	33.3	0.1	0	0	0	0	0.0	0.0	0
1時間計	14	7	21	33.3	0.9	0	0	0	0	0.0	0.0	0
1:00-1:15	2	1	3	33.3	0.1	0	0	0	0	0.0	0.0	0
1:15-1:30	1	2	3	66.7	0.1	0	0	0	0	0.0	0.0	0
1:30-1:45	2	1	3	33.3	0.1	0	0	0	0	0.0	0.0	0
1:45-2:00	1	1	2	50.0	0.1	0	0	0	0	0.0	0.0	0
1時間計	6	5	11	45.5	0.4	0	0	0	0	0.0	0.0	0
2:00-2:15	1	2	3	66.7	0.1	0	0	0	0	0.0	0.0	0
2:15-2:30	4	0	4	0.0	0.2	0	0	0	0	0.0	0.0	0
2:30-2:45	1	3	4	75.0	0.2	0	0	0	0	0.0	0.0	0
2:45-3:00	1	1	2	50.0	0.1	0	0	0	0	0.0	0.0	0
1時間計	7	6	13	46.2	0.5	0	0	0	0	0.0	0.0	0
3:00-3:15	3	3	6	50.0	0.2	0	0	0	0	0.0	0.0	0
3:15-3:30	1	1	2	50.0	0.1	0	0	0	0	0.0	0.0	0
3:30-3:45	2	1	3	33.3	0.1	0	0	0	0	0.0	0.0	0
3:45-4:00	2	1	3	33.3	0.1	0	0	0	0	0.0	0.0	0
1時間計	8	6	14	42.9	0.6	0	0	0	0	0.0	0.0	0
4:00-4:15	2	2	4	50.0	0.2	0	0	0	0	0.0	0.0	0
4:15-4:30	5	1	6	16.7	0.2	0	0	0	0	0.0	0.0	0
4:30-4:45	4	1	5	20.0	0.2	1	0	0	0	0.0	0.0	0
4:45-5:00	2	2	4	50.0	0.2	0	0	0	0	0.0	0.0	0
1時間計	13	6	19	31.6	0.8	1	0	0	0	0.0	0.0	0
5:00-5:15	5	2	7	28.6	0.3	0	0	0	0	0.0	0.0	0
5:15-5:30	11	1	12	8.3	0.5	1	0	0	0	0.0	0.0	0
5:30-5:45	10	1	11	9.1	0.4	1	0	0	0	0.0	0.0	0
5:45-6:00	11	2	13	15.4	0.5	2	0	0	0	0.0	0.0	0
1時間計	37	6	43	14.0	1.7	4	0	0	0	0.0	0.0	0
6:00-6:15	16	2	18	11.1	0.7	2	0	0	0	0.0	0.0	0
6:15-6:30	13	3	16	18.8	0.6	1	1	0	1	0.0	14.3	0
6:30-6:45	23	5	28	17.9	1.1	2	0	0	0	0.0	0.0	0
6:45-7:00	18	5	23	21.7	0.9	0	0	0	0	0.0	0.0	0
1時間計	70	15	85	17.6	3.5	5	1	0	1	0.0	14.3	0
夜12時間計	531	87	618	14.1	25.1	35	1	0	1	0.0	14.3	0
全時間合計	2025	438	2463	17.8	100.0	83	7	0	7	0.0	100.0	0
昼夜率	1.36	1.25	1.33	-	-	1.73	1.17	0.00	1.17	-	-	0.00

方向別自動車交通量調査表

調査地点：地域社会2 目黒交番前

調査年月日：令和元年 5月14日(火) 天候：雨のち曇り

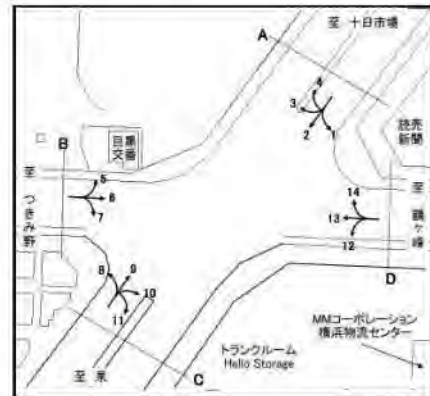

時間帯	方向 種別							A 合計 (1+2+3+4)					
		小型車 (台)	大型車 (台)	合計 (台)	大型車 混入率 (%)	時間 係数 (%)	二輪車 (台)	小型車 (台)	大型車 (台)	合計 (台)	大型車 混入率 (%)	時間 係数 (%)	二輪車 (台)
7:00-7:15							96	13	109	11.9	1.6	6	
7:15-7:30							100	10	110	9.1	1.6	9	
7:30-7:45							123	21	144	14.6	2.1	9	
7:45-8:00							94	16	110	14.5	1.6	6	
1時間計							413	60	473	12.7	6.9	30	
8:00-8:15							115	12	127	9.4	1.9	4	
8:15-8:30							75	16	91	17.6	1.3	5	
8:30-8:45							101	12	113	10.6	1.6	4	
8:45-9:00							88	15	103	14.6	1.5	3	
1時間計							379	55	434	12.7	6.3	16	
9:00-9:15							91	13	104	12.5	1.5	2	
9:15-9:30							70	19	89	21.3	1.3	2	
9:30-9:45							73	26	99	26.3	1.4	0	
9:45-10:00							103	26	129	20.2	1.9	3	
1時間計							337	84	421	20.0	6.1	7	
10:00-10:15							69	21	90	23.3	1.3	3	
10:15-10:30							75	20	95	21.1	1.4	2	
10:30-10:45							69	20	89	22.5	1.3	1	
10:45-11:00							78	20	98	20.4	1.4	3	
1時間計							291	81	372	21.8	5.4	9	
11:00-11:15							59	24	83	28.9	1.2	1	
11:15-11:30							84	11	95	11.6	1.4	2	
11:30-11:45							88	27	115	23.5	1.7	0	
11:45-12:00							68	16	84	19.0	1.2	2	
1時間計							299	78	377	20.7	5.5	5	
12:00-12:15							78	18	96	18.8	1.4	1	
12:15-12:30							67	15	82	18.3	1.2	1	
12:30-12:45							69	22	91	24.2	1.3	1	
12:45-13:00							81	23	104	22.1	1.5	3	
1時間計							295	78	373	20.9	5.4	6	
13:00-13:15							75	17	92	18.5	1.3	0	
13:15-13:30							68	22	90	24.4	1.3	1	
13:30-13:45							71	23	94	24.5	1.4	0	
13:45-14:00							79	25	104	24.0	1.5	1	
1時間計							293	87	380	22.9	5.5	2	
14:00-14:15							96	13	109	11.9	1.6	2	
14:15-14:30							69	18	87	20.7	1.3	4	
14:30-14:45							79	16	95	16.8	1.4	0	
14:45-15:00							66	13	79	16.5	1.2	1	
1時間計							310	60	370	16.2	5.4	7	

方向別自動車交通量調査表

調査地点：地域社会2 目黒交番前

調査年月日：令和元年 5月14日(火) 天候：雨のち曇り

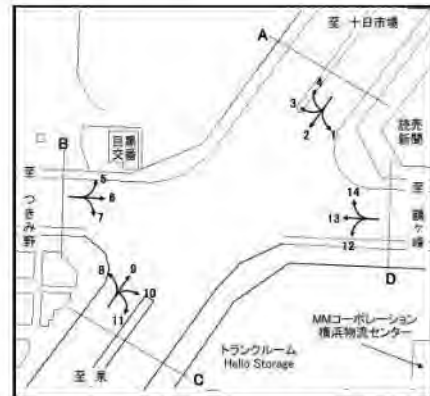

方向							A 合計 (1+2+3+4)					
	種別	小型車 (台)	大型車 (台)	合計 (台)	大型車 混入率 (%)	時間 係数 (%)	二輪車 (台)	小型車 (台)	大型車 (台)	合計 (台)	大型車 混入率 (%)	時間 係数 (%)
15:00-15:15							107	15	122	12.3	1.8	3
15:15-15:30							68	21	89	23.6	1.3	0
15:30-15:45							96	13	109	11.9	1.6	1
15:45-16:00							75	15	90	16.7	1.3	4
1時間計							346	64	410	15.6	6.0	8
16:00-16:15							120	21	141	14.9	2.1	3
16:15-16:30							124	21	145	14.5	2.1	6
16:30-16:45							72	12	84	14.3	1.2	2
16:45-17:00							96	23	119	19.3	1.7	3
1時間計							412	77	489	15.7	7.1	14
17:00-17:15							104	7	111	6.3	1.6	0
17:15-17:30							112	8	120	6.7	1.7	3
17:30-17:45							119	12	131	9.2	1.9	6
17:45-18:00							104	9	113	8.0	1.6	6
1時間計							439	36	475	7.6	6.9	15
18:00-18:15							106	9	115	7.8	1.7	5
18:15-18:30							119	4	123	3.3	1.8	10
18:30-18:45							148	7	155	4.5	2.3	5
18:45-19:00							103	3	106	2.8	1.5	5
1時間計							476	23	499	4.6	7.3	25
昼12時間計							4290	783	5073	15.4	74.0	144
19:00-19:15							112	6	118	5.1	1.7	7
19:15-19:30							114	8	122	6.6	1.8	5
19:30-19:45							112	2	114	1.8	1.7	4
19:45-20:00							96	5	101	5.0	1.5	9
1時間計							434	21	455	4.6	6.6	25
20:00-20:15							76	4	80	5.0	1.2	1
20:15-20:30							75	5	80	6.3	1.2	4
20:30-20:45							78	4	82	4.9	1.2	6
20:45-21:00							62	1	63	1.6	0.9	4
1時間計							291	14	305	4.6	4.4	15
21:00-21:15							70	2	72	2.8	1.0	4
21:15-21:30							54	1	55	1.8	0.8	3
21:30-21:45							33	2	35	5.7	0.5	1
21:45-22:00							47	3	50	6.0	0.7	5
1時間計							204	8	212	3.8	3.1	13
22:00-22:15							34	3	37	8.1	0.5	3
22:15-22:30							26	2	28	7.1	0.4	1
22:30-22:45							31	0	31	0.0	0.5	2
22:45-23:00							27	2	29	6.9	0.4	1
1時間計							118	7	125	5.6	1.8	7

方向別自動車交通量調査表

調査地点：地域社会2 目黒交番前

調査年月日：令和元年 5月14日(火) 天候：雨のち曇り

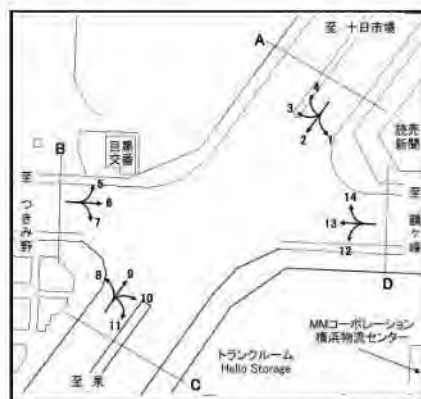

方向 時間帯							A 合計 (1+2+3+4)					
	種別 小型車 (台)	大型車 (台)	合計 (台)	大型車 混入率 (%)	時間 係数 (%)	二輪車 (台)	小型車 (台)	大型車 (台)	合計 (台)	大型車 混入率 (%)	時間 係数 (%)	二輪車 (台)
23:00-23:15							22	3	25	12.0	0.4	2
23:15-23:30							23	2	25	8.0	0.4	0
23:30-23:45							14	0	14	0.0	0.2	1
23:45-24:00							12	1	13	7.7	0.2	0
1 時間計							71	6	77	7.8	1.1	3
0:00-0:15							15	3	18	16.7	0.3	1
0:15-0:30							10	4	14	28.6	0.2	1
0:30-0:45							19	1	20	5.0	0.3	0
0:45-1:00							6	3	9	33.3	0.1	0
1 時間計							50	11	61	18.0	0.9	2
1:00-1:15							4	2	6	33.3	0.1	0
1:15-1:30							6	4	10	40.0	0.1	0
1:30-1:45							5	2	7	28.6	0.1	0
1:45-2:00							4	5	9	55.6	0.1	0
1 時間計							19	13	32	40.6	0.5	0
2:00-2:15							4	6	10	60.0	0.1	0
2:15-2:30							7	2	9	22.2	0.1	0
2:30-2:45							5	4	9	44.4	0.1	0
2:45-3:00							4	4	8	50.0	0.1	1
1 時間計							20	16	36	44.4	0.5	1
3:00-3:15							7	6	13	46.2	0.2	0
3:15-3:30							4	4	8	50.0	0.1	0
3:30-3:45							4	3	7	42.9	0.1	1
3:45-4:00							8	3	11	27.3	0.2	3
1 時間計							23	16	39	41.0	0.6	4
4:00-4:15							6	2	8	25.0	0.1	1
4:15-4:30							15	1	16	6.3	0.2	1
4:30-4:45							14	3	17	17.6	0.2	3
4:45-5:00							13	5	18	27.8	0.3	0
1 時間計							48	11	59	18.6	0.9	5
5:00-5:15							14	5	19	26.3	0.3	0
5:15-5:30							25	2	27	7.4	0.4	1
5:30-5:45							30	1	31	3.2	0.5	3
5:45-6:00							38	5	43	11.6	0.6	2
1 時間計							107	13	120	10.8	1.7	6
6:00-6:15							34	5	39	12.8	0.6	7
6:15-6:30							62	14	76	18.4	1.1	3
6:30-6:45							58	9	67	13.4	1.0	7
6:45-7:00							75	9	84	10.7	1.2	2
1 時間計							229	37	266	13.9	3.9	19
夜12時間計							1614	173	1787	9.7	26.0	100
全時間合計							5904	956	6860	13.9	100.0	244
昼夜率							1.38	1.22	1.35	-	-	1.69

方向別自動車交通量調査表

調査地点：地域社会2 目黒交番前

調査年月日：令和元年 5月14日(火) 天候：雨のち曇り

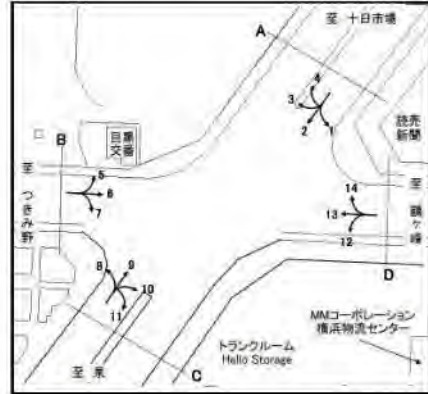

方向	5						6						
	種別	小型車 (台)	大型車 (台)	合計 (台)	大型車 混入率 (%)	時係 数 (%)	二輪車 (台)	小型車 (台)	大型車 (台)	合計 (台)	大型車 混入率 (%)	時係 数 (%)	二輪車 (台)
7:00-7:15		40	2	42	4.8	1.8	1	67	38	105	36.2	1.0	6
7:15-7:30		67	11	78	14.1	3.4	5	64	40	104	38.5	1.0	13
7:30-7:45		38	5	43	11.6	1.9	7	71	44	115	38.3	1.1	8
7:45-8:00		41	6	47	12.8	2.0	3	76	33	109	30.3	1.0	11
1時間計		186	24	210	11.4	9.1	16	278	155	433	35.8	4.2	38
8:00-8:15		47	7	54	13.0	2.3	4	106	44	150	29.3	1.4	14
8:15-8:30		24	16	40	40.0	1.7	6	62	35	97	36.1	0.9	9
8:30-8:45		33	12	45	26.7	2.0	1	69	37	106	34.9	1.0	3
8:45-9:00		35	17	52	32.7	2.3	2	88	53	141	37.6	1.4	4
1時間計		139	52	191	27.2	8.3	13	325	169	494	34.2	4.7	30
9:00-9:15		28	10	38	26.3	1.7	0	60	52	112	46.4	1.1	5
9:15-9:30		29	16	45	35.6	2.0	1	60	53	113	46.9	1.1	0
9:30-9:45		28	20	48	41.7	2.1	0	95	60	155	38.7	1.5	0
9:45-10:00		30	24	54	44.4	2.3	0	66	61	127	48.0	1.2	3
1時間計		115	70	185	37.8	8.0	1	281	226	507	44.6	4.9	8
10:00-10:15		26	10	36	27.8	1.6	0	50	51	101	50.5	1.0	0
10:15-10:30		25	2	27	7.4	1.2	1	69	57	126	45.2	1.2	1
10:30-10:45		37	13	50	26.0	2.2	0	72	49	121	40.5	1.2	2
10:45-11:00		18	14	32	43.8	1.4	2	51	78	129	60.5	1.2	2
1時間計		106	39	145	26.9	6.3	3	242	235	477	49.3	4.6	5
11:00-11:15		12	5	17	29.4	0.7	0	85	54	139	38.8	1.3	1
11:15-11:30		18	10	28	35.7	1.2	0	63	57	120	47.5	1.2	2
11:30-11:45		18	12	30	40.0	1.3	0	75	53	128	41.4	1.2	1
11:45-12:00		27	3	30	10.0	1.3	2	79	58	137	42.3	1.3	0
1時間計		75	30	105	28.6	4.6	2	302	222	524	42.4	5.0	4
12:00-12:15		33	4	37	10.8	1.6	1	87	75	162	46.3	1.6	1
12:15-12:30		21	4	25	16.0	1.1	2	61	52	113	46.0	1.1	2
12:30-12:45		19	3	22	13.6	1.0	2	77	48	125	38.4	1.2	2
12:45-13:00		22	0	22	0.0	1.0	0	90	57	147	38.8	1.4	2
1時間計		95	11	106	10.4	4.6	5	315	232	547	42.4	5.3	7
13:00-13:15		19	13	32	40.6	1.4	0	61	37	98	37.8	0.9	0
13:15-13:30		26	12	38	31.6	1.7	0	93	51	144	35.4	1.4	3
13:30-13:45		23	8	31	25.8	1.3	0	71	46	117	39.3	1.1	1
13:45-14:00		12	5	17	29.4	0.7	0	69	38	107	35.5	1.0	3
1時間計		80	38	118	32.2	5.1	0	294	172	466	36.9	4.5	7
14:00-14:15		29	8	37	21.6	1.6	1	97	52	149	34.9	1.4	0
14:15-14:30		16	7	23	30.4	1.0	0	70	55	125	44.0	1.2	1
14:30-14:45		20	10	30	33.3	1.3	0	98	46	144	31.9	1.4	2
14:45-15:00		30	4	34	11.8	1.5	0	105	44	149	29.5	1.4	2
1時間計		95	29	124	23.4	5.4	1	370	197	567	34.7	5.4	5

方向別自動車交通量調査表

調査地点：地域社会2 目黒交番前

調査年月日：令和元年 5月14日(火) 天候：雨のち曇り

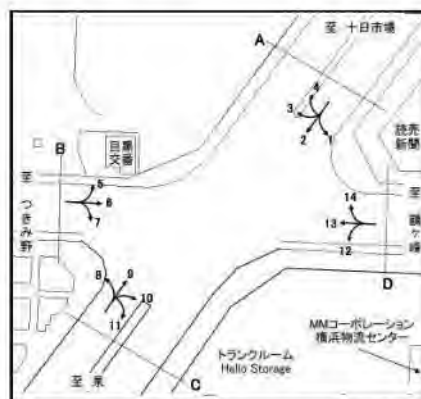

方向 時間帯	5						6					
	種別 小型車 (台)	大型車 (台)	合計 (台)	大型車 混入率 (%)	時間 係数 (%)	二輪車 (台)	種別 小型車 (台)	大型車 (台)	合計 (台)	大型車 混入率 (%)	時間 係数 (%)	二輪車 (台)
15:00-15:15	31	7	38	18.4	1.7	1	74	45	119	37.8	1.1	2
15:15-15:30	21	9	30	30.0	1.3	0	104	29	133	21.8	1.3	4
15:30-15:45	17	4	21	19.0	0.9	0	82	27	109	24.8	1.0	3
15:45-16:00	14	3	17	17.6	0.7	1	98	34	132	25.8	1.3	2
1時間計	83	23	106	21.7	4.6	2	358	135	493	27.4	4.7	11
16:00-16:15	29	8	37	21.6	1.6	0	96	40	136	29.4	1.3	2
16:15-16:30	29	1	30	3.3	1.3	0	107	32	139	23.0	1.3	3
16:30-16:45	29	4	33	12.1	1.4	0	89	35	124	28.2	1.2	3
16:45-17:00	28	5	33	15.2	1.4	2	127	42	169	24.9	1.6	2
1時間計	115	18	133	13.5	5.8	2	419	149	568	26.2	5.5	10
17:00-17:15	36	9	45	20.0	2.0	2	125	36	161	22.4	1.5	5
17:15-17:30	50	4	54	7.4	2.3	1	137	28	165	17.0	1.6	8
17:30-17:45	31	7	38	18.4	1.7	5	134	23	157	14.6	1.5	11
17:45-18:00	42	3	45	6.7	2.0	2	165	24	189	12.7	1.8	6
1時間計	159	23	182	12.6	7.9	10	561	111	672	16.5	6.5	30
18:00-18:15	37	4	41	9.8	1.8	2	132	22	154	14.3	1.5	7
18:15-18:30	32	4	36	11.1	1.6	1	109	25	134	18.7	1.3	5
18:30-18:45	36	5	41	12.2	1.8	3	101	22	123	17.9	1.2	8
18:45-19:00	29	2	31	6.5	1.3	3	135	27	162	16.7	1.6	7
1時間計	134	15	149	10.1	6.5	9	477	96	573	16.8	5.5	27
昼12時間計	1382	372	1754	21.2	76.3	64	4222	2099	6321	33.2	60.7	182
19:00-19:15	37	3	40	7.5	1.7	0	99	31	130	23.8	1.2	5
19:15-19:30	31	2	33	6.1	1.4	1	95	19	114	16.7	1.1	8
19:30-19:45	16	0	16	0.0	0.7	0	89	12	101	11.9	1.0	5
19:45-20:00	25	1	26	3.8	1.1	1	109	10	119	8.4	1.1	8
1時間計	109	6	115	5.2	5.0	2	392	72	464	15.5	4.5	26
20:00-20:15	21	2	23	8.7	1.0	0	88	19	107	17.8	1.0	10
20:15-20:30	20	1	21	4.8	0.9	2	88	23	111	20.7	1.1	8
20:30-20:45	20	1	21	4.8	0.9	0	91	16	107	15.0	1.0	3
20:45-21:00	21	0	21	0.0	0.9	0	88	19	107	17.8	1.0	4
1時間計	82	4	86	4.7	3.7	2	355	77	432	17.8	4.1	25
21:00-21:15	15	0	15	0.0	0.7	1	51	7	58	12.1	0.6	1
21:15-21:30	16	0	16	0.0	0.7	1	71	22	93	23.7	0.9	3
21:30-21:45	10	1	11	9.1	0.5	0	87	18	105	17.1	1.0	4
21:45-22:00	8	0	8	0.0	0.3	0	53	14	67	20.9	0.6	6
1時間計	49	1	50	2.0	2.2	2	262	61	323	18.9	3.1	14
22:00-22:15	7	2	9	22.2	0.4	0	67	15	82	18.3	0.8	3
22:15-22:30	16	3	19	15.8	0.8	0	113	39	152	25.7	1.5	5
22:30-22:45	16	1	17	5.9	0.7	0	100	26	126	20.6	1.2	5
22:45-23:00	26	4	30	13.3	1.3	0	119	30	149	20.1	1.4	5
1時間計	65	10	75	13.3	3.3	0	399	110	509	21.6	4.9	18

方向別自動車交通量調査表

調査地点：地域社会2 目黒交番前

調査年月日：令和元年 5月14日(火) 天候：雨のち曇り

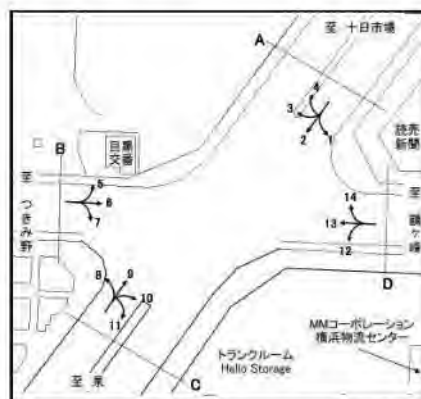

方向 時間帯	5						6					
	種別 小型車 (台)	大型車 (台)	合計 (台)	大型車 混入率 (%)	時間 係数 (%)	二輪車 (台)	小型車 (台)	大型車 (台)	合計 (台)	大型車 混入率 (%)	時間 係数 (%)	二輪車 (台)
23:00-23:15	11	5	16	31.3	0.7	1	42	19	61	31.1	0.6	2
23:15-23:30	2	1	3	33.3	0.1	0	20	13	33	39.4	0.3	0
23:30-23:45	4	0	4	0.0	0.2	1	34	16	50	32.0	0.5	5
23:45-24:00	2	3	5	60.0	0.2	0	26	15	41	36.6	0.4	1
1時間計	19	9	28	32.1	1.2	2	122	63	185	34.1	1.8	8
0:00-0:15	1	2	3	66.7	0.1	0	25	14	39	35.9	0.4	0
0:15-0:30	5	2	7	28.6	0.3	0	19	21	40	52.5	0.4	0
0:30-0:45	5	2	7	28.6	0.3	0	27	34	61	55.7	0.6	0
0:45-1:00	6	2	8	25.0	0.3	0	13	14	27	51.9	0.3	0
1時間計	17	8	25	32.0	1.1	0	84	83	167	49.7	1.6	0
1:00-1:15	5	4	9	44.4	0.4	0	16	23	39	59.0	0.4	0
1:15-1:30	5	1	6	16.7	0.3	0	24	22	46	47.8	0.4	0
1:30-1:45	1	0	1	0.0	0.0	0	18	15	33	45.5	0.3	1
1:45-2:00	3	0	3	0.0	0.1	0	15	11	26	42.3	0.2	0
1時間計	14	5	19	26.3	0.8	0	73	71	144	49.3	1.4	1
2:00-2:15	2	2	4	50.0	0.2	0	8	21	29	72.4	0.3	1
2:15-2:30	2	1	3	33.3	0.1	0	12	16	28	57.1	0.3	0
2:30-2:45	3	1	4	25.0	0.2	0	11	19	30	63.3	0.3	0
2:45-3:00	2	0	2	0.0	0.1	0	12	20	32	62.5	0.3	0
1時間計	9	4	13	30.8	0.6	0	43	76	119	63.9	1.1	1
3:00-3:15	0	0	0	0.0	0.0	0	32	30	62	48.4	0.6	0
3:15-3:30	1	0	1	0.0	0.0	0	14	16	30	53.3	0.3	0
3:30-3:45	3	1	4	25.0	0.2	0	15	21	36	58.3	0.3	0
3:45-4:00	4	0	4	0.0	0.2	0	28	31	59	52.5	0.6	2
1時間計	8	1	9	11.1	0.4	0	89	98	187	52.4	1.8	2
4:00-4:15	1	1	2	50.0	0.1	0	16	39	55	70.9	0.5	1
4:15-4:30	1	0	1	0.0	0.0	0	19	32	51	62.7	0.5	1
4:30-4:45	1	3	4	75.0	0.2	1	18	34	52	65.4	0.5	0
4:45-5:00	3	2	5	40.0	0.2	0	43	50	93	53.8	0.9	4
1時間計	6	6	12	50.0	0.5	1	96	155	251	61.8	2.4	6
5:00-5:15	3	2	5	40.0	0.2	0	56	55	111	49.5	1.1	2
5:15-5:30	8	2	10	20.0	0.4	2	109	72	181	39.8	1.7	9
5:30-5:45	7	2	9	22.2	0.4	1	113	45	158	28.5	1.5	6
5:45-6:00	10	3	13	23.1	0.6	0	116	59	175	33.7	1.7	6
1時間計	28	9	37	24.3	1.6	3	394	231	625	37.0	6.0	23
6:00-6:15	13	4	17	23.5	0.7	2	135	51	186	27.4	1.8	6
6:15-6:30	16	3	19	15.8	0.8	0	131	34	165	20.6	1.6	3
6:30-6:45	15	7	22	31.8	1.0	1	140	30	170	17.6	1.6	4
6:45-7:00	12	6	18	33.3	0.8	3	142	26	168	15.5	1.6	2
1時間計	56	20	76	26.3	3.3	6	548	141	689	20.5	6.6	15
夜12時間計	462	83	545	15.2	23.7	18	2857	1238	4095	30.2	39.3	139
全時間合計	1844	455	2299	19.8	100.0	82	7079	3337	10416	32.0	100.0	321
昼夜率	1.33	1.22	1.31	-	-	1.28	1.68	1.59	1.65	-	-	1.76

方向別自動車交通量調査表

調査地点：地域社会2 目黒交番前

調査年月日：令和元年 5月14日(火) 天候：雨のち曇り

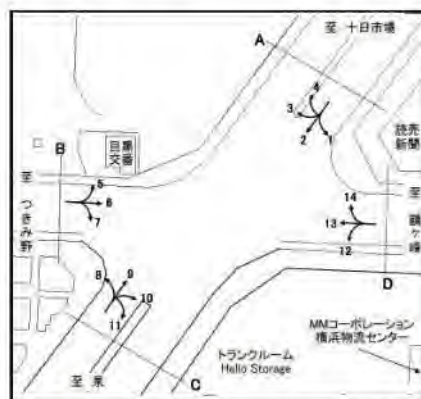

時間帯	種別	7						B 合計 (5+ 6+ 7)					
		小型車 (台)	大型車 (台)	合計 (台)	大型車 混入率 (%)	時 間 係 数 (%)	二輪車 (台)	小型車 (台)	大型車 (台)	合計 (台)	大型車 混入率 (%)	時 間 係 数 (%)	二輪車 (台)
7:00-7:15		8	5	13	38.5	1.1	0	115	45	160	28.1	1.2	7
7:15-7:30		20	9	29	31.0	2.5	1	151	60	211	28.4	1.5	19
7:30-7:45		9	3	12	25.0	1.0	1	118	52	170	30.6	1.2	16
7:45-8:00		14	4	18	22.2	1.5	0	131	43	174	24.7	1.3	14
1 時間計		51	21	72	29.2	6.1	2	515	200	715	28.0	5.1	56
8:00-8:15		14	5	19	26.3	1.6	0	167	56	223	25.1	1.6	18
8:15-8:30		6	4	10	40.0	0.9	0	92	55	147	37.4	1.1	15
8:30-8:45		8	6	14	42.9	1.2	0	110	55	165	33.3	1.2	4
8:45-9:00		16	6	22	27.3	1.9	0	139	76	215	35.3	1.5	6
1 時間計		44	21	65	32.3	5.5	0	508	242	750	32.3	5.4	43
9:00-9:15		5	2	7	28.6	0.6	0	93	64	157	40.8	1.1	5
9:15-9:30		4	4	8	50.0	0.7	2	93	73	166	44.0	1.2	3
9:30-9:45		7	4	11	36.4	0.9	0	130	84	214	39.3	1.5	0
9:45-10:00		7	6	13	46.2	1.1	0	103	91	194	46.9	1.4	3
1 時間計		23	16	39	41.0	3.3	2	419	312	731	42.7	5.3	11
10:00-10:15		4	4	8	50.0	0.7	0	80	65	145	44.8	1.0	0
10:15-10:30		14	6	20	30.0	1.7	0	108	65	173	37.6	1.2	2
10:30-10:45		10	8	18	44.4	1.5	0	119	70	189	37.0	1.4	2
10:45-11:00		16	4	20	20.0	1.7	0	85	96	181	53.0	1.3	4
1 時間計		44	22	66	33.3	5.6	0	392	296	688	43.0	5.0	8
11:00-11:15		10	7	17	41.2	1.4	0	107	66	173	38.2	1.2	1
11:15-11:30		11	6	17	35.3	1.4	0	92	73	165	44.2	1.2	2
11:30-11:45		13	7	20	35.0	1.7	0	106	72	178	40.4	1.3	1
11:45-12:00		14	4	18	22.2	1.5	0	120	65	185	35.1	1.3	2
1 時間計		48	24	72	33.3	6.1	0	425	276	701	39.4	5.0	6
12:00-12:15		12	6	18	33.3	1.5	0	132	85	217	39.2	1.6	2
12:15-12:30		12	8	20	40.0	1.7	0	94	64	158	40.5	1.1	4
12:30-12:45		11	3	14	21.4	1.2	0	107	54	161	33.5	1.2	4
12:45-13:00		16	4	20	20.0	1.7	0	128	61	189	32.3	1.4	2
1 時間計		51	21	72	29.2	6.1	0	461	264	725	36.4	5.2	12
13:00-13:15		10	4	14	28.6	1.2	0	90	54	144	37.5	1.0	0
13:15-13:30		10	3	13	23.1	1.1	0	129	66	195	33.8	1.4	3
13:30-13:45		4	2	6	33.3	0.5	1	98	56	154	36.4	1.1	2
13:45-14:00		3	2	5	40.0	0.4	1	84	45	129	34.9	0.9	4
1 時間計		27	11	38	28.9	3.2	2	401	221	622	35.5	4.5	9
14:00-14:15		15	3	18	16.7	1.5	0	141	63	204	30.9	1.5	1
14:15-14:30		12	4	16	25.0	1.4	1	98	66	164	40.2	1.2	2
14:30-14:45		16	3	19	15.8	1.6	0	134	59	193	30.6	1.4	2
14:45-15:00		15	2	17	11.8	1.4	0	150	50	200	25.0	1.4	2
1 時間計		58	12	70	17.1	6.0	1	523	238	761	31.3	5.5	7

方向別自動車交通量調査表

調査地点：地域社会2 目黒交番前

調査年月日：令和元年 5月14日(火) 天候：雨のち曇り

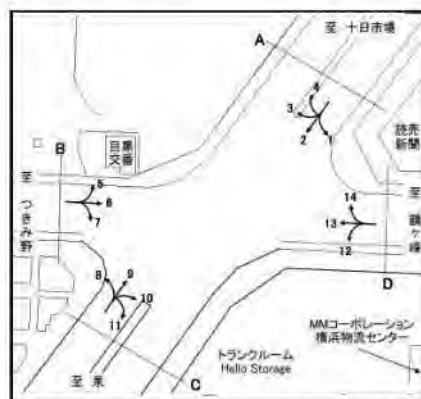

方向 種別 時間帯	7						B 合計 (5+ 6+ 7)					
	小型車 (台)	大型車 (台)	合計 (台)	大型車 混入率 (%)	時 間 係 数 (%)	二輪車 (台)	小型車 (台)	大型車 (台)	合計 (台)	大型車 混入率 (%)	時 間 係 数 (%)	二輪車 (台)
15:00-15:15	13	4	17	23.5	1.4	0	118	56	174	32.2	1.3	3
15:15-15:30	12	5	17	29.4	1.4	0	137	43	180	23.9	1.3	4
15:30-15:45	7	3	10	30.0	0.9	0	106	34	140	24.3	1.0	3
15:45-16:00	8	4	12	33.3	1.0	0	120	41	161	25.5	1.2	3
1時間計	40	16	56	28.6	4.8	0	481	174	655	26.6	4.7	13
16:00-16:15	11	3	14	21.4	1.2	2	136	51	187	27.3	1.3	4
16:15-16:30	7	2	9	22.2	0.8	0	143	35	178	19.7	1.3	3
16:30-16:45	6	0	6	0.0	0.5	0	124	39	163	23.9	1.2	3
16:45-17:00	7	3	10	30.0	0.9	1	162	50	212	23.6	1.5	5
1時間計	31	8	39	20.5	3.3	3	565	175	740	23.6	5.3	15
17:00-17:15	12	3	15	20.0	1.3	1	173	48	221	21.7	1.6	8
17:15-17:30	18	2	20	10.0	1.7	1	205	34	239	14.2	1.7	10
17:30-17:45	24	2	26	7.7	2.2	1	189	32	221	14.5	1.6	17
17:45-18:00	12	2	14	14.3	1.2	0	219	29	248	11.7	1.8	8
1時間計	66	9	75	12.0	6.4	3	786	143	929	15.4	6.7	43
18:00-18:15	14	2	16	12.5	1.4	2	183	28	211	13.3	1.5	11
18:15-18:30	20	4	24	16.7	2.0	0	161	33	194	17.0	1.4	6
18:30-18:45	13	1	14	7.1	1.2	1	150	28	178	15.7	1.3	12
18:45-19:00	18	3	21	14.3	1.8	0	182	32	214	15.0	1.5	10
1時間計	65	10	75	13.3	6.4	3	676	121	797	15.2	5.7	39
昼12時間計	548	191	739	25.8	62.8	16	6152	2662	8814	30.2	63.5	262
19:00-19:15	18	5	23	21.7	2.0	0	154	39	193	20.2	1.4	5
19:15-19:30	19	1	20	5.0	1.7	0	145	22	167	13.2	1.2	9
19:30-19:45	16	0	16	0.0	1.4	1	121	12	133	9.0	1.0	6
19:45-20:00	12	1	13	7.7	1.1	1	146	12	158	7.6	1.1	10
1時間計	65	7	72	9.7	6.1	2	566	85	651	13.1	4.7	30
20:00-20:15	23	1	24	4.2	2.0	1	132	22	154	14.3	1.1	11
20:15-20:30	22	3	25	12.0	2.1	1	130	27	157	17.2	1.1	11
20:30-20:45	16	3	19	15.8	1.6	0	127	20	147	13.6	1.1	3
20:45-21:00	17	0	17	0.0	1.4	0	126	19	145	13.1	1.0	4
1時間計	78	7	85	8.2	7.2	2	515	88	603	14.6	4.3	29
21:00-21:15	15	0	15	0.0	1.3	0	81	7	88	8.0	0.6	2
21:15-21:30	15	1	16	6.3	1.4	1	102	23	125	18.4	0.9	5
21:30-21:45	10	3	13	23.1	1.1	0	107	22	129	17.1	0.9	4
21:45-22:00	4	2	6	33.3	0.5	0	65	16	81	19.8	0.6	6
1時間計	44	6	50	12.0	4.3	1	355	68	423	16.1	3.0	17
22:00-22:15	8	0	8	0.0	0.7	1	82	17	99	17.2	0.7	4
22:15-22:30	4	1	5	20.0	0.4	0	133	43	176	24.4	1.3	5
22:30-22:45	6	1	7	14.3	0.6	0	122	28	150	18.7	1.1	5
22:45-23:00	7	1	8	12.5	0.7	0	152	35	187	18.7	1.3	5
1時間計	25	3	28	10.7	2.4	1	489	123	612	20.1	4.4	19

方向別自動車交通量調査表

調査地点：地域社会2 目黒交番前

調査年月日：令和元年 5月14日(火) 天候：雨のち曇り

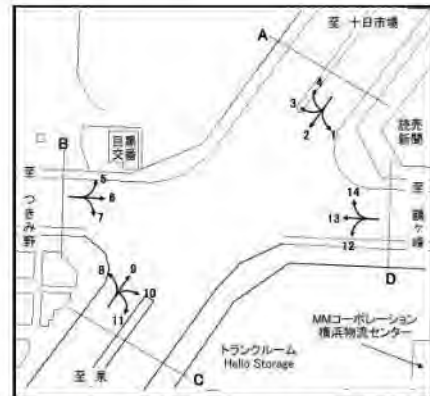

時間帯	種別	7						B 合計 (5+ 6+ 7)					
		小型車 (台)	大型車 (台)	合計 (台)	大型車混入率 (%)	時間係数 (%)	二輪車 (台)	小型車 (台)	大型車 (台)	合計 (台)	大型車混入率 (%)	時間係数 (%)	二輪車 (台)
23:00-23:15		11	1	12	8.3	1.0	0	64	25	89	28.1	0.6	3
23:15-23:30		6	3	9	33.3	0.8	0	28	17	45	37.8	0.3	0
23:30-23:45		9	1	10	10.0	0.9	0	47	17	64	26.6	0.5	6
23:45-24:00		4	4	8	50.0	0.7	1	32	22	54	40.7	0.4	2
1時間計		30	9	39	23.1	3.3	1	171	81	252	32.1	1.8	11
0:00-0:15		2	1	3	33.3	0.3	0	28	17	45	37.8	0.3	0
0:15-0:30		5	0	5	0.0	0.4	0	29	23	52	44.2	0.4	0
0:30-0:45		6	4	10	40.0	0.9	0	38	40	78	51.3	0.6	0
0:45-1:00		10	6	16	37.5	1.4	0	29	22	51	43.1	0.4	0
1時間計		23	11	34	32.4	2.9	0	124	102	226	45.1	1.6	0
1:00-1:15		6	2	8	25.0	0.7	1	27	29	56	51.8	0.4	1
1:15-1:30		2	1	3	33.3	0.3	0	31	24	55	43.6	0.4	0
1:30-1:45		1	2	3	66.7	0.3	1	20	17	37	45.9	0.3	2
1:45-2:00		2	0	2	0.0	0.2	0	20	11	31	35.5	0.2	0
1時間計		11	5	16	31.3	1.4	2	98	81	179	45.3	1.3	3
2:00-2:15		1	2	3	66.7	0.3	0	11	25	36	69.4	0.3	1
2:15-2:30		1	0	1	0.0	0.1	0	15	17	32	53.1	0.2	0
2:30-2:45		2	4	6	66.7	0.5	0	16	24	40	60.0	0.3	0
2:45-3:00		3	2	5	40.0	0.4	0	17	22	39	56.4	0.3	0
1時間計		7	8	15	53.3	1.3	0	59	88	147	59.9	1.1	1
3:00-3:15		4	2	6	33.3	0.5	0	36	32	68	47.1	0.5	0
3:15-3:30		1	1	2	50.0	0.2	0	16	17	33	51.5	0.2	0
3:30-3:45		0	0	0	0.0	0.0	0	18	22	40	55.0	0.3	0
3:45-4:00		6	1	7	14.3	0.6	0	38	32	70	45.7	0.5	2
1時間計		11	4	15	26.7	1.3	0	108	103	211	48.8	1.5	2
4:00-4:15		0	0	0	0.0	0.0	0	17	40	57	70.2	0.4	1
4:15-4:30		3	2	5	40.0	0.4	0	23	34	57	59.6	0.4	1
4:30-4:45		1	0	1	0.0	0.1	1	20	37	57	64.9	0.4	2
4:45-5:00		3	5	8	62.5	0.7	0	49	57	106	53.8	0.8	4
1時間計		7	7	14	50.0	1.2	1	109	168	277	60.6	2.0	8
5:00-5:15		0	2	2	100.0	0.2	1	59	59	118	50.0	0.8	3
5:15-5:30		6	4	10	40.0	0.9	0	123	78	201	38.8	1.4	11
5:30-5:45		1	5	6	83.3	0.5	0	121	52	173	30.1	1.2	7
5:45-6:00		4	4	8	50.0	0.7	0	130	66	196	33.7	1.4	6
1時間計		11	15	26	57.7	2.2	1	433	255	688	37.1	5.0	27
6:00-6:15		5	7	12	58.3	1.0	1	153	62	215	28.8	1.5	9
6:15-6:30		8	5	13	38.5	1.1	2	155	42	197	21.3	1.4	5
6:30-6:45		6	5	11	45.5	0.9	1	161	42	203	20.7	1.5	6
6:45-7:00		4	3	7	42.9	0.6	0	158	35	193	18.1	1.4	5
1時間計		23	20	43	46.5	3.7	4	627	181	808	22.4	5.8	25
夜12時間計		335	102	437	23.3	37.2	15	3654	1423	5077	28.0	36.5	172
全時間合計		883	293	1176	24.9	100.0	31	9806	4085	13891	29.4	100.0	434
昼夜率		1.61	1.53	1.59	-	-	1.94	1.59	1.53	1.58	-	-	1.66

方向別自動車交通量調査表

調査地点：地域社会2 目黒交番前

調査年月日：令和元年 5月14日(火) 天候：雨のち曇り

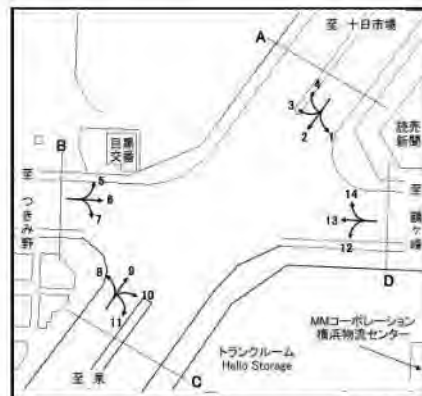

時間帯	8						9					
	小型車 (台)	大型車 (台)	合計 (台)	大型車混入率 (%)	時間係数 (%)	二輪車 (台)	小型車 (台)	大型車 (台)	合計 (台)	大型車混入率 (%)	時間係数 (%)	二輪車 (台)
7:00-7:15	6	1	7	14.3	0.8	1	85	10	95	10.5	2.4	7
7:15-7:30	12	0	12	0.0	1.3	1	81	6	87	6.9	2.2	4
7:30-7:45	14	6	20	30.0	2.2	3	85	7	92	7.6	2.3	10
7:45-8:00	5	3	8	37.5	0.9	1	78	7	85	8.2	2.1	9
1時間計	37	10	47	21.3	5.3	6	329	30	359	8.4	9.0	30
8:00-8:15	7	3	10	30.0	1.1	0	74	4	78	5.1	2.0	5
8:15-8:30	14	1	15	6.7	1.7	0	77	8	85	9.4	2.1	8
8:30-8:45	16	7	23	30.4	2.6	0	69	5	74	6.8	1.9	4
8:45-9:00	6	3	9	33.3	1.0	1	59	12	71	16.9	1.8	3
1時間計	43	14	57	24.6	6.4	1	279	29	308	9.4	7.7	20
9:00-9:15	13	8	21	38.1	2.4	0	75	15	90	16.7	2.3	0
9:15-9:30	10	9	19	47.4	2.1	0	52	11	63	17.5	1.6	1
9:30-9:45	8	3	11	27.3	1.2	0	53	7	60	11.7	1.5	1
9:45-10:00	8	4	12	33.3	1.3	0	44	6	50	12.0	1.3	0
1時間計	39	24	63	38.1	7.1	0	224	39	263	14.8	6.6	2
10:00-10:15	5	9	14	64.3	1.6	0	48	12	60	20.0	1.5	0
10:15-10:30	10	4	14	28.6	1.6	0	44	12	56	21.4	1.4	1
10:30-10:45	7	7	14	50.0	1.6	0	46	7	53	13.2	1.3	2
10:45-11:00	12	3	15	20.0	1.7	0	47	11	58	19.0	1.5	1
1時間計	34	23	57	40.4	6.4	0	185	42	227	18.5	5.7	4
11:00-11:15	10	3	13	23.1	1.5	0	41	8	49	16.3	1.2	1
11:15-11:30	5	2	7	28.6	0.8	0	33	13	46	28.3	1.2	2
11:30-11:45	5	6	11	54.5	1.2	0	58	9	67	13.4	1.7	2
11:45-12:00	9	3	12	25.0	1.3	0	54	4	58	6.9	1.5	1
1時間計	29	14	43	32.6	4.8	0	186	34	220	15.5	5.5	6
12:00-12:15	4	4	8	50.0	0.9	0	30	6	36	16.7	0.9	1
12:15-12:30	8	8	16	50.0	1.8	0	41	0	41	0.0	1.0	2
12:30-12:45	11	6	17	35.3	1.9	0	46	5	51	9.8	1.3	5
12:45-13:00	14	7	21	33.3	2.4	0	45	11	56	19.6	1.4	1
1時間計	37	25	62	40.3	7.0	0	162	22	184	12.0	4.6	9
13:00-13:15	12	6	18	33.3	2.0	0	44	9	53	17.0	1.3	2
13:15-13:30	14	9	23	39.1	2.6	0	50	7	57	12.3	1.4	1
13:30-13:45	11	2	13	15.4	1.5	0	42	2	44	4.5	1.1	2
13:45-14:00	6	3	9	33.3	1.0	0	32	7	39	17.9	1.0	0
1時間計	43	20	63	31.7	7.1	0	168	25	193	13.0	4.8	5
14:00-14:15	8	6	14	42.9	1.6	0	47	11	58	19.0	1.5	1
14:15-14:30	6	4	10	40.0	1.1	0	30	7	37	18.9	0.9	0
14:30-14:45	11	7	18	38.9	2.0	1	55	5	60	8.3	1.5	3
14:45-15:00	5	3	8	37.5	0.9	0	41	4	45	8.9	1.1	0
1時間計	30	20	50	40.0	5.6	1	173	27	200	13.5	5.0	4

方向別自動車交通量調査表

調査地点：地域社会2 目黒交番前

調査年月日：令和元年 5月14日(火) 天候：雨のち曇り

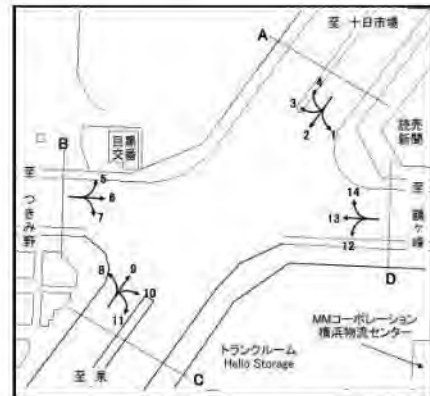

方向	8						9						
	種別	小型車 (台)	大型車 (台)	合計 (台)	大型車 混入率 (%)	時間 係数 (%)	二輪車 (台)	小型車 (台)	大型車 (台)	合計 (台)	大型車 混入率 (%)	時間 係数 (%)	二輪車 (台)
15:00-15:15		13	5	18	27.8	2.0	0	53	9	62	14.5	1.6	2
15:15-15:30		12	2	14	14.3	1.6	0	40	4	44	9.1	1.1	1
15:30-15:45		7	3	10	30.0	1.1	0	38	2	40	5.0	1.0	1
15:45-16:00		8	2	10	20.0	1.1	0	52	6	58	10.3	1.5	1
1時間計		40	12	52	23.1	5.8	0	183	21	204	10.3	5.1	5
16:00-16:15		14	2	16	12.5	1.8	0	47	5	52	9.6	1.3	2
16:15-16:30		9	5	14	35.7	1.6	0	45	2	47	4.3	1.2	3
16:30-16:45		10	3	13	23.1	1.5	2	38	3	41	7.3	1.0	2
16:45-17:00		9	2	11	18.2	1.2	0	51	7	58	12.1	1.5	0
1時間計		42	12	54	22.2	6.1	2	181	17	198	8.6	5.0	7
17:00-17:15		5	1	6	16.7	0.7	1	43	1	44	2.3	1.1	3
17:15-17:30		13	0	13	0.0	1.5	0	45	4	49	8.2	1.2	1
17:30-17:45		14	0	14	0.0	1.6	0	59	3	62	4.8	1.6	3
17:45-18:00		17	2	19	10.5	2.1	0	41	2	43	4.7	1.1	2
1時間計		49	3	52	5.8	5.8	1	188	10	198	5.1	5.0	9
18:00-18:15		12	1	13	7.7	1.5	0	45	2	47	4.3	1.2	0
18:15-18:30		7	2	9	22.2	1.0	0	48	5	53	9.4	1.3	2
18:30-18:45		14	5	19	26.3	2.1	0	57	0	57	0.0	1.4	1
18:45-19:00		10	2	12	16.7	1.3	0	58	1	59	1.7	1.5	4
1時間計		43	10	53	18.9	6.0	0	208	8	216	3.7	5.4	7
昼12時間計		466	187	653	28.6	73.4	11	2466	304	2770	11.0	69.4	108
19:00-19:15		18	3	21	14.3	2.4	1	53	0	53	0.0	1.3	4
19:15-19:30		15	0	15	0.0	1.7	0	49	2	51	3.9	1.3	1
19:30-19:45		8	0	8	0.0	0.9	0	42	0	42	0.0	1.1	0
19:45-20:00		8	0	8	0.0	0.9	0	38	1	39	2.6	1.0	1
1時間計		49	3	52	5.8	5.8	1	182	3	185	1.6	4.6	6
20:00-20:15		9	1	10	10.0	1.1	0	44	1	45	2.2	1.1	2
20:15-20:30		8	1	9	11.1	1.0	0	35	0	35	0.0	0.9	2
20:30-20:45		6	1	7	14.3	0.8	0	37	1	38	2.6	1.0	1
20:45-21:00		5	0	5	0.0	0.6	0	46	3	49	6.1	1.2	0
1時間計		28	3	31	9.7	3.5	0	162	5	167	3.0	4.2	5
21:00-21:15		6	1	7	14.3	0.8	0	25	0	25	0.0	0.6	1
21:15-21:30		2	3	5	60.0	0.6	0	29	2	31	6.5	0.8	2
21:30-21:45		3	1	4	25.0	0.4	0	10	0	10	0.0	0.3	1
21:45-22:00		6	0	6	0.0	0.7	0	20	1	21	4.8	0.5	1
1時間計		17	5	22	22.7	2.5	0	84	3	87	3.4	2.2	5
22:00-22:15		1	0	1	0.0	0.1	0	25	0	25	0.0	0.6	2
22:15-22:30		4	1	5	20.0	0.6	0	26	0	26	0.0	0.7	1
22:30-22:45		2	0	2	0.0	0.2	0	15	4	19	21.1	0.5	0
22:45-23:00		0	1	1	100.0	0.1	0	13	5	18	27.8	0.5	1
1時間計		7	2	9	22.2	1.0	0	79	9	88	10.2	2.2	4

方向別自動車交通量調査表

調査地点：地域社会2 目黒交番前

調査年月日：令和元年 5月14日(火) 天候：雨のち曇り

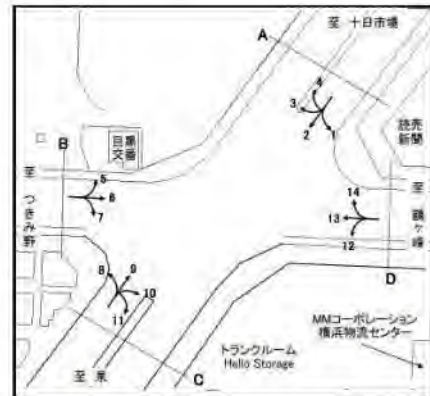

方向	8						9							
	種別	小型車 (台)	大型車 (台)	合計 (台)	大型車 混入率 (%)	時係 数 (%)	二輪車 (台)	種別	小型車 (台)	大型車 (台)	合計 (台)	大型車 混入率 (%)	時係 数 (%)	二輪車 (台)
23:00-23:15		4	3	7	42.9	0.8	0		12	4	16	25.0	0.4	0
23:15-23:30		0	0	0	0.0	0.0	0		6	0	6	0.0	0.2	0
23:30-23:45		2	2	4	50.0	0.4	0		7	0	7	0.0	0.2	0
23:45-24:00		1	0	1	0.0	0.1	0		2	3	5	60.0	0.1	0
1時間計		7	5	12	41.7	1.3	0		27	7	34	20.6	0.9	0
0:00-0:15		0	0	0	0.0	0.0	0		7	0	7	0.0	0.2	0
0:15-0:30		0	0	0	0.0	0.0	0		5	0	5	0.0	0.1	0
0:30-0:45		2	1	3	33.3	0.3	0		3	0	3	0.0	0.1	0
0:45-1:00		2	0	2	0.0	0.2	0		7	1	8	12.5	0.2	0
1時間計		4	1	5	20.0	0.6	0		22	1	23	4.3	0.6	0
1:00-1:15		2	3	5	60.0	0.6	0		6	1	7	14.3	0.2	0
1:15-1:30		2	0	2	0.0	0.2	1		3	0	3	0.0	0.1	0
1:30-1:45		1	0	1	0.0	0.1	0		3	1	4	25.0	0.1	0
1:45-2:00		0	0	0	0.0	0.0	0		4	4	8	50.0	0.2	0
1時間計		5	3	8	37.5	0.9	1		16	6	22	27.3	0.6	0
2:00-2:15		1	0	1	0.0	0.1	0		3	1	4	25.0	0.1	0
2:15-2:30		1	1	2	50.0	0.2	0		4	0	4	0.0	0.1	0
2:30-2:45		0	1	1	100.0	0.1	0		5	1	6	16.7	0.2	0
2:45-3:00		1	1	2	50.0	0.2	0		0	2	2	100.0	0.1	0
1時間計		3	3	6	50.0	0.7	0		12	4	16	25.0	0.4	0
3:00-3:15		0	4	4	100.0	0.4	0		2	1	3	33.3	0.1	0
3:15-3:30		0	1	1	100.0	0.1	0		6	3	9	33.3	0.2	0
3:30-3:45		0	1	1	100.0	0.1	0		4	1	5	20.0	0.1	0
3:45-4:00		1	1	2	50.0	0.2	0		8	1	9	11.1	0.2	0
1時間計		1	7	8	87.5	0.9	0		20	6	26	23.1	0.7	0
4:00-4:15		0	4	4	100.0	0.4	0		6	1	7	14.3	0.2	2
4:15-4:30		0	2	2	100.0	0.2	0		7	2	9	22.2	0.2	1
4:30-4:45		2	1	3	33.3	0.3	0		2	1	3	33.3	0.1	2
4:45-5:00		3	1	4	25.0	0.4	0		8	4	12	33.3	0.3	1
1時間計		5	8	13	61.5	1.5	0		23	8	31	25.8	0.8	6
5:00-5:15		1	2	3	66.7	0.3	0		19	11	30	36.7	0.8	1
5:15-5:30		1	3	4	75.0	0.4	0		31	3	34	8.8	0.9	3
5:30-5:45		6	1	7	14.3	0.8	0		41	4	45	8.9	1.1	2
5:45-6:00		7	4	11	36.4	1.2	1		60	10	70	14.3	1.8	0
1時間計		15	10	25	40.0	2.8	1		151	28	179	15.6	4.5	6
6:00-6:15		4	4	8	50.0	0.9	1		67	9	76	11.8	1.9	3
6:15-6:30		10	4	14	28.6	1.6	0		69	18	87	20.7	2.2	5
6:30-6:45		8	3	11	27.3	1.2	0		82	17	99	17.2	2.5	5
6:45-7:00		9	4	13	30.8	1.5	1		93	9	102	8.8	2.6	6
1時間計		31	15	46	32.6	5.2	2		311	53	364	14.6	9.1	19
夜12時間計		172	65	237	27.4	26.6	5		1089	133	1222	10.9	30.6	51
全時間合計		638	252	890	28.3	100.0	16		3555	437	3992	10.9	100.0	159
昼夜率		1.37	1.35	1.36	-	-	1.45		1.44	1.44	1.44	-	-	1.47

方向別自動車交通量調査表

調査地点：地域社会2 目黒交番前

調査年月日：令和元年 5月14日(火) 天候：雨のち曇り

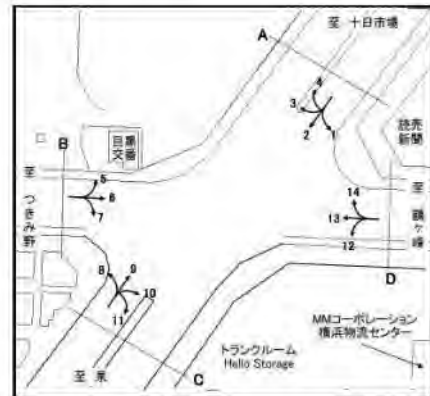

方向	10						11						
	種別	小型車 (台)	大型車 (台)	合計 (台)	大型車 混入率 (%)	時間 係数 (%)	二輪車 (台)	小型車 (台)	大型車 (台)	合計 (台)	大型車 混入率 (%)	時間 係数 (%)	二輪車 (台)
7:00-7:15		30	3	33	9.1	2.0	4	0	0	0	0.0	0.0	0
7:15-7:30		18	3	21	14.3	1.3	2	0	0	0	0.0	0.0	0
7:30-7:45		24	6	30	20.0	1.8	3	0	0	0	0.0	0.0	0
7:45-8:00		38	1	39	2.6	2.4	0	0	0	0	0.0	0.0	0
1時間計		110	13	123	10.6	7.5	9	0	0	0	0.0	0.0	0
8:00-8:15		22	3	25	12.0	1.5	2	0	0	0	0.0	0.0	0
8:15-8:30		34	3	37	8.1	2.3	1	0	0	0	0.0	0.0	0
8:30-8:45		40	0	40	0.0	2.4	0	0	0	0	0.0	0.0	0
8:45-9:00		36	2	38	5.3	2.3	2	0	0	0	0.0	0.0	0
1時間計		132	8	140	5.7	8.5	5	0	0	0	0.0	0.0	0
9:00-9:15		26	7	33	21.2	2.0	1	0	0	0	0.0	0.0	0
9:15-9:30		15	6	21	28.6	1.3	0	0	1	1	100.0	33.3	0
9:30-9:45		24	4	28	14.3	1.7	1	0	0	0	0.0	0.0	0
9:45-10:00		24	4	28	14.3	1.7	0	0	0	0	0.0	0.0	0
1時間計		89	21	110	19.1	6.7	2	0	1	1	100.0	33.3	0
10:00-10:15		17	4	21	19.0	1.3	0	0	0	0	0.0	0.0	0
10:15-10:30		21	5	26	19.2	1.6	0	0	0	0	0.0	0.0	0
10:30-10:45		21	6	27	22.2	1.6	0	0	0	0	0.0	0.0	0
10:45-11:00		25	3	28	10.7	1.7	0	0	0	0	0.0	0.0	0
1時間計		84	18	102	17.6	6.2	0	0	0	0	0.0	0.0	0
11:00-11:15		7	3	10	30.0	0.6	1	0	0	0	0.0	0.0	0
11:15-11:30		12	7	19	36.8	1.2	0	0	0	0	0.0	0.0	0
11:30-11:45		10	2	12	16.7	0.7	0	0	0	0	0.0	0.0	0
11:45-12:00		25	8	33	24.2	2.0	2	0	0	0	0.0	0.0	0
1時間計		54	20	74	27.0	4.5	3	0	0	0	0.0	0.0	0
12:00-12:15		13	0	13	0.0	0.8	0	0	0	0	0.0	0.0	0
12:15-12:30		18	4	22	18.2	1.3	1	0	0	0	0.0	0.0	0
12:30-12:45		13	6	19	31.6	1.2	0	0	0	0	0.0	0.0	0
12:45-13:00		18	4	22	18.2	1.3	0	0	0	0	0.0	0.0	0
1時間計		62	14	76	18.4	4.6	1	0	0	0	0.0	0.0	0
13:00-13:15		17	3	20	15.0	1.2	0	0	0	0	0.0	0.0	0
13:15-13:30		22	0	22	0.0	1.3	3	0	0	0	0.0	0.0	0
13:30-13:45		23	4	27	14.8	1.6	0	0	0	0	0.0	0.0	0
13:45-14:00		22	3	25	12.0	1.5	0	0	0	0	0.0	0.0	0
1時間計		84	10	94	10.6	5.7	3	0	0	0	0.0	0.0	0
14:00-14:15		19	5	24	20.8	1.5	0	0	0	0	0.0	0.0	1
14:15-14:30		15	4	19	21.1	1.2	0	0	0	0	0.0	0.0	0
14:30-14:45		17	3	20	15.0	1.2	0	0	0	0	0.0	0.0	0
14:45-15:00		22	6	28	21.4	1.7	0	0	0	0	0.0	0.0	0
1時間計		73	18	91	19.8	5.5	0	0	0	0	0.0	0.0	1

方向別自動車交通量調査表

調査地点：地域社会2 目黒交番前

調査年月日：令和元年 5月14日(火) 天候：雨のち曇り

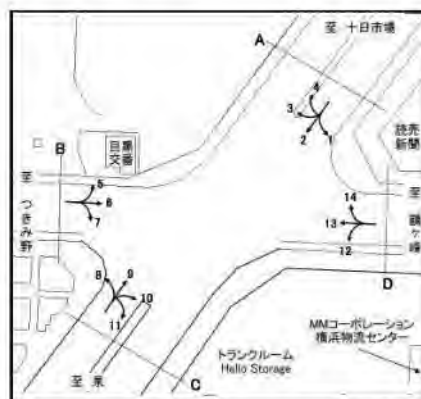

方向	10						11						
	種別	小型車 (台)	大型車 (台)	合計 (台)	大型車 混入率 (%)	時間 係数 (%)	二輪車 (台)	小型車 (台)	大型車 (台)	合計 (台)	大型車 混入率 (%)	時間 係数 (%)	二輪車 (台)
15:00-15:15		18	8	26	30.8	1.6	1	0	0	0	0.0	0.0	0
15:15-15:30		24	4	28	14.3	1.7	0	0	0	0	0.0	0.0	0
15:30-15:45		17	3	20	15.0	1.2	0	0	0	0	0.0	0.0	0
15:45-16:00		21	4	25	16.0	1.5	0	0	0	0	0.0	0.0	0
1時間計		80	19	99	19.2	6.0	1	0	0	0	0.0	0.0	0
16:00-16:15		14	3	17	17.6	1.0	0	0	0	0	0.0	0.0	0
16:15-16:30		21	6	27	22.2	1.6	0	0	0	0	0.0	0.0	0
16:30-16:45		12	4	16	25.0	1.0	0	0	0	0	0.0	0.0	0
16:45-17:00		19	4	23	17.4	1.4	2	0	0	0	0.0	0.0	0
1時間計		66	17	83	20.5	5.0	2	0	0	0	0.0	0.0	0
17:00-17:15		12	6	18	33.3	1.1	0	0	0	0	0.0	0.0	0
17:15-17:30		26	5	31	16.1	1.9	2	0	0	0	0.0	0.0	0
17:30-17:45		27	5	32	15.6	1.9	0	0	0	0	0.0	0.0	0
17:45-18:00		12	5	17	29.4	1.0	1	0	0	0	0.0	0.0	0
1時間計		77	21	98	21.4	6.0	3	0	0	0	0.0	0.0	0
18:00-18:15		10	0	10	0.0	0.6	2	0	0	0	0.0	0.0	0
18:15-18:30		11	0	11	0.0	0.7	0	0	0	0	0.0	0.0	0
18:30-18:45		8	1	9	11.1	0.5	1	0	0	0	0.0	0.0	0
18:45-19:00		17	1	18	5.6	1.1	2	0	0	0	0.0	0.0	0
1時間計		46	2	48	4.2	2.9	5	0	0	0	0.0	0.0	0
昼12時間計		957	181	1138	15.9	69.2	34	0	1	1	100.0	33.3	1
19:00-19:15		16	0	16	0.0	1.0	4	0	0	0	0.0	0.0	0
19:15-19:30		20	3	23	13.0	1.4	3	0	0	0	0.0	0.0	0
19:30-19:45		9	0	9	0.0	0.5	0	0	0	0	0.0	0.0	0
19:45-20:00		4	0	4	0.0	0.2	0	0	0	0	0.0	0.0	0
1時間計		49	3	52	5.8	3.2	7	0	0	0	0.0	0.0	0
20:00-20:15		10	1	11	9.1	0.7	0	0	0	0	0.0	0.0	0
20:15-20:30		9	1	10	10.0	0.6	1	0	0	0	0.0	0.0	0
20:30-20:45		5	1	6	16.7	0.4	0	0	0	0	0.0	0.0	0
20:45-21:00		7	1	8	12.5	0.5	1	0	0	0	0.0	0.0	0
1時間計		31	4	35	11.4	2.1	2	0	0	0	0.0	0.0	0
21:00-21:15		11	0	11	0.0	0.7	0	0	0	0	0.0	0.0	0
21:15-21:30		9	0	9	0.0	0.5	1	0	0	0	0.0	0.0	0
21:30-21:45		7	0	7	0.0	0.4	0	0	0	0	0.0	0.0	0
21:45-22:00		13	2	15	13.3	0.9	1	0	0	0	0.0	0.0	0
1時間計		40	2	42	4.8	2.6	2	0	0	0	0.0	0.0	0
22:00-22:15		7	0	7	0.0	0.4	0	0	0	0	0.0	0.0	0
22:15-22:30		12	0	12	0.0	0.7	0	0	0	0	0.0	0.0	0
22:30-22:45		3	1	4	25.0	0.2	1	1	0	1	0.0	33.3	0
22:45-23:00		7	3	10	30.0	0.6	0	0	0	0	0.0	0.0	0
1時間計		29	4	33	12.1	2.0	1	1	0	1	0.0	33.3	0

方向別自動車交通量調査表

調査地点：地域社会2 目黒交番前

調査年月日：令和元年 5月14日(火) 天候：雨のち曇り

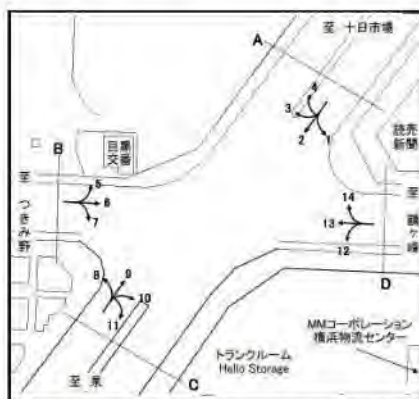

方向	10						11						
	種別	小型車 (台)	大型車 (台)	合計 (台)	大型車 混入率 (%)	時間 係数 (%)	二輪車 (台)	小型車 (台)	大型車 (台)	合計 (台)	大型車 混入率 (%)	時間 係数 (%)	二輪車 (台)
23:00-23:15		6	2	8	25.0	0.5	0	0	0	0	0.0	0.0	0
23:15-23:30		6	0	6	0.0	0.4	0	0	0	0	0.0	0.0	0
23:30-23:45		1	1	2	50.0	0.1	0	0	0	0	0.0	0.0	0
23:45-24:00		3	0	3	0.0	0.2	1	0	0	0	0.0	0.0	0
1時間計		16	3	19	15.8	1.2	1	0	0	0	0.0	0.0	0
0:00-0:15		0	0	0	0.0	0.0	0	0	0	0	0.0	0.0	0
0:15-0:30		4	1	5	20.0	0.3	0	0	0	0	0.0	0.0	0
0:30-0:45		3	0	3	0.0	0.2	0	0	0	0	0.0	0.0	0
0:45-1:00		0	0	0	0.0	0.0	0	0	0	0	0.0	0.0	0
1時間計		7	1	8	12.5	0.5	0	0	0	0	0.0	0.0	0
1:00-1:15		7	2	9	22.2	0.5	1	0	0	0	0.0	0.0	0
1:15-1:30		2	1	3	33.3	0.2	0	0	0	0	0.0	0.0	0
1:30-1:45		2	0	2	0.0	0.1	0	0	0	0	0.0	0.0	0
1:45-2:00		6	1	7	14.3	0.4	0	0	0	0	0.0	0.0	0
1時間計		17	4	21	19.0	1.3	1	0	0	0	0.0	0.0	0
2:00-2:15		2	0	2	0.0	0.1	0	0	0	0	0.0	0.0	0
2:15-2:30		2	1	3	33.3	0.2	0	0	0	0	0.0	0.0	0
2:30-2:45		2	0	2	0.0	0.1	0	0	0	0	0.0	0.0	0
2:45-3:00		1	2	3	66.7	0.2	0	0	0	0	0.0	0.0	0
1時間計		7	3	10	30.0	0.6	0	0	0	0	0.0	0.0	0
3:00-3:15		0	0	0	0.0	0.0	1	0	0	0	0.0	0.0	0
3:15-3:30		2	1	3	33.3	0.2	0	0	0	0	0.0	0.0	0
3:30-3:45		3	0	3	0.0	0.2	0	0	0	0	0.0	0.0	0
3:45-4:00		6	0	6	0.0	0.4	1	0	0	0	0.0	0.0	0
1時間計		11	1	12	8.3	0.7	2	0	0	0	0.0	0.0	0
4:00-4:15		3	0	3	0.0	0.2	0	0	0	0	0.0	0.0	0
4:15-4:30		4	1	5	20.0	0.3	0	0	0	0	0.0	0.0	0
4:30-4:45		4	0	4	0.0	0.2	1	0	0	0	0.0	0.0	0
4:45-5:00		11	4	15	26.7	0.9	0	0	0	0	0.0	0.0	0
1時間計		22	5	27	18.5	1.6	1	0	0	0	0.0	0.0	0
5:00-5:15		12	2	14	14.3	0.9	3	0	0	0	0.0	0.0	0
5:15-5:30		18	2	20	10.0	1.2	3	0	0	0	0.0	0.0	0
5:30-5:45		21	1	22	4.5	1.3	3	0	0	0	0.0	0.0	0
5:45-6:00		44	5	49	10.2	3.0	1	0	0	0	0.0	0.0	0
1時間計		95	10	105	9.5	6.4	10	0	0	0	0.0	0.0	0
6:00-6:15		23	5	28	17.9	1.7	0	1	0	1	0.0	33.3	0
6:15-6:30		34	14	48	29.2	2.9	3	0	0	0	0.0	0.0	0
6:30-6:45		32	2	34	5.9	2.1	2	0	0	0	0.0	0.0	0
6:45-7:00		26	6	32	18.8	1.9	6	0	0	0	0.0	0.0	0
1時間計		115	27	142	19.0	8.6	11	1	0	1	0.0	33.3	0
夜12時間計		439	67	506	13.2	30.8	38	2	0	2	0.0	66.7	0
全時間合計		1396	248	1644	15.1	100.0	72	2	1	3	33.3	100.0	1
昼夜率		1.46	1.37	1.44	-	-	2.12	0.00	1.00	3.00	-	-	1.00

方向別自動車交通量調査表

調査地点：地域社会2 目黒交番前

調査年月日：令和元年 5月14日(火) 天候：雨のち曇り

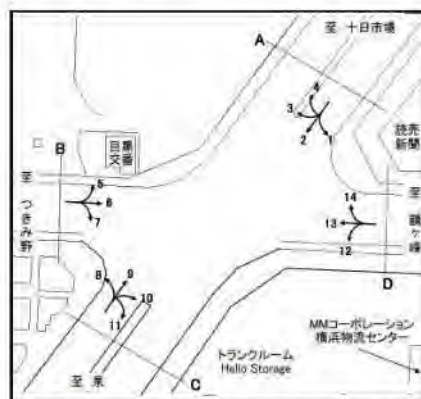

方向 時間帯	種別						C 合計 (8+9+10+11)					
		小型車 (台)	大型車 (台)	合計 (台)	大型車 混入率 (%)	時間 係数 (%)	二輪車 (台)	小型車 (台)	大型車 (台)	合計 (台)	大型車 混入率 (%)	時間 係数 (%)
7:00-7:15							121	14	135	10.4	2.1	12
7:15-7:30							111	9	120	7.5	1.8	7
7:30-7:45							123	19	142	13.4	2.2	16
7:45-8:00							121	11	132	8.3	2.0	10
1時間計							476	53	529	10.0	8.1	45
8:00-8:15							103	10	113	8.8	1.7	7
8:15-8:30							125	12	137	8.8	2.1	9
8:30-8:45							125	12	137	8.8	2.1	4
8:45-9:00							101	17	118	14.4	1.8	6
1時間計							454	51	505	10.1	7.7	26
9:00-9:15							114	30	144	20.8	2.2	1
9:15-9:30							77	27	104	26.0	1.6	1
9:30-9:45							85	14	99	14.1	1.5	2
9:45-10:00							76	14	90	15.6	1.4	0
1時間計							352	85	437	19.5	6.7	4
10:00-10:15							70	25	95	26.3	1.5	0
10:15-10:30							75	21	96	21.9	1.5	1
10:30-10:45							74	20	94	21.3	1.4	2
10:45-11:00							84	17	101	16.8	1.5	1
1時間計							303	83	386	21.5	5.9	4
11:00-11:15							58	14	72	19.4	1.1	2
11:15-11:30							50	22	72	30.6	1.1	2
11:30-11:45							73	17	90	18.9	1.4	2
11:45-12:00							88	15	103	14.6	1.6	3
1時間計							269	68	337	20.2	5.2	9
12:00-12:15							47	10	57	17.5	0.9	1
12:15-12:30							67	12	79	15.2	1.2	3
12:30-12:45							70	17	87	19.5	1.3	5
12:45-13:00							77	22	99	22.2	1.5	1
1時間計							261	61	322	18.9	4.9	10
13:00-13:15							73	18	91	19.8	1.4	2
13:15-13:30							86	16	102	15.7	1.6	4
13:30-13:45							76	8	84	9.5	1.3	2
13:45-14:00							60	13	73	17.8	1.1	0
1時間計							295	55	350	15.7	5.4	8
14:00-14:15							74	22	96	22.9	1.5	2
14:15-14:30							51	15	66	22.7	1.0	0
14:30-14:45							83	15	98	15.3	1.5	4
14:45-15:00							68	13	81	16.0	1.2	0
1時間計							276	65	341	19.1	5.2	6

方向別自動車交通量調査表

調査地点：地域社会2 目黒交番前

調査年月日：令和元年 5月14日(火) 天候：雨のち曇り

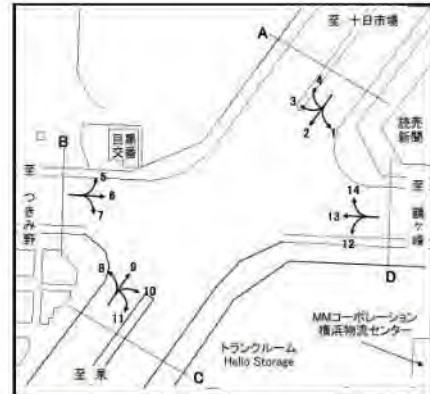

方向 時間帯							C 合計 (8+9+10+11)					
	種別 小型車 (台)	大型車 (台)	合計 (台)	大型車 混入率 (%)	時間 係数 (%)	二輪車 (台)	小型車 (台)	大型車 (台)	合計 (台)	大型車 混入率 (%)	時間 係数 (%)	二輪車 (台)
15:00-15:15							84	22	106	20.8	1.6	3
15:15-15:30							76	10	86	11.6	1.3	1
15:30-15:45							62	8	70	11.4	1.1	1
15:45-16:00							81	12	93	12.9	1.4	1
1時間計							303	52	355	14.6	5.4	6
16:00-16:15							75	10	85	11.8	1.3	2
16:15-16:30							75	13	88	14.8	1.3	3
16:30-16:45							60	10	70	14.3	1.1	4
16:45-17:00							79	13	92	14.1	1.4	2
1時間計							289	46	335	13.7	5.1	11
17:00-17:15							60	8	68	11.8	1.0	4
17:15-17:30							84	9	93	9.7	1.4	3
17:30-17:45							100	8	108	7.4	1.7	3
17:45-18:00							70	9	79	11.4	1.2	3
1時間計							314	34	348	9.8	5.3	13
18:00-18:15							67	3	70	4.3	1.1	2
18:15-18:30							66	7	73	9.6	1.1	2
18:30-18:45							79	6	85	7.1	1.3	2
18:45-19:00							85	4	89	4.5	1.4	6
1時間計							297	20	317	6.3	4.9	12
昼12時間計							3889	673	4562	14.8	69.9	154
19:00-19:15							87	3	90	3.3	1.4	9
19:15-19:30							84	5	89	5.6	1.4	4
19:30-19:45							59	0	59	0.0	0.9	0
19:45-20:00							50	1	51	2.0	0.8	1
1時間計							280	9	289	3.1	4.4	14
20:00-20:15							63	3	66	4.5	1.0	2
20:15-20:30							52	2	54	3.7	0.8	3
20:30-20:45							48	3	51	5.9	0.8	1
20:45-21:00							58	4	62	6.5	0.9	1
1時間計							221	12	233	5.2	3.6	7
21:00-21:15							42	1	43	2.3	0.7	1
21:15-21:30							40	5	45	11.1	0.7	3
21:30-21:45							20	1	21	4.8	0.3	1
21:45-22:00							39	3	42	7.1	0.6	2
1時間計							141	10	151	6.6	2.3	7
22:00-22:15							33	0	33	0.0	0.5	2
22:15-22:30							42	1	43	2.3	0.7	1
22:30-22:45							21	5	26	19.2	0.4	1
22:45-23:00							20	9	29	31.0	0.4	1
1時間計							116	15	131	11.5	2.0	5

方向別自動車交通量調査表

調査地点：地域社会2 目黒交番前

調査年月日：令和元年 5月14日(火) 天候：雨のち曇り

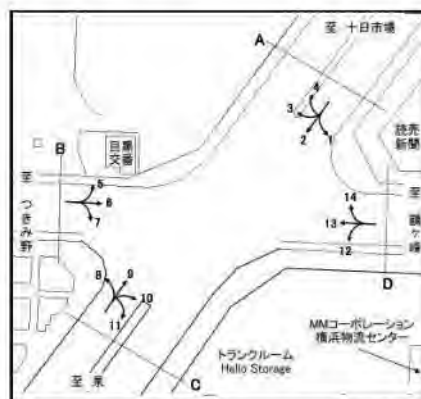

方向							C 合計 (8+9+10+11)					
	種別	小型車 (台)	大型車 (台)	合計 (台)	大型車 混入率 (%)	時間 係数 (%)	二輪車 (台)	小型車 (台)	大型車 (台)	合計 (台)	大型車 混入率 (%)	時間 係数 (%)
23:00-23:15							22	9	31	29.0	0.5	0
23:15-23:30							12	0	12	0.0	0.2	0
23:30-23:45							10	3	13	23.1	0.2	0
23:45-24:00							6	3	9	33.3	0.1	1
1 時間計							50	15	65	23.1	1.0	1
0:00-0:15							7	0	7	0.0	0.1	0
0:15-0:30							9	1	10	10.0	0.2	0
0:30-0:45							8	1	9	11.1	0.1	0
0:45-1:00							9	1	10	10.0	0.2	0
1 時間計							33	3	36	8.3	0.6	0
1:00-1:15							15	6	21	28.6	0.3	1
1:15-1:30							7	1	8	12.5	0.1	1
1:30-1:45							6	1	7	14.3	0.1	0
1:45-2:00							10	5	15	33.3	0.2	0
1 時間計							38	13	51	25.5	0.8	2
2:00-2:15							6	1	7	14.3	0.1	0
2:15-2:30							7	2	9	22.2	0.1	0
2:30-2:45							7	2	9	22.2	0.1	0
2:45-3:00							2	5	7	71.4	0.1	0
1 時間計							22	10	32	31.3	0.5	0
3:00-3:15							2	5	7	71.4	0.1	1
3:15-3:30							8	5	13	38.5	0.2	0
3:30-3:45							7	2	9	22.2	0.1	0
3:45-4:00							15	2	17	11.8	0.3	1
1 時間計							32	14	46	30.4	0.7	2
4:00-4:15							9	5	14	35.7	0.2	2
4:15-4:30							11	5	16	31.3	0.2	1
4:30-4:45							8	2	10	20.0	0.2	3
4:45-5:00							22	9	31	29.0	0.5	1
1 時間計							50	21	71	29.6	1.1	7
5:00-5:15							32	15	47	31.9	0.7	4
5:15-5:30							50	8	58	13.8	0.9	6
5:30-5:45							68	6	74	8.1	1.1	5
5:45-6:00							111	19	130	14.6	2.0	2
1 時間計							261	48	309	15.5	4.7	17
6:00-6:15							95	18	113	15.9	1.7	4
6:15-6:30							113	36	149	24.2	2.3	8
6:30-6:45							122	22	144	15.3	2.2	7
6:45-7:00							128	19	147	12.9	2.3	13
1 時間計							458	95	553	17.2	8.5	32
夜12時間計							1702	265	1967	13.5	30.1	94
全時間合計							5591	938	6529	14.4	100.0	248
昼夜率							1.44	1.39	1.43	-	-	1.61

方向別自動車交通量調査表

調査地点：地域社会2 目黒交番前

調査年月日：令和元年 5月14日(火) 天候：雨のち曇り

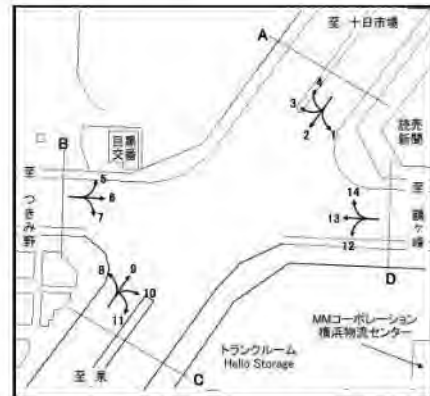

方向	12						13						
	種別	小型車 (台)	大型車 (台)	合計 (台)	大型車 混入率 (%)	時 間 係 数 (%)	二輪車 (台)	小型車 (台)	大型車 (台)	合計 (台)	大型車 混入率 (%)	時 間 係 数 (%)	二輪車 (台)
7:00-7:15		6	2	8	25.0	0.7	1	83	39	122	32.0	1.1	8
7:15-7:30		6	4	10	40.0	0.8	3	117	48	165	29.1	1.5	10
7:30-7:45		5	3	8	37.5	0.7	0	95	48	143	33.6	1.3	13
7:45-8:00		11	2	13	15.4	1.1	0	102	39	141	27.7	1.3	11
1時間計		28	11	39	28.2	3.3	4	397	174	571	30.5	5.3	42
8:00-8:15		17	4	21	19.0	1.8	0	84	41	125	32.8	1.2	7
8:15-8:30		15	1	16	6.3	1.3	1	88	36	124	29.0	1.1	7
8:30-8:45		16	4	20	20.0	1.7	1	82	50	132	37.9	1.2	3
8:45-9:00		11	5	16	31.3	1.3	3	105	54	159	34.0	1.5	8
1時間計		59	14	73	19.2	6.1	5	359	181	540	33.5	5.0	25
9:00-9:15		9	1	10	10.0	0.8	0	95	53	148	35.8	1.4	4
9:15-9:30		8	3	11	27.3	0.9	0	84	48	132	36.4	1.2	2
9:30-9:45		13	4	17	23.5	1.4	0	72	61	133	45.9	1.2	3
9:45-10:00		11	4	15	26.7	1.3	1	83	53	136	39.0	1.3	1
1時間計		41	12	53	22.6	4.5	1	334	215	549	39.2	5.1	10
10:00-10:15		16	2	18	11.1	1.5	0	98	72	170	42.4	1.6	5
10:15-10:30		15	4	19	21.1	1.6	0	88	56	144	38.9	1.3	1
10:30-10:45		17	2	19	10.5	1.6	0	81	65	146	44.5	1.4	1
10:45-11:00		16	2	18	11.1	1.5	0	96	47	143	32.9	1.3	6
1時間計		64	10	74	13.5	6.2	0	363	240	603	39.8	5.6	13
11:00-11:15		10	4	14	28.6	1.2	0	82	47	129	36.4	1.2	1
11:15-11:30		15	0	15	0.0	1.3	0	101	72	173	41.6	1.6	4
11:30-11:45		17	5	22	22.7	1.9	0	57	61	118	51.7	1.1	3
11:45-12:00		7	2	9	22.2	0.8	0	73	66	139	47.5	1.3	1
1時間計		49	11	60	18.3	5.0	0	313	246	559	44.0	5.2	9
12:00-12:15		16	3	19	15.8	1.6	0	92	64	156	41.0	1.4	0
12:15-12:30		7	3	10	30.0	0.8	0	70	65	135	48.1	1.2	2
12:30-12:45		12	2	14	14.3	1.2	0	87	46	133	34.6	1.2	5
12:45-13:00		9	4	13	30.8	1.1	0	83	52	135	38.5	1.2	1
1時間計		44	12	56	21.4	4.7	0	332	227	559	40.6	5.2	8
13:00-13:15		13	2	15	13.3	1.3	1	78	47	125	37.6	1.2	1
13:15-13:30		12	3	15	20.0	1.3	1	76	53	129	41.1	1.2	0
13:30-13:45		21	5	26	19.2	2.2	0	96	57	153	37.3	1.4	1
13:45-14:00		21	2	23	8.7	1.9	1	71	47	118	39.8	1.1	2
1時間計		67	12	79	15.2	6.6	3	321	204	525	38.9	4.9	4
14:00-14:15		17	2	19	10.5	1.6	1	101	58	159	36.5	1.5	2
14:15-14:30		12	5	17	29.4	1.4	0	77	48	125	38.4	1.2	2
14:30-14:45		16	5	21	23.8	1.8	1	82	66	148	44.6	1.4	8
14:45-15:00		21	3	24	12.5	2.0	1	84	59	143	41.3	1.3	1
1時間計		66	15	81	18.5	6.8	3	344	231	575	40.2	5.3	13

方向別自動車交通量調査表

調査地点：地域社会2 目黒交番前

調査年月日：令和元年 5月14日(火) 天候：雨のち曇り

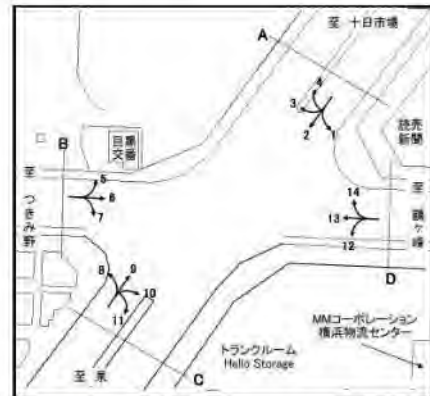

方向 時間帯	12						13					
	種別 小型車 (台)	大型車 (台)	合計 (台)	大型車 混入率 (%)	時係 数 (%)	二輪車 (台)	小型車 (台)	大型車 (台)	合計 (台)	大型車 混入率 (%)	時係 数 (%)	二輪車 (台)
15:00-15:15	15	2	17	11.8	1.4	1	83	52	135	38.5	1.2	4
15:15-15:30	10	1	11	9.1	0.9	0	80	53	133	39.8	1.2	5
15:30-15:45	15	3	18	16.7	1.5	0	104	52	156	33.3	1.4	3
15:45-16:00	21	2	23	8.7	1.9	0	84	46	130	35.4	1.2	0
1時間計	61	8	69	11.6	5.8	1	351	203	554	36.6	5.1	12
16:00-16:15	13	0	13	0.0	1.1	0	106	53	159	33.3	1.5	2
16:15-16:30	9	3	12	25.0	1.0	4	93	60	153	39.2	1.4	3
16:30-16:45	11	5	16	31.3	1.3	1	98	56	154	36.4	1.4	4
16:45-17:00	11	1	12	8.3	1.0	0	116	45	161	28.0	1.5	6
1時間計	44	9	53	17.0	4.5	5	413	214	627	34.1	5.8	15
17:00-17:15	30	0	30	0.0	2.5	2	144	44	188	23.4	1.7	11
17:15-17:30	19	0	19	0.0	1.6	1	140	19	159	11.9	1.5	2
17:30-17:45	20	3	23	13.0	1.9	2	125	34	159	21.4	1.5	9
17:45-18:00	15	1	16	6.3	1.3	5	151	40	191	20.9	1.8	13
1時間計	84	4	88	4.5	7.4	10	560	137	697	19.7	6.4	35
18:00-18:15	16	0	16	0.0	1.3	5	138	28	166	16.9	1.5	13
18:15-18:30	22	1	23	4.3	1.9	1	118	30	148	20.3	1.4	9
18:30-18:45	22	0	22	0.0	1.9	0	140	23	163	14.1	1.5	5
18:45-19:00	14	0	14	0.0	1.2	1	141	20	161	12.4	1.5	8
1時間計	74	1	75	1.3	6.3	7	537	101	638	15.8	5.9	35
昼12時間計	681	119	800	14.9	67.3	39	4624	2373	6997	33.9	64.7	221
19:00-19:15	20	2	22	9.1	1.9	2	123	24	147	16.3	1.4	10
19:15-19:30	13	1	14	7.1	1.2	2	120	14	134	10.4	1.2	2
19:30-19:45	17	1	18	5.6	1.5	1	110	21	131	16.0	1.2	10
19:45-20:00	13	1	14	7.1	1.2	1	106	15	121	12.4	1.1	4
1時間計	63	5	68	7.4	5.7	6	459	74	533	13.9	4.9	26
20:00-20:15	16	1	17	5.9	1.4	1	100	18	118	15.3	1.1	5
20:15-20:30	20	0	20	0.0	1.7	2	101	15	116	12.9	1.1	3
20:30-20:45	16	0	16	0.0	1.3	0	94	15	109	13.8	1.0	3
20:45-21:00	7	0	7	0.0	0.6	0	74	25	99	25.3	0.9	6
1時間計	59	1	60	1.7	5.0	3	369	73	442	16.5	4.1	17
21:00-21:15	13	1	14	7.1	1.2	0	71	30	101	29.7	0.9	6
21:15-21:30	11	3	14	21.4	1.2	0	67	29	96	30.2	0.9	4
21:30-21:45	13	2	15	13.3	1.3	1	58	30	88	34.1	0.8	2
21:45-22:00	6	1	7	14.3	0.6	0	48	20	68	29.4	0.6	2
1時間計	43	7	50	14.0	4.2	1	244	109	353	30.9	3.3	14
22:00-22:15	8	3	11	27.3	0.9	0	56	22	78	28.2	0.7	2
22:15-22:30	12	6	18	33.3	1.5	0	48	16	64	25.0	0.6	2
22:30-22:45	10	3	13	23.1	1.1	0	46	18	64	28.1	0.6	1
22:45-23:00	13	1	14	7.1	1.2	0	44	30	74	40.5	0.7	3
1時間計	43	13	56	23.2	4.7	0	194	86	280	30.7	2.6	8

方向別自動車交通量調査表

調査地点：地域社会2 目黒交番前

調査年月日：令和元年 5月14日(火) 天候：雨のち曇り

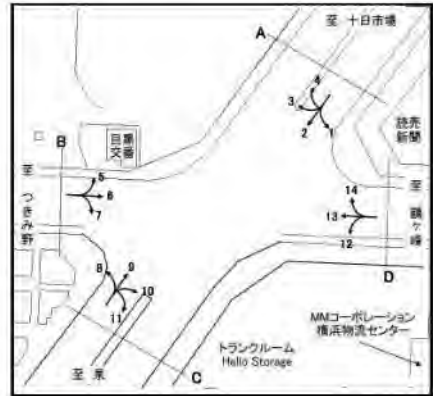

方向 時間帯	12						13					
	小型車 (台)	大型車 (台)	合計 (台)	大型車 混入率 (%)	時係 数 (%)	二輪車 (台)	小型車 (台)	大型車 (台)	合計 (台)	大型車 混入率 (%)	時係 数 (%)	二輪車 (台)
23:00-23:15	2	5	7	71.4	0.6	0	46	18	64	28.1	0.6	1
23:15-23:30	5	1	6	16.7	0.5	0	36	19	55	34.5	0.5	0
23:30-23:45	6	0	6	0.0	0.5	0	28	19	47	40.4	0.4	1
23:45-24:00	4	0	4	0.0	0.3	0	32	12	44	27.3	0.4	1
1時間計	17	6	23	26.1	1.9	0	142	68	210	32.4	1.9	3
0:00-0:15	7	0	7	0.0	0.6	0	31	21	52	40.4	0.5	1
0:15-0:30	2	3	5	60.0	0.4	0	25	17	42	40.5	0.4	0
0:30-0:45	2	4	6	66.7	0.5	0	25	13	38	34.2	0.4	2
0:45-1:00	1	1	2	50.0	0.2	0	23	26	49	53.1	0.5	2
1時間計	12	8	20	40.0	1.7	0	104	77	181	42.5	1.7	5
1:00-1:15	3	0	3	0.0	0.3	0	21	26	47	55.3	0.4	0
1:15-1:30	3	0	3	0.0	0.3	0	11	17	28	60.7	0.3	1
1:30-1:45	3	1	4	25.0	0.3	0	16	17	33	51.5	0.3	2
1:45-2:00	3	2	5	40.0	0.4	0	14	19	33	57.6	0.3	1
1時間計	12	3	15	20.0	1.3	0	62	79	141	56.0	1.3	4
2:00-2:15	3	0	3	0.0	0.3	1	16	21	37	56.8	0.3	1
2:15-2:30	2	0	2	0.0	0.2	0	15	20	35	57.1	0.3	1
2:30-2:45	3	2	5	40.0	0.4	0	19	20	39	51.3	0.4	1
2:45-3:00	1	2	3	66.7	0.3	0	14	34	48	70.8	0.4	1
1時間計	9	4	13	30.8	1.1	1	64	95	159	59.7	1.5	4
3:00-3:15	5	0	5	0.0	0.4	0	12	17	29	58.6	0.3	0
3:15-3:30	1	1	2	50.0	0.2	0	10	23	33	69.7	0.3	0
3:30-3:45	2	2	4	50.0	0.3	0	35	42	77	54.5	0.7	0
3:45-4:00	0	0	0	0.0	0.0	0	15	25	40	62.5	0.4	1
1時間計	8	3	11	27.3	0.9	0	72	107	179	59.8	1.7	1
4:00-4:15	3	1	4	25.0	0.3	0	16	31	47	66.0	0.4	0
4:15-4:30	3	2	5	40.0	0.4	0	24	28	52	53.8	0.5	3
4:30-4:45	3	1	4	25.0	0.3	0	17	38	55	69.1	0.5	5
4:45-5:00	2	1	3	33.3	0.3	0	28	40	68	58.8	0.6	3
1時間計	11	5	16	31.3	1.3	0	85	137	222	61.7	2.1	11
5:00-5:15	2	4	6	66.7	0.5	1	30	50	80	62.5	0.7	2
5:15-5:30	2	2	4	50.0	0.3	0	46	59	105	56.2	1.0	2
5:30-5:45	4	0	4	0.0	0.3	0	62	60	122	49.2	1.1	3
5:45-6:00	6	1	7	14.3	0.6	0	66	66	132	50.0	1.2	3
1時間計	14	7	21	33.3	1.8	1	204	235	439	53.5	4.1	10
6:00-6:15	5	2	7	28.6	0.6	1	118	58	176	33.0	1.6	4
6:15-6:30	5	3	8	37.5	0.7	0	98	54	152	35.5	1.4	4
6:30-6:45	7	2	9	22.2	0.8	1	126	57	183	31.1	1.7	11
6:45-7:00	10	2	12	16.7	1.0	1	112	49	161	30.4	1.5	5
1時間計	27	9	36	25.0	3.0	3	454	218	672	32.4	6.2	24
夜12時間計	318	71	389	18.3	32.7	15	2453	1358	3811	35.6	35.3	127
全時間合計	999	190	1189	16.0	100.0	54	7077	3731	10808	34.5	100.0	348
昼夜率	1.47	1.60	1.49	-	-	1.38	1.53	1.57	1.54	-	-	1.57

方向別自動車交通量調査表

調査地点：地域社会2 目黒交番前

調査年月日：令和元年 5月14日(火) 天候：雨のち曇り

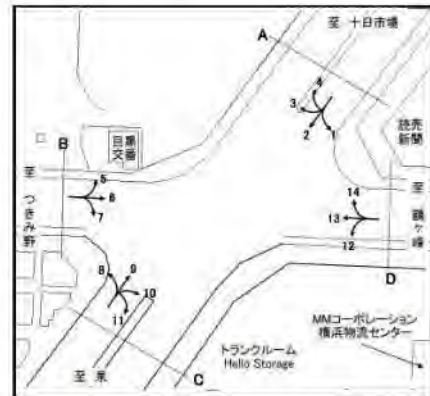

時間帯	種別	14						D 合計 (12+13+14)					
		小型車 (台)	大型車 (台)	合計 (台)	大型車 混入率 (%)	時 間 係 数 (%)	二輪車 (台)	小型車 (台)	大型車 (台)	合計 (台)	大型車 混入率 (%)	時 間 係 数 (%)	二輪車 (台)
7:00-7:15		1	2	3	66.7	1.5	0	90	43	133	32.3	1.1	9
7:15-7:30		0	1	1	100.0	0.5	0	123	53	176	30.1	1.4	13
7:30-7:45		1	1	2	50.0	1.0	0	101	52	153	34.0	1.3	13
7:45-8:00		3	1	4	25.0	2.0	0	116	42	158	26.6	1.3	11
1時間計		5	5	10	50.0	5.1	0	430	190	620	30.6	5.1	46
8:00-8:15		2	0	2	0.0	1.0	0	103	45	148	30.4	1.2	7
8:15-8:30		2	0	2	0.0	1.0	0	105	37	142	26.1	1.2	8
8:30-8:45		0	1	1	100.0	0.5	1	98	55	153	35.9	1.3	5
8:45-9:00		2	0	2	0.0	1.0	0	118	59	177	33.3	1.5	11
1時間計		6	1	7	14.3	3.5	1	424	196	620	31.6	5.1	31
9:00-9:15		0	0	0	0.0	0.0	0	104	54	158	34.2	1.3	4
9:15-9:30		1	2	3	66.7	1.5	0	93	53	146	36.3	1.2	2
9:30-9:45		0	1	1	100.0	0.5	0	85	66	151	43.7	1.2	3
9:45-10:00		4	0	4	0.0	2.0	0	98	57	155	36.8	1.3	2
1時間計		5	3	8	37.5	4.0	0	380	230	610	37.7	5.0	11
10:00-10:15		0	1	1	100.0	0.5	0	114	75	189	39.7	1.5	5
10:15-10:30		1	0	1	0.0	0.5	0	104	60	164	36.6	1.3	1
10:30-10:45		0	0	0	0.0	0.0	0	98	67	165	40.6	1.4	1
10:45-11:00		1	0	1	0.0	0.5	0	113	49	162	30.2	1.3	6
1時間計		2	1	3	33.3	1.5	0	429	251	680	36.9	5.6	13
11:00-11:15		1	2	3	66.7	1.5	0	93	53	146	36.3	1.2	1
11:15-11:30		3	4	7	57.1	3.5	0	119	76	195	39.0	1.6	4
11:30-11:45		2	1	3	33.3	1.5	0	76	67	143	46.9	1.2	3
11:45-12:00		3	1	4	25.0	2.0	0	83	69	152	45.4	1.2	1
1時間計		9	8	17	47.1	8.6	0	371	265	636	41.7	5.2	9
12:00-12:15		3	2	5	40.0	2.5	0	111	69	180	38.3	1.5	0
12:15-12:30		1	1	2	50.0	1.0	0	78	69	147	46.9	1.2	2
12:30-12:45		6	3	9	33.3	4.5	0	105	51	156	32.7	1.3	5
12:45-13:00		2	5	7	71.4	3.5	0	94	61	155	39.4	1.3	1
1時間計		12	11	23	47.8	11.6	0	388	250	638	39.2	5.2	8
13:00-13:15		1	1	2	50.0	1.0	0	92	50	142	35.2	1.2	2
13:15-13:30		3	1	4	25.0	2.0	0	91	57	148	38.5	1.2	1
13:30-13:45		1	2	3	66.7	1.5	0	118	64	182	35.2	1.5	1
13:45-14:00		4	2	6	33.3	3.0	0	96	51	147	34.7	1.2	3
1時間計		9	6	15	40.0	7.6	0	397	222	619	35.9	5.1	7
14:00-14:15		1	0	1	0.0	0.5	0	119	60	179	33.5	1.5	3
14:15-14:30		3	1	4	25.0	2.0	0	92	54	146	37.0	1.2	2
14:30-14:45		3	1	4	25.0	2.0	0	101	72	173	41.6	1.4	9
14:45-15:00		4	1	5	20.0	2.5	5	109	63	172	36.6	1.4	7
1時間計		11	3	14	21.4	7.1	5	421	249	670	37.2	5.5	21

方向別自動車交通量調査表

調査地点 : 地域社会3 上川井1C

調査年月日 : 令和元年 5月14日(火) 天候:雨のち曇り



方向	1						2							
	種別	小型車 (台)	大型車 (台)	合計 (台)	大型車 混入率 (%)	時間 係数 (%)	二輪車 (台)	種別	小型車 (台)	大型車 (台)	合計 (台)	大型車 混入率 (%)	時間 係数 (%)	二輪車 (台)
7:00-7:15		16	8	24	33.3	1.2	2		0	0	0	0.0	0.0	0
7:15-7:30		20	2	22	9.1	1.1	4		3	1	4	25.0	1.2	0
7:30-7:45		22	10	32	31.3	1.6	3		2	3	5	60.0	1.5	0
7:45-8:00		18	4	22	18.2	1.1	5		0	1	1	100.0	0.3	0
1時間計		76	24	100	24.0	5.1	14		5	5	10	50.0	3.0	0
8:00-8:15		30	11	41	26.8	2.1	7		1	5	6	83.3	1.8	0
8:15-8:30		55	2	57	3.5	2.9	3		2	1	3	33.3	0.9	0
8:30-8:45		37	10	47	21.3	2.4	2		2	5	7	71.4	2.1	0
8:45-9:00		24	11	35	31.4	1.8	4		3	3	6	50.0	1.8	0
1時間計		146	34	180	18.9	9.2	16		8	14	22	63.6	6.5	0
9:00-9:15		28	13	41	31.7	2.1	1		1	2	3	66.7	0.9	0
9:15-9:30		25	16	41	39.0	2.1	1		1	1	2	50.0	0.6	0
9:30-9:45		27	7	34	20.6	1.7	0		1	5	6	83.3	1.8	0
9:45-10:00		33	10	43	23.3	2.2	1		6	0	6	0.0	1.8	0
1時間計		113	46	159	28.9	8.1	3		9	8	17	47.1	5.0	0
10:00-10:15		27	11	38	28.9	1.9	2		2	4	6	66.7	1.8	0
10:15-10:30		24	9	33	27.3	1.7	1		4	3	7	42.9	2.1	0
10:30-10:45		32	13	45	28.9	2.3	0		2	1	3	33.3	0.9	0
10:45-11:00		30	15	45	33.3	2.3	0		3	3	6	50.0	1.8	0
1時間計		113	48	161	29.8	8.2	3		11	11	22	50.0	6.5	0
11:00-11:15		19	5	24	20.8	1.2	0		7	2	9	22.2	2.7	0
11:15-11:30		21	8	29	27.6	1.5	0		4	2	6	33.3	1.8	0
11:30-11:45		17	6	23	26.1	1.2	1		3	2	5	40.0	1.5	0
11:45-12:00		20	9	29	31.0	1.5	1		2	1	3	33.3	0.9	0
1時間計		77	28	105	26.7	5.3	2		16	7	23	30.4	6.8	0
12:00-12:15		18	11	29	37.9	1.5	0		2	1	3	33.3	0.9	0
12:15-12:30		19	5	24	20.8	1.2	0		1	1	2	50.0	0.6	0
12:30-12:45		24	2	26	7.7	1.3	0		2	2	4	50.0	1.2	0
12:45-13:00		19	4	23	17.4	1.2	0		3	0	3	0.0	0.9	0
1時間計		80	22	102	21.6	5.2	0		8	4	12	33.3	3.6	0
13:00-13:15		17	5	22	22.7	1.1	0		2	2	4	50.0	1.2	0
13:15-13:30		20	6	26	23.1	1.3	0		4	1	5	20.0	1.5	0
13:30-13:45		15	7	22	31.8	1.1	0		3	3	6	50.0	1.8	0
13:45-14:00		17	14	31	45.2	1.6	1		6	4	10	40.0	3.0	0
1時間計		69	32	101	31.7	5.1	1		15	10	25	40.0	7.4	0
14:00-14:15		19	4	23	17.4	1.2	0		4	2	6	33.3	1.8	0
14:15-14:30		29	7	36	19.4	1.8	2		4	1	5	20.0	1.5	0
14:30-14:45		20	5	25	20.0	1.3	0		3	0	3	0.0	0.9	0
14:45-15:00		24	5	29	17.2	1.5	0		6	3	9	33.3	2.7	0
1時間計		92	21	113	18.6	5.8	2		17	6	23	26.1	6.8	0

方向別自動車交通量調査表

調査地点：地域社会3 上川井IC

調査年月日：令和元年 5月14日(火) 天候：雨のち曇り



方向 時間帯	1						2					
	種別 小型車 (台)	大型車 (台)	合計 (台)	大型車 混入率 (%)	時間 係数 (%)	二輪車 (台)	小型車 (台)	大型車 (台)	合計 (台)	大型車 混入率 (%)	時間 係数 (%)	二輪車 (台)
15:00-15:15	18	7	25	28.0	1.3	2	1	3	4	75.0	1.2	0
15:15-15:30	31	5	36	13.9	1.8	4	1	5	6	83.3	1.8	0
15:30-15:45	21	5	26	19.2	1.3	0	3	4	7	57.1	2.1	0
15:45-16:00	25	9	34	26.5	1.7	0	4	5	9	55.6	2.7	0
1時間計	95	26	121	21.5	6.2	6	9	17	26	65.4	7.7	0
16:00-16:15	21	7	28	25.0	1.4	1	1	3	4	75.0	1.2	0
16:15-16:30	27	9	36	25.0	1.8	1	5	3	8	37.5	2.4	0
16:30-16:45	16	6	22	27.3	1.1	2	3	0	3	0.0	0.9	0
16:45-17:00	20	8	28	28.6	1.4	0	2	2	4	50.0	1.2	0
1時間計	84	30	114	26.3	5.8	4	11	8	19	42.1	5.6	0
17:00-17:15	28	9	37	24.3	1.9	0	3	4	7	57.1	2.1	0
17:15-17:30	25	8	33	24.2	1.7	2	4	0	4	0.0	1.2	0
17:30-17:45	20	4	24	16.7	1.2	2	1	1	2	50.0	0.6	0
17:45-18:00	29	2	31	6.5	1.6	1	1	1	2	50.0	0.6	1
1時間計	102	23	125	18.4	6.4	5	9	6	15	40.0	4.4	1
18:00-18:15	28	4	32	12.5	1.6	0	4	2	6	33.3	1.8	0
18:15-18:30	25	2	27	7.4	1.4	4	2	2	4	50.0	1.2	0
18:30-18:45	24	6	30	20.0	1.5	5	4	2	6	33.3	1.8	0
18:45-19:00	17	6	23	26.1	1.2	2	3	0	3	0.0	0.9	0
1時間計	94	18	112	16.1	5.7	11	13	6	19	31.6	5.6	0
昼12時間計	1141	352	1493	23.6	76.0	67	131	102	233	43.8	68.9	1
19:00-19:15	18	2	20	10.0	1.0	2	0	1	1	100.0	0.3	0
19:15-19:30	19	3	22	13.6	1.1	3	1	0	1	0.0	0.3	0
19:30-19:45	12	1	13	7.7	0.7	2	1	1	2	50.0	0.6	0
19:45-20:00	10	2	12	16.7	0.6	3	0	1	1	100.0	0.3	0
1時間計	59	8	67	11.9	3.4	10	2	3	5	60.0	1.5	0
20:00-20:15	15	0	15	0.0	0.8	0	1	2	3	66.7	0.9	0
20:15-20:30	9	0	9	0.0	0.5	0	3	0	3	0.0	0.9	0
20:30-20:45	12	0	12	0.0	0.6	0	1	0	1	0.0	0.3	0
20:45-21:00	7	2	9	22.2	0.5	1	1	0	1	0.0	0.3	0
1時間計	43	2	45	4.4	2.3	1	6	2	8	25.0	2.4	0
21:00-21:15	7	1	8	12.5	0.4	0	1	0	1	0.0	0.3	0
21:15-21:30	11	0	11	0.0	0.6	1	1	2	3	66.7	0.9	0
21:30-21:45	6	1	7	14.3	0.4	0	2	0	2	0.0	0.6	0
21:45-22:00	5	2	7	28.6	0.4	0	0	0	0	0.0	0.0	0
1時間計	29	4	33	12.1	1.7	1	4	2	6	33.3	1.8	0
22:00-22:15	9	1	10	10.0	0.5	0	0	2	2	100.0	0.6	0
22:15-22:30	6	5	11	45.5	0.6	1	4	0	4	0.0	1.2	0
22:30-22:45	3	2	5	40.0	0.3	1	1	0	1	0.0	0.3	0
22:45-23:00	1	0	1	0.0	0.1	0	0	1	1	100.0	0.3	0
1時間計	19	8	27	29.6	1.4	2	5	3	8	37.5	2.4	0

方向別自動車交通量調査表

調査地点：地域社会3 上川井IC

調査年月日：令和元年 5月14日(火) 天候：雨のち曇り



方向 種別 時間帯	1						2					
	小型車 (台)	大型車 (台)	合計 (台)	大型車 混入率 (%)	時間 係数 (%)	二輪車 (台)	小型車 (台)	大型車 (台)	合計 (台)	大型車 混入率 (%)	時間 係数 (%)	二輪車 (台)
23:00-23:15	5	2	7	28.6	0.4	0	0	0	0	0.0	0.0	0
23:15-23:30	6	1	7	14.3	0.4	0	0	0	0	0.0	0.0	0
23:30-23:45	4	0	4	0.0	0.2	0	1	0	1	0.0	0.3	0
23:45-24:00	1	2	3	66.7	0.2	1	0	0	0	0.0	0.0	0
1時間計	16	5	21	23.8	1.1	1	1	0	1	0.0	0.3	0
0:00-0:15	3	0	3	0.0	0.2	0	0	0	0	0.0	0.0	0
0:15-0:30	2	1	3	33.3	0.2	0	0	2	2	100.0	0.6	0
0:30-0:45	5	3	8	37.5	0.4	0	0	0	0	0.0	0.0	0
0:45-1:00	1	1	2	50.0	0.1	0	0	2	2	100.0	0.6	0
1時間計	11	5	16	31.3	0.8	0	0	4	4	100.0	1.2	0
1:00-1:15	2	1	3	33.3	0.2	1	0	1	1	100.0	0.3	0
1:15-1:30	4	1	5	20.0	0.3	0	0	3	3	100.0	0.9	0
1:30-1:45	3	0	3	0.0	0.2	0	2	6	8	75.0	2.4	0
1:45-2:00	3	2	5	40.0	0.3	0	0	1	1	100.0	0.3	0
1時間計	12	4	16	25.0	0.8	1	2	11	13	84.6	3.8	0
2:00-2:15	3	0	3	0.0	0.2	0	3	2	5	40.0	1.5	0
2:15-2:30	2	2	4	50.0	0.2	0	4	1	5	20.0	1.5	0
2:30-2:45	2	2	4	50.0	0.2	0	2	1	3	33.3	0.9	0
2:45-3:00	0	1	1	100.0	0.1	0	1	1	2	50.0	0.6	0
1時間計	7	5	12	41.7	0.6	0	10	5	15	33.3	4.4	0
3:00-3:15	1	2	3	66.7	0.2	1	1	0	1	0.0	0.3	0
3:15-3:30	3	1	4	25.0	0.2	0	1	0	1	0.0	0.3	0
3:30-3:45	2	3	5	60.0	0.3	0	1	0	1	0.0	0.3	0
3:45-4:00	2	1	3	33.3	0.2	0	0	0	0	0.0	0.0	0
1時間計	8	7	15	46.7	0.8	1	3	0	3	0.0	0.9	0
4:00-4:15	3	3	6	50.0	0.3	0	1	0	1	0.0	0.3	0
4:15-4:30	6	4	10	40.0	0.5	0	2	3	5	60.0	1.5	0
4:30-4:45	2	1	3	33.3	0.2	0	3	2	5	40.0	1.5	0
4:45-5:00	8	5	13	38.5	0.7	0	7	1	8	12.5	2.4	0
1時間計	19	13	32	40.6	1.6	0	13	6	19	31.6	5.6	0
5:00-5:15	4	6	10	60.0	0.5	1	1	2	3	66.7	0.9	0
5:15-5:30	10	6	16	37.5	0.8	2	1	1	2	50.0	0.6	1
5:30-5:45	15	5	20	25.0	1.0	2	1	2	3	66.7	0.9	1
5:45-6:00	19	7	26	26.9	1.3	2	3	1	4	25.0	1.2	0
1時間計	48	24	72	33.3	3.7	7	6	6	12	50.0	3.6	2
6:00-6:15	17	5	22	22.7	1.1	1	2	1	3	33.3	0.9	0
6:15-6:30	26	8	34	23.5	1.7	5	1	0	1	0.0	0.3	0
6:30-6:45	21	12	33	36.4	1.7	3	5	0	5	0.0	1.5	1
6:45-7:00	18	9	27	33.3	1.4	9	1	1	2	50.0	0.6	0
1時間計	82	34	116	29.3	5.9	18	9	2	11	18.2	3.3	1
夜12時間計	353	119	472	25.2	24.0	42	61	44	105	41.9	31.1	3
全時間合計	1494	471	1965	24.0	100.0	109	192	146	338	43.2	100.0	4
昼夜率	1.31	1.34	1.32	-	-	1.63	1.47	1.43	1.45	-	-	4.00

方向別自動車交通量調査表

調査地点：地域社会3 上川井1C

調査年月日：令和元年 5月14日(火) 天候：雨のち曇り

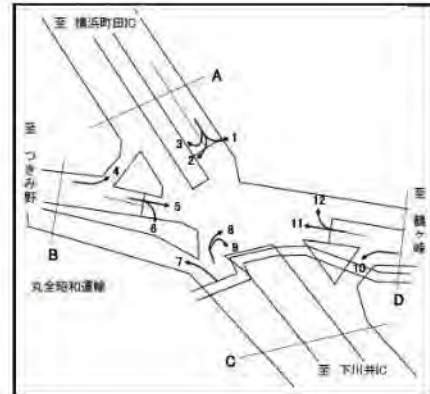

時間帯	種別	3						A 合計 (1+2+3)					
		小型車 (台)	大型車 (台)	合計 (台)	大型車 混入率 (%)	時間 係数 (%)	二輪車 (台)	小型車 (台)	大型車 (台)	合計 (台)	大型車 混入率 (%)	時間 係数 (%)	二輪車 (台)
7:00-7:15		0	0	0	0.0	0.0	0	16	8	24	33.3	1.0	2
7:15-7:30		0	0	0	0.0	0.0	0	23	3	26	11.5	1.1	4
7:30-7:45		0	0	0	0.0	0.0	0	24	13	37	35.1	1.5	3
7:45-8:00		0	0	0	0.0	0.0	0	18	5	23	21.7	0.9	5
1時間計		0	0	0	0.0	0.0	0	81	29	110	26.4	4.5	14
8:00-8:15		1	0	1	0.0	0.6	0	32	16	48	33.3	2.0	7
8:15-8:30		0	0	0	0.0	0.0	0	57	3	60	5.0	2.4	3
8:30-8:45		0	0	0	0.0	0.0	0	39	15	54	27.8	2.2	2
8:45-9:00		0	0	0	0.0	0.0	0	27	14	41	34.1	1.7	4
1時間計		1	0	1	0.0	0.6	0	155	48	203	23.6	8.3	16
9:00-9:15		1	0	1	0.0	0.6	0	30	15	45	33.3	1.8	1
9:15-9:30		0	0	0	0.0	0.0	0	26	17	43	39.5	1.7	1
9:30-9:45		0	2	2	100.0	1.3	0	28	14	42	33.3	1.7	0
9:45-10:00		0	0	0	0.0	0.0	0	39	10	49	20.4	2.0	1
1時間計		1	2	3	66.7	1.9	0	123	56	179	31.3	7.3	3
10:00-10:15		0	1	1	100.0	0.6	0	29	16	45	35.6	1.8	2
10:15-10:30		0	0	0	0.0	0.0	0	28	12	40	30.0	1.6	1
10:30-10:45		2	2	4	50.0	2.6	0	36	16	52	30.8	2.1	0
10:45-11:00		0	1	1	100.0	0.6	0	33	19	52	36.5	2.1	0
1時間計		2	4	6	66.7	3.9	0	126	63	189	33.3	7.7	3
11:00-11:15		3	2	5	40.0	3.2	0	29	9	38	23.7	1.5	0
11:15-11:30		4	3	7	42.9	4.5	0	29	13	42	31.0	1.7	0
11:30-11:45		2	1	3	33.3	1.9	0	22	9	31	29.0	1.3	1
11:45-12:00		0	1	1	100.0	0.6	0	22	11	33	33.3	1.3	1
1時間計		9	7	16	43.8	10.3	0	102	42	144	29.2	5.9	2
12:00-12:15		0	3	3	100.0	1.9	0	20	15	35	42.9	1.4	0
12:15-12:30		0	2	2	100.0	1.3	0	20	8	28	28.6	1.1	0
12:30-12:45		1	2	3	66.7	1.9	0	27	6	33	18.2	1.3	0
12:45-13:00		1	1	2	50.0	1.3	0	23	5	28	17.9	1.1	0
1時間計		2	8	10	80.0	6.5	0	90	34	124	27.4	5.0	0
13:00-13:15		0	2	2	100.0	1.3	0	19	9	28	32.1	1.1	0
13:15-13:30		0	0	0	0.0	0.0	0	24	7	31	22.6	1.3	0
13:30-13:45		0	5	5	100.0	3.2	0	18	15	33	45.5	1.3	0
13:45-14:00		2	5	7	71.4	4.5	0	25	23	48	47.9	2.0	1
1時間計		2	12	14	85.7	9.0	0	86	54	140	38.6	5.7	1
14:00-14:15		0	3	3	100.0	1.9	0	23	9	32	28.1	1.3	0
14:15-14:30		1	1	2	50.0	1.3	0	34	9	43	20.9	1.7	2
14:30-14:45		2	0	2	0.0	1.3	0	25	5	30	16.7	1.2	0
14:45-15:00		0	3	3	100.0	1.9	0	30	11	41	26.8	1.7	0
1時間計		3	7	10	70.0	6.5	0	112	34	146	23.3	5.9	2

方向別自動車交通量調査表

調査地点：地域社会3 上川井1C

調査年月日：令和元年 5月14日(火) 天候：雨のち曇り

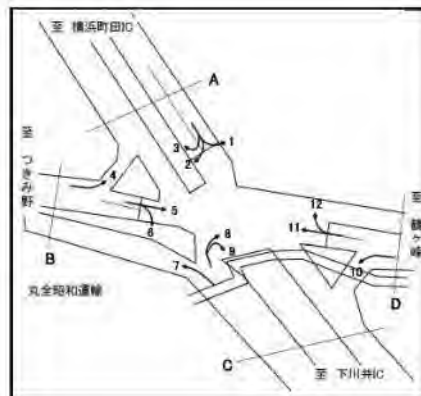

時間帯	種別	3						A 合計 (1+2+3)					
		小型車 (台)	大型車 (台)	合計 (台)	大型車 混入率 (%)	時間 係数 (%)	二輪車 (台)	小型車 (台)	大型車 (台)	合計 (台)	大型車 混入率 (%)	時間 係数 (%)	二輪車 (台)
15:00-15:15		1	0	1	0.0	0.6	0	20	10	30	33.3	1.2	2
15:15-15:30		0	2	2	100.0	1.3	0	32	12	44	27.3	1.8	4
15:30-15:45		1	1	2	50.0	1.3	0	25	10	35	28.6	1.4	0
15:45-16:00		4	3	7	42.9	4.5	0	33	17	50	34.0	2.0	0
1時間計		6	6	12	50.0	7.7	0	110	49	159	30.8	6.5	6
16:00-16:15		4	3	7	42.9	4.5	0	26	13	39	33.3	1.6	1
16:15-16:30		0	1	1	100.0	0.6	0	32	13	45	28.9	1.8	1
16:30-16:45		1	0	1	0.0	0.6	0	20	6	26	23.1	1.1	2
16:45-17:00		2	1	3	33.3	1.9	0	24	11	35	31.4	1.4	0
1時間計		7	5	12	41.7	7.7	0	102	43	145	29.7	5.9	4
17:00-17:15		1	3	4	75.0	2.6	0	32	16	48	33.3	2.0	0
17:15-17:30		1	1	2	50.0	1.3	0	30	9	39	23.1	1.6	2
17:30-17:45		0	1	1	100.0	0.6	0	21	6	27	22.2	1.1	2
17:45-18:00		2	2	4	50.0	2.6	0	32	5	37	13.5	1.5	2
1時間計		4	7	11	63.6	7.1	0	115	36	151	23.8	6.1	6
18:00-18:15		0	1	1	100.0	0.6	0	32	7	39	17.9	1.6	0
18:15-18:30		3	0	3	0.0	1.9	0	30	4	34	11.8	1.4	4
18:30-18:45		1	0	1	0.0	0.6	0	29	8	37	21.6	1.5	5
18:45-19:00		2	0	2	0.0	1.3	0	22	6	28	21.4	1.1	2
1時間計		6	1	7	14.3	4.5	0	113	25	138	18.1	5.6	11
昼12時間計		43	59	102	57.8	65.8	0	1315	513	1828	28.1	74.4	68
19:00-19:15		2	0	2	0.0	1.3	0	20	3	23	13.0	0.9	2
19:15-19:30		0	2	2	100.0	1.3	0	20	5	25	20.0	1.0	3
19:30-19:45		1	0	1	0.0	0.6	0	14	2	16	12.5	0.7	2
19:45-20:00		0	2	2	100.0	1.3	0	10	5	15	33.3	0.6	3
1時間計		3	4	7	57.1	4.5	0	64	15	79	19.0	3.2	10
20:00-20:15		3	1	4	25.0	2.6	0	19	3	22	13.6	0.9	0
20:15-20:30		1	1	2	50.0	1.3	0	13	1	14	7.1	0.6	0
20:30-20:45		0	0	0	0.0	0.0	0	13	0	13	0.0	0.5	0
20:45-21:00		0	0	0	0.0	0.0	0	8	2	10	20.0	0.4	1
1時間計		4	2	6	33.3	3.9	0	53	6	59	10.2	2.4	1
21:00-21:15		0	0	0	0.0	0.0	0	8	1	9	11.1	0.4	0
21:15-21:30		0	0	0	0.0	0.0	0	12	2	14	14.3	0.6	1
21:30-21:45		0	0	0	0.0	0.0	0	8	1	9	11.1	0.4	0
21:45-22:00		0	0	0	0.0	0.0	0	5	2	7	28.6	0.3	0
1時間計		0	0	0	0.0	0.0	0	33	6	39	15.4	1.6	1
22:00-22:15		0	0	0	0.0	0.0	0	9	3	12	25.0	0.5	0
22:15-22:30		1	0	1	0.0	0.6	0	11	5	16	31.3	0.7	1
22:30-22:45		0	0	0	0.0	0.0	0	4	2	6	33.3	0.2	1
22:45-23:00		0	1	1	100.0	0.6	0	1	2	3	66.7	0.1	0
1時間計		1	1	2	50.0	1.3	0	25	12	37	32.4	1.5	2

方向別自動車交通量調査表

調査地点：地域社会3 上川井1C

調査年月日：令和元年 5月14日(火) 天候：雨のち曇り



時間帯	3						A 合計 (1+2+3)						
	種別	小型車 (台)	大型車 (台)	合計 (台)	大型車 混入率 (%)	時 間 係 数 (%)	二輪車 (台)	小型車 (台)	大型車 (台)	合計 (台)	大型車 混入率 (%)	時 間 係 数 (%)	二輪車 (台)
23:00-23:15		1	0	1	0.0	0.6	0	6	2	8	25.0	0.3	0
23:15-23:30		0	0	0	0.0	0.0	0	6	1	7	14.3	0.3	0
23:30-23:45		0	1	1	100.0	0.6	0	5	1	6	16.7	0.2	0
23:45-24:00		0	2	2	100.0	1.3	0	1	4	5	80.0	0.2	1
1 時間計		1	3	4	75.0	2.6	0	18	8	26	30.8	1.1	1
0:00-0:15		0	0	0	0.0	0.0	0	3	0	3	0.0	0.1	0
0:15-0:30		0	0	0	0.0	0.0	0	2	3	5	60.0	0.2	0
0:30-0:45		0	0	0	0.0	0.0	0	5	3	8	37.5	0.3	0
0:45-1:00		0	1	1	100.0	0.6	0	1	4	5	80.0	0.2	0
1 時間計		0	1	1	100.0	0.6	0	11	10	21	47.6	0.9	0
1:00-1:15		1	0	1	0.0	0.6	0	3	2	5	40.0	0.2	1
1:15-1:30		0	0	0	0.0	0.0	0	4	4	8	50.0	0.3	0
1:30-1:45		1	0	1	0.0	0.6	0	6	6	12	50.0	0.5	0
1:45-2:00		0	0	0	0.0	0.0	0	3	3	6	50.0	0.2	0
1 時間計		2	0	2	0.0	1.3	0	16	15	31	48.4	1.3	1
2:00-2:15		4	0	4	0.0	2.6	0	10	2	12	16.7	0.5	0
2:15-2:30		0	0	0	0.0	0.0	0	6	3	9	33.3	0.4	0
2:30-2:45		3	1	4	25.0	2.6	0	7	4	11	36.4	0.4	0
2:45-3:00		1	0	1	0.0	0.6	0	2	2	4	50.0	0.2	0
1 時間計		8	1	9	11.1	5.8	0	25	11	36	30.6	1.5	0
3:00-3:15		0	1	1	100.0	0.6	0	2	3	5	60.0	0.2	1
3:15-3:30		0	1	1	100.0	0.6	0	4	2	6	33.3	0.2	0
3:30-3:45		0	0	0	0.0	0.0	0	3	3	6	50.0	0.2	0
3:45-4:00		1	0	1	0.0	0.6	0	3	1	4	25.0	0.2	0
1 時間計		1	2	3	66.7	1.9	0	12	9	21	42.9	0.9	1
4:00-4:15		0	1	1	100.0	0.6	0	4	4	8	50.0	0.3	0
4:15-4:30		0	1	1	100.0	0.6	0	8	8	16	50.0	0.7	0
4:30-4:45		2	1	3	33.3	1.9	0	7	4	11	36.4	0.4	0
4:45-5:00		2	1	3	33.3	1.9	0	17	7	24	29.2	1.0	0
1 時間計		4	4	8	50.0	5.2	0	36	23	59	39.0	2.4	0
5:00-5:15		3	3	6	50.0	3.9	0	8	11	19	57.9	0.8	1
5:15-5:30		0	0	0	0.0	0.0	1	11	7	18	38.9	0.7	4
5:30-5:45		0	0	0	0.0	0.0	0	16	7	23	30.4	0.9	3
5:45-6:00		0	0	0	0.0	0.0	0	22	8	30	26.7	1.2	2
1 時間計		3	3	6	50.0	3.9	1	57	33	90	36.7	3.7	10
6:00-6:15		1	0	1	0.0	0.6	0	20	6	26	23.1	1.1	1
6:15-6:30		2	1	3	33.3	1.9	0	29	9	38	23.7	1.5	5
6:30-6:45		0	1	1	100.0	0.6	0	26	13	39	33.3	1.6	4
6:45-7:00		0	0	0	0.0	0.0	0	19	10	29	34.5	1.2	9
1 時間計		3	2	5	40.0	3.2	0	94	38	132	28.8	5.4	19
夜12時間計		30	23	53	43.4	34.2	1	444	186	630	29.5	25.6	46
全時間合計		73	82	155	52.9	100.0	1	1759	699	2458	28.4	100.0	114
昼 夜 率		1.70	1.39	1.52	-	-	0.00	1.34	1.36	1.34	-	-	1.68

方向別自動車交通量調査表

調査地点 : 地域社会3 上川井1C

調査年月日 : 令和元年 5月14日(火) 天候:雨のち曇り



方向 時間帯	4						5					
	種別 小型車 (台)	大型車 (台)	合計 (台)	大型車 混入率 (%)	時間 係数 (%)	二輪車 (台)	小型車 (台)	大型車 (台)	合計 (台)	大型車 混入率 (%)	時間 係数 (%)	二輪車 (台)
7:00-7:15	0	0	0	0.0	0.0	0	26	8	34	23.5	0.9	3
7:15-7:30	0	0	0	0.0	0.0	0	31	14	45	31.1	1.2	9
7:30-7:45	1	2	3	66.7	1.3	0	21	8	29	27.6	0.8	5
7:45-8:00	1	0	1	0.0	0.4	0	25	12	37	32.4	1.0	9
1時間計	2	2	4	50.0	1.7	0	103	42	145	29.0	3.8	26
8:00-8:15	0	3	3	100.0	1.3	0	46	13	59	22.0	1.5	7
8:15-8:30	5	1	6	16.7	2.5	0	28	10	38	26.3	1.0	5
8:30-8:45	1	3	4	75.0	1.7	0	43	5	48	10.4	1.3	4
8:45-9:00	1	1	2	50.0	0.8	0	39	7	46	15.2	1.2	2
1時間計	7	8	15	53.3	6.3	0	156	35	191	18.3	5.0	18
9:00-9:15	1	1	2	50.0	0.8	0	41	17	58	29.3	1.5	4
9:15-9:30	0	2	2	100.0	0.8	0	32	15	47	31.9	1.2	0
9:30-9:45	0	1	1	100.0	0.4	0	40	13	53	24.5	1.4	0
9:45-10:00	5	1	6	16.7	2.5	0	32	9	41	22.0	1.1	1
1時間計	6	5	11	45.5	4.6	0	145	54	199	27.1	5.2	5
10:00-10:15	3	4	7	57.1	2.9	0	33	9	42	21.4	1.1	0
10:15-10:30	2	1	3	33.3	1.3	0	51	10	61	16.4	1.6	1
10:30-10:45	1	5	6	83.3	2.5	0	47	13	60	21.7	1.6	1
10:45-11:00	1	2	3	66.7	1.3	0	33	13	46	28.3	1.2	2
1時間計	7	12	19	63.2	7.9	0	164	45	209	21.5	5.5	4
11:00-11:15	2	2	4	50.0	1.7	1	36	12	48	25.0	1.3	2
11:15-11:30	2	1	3	33.3	1.3	0	33	11	44	25.0	1.2	1
11:30-11:45	3	1	4	25.0	1.7	0	39	13	52	25.0	1.4	3
11:45-12:00	5	4	9	44.4	3.8	0	44	6	50	12.0	1.3	0
1時間計	12	8	20	40.0	8.4	1	152	42	194	21.6	5.1	6
12:00-12:15	0	2	2	100.0	0.8	0	53	15	68	22.1	1.8	2
12:15-12:30	3	1	4	25.0	1.7	0	36	14	50	28.0	1.3	2
12:30-12:45	6	0	6	0.0	2.5	0	42	14	56	25.0	1.5	1
12:45-13:00	3	0	3	0.0	1.3	0	43	9	52	17.3	1.4	0
1時間計	12	3	15	20.0	6.3	0	174	52	226	23.0	5.9	5
13:00-13:15	1	1	2	50.0	0.8	0	23	9	32	28.1	0.8	0
13:15-13:30	2	1	3	33.3	1.3	0	60	11	71	15.5	1.9	3
13:30-13:45	1	2	3	66.7	1.3	0	44	12	56	21.4	1.5	1
13:45-14:00	0	8	8	100.0	3.3	0	42	16	58	27.6	1.5	2
1時間計	4	12	16	75.0	6.7	0	169	48	217	22.1	5.7	6
14:00-14:15	1	2	3	66.7	1.3	1	38	13	51	25.5	1.3	0
14:15-14:30	1	1	2	50.0	0.8	0	39	15	54	27.8	1.4	1
14:30-14:45	3	2	5	40.0	2.1	0	37	8	45	17.8	1.2	1
14:45-15:00	2	1	3	33.3	1.3	0	54	18	72	25.0	1.9	1
1時間計	7	6	13	46.2	5.4	1	168	54	222	24.3	5.8	3

方向別自動車交通量調査表

調査地点 : 地域社会3 上川井1C

調査年月日 : 令和元年 5月14日(火) 天候:雨のち曇り



方向 種別 時間帯	4						5					
	小型車 (台)	大型車 (台)	合計 (台)	大型車 混入率 (%)	時間 係数 (%)	二輪車 (台)	小型車 (台)	大型車 (台)	合計 (台)	大型車 混入率 (%)	時間 係数 (%)	二輪車 (台)
15:00-15:15	1	1	2	50.0	0.8	0	50	12	62	19.4	1.6	3
15:15-15:30	1	2	3	66.7	1.3	0	65	16	81	19.8	2.1	2
15:30-15:45	5	1	6	16.7	2.5	1	44	7	51	13.7	1.3	4
15:45-16:00	4	1	5	20.0	2.1	0	37	5	42	11.9	1.1	0
1時間計	11	5	16	31.3	6.7	1	196	40	236	16.9	6.2	9
16:00-16:15	2	3	5	60.0	2.1	0	38	5	43	11.6	1.1	2
16:15-16:30	5	1	6	16.7	2.5	0	73	9	82	11.0	2.2	5
16:30-16:45	2	4	6	66.7	2.5	1	41	9	50	18.0	1.3	3
16:45-17:00	1	1	2	50.0	0.8	1	61	14	75	18.7	2.0	3
1時間計	10	9	19	47.4	7.9	2	213	37	250	14.8	6.6	13
17:00-17:15	4	1	5	20.0	2.1	0	64	11	75	14.7	2.0	4
17:15-17:30	4	1	5	20.0	2.1	0	62	14	76	18.4	2.0	13
17:30-17:45	4	1	5	20.0	2.1	0	63	9	72	12.5	1.9	12
17:45-18:00	2	2	4	50.0	1.7	0	66	5	71	7.0	1.9	9
1時間計	14	5	19	26.3	7.9	0	255	39	294	13.3	7.7	38
18:00-18:15	1	1	2	50.0	0.8	0	66	9	75	12.0	2.0	11
18:15-18:30	2	0	2	0.0	0.8	0	46	6	52	11.5	1.4	5
18:30-18:45	1	0	1	0.0	0.4	0	45	7	52	13.5	1.4	8
18:45-19:00	2	3	5	60.0	2.1	0	59	9	68	13.2	1.8	6
1時間計	6	4	10	40.0	4.2	0	216	31	247	12.6	6.5	30
昼12時間計	98	79	177	44.6	74.1	5	2111	519	2630	19.7	69.1	163
19:00-19:15	2	0	2	0.0	0.8	0	43	1	44	2.3	1.2	4
19:15-19:30	2	1	3	33.3	1.3	0	45	5	50	10.0	1.3	4
19:30-19:45	1	1	2	50.0	0.8	0	52	5	57	8.8	1.5	7
19:45-20:00	0	0	0	0.0	0.0	0	37	2	39	5.1	1.0	7
1時間計	5	2	7	28.6	2.9	0	177	13	190	6.8	5.0	22
20:00-20:15	0	0	0	0.0	0.0	0	45	3	48	6.3	1.3	8
20:15-20:30	0	0	0	0.0	0.0	0	41	4	45	8.9	1.2	4
20:30-20:45	1	0	1	0.0	0.4	0	49	6	55	10.9	1.4	3
20:45-21:00	0	2	2	100.0	0.8	0	30	6	36	16.7	0.9	7
1時間計	1	2	3	66.7	1.3	0	165	19	184	10.3	4.8	22
21:00-21:15	2	2	4	50.0	1.7	0	33	2	35	5.7	0.9	3
21:15-21:30	0	1	1	100.0	0.4	0	18	6	24	25.0	0.6	2
21:30-21:45	0	0	0	0.0	0.0	0	27	1	28	3.6	0.7	4
21:45-22:00	1	0	1	0.0	0.4	0	40	1	41	2.4	1.1	1
1時間計	3	3	6	50.0	2.5	0	118	10	128	7.8	3.4	10
22:00-22:15	0	0	0	0.0	0.0	0	23	5	28	17.9	0.7	1
22:15-22:30	0	0	0	0.0	0.0	0	35	3	38	7.9	1.0	3
22:30-22:45	0	5	5	100.0	2.1	0	31	1	32	3.1	0.8	4
22:45-23:00	1	0	1	0.0	0.4	0	16	4	20	20.0	0.5	2
1時間計	1	5	6	83.3	2.5	0	105	13	118	11.0	3.1	10

方向別自動車交通量調査表

調査地点：地域社会3 上川井1C

調査年月日：令和元年 5月14日(火) 天候：雨のち曇り



方向	4						5						
	種別	小型車 (台)	大型車 (台)	合計 (台)	大型車 混入率 (%)	時間 係数 (%)	二輪車 (台)	小型車 (台)	大型車 (台)	合計 (台)	大型車 混入率 (%)	時間 係数 (%)	二輪車 (台)
23:00-23:15		0	0	0	0.0	0.0	0	17	4	21	19.0	0.6	2
23:15-23:30		0	0	0	0.0	0.0	0	10	2	12	16.7	0.3	0
23:30-23:45		2	0	2	0.0	0.8	0	18	2	20	10.0	0.5	2
23:45-24:00		0	0	0	0.0	0.0	0	13	0	13	0.0	0.3	0
1時間計		2	0	2	0.0	0.8	0	58	8	66	12.1	1.7	4
0:00-0:15		0	0	0	0.0	0.0	0	6	3	9	33.3	0.2	0
0:15-0:30		1	0	1	0.0	0.4	0	12	4	16	25.0	0.4	1
0:30-0:45		1	0	1	0.0	0.4	0	10	5	15	33.3	0.4	1
0:45-1:00		0	0	0	0.0	0.0	0	2	2	4	50.0	0.1	1
1時間計		2	0	2	0.0	0.8	0	30	14	44	31.8	1.2	3
1:00-1:15		1	1	2	50.0	0.8	0	5	4	9	44.4	0.2	1
1:15-1:30		0	0	0	0.0	0.0	0	12	4	16	25.0	0.4	0
1:30-1:45		0	0	0	0.0	0.0	0	8	3	11	27.3	0.3	1
1:45-2:00		0	0	0	0.0	0.0	0	3	0	3	0.0	0.1	0
1時間計		1	1	2	50.0	0.8	0	28	11	39	28.2	1.0	2
2:00-2:15		0	0	0	0.0	0.0	0	4	2	6	33.3	0.2	0
2:15-2:30		0	0	0	0.0	0.0	0	2	1	3	33.3	0.1	0
2:30-2:45		2	0	2	0.0	0.8	0	5	4	9	44.4	0.2	0
2:45-3:00		0	2	2	100.0	0.8	0	6	2	8	25.0	0.2	1
1時間計		2	2	4	50.0	1.7	0	17	9	26	34.6	0.7	1
3:00-3:15		0	0	0	0.0	0.0	0	5	4	9	44.4	0.2	1
3:15-3:30		0	1	1	100.0	0.4	0	2	4	6	66.7	0.2	2
3:30-3:45		2	1	3	33.3	1.3	0	12	3	15	20.0	0.4	0
3:45-4:00		0	0	0	0.0	0.0	0	2	2	4	50.0	0.1	3
1時間計		2	2	4	50.0	1.7	0	21	13	34	38.2	0.9	6
4:00-4:15		1	0	1	0.0	0.4	0	8	0	8	0.0	0.2	1
4:15-4:30		2	0	2	0.0	0.8	0	5	1	6	16.7	0.2	1
4:30-4:45		0	0	0	0.0	0.0	1	9	1	10	10.0	0.3	2
4:45-5:00		1	1	2	50.0	0.8	0	13	4	17	23.5	0.4	2
1時間計		4	1	5	20.0	2.1	1	35	6	41	14.6	1.1	6
5:00-5:15		2	1	3	33.3	1.3	0	15	6	21	28.6	0.6	1
5:15-5:30		1	2	3	66.7	1.3	0	23	3	26	11.5	0.7	6
5:30-5:45		0	2	2	100.0	0.8	0	35	3	38	7.9	1.0	9
5:45-6:00		2	1	3	33.3	1.3	0	30	10	40	25.0	1.1	4
1時間計		5	6	11	54.5	4.6	0	103	22	125	17.6	3.3	20
6:00-6:15		0	0	0	0.0	0.0	0	38	7	45	15.6	1.2	4
6:15-6:30		0	2	2	100.0	0.8	0	43	9	52	17.3	1.4	10
6:30-6:45		3	1	4	25.0	1.7	0	42	10	52	19.2	1.4	7
6:45-7:00		2	2	4	50.0	1.7	0	23	10	33	30.3	0.9	7
1時間計		5	5	10	50.0	4.2	0	146	36	182	19.8	4.8	28
夜12時間計		33	29	62	46.8	25.9	1	1003	174	1177	14.8	30.9	134
全時間合計		131	108	239	45.2	100.0	6	3114	693	3807	18.2	100.0	297
昼夜率		1.34	1.37	1.35	-	-	1.20	1.48	1.34	1.45	-	-	1.82

方向別自動車交通量調査表

調査地点 : 地域社会3 上川井IC

調査年月日 : 令和元年 5月14日(火) 天候:雨のち曇り



時間帯	種別	6						B 合計 (4+ 5+ 6)					
		小型車 (台)	大型車 (台)	合計 (台)	大型車 混入率 (%)	時間 係数 (%)	二輪車 (台)	小型車 (台)	大型車 (台)	合計 (台)	大型車 混入率 (%)	時間 係数 (%)	二輪車 (台)
7:00-7:15		39	32	71	45.1	0.9	2	65	40	105	38.1	0.9	5
7:15-7:30		48	26	74	35.1	1.0	1	79	40	119	33.6	1.0	10
7:30-7:45		45	40	85	47.1	1.1	2	67	50	117	42.7	1.0	7
7:45-8:00		51	36	87	41.4	1.1	1	77	48	125	38.4	1.1	10
1時間計		183	134	317	42.3	4.1	6	288	178	466	38.2	4.0	32
8:00-8:15		44	46	90	51.1	1.2	2	90	62	152	40.8	1.3	9
8:15-8:30		34	26	60	43.3	0.8	0	67	37	104	35.6	0.9	5
8:30-8:45		31	45	76	59.2	1.0	1	75	53	128	41.4	1.1	5
8:45-9:00		50	41	91	45.1	1.2	0	90	49	139	35.3	1.2	2
1時間計		159	158	317	49.8	4.1	3	322	201	523	38.4	4.5	21
9:00-9:15		38	54	92	58.7	1.2	1	80	72	152	47.4	1.3	5
9:15-9:30		67	55	122	45.1	1.6	0	99	72	171	42.1	1.5	0
9:30-9:45		53	46	99	46.5	1.3	0	93	60	153	39.2	1.3	0
9:45-10:00		53	54	107	50.5	1.4	2	90	64	154	41.6	1.3	3
1時間計		211	209	420	49.8	5.5	3	362	268	630	42.5	5.4	8
10:00-10:15		49	46	95	48.4	1.2	0	85	59	144	41.0	1.2	0
10:15-10:30		46	60	106	56.6	1.4	1	99	71	170	41.8	1.5	2
10:30-10:45		38	44	82	53.7	1.1	0	86	62	148	41.9	1.3	1
10:45-11:00		27	47	74	63.5	1.0	1	61	62	123	50.4	1.0	3
1時間計		160	197	357	55.2	4.7	2	331	254	585	43.4	5.0	6
11:00-11:15		48	52	100	52.0	1.3	0	86	66	152	43.4	1.3	3
11:15-11:30		64	38	102	37.3	1.3	0	99	50	149	33.6	1.3	1
11:30-11:45		63	45	108	41.7	1.4	0	105	59	164	36.0	1.4	3
11:45-12:00		52	35	87	40.2	1.1	0	101	45	146	30.8	1.2	0
1時間計		227	170	397	42.8	5.2	0	391	220	611	36.0	5.2	7
12:00-12:15		38	52	90	57.8	1.2	1	91	69	160	43.1	1.4	3
12:15-12:30		59	51	110	46.4	1.4	1	98	66	164	40.2	1.4	3
12:30-12:45		50	52	102	51.0	1.3	1	98	66	164	40.2	1.4	2
12:45-13:00		65	53	118	44.9	1.5	0	111	62	173	35.8	1.5	0
1時間計		212	208	420	49.5	5.5	3	398	263	661	39.8	5.6	8
13:00-13:15		59	40	99	40.4	1.3	0	83	50	133	37.6	1.1	0
13:15-13:30		61	51	112	45.5	1.5	0	123	63	186	33.9	1.6	3
13:30-13:45		57	56	113	49.6	1.5	0	102	70	172	40.7	1.5	1
13:45-14:00		51	38	89	42.7	1.2	0	93	62	155	40.0	1.3	2
1時間計		228	185	413	44.8	5.4	0	401	245	646	37.9	5.5	6
14:00-14:15		49	35	84	41.7	1.1	0	88	50	138	36.2	1.2	1
14:15-14:30		46	49	95	51.6	1.2	0	86	65	151	43.0	1.3	1
14:30-14:45		57	43	100	43.0	1.3	0	97	53	150	35.3	1.3	1
14:45-15:00		65	38	103	36.9	1.3	0	121	57	178	32.0	1.5	1
1時間計		217	165	382	43.2	5.0	0	392	225	617	36.5	5.3	4

方向別自動車交通量調査表

調査地点 : 地域社会3 上川井IC

調査年月日 : 令和元年 5月14日(火) 天候: 雨のち曇り



時間帯	6						B 合計 (4+ 5+ 6)					
	種別 小型車 (台)	大型車 (台)	合計 (台)	大型車 混入率 (%)	時間 係数 (%)	二輪車 (台)	種別 小型車 (台)	大型車 (台)	合計 (台)	大型車 混入率 (%)	時間 係数 (%)	二輪車 (台)
15:00-15:15	63	41	104	39.4	1.4	0	114	54	168	32.1	1.4	3
15:15-15:30	52	31	83	37.3	1.1	1	118	49	167	29.3	1.4	3
15:30-15:45	56	20	76	26.3	1.0	1	105	28	133	21.1	1.1	6
15:45-16:00	70	31	101	30.7	1.3	0	111	37	148	25.0	1.3	0
1時間計	241	123	364	33.8	4.7	2	448	168	616	27.3	5.3	12
16:00-16:15	59	34	93	36.6	1.2	0	99	42	141	29.8	1.2	2
16:15-16:30	90	33	123	26.8	1.6	0	168	43	211	20.4	1.8	5
16:30-16:45	64	25	89	28.1	1.2	0	107	38	145	26.2	1.2	4
16:45-17:00	73	36	109	33.0	1.4	0	135	51	186	27.4	1.6	4
1時間計	286	128	414	30.9	5.4	0	509	174	683	25.5	5.8	15
17:00-17:15	82	24	106	22.6	1.4	2	150	36	186	19.4	1.6	6
17:15-17:30	113	18	131	13.7	1.7	2	179	33	212	15.6	1.8	15
17:30-17:45	116	21	137	15.3	1.8	5	183	31	214	14.5	1.8	17
17:45-18:00	87	14	101	13.9	1.3	1	155	21	176	11.9	1.5	10
1時間計	398	77	475	16.2	6.2	10	667	121	788	15.4	6.7	48
18:00-18:15	98	10	108	9.3	1.4	2	165	20	185	10.8	1.6	13
18:15-18:30	85	28	113	24.8	1.5	0	133	34	167	20.4	1.4	5
18:30-18:45	92	25	117	21.4	1.5	2	138	32	170	18.8	1.5	10
18:45-19:00	93	27	120	22.5	1.6	2	154	39	193	20.2	1.6	8
1時間計	368	90	458	19.7	6.0	6	590	125	715	17.5	6.1	36
昼12時間計	2890	1844	4734	39.0	61.7	35	5099	2442	7541	32.4	64.3	203
19:00-19:15	71	22	93	23.7	1.2	2	116	23	139	16.5	1.2	6
19:15-19:30	83	29	112	25.9	1.5	3	130	35	165	21.2	1.4	7
19:30-19:45	89	17	106	16.0	1.4	1	142	23	165	13.9	1.4	8
19:45-20:00	64	9	73	12.3	1.0	2	101	11	112	9.8	1.0	9
1時間計	307	77	384	20.1	5.0	8	489	92	581	15.8	5.0	30
20:00-20:15	70	20	90	22.2	1.2	1	115	23	138	16.7	1.2	9
20:15-20:30	54	16	70	22.9	0.9	4	95	20	115	17.4	1.0	8
20:30-20:45	66	8	74	10.8	1.0	0	116	14	130	10.8	1.1	3
20:45-21:00	59	14	73	19.2	1.0	2	89	22	111	19.8	0.9	9
1時間計	249	58	307	18.9	4.0	7	415	79	494	16.0	4.2	29
21:00-21:15	44	8	52	15.4	0.7	1	79	12	91	13.2	0.8	4
21:15-21:30	48	16	64	25.0	0.8	1	66	23	89	25.8	0.8	3
21:30-21:45	43	16	59	27.1	0.8	1	70	17	87	19.5	0.7	5
21:45-22:00	51	16	67	23.9	0.9	2	92	17	109	15.6	0.9	3
1時間計	186	56	242	23.1	3.2	5	307	69	376	18.4	3.2	15
22:00-22:15	36	16	52	30.8	0.7	0	59	21	80	26.3	0.7	1
22:15-22:30	46	22	68	32.4	0.9	0	81	25	106	23.6	0.9	3
22:30-22:45	48	18	66	27.3	0.9	1	79	24	103	23.3	0.9	5
22:45-23:00	31	14	45	31.1	0.6	2	48	18	66	27.3	0.6	4
1時間計	161	70	231	30.3	3.0	3	267	88	355	24.8	3.0	13

方向別自動車交通量調査表

調査地点 : 地域社会3 上川井IC

調査年月日 : 令和元年 5月14日(火) 天候: 雨のち曇り

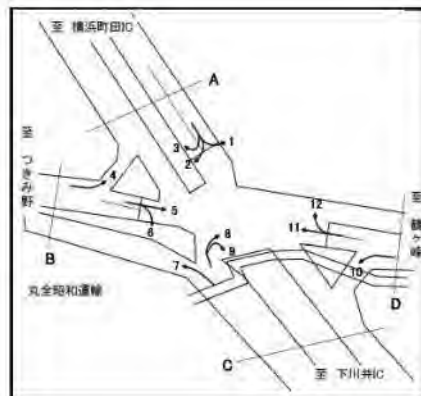

方向 時間帯	6						B 合計 (4+ 5+ 6)					
	種別 小型車 (台)	大型車 (台)	合計 (台)	大型車 混入率 (%)	時 間 係 数 (%)	二輪車 (台)	小型車 (台)	大型車 (台)	合計 (台)	大型車 混入率 (%)	時 間 係 数 (%)	二輪車 (台)
23:00-23:15	23	13	36	36.1	0.5	0	40	17	57	29.8	0.5	2
23:15-23:30	18	16	34	47.1	0.4	0	28	18	46	39.1	0.4	0
23:30-23:45	10	22	32	68.8	0.4	1	30	24	54	44.4	0.5	3
23:45-24:00	11	17	28	60.7	0.4	0	24	17	41	41.5	0.3	0
1 時間計	62	68	130	52.3	1.7	1	122	76	198	38.4	1.7	5
0:00-0:15	13	19	32	59.4	0.4	0	19	22	41	53.7	0.3	0
0:15-0:30	10	17	27	63.0	0.4	0	23	21	44	47.7	0.4	1
0:30-0:45	11	23	34	67.6	0.4	0	22	28	50	56.0	0.4	1
0:45-1:00	8	16	24	66.7	0.3	0	10	18	28	64.3	0.2	1
1 時間計	42	75	117	64.1	1.5	0	74	89	163	54.6	1.4	3
1:00-1:15	14	21	35	60.0	0.5	0	20	26	46	56.5	0.4	1
1:15-1:30	22	22	44	50.0	0.6	0	34	26	60	43.3	0.5	0
1:30-1:45	12	17	29	58.6	0.4	0	20	20	40	50.0	0.3	1
1:45-2:00	14	10	24	41.7	0.3	0	17	10	27	37.0	0.2	0
1 時間計	62	70	132	53.0	1.7	0	91	82	173	47.4	1.5	2
2:00-2:15	8	19	27	70.4	0.4	0	12	21	33	63.6	0.3	0
2:15-2:30	4	11	15	73.3	0.2	0	6	12	18	66.7	0.2	0
2:30-2:45	6	12	18	66.7	0.2	0	13	16	29	55.2	0.2	0
2:45-3:00	7	24	31	77.4	0.4	1	13	28	41	68.3	0.3	2
1 時間計	25	66	91	72.5	1.2	1	44	77	121	63.6	1.0	2
3:00-3:15	14	25	39	64.1	0.5	0	19	29	48	60.4	0.4	1
3:15-3:30	7	18	25	72.0	0.3	0	9	23	32	71.9	0.3	2
3:30-3:45	13	27	40	67.5	0.5	0	27	31	58	53.4	0.5	0
3:45-4:00	10	24	34	70.6	0.4	0	12	26	38	68.4	0.3	3
1 時間計	44	94	138	68.1	1.8	0	67	109	176	61.9	1.5	6
4:00-4:15	12	24	36	66.7	0.5	0	21	24	45	53.3	0.4	1
4:15-4:30	18	30	48	62.5	0.6	1	25	31	56	55.4	0.5	2
4:30-4:45	19	36	55	65.5	0.7	3	28	37	65	56.9	0.6	6
4:45-5:00	33	43	76	56.6	1.0	1	47	48	95	50.5	0.8	3
1 時間計	82	133	215	61.9	2.8	5	121	140	261	53.6	2.2	12
5:00-5:15	35	57	92	62.0	1.2	2	52	64	116	55.2	1.0	3
5:15-5:30	57	54	111	48.6	1.4	0	81	59	140	42.1	1.2	6
5:30-5:45	91	55	146	37.7	1.9	5	126	60	186	32.3	1.6	14
5:45-6:00	77	57	134	42.5	1.7	3	109	68	177	38.4	1.5	7
1 時間計	260	223	483	46.2	6.3	10	368	251	619	40.5	5.3	30
6:00-6:15	103	49	152	32.2	2.0	3	141	56	197	28.4	1.7	7
6:15-6:30	75	38	113	33.6	1.5	1	118	49	167	29.3	1.4	11
6:30-6:45	72	48	120	40.0	1.6	0	117	59	176	33.5	1.5	7
6:45-7:00	51	34	85	40.0	1.1	3	76	46	122	37.7	1.0	10
1 時間計	301	169	470	36.0	6.1	7	452	210	662	31.7	5.6	35
夜12時間計	1781	1159	2940	39.4	38.3	47	2817	1362	4179	32.6	35.7	182
全時間合計	4671	3003	7674	39.1	100.0	82	7916	3804	11720	32.5	100.0	385
昼 夜 率	1.62	1.63	1.62	-	-	2.34	1.55	1.56	1.55	-	-	1.90

方向別自動車交通量調査表

調査地点：地域社会3 上川井1C

調査年月日：令和元年 5月14日(火) 天候：雨のち曇り

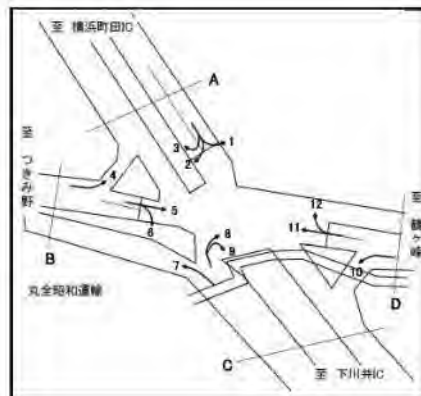

方向	7						8						
	種別	小型車 (台)	大型車 (台)	合計 (台)	大型車 混入率 (%)	時間 係数 (%)	二輪車 (台)	小型車 (台)	大型車 (台)	合計 (台)	大型車 混入率 (%)	時間 係数 (%)	二輪車 (台)
7:00-7:15		42	33	75	44.0	1.1	0	18	2	20	10.0	1.1	1
7:15-7:30		49	34	83	41.0	1.2	3	29	2	31	6.5	1.8	0
7:30-7:45		60	38	98	38.8	1.4	1	29	4	33	12.1	1.9	1
7:45-8:00		48	25	73	34.2	1.1	2	36	5	41	12.2	2.3	0
1時間計		199	130	329	39.5	4.8	6	112	13	125	10.4	7.1	2
8:00-8:15		45	34	79	43.0	1.2	3	35	5	40	12.5	2.3	0
8:15-8:30		57	27	84	32.1	1.2	4	31	4	35	11.4	2.0	0
8:30-8:45		58	33	91	36.3	1.3	0	53	8	61	13.1	3.5	0
8:45-9:00		50	43	93	46.2	1.4	0	29	1	30	3.3	1.7	0
1時間計		210	137	347	39.5	5.1	7	148	18	166	10.8	9.4	0
9:00-9:15		49	45	94	47.9	1.4	0	12	0	12	0.0	0.7	0
9:15-9:30		23	39	62	62.9	0.9	1	40	4	44	9.1	2.5	0
9:30-9:45		51	46	97	47.4	1.4	0	22	6	28	21.4	1.6	0
9:45-10:00		34	41	75	54.7	1.1	0	24	3	27	11.1	1.5	1
1時間計		157	171	328	52.1	4.8	1	98	13	111	11.7	6.3	1
10:00-10:15		33	46	79	58.2	1.2	1	18	3	21	14.3	1.2	0
10:15-10:30		46	57	103	55.3	1.5	0	13	0	13	0.0	0.7	0
10:30-10:45		51	49	100	49.0	1.5	0	22	4	26	15.4	1.5	0
10:45-11:00		52	39	91	42.9	1.3	1	19	5	24	20.8	1.4	0
1時間計		182	191	373	51.2	5.4	2	72	12	84	14.3	4.8	0
11:00-11:15		58	61	119	51.3	1.7	0	14	2	16	12.5	0.9	0
11:15-11:30		41	55	96	57.3	1.4	0	23	4	27	14.8	1.5	0
11:30-11:45		27	53	80	66.3	1.2	1	25	6	31	19.4	1.8	0
11:45-12:00		38	54	92	58.7	1.3	0	25	7	32	21.9	1.8	0
1時間計		164	223	387	57.6	5.6	1	87	19	106	17.9	6.0	0
12:00-12:15		46	50	96	52.1	1.4	0	34	3	37	8.1	2.1	0
12:15-12:30		39	56	95	58.9	1.4	0	13	6	19	31.6	1.1	0
12:30-12:45		48	36	84	42.9	1.2	0	23	11	34	32.4	1.9	0
12:45-13:00		41	34	75	45.3	1.1	0	16	2	18	11.1	1.0	0
1時間計		174	176	350	50.3	5.1	0	86	22	108	20.4	6.1	0
13:00-13:15		51	55	106	51.9	1.5	0	24	0	24	0.0	1.4	0
13:15-13:30		38	35	73	47.9	1.1	0	13	2	15	13.3	0.9	0
13:30-13:45		40	42	82	51.2	1.2	0	34	5	39	12.8	2.2	0
13:45-14:00		43	28	71	39.4	1.0	0	17	6	23	26.1	1.3	0
1時間計		172	160	332	48.2	4.8	0	88	13	101	12.9	5.7	0
14:00-14:15		42	46	88	52.3	1.3	0	20	3	23	13.0	1.3	0
14:15-14:30		35	49	84	58.3	1.2	1	15	7	22	31.8	1.2	0
14:30-14:45		31	43	74	58.1	1.1	3	19	8	27	29.6	1.5	0
14:45-15:00		37	57	94	60.6	1.4	1	18	11	29	37.9	1.6	0
1時間計		145	195	340	57.4	5.0	5	72	29	101	28.7	5.7	0

方向別自動車交通量調査表

調査地点 : 地域社会3 上川井1C

調査年月日 : 令和元年 5月14日(火) 天候: 雨のち曇り

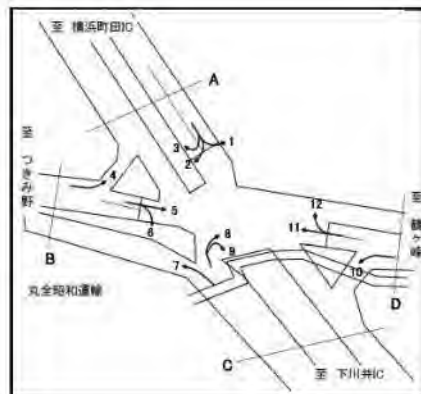

方向 種別 時間帯	7						8					
	小型車 (台)	大型車 (台)	合計 (台)	大型車 混入率 (%)	時 間 係 数 (%)	二輪車 (台)	小型車 (台)	大型車 (台)	合計 (台)	大型車 混入率 (%)	時 間 係 数 (%)	二輪車 (台)
15:00-15:15	37	38	75	50.7	1.1	0	19	6	25	24.0	1.4	0
15:15-15:30	52	39	91	42.9	1.3	2	23	7	30	23.3	1.7	0
15:30-15:45	66	51	117	43.6	1.7	1	20	6	26	23.1	1.5	0
15:45-16:00	59	48	107	44.9	1.6	1	30	8	38	21.1	2.2	2
1時間計	214	176	390	45.1	5.7	4	92	27	119	22.7	6.7	2
16:00-16:15	59	36	95	37.9	1.4	2	27	6	33	18.2	1.9	0
16:15-16:30	33	43	76	56.6	1.1	0	28	9	37	24.3	2.1	0
16:30-16:45	88	50	138	36.2	2.0	1	19	10	29	34.5	1.6	1
16:45-17:00	60	46	106	43.4	1.5	0	23	5	28	17.9	1.6	0
1時間計	240	175	415	42.2	6.1	3	97	30	127	23.6	7.2	1
17:00-17:15	61	32	93	34.4	1.4	0	28	4	32	12.5	1.8	0
17:15-17:30	65	29	94	30.9	1.4	0	27	6	33	18.2	1.9	0
17:30-17:45	68	33	101	32.7	1.5	4	21	4	25	16.0	1.4	1
17:45-18:00	60	31	91	34.1	1.3	2	31	5	36	13.9	2.0	1
1時間計	254	125	379	33.0	5.5	6	107	19	126	15.1	7.1	2
18:00-18:15	64	30	94	31.9	1.4	0	23	8	31	25.8	1.8	0
18:15-18:30	65	23	88	26.1	1.3	0	24	1	25	4.0	1.4	0
18:30-18:45	56	16	72	22.2	1.1	0	13	6	19	31.6	1.1	0
18:45-19:00	67	22	89	24.7	1.3	1	24	2	26	7.7	1.5	0
1時間計	252	91	343	26.5	5.0	1	84	17	101	16.8	5.7	0
昼12時間計	2363	1950	4313	45.2	62.9	36	1143	232	1375	16.9	77.9	8
19:00-19:15	56	14	70	20.0	1.0	0	24	3	27	11.1	1.5	0
19:15-19:30	58	13	71	18.3	1.0	0	16	3	19	15.8	1.1	0
19:30-19:45	53	14	67	20.9	1.0	0	25	1	26	3.8	1.5	0
19:45-20:00	40	8	48	16.7	0.7	0	17	1	18	5.6	1.0	0
1時間計	207	49	256	19.1	3.7	0	82	8	90	8.9	5.1	0
20:00-20:15	58	14	72	19.4	1.1	0	12	3	15	20.0	0.9	0
20:15-20:30	56	18	74	24.3	1.1	1	21	0	21	0.0	1.2	0
20:30-20:45	53	11	64	17.2	0.9	0	19	2	21	9.5	1.2	0
20:45-21:00	52	22	74	29.7	1.1	2	10	2	12	16.7	0.7	0
1時間計	219	65	284	22.9	4.1	3	62	7	69	10.1	3.9	0
21:00-21:15	41	29	70	41.4	1.0	0	9	0	9	0.0	0.5	0
21:15-21:30	46	21	67	31.3	1.0	0	11	0	11	0.0	0.6	0
21:30-21:45	33	15	48	31.3	0.7	0	4	0	4	0.0	0.2	0
21:45-22:00	29	13	42	31.0	0.6	1	3	0	3	0.0	0.2	0
1時間計	149	78	227	34.4	3.3	1	27	0	27	0.0	1.5	0
22:00-22:15	38	16	54	29.6	0.8	1	5	1	6	16.7	0.3	0
22:15-22:30	36	10	46	21.7	0.7	1	7	1	8	12.5	0.5	0
22:30-22:45	30	15	45	33.3	0.7	2	4	0	4	0.0	0.2	0
22:45-23:00	31	22	53	41.5	0.8	1	1	0	1	0.0	0.1	0
1時間計	135	63	198	31.8	2.9	5	17	2	19	10.5	1.1	0

方向別自動車交通量調査表

調査地点 : 地域社会3 上川井1C

調査年月日 : 令和元年 5月14日(火) 天候:雨のち曇り



方向 種別 時間帯	7						8					
	小型車 (台)	大型車 (台)	合計 (台)	大型車 混入率 (%)	時間 係数 (%)	二輪車 (台)	小型車 (台)	大型車 (台)	合計 (台)	大型車 混入率 (%)	時間 係数 (%)	二輪車 (台)
23:00-23:15	24	15	39	38.5	0.6	0	2	0	2	0.0	0.1	0
23:15-23:30	18	14	32	43.8	0.5	0	7	2	9	22.2	0.5	0
23:30-23:45	19	10	29	34.5	0.4	0	4	1	5	20.0	0.3	0
23:45-24:00	18	9	27	33.3	0.4	0	4	0	4	0.0	0.2	0
1時間計	79	48	127	37.8	1.9	0	17	3	20	15.0	1.1	0
0:00-0:15	15	8	23	34.8	0.3	0	2	0	2	0.0	0.1	0
0:15-0:30	16	11	27	40.7	0.4	0	5	0	5	0.0	0.3	0
0:30-0:45	9	10	19	52.6	0.3	0	3	0	3	0.0	0.2	0
0:45-1:00	16	15	31	48.4	0.5	0	6	0	6	0.0	0.3	0
1時間計	56	44	100	44.0	1.5	0	16	0	16	0.0	0.9	0
1:00-1:15	19	21	40	52.5	0.6	1	3	1	4	25.0	0.2	0
1:15-1:30	10	14	24	58.3	0.4	0	4	4	8	50.0	0.5	0
1:30-1:45	5	13	18	72.2	0.3	0	1	0	1	0.0	0.1	0
1:45-2:00	10	18	28	64.3	0.4	1	2	1	3	33.3	0.2	0
1時間計	44	66	110	60.0	1.6	2	10	6	16	37.5	0.9	0
2:00-2:15	8	21	29	72.4	0.4	0	3	0	3	0.0	0.2	0
2:15-2:30	6	23	29	79.3	0.4	0	1	1	2	50.0	0.1	0
2:30-2:45	9	24	33	72.7	0.5	0	1	0	1	0.0	0.1	0
2:45-3:00	7	31	38	81.6	0.6	0	1	2	3	66.7	0.2	0
1時間計	30	99	129	76.7	1.9	0	6	3	9	33.3	0.5	0
3:00-3:15	3	24	27	88.9	0.4	0	1	1	2	50.0	0.1	0
3:15-3:30	4	15	19	78.9	0.3	0	2	1	3	33.3	0.2	0
3:30-3:45	4	18	22	81.8	0.3	0	1	1	2	50.0	0.1	0
3:45-4:00	10	31	41	75.6	0.6	0	2	2	4	50.0	0.2	0
1時間計	21	88	109	80.7	1.6	0	6	5	11	45.5	0.6	0
4:00-4:15	11	23	34	67.6	0.5	0	0	1	1	100.0	0.1	0
4:15-4:30	11	21	32	65.6	0.5	1	4	0	4	0.0	0.2	0
4:30-4:45	11	26	37	70.3	0.5	0	2	0	2	0.0	0.1	0
4:45-5:00	23	33	56	58.9	0.8	0	6	2	8	25.0	0.5	0
1時間計	56	103	159	64.8	2.3	1	12	3	15	20.0	0.9	0
5:00-5:15	16	48	64	75.0	0.9	0	6	0	6	0.0	0.3	0
5:15-5:30	24	40	64	62.5	0.9	0	6	5	11	45.5	0.6	1
5:30-5:45	40	54	94	57.4	1.4	2	3	0	3	0.0	0.2	0
5:45-6:00	51	49	100	49.0	1.5	0	9	0	9	0.0	0.5	1
1時間計	131	191	322	59.3	4.7	2	24	5	29	17.2	1.6	2
6:00-6:15	75	55	130	42.3	1.9	1	9	0	9	0.0	0.5	1
6:15-6:30	68	48	116	41.4	1.7	1	19	1	20	5.0	1.1	1
6:30-6:45	92	54	146	37.0	2.1	4	19	9	28	32.1	1.6	0
6:45-7:00	87	39	126	31.0	1.8	3	8	3	11	27.3	0.6	1
1時間計	322	196	518	37.8	7.6	9	55	13	68	19.1	3.9	3
夜12時間計	1449	1090	2539	42.9	37.1	23	334	55	389	14.1	22.1	5
全時間合計	3812	3040	6852	44.4	100.0	59	1477	287	1764	16.3	100.0	13
昼夜率	1.61	1.56	1.59	-	-	1.64	1.29	1.24	1.28	-	-	1.63

方向別自動車交通量調査表

調査地点：地域社会3 上川井1C

調査年月日：令和元年 5月14日(火) 天候：雨のち曇り

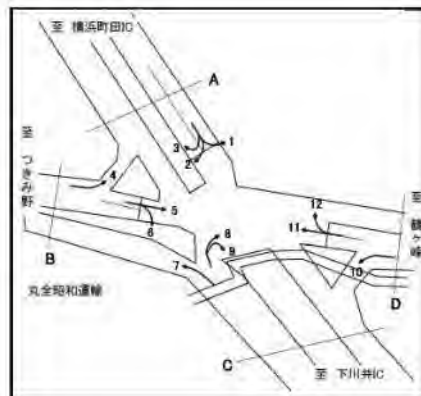

時間帯	種別	g					C 合計 (7+ 8+ 9)						
		小型車 (台)	大型車 (台)	合計 (台)	大型車 混入率 (%)	時間 係数 (%)	二輪車 (台)	小型車 (台)	大型車 (台)	合計 (台)	大型車 混入率 (%)	時間 係数 (%)	二輪車 (台)
7:00-7:15		0	0	0	0.0	0.0	0	60	35	95	36.8	1.1	1
7:15-7:30		0	0	0	0.0	0.0	0	78	36	114	31.6	1.3	3
7:30-7:45		0	0	0	0.0	0.0	0	89	42	131	32.1	1.5	2
7:45-8:00		0	0	0	0.0	0.0	0	84	30	114	26.3	1.3	2
1時間計		0	0	0	0.0	0.0	0	311	143	454	31.5	5.3	8
8:00-8:15		0	0	0	0.0	0.0	0	80	39	119	32.8	1.4	3
8:15-8:30		0	0	0	0.0	0.0	0	88	31	119	26.1	1.4	4
8:30-8:45		0	0	0	0.0	0.0	0	111	41	152	27.0	1.8	0
8:45-9:00		0	0	0	0.0	0.0	0	79	44	123	35.8	1.4	0
1時間計		0	0	0	0.0	0.0	0	358	155	513	30.2	5.9	7
9:00-9:15		0	0	0	0.0	0.0	0	61	45	106	42.5	1.2	0
9:15-9:30		0	0	0	0.0	0.0	0	63	43	106	40.6	1.2	1
9:30-9:45		0	0	0	0.0	0.0	0	73	52	125	41.6	1.4	0
9:45-10:00		0	0	0	0.0	0.0	0	58	44	102	43.1	1.2	1
1時間計		0	0	0	0.0	0.0	0	255	184	439	41.9	5.1	2
10:00-10:15		0	0	0	0.0	0.0	0	51	49	100	49.0	1.2	1
10:15-10:30		0	0	0	0.0	0.0	0	59	57	116	49.1	1.3	0
10:30-10:45		0	0	0	0.0	0.0	0	73	53	126	42.1	1.5	0
10:45-11:00		0	0	0	0.0	0.0	0	71	44	115	38.3	1.3	1
1時間計		0	0	0	0.0	0.0	0	254	203	457	44.4	5.3	2
11:00-11:15		0	0	0	0.0	0.0	0	72	63	135	46.7	1.6	0
11:15-11:30		0	0	0	0.0	0.0	0	64	59	123	48.0	1.4	0
11:30-11:45		0	0	0	0.0	0.0	0	52	59	111	53.2	1.3	1
11:45-12:00		0	0	0	0.0	0.0	0	63	61	124	49.2	1.4	0
1時間計		0	0	0	0.0	0.0	0	251	242	493	49.1	5.7	1
12:00-12:15		1	0	1	0.0	12.5	0	81	53	134	39.6	1.6	0
12:15-12:30		1	0	1	0.0	12.5	0	53	62	115	53.9	1.3	0
12:30-12:45		0	0	0	0.0	0.0	0	71	47	118	39.8	1.4	0
12:45-13:00		0	0	0	0.0	0.0	0	57	36	93	38.7	1.1	0
1時間計		2	0	2	0.0	25.0	0	262	198	460	43.0	5.3	0
13:00-13:15		0	0	0	0.0	0.0	0	75	55	130	42.3	1.5	0
13:15-13:30		0	0	0	0.0	0.0	0	51	37	88	42.0	1.0	0
13:30-13:45		0	1	1	100.0	12.5	0	74	48	122	39.3	1.4	0
13:45-14:00		0	0	0	0.0	0.0	0	60	34	94	36.2	1.1	0
1時間計		0	1	1	100.0	12.5	0	260	174	434	40.1	5.0	0
14:00-14:15		0	0	0	0.0	0.0	0	62	49	111	44.1	1.3	0
14:15-14:30		0	0	0	0.0	0.0	0	50	56	106	52.8	1.2	1
14:30-14:45		0	0	0	0.0	0.0	0	50	51	101	50.5	1.2	3
14:45-15:00		1	0	1	0.0	12.5	0	56	68	124	54.8	1.4	1
1時間計		1	0	1	0.0	12.5	0	218	224	442	50.7	5.1	5

方向別自動車交通量調査表

調査地点 : 地域社会3 上川井1C

調査年月日 : 令和元年 5月14日(火) 天候: 雨のち曇り

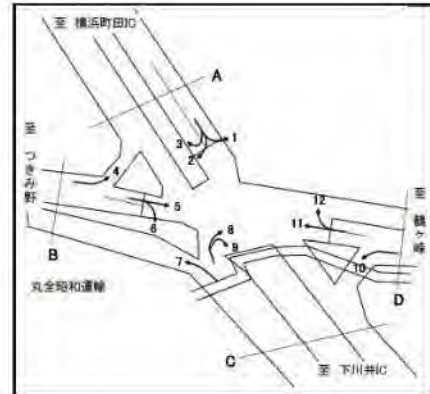

方向 時間帯	g						C 合計 (7+ 8+ 9)					
	種別 小型車 (台)	大型車 (台)	合計 (台)	大型車 混入率 (%)	時間 係数 (%)	二輪車 (台)	小型車 (台)	大型車 (台)	合計 (台)	大型車 混入率 (%)	時間 係数 (%)	二輪車 (台)
15:00-15:15	0	0	0	0.0	0.0	0	56	44	100	44.0	1.2	0
15:15-15:30	0	0	0	0.0	0.0	0	75	46	121	38.0	1.4	2
15:30-15:45	0	0	0	0.0	0.0	0	86	57	143	39.9	1.7	1
15:45-16:00	1	0	1	0.0	12.5	0	90	56	146	38.4	1.7	3
1時間計	1	0	1	0.0	12.5	0	307	203	510	39.8	5.9	6
16:00-16:15	0	0	0	0.0	0.0	0	86	42	128	32.8	1.5	2
16:15-16:30	0	0	0	0.0	0.0	0	61	52	113	46.0	1.3	0
16:30-16:45	0	0	0	0.0	0.0	0	107	60	167	35.9	1.9	2
16:45-17:00	0	0	0	0.0	0.0	0	83	51	134	38.1	1.6	0
1時間計	0	0	0	0.0	0.0	0	337	205	542	37.8	6.3	4
17:00-17:15	0	0	0	0.0	0.0	0	89	36	125	28.8	1.4	0
17:15-17:30	0	0	0	0.0	0.0	0	92	35	127	27.6	1.5	0
17:30-17:45	0	0	0	0.0	0.0	0	89	37	126	29.4	1.5	5
17:45-18:00	0	0	0	0.0	0.0	0	91	36	127	28.3	1.5	3
1時間計	0	0	0	0.0	0.0	0	361	144	505	28.5	5.9	8
18:00-18:15	0	0	0	0.0	0.0	0	87	38	125	30.4	1.4	0
18:15-18:30	0	0	0	0.0	0.0	0	89	24	113	21.2	1.3	0
18:30-18:45	0	0	0	0.0	0.0	0	69	22	91	24.2	1.1	0
18:45-19:00	1	0	1	0.0	12.5	0	92	24	116	20.7	1.3	1
1時間計	1	0	1	0.0	12.5	0	337	108	445	24.3	5.2	1
昼12時間計	5	1	6	16.7	75.0	0	3511	2183	5694	38.3	66.0	44
19:00-19:15	0	0	0	0.0	0.0	0	80	17	97	17.5	1.1	0
19:15-19:30	0	0	0	0.0	0.0	0	74	16	90	17.8	1.0	0
19:30-19:45	0	0	0	0.0	0.0	0	78	15	93	16.1	1.1	0
19:45-20:00	0	0	0	0.0	0.0	0	57	9	66	13.6	0.8	0
1時間計	0	0	0	0.0	0.0	0	289	57	346	16.5	4.0	0
20:00-20:15	1	0	1	0.0	12.5	0	71	17	88	19.3	1.0	0
20:15-20:30	0	0	0	0.0	0.0	0	77	18	95	18.9	1.1	1
20:30-20:45	0	0	0	0.0	0.0	0	72	13	85	15.3	1.0	0
20:45-21:00	1	0	1	0.0	12.5	0	63	24	87	27.6	1.0	2
1時間計	2	0	2	0.0	25.0	0	283	72	355	20.3	4.1	3
21:00-21:15	0	0	0	0.0	0.0	0	50	29	79	36.7	0.9	0
21:15-21:30	0	0	0	0.0	0.0	0	57	21	78	26.9	0.9	0
21:30-21:45	0	0	0	0.0	0.0	0	37	15	52	28.8	0.6	0
21:45-22:00	0	0	0	0.0	0.0	0	32	13	45	28.9	0.5	1
1時間計	0	0	0	0.0	0.0	0	176	78	254	30.7	2.9	1
22:00-22:15	0	0	0	0.0	0.0	0	43	17	60	28.3	0.7	1
22:15-22:30	0	0	0	0.0	0.0	0	43	11	54	20.4	0.6	1
22:30-22:45	0	0	0	0.0	0.0	0	34	15	49	30.6	0.6	2
22:45-23:00	0	0	0	0.0	0.0	0	32	22	54	40.7	0.6	1
1時間計	0	0	0	0.0	0.0	0	152	65	217	30.0	2.5	5

方向別自動車交通量調査表

調査地点 : 地域社会3 上川井1C

調査年月日 : 令和元年 5月14日(火) 天候: 雨のち曇り

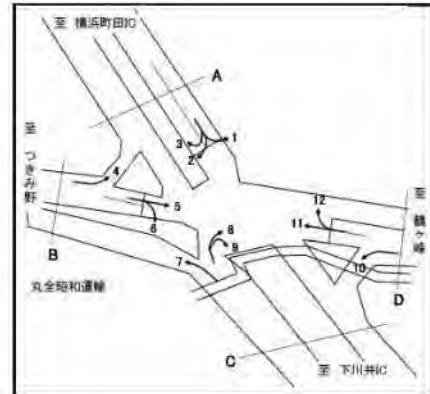

方向 時間帯	g						C 合計 (7+ 8+ 9)					
	種別 小型車 (台)	大型車 (台)	合計 (台)	大型車 混入率 (%)	時間 係数 (%)	二輪車 (台)	小型車 (台)	大型車 (台)	合計 (台)	大型車 混入率 (%)	時間 係数 (%)	二輪車 (台)
23:00-23:15	0	0	0	0.0	0.0	0	26	15	41	36.6	0.5	0
23:15-23:30	0	0	0	0.0	0.0	0	25	16	41	39.0	0.5	0
23:30-23:45	0	0	0	0.0	0.0	0	23	11	34	32.4	0.4	0
23:45-24:00	0	0	0	0.0	0.0	0	22	9	31	29.0	0.4	0
1時間計	0	0	0	0.0	0.0	0	96	51	147	34.7	1.7	0
0:00-0:15	0	0	0	0.0	0.0	0	17	8	25	32.0	0.3	0
0:15-0:30	0	0	0	0.0	0.0	0	21	11	32	34.4	0.4	0
0:30-0:45	0	0	0	0.0	0.0	0	12	10	22	45.5	0.3	0
0:45-1:00	0	0	0	0.0	0.0	0	22	15	37	40.5	0.4	0
1時間計	0	0	0	0.0	0.0	0	72	44	116	37.9	1.3	0
1:00-1:15	0	0	0	0.0	0.0	0	22	22	44	50.0	0.5	1
1:15-1:30	0	0	0	0.0	0.0	0	14	18	32	56.3	0.4	0
1:30-1:45	0	0	0	0.0	0.0	0	6	13	19	68.4	0.2	0
1:45-2:00	0	0	0	0.0	0.0	0	12	19	31	61.3	0.4	1
1時間計	0	0	0	0.0	0.0	0	54	72	126	57.1	1.5	2
2:00-2:15	0	0	0	0.0	0.0	0	11	21	32	65.6	0.4	0
2:15-2:30	0	0	0	0.0	0.0	0	7	24	31	77.4	0.4	0
2:30-2:45	0	0	0	0.0	0.0	0	10	24	34	70.6	0.4	0
2:45-3:00	0	0	0	0.0	0.0	0	8	33	41	80.5	0.5	0
1時間計	0	0	0	0.0	0.0	0	36	102	138	73.9	1.6	0
3:00-3:15	0	0	0	0.0	0.0	0	4	25	29	86.2	0.3	0
3:15-3:30	0	0	0	0.0	0.0	0	6	16	22	72.7	0.3	0
3:30-3:45	0	0	0	0.0	0.0	0	5	19	24	79.2	0.3	0
3:45-4:00	0	0	0	0.0	0.0	0	12	33	45	73.3	0.5	0
1時間計	0	0	0	0.0	0.0	0	27	93	120	77.5	1.4	0
4:00-4:15	0	0	0	0.0	0.0	0	11	24	35	68.6	0.4	0
4:15-4:30	0	0	0	0.0	0.0	0	15	21	36	58.3	0.4	1
4:30-4:45	0	0	0	0.0	0.0	0	13	26	39	66.7	0.5	0
4:45-5:00	0	0	0	0.0	0.0	0	29	35	64	54.7	0.7	0
1時間計	0	0	0	0.0	0.0	0	68	106	174	60.9	2.0	1
5:00-5:15	0	0	0	0.0	0.0	0	22	48	70	68.6	0.8	0
5:15-5:30	0	0	0	0.0	0.0	0	30	45	75	60.0	0.9	1
5:30-5:45	0	0	0	0.0	0.0	0	43	54	97	55.7	1.1	2
5:45-6:00	0	0	0	0.0	0.0	0	60	49	109	45.0	1.3	1
1時間計	0	0	0	0.0	0.0	0	155	196	351	55.8	4.1	4
6:00-6:15	0	0	0	0.0	0.0	0	84	55	139	39.6	1.6	2
6:15-6:30	0	0	0	0.0	0.0	0	87	49	136	36.0	1.6	2
6:30-6:45	0	0	0	0.0	0.0	0	111	63	174	36.2	2.0	4
6:45-7:00	0	0	0	0.0	0.0	0	95	42	137	30.7	1.6	4
1時間計	0	0	0	0.0	0.0	0	377	209	586	35.7	6.8	12
夜12時間計	2	0	2	0.0	25.0	0	1785	1145	2930	39.1	34.0	28
全時間合計	7	1	8	12.5	100.0	0	5296	3328	8624	38.6	100.0	72
昼夜率	1.40	1.00	1.33	-	-	0.00	1.51	1.52	1.51	-	-	1.64

方向別自動車交通量調査表

調査地点 : 地域社会3 上川井1C

調査年月日 : 令和元年 5月14日(火) 天候:雨のち曇り

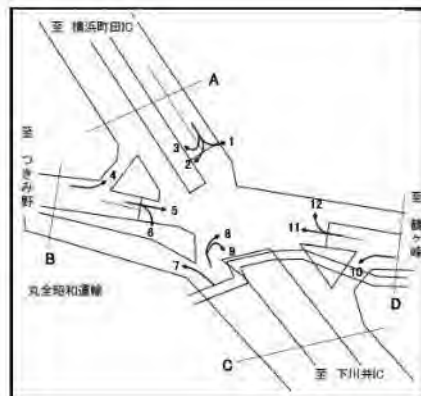

方向 時間帯	10						11					
	種別 小型車 (台)	大型車 (台)	合計 (台)	大型車 混入率 (%)	時間 係数 (%)	二輪車 (台)	小型車 (台)	大型車 (台)	合計 (台)	大型車 混入率 (%)	時間 係数 (%)	二輪車 (台)
7:00-7:15	23	7	30	23.3	2.0	0	38	9	47	19.1	1.3	7
7:15-7:30	25	4	29	13.8	2.0	0	46	15	61	24.6	1.7	4
7:30-7:45	26	4	30	13.3	2.0	0	34	4	38	10.5	1.1	12
7:45-8:00	25	4	29	13.8	2.0	0	42	9	51	17.6	1.5	6
1時間計	99	19	118	16.1	8.0	0	160	37	197	18.8	5.6	29
8:00-8:15	29	8	37	21.6	2.5	0	53	8	61	13.1	1.7	3
8:15-8:30	35	1	36	2.8	2.4	0	49	9	58	15.5	1.7	8
8:30-8:45	21	5	26	19.2	1.8	2	51	4	55	7.3	1.6	6
8:45-9:00	13	3	16	18.8	1.1	0	50	11	61	18.0	1.7	7
1時間計	98	17	115	14.8	7.8	2	203	32	235	13.6	6.7	24
9:00-9:15	11	8	19	42.1	1.3	0	50	15	65	23.1	1.9	3
9:15-9:30	19	7	26	26.9	1.8	0	36	12	48	25.0	1.4	1
9:30-9:45	7	9	16	56.3	1.1	0	41	16	57	28.1	1.6	4
9:45-10:00	7	5	12	41.7	0.8	1	35	16	51	31.4	1.5	2
1時間計	44	29	73	39.7	5.0	1	162	59	221	26.7	6.3	10
10:00-10:15	15	5	20	25.0	1.4	0	44	19	63	30.2	1.8	2
10:15-10:30	9	5	14	35.7	1.0	0	34	15	49	30.6	1.4	0
10:30-10:45	15	3	18	16.7	1.2	1	37	8	45	17.8	1.3	2
10:45-11:00	6	3	9	33.3	0.6	0	37	12	49	24.5	1.4	2
1時間計	45	16	61	26.2	4.1	1	152	54	206	26.2	5.9	6
11:00-11:15	16	4	20	20.0	1.4	0	44	9	53	17.0	1.5	2
11:15-11:30	18	3	21	14.3	1.4	0	36	10	46	21.7	1.3	2
11:30-11:45	13	1	14	7.1	1.0	0	42	11	53	20.8	1.5	1
11:45-12:00	12	0	12	0.0	0.8	0	39	11	50	22.0	1.4	0
1時間計	59	8	67	11.9	4.5	0	161	41	202	20.3	5.8	5
12:00-12:15	13	2	15	13.3	1.0	0	43	9	52	17.3	1.5	0
12:15-12:30	15	5	20	25.0	1.4	1	38	8	46	17.4	1.3	0
12:30-12:45	14	0	14	0.0	1.0	0	39	9	48	18.8	1.4	4
12:45-13:00	11	2	13	15.4	0.9	0	31	16	47	34.0	1.3	2
1時間計	53	9	62	14.5	4.2	1	151	42	193	21.8	5.5	6
13:00-13:15	28	5	33	15.2	2.2	0	38	10	48	20.8	1.4	2
13:15-13:30	13	1	14	7.1	1.0	0	47	17	64	26.6	1.8	0
13:30-13:45	11	1	12	8.3	0.8	1	37	13	50	26.0	1.4	1
13:45-14:00	16	4	20	20.0	1.4	0	30	5	35	14.3	1.0	0
1時間計	68	11	79	13.9	5.4	1	152	45	197	22.8	5.6	3
14:00-14:15	25	5	30	16.7	2.0	0	40	9	49	18.4	1.4	2
14:15-14:30	25	3	28	10.7	1.9	0	37	11	48	22.9	1.4	1
14:30-14:45	19	1	20	5.0	1.4	0	42	9	51	17.6	1.5	5
14:45-15:00	13	5	18	27.8	1.2	0	45	4	49	8.2	1.4	0
1時間計	82	14	96	14.6	6.5	0	164	33	197	16.8	5.6	8

方向別自動車交通量調査表

調査地点 : 地域社会3 上川井IC

調査年月日 : 令和元年 5月14日(火) 天候:雨のち曇り

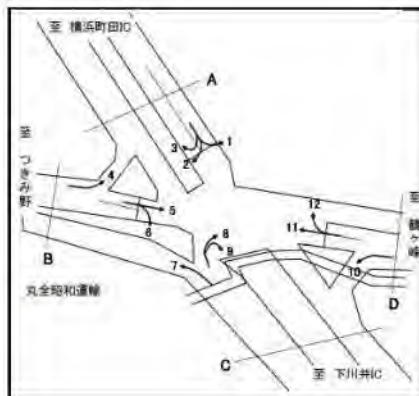

方向	10						11						
	種別	小型車 (台)	大型車 (台)	合計 (台)	大型車 混入率 (%)	時間 係数 (%)	二輪車 (台)	小型車 (台)	大型車 (台)	合計 (台)	大型車 混入率 (%)	時間 係数 (%)	二輪車 (台)
15:00-15:15		27	4	31	12.9	2.1	0	42	8	50	16.0	1.4	4
15:15-15:30		25	2	27	7.4	1.8	0	36	15	51	29.4	1.5	1
15:30-15:45		22	4	26	15.4	1.8	0	45	10	55	18.2	1.6	1
15:45-16:00		19	2	21	9.5	1.4	0	41	10	51	19.6	1.5	0
1時間計		93	12	105	11.4	7.1	0	164	43	207	20.8	5.9	6
16:00-16:15		16	1	17	5.9	1.2	1	45	13	58	22.4	1.7	0
16:15-16:30		26	6	32	18.8	2.2	1	32	5	37	13.5	1.1	3
16:30-16:45		18	2	20	10.0	1.4	0	54	14	68	20.6	1.9	3
16:45-17:00		14	4	18	22.2	1.2	0	37	3	40	7.5	1.1	6
1時間計		74	13	87	14.9	5.9	2	168	35	203	17.2	5.8	12
17:00-17:15		22	2	24	8.3	1.6	0	50	4	54	7.4	1.5	8
17:15-17:30		20	0	20	0.0	1.4	0	62	6	68	8.8	1.9	0
17:30-17:45		32	0	32	0.0	2.2	2	50	8	58	13.8	1.7	3
17:45-18:00		19	1	20	5.0	1.4	0	39	5	44	11.4	1.3	9
1時間計		93	3	96	3.1	6.5	2	201	23	224	10.3	6.4	20
18:00-18:15		28	0	28	0.0	1.9	0	49	4	53	7.5	1.5	12
18:15-18:30		24	2	26	7.7	1.8	0	45	5	50	10.0	1.4	6
18:30-18:45		11	3	14	21.4	1.0	1	54	4	58	6.9	1.7	2
18:45-19:00		18	3	21	14.3	1.4	0	43	7	50	14.0	1.4	6
1時間計		81	8	89	9.0	6.0	1	191	20	211	9.5	6.0	26
昼12時間計		889	159	1048	15.2	71.1	11	2029	464	2493	18.6	71.0	155
19:00-19:15		23	4	27	14.8	1.8	0	32	2	34	5.9	1.0	2
19:15-19:30		17	1	18	5.6	1.2	0	57	4	61	6.6	1.7	5
19:30-19:45		10	2	12	16.7	0.8	0	40	2	42	4.8	1.2	6
19:45-20:00		4	0	4	0.0	0.3	0	39	1	40	2.5	1.1	4
1時間計		54	7	61	11.5	4.1	0	168	9	177	5.1	5.0	17
20:00-20:15		14	0	14	0.0	1.0	0	32	4	36	11.1	1.0	4
20:15-20:30		14	1	15	6.7	1.0	0	43	3	46	6.5	1.3	0
20:30-20:45		14	2	16	12.5	1.1	0	33	2	35	5.7	1.0	0
20:45-21:00		9	0	9	0.0	0.6	0	16	5	21	23.8	0.6	4
1時間計		51	3	54	5.6	3.7	0	124	14	138	10.1	3.9	8
21:00-21:15		10	2	12	16.7	0.8	0	27	3	30	10.0	0.9	4
21:15-21:30		7	2	9	22.2	0.6	0	19	4	23	17.4	0.7	2
21:30-21:45		10	1	11	9.1	0.7	0	30	3	33	9.1	0.9	2
21:45-22:00		6	0	6	0.0	0.4	0	22	5	27	18.5	0.8	2
1時間計		33	5	38	13.2	2.6	0	98	15	113	13.3	3.2	10
22:00-22:15		2	0	2	0.0	0.1	0	9	5	14	35.7	0.4	1
22:15-22:30		6	0	6	0.0	0.4	0	13	3	16	18.8	0.5	0
22:30-22:45		6	1	7	14.3	0.5	0	27	2	29	6.9	0.8	0
22:45-23:00		7	1	8	12.5	0.5	0	13	2	15	13.3	0.4	3
1時間計		21	2	23	8.7	1.6	0	62	12	74	16.2	2.1	4

方向別自動車交通量調査表

調査地点：地域社会3 上川井IC

調査年月日：令和元年 5月14日(火) 天候：雨のち曇り



方向	10						11						
	種別	小型車 (台)	大型車 (台)	合計 (台)	大型車 混入率 (%)	時間 係数 (%)	二輪車 (台)	小型車 (台)	大型車 (台)	合計 (台)	大型車 混入率 (%)	時間 係数 (%)	二輪車 (台)
23:00-23:15		3	1	4	25.0	0.3	0	13	3	16	18.8	0.5	1
23:15-23:30		2	0	2	0.0	0.1	0	11	6	17	35.3	0.5	0
23:30-23:45		5	0	5	0.0	0.3	0	10	1	11	9.1	0.3	1
23:45-24:00		7	2	9	22.2	0.6	0	10	2	12	16.7	0.3	1
1時間計		17	3	20	15.0	1.4	0	44	12	56	21.4	1.6	3
0:00-0:15		6	0	6	0.0	0.4	0	6	4	10	40.0	0.3	0
0:15-0:30		2	0	2	0.0	0.1	0	8	4	12	33.3	0.3	1
0:30-0:45		2	1	3	33.3	0.2	0	10	2	12	16.7	0.3	1
0:45-1:00		0	0	0	0.0	0.0	0	6	4	10	40.0	0.3	2
1時間計		10	1	11	9.1	0.7	0	30	14	44	31.8	1.3	4
1:00-1:15		2	0	2	0.0	0.1	0	3	5	8	62.5	0.2	0
1:15-1:30		0	1	1	100.0	0.1	0	5	2	7	28.6	0.2	1
1:30-1:45		2	0	2	0.0	0.1	0	3	2	5	40.0	0.1	0
1:45-2:00		3	0	3	0.0	0.2	0	1	0	1	0.0	0.0	0
1時間計		7	1	8	12.5	0.5	0	12	9	21	42.9	0.6	1
2:00-2:15		2	0	2	0.0	0.1	0	2	2	4	50.0	0.1	2
2:15-2:30		2	2	4	50.0	0.3	0	2	1	3	33.3	0.1	1
2:30-2:45		1	1	2	50.0	0.1	0	3	2	5	40.0	0.1	0
2:45-3:00		2	1	3	33.3	0.2	0	4	5	9	55.6	0.3	3
1時間計		7	4	11	36.4	0.7	0	11	10	21	47.6	0.6	6
3:00-3:15		1	0	1	0.0	0.1	0	4	0	4	0.0	0.1	0
3:15-3:30		1	1	2	50.0	0.1	0	2	1	3	33.3	0.1	0
3:30-3:45		0	1	1	100.0	0.1	0	5	9	14	64.3	0.4	0
3:45-4:00		1	2	3	66.7	0.2	0	1	6	7	85.7	0.2	1
1時間計		3	4	7	57.1	0.5	0	12	16	28	57.1	0.8	1
4:00-4:15		2	1	3	33.3	0.2	0	4	4	8	50.0	0.2	0
4:15-4:30		2	1	3	33.3	0.2	0	2	9	11	81.8	0.3	0
4:30-4:45		10	1	11	9.1	0.7	0	7	0	7	0.0	0.2	1
4:45-5:00		3	3	6	50.0	0.4	0	6	3	9	33.3	0.3	8
1時間計		17	6	23	26.1	1.6	0	19	16	35	45.7	1.0	9
5:00-5:15		10	2	12	16.7	0.8	1	15	10	25	40.0	0.7	3
5:15-5:30		6	1	7	14.3	0.5	1	17	8	25	32.0	0.7	4
5:30-5:45		23	5	28	17.9	1.9	0	16	9	25	36.0	0.7	2
5:45-6:00		22	6	28	21.4	1.9	1	28	13	41	31.7	1.2	4
1時間計		61	14	75	18.7	5.1	3	76	40	116	34.5	3.3	13
6:00-6:15		9	0	9	0.0	0.6	0	35	12	47	25.5	1.3	4
6:15-6:30		27	6	33	18.2	2.2	1	45	9	54	16.7	1.5	3
6:30-6:45		21	2	23	8.7	1.6	0	41	15	56	26.8	1.6	9
6:45-7:00		21	8	29	27.6	2.0	0	31	9	40	22.5	1.1	3
1時間計		78	16	94	17.0	6.4	1	152	45	197	22.8	5.6	19
夜12時間計		359	66	425	15.5	28.9	4	808	212	1020	20.8	29.0	95
全時間合計		1248	225	1473	15.3	100.0	15	2837	676	3513	19.2	100.0	250
昼夜率		1.40	1.42	1.41	-	-	1.36	1.40	1.46	1.41	-	-	1.61

方向別自動車交通量調査表

調査地点 : 地域社会3 上川井IC

調査年月日 : 令和元年 5月14日(火) 天候:雨のち曇り



時間帯	種別	12						D 合計 (10+11+12)					
		小型車 (台)	大型車 (台)	合計 (台)	大型車 混入率 (%)	時間 係数 (%)	二輪車 (台)	小型車 (台)	大型車 (台)	合計 (台)	大型車 混入率 (%)	時間 係数 (%)	二輪車 (台)
7:00-7:15		41	7	48	14.6	1.8	3	102	23	125	18.4	1.6	10
7:15-7:30		56	2	58	3.4	2.2	6	127	21	148	14.2	2.0	10
7:30-7:45		47	9	56	16.1	2.2	6	107	17	124	13.7	1.6	18
7:45-8:00		44	13	57	22.8	2.2	8	111	26	137	19.0	1.8	14
1時間計		188	31	219	14.2	8.4	23	447	87	534	16.3	7.0	52
8:00-8:15		43	8	51	15.7	2.0	6	125	24	149	16.1	2.0	9
8:15-8:30		39	8	47	17.0	1.8	2	123	18	141	12.8	1.9	10
8:30-8:45		44	7	51	13.7	2.0	3	116	16	132	12.1	1.7	11
8:45-9:00		24	11	35	31.4	1.3	3	87	25	112	22.3	1.5	10
1時間計		150	34	184	18.5	7.1	14	451	83	534	15.5	7.0	40
9:00-9:15		30	4	34	11.8	1.3	0	91	27	118	22.9	1.6	3
9:15-9:30		23	6	29	20.7	1.1	0	78	25	103	24.3	1.4	1
9:30-9:45		42	13	55	23.6	2.1	0	90	38	128	29.7	1.7	4
9:45-10:00		31	13	44	29.5	1.7	2	73	34	107	31.8	1.4	5
1時間計		126	36	162	22.2	6.2	2	332	124	456	27.2	6.0	13
10:00-10:15		33	15	48	31.3	1.8	0	92	39	131	29.8	1.7	2
10:15-10:30		28	10	38	26.3	1.5	0	71	30	101	29.7	1.3	0
10:30-10:45		19	10	29	34.5	1.1	2	71	21	92	22.8	1.2	5
10:45-11:00		33	13	46	28.3	1.8	2	76	28	104	26.9	1.4	4
1時間計		113	48	161	29.8	6.2	4	310	118	428	27.6	5.6	11
11:00-11:15		19	8	27	29.6	1.0	0	79	21	100	21.0	1.3	2
11:15-11:30		30	12	42	28.6	1.6	1	84	25	109	22.9	1.4	3
11:30-11:45		27	15	42	35.7	1.6	1	82	27	109	24.8	1.4	2
11:45-12:00		25	13	38	34.2	1.5	0	76	24	100	24.0	1.3	0
1時間計		101	48	149	32.2	5.7	2	321	97	418	23.2	5.5	7
12:00-12:15		30	5	35	14.3	1.3	1	86	16	102	15.7	1.3	1
12:15-12:30		28	6	34	17.6	1.3	0	81	19	100	19.0	1.3	1
12:30-12:45		33	6	39	15.4	1.5	0	86	15	101	14.9	1.3	4
12:45-13:00		18	12	30	40.0	1.2	0	60	30	90	33.3	1.2	2
1時間計		109	29	138	21.0	5.3	1	313	80	393	20.4	5.2	8
13:00-13:15		22	7	29	24.1	1.1	0	88	22	110	20.0	1.5	2
13:15-13:30		31	10	41	24.4	1.6	2	91	28	119	23.5	1.6	2
13:30-13:45		27	12	39	30.8	1.5	0	75	26	101	25.7	1.3	2
13:45-14:00		23	14	37	37.8	1.4	0	69	23	92	25.0	1.2	0
1時間計		103	43	146	29.5	5.6	2	323	99	422	23.5	5.6	6
14:00-14:15		23	8	31	25.8	1.2	1	88	22	110	20.0	1.5	3
14:15-14:30		26	6	32	18.8	1.2	0	88	20	108	18.5	1.4	1
14:30-14:45		30	4	34	11.8	1.3	0	91	14	105	13.3	1.4	5
14:45-15:00		28	7	35	20.0	1.3	1	86	16	102	15.7	1.3	1
1時間計		107	25	132	18.9	5.1	2	353	72	425	16.9	5.6	10

方向別自動車交通量調査表

調査地点：地域社会3 上川井IC

調査年月日：令和元年 5月14日(火) 天候：雨のち曇り



時間帯	方向		12				D 合計 (10+11+12)						
	種別	小型車 (台)	大型車 (台)	合計 (台)	大型車混入率 (%)	時間係数 (%)	二輪車 (台)	小型車 (台)	大型車 (台)	合計 (台)	大型車混入率 (%)	時間係数 (%)	二輪車 (台)
15:00-15:15		32	7	39	17.9	1.5	0	101	19	120	15.8	1.6	4
15:15-15:30		20	8	28	28.6	1.1	0	81	25	106	23.6	1.4	1
15:30-15:45		24	5	29	17.2	1.1	1	91	19	110	17.3	1.5	2
15:45-16:00		35	7	42	16.7	1.6	0	95	19	114	16.7	1.5	0
1時間計		111	27	138	19.6	5.3	1	368	82	450	18.2	5.9	7
16:00-16:15		21	10	31	32.3	1.2	4	82	24	106	22.6	1.4	5
16:15-16:30		31	4	35	11.4	1.3	0	89	15	104	14.4	1.4	4
16:30-16:45		39	11	50	22.0	1.9	2	111	27	138	19.6	1.8	5
16:45-17:00		23	8	31	25.8	1.2	1	74	15	89	16.9	1.2	7
1時間計		114	33	147	22.4	5.7	7	356	81	437	18.5	5.8	21
17:00-17:15		41	5	46	10.9	1.8	2	113	11	124	8.9	1.6	10
17:15-17:30		42	5	47	10.6	1.8	5	124	11	135	8.1	1.8	5
17:30-17:45		34	4	38	10.5	1.5	3	116	12	128	9.4	1.7	8
17:45-18:00		50	3	53	5.7	2.0	7	108	9	117	7.7	1.5	16
1時間計		167	17	184	9.2	7.1	17	461	43	504	8.5	6.6	39
18:00-18:15		37	3	40	7.5	1.5	7	114	7	121	5.8	1.6	19
18:15-18:30		36	5	41	12.2	1.6	4	105	12	117	10.3	1.5	10
18:30-18:45		35	5	40	12.5	1.5	3	100	12	112	10.7	1.5	6
18:45-19:00		46	4	50	8.0	1.9	5	107	14	121	11.6	1.6	11
1時間計		154	17	171	9.9	6.6	19	426	45	471	9.6	6.2	46
昼12時間計		1543	388	1931	20.1	74.4	94	4461	1011	5472	18.5	72.2	260
19:00-19:15		27	4	31	12.9	1.2	5	82	10	92	10.9	1.2	7
19:15-19:30		28	3	31	9.7	1.2	3	102	8	110	7.3	1.5	8
19:30-19:45		30	1	31	3.2	1.2	2	80	5	85	5.9	1.1	8
19:45-20:00		17	2	19	10.5	0.7	2	60	3	63	4.8	0.8	6
1時間計		102	10	112	8.9	4.3	12	324	26	350	7.4	4.6	29
20:00-20:15		8	3	11	27.3	0.4	2	54	7	61	11.5	0.8	6
20:15-20:30		12	3	15	20.0	0.6	2	69	7	76	9.2	1.0	2
20:30-20:45		18	3	21	14.3	0.8	3	65	7	72	9.7	0.9	3
20:45-21:00		5	1	6	16.7	0.2	2	30	6	36	16.7	0.5	6
1時間計		43	10	53	18.9	2.0	9	218	27	245	11.0	3.2	17
21:00-21:15		11	2	13	15.4	0.5	1	48	7	55	12.7	0.7	5
21:15-21:30		7	0	7	0.0	0.3	0	33	6	39	15.4	0.5	2
21:30-21:45		10	3	13	23.1	0.5	0	50	7	57	12.3	0.8	2
21:45-22:00		8	2	10	20.0	0.4	1	36	7	43	16.3	0.6	3
1時間計		36	7	43	16.3	1.7	2	167	27	194	13.9	2.6	12
22:00-22:15		7	3	10	30.0	0.4	0	18	8	26	30.8	0.3	1
22:15-22:30		5	1	6	16.7	0.2	2	24	4	28	14.3	0.4	2
22:30-22:45		8	3	11	27.3	0.4	0	41	6	47	12.8	0.6	0
22:45-23:00		4	1	5	20.0	0.2	1	24	4	28	14.3	0.4	4
1時間計		24	8	32	25.0	1.2	3	107	22	129	17.1	1.7	7

方向別自動車交通量調査表

調査地点：地域社会3 上川井1C

調査年月日：令和元年 5月14日(火) 天候：雨のち曇り



時間帯	12						D 合計 (10+11+12)						
	種別	小型車 (台)	大型車 (台)	合計 (台)	大型車 混入率 (%)	時間 係数 (%)	二輪車 (台)	小型車 (台)	大型車 (台)	合計 (台)	大型車 混入率 (%)	時間 係数 (%)	二輪車 (台)
23:00-23:15		8	2	10	20.0	0.4	0	24	6	30	20.0	0.4	1
23:15-23:30		7	1	8	12.5	0.3	1	20	7	27	25.9	0.4	1
23:30-23:45		5	0	5	0.0	0.2	1	20	1	21	4.8	0.3	2
23:45-24:00		5	2	7	28.6	0.3	3	22	6	28	21.4	0.4	4
1時間計		25	5	30	16.7	1.2	5	86	20	106	18.9	1.4	8
0:00-0:15		5	4	9	44.4	0.3	0	17	8	25	32.0	0.3	0
0:15-0:30		5	1	6	16.7	0.2	1	15	5	20	25.0	0.3	2
0:30-0:45		6	0	6	0.0	0.2	0	18	3	21	14.3	0.3	1
0:45-1:00		1	1	2	50.0	0.1	0	7	5	12	41.7	0.2	2
1時間計		17	6	23	26.1	0.9	1	57	21	78	26.9	1.0	5
1:00-1:15		4	0	4	0.0	0.2	1	9	5	14	35.7	0.2	1
1:15-1:30		4	3	7	42.9	0.3	0	9	6	15	40.0	0.2	1
1:30-1:45		3	1	4	25.0	0.2	1	8	3	11	27.3	0.1	1
1:45-2:00		3	2	5	40.0	0.2	0	7	2	9	22.2	0.1	0
1時間計		14	6	20	30.0	0.8	2	33	16	49	32.7	0.6	3
2:00-2:15		7	0	7	0.0	0.3	2	11	2	13	15.4	0.2	4
2:15-2:30		1	1	2	50.0	0.1	1	5	4	9	44.4	0.1	2
2:30-2:45		3	4	7	57.1	0.3	0	7	7	14	50.0	0.2	0
2:45-3:00		3	2	5	40.0	0.2	0	9	8	17	47.1	0.2	3
1時間計		14	7	21	33.3	0.8	3	32	21	53	39.6	0.7	9
3:00-3:15		2	2	4	50.0	0.2	0	7	2	9	22.2	0.1	0
3:15-3:30		0	1	1	100.0	0.0	0	3	3	6	50.0	0.1	0
3:30-3:45		2	0	2	0.0	0.1	2	7	10	17	58.8	0.2	2
3:45-4:00		1	1	2	50.0	0.1	0	3	9	12	75.0	0.2	1
1時間計		5	4	9	44.4	0.3	2	20	24	44	54.5	0.6	3
4:00-4:15		1	2	3	66.7	0.1	1	7	7	14	50.0	0.2	1
4:15-4:30		1	2	3	66.7	0.1	1	5	12	17	70.6	0.2	1
4:30-4:45		2	2	4	50.0	0.2	1	19	3	22	13.6	0.3	2
4:45-5:00		9	7	16	43.8	0.6	1	18	13	31	41.9	0.4	9
1時間計		13	13	26	50.0	1.0	4	49	35	84	41.7	1.1	13
5:00-5:15		5	7	12	58.3	0.5	3	30	19	49	38.8	0.6	7
5:15-5:30		5	5	10	50.0	0.4	1	28	14	42	33.3	0.6	6
5:30-5:45		16	6	22	27.3	0.8	3	55	20	75	26.7	1.0	5
5:45-6:00		20	16	36	44.4	1.4	3	70	35	105	33.3	1.4	8
1時間計		46	34	80	42.5	3.1	10	183	88	271	32.5	3.6	26
6:00-6:15		33	8	41	19.5	1.6	4	77	20	97	20.6	1.3	8
6:15-6:30		43	9	52	17.3	2.0	2	115	24	139	17.3	1.8	6
6:30-6:45		42	11	53	20.8	2.0	10	104	28	132	21.2	1.7	19
6:45-7:00		57	13	70	18.6	2.7	3	109	30	139	21.6	1.8	6
1時間計		175	41	216	19.0	8.3	19	405	102	507	20.1	6.7	39
夜12時間計		514	151	665	22.7	25.6	72	1681	429	2110	20.3	27.8	171
全時間合計		2057	539	2596	20.8	100.0	166	6142	1440	7582	19.0	100.0	431
昼夜率		1.33	1.39	1.34	-	-	1.77	1.38	1.42	1.39	-	-	1.66

方向別自動車交通量調査表

調査地点：地域社会4 滝沢

調査年月日：令和2年9月29日(火) 天候：曇りのち晴れ



方向	1						2						
	種別	小型車 (台)	大型車 (台)	合計 (台)	大型車 混入率 (%)	時間 係数 (%)	二輪車 (台)	小型車 (台)	大型車 (台)	合計 (台)	大型車 混入率 (%)	時間 係数 (%)	二輪車 (台)
7:00-7:15		13	1	14	7.1	0.8	1	143	18	161	11.2	2.2	16
7:15-7:30		10	1	11	9.1	0.6	0	131	24	155	15.5	2.1	17
7:30-7:45		16	0	16	0.0	0.9	0	120	32	152	21.1	2.1	13
7:45-8:00		20	3	23	13.0	1.2	2	127	17	144	11.8	1.9	7
1時間計		59	5	64	7.8	3.5	3	521	91	612	14.9	8.3	53
8:00-8:15		20	2	22	9.1	1.2	3	158	18	176	10.2	2.4	20
8:15-8:30		19	0	19	0.0	1.0	5	117	21	138	15.2	1.9	15
8:30-8:45		15	0	15	0.0	0.8	1	101	21	122	17.2	1.6	3
8:45-9:00		11	4	15	26.7	0.8	0	88	14	102	13.7	1.4	5
1時間計		65	6	71	8.5	3.8	9	464	74	538	13.8	7.3	43
9:00-9:15		20	2	22	9.1	1.2	0	105	25	130	19.2	1.8	6
9:15-9:30		16	1	17	5.9	0.9	0	83	23	106	21.7	1.4	8
9:30-9:45		22	5	27	18.5	1.5	1	98	18	116	15.5	1.6	3
9:45-10:00		17	7	24	29.2	1.3	0	95	21	116	18.1	1.6	7
1時間計		75	15	90	16.7	4.9	1	381	87	468	18.6	6.3	24
10:00-10:15		15	2	17	11.8	0.9	1	88	32	120	26.7	1.6	6
10:15-10:30		20	3	23	13.0	1.2	4	76	22	98	22.4	1.3	4
10:30-10:45		25	2	27	7.4	1.5	1	85	29	114	25.4	1.5	5
10:45-11:00		26	4	30	13.3	1.6	1	72	15	87	17.2	1.2	7
1時間計		86	11	97	11.3	5.2	7	321	98	419	23.4	5.7	22
11:00-11:15		14	1	15	6.7	0.8	0	105	18	123	14.6	1.7	7
11:15-11:30		15	7	22	31.8	1.2	2	67	15	82	18.3	1.1	2
11:30-11:45		21	3	24	12.5	1.3	1	105	26	131	19.8	1.8	7
11:45-12:00		20	6	26	23.1	1.4	1	82	21	103	20.4	1.4	4
1時間計		70	17	87	19.5	4.7	4	359	80	439	18.2	5.9	20
12:00-12:15		25	4	29	13.8	1.6	0	80	22	102	21.6	1.4	6
12:15-12:30		17	6	23	26.1	1.2	0	70	17	87	19.5	1.2	6
12:30-12:45		21	8	29	27.6	1.6	6	92	21	113	18.6	1.5	4
12:45-13:00		18	3	21	14.3	1.1	0	88	12	100	12.0	1.4	2
1時間計		81	21	102	20.6	5.5	6	330	72	402	17.9	5.4	18
13:00-13:15		28	4	32	12.5	1.7	1	83	19	102	18.6	1.4	4
13:15-13:30		27	3	30	10.0	1.6	0	95	12	107	11.2	1.4	3
13:30-13:45		15	5	20	25.0	1.1	2	87	27	114	23.7	1.5	3
13:45-14:00		24	2	26	7.7	1.4	0	73	13	86	15.1	1.2	5
1時間計		94	14	108	13.0	5.8	3	338	71	409	17.4	5.5	15
14:00-14:15		32	6	38	15.8	2.1	0	86	22	108	20.4	1.5	5
14:15-14:30		39	4	43	9.3	2.3	0	82	26	108	24.1	1.5	3
14:30-14:45		28	4	32	12.5	1.7	0	81	15	96	15.6	1.3	1
14:45-15:00		33	2	35	5.7	1.9	0	70	12	82	14.6	1.1	6
1時間計		132	16	148	10.8	8.0	0	319	75	394	19.0	5.3	15

方向別自動車交通量調査表

調査地点：地域社会4 滝沢

調査年月日：令和2年9月29日(火) 天候：曇りのち晴れ



方向 種別 時間帯	1						2					
	小型車 (台)	大型車 (台)	合計 (台)	大型車 混入率 (%)	時間 係数 (%)	二輪車 (台)	小型車 (台)	大型車 (台)	合計 (台)	大型車 混入率 (%)	時間 係数 (%)	二輪車 (台)
15:00-15:15	19	7	26	26.9	1.4	3	90	17	107	15.9	1.4	4
15:15-15:30	26	4	30	13.3	1.6	0	115	25	140	17.9	1.9	3
15:30-15:45	33	8	41	19.5	2.2	4	73	16	89	18.0	1.2	9
15:45-16:00	27	4	31	12.9	1.7	0	82	25	107	23.4	1.4	9
1時間計	105	23	128	18.0	6.9	7	360	83	443	18.7	6.0	25
16:00-16:15	38	9	47	19.1	2.5	0	95	13	108	12.0	1.5	8
16:15-16:30	27	6	33	18.2	1.8	0	103	12	115	10.4	1.6	6
16:30-16:45	30	4	34	11.8	1.8	1	98	15	113	13.3	1.5	8
16:45-17:00	40	3	43	7.0	2.3	0	103	10	113	8.8	1.5	8
1時間計	135	22	157	14.0	8.5	1	399	50	449	11.1	6.1	30
17:00-17:15	29	7	36	19.4	1.9	0	103	13	116	11.2	1.6	2
17:15-17:30	27	5	32	15.6	1.7	3	94	7	101	6.9	1.4	12
17:30-17:45	44	6	50	12.0	2.7	1	134	14	148	9.5	2.0	22
17:45-18:00	29	2	31	6.5	1.7	1	101	12	113	10.6	1.5	10
1時間計	129	20	149	13.4	8.1	5	432	46	478	9.6	6.5	46
18:00-18:15	35	4	39	10.3	2.1	1	111	11	122	9.0	1.6	13
18:15-18:30	20	0	20	0.0	1.1	3	115	6	121	5.0	1.6	5
18:30-18:45	44	3	47	6.4	2.5	1	122	8	130	6.2	1.8	9
18:45-19:00	20	2	22	9.1	1.2	0	123	13	136	9.6	1.8	11
1時間計	119	9	128	7.0	6.9	5	471	38	509	7.5	6.9	38
昼12時間計	1150	179	1329	13.5	71.9	51	4695	865	5560	15.6	75.1	349
19:00-19:15	35	6	41	14.6	2.2	0	112	4	116	3.4	1.6	11
19:15-19:30	34	2	36	5.6	1.9	1	112	5	117	4.3	1.6	6
19:30-19:45	34	2	36	5.6	1.9	2	111	10	121	8.3	1.6	12
19:45-20:00	16	0	16	0.0	0.9	2	84	1	85	1.2	1.1	12
1時間計	119	10	129	7.8	7.0	5	419	20	439	4.6	5.9	41
20:00-20:15	16	1	17	5.9	0.9	1	82	9	91	9.9	1.2	13
20:15-20:30	18	1	19	5.3	1.0	0	80	1	81	1.2	1.1	7
20:30-20:45	16	0	16	0.0	0.9	1	57	3	60	5.0	0.8	7
20:45-21:00	14	1	15	6.7	0.8	1	46	1	47	2.1	0.6	11
1時間計	64	3	67	4.5	3.6	3	265	14	279	5.0	3.8	38
21:00-21:15	21	2	23	8.7	1.2	2	55	2	57	3.5	0.8	7
21:15-21:30	16	0	16	0.0	0.9	1	49	1	50	2.0	0.7	2
21:30-21:45	18	1	19	5.3	1.0	1	40	1	41	2.4	0.6	2
21:45-22:00	11	0	11	0.0	0.6	0	28	2	30	6.7	0.4	4
1時間計	66	3	69	4.3	3.7	4	172	6	178	3.4	2.4	15
22:00-22:15	10	2	12	16.7	0.6	0	34	0	34	0.0	0.5	2
22:15-22:30	12	0	12	0.0	0.6	1	27	2	29	6.9	0.4	1
22:30-22:45	6	0	6	0.0	0.3	1	19	1	20	5.0	0.3	3
22:45-23:00	2	3	5	60.0	0.3	0	19	1	20	5.0	0.3	2
1時間計	30	5	35	14.3	1.9	2	99	4	103	3.9	1.4	8

方向別自動車交通量調査表

調査地点：地域社会4 滝沢

調査年月日：令和2年9月29日(火) 天候：曇りのち晴れ



方向	1						2							
	種別	小型車 (台)	大型車 (台)	合計 (台)	大型車 混入率 (%)	時間 係数 (%)	二輪車 (台)	種別	小型車 (台)	大型車 (台)	合計 (台)	大型車 混入率 (%)	時間 係数 (%)	二輪車 (台)
23:00-23:15		2	1	3	33.3	0.2	1		15	4	19	21.1	0.3	3
23:15-23:30		2	0	2	0.0	0.1	1		12	1	13	7.7	0.2	2
23:30-23:45		3	0	3	0.0	0.2	1		11	0	11	0.0	0.1	3
23:45-24:00		7	1	8	12.5	0.4	0		10	1	11	9.1	0.1	3
1時間計		14	2	16	12.5	0.9	3		48	6	54	11.1	0.7	11
0:00-0:15		2	0	2	0.0	0.1	0		10	2	12	16.7	0.2	1
0:15-0:30		1	0	1	0.0	0.1	0		11	4	15	26.7	0.2	0
0:30-0:45		3	2	5	40.0	0.3	0		7	8	15	53.3	0.2	3
0:45-1:00		3	1	4	25.0	0.2	0		3	4	7	57.1	0.1	1
1時間計		9	3	12	25.0	0.6	0		31	18	49	36.7	0.7	5
1:00-1:15		3	0	3	0.0	0.2	0		12	5	17	29.4	0.2	0
1:15-1:30		6	1	7	14.3	0.4	0		5	6	11	54.5	0.1	1
1:30-1:45		8	1	9	11.1	0.5	1		8	3	11	27.3	0.1	1
1:45-2:00		3	0	3	0.0	0.2	0		7	2	9	22.2	0.1	0
1時間計		20	2	22	9.1	1.2	1		32	16	48	33.3	0.6	2
2:00-2:15		3	0	3	0.0	0.2	0		7	0	7	0.0	0.1	0
2:15-2:30		0	0	0	0.0	0.0	1		8	5	13	38.5	0.2	0
2:30-2:45		3	1	4	25.0	0.2	1		5	2	7	28.6	0.1	0
2:45-3:00		0	0	0	0.0	0.0	0		3	3	6	50.0	0.1	0
1時間計		6	1	7	14.3	0.4	2		23	10	33	30.3	0.4	0
3:00-3:15		3	0	3	0.0	0.2	0		5	3	8	37.5	0.1	1
3:15-3:30		2	1	3	33.3	0.2	0		3	1	4	25.0	0.1	2
3:30-3:45		5	0	5	0.0	0.3	1		7	1	8	12.5	0.1	1
3:45-4:00		3	3	6	50.0	0.3	1		8	3	11	27.3	0.1	0
1時間計		13	4	17	23.5	0.9	2		23	8	31	25.8	0.4	4
4:00-4:15		4	0	4	0.0	0.2	0		5	2	7	28.6	0.1	0
4:15-4:30		5	0	5	0.0	0.3	1		9	3	12	25.0	0.2	0
4:30-4:45		5	0	5	0.0	0.3	2		15	4	19	21.1	0.3	2
4:45-5:00		9	1	10	10.0	0.5	0		12	3	15	20.0	0.2	1
1時間計		23	1	24	4.2	1.3	3		41	12	53	22.6	0.7	3
5:00-5:15		9	2	11	18.2	0.6	1		18	4	22	18.2	0.3	1
5:15-5:30		11	2	13	15.4	0.7	0		23	3	26	11.5	0.4	2
5:30-5:45		9	3	12	25.0	0.6	1		36	6	42	14.3	0.6	0
5:45-6:00		9	0	9	0.0	0.5	2		47	7	54	13.0	0.7	3
1時間計		38	7	45	15.6	2.4	4		124	20	144	13.9	1.9	6
6:00-6:15		17	3	20	15.0	1.1	1		80	14	94	14.9	1.3	8
6:15-6:30		15	1	16	6.3	0.9	1		73	8	81	9.9	1.1	7
6:30-6:45		19	2	21	9.5	1.1	1		102	15	117	12.8	1.6	18
6:45-7:00		17	2	19	10.5	1.0	2		118	19	137	13.9	1.9	7
1時間計		68	8	76	10.5	4.1	5		373	56	429	13.1	5.8	40
夜12時間計		470	49	519	9.4	28.1	34		1650	190	1840	10.3	24.9	173
全時間合計		1620	228	1848	12.3	100.0	85		6345	1055	7400	14.3	100.0	522
昼夜率		1.41	1.27	1.39	-	-	1.67		1.35	1.22	1.33	-	-	1.50

方向別自動車交通量調査表

調査地点 : 地域社会4 滝沢

調査年月日 : 令和 2年 9月29日(火) 天候:曇りのち晴れ



方向 時間帯	種別						A 合計 (1+2)					
		小型車 (台)	大型車 (台)	合計 (台)	大型車 混入率 (%)	時間 係数 (%)	二輪車 (台)	小型車 (台)	大型車 (台)	合計 (台)	大型車 混入率 (%)	時間 係数 (%)
7:00-7:15							156	19	175	10.9	1.9	17
7:15-7:30							141	25	166	15.1	1.8	17
7:30-7:45							136	32	168	19.0	1.8	13
7:45-8:00							147	20	167	12.0	1.8	9
1時間計							580	96	676	14.2	7.3	56
8:00-8:15							178	20	198	10.1	2.1	23
8:15-8:30							136	21	157	13.4	1.7	20
8:30-8:45							116	21	137	15.3	1.5	4
8:45-9:00							99	18	117	15.4	1.3	5
1時間計							529	80	609	13.1	6.6	52
9:00-9:15							125	27	152	17.8	1.6	6
9:15-9:30							99	24	123	19.5	1.3	8
9:30-9:45							120	23	143	16.1	1.5	4
9:45-10:00							112	28	140	20.0	1.5	7
1時間計							456	102	558	18.3	6.0	25
10:00-10:15							103	34	137	24.8	1.5	7
10:15-10:30							96	25	121	20.7	1.3	8
10:30-10:45							110	31	141	22.0	1.5	6
10:45-11:00							98	19	117	16.2	1.3	8
1時間計							407	109	516	21.1	5.6	29
11:00-11:15							119	19	138	13.8	1.5	7
11:15-11:30							82	22	104	21.2	1.1	4
11:30-11:45							126	29	155	18.7	1.7	8
11:45-12:00							102	27	129	20.9	1.4	5
1時間計							429	97	526	18.4	5.7	24
12:00-12:15							105	26	131	19.8	1.4	6
12:15-12:30							87	23	110	20.9	1.2	6
12:30-12:45							113	29	142	20.4	1.5	10
12:45-13:00							106	15	121	12.4	1.3	2
1時間計							411	93	504	18.5	5.4	24
13:00-13:15							111	23	134	17.2	1.4	5
13:15-13:30							122	15	137	10.9	1.5	3
13:30-13:45							102	32	134	23.9	1.4	5
13:45-14:00							97	15	112	13.4	1.2	5
1時間計							432	85	517	16.4	5.6	18
14:00-14:15							118	28	146	19.2	1.6	5
14:15-14:30							121	30	151	19.9	1.6	3
14:30-14:45							109	19	128	14.8	1.4	1
14:45-15:00							103	14	117	12.0	1.3	6
1時間計							451	91	542	16.8	5.9	15

方向別自動車交通量調査表

調査地点：地域社会4 滝沢

調査年月日：令和2年9月29日(火) 天候：曇りのち晴れ



方向							A 合計 (1+2)					
	種別	小型車 (台)	大型車 (台)	合計 (台)	大型車 混入率 (%)	時間 係数 (%)	二輪車 (台)	小型車 (台)	大型車 (台)	合計 (台)	大型車 混入率 (%)	時間 係数 (%)
15:00-15:15							109	24	133	18.0	1.4	7
15:15-15:30							141	29	170	17.1	1.8	3
15:30-15:45							106	24	130	18.5	1.4	13
15:45-16:00							109	29	138	21.0	1.5	9
1時間計							465	106	571	18.6	6.2	32
16:00-16:15							133	22	155	14.2	1.7	8
16:15-16:30							130	18	148	12.2	1.6	6
16:30-16:45							128	19	147	12.9	1.6	9
16:45-17:00							143	13	156	8.3	1.7	8
1時間計							534	72	606	11.9	6.6	31
17:00-17:15							132	20	152	13.2	1.6	2
17:15-17:30							121	12	133	9.0	1.4	15
17:30-17:45							178	20	198	10.1	2.1	23
17:45-18:00							130	14	144	9.7	1.6	11
1時間計							561	66	627	10.5	6.8	51
18:00-18:15							146	15	161	9.3	1.7	14
18:15-18:30							135	6	141	4.3	1.5	8
18:30-18:45							166	11	177	6.2	1.9	10
18:45-19:00							143	15	158	9.5	1.7	11
1時間計							590	47	637	7.4	6.9	43
昼12時間計							5845	1044	6889	15.2	74.5	400
19:00-19:15							147	10	157	6.4	1.7	11
19:15-19:30							146	7	153	4.6	1.7	7
19:30-19:45							145	12	157	7.6	1.7	14
19:45-20:00							100	1	101	1.0	1.1	14
1時間計							538	30	568	5.3	6.1	46
20:00-20:15							98	10	108	9.3	1.2	14
20:15-20:30							98	2	100	2.0	1.1	7
20:30-20:45							73	3	76	3.9	0.8	8
20:45-21:00							60	2	62	3.2	0.7	12
1時間計							329	17	346	4.9	3.7	41
21:00-21:15							76	4	80	5.0	0.9	9
21:15-21:30							65	1	66	1.5	0.7	3
21:30-21:45							58	2	60	3.3	0.6	3
21:45-22:00							39	2	41	4.9	0.4	4
1時間計							238	9	247	3.6	2.7	19
22:00-22:15							44	2	46	4.3	0.5	2
22:15-22:30							39	2	41	4.9	0.4	2
22:30-22:45							25	1	26	3.8	0.3	4
22:45-23:00							21	4	25	16.0	0.3	2
1時間計							129	9	138	6.5	1.5	10

方向別自動車交通量調査表

調査地点：地域社会4 滝沢

調査年月日：令和2年9月29日(火) 天候：曇りのち晴れ



方向							A 合計 (1+2)					
	種別	小型車 (台)	大型車 (台)	合計 (台)	大型車 混入率 (%)	時間 係数 (%)	二輪車 (台)	小型車 (台)	大型車 (台)	合計 (台)	大型車 混入率 (%)	時間 係数 (%)
23:00-23:15							17	5	22	22.7	0.2	4
23:15-23:30							14	1	15	6.7	0.2	3
23:30-23:45							14	0	14	0.0	0.2	4
23:45-24:00							17	2	19	10.5	0.2	3
1時間計							62	8	70	11.4	0.8	14
0:00-0:15							12	2	14	14.3	0.2	1
0:15-0:30							12	4	16	25.0	0.2	0
0:30-0:45							10	10	20	50.0	0.2	3
0:45-1:00							6	5	11	45.5	0.1	1
1時間計							40	21	61	34.4	0.7	5
1:00-1:15							15	5	20	25.0	0.2	0
1:15-1:30							11	7	18	38.9	0.2	1
1:30-1:45							16	4	20	20.0	0.2	2
1:45-2:00							10	2	12	16.7	0.1	0
1時間計							52	18	70	25.7	0.8	3
2:00-2:15							10	0	10	0.0	0.1	0
2:15-2:30							8	5	13	38.5	0.1	1
2:30-2:45							8	3	11	27.3	0.1	1
2:45-3:00							3	3	6	50.0	0.1	0
1時間計							29	11	40	27.5	0.4	2
3:00-3:15							8	3	11	27.3	0.1	1
3:15-3:30							5	2	7	28.6	0.1	2
3:30-3:45							12	1	13	7.7	0.1	2
3:45-4:00							11	6	17	35.3	0.2	1
1時間計							36	12	48	25.0	0.5	6
4:00-4:15							9	2	11	18.2	0.1	0
4:15-4:30							14	3	17	17.6	0.2	1
4:30-4:45							20	4	24	16.7	0.3	4
4:45-5:00							21	4	25	16.0	0.3	1
1時間計							64	13	77	16.9	0.8	6
5:00-5:15							27	6	33	18.2	0.4	2
5:15-5:30							34	5	39	12.8	0.4	2
5:30-5:45							45	9	54	16.7	0.6	1
5:45-6:00							56	7	63	11.1	0.7	5
1時間計							162	27	189	14.3	2.0	10
6:00-6:15							97	17	114	14.9	1.2	9
6:15-6:30							88	9	97	9.3	1.0	8
6:30-6:45							121	17	138	12.3	1.5	19
6:45-7:00							135	21	156	13.5	1.7	9
1時間計							441	64	505	12.7	5.5	45
夜12時間計							2120	239	2359	10.1	25.5	207
全時間合計							7965	1283	9248	13.9	100.0	607
昼夜率							1.36	1.23	1.34	-	-	1.52

方向別自動車交通量調査表

調査地点：地域社会4 滝沢

調査年月日：令和2年9月29日(火) 天候：曇りのち晴れ



方向 時間帯	3						4					
	種別 小型車 (台)	大型車 (台)	合計 (台)	大型車 混入率 (%)	時係 数 (%)	二輪車 (台)	種別 小型車 (台)	大型車 (台)	合計 (台)	大型車 混入率 (%)	時係 数 (%)	二輪車 (台)
7:00-7:15	169	20	189	10.6	2.0	24	4	1	5	20.0	1.1	0
7:15-7:30	171	28	199	14.1	2.1	16	1	2	3	66.7	0.7	1
7:30-7:45	192	22	214	10.3	2.3	17	2	4	6	66.7	1.3	0
7:45-8:00	206	20	226	8.8	2.4	16	2	4	6	66.7	1.3	0
1時間計	738	90	828	10.9	8.9	73	9	11	20	55.0	4.4	1
8:00-8:15	183	39	222	17.6	2.4	12	2	0	2	0.0	0.4	0
8:15-8:30	172	30	202	14.9	2.2	11	5	2	7	28.6	1.5	0
8:30-8:45	152	40	192	20.8	2.1	12	1	2	3	66.7	0.7	0
8:45-9:00	139	27	166	16.3	1.8	9	0	3	3	100.0	0.7	0
1時間計	646	136	782	17.4	8.4	44	8	7	15	46.7	3.3	0
9:00-9:15	137	30	167	18.0	1.8	12	3	5	8	62.5	1.8	0
9:15-9:30	109	27	136	19.9	1.5	5	3	3	6	50.0	1.3	0
9:30-9:45	120	37	157	23.6	1.7	7	1	5	6	83.3	1.3	0
9:45-10:00	99	22	121	18.2	1.3	4	2	6	8	75.0	1.8	0
1時間計	465	116	581	20.0	6.2	28	9	19	28	67.9	6.2	0
10:00-10:15	122	29	151	19.2	1.6	7	8	7	15	46.7	3.3	0
10:15-10:30	103	19	122	15.6	1.3	6	4	3	7	42.9	1.5	0
10:30-10:45	100	20	120	16.7	1.3	5	1	5	6	83.3	1.3	0
10:45-11:00	97	34	131	26.0	1.4	5	3	5	8	62.5	1.8	0
1時間計	422	102	524	19.5	5.6	23	16	20	36	55.6	7.9	0
11:00-11:15	70	27	97	27.8	1.0	5	4	8	12	66.7	2.6	0
11:15-11:30	108	18	126	14.3	1.3	5	4	7	11	63.6	2.4	0
11:30-11:45	107	13	120	10.8	1.3	4	5	8	13	61.5	2.9	0
11:45-12:00	89	17	106	16.0	1.1	4	1	8	9	88.9	2.0	0
1時間計	374	75	449	16.7	4.8	18	14	31	45	68.9	9.9	0
12:00-12:15	96	20	116	17.2	1.2	7	0	5	5	100.0	1.1	0
12:15-12:30	92	18	110	16.4	1.2	7	1	5	6	83.3	1.3	0
12:30-12:45	86	14	100	14.0	1.1	9	4	3	7	42.9	1.5	1
12:45-13:00	83	15	98	15.3	1.0	7	1	4	5	80.0	1.1	0
1時間計	357	67	424	15.8	4.5	30	6	17	23	73.9	5.1	1
13:00-13:15	107	31	138	22.5	1.5	6	5	5	10	50.0	2.2	0
13:15-13:30	108	17	125	13.6	1.3	3	1	3	4	75.0	0.9	0
13:30-13:45	93	19	112	17.0	1.2	4	6	6	12	50.0	2.6	0
13:45-14:00	95	19	114	16.7	1.2	9	1	6	7	85.7	1.5	0
1時間計	403	86	489	17.6	5.2	22	13	20	33	60.6	7.3	0
14:00-14:15	82	18	100	18.0	1.1	5	1	9	10	90.0	2.2	0
14:15-14:30	91	16	107	15.0	1.1	5	1	4	5	80.0	1.1	0
14:30-14:45	93	16	109	14.7	1.2	2	3	7	10	70.0	2.2	0
14:45-15:00	110	21	131	16.0	1.4	5	3	6	9	66.7	2.0	0
1時間計	376	71	447	15.9	4.8	17	8	26	34	76.5	7.5	0

方向別自動車交通量調査表

調査地点：地域社会4 滝沢

調査年月日：令和2年9月29日(火) 天候：曇りのち晴れ



方向	3						4						
	種別	小型車 (台)	大型車 (台)	合計 (台)	大型車 混入率 (%)	時間 係数 (%)	二輪車 (台)	小型車 (台)	大型車 (台)	合計 (台)	大型車 混入率 (%)	時間 係数 (%)	二輪車 (台)
15:00-15:15		121	15	136	11.0	1.5	8	4	2	6	33.3	1.3	0
15:15-15:30		113	10	123	8.1	1.3	8	1	5	6	83.3	1.3	0
15:30-15:45		132	10	142	7.0	1.5	11	2	1	3	33.3	0.7	0
15:45-16:00		99	11	110	10.0	1.2	8	4	2	6	33.3	1.3	1
1時間計		465	46	511	9.0	5.5	35	11	10	21	47.6	4.6	1
16:00-16:15		126	20	146	13.7	1.6	8	4	6	10	60.0	2.2	0
16:15-16:30		135	17	152	11.2	1.6	4	5	4	9	44.4	2.0	0
16:30-16:45		128	16	144	11.1	1.5	6	0	5	5	100.0	1.1	0
16:45-17:00		126	15	141	10.6	1.5	14	4	1	5	20.0	1.1	0
1時間計		515	68	583	11.7	6.2	32	13	16	29	55.2	6.4	0
17:00-17:15		148	4	152	2.6	1.6	8	6	4	10	40.0	2.2	0
17:15-17:30		142	13	155	8.4	1.7	11	1	1	2	50.0	0.4	0
17:30-17:45		179	12	191	6.3	2.0	13	10	5	15	33.3	3.3	0
17:45-18:00		151	6	157	3.8	1.7	12	1	3	4	75.0	0.9	0
1時間計		620	35	655	5.3	7.0	44	18	13	31	41.9	6.8	0
18:00-18:15		197	9	206	4.4	2.2	12	3	2	5	40.0	1.1	0
18:15-18:30		157	7	164	4.3	1.8	14	1	1	2	50.0	0.4	0
18:30-18:45		159	5	164	3.0	1.8	20	3	1	4	25.0	0.9	0
18:45-19:00		163	6	169	3.6	1.8	13	5	4	9	44.4	2.0	0
1時間計		676	27	703	3.8	7.5	59	12	8	20	40.0	4.4	0
昼12時間計		6057	919	6976	13.2	74.6	425	137	198	335	59.1	73.8	3
19:00-19:15		151	5	156	3.2	1.7	13	3	2	5	40.0	1.1	0
19:15-19:30		143	6	149	4.0	1.6	7	1	2	3	66.7	0.7	0
19:30-19:45		124	4	128	3.1	1.4	13	1	2	3	66.7	0.7	0
19:45-20:00		100	2	102	2.0	1.1	5	0	2	2	100.0	0.4	0
1時間計		518	17	535	3.2	5.7	38	5	8	13	61.5	2.9	0
20:00-20:15		103	1	104	1.0	1.1	8	1	2	3	66.7	0.7	0
20:15-20:30		80	4	84	4.8	0.9	6	2	3	5	60.0	1.1	0
20:30-20:45		78	2	80	2.5	0.9	6	3	0	3	0.0	0.7	0
20:45-21:00		54	1	55	1.8	0.6	11	1	1	2	50.0	0.4	1
1時間計		315	8	323	2.5	3.5	31	7	6	13	46.2	2.9	1
21:00-21:15		89	3	92	3.3	1.0	4	8	1	9	11.1	2.0	0
21:15-21:30		61	3	64	4.7	0.7	4	1	0	1	0.0	0.2	0
21:30-21:45		57	3	60	5.0	0.6	2	1	2	3	66.7	0.7	0
21:45-22:00		42	3	45	6.7	0.5	3	1	2	3	66.7	0.7	0
1時間計		249	12	261	4.6	2.8	13	11	5	16	31.3	3.5	0
22:00-22:15		42	2	44	4.5	0.5	2	1	1	2	50.0	0.4	0
22:15-22:30		52	4	56	7.1	0.6	3	1	0	1	0.0	0.2	0
22:30-22:45		65	4	69	5.8	0.7	8	0	0	0	0.0	0.0	0
22:45-23:00		22	2	24	8.3	0.3	4	2	2	4	50.0	0.9	1
1時間計		181	12	193	6.2	2.1	17	4	3	7	42.9	1.5	1

方向別自動車交通量調査表

調査地点：地域社会4 滝沢

調査年月日：令和2年9月29日(火) 天候：曇りのち晴れ



方向	3						4						
	種別	小型車 (台)	大型車 (台)	合計 (台)	大型車 混入率 (%)	時間 係数 (%)	二輪車 (台)	小型車 (台)	大型車 (台)	合計 (台)	大型車 混入率 (%)	時間 係数 (%)	二輪車 (台)
23:00-23:15		22	5	27	18.5	0.3	4	1	0	1	0.0	0.2	0
23:15-23:30		16	3	19	15.8	0.2	0	3	1	4	25.0	0.9	0
23:30-23:45		13	2	15	13.3	0.2	1	1	2	3	66.7	0.7	0
23:45-24:00		15	4	19	21.1	0.2	1	1	0	1	0.0	0.2	0
1時間計		66	14	80	17.5	0.9	6	6	3	9	33.3	2.0	0
0:00-0:15		9	5	14	35.7	0.1	1	0	2	2	100.0	0.4	0
0:15-0:30		11	2	13	15.4	0.1	0	0	0	0	0.0	0.0	0
0:30-0:45		5	4	9	44.4	0.1	1	0	2	2	100.0	0.4	0
0:45-1:00		7	1	8	12.5	0.1	1	0	0	0	0.0	0.0	0
1時間計		32	12	44	27.3	0.5	3	0	4	4	100.0	0.9	0
1:00-1:15		9	6	15	40.0	0.2	1	0	0	0	0.0	0.0	0
1:15-1:30		8	3	11	27.3	0.1	1	0	3	3	100.0	0.7	0
1:30-1:45		6	2	8	25.0	0.1	1	0	0	0	0.0	0.0	0
1:45-2:00		7	6	13	46.2	0.1	0	1	0	1	0.0	0.2	0
1時間計		30	17	47	36.2	0.5	3	1	3	4	75.0	0.9	0
2:00-2:15		8	5	13	38.5	0.1	0	0	0	0	0.0	0.0	0
2:15-2:30		2	2	4	50.0	0.0	1	1	0	1	0.0	0.2	0
2:30-2:45		6	1	7	14.3	0.1	3	0	0	0	0.0	0.0	0
2:45-3:00		10	1	11	9.1	0.1	1	0	0	0	0.0	0.0	0
1時間計		26	9	35	25.7	0.4	5	1	0	1	0.0	0.2	0
3:00-3:15		3	2	5	40.0	0.1	2	0	0	0	0.0	0.0	1
3:15-3:30		8	5	13	38.5	0.1	3	2	1	3	33.3	0.7	0
3:30-3:45		6	4	10	40.0	0.1	1	0	0	0	0.0	0.0	0
3:45-4:00		9	5	14	35.7	0.1	0	1	0	1	0.0	0.2	0
1時間計		26	16	42	38.1	0.4	6	3	1	4	25.0	0.9	1
4:00-4:15		6	2	8	25.0	0.1	0	0	0	0	0.0	0.0	0
4:15-4:30		10	3	13	23.1	0.1	0	0	2	2	100.0	0.4	0
4:30-4:45		17	9	26	34.6	0.3	1	1	1	2	50.0	0.4	0
4:45-5:00		22	6	28	21.4	0.3	5	0	0	0	0.0	0.0	1
1時間計		55	20	75	26.7	0.8	6	1	3	4	75.0	0.9	1
5:00-5:15		25	15	40	37.5	0.4	1	0	2	2	100.0	0.4	0
5:15-5:30		25	9	34	26.5	0.4	2	1	3	4	75.0	0.9	1
5:30-5:45		36	13	49	26.5	0.5	5	3	0	3	0.0	0.7	0
5:45-6:00		56	15	71	21.1	0.8	3	5	2	7	28.6	1.5	0
1時間計		142	52	194	26.8	2.1	11	9	7	16	43.8	3.5	1
6:00-6:15		87	16	103	15.5	1.1	9	7	1	8	12.5	1.8	0
6:15-6:30		103	21	124	16.9	1.3	12	2	3	5	60.0	1.1	0
6:30-6:45		116	23	139	16.5	1.5	13	5	7	12	58.3	2.6	0
6:45-7:00		159	21	180	11.7	1.9	16	1	2	3	66.7	0.7	1
1時間計		465	81	546	14.8	5.8	50	15	13	28	46.4	6.2	1
夜12時間計		2105	270	2375	11.4	25.4	189	63	56	119	47.1	26.2	6
全時間合計		8162	1189	9351	12.7	100.0	614	200	254	454	55.9	100.0	9
昼夜率		1.35	1.29	1.34	-	-	1.44	1.46	1.28	1.36	-	-	3.00

方向別自動車交通量調査表

調査地点：地域社会4 滝沢

調査年月日：令和2年9月29日(火) 天候：曇りのち晴れ



時間帯	種別	方向					B 合計 (3+4)					
		小型車 (台)	大型車 (台)	合計 (台)	大型車 混入率 (%)	時間 係数 (%)	二輪車 (台)	小型車 (台)	大型車 (台)	合計 (台)	大型車 混入率 (%)	時間 係数 (%)
7:00-7:15							173	21	194	10.8	2.0	24
7:15-7:30							172	30	202	14.9	2.1	17
7:30-7:45							194	26	220	11.8	2.2	17
7:45-8:00							208	24	232	10.3	2.4	16
1時間計							747	101	848	11.9	8.6	74
8:00-8:15							185	39	224	17.4	2.3	12
8:15-8:30							177	32	209	15.3	2.1	11
8:30-8:45							153	42	195	21.5	2.0	12
8:45-9:00							139	30	169	17.8	1.7	9
1時間計							654	143	797	17.9	8.1	44
9:00-9:15							140	35	175	20.0	1.8	12
9:15-9:30							112	30	142	21.1	1.4	5
9:30-9:45							121	42	163	25.8	1.7	7
9:45-10:00							101	28	129	21.7	1.3	4
1時間計							474	135	609	22.2	6.2	28
10:00-10:15							130	36	166	21.7	1.7	7
10:15-10:30							107	22	129	17.1	1.3	6
10:30-10:45							101	25	126	19.8	1.3	5
10:45-11:00							100	39	139	28.1	1.4	5
1時間計							438	122	560	21.8	5.7	23
11:00-11:15							74	35	109	32.1	1.1	5
11:15-11:30							112	25	137	18.2	1.4	5
11:30-11:45							112	21	133	15.8	1.4	4
11:45-12:00							90	25	115	21.7	1.2	4
1時間計							388	106	494	21.5	5.0	18
12:00-12:15							96	25	121	20.7	1.2	7
12:15-12:30							93	23	116	19.8	1.2	7
12:30-12:45							90	17	107	15.9	1.1	10
12:45-13:00							84	19	103	18.4	1.1	7
1時間計							363	84	447	18.8	4.6	31
13:00-13:15							112	36	148	24.3	1.5	6
13:15-13:30							109	20	129	15.5	1.3	3
13:30-13:45							99	25	124	20.2	1.3	4
13:45-14:00							96	25	121	20.7	1.2	9
1時間計							416	106	522	20.3	5.3	22
14:00-14:15							83	27	110	24.5	1.1	5
14:15-14:30							92	20	112	17.9	1.1	5
14:30-14:45							96	23	119	19.3	1.2	2
14:45-15:00							113	27	140	19.3	1.4	5
1時間計							384	97	481	20.2	4.9	17

方向別自動車交通量調査表

調査地点：地域社会4 滝沢

調査年月日：令和2年9月29日(火) 天候：曇りのち晴れ



方向 時間帯	種別							B 合計 (3+4)					
		小型車 (台)	大型車 (台)	合計 (台)	大型車 混入率 (%)	時間 係数 (%)	二輪車 (台)	小型車 (台)	大型車 (台)	合計 (台)	大型車 混入率 (%)	時間 係数 (%)	二輪車 (台)
15:00-15:15							125	17	142	12.0	1.4	8	
15:15-15:30							114	15	129	11.6	1.3	8	
15:30-15:45							134	11	145	7.6	1.5	11	
15:45-16:00							103	13	116	11.2	1.2	9	
1時間計							476	56	532	10.5	5.4	36	
16:00-16:15							130	26	156	16.7	1.6	8	
16:15-16:30							140	21	161	13.0	1.6	4	
16:30-16:45							128	21	149	14.1	1.5	6	
16:45-17:00							130	16	146	11.0	1.5	14	
1時間計							528	84	612	13.7	6.2	32	
17:00-17:15							154	8	162	4.9	1.7	8	
17:15-17:30							143	14	157	8.9	1.6	11	
17:30-17:45							189	17	206	8.3	2.1	13	
17:45-18:00							152	9	161	5.6	1.6	12	
1時間計							638	48	686	7.0	7.0	44	
18:00-18:15							200	11	211	5.2	2.2	12	
18:15-18:30							158	8	166	4.8	1.7	14	
18:30-18:45							162	6	168	3.6	1.7	20	
18:45-19:00							168	10	178	5.6	1.8	13	
1時間計							688	35	723	4.8	7.4	59	
昼12時間計							6194	1117	7311	15.3	74.6	428	
19:00-19:15							154	7	161	4.3	1.6	13	
19:15-19:30							144	8	152	5.3	1.6	7	
19:30-19:45							125	6	131	4.6	1.3	13	
19:45-20:00							100	4	104	3.8	1.1	5	
1時間計							523	25	548	4.6	5.6	38	
20:00-20:15							104	3	107	2.8	1.1	8	
20:15-20:30							82	7	89	7.9	0.9	6	
20:30-20:45							81	2	83	2.4	0.8	6	
20:45-21:00							55	2	57	3.5	0.6	12	
1時間計							322	14	336	4.2	3.4	32	
21:00-21:15							97	4	101	4.0	1.0	4	
21:15-21:30							62	3	65	4.6	0.7	4	
21:30-21:45							58	5	63	7.9	0.6	2	
21:45-22:00							43	5	48	10.4	0.5	3	
1時間計							260	17	277	6.1	2.8	13	
22:00-22:15							43	3	46	6.5	0.5	2	
22:15-22:30							53	4	57	7.0	0.6	3	
22:30-22:45							65	4	69	5.8	0.7	8	
22:45-23:00							24	4	28	14.3	0.3	5	
1時間計							185	15	200	7.5	2.0	18	

方向別自動車交通量調査表

調査地点：地域社会4 滝沢

調査年月日：令和2年9月29日(火) 天候：曇りのち晴れ



方向							B 合計 (3+4)						
	種別	小型車 (台)	大型車 (台)	合計 (台)	大型車 混入率 (%)	時間 係数 (%)	二輪車 (台)	小型車 (台)	大型車 (台)	合計 (台)	大型車 混入率 (%)	時間 係数 (%)	二輪車 (台)
時間帯													
23:00-23:15							23	5	28	17.9	0.3	4	
23:15-23:30							19	4	23	17.4	0.2	0	
23:30-23:45							14	4	18	22.2	0.2	1	
23:45-24:00							16	4	20	20.0	0.2	1	
1時間計							72	17	89	19.1	0.9	6	
0:00-0:15							9	7	16	43.8	0.2	1	
0:15-0:30							11	2	13	15.4	0.1	0	
0:30-0:45							5	6	11	54.5	0.1	1	
0:45-1:00							7	1	8	12.5	0.1	1	
1時間計							32	16	48	33.3	0.5	3	
1:00-1:15							9	6	15	40.0	0.2	1	
1:15-1:30							8	6	14	42.9	0.1	1	
1:30-1:45							6	2	8	25.0	0.1	1	
1:45-2:00							8	6	14	42.9	0.1	0	
1時間計							31	20	51	39.2	0.5	3	
2:00-2:15							8	5	13	38.5	0.1	0	
2:15-2:30							3	2	5	40.0	0.1	1	
2:30-2:45							6	1	7	14.3	0.1	3	
2:45-3:00							10	1	11	9.1	0.1	1	
1時間計							27	9	36	25.0	0.4	5	
3:00-3:15							3	2	5	40.0	0.1	3	
3:15-3:30							10	6	16	37.5	0.2	3	
3:30-3:45							6	4	10	40.0	0.1	1	
3:45-4:00							10	5	15	33.3	0.2	0	
1時間計							29	17	46	37.0	0.5	7	
4:00-4:15							6	2	8	25.0	0.1	0	
4:15-4:30							10	5	15	33.3	0.2	0	
4:30-4:45							18	10	28	35.7	0.3	1	
4:45-5:00							22	6	28	21.4	0.3	6	
1時間計							56	23	79	29.1	0.8	7	
5:00-5:15							25	17	42	40.5	0.4	1	
5:15-5:30							26	12	38	31.6	0.4	3	
5:30-5:45							39	13	52	25.0	0.5	5	
5:45-6:00							61	17	78	21.8	0.8	3	
1時間計							151	59	210	28.1	2.1	12	
6:00-6:15							94	17	111	15.3	1.1	9	
6:15-6:30							105	24	129	18.6	1.3	12	
6:30-6:45							121	30	151	19.9	1.5	13	
6:45-7:00							160	23	183	12.6	1.9	17	
1時間計							490	94	574	16.4	5.9	51	
夜12時間計							2168	326	2494	13.1	25.4	195	
全時間合計							8362	1443	9805	14.7	100.0	623	
昼夜率							1.35	1.29	1.34	-	-	1.46	

方向別自動車交通量調査表

調査地点：地域社会4 滝沢

調査年月日：令和2年9月29日(火) 天候：曇りのち晴れ



方向	5						6							
	種別	小型車 (台)	大型車 (台)	合計 (台)	大型車 混入率 (%)	時間 係数 (%)	二輪車 (台)	種別	小型車 (台)	大型車 (台)	合計 (台)	大型車 混入率 (%)	時間 係数 (%)	二輪車 (台)
7:00-7:15		19	12	31	38.7	1.0	0		35	8	43	18.6	1.3	2
7:15-7:30		29	14	43	32.6	1.4	0		47	12	59	20.3	1.8	1
7:30-7:45		32	18	50	36.0	1.6	1		43	11	54	20.4	1.6	3
7:45-8:00		27	8	35	22.9	1.1	0		47	6	53	11.3	1.6	5
1時間計		107	52	159	32.7	5.1	1		172	37	209	17.7	6.3	11
8:00-8:15		25	10	35	28.6	1.1	0		53	14	67	20.9	2.0	3
8:15-8:30		31	12	43	27.9	1.4	2		40	10	50	20.0	1.5	1
8:30-8:45		22	13	35	37.1	1.1	1		45	7	52	13.5	1.6	3
8:45-9:00		21	13	34	38.2	1.1	0		35	12	47	25.5	1.4	0
1時間計		99	48	147	32.7	4.7	3		173	43	216	19.9	6.5	7
9:00-9:15		22	11	33	33.3	1.1	1		37	7	44	15.9	1.3	3
9:15-9:30		15	14	29	48.3	0.9	1		37	10	47	21.3	1.4	1
9:30-9:45		21	13	34	38.2	1.1	0		29	8	37	21.6	1.1	2
9:45-10:00		23	18	41	43.9	1.3	1		33	8	41	19.5	1.2	2
1時間計		81	56	137	40.9	4.4	3		136	33	169	19.5	5.1	8
10:00-10:15		25	14	39	35.9	1.3	1		30	15	45	33.3	1.4	4
10:15-10:30		18	14	32	43.8	1.0	1		15	8	23	34.8	0.7	0
10:30-10:45		19	17	36	47.2	1.2	0		25	9	34	26.5	1.0	0
10:45-11:00		14	23	37	62.2	1.2	1		27	17	44	38.6	1.3	1
1時間計		76	68	144	47.2	4.6	3		97	49	146	33.6	4.4	5
11:00-11:15		14	26	40	65.0	1.3	0		29	3	32	9.4	1.0	1
11:15-11:30		13	9	22	40.9	0.7	0		30	9	39	23.1	1.2	0
11:30-11:45		27	23	50	46.0	1.6	2		35	7	42	16.7	1.3	5
11:45-12:00		24	13	37	35.1	1.2	1		35	5	40	12.5	1.2	1
1時間計		78	71	149	47.7	4.8	3		129	24	153	15.7	4.6	7
12:00-12:15		25	11	36	30.6	1.2	0		31	7	38	18.4	1.2	1
12:15-12:30		22	15	37	40.5	1.2	0		40	5	45	11.1	1.4	0
12:30-12:45		25	14	39	35.9	1.3	1		38	7	45	15.6	1.4	2
12:45-13:00		26	17	43	39.5	1.4	0		28	3	31	9.7	0.9	1
1時間計		98	57	155	36.8	5.0	1		137	22	159	13.8	4.8	4
13:00-13:15		23	15	38	39.5	1.2	1		38	11	49	22.4	1.5	0
13:15-13:30		33	11	44	25.0	1.4	0		46	4	50	8.0	1.5	1
13:30-13:45		42	17	59	28.8	1.9	2		40	4	44	9.1	1.3	1
13:45-14:00		27	16	43	37.2	1.4	0		34	8	42	19.0	1.3	2
1時間計		125	59	184	32.1	5.9	3		158	27	185	14.6	5.6	4
14:00-14:15		18	25	43	58.1	1.4	0		29	7	36	19.4	1.1	1
14:15-14:30		33	13	46	28.3	1.5	1		37	5	42	11.9	1.3	1
14:30-14:45		17	11	28	39.3	0.9	1		44	11	55	20.0	1.7	2
14:45-15:00		33	21	54	38.9	1.7	0		42	4	46	8.7	1.4	2
1時間計		101	70	171	40.9	5.5	2		152	27	179	15.1	5.4	6

方向別自動車交通量調査表

調査地点：地域社会4 滝沢

調査年月日：令和2年9月29日(火) 天候：曇りのち晴れ



方向 種別 時間帯	5						6					
	小型車 (台)	大型車 (台)	合計 (台)	大型車 混入率 (%)	時間 係数 (%)	二輪車 (台)	小型車 (台)	大型車 (台)	合計 (台)	大型車 混入率 (%)	時間 係数 (%)	二輪車 (台)
15:00-15:15	41	10	51	19.6	1.6	0	47	10	57	17.5	1.7	0
15:15-15:30	43	11	54	20.4	1.7	1	44	6	50	12.0	1.5	1
15:30-15:45	45	9	54	16.7	1.7	1	45	6	51	11.8	1.5	1
15:45-16:00	38	14	52	26.9	1.7	0	46	5	51	9.8	1.5	2
1時間計	167	44	211	20.9	6.8	2	182	27	209	12.9	6.3	4
16:00-16:15	43	12	55	21.8	1.8	1	64	10	74	13.5	2.2	0
16:15-16:30	38	13	51	25.5	1.6	1	46	3	49	6.1	1.5	0
16:30-16:45	45	18	63	28.6	2.0	0	60	2	62	3.2	1.9	7
16:45-17:00	29	11	40	27.5	1.3	0	51	5	56	8.9	1.7	5
1時間計	155	54	209	25.8	6.7	2	221	20	241	8.3	7.3	12
17:00-17:15	49	20	69	29.0	2.2	0	47	6	53	11.3	1.6	2
17:15-17:30	37	14	51	27.5	1.6	0	64	5	69	7.2	2.1	2
17:30-17:45	65	13	78	16.7	2.5	0	64	8	72	11.1	2.2	5
17:45-18:00	76	13	89	14.6	2.9	0	79	2	81	2.5	2.5	4
1時間計	227	60	287	20.9	9.3	0	254	21	275	7.6	8.3	13
18:00-18:15	67	13	80	16.3	2.6	2	89	7	96	7.3	2.9	2
18:15-18:30	59	12	71	16.9	2.3	1	82	7	89	7.9	2.7	5
18:30-18:45	76	16	92	17.4	3.0	0	86	4	90	4.4	2.7	2
18:45-19:00	62	12	74	16.2	2.4	0	72	1	73	1.4	2.2	1
1時間計	264	53	317	16.7	10.2	3	329	19	348	5.5	10.5	10
昼12時間計	1578	692	2270	30.5	73.2	26	2140	349	2489	14.0	75.4	91
19:00-19:15	41	5	46	10.9	1.5	0	80	3	83	3.6	2.5	1
19:15-19:30	59	4	63	6.3	2.0	0	70	1	71	1.4	2.2	2
19:30-19:45	49	10	59	16.9	1.9	1	77	3	80	3.8	2.4	3
19:45-20:00	26	9	35	25.7	1.1	0	52	0	52	0.0	1.6	1
1時間計	175	28	203	13.8	6.5	1	279	7	286	2.4	8.7	7
20:00-20:15	39	9	48	18.8	1.5	1	41	2	43	4.7	1.3	5
20:15-20:30	18	3	21	14.3	0.7	0	24	4	28	14.3	0.8	1
20:30-20:45	18	9	27	33.3	0.9	0	30	0	30	0.0	0.9	2
20:45-21:00	19	4	23	17.4	0.7	0	31	0	31	0.0	0.9	3
1時間計	94	25	119	21.0	3.8	1	126	6	132	4.5	4.0	11
21:00-21:15	6	5	11	45.5	0.4	0	28	1	29	3.4	0.9	1
21:15-21:30	9	6	15	40.0	0.5	0	18	4	22	18.2	0.7	0
21:30-21:45	12	6	18	33.3	0.6	0	13	2	15	13.3	0.5	2
21:45-22:00	11	5	16	31.3	0.5	0	10	0	10	0.0	0.3	2
1時間計	38	22	60	36.7	1.9	0	69	7	76	9.2	2.3	5
22:00-22:15	9	5	14	35.7	0.5	1	21	0	21	0.0	0.6	1
22:15-22:30	13	2	15	13.3	0.5	0	10	0	10	0.0	0.3	2
22:30-22:45	7	3	10	30.0	0.3	1	8	1	9	11.1	0.3	0
22:45-23:00	9	3	12	25.0	0.4	1	3	0	3	0.0	0.1	0
1時間計	38	13	51	25.5	1.6	3	42	1	43	2.3	1.3	3

方向別自動車交通量調査表

調査地点：地域社会4 滝沢

調査年月日：令和2年9月29日(火) 天候：曇りのち晴れ



方向 種別 時間帯	5						6					
	小型車 (台)	大型車 (台)	合計 (台)	大型車 混入率 (%)	時間 係数 (%)	二輪車 (台)	小型車 (台)	大型車 (台)	合計 (台)	大型車 混入率 (%)	時間 係数 (%)	二輪車 (台)
23:00-23:15	6	3	9	33.3	0.3	0	12	1	13	7.7	0.4	4
23:15-23:30	3	4	7	57.1	0.2	0	5	0	5	0.0	0.2	0
23:30-23:45	2	13	15	86.7	0.5	0	7	0	7	0.0	0.2	0
23:45-24:00	5	7	12	58.3	0.4	0	6	0	6	0.0	0.2	0
1時間計	16	27	43	62.8	1.4	0	30	1	31	3.2	0.9	4
0:00-0:15	4	16	20	80.0	0.6	0	4	0	4	0.0	0.1	0
0:15-0:30	2	10	12	83.3	0.4	0	5	2	7	28.6	0.2	0
0:30-0:45	5	5	10	50.0	0.3	0	6	2	8	25.0	0.2	0
0:45-1:00	4	8	12	66.7	0.4	0	6	1	7	14.3	0.2	0
1時間計	15	39	54	72.2	1.7	0	21	5	26	19.2	0.8	0
1:00-1:15	1	7	8	87.5	0.3	0	5	3	8	37.5	0.2	0
1:15-1:30	6	9	15	60.0	0.5	0	5	1	6	16.7	0.2	0
1:30-1:45	2	7	9	77.8	0.3	0	4	1	5	20.0	0.2	0
1:45-2:00	3	7	10	70.0	0.3	0	1	1	2	50.0	0.1	0
1時間計	12	30	42	71.4	1.4	0	15	6	21	28.6	0.6	0
2:00-2:15	4	7	11	63.6	0.4	0	4	3	7	42.9	0.2	0
2:15-2:30	4	8	12	66.7	0.4	0	3	1	4	25.0	0.1	0
2:30-2:45	7	8	15	53.3	0.5	0	4	3	7	42.9	0.2	1
2:45-3:00	1	6	7	85.7	0.2	0	2	1	3	33.3	0.1	0
1時間計	16	29	45	64.4	1.5	0	13	8	21	38.1	0.6	1
3:00-3:15	4	8	12	66.7	0.4	0	2	2	4	50.0	0.1	0
3:15-3:30	2	6	8	75.0	0.3	0	2	2	4	50.0	0.1	0
3:30-3:45	5	6	11	54.5	0.4	0	1	0	1	0.0	0.0	0
3:45-4:00	1	2	3	66.7	0.1	0	3	0	3	0.0	0.1	0
1時間計	12	22	34	64.7	1.1	0	8	4	12	33.3	0.4	0
4:00-4:15	5	9	14	64.3	0.5	0	0	2	2	100.0	0.1	1
4:15-4:30	1	4	5	80.0	0.2	1	4	0	4	0.0	0.1	0
4:30-4:45	2	5	7	71.4	0.2	0	2	3	5	60.0	0.2	1
4:45-5:00	5	6	11	54.5	0.4	0	1	7	8	87.5	0.2	0
1時間計	13	24	37	64.9	1.2	1	7	12	19	63.2	0.6	2
5:00-5:15	2	6	8	75.0	0.3	0	4	2	6	33.3	0.2	0
5:15-5:30	1	8	9	88.9	0.3	1	11	2	13	15.4	0.4	2
5:30-5:45	7	4	11	36.4	0.4	0	7	6	13	46.2	0.4	1
5:45-6:00	13	10	23	43.5	0.7	1	11	6	17	35.3	0.5	0
1時間計	23	28	51	54.9	1.6	2	33	16	49	32.7	1.5	3
6:00-6:15	8	7	15	46.7	0.5	1	10	8	18	44.4	0.5	0
6:15-6:30	10	4	14	28.6	0.5	0	13	6	19	31.6	0.6	0
6:30-6:45	19	11	30	36.7	1.0	0	19	6	25	24.0	0.8	3
6:45-7:00	19	13	32	40.6	1.0	3	25	9	34	26.5	1.0	2
1時間計	56	35	91	38.5	2.9	4	67	29	96	30.2	2.9	5
夜12時間計	508	322	830	38.8	26.8	12	710	102	812	12.6	24.6	41
全時間合計	2086	1014	3100	32.7	100.0	38	2850	451	3301	13.7	100.0	132
昼夜率	1.32	1.47	1.37	-	-	1.46	1.33	1.29	1.33	-	-	1.45

方向別自動車交通量調査表

調査地点：地域社会4 滝沢

調査年月日：令和2年9月29日(火) 天候：曇りのち晴れ



方向 種別 時間帯							C 合計 (5+6)					
	小型車 (台)	大型車 (台)	合計 (台)	大型車 混入率 (%)	時間 係数 (%)	二輪車 (台)	小型車 (台)	大型車 (台)	合計 (台)	大型車 混入率 (%)	時間 係数 (%)	二輪車 (台)
7:00-7:15							54	20	74	27.0	1.2	2
7:15-7:30							76	26	102	25.5	1.6	1
7:30-7:45							75	29	104	27.9	1.6	4
7:45-8:00							74	14	88	15.9	1.4	5
1時間計							279	89	368	24.2	5.7	12
8:00-8:15							78	24	102	23.5	1.6	3
8:15-8:30							71	22	93	23.7	1.5	3
8:30-8:45							67	20	87	23.0	1.4	4
8:45-9:00							56	25	81	30.9	1.3	0
1時間計							272	91	363	25.1	5.7	10
9:00-9:15							59	18	77	23.4	1.2	4
9:15-9:30							52	24	76	31.6	1.2	2
9:30-9:45							50	21	71	29.6	1.1	2
9:45-10:00							56	26	82	31.7	1.3	3
1時間計							217	89	306	29.1	4.8	11
10:00-10:15							55	29	84	34.5	1.3	5
10:15-10:30							33	22	55	40.0	0.9	1
10:30-10:45							44	26	70	37.1	1.1	0
10:45-11:00							41	40	81	49.4	1.3	2
1時間計							173	117	290	40.3	4.5	8
11:00-11:15							43	29	72	40.3	1.1	1
11:15-11:30							43	18	61	29.5	1.0	0
11:30-11:45							62	30	92	32.6	1.4	7
11:45-12:00							59	18	77	23.4	1.2	2
1時間計							207	95	302	31.5	4.7	10
12:00-12:15							56	18	74	24.3	1.2	1
12:15-12:30							62	20	82	24.4	1.3	0
12:30-12:45							63	21	84	25.0	1.3	3
12:45-13:00							54	20	74	27.0	1.2	1
1時間計							235	79	314	25.2	4.9	5
13:00-13:15							61	26	87	29.9	1.4	1
13:15-13:30							79	15	94	16.0	1.5	1
13:30-13:45							82	21	103	20.4	1.6	3
13:45-14:00							61	24	85	28.2	1.3	2
1時間計							283	86	369	23.3	5.8	7
14:00-14:15							47	32	79	40.5	1.2	1
14:15-14:30							70	18	88	20.5	1.4	2
14:30-14:45							61	22	83	26.5	1.3	3
14:45-15:00							75	25	100	25.0	1.6	2
1時間計							253	97	350	27.7	5.5	8

方向別自動車交通量調査表

調査地点：地域社会4 滝沢

調査年月日：令和2年9月29日(火) 天候：曇りのち晴れ



方向 時間帯	種別						C 合計 (5+6)					
		小型車 (台)	大型車 (台)	合計 (台)	大型車 混入率 (%)	時間 係数 (%)	二輪車 (台)	小型車 (台)	大型車 (台)	合計 (台)	大型車 混入率 (%)	時間 係数 (%)
15:00-15:15							88	20	108	18.5	1.7	0
15:15-15:30							87	17	104	16.3	1.6	2
15:30-15:45							90	15	105	14.3	1.6	2
15:45-16:00							84	19	103	18.4	1.6	2
1時間計							349	71	420	16.9	6.6	6
16:00-16:15							107	22	129	17.1	2.0	1
16:15-16:30							84	16	100	16.0	1.6	1
16:30-16:45							105	20	125	16.0	2.0	7
16:45-17:00							80	16	96	16.7	1.5	5
1時間計							376	74	450	16.4	7.0	14
17:00-17:15							96	26	122	21.3	1.9	2
17:15-17:30							101	19	120	15.8	1.9	2
17:30-17:45							129	21	150	14.0	2.3	5
17:45-18:00							155	15	170	8.8	2.7	4
1時間計							481	81	562	14.4	8.8	13
18:00-18:15							156	20	176	11.4	2.7	4
18:15-18:30							141	19	160	11.9	2.5	6
18:30-18:45							162	20	182	11.0	2.8	2
18:45-19:00							134	13	147	8.8	2.3	1
1時間計							593	72	665	10.8	10.4	13
昼12時間計							3718	1041	4759	21.9	74.3	117
19:00-19:15							121	8	129	6.2	2.0	1
19:15-19:30							129	5	134	3.7	2.1	2
19:30-19:45							126	13	139	9.4	2.2	4
19:45-20:00							78	9	87	10.3	1.4	1
1時間計							454	35	489	7.2	7.6	8
20:00-20:15							80	11	91	12.1	1.4	6
20:15-20:30							42	7	49	14.3	0.8	1
20:30-20:45							48	9	57	15.8	0.9	2
20:45-21:00							50	4	54	7.4	0.8	3
1時間計							220	31	251	12.4	3.9	12
21:00-21:15							34	6	40	15.0	0.6	1
21:15-21:30							27	10	37	27.0	0.6	0
21:30-21:45							25	8	33	24.2	0.5	2
21:45-22:00							21	5	26	19.2	0.4	2
1時間計							107	29	136	21.3	2.1	5
22:00-22:15							30	5	35	14.3	0.5	2
22:15-22:30							23	2	25	8.0	0.4	2
22:30-22:45							15	4	19	21.1	0.3	1
22:45-23:00							12	3	15	20.0	0.2	1
1時間計							80	14	94	14.9	1.5	6

方向別自動車交通量調査表

調査地点：地域社会4 滝沢

調査年月日：令和2年9月29日(火) 天候：曇りのち晴れ



時間帯	方向 種別							C 合計 (5+6)					
		小型車 (台)	大型車 (台)	合計 (台)	大型車 混入率 (%)	時間 係数 (%)	二輪車 (台)	小型車 (台)	大型車 (台)	合計 (台)	大型車 混入率 (%)	時間 係数 (%)	二輪車 (台)
23:00-23:15							18	4	22	18.2	0.3	4	
23:15-23:30							8	4	12	33.3	0.2	0	
23:30-23:45							9	13	22	59.1	0.3	0	
23:45-24:00							11	7	18	38.9	0.3	0	
1時間計							46	28	74	37.8	1.2	4	
0:00-0:15							8	16	24	66.7	0.4	0	
0:15-0:30							7	12	19	63.2	0.3	0	
0:30-0:45							11	7	18	38.9	0.3	0	
0:45-1:00							10	9	19	47.4	0.3	0	
1時間計							36	44	80	55.0	1.2	0	
1:00-1:15							6	10	16	62.5	0.2	0	
1:15-1:30							11	10	21	47.6	0.3	0	
1:30-1:45							6	8	14	57.1	0.2	0	
1:45-2:00							4	8	12	66.7	0.2	0	
1時間計							27	36	63	57.1	1.0	0	
2:00-2:15							8	10	18	55.6	0.3	0	
2:15-2:30							7	9	16	56.3	0.2	0	
2:30-2:45							11	11	22	50.0	0.3	1	
2:45-3:00							3	7	10	70.0	0.2	0	
1時間計							29	37	66	56.1	1.0	1	
3:00-3:15							6	10	16	62.5	0.2	0	
3:15-3:30							4	8	12	66.7	0.2	0	
3:30-3:45							6	6	12	50.0	0.2	0	
3:45-4:00							4	2	6	33.3	0.1	0	
1時間計							20	26	46	56.5	0.7	0	
4:00-4:15							5	11	16	68.8	0.2	1	
4:15-4:30							5	4	9	44.4	0.1	1	
4:30-4:45							4	8	12	66.7	0.2	1	
4:45-5:00							6	13	19	68.4	0.3	0	
1時間計							20	36	56	64.3	0.9	3	
5:00-5:15							6	8	14	57.1	0.2	0	
5:15-5:30							12	10	22	45.5	0.3	3	
5:30-5:45							14	10	24	41.7	0.4	1	
5:45-6:00							24	16	40	40.0	0.6	1	
1時間計							56	44	100	44.0	1.6	5	
6:00-6:15							18	15	33	45.5	0.5	1	
6:15-6:30							23	10	33	30.3	0.5	0	
6:30-6:45							38	17	55	30.9	0.9	3	
6:45-7:00							44	22	66	33.3	1.0	5	
1時間計							123	64	187	34.2	2.9	9	
夜12時間計							1218	424	1642	25.8	25.7	53	
全時間合計							4936	1465	6401	22.9	100.0	170	
昼夜率							1.33	1.41	1.35	-	-	1.45	

方向別自動車交通量調査表

調査地点：地域社会4 瀬谷土橋公園入口

調査年月日：令和2年9月29日(火) 天候：曇りのち晴れ



方向	1						2						
	種別	小型車 (台)	大型車 (台)	合計 (台)	大型車 混入率 (%)	時間 係数 (%)	二輪車 (台)	小型車 (台)	大型車 (台)	合計 (台)	大型車 混入率 (%)	時間 係数 (%)	二輪車 (台)
7:00-7:15	時間帯	25	6	31	19.4	1.7	0	112	18	130	13.8	1.7	11
7:15-7:30		32	14	46	30.4	2.5	2	109	16	125	12.8	1.6	14
7:30-7:45		19	10	29	34.5	1.6	1	97	23	120	19.2	1.5	7
7:45-8:00		23	7	30	23.3	1.6	3	115	16	131	12.2	1.7	7
	1時間計	99	37	136	27.2	7.3	6	433	73	506	14.4	6.5	39
8:00-8:15		23	11	34	32.4	1.8	0	126	11	137	8.0	1.8	13
8:15-8:30		29	10	39	25.6	2.1	2	106	21	127	16.5	1.6	15
8:30-8:45		24	4	28	14.3	1.5	1	111	33	144	22.9	1.9	3
8:45-9:00		23	13	36	36.1	1.9	0	74	16	90	17.8	1.2	7
	1時間計	99	38	137	27.7	7.3	3	417	81	498	16.3	6.4	38
9:00-9:15		18	10	28	35.7	1.5	2	85	25	110	22.7	1.4	3
9:15-9:30		17	14	31	45.2	1.7	0	80	25	105	23.8	1.4	9
9:30-9:45		13	11	24	45.8	1.3	0	84	20	104	19.2	1.3	2
9:45-10:00		20	11	31	35.5	1.7	0	94	24	118	20.3	1.5	6
	1時間計	68	46	114	40.4	6.1	2	343	94	437	21.5	5.6	20
10:00-10:15		23	8	31	25.8	1.7	0	81	29	110	26.4	1.4	7
10:15-10:30		27	12	39	30.8	2.1	1	62	25	87	28.7	1.1	5
10:30-10:45		21	14	35	40.0	1.9	0	86	33	119	27.7	1.5	4
10:45-11:00		22	14	36	38.9	1.9	0	65	34	99	34.3	1.3	7
	1時間計	93	48	141	34.0	7.6	1	294	121	415	29.2	5.3	23
11:00-11:15		14	19	33	57.6	1.8	1	87	26	113	23.0	1.5	6
11:15-11:30		19	11	30	36.7	1.6	0	73	12	85	14.1	1.1	5
11:30-11:45		14	17	31	54.8	1.7	0	76	23	99	23.2	1.3	4
11:45-12:00		21	9	30	30.0	1.6	1	102	23	125	18.4	1.6	5
	1時間計	68	56	124	45.2	6.6	2	338	84	422	19.9	5.4	20
12:00-12:15		19	8	27	29.6	1.4	0	86	16	102	15.7	1.3	7
12:15-12:30		21	10	31	32.3	1.7	2	81	14	95	14.7	1.2	7
12:30-12:45		20	10	30	33.3	1.6	2	82	16	98	16.3	1.3	5
12:45-13:00		20	9	29	31.0	1.6	0	91	16	107	15.0	1.4	2
	1時間計	80	37	117	31.6	6.3	4	340	62	402	15.4	5.2	21
13:00-13:15		23	11	34	32.4	1.8	1	80	15	95	15.8	1.2	0
13:15-13:30		18	9	27	33.3	1.4	0	96	14	110	12.7	1.4	3
13:30-13:45		16	12	28	42.9	1.5	2	99	27	126	21.4	1.6	3
13:45-14:00		16	11	27	40.7	1.4	1	75	18	93	19.4	1.2	4
	1時間計	73	43	116	37.1	6.2	4	350	74	424	17.5	5.5	10
14:00-14:15		19	15	34	44.1	1.8	0	83	27	110	24.5	1.4	6
14:15-14:30		17	14	31	45.2	1.7	0	73	26	99	26.3	1.3	3
14:30-14:45		15	6	21	28.6	1.1	0	88	21	109	19.3	1.4	2
14:45-15:00		17	11	28	39.3	1.5	0	69	21	90	23.3	1.2	6
	1時間計	68	46	114	40.4	6.1	0	313	95	408	23.3	5.3	17

方向別自動車交通量調査表

調査地点：地域社会4 瀬谷土橋公園入口

調査年月日：令和2年9月29日(火) 天候：曇りのち晴れ



方向 種別 時間帯	1						2					
	小型車 (台)	大型車 (台)	合計 (台)	大型車 混入率 (%)	時間 係数 (%)	二輪車 (台)	小型車 (台)	大型車 (台)	合計 (台)	大型車 混入率 (%)	時間 係数 (%)	二輪車 (台)
15:00-15:15	25	12	37	32.4	2.0	0	93	20	113	17.7	1.5	4
15:15-15:30	25	5	30	16.7	1.6	0	113	26	139	18.7	1.8	4
15:30-15:45	18	6	24	25.0	1.3	1	104	23	127	18.1	1.6	9
15:45-16:00	19	7	26	26.9	1.4	0	73	28	101	27.7	1.3	7
1時間計	87	30	117	25.6	6.3	1	383	97	480	20.2	6.2	24
16:00-16:15	19	4	23	17.4	1.2	1	114	24	138	17.4	1.8	8
16:15-16:30	20	7	27	25.9	1.4	0	136	21	157	13.4	2.0	8
16:30-16:45	25	13	38	34.2	2.0	0	102	22	124	17.7	1.6	8
16:45-17:00	27	7	34	20.6	1.8	0	93	14	107	13.1	1.4	5
1時間計	91	31	122	25.4	6.5	1	445	81	526	15.4	6.8	29
17:00-17:15	15	4	19	21.1	1.0	0	108	25	133	18.8	1.7	3
17:15-17:30	21	9	30	30.0	1.6	0	135	8	143	5.6	1.8	11
17:30-17:45	17	6	23	26.1	1.2	1	150	9	159	5.7	2.0	17
17:45-18:00	14	9	23	39.1	1.2	0	147	14	161	8.7	2.1	10
1時間計	67	28	95	29.5	5.1	1	540	56	596	9.4	7.7	41
18:00-18:15	22	4	26	15.4	1.4	1	138	15	153	9.8	2.0	1
18:15-18:30	13	7	20	35.0	1.1	1	148	11	159	6.9	2.0	6
18:30-18:45	9	5	14	35.7	0.7	0	160	11	171	6.4	2.2	10
18:45-19:00	11	5	16	31.3	0.9	0	132	13	145	9.0	1.9	8
1時間計	55	21	76	27.6	4.1	2	578	50	628	8.0	8.1	25
昼12時間計	948	461	1409	32.7	75.5	27	4774	968	5742	16.9	73.9	307
19:00-19:15	16	4	20	20.0	1.1	0	148	6	154	3.9	2.0	12
19:15-19:30	16	6	22	27.3	1.2	0	150	5	155	3.2	2.0	7
19:30-19:45	10	9	19	47.4	1.0	0	140	9	149	6.0	1.9	11
19:45-20:00	9	5	14	35.7	0.7	1	89	7	96	7.3	1.2	9
1時間計	51	24	75	32.0	4.0	1	527	27	554	4.9	7.1	39
20:00-20:15	8	4	12	33.3	0.6	1	104	13	117	11.1	1.5	15
20:15-20:30	6	3	9	33.3	0.5	0	88	5	93	5.4	1.2	7
20:30-20:45	15	9	24	37.5	1.3	0	76	5	81	6.2	1.0	8
20:45-21:00	8	3	11	27.3	0.6	0	49	5	54	9.3	0.7	10
1時間計	37	19	56	33.9	3.0	1	317	28	345	8.1	4.4	40
21:00-21:15	3	3	6	50.0	0.3	0	53	4	57	7.0	0.7	3
21:15-21:30	11	5	16	31.3	0.9	1	49	1	50	2.0	0.6	4
21:30-21:45	7	6	13	46.2	0.7	0	37	2	39	5.1	0.5	2
21:45-22:00	4	2	6	33.3	0.3	0	32	4	36	11.1	0.5	3
1時間計	25	16	41	39.0	2.2	1	171	11	182	6.0	2.3	12
22:00-22:15	6	2	8	25.0	0.4	0	38	4	42	9.5	0.5	3
22:15-22:30	2	2	4	50.0	0.2	0	34	2	36	5.6	0.5	1
22:30-22:45	2	1	3	33.3	0.2	0	26	2	28	7.1	0.4	0
22:45-23:00	1	1	2	50.0	0.1	0	17	3	20	15.0	0.3	2
1時間計	11	6	17	35.3	0.9	0	115	11	126	8.7	1.6	6

方向別自動車交通量調査表

調査地点：地域社会4 瀬谷土橋公園入口

調査年月日：令和2年9月29日(火) 天候：曇りのち晴れ



方向 種別 時間帯	1						2					
	小型車 (台)	大型車 (台)	合計 (台)	大型車 混入率 (%)	時間 係数 (%)	二輪車 (台)	小型車 (台)	大型車 (台)	合計 (台)	大型車 混入率 (%)	時間 係数 (%)	二輪車 (台)
23:00-23:15	2	2	4	50.0	0.2	1	17	4	21	19.0	0.3	3
23:15-23:30	2	6	8	75.0	0.4	0	14	1	15	6.7	0.2	1
23:30-23:45	0	7	7	100.0	0.4	0	5	1	6	16.7	0.1	4
23:45-24:00	1	4	5	80.0	0.3	0	15	2	17	11.8	0.2	2
1時間計	5	19	24	79.2	1.3	1	51	8	59	13.6	0.8	10
0:00-0:15	1	5	6	83.3	0.3	0	15	8	23	34.8	0.3	1
0:15-0:30	4	6	10	60.0	0.5	0	12	2	14	14.3	0.2	1
0:30-0:45	3	6	9	66.7	0.5	0	10	2	12	16.7	0.2	3
0:45-1:00	1	2	3	66.7	0.2	0	9	5	14	35.7	0.2	1
1時間計	9	19	28	67.9	1.5	0	46	17	63	27.0	0.8	6
1:00-1:15	1	2	3	66.7	0.2	0	7	8	15	53.3	0.2	0
1:15-1:30	2	6	8	75.0	0.4	0	6	4	10	40.0	0.1	0
1:30-1:45	2	3	5	60.0	0.3	0	9	9	18	50.0	0.2	1
1:45-2:00	0	4	4	100.0	0.2	0	6	5	11	45.5	0.1	1
1時間計	5	15	20	75.0	1.1	0	28	26	54	48.1	0.7	2
2:00-2:15	1	5	6	83.3	0.3	0	7	6	13	46.2	0.2	0
2:15-2:30	2	5	7	71.4	0.4	0	2	3	5	60.0	0.1	0
2:30-2:45	3	5	8	62.5	0.4	0	5	3	8	37.5	0.1	0
2:45-3:00	0	5	5	100.0	0.3	0	4	4	8	50.0	0.1	0
1時間計	6	20	26	76.9	1.4	0	18	16	34	47.1	0.4	0
3:00-3:15	0	5	5	100.0	0.3	0	6	2	8	25.0	0.1	1
3:15-3:30	0	2	2	100.0	0.1	0	9	3	12	25.0	0.2	2
3:30-3:45	1	4	5	80.0	0.3	0	10	3	13	23.1	0.2	0
3:45-4:00	2	3	5	60.0	0.3	0	7	1	8	12.5	0.1	1
1時間計	3	14	17	82.4	0.9	0	32	9	41	22.0	0.5	4
4:00-4:15	1	2	3	66.7	0.2	0	6	7	13	53.8	0.2	0
4:15-4:30	2	2	4	50.0	0.2	0	12	4	16	25.0	0.2	1
4:30-4:45	1	1	2	50.0	0.1	0	8	3	11	27.3	0.1	1
4:45-5:00	4	5	9	55.6	0.5	0	8	3	11	27.3	0.1	0
1時間計	8	10	18	55.6	1.0	0	34	17	51	33.3	0.7	2
5:00-5:15	3	4	7	57.1	0.4	0	21	4	25	16.0	0.3	2
5:15-5:30	8	6	14	42.9	0.7	1	13	4	17	23.5	0.2	1
5:30-5:45	4	1	5	20.0	0.3	0	29	10	39	25.6	0.5	0
5:45-6:00	8	6	14	42.9	0.7	0	46	8	54	14.8	0.7	1
1時間計	23	17	40	42.5	2.1	1	109	26	135	19.3	1.7	4
6:00-6:15	20	4	24	16.7	1.3	2	63	11	74	14.9	1.0	7
6:15-6:30	13	5	18	27.8	1.0	1	67	8	75	10.7	1.0	6
6:30-6:45	14	4	18	22.2	1.0	1	84	16	100	16.0	1.3	11
6:45-7:00	26	10	36	27.8	1.9	0	113	21	134	15.7	1.7	8
1時間計	73	23	96	24.0	5.1	4	327	56	383	14.6	4.9	32
夜12時間計	256	202	458	44.1	24.5	9	1775	252	2027	12.4	26.1	157
全時間合計	1204	663	1867	35.5	100.0	36	6549	1220	7769	15.7	100.0	464
昼夜率	1.27	1.44	1.33	-	-	1.33	1.37	1.26	1.35	-	-	1.51

方向別自動車交通量調査表

調査地点：地域社会4 瀬谷土橋公園入口

調査年月日：令和2年9月29日(火) 天候：曇りのち晴れ



方向 種別 時間帯							A 合計 (1+2)					
	小型車 (台)	大型車 (台)	合計 (台)	大型車 混入率 (%)	時間 係数 (%)	二輪車 (台)	小型車 (台)	大型車 (台)	合計 (台)	大型車 混入率 (%)	時間 係数 (%)	二輪車 (台)
7:00-7:15							137	24	161	14.9	1.7	11
7:15-7:30							141	30	171	17.5	1.8	16
7:30-7:45							116	33	149	22.1	1.5	8
7:45-8:00							138	23	161	14.3	1.7	10
1 時間計							532	110	642	17.1	6.7	45
8:00-8:15							149	22	171	12.9	1.8	13
8:15-8:30							135	31	166	18.7	1.7	17
8:30-8:45							135	37	172	21.5	1.8	4
8:45-9:00							97	29	126	23.0	1.3	7
1 時間計							516	119	635	18.7	6.6	41
9:00-9:15							103	35	138	25.4	1.4	5
9:15-9:30							97	39	136	28.7	1.4	9
9:30-9:45							97	31	128	24.2	1.3	2
9:45-10:00							114	35	149	23.5	1.5	6
1 時間計							411	140	551	25.4	5.7	22
10:00-10:15							104	37	141	26.2	1.5	7
10:15-10:30							89	37	126	29.4	1.3	6
10:30-10:45							107	47	154	30.5	1.6	4
10:45-11:00							87	48	135	35.6	1.4	7
1 時間計							387	169	556	30.4	5.8	24
11:00-11:15							101	45	146	30.8	1.5	7
11:15-11:30							92	23	115	20.0	1.2	5
11:30-11:45							90	40	130	30.8	1.3	4
11:45-12:00							123	32	155	20.6	1.6	6
1 時間計							406	140	546	25.6	5.7	22
12:00-12:15							105	24	129	18.6	1.3	7
12:15-12:30							102	24	126	19.0	1.3	9
12:30-12:45							102	26	128	20.3	1.3	7
12:45-13:00							111	25	136	18.4	1.4	2
1 時間計							420	99	519	19.1	5.4	25
13:00-13:15							103	26	129	20.2	1.3	1
13:15-13:30							114	23	137	16.8	1.4	3
13:30-13:45							115	39	154	25.3	1.6	5
13:45-14:00							91	29	120	24.2	1.2	5
1 時間計							423	117	540	21.7	5.6	14
14:00-14:15							102	42	144	29.2	1.5	6
14:15-14:30							90	40	130	30.8	1.3	3
14:30-14:45							103	27	130	20.8	1.3	2
14:45-15:00							86	32	118	27.1	1.2	6
1 時間計							381	141	522	27.0	5.4	17

方向別自動車交通量調査表

調査地点：地域社会4 瀬谷土橋公園入口

調査年月日：令和2年9月29日(火) 天候：曇りのち晴れ



方向 時間帯							A 合計 (1+2)					
	種別 小型車 (台)	大型車 (台)	合計 (台)	大型車 混入率 (%)	時間 係数 (%)	二輪車 (台)	小型車 (台)	大型車 (台)	合計 (台)	大型車 混入率 (%)	時間 係数 (%)	二輪車 (台)
15:00-15:15							118	32	150	21.3	1.6	4
15:15-15:30							138	31	169	18.3	1.8	4
15:30-15:45							122	29	151	19.2	1.6	10
15:45-16:00							92	35	127	27.6	1.3	7
1時間計							470	127	597	21.3	6.2	25
16:00-16:15							133	28	161	17.4	1.7	9
16:15-16:30							156	28	184	15.2	1.9	8
16:30-16:45							127	35	162	21.6	1.7	8
16:45-17:00							120	21	141	14.9	1.5	5
1時間計							536	112	648	17.3	6.7	30
17:00-17:15							123	29	152	19.1	1.6	3
17:15-17:30							156	17	173	9.8	1.8	11
17:30-17:45							167	15	182	8.2	1.9	18
17:45-18:00							161	23	184	12.5	1.9	10
1時間計							607	84	691	12.2	7.2	42
18:00-18:15							160	19	179	10.6	1.9	2
18:15-18:30							161	18	179	10.1	1.9	7
18:30-18:45							169	16	185	8.6	1.9	10
18:45-19:00							143	18	161	11.2	1.7	8
1時間計							633	71	704	10.1	7.3	27
昼12時間計							5722	1429	7151	20.0	74.2	334
19:00-19:15							164	10	174	5.7	1.8	12
19:15-19:30							166	11	177	6.2	1.8	7
19:30-19:45							150	18	168	10.7	1.7	11
19:45-20:00							98	12	110	10.9	1.1	10
1時間計							578	51	629	8.1	6.5	40
20:00-20:15							112	17	129	13.2	1.3	16
20:15-20:30							94	8	102	7.8	1.1	7
20:30-20:45							91	14	105	13.3	1.1	8
20:45-21:00							57	8	65	12.3	0.7	10
1時間計							354	47	401	11.7	4.2	41
21:00-21:15							56	7	63	11.1	0.7	3
21:15-21:30							60	6	66	9.1	0.7	5
21:30-21:45							44	8	52	15.4	0.5	2
21:45-22:00							36	6	42	14.3	0.4	3
1時間計							196	27	223	12.1	2.3	13
22:00-22:15							44	6	50	12.0	0.5	3
22:15-22:30							36	4	40	10.0	0.4	1
22:30-22:45							28	3	31	9.7	0.3	0
22:45-23:00							18	4	22	18.2	0.2	2
1時間計							126	17	143	11.9	1.5	6

方向別自動車交通量調査表

調査地点：地域社会4 瀬谷土橋公園入口

調査年月日：令和2年9月29日(火) 天候：曇りのち晴れ



方向							A 合計 (1+2)						
	種別	小型車 (台)	大型車 (台)	合計 (台)	大型車 混入率 (%)	時間 係数 (%)	二輪車 (台)	小型車 (台)	大型車 (台)	合計 (台)	大型車 混入率 (%)	時間 係数 (%)	二輪車 (台)
時間帯													
23:00-23:15							19	6	25	24.0	0.3	4	
23:15-23:30							16	7	23	30.4	0.2	1	
23:30-23:45							5	8	13	61.5	0.1	4	
23:45-24:00							16	6	22	27.3	0.2	2	
1時間計							56	27	83	32.5	0.9	11	
0:00-0:15							16	13	29	44.8	0.3	1	
0:15-0:30							16	8	24	33.3	0.2	1	
0:30-0:45							13	8	21	38.1	0.2	3	
0:45-1:00							10	7	17	41.2	0.2	1	
1時間計							55	36	91	39.6	0.9	6	
1:00-1:15							8	10	18	55.6	0.2	0	
1:15-1:30							8	10	18	55.6	0.2	0	
1:30-1:45							11	12	23	52.2	0.2	1	
1:45-2:00							6	9	15	60.0	0.2	1	
1時間計							33	41	74	55.4	0.8	2	
2:00-2:15							8	11	19	57.9	0.2	0	
2:15-2:30							4	8	12	66.7	0.1	0	
2:30-2:45							8	8	16	50.0	0.2	0	
2:45-3:00							4	9	13	69.2	0.1	0	
1時間計							24	36	60	60.0	0.6	0	
3:00-3:15							6	7	13	53.8	0.1	1	
3:15-3:30							9	5	14	35.7	0.1	2	
3:30-3:45							11	7	18	38.9	0.2	0	
3:45-4:00							9	4	13	30.8	0.1	1	
1時間計							35	23	58	39.7	0.6	4	
4:00-4:15							7	9	16	56.3	0.2	0	
4:15-4:30							14	6	20	30.0	0.2	1	
4:30-4:45							9	4	13	30.8	0.1	1	
4:45-5:00							12	8	20	40.0	0.2	0	
1時間計							42	27	69	39.1	0.7	2	
5:00-5:15							24	8	32	25.0	0.3	2	
5:15-5:30							21	10	31	32.3	0.3	2	
5:30-5:45							33	11	44	25.0	0.5	0	
5:45-6:00							54	14	68	20.6	0.7	1	
1時間計							132	43	175	24.6	1.8	5	
6:00-6:15							83	15	98	15.3	1.0	9	
6:15-6:30							80	13	93	14.0	1.0	7	
6:30-6:45							98	20	118	16.9	1.2	12	
6:45-7:00							139	31	170	18.2	1.8	8	
1時間計							400	79	479	16.5	5.0	36	
夜12時間計							2031	454	2485	18.3	25.8	166	
全時間合計							7753	1883	9636	19.5	100.0	500	
昼夜率							1.35	1.32	1.35	-	-	1.50	

方向別自動車交通量調査表

調査地点：地域社会4 瀬谷土橋公園入口

調査年月日：令和2年9月29日(火) 天候：曇りのち晴れ



方向	3						4						
	種別	小型車 (台)	大型車 (台)	合計 (台)	大型車 混入率 (%)	時間 係数 (%)	二輪車 (台)	小型車 (台)	大型車 (台)	合計 (台)	大型車 混入率 (%)	時間 係数 (%)	二輪車 (台)
7:00-7:15		116	16	132	12.1	2.2	22	18	5	23	21.7	2.0	2
7:15-7:30		108	14	122	11.5	2.0	15	20	3	23	13.0	2.0	1
7:30-7:45		114	17	131	13.0	2.2	14	21	5	26	19.2	2.2	2
7:45-8:00		131	18	149	12.1	2.5	16	9	4	13	30.8	1.1	0
1時間計		469	65	534	12.2	9.0	67	68	17	85	20.0	7.3	5
8:00-8:15		119	18	137	13.1	2.3	9	13	2	15	13.3	1.3	1
8:15-8:30		120	24	144	16.7	2.4	11	12	5	17	29.4	1.5	1
8:30-8:45		97	27	124	21.8	2.1	9	11	4	15	26.7	1.3	0
8:45-9:00		95	21	116	18.1	1.9	7	14	4	18	22.2	1.5	0
1時間計		431	90	521	17.3	8.7	36	50	15	65	23.1	5.6	2
9:00-9:15		88	27	115	23.5	1.9	9	11	9	20	45.0	1.7	0
9:15-9:30		63	19	82	23.2	1.4	3	16	4	20	20.0	1.7	1
9:30-9:45		69	26	95	27.4	1.6	5	11	7	18	38.9	1.5	0
9:45-10:00		82	22	104	21.2	1.7	4	11	2	13	15.4	1.1	0
1時間計		302	94	396	23.7	6.6	21	49	22	71	31.0	6.1	1
10:00-10:15		98	30	128	23.4	2.1	5	8	7	15	46.7	1.3	0
10:15-10:30		68	11	79	13.9	1.3	2	12	5	17	29.4	1.5	0
10:30-10:45		72	14	86	16.3	1.4	5	9	9	18	50.0	1.5	0
10:45-11:00		58	22	80	27.5	1.3	4	9	6	15	40.0	1.3	0
1時間計		296	77	373	20.6	6.3	16	38	27	65	41.5	5.6	0
11:00-11:15		48	23	71	32.4	1.2	4	16	2	18	11.1	1.5	0
11:15-11:30		75	19	94	20.2	1.6	2	10	4	14	28.6	1.2	0
11:30-11:45		68	14	82	17.1	1.4	4	10	4	14	28.6	1.2	1
11:45-12:00		46	6	52	11.5	0.9	3	8	5	13	38.5	1.1	0
1時間計		237	62	299	20.7	5.0	13	44	15	59	25.4	5.0	1
12:00-12:15		57	15	72	20.8	1.2	6	9	8	17	47.1	1.5	1
12:15-12:30		54	11	65	16.9	1.1	5	8	9	17	52.9	1.5	0
12:30-12:45		43	12	55	21.8	0.9	7	15	9	24	37.5	2.0	1
12:45-13:00		50	10	60	16.7	1.0	5	7	2	9	22.2	0.8	0
1時間計		204	48	252	19.0	4.2	23	39	28	67	41.8	5.7	2
13:00-13:15		65	21	86	24.4	1.4	5	17	6	23	26.1	2.0	1
13:15-13:30		76	9	85	10.6	1.4	4	6	5	11	45.5	0.9	0
13:30-13:45		53	12	65	18.5	1.1	3	14	6	20	30.0	1.7	0
13:45-14:00		58	12	70	17.1	1.2	7	9	12	21	57.1	1.8	0
1時間計		252	54	306	17.6	5.1	19	46	29	75	38.7	6.4	1
14:00-14:15		56	15	71	21.1	1.2	3	14	6	20	30.0	1.7	0
14:15-14:30		45	6	51	11.8	0.9	4	15	6	21	28.6	1.8	1
14:30-14:45		42	12	54	22.2	0.9	2	16	13	29	44.8	2.5	0
14:45-15:00		76	13	89	14.6	1.5	4	9	2	11	18.2	0.9	0
1時間計		219	46	265	17.4	4.4	13	54	27	81	33.3	6.9	1

方向別自動車交通量調査表

調査地点：地域社会4 瀬谷土橋公園入口

調査年月日：令和2年9月29日(火) 天候：曇りのち晴れ



方向 種別 時間帯	3						4					
	小型車 (台)	大型車 (台)	合計 (台)	大型車 混入率 (%)	時間 係数 (%)	二輪車 (台)	小型車 (台)	大型車 (台)	合計 (台)	大型車 混入率 (%)	時間 係数 (%)	二輪車 (台)
15:00-15:15	72	10	82	12.2	1.4	8	20	5	25	20.0	2.1	0
15:15-15:30	61	14	75	18.7	1.3	5	8	4	12	33.3	1.0	1
15:30-15:45	69	6	75	8.0	1.3	6	13	4	17	23.5	1.5	1
15:45-16:00	57	7	64	10.9	1.1	9	3	5	8	62.5	0.7	0
1時間計	259	37	296	12.5	5.0	28	44	18	62	29.0	5.3	2
16:00-16:15	66	18	84	21.4	1.4	7	9	9	18	50.0	1.5	0
16:15-16:30	72	8	80	10.0	1.3	3	12	3	15	20.0	1.3	0
16:30-16:45	84	15	99	15.2	1.7	3	11	1	12	8.3	1.0	0
16:45-17:00	85	7	92	7.6	1.5	11	14	2	16	12.5	1.4	2
1時間計	307	48	355	13.5	6.0	24	46	15	61	24.6	5.2	2
17:00-17:15	80	5	85	5.9	1.4	4	8	3	11	27.3	0.9	3
17:15-17:30	91	13	104	12.5	1.7	6	22	1	23	4.3	2.0	0
17:30-17:45	120	10	130	7.7	2.2	12	13	5	18	27.8	1.5	1
17:45-18:00	75	7	82	8.5	1.4	8	9	6	15	40.0	1.3	0
1時間計	366	35	401	8.7	6.7	30	52	15	67	22.4	5.7	4
18:00-18:15	114	5	119	4.2	2.0	9	4	3	7	42.9	0.6	0
18:15-18:30	99	4	103	3.9	1.7	7	7	2	9	22.2	0.8	0
18:30-18:45	92	4	96	4.2	1.6	15	14	5	19	26.3	1.6	1
18:45-19:00	103	5	108	4.6	1.8	10	4	1	5	20.0	0.4	2
1時間計	408	18	426	4.2	7.2	41	29	11	40	27.5	3.4	3
昼12時間計	3750	674	4424	15.2	74.3	331	559	239	798	29.9	68.1	24
19:00-19:15	75	4	79	5.1	1.3	6	17	3	20	15.0	1.7	0
19:15-19:30	74	3	77	3.9	1.3	7	7	3	10	30.0	0.9	1
19:30-19:45	78	3	81	3.7	1.4	9	6	4	10	40.0	0.9	0
19:45-20:00	61	3	64	4.7	1.1	2	10	1	11	9.1	0.9	0
1時間計	288	13	301	4.3	5.1	24	40	11	51	21.6	4.4	1
20:00-20:15	69	1	70	1.4	1.2	7	6	1	7	14.3	0.6	0
20:15-20:30	53	4	57	7.0	1.0	3	6	1	7	14.3	0.6	0
20:30-20:45	38	2	40	5.0	0.7	6	6	0	6	0.0	0.5	0
20:45-21:00	43	1	44	2.3	0.7	9	6	2	8	25.0	0.7	0
1時間計	203	8	211	3.8	3.5	25	24	4	28	14.3	2.4	0
21:00-21:15	64	2	66	3.0	1.1	2	7	0	7	0.0	0.6	2
21:15-21:30	40	1	41	2.4	0.7	5	16	0	16	0.0	1.4	2
21:30-21:45	33	4	37	10.8	0.6	1	5	2	7	28.6	0.6	0
21:45-22:00	31	1	32	3.1	0.5	5	3	1	4	25.0	0.3	0
1時間計	168	8	176	4.5	3.0	13	31	3	34	8.8	2.9	4
22:00-22:15	25	2	27	7.4	0.5	0	7	3	10	30.0	0.9	1
22:15-22:30	33	1	34	2.9	0.6	3	4	6	10	60.0	0.9	0
22:30-22:45	34	3	37	8.1	0.6	5	5	0	5	0.0	0.4	0
22:45-23:00	19	4	23	17.4	0.4	3	2	4	6	66.7	0.5	0
1時間計	111	10	121	8.3	2.0	11	18	13	31	41.9	2.6	1

方向別自動車交通量調査表

調査地点：地域社会4 瀬谷土橋公園入口

調査年月日：令和2年9月29日(火) 天候：曇りのち晴れ



方向	3						4						
	種別	小型車 (台)	大型車 (台)	合計 (台)	大型車 混入率 (%)	時間 係数 (%)	二輪車 (台)	小型車 (台)	大型車 (台)	合計 (台)	大型車 混入率 (%)	時間 係数 (%)	二輪車 (台)
23:00-23:15		17	3	20	15.0	0.3	2	5	1	6	16.7	0.5	0
23:15-23:30		10	6	16	37.5	0.3	0	3	0	3	0.0	0.3	0
23:30-23:45		7	3	10	30.0	0.2	0	3	1	4	25.0	0.3	0
23:45-24:00		10	1	11	9.1	0.2	1	4	1	5	20.0	0.4	0
1時間計		44	13	57	22.8	1.0	3	15	3	18	16.7	1.5	0
0:00-0:15		5	5	10	50.0	0.2	1	3	0	3	0.0	0.3	0
0:15-0:30		7	3	10	30.0	0.2	0	2	0	2	0.0	0.2	0
0:30-0:45		2	1	3	33.3	0.1	1	0	1	1	100.0	0.1	0
0:45-1:00		6	1	7	14.3	0.1	1	1	0	1	0.0	0.1	0
1時間計		20	10	30	33.3	0.5	3	6	1	7	14.3	0.6	0
1:00-1:15		3	2	5	40.0	0.1	0	6	2	8	25.0	0.7	0
1:15-1:30		4	3	7	42.9	0.1	1	4	0	4	0.0	0.3	0
1:30-1:45		1	1	2	50.0	0.0	2	2	1	3	33.3	0.3	0
1:45-2:00		8	2	10	20.0	0.2	0	0	0	0	0.0	0.0	0
1時間計		16	8	24	33.3	0.4	3	12	3	15	20.0	1.3	0
2:00-2:15		6	1	7	14.3	0.1	0	2	0	2	0.0	0.2	0
2:15-2:30		3	2	5	40.0	0.1	2	0	0	0	0.0	0.0	0
2:30-2:45		4	1	5	20.0	0.1	1	0	0	0	0.0	0.0	0
2:45-3:00		6	0	6	0.0	0.1	1	2	0	2	0.0	0.2	0
1時間計		19	4	23	17.4	0.4	4	4	0	4	0.0	0.3	0
3:00-3:15		1	0	1	0.0	0.0	0	0	1	1	100.0	0.1	0
3:15-3:30		7	3	10	30.0	0.2	2	1	2	3	66.7	0.3	0
3:30-3:45		5	2	7	28.6	0.1	1	2	1	3	33.3	0.3	0
3:45-4:00		9	3	12	25.0	0.2	0	4	4	8	50.0	0.7	0
1時間計		22	8	30	26.7	0.5	3	7	8	15	53.3	1.3	0
4:00-4:15		2	1	3	33.3	0.1	0	0	2	2	100.0	0.2	0
4:15-4:30		8	2	10	20.0	0.2	0	1	1	2	50.0	0.2	0
4:30-4:45		7	5	12	41.7	0.2	2	1	0	1	0.0	0.1	0
4:45-5:00		15	4	19	21.1	0.3	5	3	2	5	40.0	0.4	1
1時間計		32	12	44	27.3	0.7	7	5	5	10	50.0	0.9	1
5:00-5:15		17	6	23	26.1	0.4	3	2	2	4	50.0	0.3	0
5:15-5:30		15	8	23	34.8	0.4	3	7	4	11	36.4	0.9	0
5:30-5:45		25	9	34	26.5	0.6	5	18	3	21	14.3	1.8	0
5:45-6:00		46	8	54	14.8	0.9	2	18	4	22	18.2	1.9	0
1時間計		103	31	134	23.1	2.2	13	45	13	58	22.4	5.0	0
6:00-6:15		65	8	73	11.0	1.2	10	15	7	22	31.8	1.9	1
6:15-6:30		70	12	82	14.6	1.4	9	16	6	22	27.3	1.9	0
6:30-6:45		85	21	106	19.8	1.8	14	16	8	24	33.3	2.0	0
6:45-7:00		108	13	121	10.7	2.0	17	26	8	34	23.5	2.9	0
1時間計		328	54	382	14.1	6.4	50	73	29	102	28.4	8.7	1
夜12時間計		1354	179	1533	11.7	25.7	159	280	93	373	24.9	31.9	8
全時間合計		5104	853	5957	14.3	100.0	490	839	332	1171	28.4	100.0	32
昼夜率		1.36	1.27	1.35	-	-	1.48	1.50	1.39	1.47	-	-	1.33

方向別自動車交通量調査表

調査地点：地域社会4 瀬谷土橋公園入口

調査年月日：令和2年9月29日(火) 天候：曇りのち晴れ



時間帯	種別	方向					B 合計 (3+4)					
		小型車 (台)	大型車 (台)	合計 (台)	大型車 混入率 (%)	時間 係数 (%)	二輪車 (台)	小型車 (台)	大型車 (台)	合計 (台)	大型車 混入率 (%)	時間 係数 (%)
7:00-7:15							134	21	155	13.5	2.2	24
7:15-7:30							128	17	145	11.7	2.0	16
7:30-7:45							135	22	157	14.0	2.2	16
7:45-8:00							140	22	162	13.6	2.3	16
1時間計							537	82	619	13.2	8.7	72
8:00-8:15							132	20	152	13.2	2.1	10
8:15-8:30							132	29	161	18.0	2.3	12
8:30-8:45							108	31	139	22.3	2.0	9
8:45-9:00							109	25	134	18.7	1.9	7
1時間計							481	105	586	17.9	8.2	38
9:00-9:15							99	36	135	26.7	1.9	9
9:15-9:30							79	23	102	22.5	1.4	4
9:30-9:45							80	33	113	29.2	1.6	5
9:45-10:00							93	24	117	20.5	1.6	4
1時間計							351	116	467	24.8	6.6	22
10:00-10:15							106	37	143	25.9	2.0	5
10:15-10:30							80	16	96	16.7	1.3	2
10:30-10:45							81	23	104	22.1	1.5	5
10:45-11:00							67	28	95	29.5	1.3	4
1時間計							334	104	438	23.7	6.1	16
11:00-11:15							64	25	89	28.1	1.2	4
11:15-11:30							85	23	108	21.3	1.5	2
11:30-11:45							78	18	96	18.8	1.3	5
11:45-12:00							54	11	65	16.9	0.9	3
1時間計							281	77	358	21.5	5.0	14
12:00-12:15							66	23	89	25.8	1.2	7
12:15-12:30							62	20	82	24.4	1.2	5
12:30-12:45							58	21	79	26.6	1.1	8
12:45-13:00							57	12	69	17.4	1.0	5
1時間計							243	76	319	23.8	4.5	25
13:00-13:15							82	27	109	24.8	1.5	6
13:15-13:30							82	14	96	14.6	1.3	4
13:30-13:45							67	18	85	21.2	1.2	3
13:45-14:00							67	24	91	26.4	1.3	7
1時間計							298	83	381	21.8	5.3	20
14:00-14:15							70	21	91	23.1	1.3	3
14:15-14:30							60	12	72	16.7	1.0	5
14:30-14:45							58	25	83	30.1	1.2	2
14:45-15:00							85	15	100	15.0	1.4	4
1時間計							273	73	346	21.1	4.9	14

方向別自動車交通量調査表

調査地点：地域社会4 瀬谷土橋公園入口

調査年月日：令和2年9月29日(火) 天候：曇りのち晴れ



方向 時間帯							B 合計 (3+4)					
	種別 小型車 (台)	大型車 (台)	合計 (台)	大型車 混入率 (%)	時間 係数 (%)	二輪車 (台)	小型車 (台)	大型車 (台)	合計 (台)	大型車 混入率 (%)	時間 係数 (%)	二輪車 (台)
15:00-15:15							92	15	107	14.0	1.5	8
15:15-15:30							69	18	87	20.7	1.2	6
15:30-15:45							82	10	92	10.9	1.3	7
15:45-16:00							60	12	72	16.7	1.0	9
1時間計							303	55	358	15.4	5.0	30
16:00-16:15							75	27	102	26.5	1.4	7
16:15-16:30							84	11	95	11.6	1.3	3
16:30-16:45							95	16	111	14.4	1.6	3
16:45-17:00							99	9	108	8.3	1.5	13
1時間計							353	63	416	15.1	5.8	26
17:00-17:15							88	8	96	8.3	1.3	7
17:15-17:30							113	14	127	11.0	1.8	6
17:30-17:45							133	15	148	10.1	2.1	13
17:45-18:00							84	13	97	13.4	1.4	8
1時間計							418	50	468	10.7	6.6	34
18:00-18:15							118	8	126	6.3	1.8	9
18:15-18:30							106	6	112	5.4	1.6	7
18:30-18:45							106	9	115	7.8	1.6	16
18:45-19:00							107	6	113	5.3	1.6	12
1時間計							437	29	466	6.2	6.5	44
昼12時間計							4309	913	5222	17.5	73.3	355
19:00-19:15							92	7	99	7.1	1.4	6
19:15-19:30							81	6	87	6.9	1.2	8
19:30-19:45							84	7	91	7.7	1.3	9
19:45-20:00							71	4	75	5.3	1.1	2
1時間計							328	24	352	6.8	4.9	25
20:00-20:15							75	2	77	2.6	1.1	7
20:15-20:30							59	5	64	7.8	0.9	3
20:30-20:45							44	2	46	4.3	0.6	6
20:45-21:00							49	3	52	5.8	0.7	9
1時間計							227	12	239	5.0	3.4	25
21:00-21:15							71	2	73	2.7	1.0	4
21:15-21:30							56	1	57	1.8	0.8	7
21:30-21:45							38	6	44	13.6	0.6	1
21:45-22:00							34	2	36	5.6	0.5	5
1時間計							199	11	210	5.2	2.9	17
22:00-22:15							32	5	37	13.5	0.5	1
22:15-22:30							37	7	44	15.9	0.6	3
22:30-22:45							39	3	42	7.1	0.6	5
22:45-23:00							21	8	29	27.6	0.4	3
1時間計							129	23	152	15.1	2.1	12

方向別自動車交通量調査表

調査地点：地域社会4 瀬谷土橋公園入口

調査年月日：令和2年9月29日(火) 天候：曇りのち晴れ



方向 種別 時間帯							B 合計 (3+4)					
	小型車 (台)	大型車 (台)	合計 (台)	大型車 混入率 (%)	時間 係数 (%)	二輪車 (台)	小型車 (台)	大型車 (台)	合計 (台)	大型車 混入率 (%)	時間 係数 (%)	二輪車 (台)
23:00-23:15							22	4	26	15.4	0.4	2
23:15-23:30							13	6	19	31.6	0.3	0
23:30-23:45							10	4	14	28.6	0.2	0
23:45-24:00							14	2	16	12.5	0.2	1
1 時間計							59	16	75	21.3	1.1	3
0:00-0:15							8	5	13	38.5	0.2	1
0:15-0:30							9	3	12	25.0	0.2	0
0:30-0:45							2	2	4	50.0	0.1	1
0:45-1:00							7	1	8	12.5	0.1	1
1 時間計							26	11	37	29.7	0.5	3
1:00-1:15							9	4	13	30.8	0.2	0
1:15-1:30							8	3	11	27.3	0.2	1
1:30-1:45							3	2	5	40.0	0.1	2
1:45-2:00							8	2	10	20.0	0.1	0
1 時間計							28	11	39	28.2	0.5	3
2:00-2:15							8	1	9	11.1	0.1	0
2:15-2:30							3	2	5	40.0	0.1	2
2:30-2:45							4	1	5	20.0	0.1	1
2:45-3:00							8	0	8	0.0	0.1	1
1 時間計							23	4	27	14.8	0.4	4
3:00-3:15							1	1	2	50.0	0.0	0
3:15-3:30							8	5	13	38.5	0.2	2
3:30-3:45							7	3	10	30.0	0.1	1
3:45-4:00							13	7	20	35.0	0.3	0
1 時間計							29	16	45	35.6	0.6	3
4:00-4:15							2	3	5	60.0	0.1	0
4:15-4:30							9	3	12	25.0	0.2	0
4:30-4:45							8	5	13	38.5	0.2	2
4:45-5:00							18	6	24	25.0	0.3	6
1 時間計							37	17	54	31.5	0.8	8
5:00-5:15							19	8	27	29.6	0.4	3
5:15-5:30							22	12	34	35.3	0.5	3
5:30-5:45							43	12	55	21.8	0.8	5
5:45-6:00							64	12	76	15.8	1.1	2
1 時間計							148	44	192	22.9	2.7	13
6:00-6:15							80	15	95	15.8	1.3	11
6:15-6:30							86	18	104	17.3	1.5	9
6:30-6:45							101	29	130	22.3	1.8	14
6:45-7:00							134	21	155	13.5	2.2	17
1 時間計							401	83	484	17.1	6.8	51
夜12時間計							1634	272	1906	14.3	26.7	167
全時間合計							5943	1185	7128	16.6	100.0	522
昼夜率							1.38	1.30	1.36	-	-	1.47

方向別自動車交通量調査表

調査地点：地域社会4 瀬谷土橋公園入口

調査年月日：令和2年9月29日(火) 天候：曇りのち晴れ



方向 時間帯	5						6					
	種別 小型車 (台)	大型車 (台)	合計 (台)	大型車 混入率 (%)	時間 係数 (%)	二輪車 (台)	小型車 (台)	大型車 (台)	合計 (台)	大型車 混入率 (%)	時間 係数 (%)	二輪車 (台)
7:00-7:15	10	5	15	33.3	1.4	0	61	7	68	10.3	1.8	1
7:15-7:30	17	3	20	15.0	1.8	1	59	16	75	21.3	2.0	3
7:30-7:45	18	5	23	21.7	2.1	0	82	10	92	10.9	2.4	2
7:45-8:00	15	2	17	11.8	1.6	0	70	6	76	7.9	2.0	2
1時間計	60	15	75	20.0	6.9	1	272	39	311	12.5	8.1	8
8:00-8:15	8	3	11	27.3	1.0	3	66	18	84	21.4	2.2	2
8:15-8:30	6	12	18	66.7	1.7	0	67	8	75	10.7	2.0	0
8:30-8:45	2	6	8	75.0	0.7	0	53	13	66	19.7	1.7	3
8:45-9:00	4	2	6	33.3	0.6	1	39	10	49	20.4	1.3	2
1時間計	20	23	43	53.5	4.0	4	225	49	274	17.9	7.1	7
9:00-9:15	6	2	8	25.0	0.7	0	55	8	63	12.7	1.6	2
9:15-9:30	7	2	9	22.2	0.8	0	46	10	56	17.9	1.5	2
9:30-9:45	4	5	9	55.6	0.8	0	46	16	62	25.8	1.6	2
9:45-10:00	4	4	8	50.0	0.7	0	26	7	33	21.2	0.9	0
1時間計	21	13	34	38.2	3.1	0	173	41	214	19.2	5.6	6
10:00-10:15	9	1	10	10.0	0.9	0	28	8	36	22.2	0.9	2
10:15-10:30	4	1	5	20.0	0.5	0	40	9	49	18.4	1.3	3
10:30-10:45	3	6	9	66.7	0.8	0	33	8	41	19.5	1.1	0
10:45-11:00	4	5	9	55.6	0.8	1	38	19	57	33.3	1.5	1
1時間計	20	13	33	39.4	3.0	1	139	44	183	24.0	4.8	6
11:00-11:15	10	5	15	33.3	1.4	0	29	13	42	31.0	1.1	1
11:15-11:30	11	4	15	26.7	1.4	0	38	7	45	15.6	1.2	3
11:30-11:45	6	6	12	50.0	1.1	1	47	7	54	13.0	1.4	0
11:45-12:00	6	4	10	40.0	0.9	0	45	16	61	26.2	1.6	0
1時間計	33	19	52	36.5	4.8	1	159	43	202	21.3	5.3	4
12:00-12:15	3	4	7	57.1	0.6	0	40	10	50	20.0	1.3	1
12:15-12:30	6	3	9	33.3	0.8	0	38	11	49	22.4	1.3	2
12:30-12:45	12	8	20	40.0	1.8	0	53	7	60	11.7	1.6	4
12:45-13:00	4	5	9	55.6	0.8	0	28	10	38	26.3	1.0	1
1時間計	25	20	45	44.4	4.1	0	159	38	197	19.3	5.1	8
13:00-13:15	7	1	8	12.5	0.7	0	51	15	66	22.7	1.7	1
13:15-13:30	6	2	8	25.0	0.7	0	37	12	49	24.5	1.3	0
13:30-13:45	4	6	10	60.0	0.9	0	38	12	50	24.0	1.3	1
13:45-14:00	9	3	12	25.0	1.1	0	33	12	45	26.7	1.2	1
1時間計	26	12	38	31.6	3.5	0	159	51	210	24.3	5.5	3
14:00-14:15	13	3	16	18.8	1.5	2	29	10	39	25.6	1.0	2
14:15-14:30	5	5	10	50.0	0.9	0	46	17	63	27.0	1.6	1
14:30-14:45	15	3	18	16.7	1.7	0	58	9	67	13.4	1.7	1
14:45-15:00	20	6	26	23.1	2.4	0	36	12	48	25.0	1.2	0
1時間計	53	17	70	24.3	6.4	2	169	48	217	22.1	5.6	4

方向別自動車交通量調査表

調査地点：地域社会4 瀬谷土橋公園入口

調査年月日：令和2年9月29日(火) 天候：曇りのち晴れ



方向 種別 時間帯	5						6					
	小型車 (台)	大型車 (台)	合計 (台)	大型車 混入率 (%)	時間 係数 (%)	二輪車 (台)	小型車 (台)	大型車 (台)	合計 (台)	大型車 混入率 (%)	時間 係数 (%)	二輪車 (台)
15:00-15:15	14	10	24	41.7	2.2	0	45	8	53	15.1	1.4	0
15:15-15:30	18	9	27	33.3	2.5	1	57	2	59	3.4	1.5	3
15:30-15:45	14	7	21	33.3	1.9	0	70	4	74	5.4	1.9	3
15:45-16:00	13	4	17	23.5	1.6	3	47	8	55	14.5	1.4	1
1時間計	59	30	89	33.7	8.2	4	219	22	241	9.1	6.3	7
16:00-16:15	13	4	17	23.5	1.6	1	66	6	72	8.3	1.9	1
16:15-16:30	10	1	11	9.1	1.0	1	64	14	78	17.9	2.0	1
16:30-16:45	26	5	31	16.1	2.9	0	42	8	50	16.0	1.3	2
16:45-17:00	14	0	14	0.0	1.3	0	40	8	48	16.7	1.2	3
1時間計	63	10	73	13.7	6.7	2	212	36	248	14.5	6.4	7
17:00-17:15	15	1	16	6.3	1.5	1	71	5	76	6.6	2.0	5
17:15-17:30	17	0	17	0.0	1.6	3	53	2	55	3.6	1.4	4
17:30-17:45	18	1	19	5.3	1.7	5	75	6	81	7.4	2.1	2
17:45-18:00	36	3	39	7.7	3.6	2	83	3	86	3.5	2.2	2
1時間計	86	5	91	5.5	8.4	11	282	16	298	5.4	7.7	13
18:00-18:15	35	1	36	2.8	3.3	4	79	5	84	6.0	2.2	4
18:15-18:30	46	6	52	11.5	4.8	4	56	4	60	6.7	1.6	5
18:30-18:45	43	6	49	12.2	4.5	4	72	3	75	4.0	2.0	6
18:45-19:00	47	2	49	4.1	4.5	3	68	3	71	4.2	1.8	4
1時間計	171	15	186	8.1	17.1	15	275	15	290	5.2	7.5	19
昼12時間計	637	192	829	23.2	76.3	41	2443	442	2885	15.3	75.0	92
19:00-19:15	29	1	30	3.3	2.8	0	75	5	80	6.3	2.1	5
19:15-19:30	41	3	44	6.8	4.0	1	65	3	68	4.4	1.8	1
19:30-19:45	28	1	29	3.4	2.7	2	53	4	57	7.0	1.5	2
19:45-20:00	17	0	17	0.0	1.6	2	34	1	35	2.9	0.9	1
1時間計	115	5	120	4.2	11.0	5	227	13	240	5.4	6.2	9
20:00-20:15	20	0	20	0.0	1.8	2	40	5	45	11.1	1.2	1
20:15-20:30	7	0	7	0.0	0.6	0	27	2	29	6.9	0.8	3
20:30-20:45	7	1	8	12.5	0.7	1	42	1	43	2.3	1.1	2
20:45-21:00	9	0	9	0.0	0.8	1	15	1	16	6.3	0.4	1
1時間計	43	1	44	2.3	4.0	4	124	9	133	6.8	3.5	7
21:00-21:15	2	0	2	0.0	0.2	0	30	2	32	6.3	0.8	1
21:15-21:30	3	0	3	0.0	0.3	0	28	2	30	6.7	0.8	1
21:30-21:45	3	1	4	25.0	0.4	0	27	2	29	6.9	0.8	0
21:45-22:00	3	0	3	0.0	0.3	0	15	3	18	16.7	0.5	0
1時間計	11	1	12	8.3	1.1	0	100	9	109	8.3	2.8	2
22:00-22:15	0	0	0	0.0	0.0	0	15	2	17	11.8	0.4	0
22:15-22:30	1	0	1	0.0	0.1	1	17	2	19	10.5	0.5	1
22:30-22:45	2	0	2	0.0	0.2	0	24	2	26	7.7	0.7	1
22:45-23:00	2	0	2	0.0	0.2	0	12	1	13	7.7	0.3	3
1時間計	5	0	5	0.0	0.5	1	68	7	75	9.3	2.0	5

方向別自動車交通量調査表

調査地点：地域社会4 瀬谷土橋公園入口

調査年月日：令和2年9月29日(火) 天候：曇りのち晴れ



方向 種別 時間帯	5						6					
	小型車 (台)	大型車 (台)	合計 (台)	大型車 混入率 (%)	時間 係数 (%)	二輪車 (台)	小型車 (台)	大型車 (台)	合計 (台)	大型車 混入率 (%)	時間 係数 (%)	二輪車 (台)
23:00-23:15	5	1	6	16.7	0.6	0	9	0	9	0.0	0.2	2
23:15-23:30	3	1	4	25.0	0.4	0	8	1	9	11.1	0.2	0
23:30-23:45	1	0	1	0.0	0.1	0	5	0	5	0.0	0.1	1
23:45-24:00	4	0	4	0.0	0.4	0	5	5	10	50.0	0.3	0
1時間計	13	2	15	13.3	1.4	0	27	6	33	18.2	0.9	3
0:00-0:15	0	1	1	100.0	0.1	0	2	1	3	33.3	0.1	0
0:15-0:30	0	1	1	100.0	0.1	0	5	0	5	0.0	0.1	0
0:30-0:45	1	0	1	0.0	0.1	0	3	5	8	62.5	0.2	0
0:45-1:00	1	0	1	0.0	0.1	0	2	0	2	0.0	0.1	0
1時間計	2	2	4	50.0	0.4	0	12	6	18	33.3	0.5	0
1:00-1:15	1	0	1	0.0	0.1	0	3	5	8	62.5	0.2	0
1:15-1:30	3	0	3	0.0	0.3	0	3	2	5	40.0	0.1	0
1:30-1:45	1	0	1	0.0	0.1	0	4	2	6	33.3	0.2	0
1:45-2:00	0	2	2	100.0	0.2	1	1	3	4	75.0	0.1	0
1時間計	5	2	7	28.6	0.6	1	11	12	23	52.2	0.6	0
2:00-2:15	2	0	2	0.0	0.2	0	3	2	5	40.0	0.1	0
2:15-2:30	1	0	1	0.0	0.1	0	3	0	3	0.0	0.1	0
2:30-2:45	0	0	0	0.0	0.0	2	1	1	2	50.0	0.1	0
2:45-3:00	1	0	1	0.0	0.1	1	4	3	7	42.9	0.2	0
1時間計	4	0	4	0.0	0.4	3	11	6	17	35.3	0.4	0
3:00-3:15	0	0	0	0.0	0.0	0	2	3	5	60.0	0.1	3
3:15-3:30	3	0	3	0.0	0.3	0	3	1	4	25.0	0.1	0
3:30-3:45	1	0	1	0.0	0.1	0	1	2	3	66.7	0.1	0
3:45-4:00	1	1	2	50.0	0.2	1	2	2	4	50.0	0.1	0
1時間計	5	1	6	16.7	0.6	1	8	8	16	50.0	0.4	3
4:00-4:15	0	1	1	100.0	0.1	0	3	0	3	0.0	0.1	0
4:15-4:30	1	0	1	0.0	0.1	1	4	3	7	42.9	0.2	0
4:30-4:45	2	4	6	66.7	0.6	0	10	4	14	28.6	0.4	0
4:45-5:00	0	0	0	0.0	0.0	0	7	2	9	22.2	0.2	0
1時間計	3	5	8	62.5	0.7	1	24	9	33	27.3	0.9	0
5:00-5:15	0	2	2	100.0	0.2	0	7	9	16	56.3	0.4	0
5:15-5:30	4	1	5	20.0	0.5	1	11	6	17	35.3	0.4	0
5:30-5:45	0	0	0	0.0	0.0	0	13	5	18	27.8	0.5	0
5:45-6:00	0	0	0	0.0	0.0	0	14	7	21	33.3	0.5	0
1時間計	4	3	7	42.9	0.6	1	45	27	72	37.5	1.9	0
6:00-6:15	1	3	4	75.0	0.4	0	31	10	41	24.4	1.1	0
6:15-6:30	5	0	5	0.0	0.5	0	36	11	47	23.4	1.2	2
6:30-6:45	5	0	5	0.0	0.5	2	36	7	43	16.3	1.1	1
6:45-7:00	8	4	12	33.3	1.1	0	49	12	61	19.7	1.6	0
1時間計	19	7	26	26.9	2.4	2	152	40	192	20.8	5.0	3
夜12時間計	229	29	258	11.2	23.7	19	809	152	961	15.8	25.0	32
全時間合計	866	221	1087	20.3	100.0	60	3252	594	3846	15.4	100.0	124
昼夜率	1.36	1.15	1.31	-	-	1.46	1.33	1.34	1.33	-	-	1.35

方向別自動車交通量調査表

調査地点：地域社会4 瀬谷土橋公園入口

調査年月日：令和2年9月29日(火) 天候：曇りのち晴れ



方向 時間帯	種別						C 合計 (5+6)					
		小型車 (台)	大型車 (台)	合計 (台)	大型車 混入率 (%)	時間 係数 (%)	二輪車 (台)	小型車 (台)	大型車 (台)	合計 (台)	大型車 混入率 (%)	時間 係数 (%)
7:00-7:15							71	12	83	14.5	1.7	1
7:15-7:30							76	19	95	20.0	1.9	4
7:30-7:45							100	15	115	13.0	2.3	2
7:45-8:00							85	8	93	8.6	1.9	2
1時間計							332	54	386	14.0	7.8	9
8:00-8:15							74	21	95	22.1	1.9	5
8:15-8:30							73	20	93	21.5	1.9	0
8:30-8:45							55	19	74	25.7	1.5	3
8:45-9:00							43	12	55	21.8	1.1	3
1時間計							245	72	317	22.7	6.4	11
9:00-9:15							61	10	71	14.1	1.4	2
9:15-9:30							53	12	65	18.5	1.3	2
9:30-9:45							50	21	71	29.6	1.4	2
9:45-10:00							30	11	41	26.8	0.8	0
1時間計							194	54	248	21.8	5.0	6
10:00-10:15							37	9	46	19.6	0.9	2
10:15-10:30							44	10	54	18.5	1.1	3
10:30-10:45							36	14	50	28.0	1.0	0
10:45-11:00							42	24	66	36.4	1.3	2
1時間計							159	57	216	26.4	4.4	7
11:00-11:15							39	18	57	31.6	1.2	1
11:15-11:30							49	11	60	18.3	1.2	3
11:30-11:45							53	13	66	19.7	1.3	1
11:45-12:00							51	20	71	28.2	1.4	0
1時間計							192	62	254	24.4	5.1	5
12:00-12:15							43	14	57	24.6	1.2	1
12:15-12:30							44	14	58	24.1	1.2	2
12:30-12:45							65	15	80	18.8	1.6	4
12:45-13:00							32	15	47	31.9	1.0	1
1時間計							184	58	242	24.0	4.9	8
13:00-13:15							58	16	74	21.6	1.5	1
13:15-13:30							43	14	57	24.6	1.2	0
13:30-13:45							42	18	60	30.0	1.2	1
13:45-14:00							42	15	57	26.3	1.2	1
1時間計							185	63	248	25.4	5.0	3
14:00-14:15							42	13	55	23.6	1.1	4
14:15-14:30							51	22	73	30.1	1.5	1
14:30-14:45							73	12	85	14.1	1.7	1
14:45-15:00							56	18	74	24.3	1.5	0
1時間計							222	65	287	22.6	5.8	6

方向別自動車交通量調査表

調査地点：地域社会4 瀬谷土橋公園入口

調査年月日：令和2年9月29日(火) 天候：曇りのち晴れ



方向 時間帯							C 合計 (5+6)					
	種別 小型車 (台)	大型車 (台)	合計 (台)	大型車 混入率 (%)	時間 係数 (%)	二輪車 (台)	小型車 (台)	大型車 (台)	合計 (台)	大型車 混入率 (%)	時間 係数 (%)	二輪車 (台)
15:00-15:15							59	18	77	23.4	1.6	0
15:15-15:30							75	11	86	12.8	1.7	4
15:30-15:45							84	11	95	11.6	1.9	3
15:45-16:00							60	12	72	16.7	1.5	4
1時間計							278	52	330	15.8	6.7	11
16:00-16:15							79	10	89	11.2	1.8	2
16:15-16:30							74	15	89	16.9	1.8	2
16:30-16:45							68	13	81	16.0	1.6	2
16:45-17:00							54	8	62	12.9	1.3	3
1時間計							275	46	321	14.3	6.5	9
17:00-17:15							86	6	92	6.5	1.9	6
17:15-17:30							70	2	72	2.8	1.5	7
17:30-17:45							93	7	100	7.0	2.0	7
17:45-18:00							119	6	125	4.8	2.5	4
1時間計							368	21	389	5.4	7.9	24
18:00-18:15							114	6	120	5.0	2.4	8
18:15-18:30							102	10	112	8.9	2.3	9
18:30-18:45							115	9	124	7.3	2.5	10
18:45-19:00							115	5	120	4.2	2.4	7
1時間計							446	30	476	6.3	9.6	34
昼12時間計							3080	634	3714	17.1	75.3	133
19:00-19:15							104	6	110	5.5	2.2	5
19:15-19:30							106	6	112	5.4	2.3	2
19:30-19:45							81	5	86	5.8	1.7	4
19:45-20:00							51	1	52	1.9	1.1	3
1時間計							342	18	360	5.0	7.3	14
20:00-20:15							60	5	65	7.7	1.3	3
20:15-20:30							34	2	36	5.6	0.7	3
20:30-20:45							49	2	51	3.9	1.0	3
20:45-21:00							24	1	25	4.0	0.5	2
1時間計							167	10	177	5.6	3.6	11
21:00-21:15							32	2	34	5.9	0.7	1
21:15-21:30							31	2	33	6.1	0.7	1
21:30-21:45							30	3	33	9.1	0.7	0
21:45-22:00							18	3	21	14.3	0.4	0
1時間計							111	10	121	8.3	2.5	2
22:00-22:15							15	2	17	11.8	0.3	0
22:15-22:30							18	2	20	10.0	0.4	2
22:30-22:45							26	2	28	7.1	0.6	1
22:45-23:00							14	1	15	6.7	0.3	3
1時間計							73	7	80	8.8	1.6	6

方向別自動車交通量調査表

調査地点：地域社会4 瀬谷土橋公園入口

調査年月日：令和2年9月29日(火) 天候：曇りのち晴れ



方向 時間帯	種別	C 合計 (5+6)										
		小型車 (台)	大型車 (台)	合計 (台)	大型車 混入率 (%)	時間 係数 (%)	二輪車 (台)	小型車 (台)	大型車 (台)	合計 (台)	大型車 混入率 (%)	時間 係数 (%)
23:00-23:15							14	1	15	6.7	0.3	2
23:15-23:30							11	2	13	15.4	0.3	0
23:30-23:45							6	0	6	0.0	0.1	1
23:45-24:00							9	5	14	35.7	0.3	0
1時間計							40	8	48	16.7	1.0	3
0:00-0:15							2	2	4	50.0	0.1	0
0:15-0:30							5	1	6	16.7	0.1	0
0:30-0:45							4	5	9	55.6	0.2	0
0:45-1:00							3	0	3	0.0	0.1	0
1時間計							14	8	22	36.4	0.4	0
1:00-1:15							4	5	9	55.6	0.2	0
1:15-1:30							6	2	8	25.0	0.2	0
1:30-1:45							5	2	7	28.6	0.1	0
1:45-2:00							1	5	6	83.3	0.1	1
1時間計							16	14	30	46.7	0.6	1
2:00-2:15							5	2	7	28.6	0.1	0
2:15-2:30							4	0	4	0.0	0.1	0
2:30-2:45							1	1	2	50.0	0.0	2
2:45-3:00							5	3	8	37.5	0.2	1
1時間計							15	6	21	28.6	0.4	3
3:00-3:15							2	3	5	60.0	0.1	3
3:15-3:30							6	1	7	14.3	0.1	0
3:30-3:45							2	2	4	50.0	0.1	0
3:45-4:00							3	3	6	50.0	0.1	1
1時間計							13	9	22	40.9	0.4	4
4:00-4:15							3	1	4	25.0	0.1	0
4:15-4:30							5	3	8	37.5	0.2	1
4:30-4:45							12	8	20	40.0	0.4	0
4:45-5:00							7	2	9	22.2	0.2	0
1時間計							27	14	41	34.1	0.8	1
5:00-5:15							7	11	18	61.1	0.4	0
5:15-5:30							15	7	22	31.8	0.4	1
5:30-5:45							13	5	18	27.8	0.4	0
5:45-6:00							14	7	21	33.3	0.4	0
1時間計							49	30	79	38.0	1.6	1
6:00-6:15							32	13	45	28.9	0.9	0
6:15-6:30							41	11	52	21.2	1.1	2
6:30-6:45							41	7	48	14.6	1.0	3
6:45-7:00							57	16	73	21.9	1.5	0
1時間計							171	47	218	21.6	4.4	5
夜12時間計							1038	181	1219	14.8	24.7	51
全時間合計							4118	815	4933	16.5	100.0	184
昼夜率							1.34	1.29	1.33	-	-	1.38

方向別自動車交通量調査表

調査地点：地域社会4 瀬谷土橋公園前

調査年月日：令和2年9月29日(火) 天候：曇りのち晴れ



方向 種別 時間帯	1						2					
	小型車 (台)	大型車 (台)	合計 (台)	大型車 混入率 (%)	時間 係数 (%)	二輪車 (台)	小型車 (台)	大型車 (台)	合計 (台)	大型車 混入率 (%)	時間 係数 (%)	二輪車 (台)
7:00-7:15	16	3	19	15.8	1.4	0	62	6	68	8.8	1.6	1
7:15-7:30	17	3	20	15.0	1.5	2	77	8	85	9.4	2.0	5
7:30-7:45	21	3	24	12.5	1.8	0	89	4	93	4.3	2.2	4
7:45-8:00	29	5	34	14.7	2.5	0	98	8	106	7.5	2.5	2
1時間計	83	14	97	14.4	7.2	2	326	26	352	7.4	8.4	12
8:00-8:15	22	2	24	8.3	1.8	0	74	10	84	11.9	2.0	4
8:15-8:30	29	5	34	14.7	2.5	1	82	9	91	9.9	2.2	2
8:30-8:45	21	6	27	22.2	2.0	0	50	5	55	9.1	1.3	3
8:45-9:00	14	3	17	17.6	1.3	0	58	10	68	14.7	1.6	3
1時間計	86	16	102	15.7	7.6	1	264	34	298	11.4	7.1	12
9:00-9:15	12	8	20	40.0	1.5	1	54	6	60	10.0	1.4	0
9:15-9:30	13	5	18	27.8	1.3	0	41	8	49	16.3	1.2	3
9:30-9:45	6	3	9	33.3	0.7	0	38	16	54	29.6	1.3	1
9:45-10:00	10	4	14	28.6	1.0	1	39	9	48	18.8	1.1	0
1時間計	41	20	61	32.8	4.6	2	172	39	211	18.5	5.0	4
10:00-10:15	9	7	16	43.8	1.2	0	39	8	47	17.0	1.1	2
10:15-10:30	6	11	17	64.7	1.3	1	41	6	47	12.8	1.1	3
10:30-10:45	5	8	13	61.5	1.0	0	35	14	49	28.6	1.2	0
10:45-11:00	7	7	14	50.0	1.0	2	41	16	57	28.1	1.4	1
1時間計	27	33	60	55.0	4.5	3	156	44	200	22.0	4.8	6
11:00-11:15	10	8	18	44.4	1.3	0	33	20	53	37.7	1.3	1
11:15-11:30	10	11	21	52.4	1.6	1	44	10	54	18.5	1.3	4
11:30-11:45	10	9	19	47.4	1.4	0	40	11	51	21.6	1.2	1
11:45-12:00	7	7	14	50.0	1.0	1	47	14	61	23.0	1.5	0
1時間計	37	35	72	48.6	5.4	2	164	55	219	25.1	5.2	6
12:00-12:15	13	15	28	53.6	2.1	0	34	17	51	33.3	1.2	0
12:15-12:30	12	7	19	36.8	1.4	0	31	14	45	31.1	1.1	2
12:30-12:45	13	7	20	35.0	1.5	0	40	14	54	25.9	1.3	3
12:45-13:00	14	8	22	36.4	1.6	1	28	11	39	28.2	0.9	2
1時間計	52	37	89	41.6	6.6	1	133	56	189	29.6	4.5	7
13:00-13:15	14	6	20	30.0	1.5	1	49	12	61	19.7	1.5	1
13:15-13:30	7	5	12	41.7	0.9	0	38	12	50	24.0	1.2	1
13:30-13:45	7	3	10	30.0	0.7	0	50	10	60	16.7	1.4	1
13:45-14:00	9	8	17	47.1	1.3	0	38	12	50	24.0	1.2	0
1時間計	37	22	59	37.3	4.4	1	175	46	221	20.8	5.3	3
14:00-14:15	10	3	13	23.1	1.0	0	36	13	49	26.5	1.2	3
14:15-14:30	7	8	15	53.3	1.1	1	39	16	55	29.1	1.3	1
14:30-14:45	20	6	26	23.1	1.9	1	70	7	77	9.1	1.8	1
14:45-15:00	13	11	24	45.8	1.8	0	61	15	76	19.7	1.8	1
1時間計	50	28	78	35.9	5.8	2	206	51	257	19.8	6.1	6

方向別自動車交通量調査表

調査地点：地域社会4 瀬谷土橋公園前

調査年月日：令和2年9月29日(火) 天候：曇りのち晴れ



方向 種別 時間帯	1						2					
	小型車 (台)	大型車 (台)	合計 (台)	大型車 混入率 (%)	時間 係数 (%)	二輪車 (台)	小型車 (台)	大型車 (台)	合計 (台)	大型車 混入率 (%)	時間 係数 (%)	二輪車 (台)
15:00-15:15	14	13	27	48.1	2.0	1	55	17	72	23.6	1.7	0
15:15-15:30	11	15	26	57.7	1.9	1	74	9	83	10.8	2.0	4
15:30-15:45	17	10	27	37.0	2.0	0	72	8	80	10.0	1.9	3
15:45-16:00	13	11	24	45.8	1.8	0	54	11	65	16.9	1.5	3
1時間計	55	49	104	47.1	7.8	2	255	45	300	15.0	7.1	10
16:00-16:15	12	4	16	25.0	1.2	0	70	12	82	14.6	2.0	3
16:15-16:30	13	9	22	40.9	1.6	0	59	14	73	19.2	1.7	1
16:30-16:45	5	9	14	64.3	1.0	0	55	13	68	19.1	1.6	1
16:45-17:00	14	8	22	36.4	1.6	0	52	6	58	10.3	1.4	4
1時間計	44	30	74	40.5	5.5	0	236	45	281	16.0	6.7	9
17:00-17:15	12	17	29	58.6	2.2	0	65	3	68	4.4	1.6	4
17:15-17:30	15	10	25	40.0	1.9	0	69	4	73	5.5	1.7	7
17:30-17:45	11	8	19	42.1	1.4	1	70	7	77	9.1	1.8	4
17:45-18:00	22	9	31	29.0	2.3	2	92	8	100	8.0	2.4	4
1時間計	60	44	104	42.3	7.8	3	296	22	318	6.9	7.6	19
18:00-18:15	24	9	33	27.3	2.5	2	92	7	99	7.1	2.4	7
18:15-18:30	29	6	35	17.1	2.6	1	86	10	96	10.4	2.3	11
18:30-18:45	19	6	25	24.0	1.9	1	90	7	97	7.2	2.3	3
18:45-19:00	19	11	30	36.7	2.2	2	96	8	104	7.7	2.5	7
1時間計	91	32	123	26.0	9.2	6	364	32	396	8.1	9.4	28
昼12時間計	663	360	1023	35.2	76.3	25	2747	495	3242	15.3	77.3	122
19:00-19:15	30	8	38	21.1	2.8	3	79	3	82	3.7	2.0	5
19:15-19:30	31	7	38	18.4	2.8	4	78	4	82	4.9	2.0	0
19:30-19:45	17	2	19	10.5	1.4	1	57	5	62	8.1	1.5	2
19:45-20:00	8	5	13	38.5	1.0	1	59	1	60	1.7	1.4	3
1時間計	86	22	108	20.4	8.1	9	273	13	286	4.5	6.8	10
20:00-20:15	4	3	7	42.9	0.5	0	30	2	32	6.3	0.8	2
20:15-20:30	4	2	6	33.3	0.4	0	33	1	34	2.9	0.8	2
20:30-20:45	4	1	5	20.0	0.4	1	28	1	29	3.4	0.7	2
20:45-21:00	0	0	0	0.0	0.0	0	14	0	14	0.0	0.3	1
1時間計	12	6	18	33.3	1.3	1	105	4	109	3.7	2.6	7
21:00-21:15	4	3	7	42.9	0.5	0	30	0	30	0.0	0.7	0
21:15-21:30	3	2	5	40.0	0.4	0	25	2	27	7.4	0.6	1
21:30-21:45	4	0	4	0.0	0.3	0	28	2	30	6.7	0.7	0
21:45-22:00	4	2	6	33.3	0.4	1	17	1	18	5.6	0.4	0
1時間計	15	7	22	31.8	1.6	1	100	5	105	4.8	2.5	1
22:00-22:15	3	2	5	40.0	0.4	0	10	1	11	9.1	0.3	0
22:15-22:30	6	0	6	0.0	0.4	1	19	1	20	5.0	0.5	1
22:30-22:45	1	0	1	0.0	0.1	0	22	1	23	4.3	0.5	1
22:45-23:00	4	4	8	50.0	0.6	0	15	0	15	0.0	0.4	2
1時間計	14	6	20	30.0	1.5	1	66	3	69	4.3	1.6	4

方向別自動車交通量調査表

調査地点：地域社会4 瀬谷土橋公園前

調査年月日：令和2年9月29日(火) 天候：曇りのち晴れ



方向 種別 時間帯	1						2					
	小型車 (台)	大型車 (台)	合計 (台)	大型車 混入率 (%)	時係 数 (%)	二輪車 (台)	小型車 (台)	大型車 (台)	合計 (台)	大型車 混入率 (%)	時係 数 (%)	二輪車 (台)
23:00-23:15	0	0	0	0.0	0.0	0	10	0	10	0.0	0.2	1
23:15-23:30	0	0	0	0.0	0.0	0	6	0	6	0.0	0.1	0
23:30-23:45	0	1	1	100.0	0.1	0	8	2	10	20.0	0.2	1
23:45-24:00	4	1	5	20.0	0.4	0	8	5	13	38.5	0.3	0
1時間計	4	2	6	33.3	0.4	0	32	7	39	17.9	0.9	2
0:00-0:15	1	0	1	0.0	0.1	0	1	2	3	66.7	0.1	0
0:15-0:30	2	1	3	33.3	0.2	0	5	1	6	16.7	0.1	0
0:30-0:45	0	1	1	100.0	0.1	0	4	4	8	50.0	0.2	0
0:45-1:00	0	1	1	100.0	0.1	0	3	0	3	0.0	0.1	0
1時間計	3	3	6	50.0	0.4	0	13	7	20	35.0	0.5	0
1:00-1:15	1	2	3	66.7	0.2	0	3	0	3	0.0	0.1	0
1:15-1:30	3	2	5	40.0	0.4	0	0	0	0	0.0	0.0	1
1:30-1:45	5	5	10	50.0	0.7	0	1	1	2	50.0	0.0	0
1:45-2:00	2	6	8	75.0	0.6	0	3	3	6	50.0	0.1	1
1時間計	11	15	26	57.7	1.9	0	7	4	11	36.4	0.3	2
2:00-2:15	1	1	2	50.0	0.1	0	0	1	1	100.0	0.0	0
2:15-2:30	0	3	3	100.0	0.2	1	2	0	2	0.0	0.0	0
2:30-2:45	3	3	6	50.0	0.4	0	1	0	1	0.0	0.0	2
2:45-3:00	2	3	5	60.0	0.4	0	4	2	6	33.3	0.1	0
1時間計	6	10	16	62.5	1.2	1	7	3	10	30.0	0.2	2
3:00-3:15	1	3	4	75.0	0.3	0	2	2	4	50.0	0.1	3
3:15-3:30	1	1	2	50.0	0.1	0	6	2	8	25.0	0.2	0
3:30-3:45	2	1	3	33.3	0.2	0	3	1	4	25.0	0.1	0
3:45-4:00	1	1	2	50.0	0.1	0	4	2	6	33.3	0.1	1
1時間計	5	6	11	54.5	0.8	0	15	7	22	31.8	0.5	4
4:00-4:15	5	2	7	28.6	0.5	0	2	1	3	33.3	0.1	0
4:15-4:30	3	1	4	25.0	0.3	1	3	2	5	40.0	0.1	1
4:30-4:45	1	0	1	0.0	0.1	1	8	6	14	42.9	0.3	0
4:45-5:00	2	1	3	33.3	0.2	1	8	2	10	20.0	0.2	0
1時間計	11	4	15	26.7	1.1	3	21	11	32	34.4	0.8	1
5:00-5:15	4	1	5	20.0	0.4	0	7	6	13	46.2	0.3	0
5:15-5:30	5	2	7	28.6	0.5	1	14	7	21	33.3	0.5	1
5:30-5:45	4	7	11	63.6	0.8	0	15	2	17	11.8	0.4	0
5:45-6:00	4	4	8	50.0	0.6	2	11	4	15	26.7	0.4	0
1時間計	17	14	31	45.2	2.3	3	47	19	66	28.8	1.6	1
6:00-6:15	5	4	9	44.4	0.7	0	12	5	17	29.4	0.4	1
6:15-6:30	8	3	11	27.3	0.8	1	37	14	51	27.5	1.2	2
6:30-6:45	6	5	11	45.5	0.8	1	31	6	37	16.2	0.9	3
6:45-7:00	5	2	7	28.6	0.5	3	67	13	80	16.3	1.9	0
1時間計	24	14	38	36.8	2.8	5	147	38	185	20.5	4.4	6
夜12時間計	208	109	317	34.4	23.7	24	833	121	954	12.7	22.7	40
全時間合計	871	469	1340	35.0	100.0	49	3580	616	4196	14.7	100.0	162
昼夜率	1.31	1.30	1.31	-	-	1.96	1.30	1.24	1.29	-	-	1.33

方向別自動車交通量調査表

調査地点：地域社会4 瀬谷土橋公園前

調査年月日：令和2年9月29日(火) 天候：曇りのち晴れ



方向							A 合計 (1+2)					
	種別	小型車 (台)	大型車 (台)	合計 (台)	大型車 混入率 (%)	時間 係数 (%)	二輪車 (台)	小型車 (台)	大型車 (台)	合計 (台)	大型車 混入率 (%)	時間 係数 (%)
7:00-7:15							78	9	87	10.3	1.6	1
7:15-7:30							94	11	105	10.5	1.9	7
7:30-7:45							110	7	117	6.0	2.1	4
7:45-8:00							127	13	140	9.3	2.5	2
1時間計							409	40	449	8.9	8.1	14
8:00-8:15							96	12	108	11.1	2.0	4
8:15-8:30							111	14	125	11.2	2.3	3
8:30-8:45							71	11	82	13.4	1.5	3
8:45-9:00							72	13	85	15.3	1.5	3
1時間計							350	50	400	12.5	7.2	13
9:00-9:15							66	14	80	17.5	1.4	1
9:15-9:30							54	13	67	19.4	1.2	3
9:30-9:45							44	19	63	30.2	1.1	1
9:45-10:00							49	13	62	21.0	1.1	1
1時間計							213	59	272	21.7	4.9	6
10:00-10:15							48	15	63	23.8	1.1	2
10:15-10:30							47	17	64	26.6	1.2	4
10:30-10:45							40	22	62	35.5	1.1	0
10:45-11:00							48	23	71	32.4	1.3	3
1時間計							183	77	260	29.6	4.7	9
11:00-11:15							43	28	71	39.4	1.3	1
11:15-11:30							54	21	75	28.0	1.4	5
11:30-11:45							50	20	70	28.6	1.3	1
11:45-12:00							54	21	75	28.0	1.4	1
1時間計							201	90	291	30.9	5.3	8
12:00-12:15							47	32	79	40.5	1.4	0
12:15-12:30							43	21	64	32.8	1.2	2
12:30-12:45							53	21	74	28.4	1.3	3
12:45-13:00							42	19	61	31.1	1.1	3
1時間計							185	93	278	33.5	5.0	8
13:00-13:15							63	18	81	22.2	1.5	2
13:15-13:30							45	17	62	27.4	1.1	1
13:30-13:45							57	13	70	18.6	1.3	1
13:45-14:00							47	20	67	29.9	1.2	0
1時間計							212	68	280	24.3	5.1	4
14:00-14:15							46	16	62	25.8	1.1	3
14:15-14:30							46	24	70	34.3	1.3	2
14:30-14:45							90	13	103	12.6	1.9	2
14:45-15:00							74	26	100	26.0	1.8	1
1時間計							256	79	335	23.6	6.1	8

方向別自動車交通量調査表

調査地点：地域社会4 瀬谷土橋公園前

調査年月日：令和2年9月29日(火) 天候：曇りのち晴れ



方向 時間帯							A 合計 (1+2)					
	種別 小型車 (台)	大型車 (台)	合計 (台)	大型車 混入率 (%)	時間 係数 (%)	二輪車 (台)	小型車 (台)	大型車 (台)	合計 (台)	大型車 混入率 (%)	時間 係数 (%)	二輪車 (台)
15:00-15:15							69	30	99	30.3	1.8	1
15:15-15:30							85	24	109	22.0	2.0	5
15:30-15:45							89	18	107	16.8	1.9	3
15:45-16:00							67	22	89	24.7	1.6	3
1時間計							310	94	404	23.3	7.3	12
16:00-16:15							82	16	98	16.3	1.8	3
16:15-16:30							72	23	95	24.2	1.7	1
16:30-16:45							60	22	82	26.8	1.5	1
16:45-17:00							66	14	80	17.5	1.4	4
1時間計							280	75	355	21.1	6.4	9
17:00-17:15							77	20	97	20.6	1.8	4
17:15-17:30							84	14	98	14.3	1.8	7
17:30-17:45							81	15	96	15.6	1.7	5
17:45-18:00							114	17	131	13.0	2.4	6
1時間計							356	66	422	15.6	7.6	22
18:00-18:15							116	16	132	12.1	2.4	9
18:15-18:30							115	16	131	12.2	2.4	12
18:30-18:45							109	13	122	10.7	2.2	4
18:45-19:00							115	19	134	14.2	2.4	9
1時間計							455	64	519	12.3	9.4	34
昼12時間計							3410	855	4265	20.0	77.0	147
19:00-19:15							109	11	120	9.2	2.2	8
19:15-19:30							109	11	120	9.2	2.2	4
19:30-19:45							74	7	81	8.6	1.5	3
19:45-20:00							67	6	73	8.2	1.3	4
1時間計							359	35	394	8.9	7.1	19
20:00-20:15							34	5	39	12.8	0.7	2
20:15-20:30							37	3	40	7.5	0.7	2
20:30-20:45							32	2	34	5.9	0.6	3
20:45-21:00							14	0	14	0.0	0.3	1
1時間計							117	10	127	7.9	2.3	8
21:00-21:15							34	3	37	8.1	0.7	0
21:15-21:30							28	4	32	12.5	0.6	1
21:30-21:45							32	2	34	5.9	0.6	0
21:45-22:00							21	3	24	12.5	0.4	1
1時間計							115	12	127	9.4	2.3	2
22:00-22:15							13	3	16	18.8	0.3	0
22:15-22:30							25	1	26	3.8	0.5	2
22:30-22:45							23	1	24	4.2	0.4	1
22:45-23:00							19	4	23	17.4	0.4	2
1時間計							80	9	89	10.1	1.6	5

方向別自動車交通量調査表

調査地点：地域社会4 瀬谷土橋公園前

調査年月日：令和2年9月29日(火) 天候：曇りのち晴れ



方向 種別 時間帯							A 合計 (1+2)					
	小型車 (台)	大型車 (台)	合計 (台)	大型車 混入率 (%)	時間 係数 (%)	二輪車 (台)	小型車 (台)	大型車 (台)	合計 (台)	大型車 混入率 (%)	時間 係数 (%)	二輪車 (台)
23:00-23:15							10	0	10	0.0	0.2	1
23:15-23:30							6	0	6	0.0	0.1	0
23:30-23:45							8	3	11	27.3	0.2	1
23:45-24:00							12	6	18	33.3	0.3	0
1 時間計							36	9	45	20.0	0.8	2
0:00-0:15							2	2	4	50.0	0.1	0
0:15-0:30							7	2	9	22.2	0.2	0
0:30-0:45							4	5	9	55.6	0.2	0
0:45-1:00							3	1	4	25.0	0.1	0
1 時間計							16	10	26	38.5	0.5	0
1:00-1:15							4	2	6	33.3	0.1	0
1:15-1:30							3	2	5	40.0	0.1	1
1:30-1:45							6	6	12	50.0	0.2	0
1:45-2:00							5	9	14	64.3	0.3	1
1 時間計							18	19	37	51.4	0.7	2
2:00-2:15							1	2	3	66.7	0.1	0
2:15-2:30							2	3	5	60.0	0.1	1
2:30-2:45							4	3	7	42.9	0.1	2
2:45-3:00							6	5	11	45.5	0.2	0
1 時間計							13	13	26	50.0	0.5	3
3:00-3:15							3	5	8	62.5	0.1	3
3:15-3:30							7	3	10	30.0	0.2	0
3:30-3:45							5	2	7	28.6	0.1	0
3:45-4:00							5	3	8	37.5	0.1	1
1 時間計							20	13	33	39.4	0.6	4
4:00-4:15							7	3	10	30.0	0.2	0
4:15-4:30							6	3	9	33.3	0.2	2
4:30-4:45							9	6	15	40.0	0.3	1
4:45-5:00							10	3	13	23.1	0.2	1
1 時間計							32	15	47	31.9	0.8	4
5:00-5:15							11	7	18	38.9	0.3	0
5:15-5:30							19	9	28	32.1	0.5	2
5:30-5:45							19	9	28	32.1	0.5	0
5:45-6:00							15	8	23	34.8	0.4	2
1 時間計							64	33	97	34.0	1.8	4
6:00-6:15							17	9	26	34.6	0.5	1
6:15-6:30							45	17	62	27.4	1.1	3
6:30-6:45							37	11	48	22.9	0.9	4
6:45-7:00							72	15	87	17.2	1.6	3
1 時間計							171	52	223	23.3	4.0	11
夜12時間計							1041	230	1271	18.1	23.0	64
全時間合計							4451	1085	5536	19.6	100.0	211
昼夜率							1.31	1.27	1.30	-	-	1.44

方向別自動車交通量調査表

調査地点：地域社会4 瀬谷土橋公園前

調査年月日：令和2年9月29日(火) 天候：曇りのち晴れ



方向 時間帯	3						4					
	種別 小型車 (台)	大型車 (台)	合計 (台)	大型車 混入率 (%)	時間 係数 (%)	二輪車 (台)	種別 小型車 (台)	大型車 (台)	合計 (台)	大型車 混入率 (%)	時間 係数 (%)	二輪車 (台)
7:00-7:15	36	16	52	30.8	2.2	1	10	4	14	28.6	1.8	0
7:15-7:30	40	16	56	28.6	2.3	3	12	1	13	7.7	1.6	0
7:30-7:45	30	14	44	31.8	1.8	2	11	3	14	21.4	1.8	1
7:45-8:00	19	13	32	40.6	1.3	1	16	5	21	23.8	2.7	2
1時間計	125	59	184	32.1	7.7	7	49	13	62	21.0	7.8	3
8:00-8:15	24	7	31	22.6	1.3	2	8	7	15	46.7	1.9	0
8:15-8:30	34	14	48	29.2	2.0	1	11	1	12	8.3	1.5	2
8:30-8:45	20	5	25	20.0	1.0	0	13	3	16	18.8	2.0	2
8:45-9:00	30	8	38	21.1	1.6	0	18	6	24	25.0	3.0	0
1時間計	108	34	142	23.9	5.9	3	50	17	67	25.4	8.5	4
9:00-9:15	32	17	49	34.7	2.0	2	5	3	8	37.5	1.0	1
9:15-9:30	26	17	43	39.5	1.8	0	12	1	13	7.7	1.6	0
9:30-9:45	20	18	38	47.4	1.6	0	7	4	11	36.4	1.4	0
9:45-10:00	29	11	40	27.5	1.7	0	11	3	14	21.4	1.8	0
1時間計	107	63	170	37.1	7.1	2	35	11	46	23.9	5.8	1
10:00-10:15	26	14	40	35.0	1.7	0	11	3	14	21.4	1.8	0
10:15-10:30	24	6	30	20.0	1.2	0	15	4	19	21.1	2.4	0
10:30-10:45	29	16	45	35.6	1.9	0	7	9	16	56.3	2.0	0
10:45-11:00	28	14	42	33.3	1.7	0	7	6	13	46.2	1.6	0
1時間計	107	50	157	31.8	6.5	0	40	22	62	35.5	7.8	0
11:00-11:15	29	11	40	27.5	1.7	1	5	10	15	66.7	1.9	0
11:15-11:30	24	13	37	35.1	1.5	1	6	0	6	0.0	0.8	0
11:30-11:45	31	14	45	31.1	1.9	1	5	3	8	37.5	1.0	0
11:45-12:00	28	11	39	28.2	1.6	0	7	3	10	30.0	1.3	1
1時間計	112	49	161	30.4	6.7	3	23	16	39	41.0	4.9	1
12:00-12:15	23	14	37	37.8	1.5	0	10	5	15	33.3	1.9	1
12:15-12:30	24	14	38	36.8	1.6	0	9	4	13	30.8	1.6	0
12:30-12:45	27	17	44	38.6	1.8	2	9	4	13	30.8	1.6	1
12:45-13:00	21	14	35	40.0	1.5	0	10	6	16	37.5	2.0	0
1時間計	95	59	154	38.3	6.4	2	38	19	57	33.3	7.2	2
13:00-13:15	31	13	44	29.5	1.8	2	11	3	14	21.4	1.8	0
13:15-13:30	24	12	36	33.3	1.5	0	4	5	9	55.6	1.1	0
13:30-13:45	19	9	28	32.1	1.2	1	9	8	17	47.1	2.2	1
13:45-14:00	19	13	32	40.6	1.3	1	10	5	15	33.3	1.9	1
1時間計	93	47	140	33.6	5.8	4	34	21	55	38.2	7.0	2
14:00-14:15	27	20	47	42.6	2.0	0	3	2	5	40.0	0.6	3
14:15-14:30	20	18	38	47.4	1.6	1	7	4	11	36.4	1.4	0
14:30-14:45	18	13	31	41.9	1.3	0	7	1	8	12.5	1.0	0
14:45-15:00	18	12	30	40.0	1.2	0	14	3	17	17.6	2.2	0
1時間計	83	63	146	43.2	6.1	1	31	10	41	24.4	5.2	3

方向別自動車交通量調査表

調査地点：地域社会4 瀬谷土橋公園前

調査年月日：令和2年9月29日(火) 天候：曇りのち晴れ



方向 種別 時間帯	3						4					
	小型車 (台)	大型車 (台)	合計 (台)	大型車 混入率 (%)	時間 係数 (%)	二輪車 (台)	小型車 (台)	大型車 (台)	合計 (台)	大型車 混入率 (%)	時間 係数 (%)	二輪車 (台)
15:00-15:15	30	10	40	25.0	1.7	0	13	3	16	18.8	2.0	0
15:15-15:30	32	6	38	15.8	1.6	1	8	5	13	38.5	1.6	0
15:30-15:45	23	6	29	20.7	1.2	1	5	2	7	28.6	0.9	0
15:45-16:00	23	10	33	30.3	1.4	0	9	2	11	18.2	1.4	0
1時間計	108	32	140	22.9	5.8	2	35	12	47	25.5	5.9	0
16:00-16:15	22	8	30	26.7	1.2	0	6	3	9	33.3	1.1	0
16:15-16:30	22	4	26	15.4	1.1	0	11	5	16	31.3	2.0	0
16:30-16:45	20	5	25	20.0	1.0	1	12	5	17	29.4	2.2	0
16:45-17:00	32	4	36	11.1	1.5	1	11	6	17	35.3	2.2	0
1時間計	96	21	117	17.9	4.9	2	40	19	59	32.2	7.5	0
17:00-17:15	17	6	23	26.1	1.0	2	14	2	16	12.5	2.0	0
17:15-17:30	35	7	42	16.7	1.7	0	6	2	8	25.0	1.0	0
17:30-17:45	22	5	27	18.5	1.1	1	7	3	10	30.0	1.3	1
17:45-18:00	18	8	26	30.8	1.1	0	8	5	13	38.5	1.6	0
1時間計	92	26	118	22.0	4.9	3	35	12	47	25.5	5.9	1
18:00-18:15	20	4	24	16.7	1.0	1	10	4	14	28.6	1.8	2
18:15-18:30	22	6	28	21.4	1.2	1	8	5	13	38.5	1.6	0
18:30-18:45	21	6	27	22.2	1.1	1	4	4	8	50.0	1.0	1
18:45-19:00	14	4	18	22.2	0.7	2	7	2	9	22.2	1.1	0
1時間計	77	20	97	20.6	4.0	5	29	15	44	34.1	5.6	3
昼12時間計	1203	523	1726	30.3	71.8	34	439	187	626	29.9	79.2	20
19:00-19:15	19	3	22	13.6	0.9	0	10	3	13	23.1	1.6	2
19:15-19:30	24	8	32	25.0	1.3	1	9	2	11	18.2	1.4	0
19:30-19:45	9	10	19	52.6	0.8	0	3	1	4	25.0	0.5	0
19:45-20:00	17	6	23	26.1	1.0	1	6	5	11	45.5	1.4	0
1時間計	69	27	96	28.1	4.0	2	28	11	39	28.2	4.9	2
20:00-20:15	12	3	15	20.0	0.6	1	8	2	10	20.0	1.3	0
20:15-20:30	9	4	13	30.8	0.5	0	3	1	4	25.0	0.5	0
20:30-20:45	15	3	18	16.7	0.7	0	2	3	5	60.0	0.6	1
20:45-21:00	14	5	19	26.3	0.8	0	1	1	2	50.0	0.3	0
1時間計	50	15	65	23.1	2.7	1	14	7	21	33.3	2.7	1
21:00-21:15	12	1	13	7.7	0.5	2	1	2	3	66.7	0.4	0
21:15-21:30	16	3	19	15.8	0.8	1	1	3	4	75.0	0.5	1
21:30-21:45	17	5	22	22.7	0.9	0	4	2	6	33.3	0.8	0
21:45-22:00	7	2	9	22.2	0.4	0	2	0	2	0.0	0.3	0
1時間計	52	11	63	17.5	2.6	3	8	7	15	46.7	1.9	1
22:00-22:15	5	7	12	58.3	0.5	0	1	0	1	0.0	0.1	1
22:15-22:30	6	4	10	40.0	0.4	1	3	1	4	25.0	0.5	1
22:30-22:45	4	4	8	50.0	0.3	0	2	0	2	0.0	0.3	0
22:45-23:00	4	0	4	0.0	0.2	0	1	1	2	50.0	0.3	0
1時間計	19	15	34	44.1	1.4	1	7	2	9	22.2	1.1	2

方向別自動車交通量調査表

調査地点：地域社会4 瀬谷土橋公園前

調査年月日：令和2年9月29日(火) 天候：曇りのち晴れ



方向 時間帯	3						4					
	種別 小型車 (台)	大型車 (台)	合計 (台)	大型車 混入率 (%)	時間 係数 (%)	二輪車 (台)	小型車 (台)	大型車 (台)	合計 (台)	大型車 混入率 (%)	時間 係数 (%)	二輪車 (台)
23:00-23:15	7	1	8	12.5	0.3	1	0	0	0	0.0	0.0	1
23:15-23:30	8	0	8	0.0	0.3	0	0	3	3	100.0	0.4	0
23:30-23:45	4	6	10	60.0	0.4	0	1	3	4	75.0	0.5	0
23:45-24:00	2	5	7	71.4	0.3	0	0	0	0	0.0	0.0	0
1時間計	21	12	33	36.4	1.4	1	1	6	7	85.7	0.9	1
0:00-0:15	2	5	7	71.4	0.3	0	0	1	1	100.0	0.1	0
0:15-0:30	3	2	5	40.0	0.2	0	2	2	4	50.0	0.5	0
0:30-0:45	5	4	9	44.4	0.4	0	0	3	3	100.0	0.4	0
0:45-1:00	1	2	3	66.7	0.1	0	0	1	1	100.0	0.1	0
1時間計	11	13	24	54.2	1.0	0	2	7	9	77.8	1.1	0
1:00-1:15	2	3	5	60.0	0.2	0	0	1	1	100.0	0.1	0
1:15-1:30	5	3	8	37.5	0.3	0	0	0	0	0.0	0.0	1
1:30-1:45	4	3	7	42.9	0.3	0	0	2	2	100.0	0.3	0
1:45-2:00	1	3	4	75.0	0.2	1	0	1	1	100.0	0.1	0
1時間計	12	12	24	50.0	1.0	1	0	4	4	100.0	0.5	1
2:00-2:15	4	2	6	33.3	0.2	0	0	3	3	100.0	0.4	0
2:15-2:30	4	3	7	42.9	0.3	1	4	3	7	42.9	0.9	0
2:30-2:45	1	3	4	75.0	0.2	0	0	1	1	100.0	0.1	0
2:45-3:00	3	4	7	57.1	0.3	0	0	2	2	100.0	0.3	0
1時間計	12	12	24	50.0	1.0	1	4	9	13	69.2	1.6	0
3:00-3:15	1	6	7	85.7	0.3	0	1	0	1	0.0	0.1	0
3:15-3:30	1	2	3	66.7	0.1	0	1	1	2	50.0	0.3	0
3:30-3:45	1	5	6	83.3	0.2	0	0	0	0	0.0	0.0	0
3:45-4:00	3	6	9	66.7	0.4	0	1	0	1	0.0	0.1	0
1時間計	6	19	25	76.0	1.0	0	3	1	4	25.0	0.5	0
4:00-4:15	1	4	5	80.0	0.2	1	0	0	0	0.0	0.0	0
4:15-4:30	4	4	8	50.0	0.3	0	1	0	1	0.0	0.1	0
4:30-4:45	1	0	1	0.0	0.0	0	1	2	3	66.7	0.4	0
4:45-5:00	8	5	13	38.5	0.5	1	2	0	2	0.0	0.3	0
1時間計	14	13	27	48.1	1.1	2	4	2	6	33.3	0.8	0
5:00-5:15	4	6	10	60.0	0.4	0	1	0	1	0.0	0.1	0
5:15-5:30	11	5	16	31.3	0.7	0	3	3	6	50.0	0.8	1
5:30-5:45	18	2	20	10.0	0.8	0	0	0	0	0.0	0.0	0
5:45-6:00	35	10	45	22.2	1.9	0	4	1	5	20.0	0.6	0
1時間計	68	23	91	25.3	3.8	0	8	4	12	33.3	1.5	1
6:00-6:15	34	9	43	20.9	1.8	2	4	4	8	50.0	1.0	0
6:15-6:30	28	9	37	24.3	1.5	1	6	2	8	25.0	1.0	0
6:30-6:45	25	9	34	26.5	1.4	1	2	2	4	50.0	0.5	0
6:45-7:00	43	16	59	27.1	2.5	0	4	1	5	20.0	0.6	0
1時間計	130	43	173	24.9	7.2	4	16	9	25	36.0	3.2	0
夜12時間計	464	215	679	31.7	28.2	16	95	69	164	42.1	20.8	9
全時間合計	1667	738	2405	30.7	100.0	50	534	256	790	32.4	100.0	29
昼夜率	1.39	1.41	1.39	-	-	1.47	1.22	1.37	1.26	-	-	1.45

方向別自動車交通量調査表

調査地点：地域社会4 瀬谷土橋公園前

調査年月日：令和2年9月29日(火) 天候：曇りのち晴れ



方向							B 合計 (3+4)					
	種別	小型車 (台)	大型車 (台)	合計 (台)	大型車 混入率 (%)	時間 係数 (%)	二輪車 (台)	小型車 (台)	大型車 (台)	合計 (台)	大型車 混入率 (%)	時間 係数 (%)
7:00-7:15							46	20	66	30.3	2.1	1
7:15-7:30							52	17	69	24.6	2.2	3
7:30-7:45							41	17	58	29.3	1.8	3
7:45-8:00							35	18	53	34.0	1.7	3
1時間計							174	72	246	29.3	7.7	10
8:00-8:15							32	14	46	30.4	1.4	2
8:15-8:30							45	15	60	25.0	1.9	3
8:30-8:45							33	8	41	19.5	1.3	2
8:45-9:00							48	14	62	22.6	1.9	0
1時間計							158	51	209	24.4	6.5	7
9:00-9:15							37	20	57	35.1	1.8	3
9:15-9:30							38	18	56	32.1	1.8	0
9:30-9:45							27	22	49	44.9	1.5	0
9:45-10:00							40	14	54	25.9	1.7	0
1時間計							142	74	216	34.3	6.8	3
10:00-10:15							37	17	54	31.5	1.7	0
10:15-10:30							39	10	49	20.4	1.5	0
10:30-10:45							36	25	61	41.0	1.9	0
10:45-11:00							35	20	55	36.4	1.7	0
1時間計							147	72	219	32.9	6.9	0
11:00-11:15							34	21	55	38.2	1.7	1
11:15-11:30							30	13	43	30.2	1.3	1
11:30-11:45							36	17	53	32.1	1.7	1
11:45-12:00							35	14	49	28.6	1.5	1
1時間計							135	65	200	32.5	6.3	4
12:00-12:15							33	19	52	36.5	1.6	1
12:15-12:30							33	18	51	35.3	1.6	0
12:30-12:45							36	21	57	36.8	1.8	3
12:45-13:00							31	20	51	39.2	1.6	0
1時間計							133	78	211	37.0	6.6	4
13:00-13:15							42	16	58	27.6	1.8	2
13:15-13:30							28	17	45	37.8	1.4	0
13:30-13:45							28	17	45	37.8	1.4	2
13:45-14:00							29	18	47	38.3	1.5	2
1時間計							127	68	195	34.9	6.1	6
14:00-14:15							30	22	52	42.3	1.6	3
14:15-14:30							27	22	49	44.9	1.5	1
14:30-14:45							25	14	39	35.9	1.2	0
14:45-15:00							32	15	47	31.9	1.5	0
1時間計							114	73	187	39.0	5.9	4

方向別自動車交通量調査表

調査地点：地域社会4 瀬谷土橋公園前

調査年月日：令和2年9月29日(火) 天候：曇りのち晴れ



方向 時間帯							B 合計 (3+4)					
	種別 小型車 (台)	大型車 (台)	合計 (台)	大型車 混入率 (%)	時間 係数 (%)	二輪車 (台)	小型車 (台)	大型車 (台)	合計 (台)	大型車 混入率 (%)	時間 係数 (%)	二輪車 (台)
15:00-15:15							43	13	56	23.2	1.8	0
15:15-15:30							40	11	51	21.6	1.6	1
15:30-15:45							28	8	36	22.2	1.1	1
15:45-16:00							32	12	44	27.3	1.4	0
1時間計							143	44	187	23.5	5.9	2
16:00-16:15							28	11	39	28.2	1.2	0
16:15-16:30							33	9	42	21.4	1.3	0
16:30-16:45							32	10	42	23.8	1.3	1
16:45-17:00							43	10	53	18.9	1.7	1
1時間計							136	40	176	22.7	5.5	2
17:00-17:15							31	8	39	20.5	1.2	2
17:15-17:30							41	9	50	18.0	1.6	0
17:30-17:45							29	8	37	21.6	1.2	2
17:45-18:00							26	13	39	33.3	1.2	0
1時間計							127	38	165	23.0	5.2	4
18:00-18:15							30	8	38	21.1	1.2	3
18:15-18:30							30	11	41	26.8	1.3	1
18:30-18:45							25	10	35	28.6	1.1	2
18:45-19:00							21	6	27	22.2	0.8	2
1時間計							106	35	141	24.8	4.4	8
昼12時間計							1642	710	2352	30.2	73.6	54
19:00-19:15							29	6	35	17.1	1.1	2
19:15-19:30							33	10	43	23.3	1.3	1
19:30-19:45							12	11	23	47.8	0.7	0
19:45-20:00							23	11	34	32.4	1.1	1
1時間計							97	38	135	28.1	4.2	4
20:00-20:15							20	5	25	20.0	0.8	1
20:15-20:30							12	5	17	29.4	0.5	0
20:30-20:45							17	6	23	26.1	0.7	1
20:45-21:00							15	6	21	28.6	0.7	0
1時間計							64	22	86	25.6	2.7	2
21:00-21:15							13	3	16	18.8	0.5	2
21:15-21:30							17	6	23	26.1	0.7	2
21:30-21:45							21	7	28	25.0	0.9	0
21:45-22:00							9	2	11	18.2	0.3	0
1時間計							60	18	78	23.1	2.4	4
22:00-22:15							6	7	13	53.8	0.4	1
22:15-22:30							9	5	14	35.7	0.4	2
22:30-22:45							6	4	10	40.0	0.3	0
22:45-23:00							5	1	6	16.7	0.2	0
1時間計							26	17	43	39.5	1.3	3

方向別自動車交通量調査表

調査地点：地域社会4 瀬谷土橋公園前

調査年月日：令和2年9月29日(火) 天候：曇りのち晴れ



方向 時間帯	種別							B 合計 (3+4)					
		小型車 (台)	大型車 (台)	合計 (台)	大型車 混入率 (%)	時間 係数 (%)	二輪車 (台)	小型車 (台)	大型車 (台)	合計 (台)	大型車 混入率 (%)	時間 係数 (%)	二輪車 (台)
23:00-23:15							7	1	8	12.5	0.3	2	
23:15-23:30							8	3	11	27.3	0.3	0	
23:30-23:45							5	9	14	64.3	0.4	0	
23:45-24:00							2	5	7	71.4	0.2	0	
1時間計							22	18	40	45.0	1.3	2	
0:00-0:15							2	6	8	75.0	0.3	0	
0:15-0:30							5	4	9	44.4	0.3	0	
0:30-0:45							5	7	12	58.3	0.4	0	
0:45-1:00							1	3	4	75.0	0.1	0	
1時間計							13	20	33	60.6	1.0	0	
1:00-1:15							2	4	6	66.7	0.2	0	
1:15-1:30							5	3	8	37.5	0.3	1	
1:30-1:45							4	5	9	55.6	0.3	0	
1:45-2:00							1	4	5	80.0	0.2	1	
1時間計							12	16	28	57.1	0.9	2	
2:00-2:15							4	5	9	55.6	0.3	0	
2:15-2:30							8	6	14	42.9	0.4	1	
2:30-2:45							1	4	5	80.0	0.2	0	
2:45-3:00							3	6	9	66.7	0.3	0	
1時間計							16	21	37	56.8	1.2	1	
3:00-3:15							2	6	8	75.0	0.3	0	
3:15-3:30							2	3	5	60.0	0.2	0	
3:30-3:45							1	5	6	83.3	0.2	0	
3:45-4:00							4	6	10	60.0	0.3	0	
1時間計							9	20	29	69.0	0.9	0	
4:00-4:15							1	4	5	80.0	0.2	1	
4:15-4:30							5	4	9	44.4	0.3	0	
4:30-4:45							2	2	4	50.0	0.1	0	
4:45-5:00							10	5	15	33.3	0.5	1	
1時間計							18	15	33	45.5	1.0	2	
5:00-5:15							5	6	11	54.5	0.3	0	
5:15-5:30							14	8	22	36.4	0.7	1	
5:30-5:45							18	2	20	10.0	0.6	0	
5:45-6:00							39	11	50	22.0	1.6	0	
1時間計							76	27	103	26.2	3.2	1	
6:00-6:15							38	13	51	25.5	1.6	2	
6:15-6:30							34	11	45	24.4	1.4	1	
6:30-6:45							27	11	38	28.9	1.2	1	
6:45-7:00							47	17	64	26.6	2.0	0	
1時間計							146	52	198	26.3	6.2	4	
夜12時間計							559	284	843	33.7	26.4	25	
全時間合計							2201	994	3195	31.1	100.0	79	
昼夜率							1.34	1.40	1.36	-	-	1.46	

方向別自動車交通量調査表

調査地点：地域社会4 瀬谷土橋公園前

調査年月日：令和2年9月29日(火) 天候：曇りのち晴れ



方向 時間帯	5						6					
	種別 小型車 (台)	大型車 (台)	合計 (台)	大型車 混入率 (%)	時係 数 (%)	二輪車 (台)	小型車 (台)	大型車 (台)	合計 (台)	大型車 混入率 (%)	時係 数 (%)	二輪車 (台)
7:00-7:15	2	4	6	66.7	1.0	0	23	7	30	23.3	2.0	2
7:15-7:30	7	7	14	50.0	2.3	0	13	10	23	43.5	1.6	1
7:30-7:45	3	5	8	62.5	1.3	0	11	8	19	42.1	1.3	1
7:45-8:00	3	3	6	50.0	1.0	0	12	8	20	40.0	1.4	1
1時間計	15	19	34	55.9	5.7	0	59	33	92	35.9	6.3	5
8:00-8:15	5	7	12	58.3	2.0	0	13	12	25	48.0	1.7	1
8:15-8:30	7	3	10	30.0	1.7	0	12	6	18	33.3	1.2	0
8:30-8:45	1	5	6	83.3	1.0	1	15	13	28	46.4	1.9	3
8:45-9:00	3	2	5	40.0	0.8	0	16	12	28	42.9	1.9	0
1時間計	16	17	33	51.5	5.5	1	56	43	99	43.4	6.7	4
9:00-9:15	2	3	5	60.0	0.8	1	17	11	28	39.3	1.9	0
9:15-9:30	8	7	15	46.7	2.5	0	15	5	20	25.0	1.4	2
9:30-9:45	5	4	9	44.4	1.5	0	6	7	13	53.8	0.9	0
9:45-10:00	1	1	2	50.0	0.3	0	14	7	21	33.3	1.4	0
1時間計	16	15	31	48.4	5.2	1	52	30	82	36.6	5.6	2
10:00-10:15	4	4	8	50.0	1.3	0	19	9	28	32.1	1.9	1
10:15-10:30	2	1	3	33.3	0.5	0	8	3	11	27.3	0.7	0
10:30-10:45	2	1	3	33.3	0.5	0	14	7	21	33.3	1.4	2
10:45-11:00	8	1	9	11.1	1.5	0	16	8	24	33.3	1.6	0
1時間計	16	7	23	30.4	3.8	0	57	27	84	32.1	5.7	3
11:00-11:15	3	2	5	40.0	0.8	0	15	6	21	28.6	1.4	1
11:15-11:30	6	3	9	33.3	1.5	0	17	8	25	32.0	1.7	1
11:30-11:45	10	1	11	9.1	1.8	0	10	9	19	47.4	1.3	0
11:45-12:00	3	2	5	40.0	0.8	0	17	11	28	39.3	1.9	2
1時間計	22	8	30	26.7	5.0	0	59	34	93	36.6	6.3	4
12:00-12:15	10	4	14	28.6	2.3	0	14	19	33	57.6	2.2	0
12:15-12:30	6	6	12	50.0	2.0	0	8	12	20	60.0	1.4	0
12:30-12:45	12	2	14	14.3	2.3	0	16	14	30	46.7	2.0	0
12:45-13:00	6	5	11	45.5	1.8	0	8	17	25	68.0	1.7	1
1時間計	34	17	51	33.3	8.5	0	46	62	108	57.4	7.4	1
13:00-13:15	3	8	11	72.7	1.8	0	18	10	28	35.7	1.9	0
13:15-13:30	9	4	13	30.8	2.2	0	21	13	34	38.2	2.3	0
13:30-13:45	2	3	5	60.0	0.8	0	6	9	15	60.0	1.0	0
13:45-14:00	5	2	7	28.6	1.2	0	14	5	19	26.3	1.3	0
1時間計	19	17	36	47.2	6.0	0	59	37	96	38.5	6.5	0
14:00-14:15	7	1	8	12.5	1.3	0	16	14	30	46.7	2.0	0
14:15-14:30	9	4	13	30.8	2.2	0	16	8	24	33.3	1.6	0
14:30-14:45	5	2	7	28.6	1.2	0	7	5	12	41.7	0.8	0
14:45-15:00	0	3	3	100.0	0.5	0	15	12	27	44.4	1.8	2
1時間計	21	10	31	32.3	5.2	0	54	39	93	41.9	6.3	2

方向別自動車交通量調査表

調査地点：地域社会4 瀬谷土橋公園前

調査年月日：令和2年9月29日(火) 天候：曇りのち晴れ



方向 種別 時間帯	5						6					
	小型車 (台)	大型車 (台)	合計 (台)	大型車 混入率 (%)	時間 係数 (%)	二輪車 (台)	小型車 (台)	大型車 (台)	合計 (台)	大型車 混入率 (%)	時間 係数 (%)	二輪車 (台)
15:00-15:15	7	3	10	30.0	1.7	0	10	12	22	54.5	1.5	0
15:15-15:30	3	2	5	40.0	0.8	0	13	4	17	23.5	1.2	0
15:30-15:45	8	0	8	0.0	1.3	0	14	10	24	41.7	1.6	0
15:45-16:00	11	2	13	15.4	2.2	1	5	8	13	61.5	0.9	1
1時間計	29	7	36	19.4	6.0	1	42	34	76	44.7	5.2	1
16:00-16:15	3	0	3	0.0	0.5	0	11	5	16	31.3	1.1	0
16:15-16:30	4	3	7	42.9	1.2	0	13	6	19	31.6	1.3	0
16:30-16:45	8	2	10	20.0	1.7	0	10	3	13	23.1	0.9	2
16:45-17:00	6	2	8	25.0	1.3	0	4	1	5	20.0	0.3	1
1時間計	21	7	28	25.0	4.7	0	38	15	53	28.3	3.6	3
17:00-17:15	12	1	13	7.7	2.2	1	12	3	15	20.0	1.0	0
17:15-17:30	8	3	11	27.3	1.8	0	11	4	15	26.7	1.0	0
17:30-17:45	8	2	10	20.0	1.7	1	16	2	18	11.1	1.2	1
17:45-18:00	16	1	17	5.9	2.8	0	16	5	21	23.8	1.4	2
1時間計	44	7	51	13.7	8.5	2	55	14	69	20.3	4.7	3
18:00-18:15	10	0	10	0.0	1.7	0	19	4	23	17.4	1.6	1
18:15-18:30	17	2	19	10.5	3.2	1	16	1	17	5.9	1.2	0
18:30-18:45	14	3	17	17.6	2.8	2	16	1	17	5.9	1.2	0
18:45-19:00	11	0	11	0.0	1.8	2	10	3	13	23.1	0.9	1
1時間計	52	5	57	8.8	9.5	5	61	9	70	12.9	4.8	2
昼12時間計	305	136	441	30.8	73.6	10	638	377	1015	37.1	69.2	30
19:00-19:15	16	1	17	5.9	2.8	0	18	8	26	30.8	1.8	0
19:15-19:30	22	4	26	15.4	4.3	1	16	2	18	11.1	1.2	0
19:30-19:45	6	2	8	25.0	1.3	1	12	2	14	14.3	1.0	0
19:45-20:00	10	1	11	9.1	1.8	0	11	4	15	26.7	1.0	0
1時間計	54	8	62	12.9	10.4	2	57	16	73	21.9	5.0	0
20:00-20:15	8	2	10	20.0	1.7	1	9	4	13	30.8	0.9	0
20:15-20:30	3	2	5	40.0	0.8	0	8	1	9	11.1	0.6	0
20:30-20:45	6	0	6	0.0	1.0	0	3	3	6	50.0	0.4	1
20:45-21:00	4	1	5	20.0	0.8	1	4	1	5	20.0	0.3	2
1時間計	21	5	26	19.2	4.3	2	24	9	33	27.3	2.2	3
21:00-21:15	5	2	7	28.6	1.2	0	4	6	10	60.0	0.7	0
21:15-21:30	4	0	4	0.0	0.7	0	6	8	14	57.1	1.0	0
21:30-21:45	0	1	1	100.0	0.2	0	5	6	11	54.5	0.7	0
21:45-22:00	0	1	1	100.0	0.2	0	2	5	7	71.4	0.5	0
1時間計	9	4	13	30.8	2.2	0	17	25	42	59.5	2.9	0
22:00-22:15	1	1	2	50.0	0.3	0	4	2	6	33.3	0.4	0
22:15-22:30	0	0	0	0.0	0.0	1	1	6	7	85.7	0.5	0
22:30-22:45	4	0	4	0.0	0.7	0	3	6	9	66.7	0.6	1
22:45-23:00	0	0	0	0.0	0.0	0	1	3	4	75.0	0.3	1
1時間計	5	1	6	16.7	1.0	1	9	17	26	65.4	1.8	2

方向別自動車交通量調査表

調査地点：地域社会4 瀬谷土橋公園前

調査年月日：令和2年9月29日(火) 天候：曇りのち晴れ



方向 時間帯	5						6					
	種別 小型車 (台)	大型車 (台)	合計 (台)	大型車 混入率 (%)	時間 係数 (%)	二輪車 (台)	小型車 (台)	大型車 (台)	合計 (台)	大型車 混入率 (%)	時間 係数 (%)	二輪車 (台)
23:00-23:15	3	0	3	0.0	0.5	0	1	2	3	66.7	0.2	0
23:15-23:30	1	1	2	50.0	0.3	0	1	1	2	50.0	0.1	0
23:30-23:45	2	1	3	33.3	0.5	0	0	0	0	0.0	0.0	2
23:45-24:00	0	0	0	0.0	0.0	0	2	1	3	33.3	0.2	0
1時間計	6	2	8	25.0	1.3	0	4	4	8	50.0	0.5	2
0:00-0:15	0	0	0	0.0	0.0	0	1	5	6	83.3	0.4	0
0:15-0:30	0	0	0	0.0	0.0	0	0	3	3	100.0	0.2	0
0:30-0:45	0	0	0	0.0	0.0	0	3	2	5	40.0	0.3	0
0:45-1:00	0	0	0	0.0	0.0	0	4	3	7	42.9	0.5	0
1時間計	0	0	0	0.0	0.0	0	8	13	21	61.9	1.4	0
1:00-1:15	0	2	2	100.0	0.3	0	8	5	13	38.5	0.9	0
1:15-1:30	0	1	1	100.0	0.2	0	6	5	11	45.5	0.7	0
1:30-1:45	0	0	0	0.0	0.0	0	3	3	6	50.0	0.4	0
1:45-2:00	1	0	1	0.0	0.2	0	2	3	5	60.0	0.3	0
1時間計	1	3	4	75.0	0.7	0	19	16	35	45.7	2.4	0
2:00-2:15	0	0	0	0.0	0.0	0	0	3	3	100.0	0.2	0
2:15-2:30	0	0	0	0.0	0.0	1	2	3	5	60.0	0.3	0
2:30-2:45	0	1	1	100.0	0.2	0	0	0	0	0.0	0.0	1
2:45-3:00	1	0	1	0.0	0.2	1	0	3	3	100.0	0.2	0
1時間計	1	1	2	50.0	0.3	2	2	9	11	81.8	0.7	1
3:00-3:15	0	1	1	100.0	0.2	0	1	7	8	87.5	0.5	0
3:15-3:30	0	0	0	0.0	0.0	0	2	4	6	66.7	0.4	0
3:30-3:45	0	0	0	0.0	0.0	0	4	5	9	55.6	0.6	0
3:45-4:00	0	0	0	0.0	0.0	0	2	2	4	50.0	0.3	0
1時間計	0	1	1	100.0	0.2	0	9	18	27	66.7	1.8	0
4:00-4:15	0	0	0	0.0	0.0	0	2	3	5	60.0	0.3	0
4:15-4:30	0	0	0	0.0	0.0	0	1	2	3	66.7	0.2	1
4:30-4:45	1	0	1	0.0	0.2	0	4	1	5	20.0	0.3	0
4:45-5:00	1	1	2	50.0	0.3	0	1	3	4	75.0	0.3	0
1時間計	2	1	3	33.3	0.5	0	8	9	17	52.9	1.2	1
5:00-5:15	0	3	3	100.0	0.5	0	2	5	7	71.4	0.5	0
5:15-5:30	2	3	5	60.0	0.8	0	4	7	11	63.6	0.7	0
5:30-5:45	3	1	4	25.0	0.7	0	5	4	9	44.4	0.6	2
5:45-6:00	2	1	3	33.3	0.5	0	13	9	22	40.9	1.5	0
1時間計	7	8	15	53.3	2.5	0	24	25	49	51.0	3.3	2
6:00-6:15	3	3	6	50.0	1.0	0	15	7	22	31.8	1.5	0
6:15-6:30	0	1	1	100.0	0.2	0	17	14	31	45.2	2.1	0
6:30-6:45	1	4	5	80.0	0.8	0	12	19	31	61.3	2.1	1
6:45-7:00	2	4	6	66.7	1.0	0	18	8	26	30.8	1.8	2
1時間計	6	12	18	66.7	3.0	0	62	48	110	43.6	7.5	3
夜12時間計	112	46	158	29.1	26.4	7	243	209	452	46.2	30.8	14
全時間合計	417	182	599	30.4	100.0	17	881	586	1467	39.9	100.0	44
昼夜率	1.37	1.34	1.36	-	-	1.70	1.38	1.55	1.45	-	-	1.47

方向別自動車交通量調査表

調査地点：地域社会4 瀬谷土橋公園前

調査年月日：令和2年9月29日(火) 天候：曇りのち晴れ



方向 時間帯	種別						C 合計 (5+6)					
		小型車 (台)	大型車 (台)	合計 (台)	大型車 混入率 (%)	時間 係数 (%)	二輪車 (台)	小型車 (台)	大型車 (台)	合計 (台)	大型車 混入率 (%)	時間 係数 (%)
7:00-7:15							25	11	36	30.6	1.7	2
7:15-7:30							20	17	37	45.9	1.8	1
7:30-7:45							14	13	27	48.1	1.3	1
7:45-8:00							15	11	26	42.3	1.3	1
1時間計							74	52	126	41.3	6.1	5
8:00-8:15							18	19	37	51.4	1.8	1
8:15-8:30							19	9	28	32.1	1.4	0
8:30-8:45							16	18	34	52.9	1.6	4
8:45-9:00							19	14	33	42.4	1.6	0
1時間計							72	60	132	45.5	6.4	5
9:00-9:15							19	14	33	42.4	1.6	1
9:15-9:30							23	12	35	34.3	1.7	2
9:30-9:45							11	11	22	50.0	1.1	0
9:45-10:00							15	8	23	34.8	1.1	0
1時間計							68	45	113	39.8	5.5	3
10:00-10:15							23	13	36	36.1	1.7	1
10:15-10:30							10	4	14	28.6	0.7	0
10:30-10:45							16	8	24	33.3	1.2	2
10:45-11:00							24	9	33	27.3	1.6	0
1時間計							73	34	107	31.8	5.2	3
11:00-11:15							18	8	26	30.8	1.3	1
11:15-11:30							23	11	34	32.4	1.6	1
11:30-11:45							20	10	30	33.3	1.5	0
11:45-12:00							20	13	33	39.4	1.6	2
1時間計							81	42	123	34.1	6.0	4
12:00-12:15							24	23	47	48.9	2.3	0
12:15-12:30							14	18	32	56.3	1.5	0
12:30-12:45							28	16	44	36.4	2.1	0
12:45-13:00							14	22	36	61.1	1.7	1
1時間計							80	79	159	49.7	7.7	1
13:00-13:15							21	18	39	46.2	1.9	0
13:15-13:30							30	17	47	36.2	2.3	0
13:30-13:45							8	12	20	60.0	1.0	0
13:45-14:00							19	7	26	26.9	1.3	0
1時間計							78	54	132	40.9	6.4	0
14:00-14:15							23	15	38	39.5	1.8	0
14:15-14:30							25	12	37	32.4	1.8	0
14:30-14:45							12	7	19	36.8	0.9	0
14:45-15:00							15	15	30	50.0	1.5	2
1時間計							75	49	124	39.5	6.0	2

方向別自動車交通量調査表

調査地点 : 地域社会4 瀬谷土橋公園前

調査年月日 : 令和 2年 9月29日(火) 天候:曇りのち晴れ



方向 時間帯							C 合計 (5+6)					
	種別 小型車 (台)	大型車 (台)	合計 (台)	大型車 混入率 (%)	時間 係数 (%)	二輪車 (台)	小型車 (台)	大型車 (台)	合計 (台)	大型車 混入率 (%)	時間 係数 (%)	二輪車 (台)
15:00-15:15							17	15	32	46.9	1.5	0
15:15-15:30							16	6	22	27.3	1.1	0
15:30-15:45							22	10	32	31.3	1.5	0
15:45-16:00							16	10	26	38.5	1.3	2
1時間計							71	41	112	36.6	5.4	2
16:00-16:15							14	5	19	26.3	0.9	0
16:15-16:30							17	9	26	34.6	1.3	0
16:30-16:45							18	5	23	21.7	1.1	2
16:45-17:00							10	3	13	23.1	0.6	1
1時間計							59	22	81	27.2	3.9	3
17:00-17:15							24	4	28	14.3	1.4	1
17:15-17:30							19	7	26	26.9	1.3	0
17:30-17:45							24	4	28	14.3	1.4	2
17:45-18:00							32	6	38	15.8	1.8	2
1時間計							99	21	120	17.5	5.8	5
18:00-18:15							29	4	33	12.1	1.6	1
18:15-18:30							33	3	36	8.3	1.7	1
18:30-18:45							30	4	34	11.8	1.6	2
18:45-19:00							21	3	24	12.5	1.2	3
1時間計							113	14	127	11.0	6.1	7
昼12時間計							943	513	1456	35.2	70.5	40
19:00-19:15							34	9	43	20.9	2.1	0
19:15-19:30							38	6	44	13.6	2.1	1
19:30-19:45							18	4	22	18.2	1.1	1
19:45-20:00							21	5	26	19.2	1.3	0
1時間計							111	24	135	17.8	6.5	2
20:00-20:15							17	6	23	26.1	1.1	1
20:15-20:30							11	3	14	21.4	0.7	0
20:30-20:45							9	3	12	25.0	0.6	1
20:45-21:00							8	2	10	20.0	0.5	3
1時間計							45	14	59	23.7	2.9	5
21:00-21:15							9	8	17	47.1	0.8	0
21:15-21:30							10	8	18	44.4	0.9	0
21:30-21:45							5	7	12	58.3	0.6	0
21:45-22:00							2	6	8	75.0	0.4	0
1時間計							26	29	55	52.7	2.7	0
22:00-22:15							5	3	8	37.5	0.4	0
22:15-22:30							1	6	7	85.7	0.3	1
22:30-22:45							7	6	13	46.2	0.6	1
22:45-23:00							1	3	4	75.0	0.2	1
1時間計							14	18	32	56.3	1.5	3

方向別自動車交通量調査表

調査地点：地域社会4 瀬谷土橋公園前

調査年月日：令和2年9月29日(火) 天候：曇りのち晴れ



方向 時間帯	種別						C 合計 (5+6)					
		小型車 (台)	大型車 (台)	合計 (台)	大型車 混入率 (%)	時間 係数 (%)	二輪車 (台)	小型車 (台)	大型車 (台)	合計 (台)	大型車 混入率 (%)	時間 係数 (%)
23:00-23:15							4	2	6	33.3	0.3	0
23:15-23:30							2	2	4	50.0	0.2	0
23:30-23:45							2	1	3	33.3	0.1	2
23:45-24:00							2	1	3	33.3	0.1	0
1時間計							10	6	16	37.5	0.8	2
0:00-0:15							1	5	6	83.3	0.3	0
0:15-0:30							0	3	3	100.0	0.1	0
0:30-0:45							3	2	5	40.0	0.2	0
0:45-1:00							4	3	7	42.9	0.3	0
1時間計							8	13	21	61.9	1.0	0
1:00-1:15							8	7	15	46.7	0.7	0
1:15-1:30							6	6	12	50.0	0.6	0
1:30-1:45							3	3	6	50.0	0.3	0
1:45-2:00							3	3	6	50.0	0.3	0
1時間計							20	19	39	48.7	1.9	0
2:00-2:15							0	3	3	100.0	0.1	0
2:15-2:30							2	3	5	60.0	0.2	1
2:30-2:45							0	1	1	100.0	0.0	1
2:45-3:00							1	3	4	75.0	0.2	1
1時間計							3	10	13	76.9	0.6	3
3:00-3:15							1	8	9	88.9	0.4	0
3:15-3:30							2	4	6	66.7	0.3	0
3:30-3:45							4	5	9	55.6	0.4	0
3:45-4:00							2	2	4	50.0	0.2	0
1時間計							9	19	28	67.9	1.4	0
4:00-4:15							2	3	5	60.0	0.2	0
4:15-4:30							1	2	3	66.7	0.1	1
4:30-4:45							5	1	6	16.7	0.3	0
4:45-5:00							2	4	6	66.7	0.3	0
1時間計							10	10	20	50.0	1.0	1
5:00-5:15							2	8	10	80.0	0.5	0
5:15-5:30							6	10	16	62.5	0.8	0
5:30-5:45							8	5	13	38.5	0.6	2
5:45-6:00							15	10	25	40.0	1.2	0
1時間計							31	33	64	51.6	3.1	2
6:00-6:15							18	10	28	35.7	1.4	0
6:15-6:30							17	15	32	46.9	1.5	0
6:30-6:45							13	23	36	63.9	1.7	1
6:45-7:00							20	12	32	37.5	1.5	2
1時間計							68	60	128	46.9	6.2	3
夜12時間計							355	255	610	41.8	29.5	21
全時間合計							1298	768	2066	37.2	100.0	61
昼夜率							1.38	1.50	1.42	-	-	1.53

方向別自動車交通量調査表

調査地点 : 地域社会5

調査年月日 : 令和元年 5月14日(火) 天候: 雨のち曇り



方向 時間帯	1						2					
	種別 小型車 (台)	大型車 (台)	合計 (台)	大型車 混入率 (%)	時 間 係 数 (%)	二輪車 (台)	種別 小型車 (台)	大型車 (台)	合計 (台)	大型車 混入率 (%)	時 間 係 数 (%)	二輪車 (台)
7:00-7:15	53	1	54	1.9	3.2	1	80	18	98	18.4	1.5	6
7:15-7:30	32	1	33	3.0	1.9	3	76	22	98	22.4	1.5	11
7:30-7:45	34	1	35	2.9	2.0	2	84	15	99	15.2	1.5	9
7:45-8:00	25	0	25	0.0	1.5	2	76	17	93	18.3	1.4	5
1時間計	144	3	147	2.0	8.6	8	316	72	388	18.6	5.9	31
8:00-8:15	31	3	34	8.8	2.0	1	69	15	84	17.9	1.3	3
8:15-8:30	27	5	32	15.6	1.9	2	71	13	84	15.5	1.3	3
8:30-8:45	31	4	35	11.4	2.0	3	63	20	83	24.1	1.3	2
8:45-9:00	31	4	35	11.4	2.0	0	77	17	94	18.1	1.4	4
1時間計	120	16	136	11.8	7.9	6	280	65	345	18.8	5.2	12
9:00-9:15	15	4	19	21.1	1.1	0	67	18	85	21.2	1.3	2
9:15-9:30	18	5	23	21.7	1.3	1	72	14	86	16.3	1.3	4
9:30-9:45	21	4	25	16.0	1.5	1	52	35	87	40.2	1.3	2
9:45-10:00	16	2	18	11.1	1.1	2	60	14	74	18.9	1.1	4
1時間計	70	15	85	17.6	5.0	4	251	81	332	24.4	5.1	12
10:00-10:15	15	2	17	11.8	1.0	0	83	21	104	20.2	1.6	1
10:15-10:30	19	1	20	5.0	1.2	0	79	14	93	15.1	1.4	0
10:30-10:45	27	2	29	6.9	1.7	1	76	27	103	26.2	1.6	0
10:45-11:00	22	1	23	4.3	1.3	1	68	11	79	13.9	1.2	2
1時間計	83	6	89	6.7	5.2	2	306	73	379	19.3	5.8	3
11:00-11:15	18	2	20	10.0	1.2	1	54	26	80	32.5	1.2	2
11:15-11:30	13	0	13	0.0	0.8	1	87	9	96	9.4	1.5	1
11:30-11:45	19	2	21	9.5	1.2	0	79	16	95	16.8	1.4	0
11:45-12:00	16	1	17	5.9	1.0	0	72	15	87	17.2	1.3	1
1時間計	66	5	71	7.0	4.1	2	292	66	358	18.4	5.4	4
12:00-12:15	16	0	16	0.0	0.9	1	67	17	84	20.2	1.3	0
12:15-12:30	26	0	26	0.0	1.5	0	87	19	106	17.9	1.6	1
12:30-12:45	10	0	10	0.0	0.6	0	78	14	92	15.2	1.4	0
12:45-13:00	7	0	7	0.0	0.4	1	45	9	54	16.7	0.8	0
1時間計	59	0	59	0.0	3.4	2	277	59	336	17.6	5.1	1
13:00-13:15	23	0	23	0.0	1.3	0	64	17	81	21.0	1.2	1
13:15-13:30	19	0	19	0.0	1.1	1	55	21	76	27.6	1.2	1
13:30-13:45	19	0	19	0.0	1.1	0	66	10	76	13.2	1.2	1
13:45-14:00	14	1	15	6.7	0.9	0	88	12	100	12.0	1.5	2
1時間計	75	1	76	1.3	4.4	1	273	60	333	18.0	5.1	5
14:00-14:15	25	3	28	10.7	1.6	1	86	15	101	14.9	1.5	6
14:15-14:30	24	3	27	11.1	1.6	0	62	14	76	18.4	1.2	4
14:30-14:45	17	0	17	0.0	1.0	2	104	20	124	16.1	1.9	2
14:45-15:00	14	1	15	6.7	0.9	0	70	9	79	11.4	1.2	3
1時間計	80	7	87	8.0	5.1	3	322	58	380	15.3	5.8	15

方向別自動車交通量調査表

調査地点：地域社会5

調査年月日：令和元年 5月14日(火) 天候：雨のち曇り



方向 時間帯	1						2					
	種別 小型車 (台)	大型車 (台)	合計 (台)	大型車 混入率 (%)	時 間 係 数 (%)	二輪車 (台)	小型車 (台)	大型車 (台)	合計 (台)	大型車 混入率 (%)	時 間 係 数 (%)	二輪車 (台)
15:00-15:15	19	1	20	5.0	1.2	0	73	14	87	16.1	1.3	7
15:15-15:30	24	3	27	11.1	1.6	1	92	18	110	16.4	1.7	3
15:30-15:45	20	1	21	4.8	1.2	0	67	8	75	10.7	1.1	3
15:45-16:00	24	0	24	0.0	1.4	1	94	14	108	13.0	1.6	2
1時間計	87	5	92	5.4	5.4	2	326	54	380	14.2	5.8	15
16:00-16:15	31	2	33	6.1	1.9	3	99	17	116	14.7	1.8	5
16:15-16:30	33	0	33	0.0	1.9	2	108	14	122	11.5	1.9	8
16:30-16:45	27	0	27	0.0	1.6	2	87	10	97	10.3	1.5	5
16:45-17:00	33	1	34	2.9	2.0	1	79	10	89	11.2	1.4	1
1時間計	124	3	127	2.4	7.4	8	373	51	424	12.0	6.5	19
17:00-17:15	26	0	26	0.0	1.5	0	91	8	99	8.1	1.5	3
17:15-17:30	41	1	42	2.4	2.5	3	130	6	136	4.4	2.1	4
17:30-17:45	49	2	51	3.9	3.0	6	93	9	102	8.8	1.6	4
17:45-18:00	57	1	58	1.7	3.4	5	96	7	103	6.8	1.6	12
1時間計	173	4	177	2.3	10.3	14	410	30	440	6.8	6.7	23
18:00-18:15	43	1	44	2.3	2.6	1	112	4	116	3.4	1.8	10
18:15-18:30	22	0	22	0.0	1.3	2	141	7	148	4.7	2.3	11
18:30-18:45	29	0	29	0.0	1.7	2	96	6	102	5.9	1.6	2
18:45-19:00	20	1	21	4.8	1.2	2	98	2	100	2.0	1.5	4
1時間計	114	2	116	1.7	6.8	7	447	19	466	4.1	7.1	27
昼12時間計	1195	67	1262	5.3	73.6	59	3873	688	4561	15.1	69.4	167
19:00-19:15	7	1	8	12.5	0.5	1	100	6	106	5.7	1.6	7
19:15-19:30	15	0	15	0.0	0.9	2	95	5	100	5.0	1.5	4
19:30-19:45	21	0	21	0.0	1.2	1	124	3	127	2.4	1.9	9
19:45-20:00	16	0	16	0.0	0.9	1	78	2	80	2.5	1.2	6
1時間計	59	1	60	1.7	3.5	5	397	16	413	3.9	6.3	26
20:00-20:15	33	0	33	0.0	1.9	6	92	4	96	4.2	1.5	7
20:15-20:30	30	2	32	6.3	1.9	0	85	1	86	1.2	1.3	6
20:30-20:45	26	0	26	0.0	1.5	1	85	5	90	5.6	1.4	4
20:45-21:00	19	0	19	0.0	1.1	0	68	1	69	1.4	1.0	7
1時間計	108	2	110	1.8	6.4	7	330	11	341	3.2	5.2	24
21:00-21:15	15	0	15	0.0	0.9	1	80	3	83	3.6	1.3	4
21:15-21:30	12	0	12	0.0	0.7	0	63	1	64	1.6	1.0	3
21:30-21:45	13	0	13	0.0	0.8	0	45	3	48	6.3	0.7	2
21:45-22:00	6	0	6	0.0	0.4	0	44	4	48	8.3	0.7	6
1時間計	46	0	46	0.0	2.7	1	232	11	243	4.5	3.7	15
22:00-22:15	15	0	15	0.0	0.9	2	62	9	71	12.7	1.1	4
22:15-22:30	11	0	11	0.0	0.6	0	38	4	42	9.5	0.6	1
22:30-22:45	10	0	10	0.0	0.6	0	57	2	59	3.4	0.9	7
22:45-23:00	10	0	10	0.0	0.6	0	32	2	34	5.9	0.5	0
1時間計	46	0	46	0.0	2.7	2	189	17	206	8.3	3.1	12

方向別自動車交通量調査表

調査地点：地域社会5

調査年月日：令和元年 5月14日(火) 天候：雨のち曇り



方向 時間帯	1						2					
	種別 小型車 (台)	大型車 (台)	合計 (台)	大型車 混入率 (%)	時間 係数 (%)	二輪車 (台)	小型車 (台)	大型車 (台)	合計 (台)	大型車 混入率 (%)	時間 係数 (%)	二輪車 (台)
23:00-23:15	13	0	13	0.0	0.8	0	32	6	38	15.8	0.6	2
23:15-23:30	5	0	5	0.0	0.3	1	26	3	29	10.3	0.4	1
23:30-23:45	3	0	3	0.0	0.2	0	21	2	23	8.7	0.3	1
23:45-24:00	3	0	3	0.0	0.2	0	20	4	24	16.7	0.4	1
1時間計	24	0	24	0.0	1.4	1	99	15	114	13.2	1.7	5
0:00-0:15	4	0	4	0.0	0.2	0	23	3	26	11.5	0.4	1
0:15-0:30	6	0	6	0.0	0.4	0	18	4	22	18.2	0.3	1
0:30-0:45	2	0	2	0.0	0.1	0	9	7	16	43.8	0.2	0
0:45-1:00	1	0	1	0.0	0.1	0	10	4	14	28.6	0.2	1
1時間計	13	0	13	0.0	0.8	0	60	18	78	23.1	1.2	3
1:00-1:15	4	0	4	0.0	0.2	0	11	4	15	26.7	0.2	1
1:15-1:30	0	1	1	100.0	0.1	0	13	3	16	18.8	0.2	0
1:30-1:45	0	2	2	100.0	0.1	0	9	4	13	30.8	0.2	1
1:45-2:00	0	1	1	100.0	0.1	0	15	2	17	11.8	0.3	0
1時間計	4	4	8	50.0	0.5	0	48	13	61	21.3	0.9	2
2:00-2:15	0	0	0	0.0	0.0	0	4	3	7	42.9	0.1	0
2:15-2:30	4	0	4	0.0	0.2	0	15	5	20	25.0	0.3	0
2:30-2:45	2	0	2	0.0	0.1	0	9	4	13	30.8	0.2	0
2:45-3:00	1	0	1	0.0	0.1	0	3	5	8	62.5	0.1	1
1時間計	7	0	7	0.0	0.4	0	31	17	48	35.4	0.7	1
3:00-3:15	1	0	1	0.0	0.1	1	7	3	10	30.0	0.2	1
3:15-3:30	1	0	1	0.0	0.1	0	6	4	10	40.0	0.2	1
3:30-3:45	2	0	2	0.0	0.1	0	5	2	7	28.6	0.1	0
3:45-4:00	2	0	2	0.0	0.1	0	6	1	7	14.3	0.1	1
1時間計	6	0	6	0.0	0.4	1	24	10	34	29.4	0.5	3
4:00-4:15	1	0	1	0.0	0.1	0	7	2	9	22.2	0.1	1
4:15-4:30	2	1	3	33.3	0.2	0	12	3	15	20.0	0.2	1
4:30-4:45	1	0	1	0.0	0.1	0	11	3	14	21.4	0.2	2
4:45-5:00	0	0	0	0.0	0.0	0	20	7	27	25.9	0.4	2
1時間計	4	1	5	20.0	0.3	0	50	15	65	23.1	1.0	6
5:00-5:15	0	0	0	0.0	0.0	0	10	10	20	50.0	0.3	3
5:15-5:30	4	0	4	0.0	0.2	0	21	5	26	19.2	0.4	1
5:30-5:45	5	0	5	0.0	0.3	1	22	9	31	29.0	0.5	1
5:45-6:00	7	0	7	0.0	0.4	0	43	16	59	27.1	0.9	2
1時間計	16	0	16	0.0	0.9	1	96	40	136	29.4	2.1	7
6:00-6:15	18	1	19	5.3	1.1	1	35	11	46	23.9	0.7	4
6:15-6:30	25	0	25	0.0	1.5	3	53	16	69	23.2	1.0	5
6:30-6:45	35	2	37	5.4	2.2	1	67	17	84	20.2	1.3	11
6:45-7:00	27	3	30	10.0	1.8	4	61	12	73	16.4	1.1	6
1時間計	105	6	111	5.4	6.5	9	216	56	272	20.6	4.1	26
夜12時間計	438	14	452	3.1	26.4	27	1772	239	2011	11.9	30.6	130
全時間合計	1633	81	1714	4.7	100.0	86	5645	927	6572	14.1	100.0	297
昼夜率	1.37	1.21	1.36	-	-	1.46	1.46	1.35	1.44	-	-	1.78

方向別自動車交通量調査表

調査地点：地域社会5

調査年月日：令和元年 5月14日(火) 天候：雨のち曇り



時間帯	方向 種別							A 合計 (1+2)					
		小型車 (台)	大型車 (台)	合計 (台)	大型車 混入率 (%)	時間 係数 (%)	二輪車 (台)	小型車 (台)	大型車 (台)	合計 (台)	大型車 混入率 (%)	時間 係数 (%)	二輪車 (台)
7:00-7:15							133	19	152	12.5	1.8	7	
7:15-7:30							108	23	131	17.6	1.6	14	
7:30-7:45							118	16	134	11.9	1.6	11	
7:45-8:00							101	17	118	14.4	1.4	7	
1時間計							460	75	535	14.0	6.5	39	
8:00-8:15							100	18	118	15.3	1.4	4	
8:15-8:30							98	18	116	15.5	1.4	5	
8:30-8:45							94	24	118	20.3	1.4	5	
8:45-9:00							108	21	129	16.3	1.6	4	
1時間計							400	81	481	16.8	5.8	18	
9:00-9:15							82	22	104	21.2	1.3	2	
9:15-9:30							90	19	109	17.4	1.3	5	
9:30-9:45							73	39	112	34.8	1.4	3	
9:45-10:00							76	16	92	17.4	1.1	6	
1時間計							321	96	417	23.0	5.0	16	
10:00-10:15							98	23	121	19.0	1.5	1	
10:15-10:30							98	15	113	13.3	1.4	0	
10:30-10:45							103	29	132	22.0	1.6	1	
10:45-11:00							90	12	102	11.8	1.2	3	
1時間計							389	79	468	16.9	5.6	5	
11:00-11:15							72	28	100	28.0	1.2	3	
11:15-11:30							100	9	109	8.3	1.3	2	
11:30-11:45							98	18	116	15.5	1.4	0	
11:45-12:00							88	16	104	15.4	1.3	1	
1時間計							358	71	429	16.6	5.2	6	
12:00-12:15							83	17	100	17.0	1.2	1	
12:15-12:30							113	19	132	14.4	1.6	1	
12:30-12:45							88	14	102	13.7	1.2	0	
12:45-13:00							52	9	61	14.8	0.7	1	
1時間計							336	59	395	14.9	4.8	3	
13:00-13:15							87	17	104	16.3	1.3	1	
13:15-13:30							74	21	95	22.1	1.1	2	
13:30-13:45							85	10	95	10.5	1.1	1	
13:45-14:00							102	13	115	11.3	1.4	2	
1時間計							348	61	409	14.9	4.9	6	
14:00-14:15							111	18	129	14.0	1.6	7	
14:15-14:30							86	17	103	16.5	1.2	4	
14:30-14:45							121	20	141	14.2	1.7	4	
14:45-15:00							84	10	94	10.6	1.1	3	
1時間計							402	65	467	13.9	5.6	18	

方向別自動車交通量調査表

調査地点 : 地域社会5

調査年月日 : 令和元年 5月14日(火) 天候:雨のち曇り



方向 時間帯							A 合計 (1+2)					
	種別 小型車 (台)	大型車 (台)	合計 (台)	大型車 混入率 (%)	時間 係数 (%)	二輪車 (台)	小型車 (台)	大型車 (台)	合計 (台)	大型車 混入率 (%)	時間 係数 (%)	二輪車 (台)
15:00-15:15							92	15	107	14.0	1.3	7
15:15-15:30							116	21	137	15.3	1.7	4
15:30-15:45							87	9	96	9.4	1.2	3
15:45-16:00							118	14	132	10.6	1.6	3
1時間計							413	59	472	12.5	5.7	17
16:00-16:15							130	19	149	12.8	1.8	8
16:15-16:30							141	14	155	9.0	1.9	10
16:30-16:45							114	10	124	8.1	1.5	7
16:45-17:00							112	11	123	8.9	1.5	2
1時間計							497	54	551	9.8	6.6	27
17:00-17:15							117	8	125	6.4	1.5	3
17:15-17:30							171	7	178	3.9	2.1	7
17:30-17:45							142	11	153	7.2	1.8	10
17:45-18:00							153	8	161	5.0	1.9	17
1時間計							583	34	617	5.5	7.4	37
18:00-18:15							155	5	160	3.1	1.9	11
18:15-18:30							163	7	170	4.1	2.1	13
18:30-18:45							125	6	131	4.6	1.6	4
18:45-19:00							118	3	121	2.5	1.5	6
1時間計							561	21	582	3.6	7.0	34
昼12時間計							5068	755	5823	13.0	70.3	226
19:00-19:15							107	7	114	6.1	1.4	8
19:15-19:30							110	5	115	4.3	1.4	6
19:30-19:45							145	3	148	2.0	1.8	10
19:45-20:00							94	2	96	2.1	1.2	7
1時間計							456	17	473	3.6	5.7	31
20:00-20:15							125	4	129	3.1	1.6	13
20:15-20:30							115	3	118	2.5	1.4	6
20:30-20:45							111	5	116	4.3	1.4	5
20:45-21:00							87	1	88	1.1	1.1	7
1時間計							438	13	451	2.9	5.4	31
21:00-21:15							95	3	98	3.1	1.2	5
21:15-21:30							75	1	76	1.3	0.9	3
21:30-21:45							58	3	61	4.9	0.7	2
21:45-22:00							50	4	54	7.4	0.7	6
1時間計							278	11	289	3.8	3.5	16
22:00-22:15							77	9	86	10.5	1.0	6
22:15-22:30							49	4	53	7.5	0.6	1
22:30-22:45							67	2	69	2.9	0.8	7
22:45-23:00							42	2	44	4.5	0.5	0
1時間計							235	17	252	6.7	3.0	14

方向別自動車交通量調査表

調査地点：地域社会5

調査年月日：令和元年 5月14日(火) 天候：雨のち曇り



方向 時間帯							A 合計 (1+2)					
	種別 小型車 (台)	大型車 (台)	合計 (台)	大型車 混入率 (%)	時間 係数 (%)	二輪車 (台)	小型車 (台)	大型車 (台)	合計 (台)	大型車 混入率 (%)	時間 係数 (%)	二輪車 (台)
23:00-23:15							45	6	51	11.8	0.6	2
23:15-23:30							31	3	34	8.8	0.4	2
23:30-23:45							24	2	26	7.7	0.3	1
23:45-24:00							23	4	27	14.8	0.3	1
1 時間計							123	15	138	10.9	1.7	6
0:00-0:15							27	3	30	10.0	0.4	1
0:15-0:30							24	4	28	14.3	0.3	1
0:30-0:45							11	7	18	38.9	0.2	0
0:45-1:00							11	4	15	26.7	0.2	1
1 時間計							73	18	91	19.8	1.1	3
1:00-1:15							15	4	19	21.1	0.2	1
1:15-1:30							13	4	17	23.5	0.2	0
1:30-1:45							9	6	15	40.0	0.2	1
1:45-2:00							15	3	18	16.7	0.2	0
1 時間計							52	17	69	24.6	0.8	2
2:00-2:15							4	3	7	42.9	0.1	0
2:15-2:30							19	5	24	20.8	0.3	0
2:30-2:45							11	4	15	26.7	0.2	0
2:45-3:00							4	5	9	55.6	0.1	1
1 時間計							38	17	55	30.9	0.7	1
3:00-3:15							8	3	11	27.3	0.1	2
3:15-3:30							7	4	11	36.4	0.1	1
3:30-3:45							7	2	9	22.2	0.1	0
3:45-4:00							8	1	9	11.1	0.1	1
1 時間計							30	10	40	25.0	0.5	4
4:00-4:15							8	2	10	20.0	0.1	1
4:15-4:30							14	4	18	22.2	0.2	1
4:30-4:45							12	3	15	20.0	0.2	2
4:45-5:00							20	7	27	25.9	0.3	2
1 時間計							54	16	70	22.9	0.8	6
5:00-5:15							10	10	20	50.0	0.2	3
5:15-5:30							25	5	30	16.7	0.4	1
5:30-5:45							27	9	36	25.0	0.4	2
5:45-6:00							50	16	66	24.2	0.8	2
1 時間計							112	40	152	26.3	1.8	8
6:00-6:15							53	12	65	18.5	0.8	5
6:15-6:30							78	16	94	17.0	1.1	8
6:30-6:45							102	19	121	15.7	1.5	12
6:45-7:00							88	15	103	14.6	1.2	10
1 時間計							321	62	383	16.2	4.6	35
夜12時間計							2210	253	2463	10.3	29.7	157
全時間合計							7278	1008	8286	12.2	100.0	383
昼夜率							1.44	1.34	1.42	-	-	1.69

方向別自動車交通量調査表

調査地点：地域社会5

調査年月日：令和元年 5月14日(火) 天候：雨のち曇り



時間帯	種別	3					4						
		小型車 (台)	大型車 (台)	合計 (台)	大型車 混入率 (%)	時 間 係 数 (%)	二輪車 (台)	小型車 (台)	大型車 (台)	合計 (台)	大型車 混入率 (%)	時 間 係 数 (%)	二輪車 (台)
7:00-7:15		123	16	139	11.5	2.0	6	21	0	21	0.0	2.7	1
7:15-7:30		109	14	123	11.4	1.8	14	20	1	21	4.8	2.7	0
7:30-7:45		113	18	131	13.7	1.9	20	14	0	14	0.0	1.8	2
7:45-8:00		93	13	106	12.3	1.5	9	21	0	21	0.0	2.7	0
1時間計		438	61	499	12.2	7.2	49	76	1	77	1.3	9.8	3
8:00-8:15		99	8	107	7.5	1.5	15	17	0	17	0.0	2.2	1
8:15-8:30		102	11	113	9.7	1.6	8	23	1	24	4.2	3.1	0
8:30-8:45		91	17	108	15.7	1.6	9	18	1	19	5.3	2.4	0
8:45-9:00		108	18	126	14.3	1.8	10	18	0	18	0.0	2.3	0
1時間計		400	54	454	11.9	6.6	42	76	2	78	2.6	9.9	1
9:00-9:15		91	12	103	11.7	1.5	2	13	1	14	7.1	1.8	0
9:15-9:30		74	19	93	20.4	1.3	4	9	0	9	0.0	1.1	0
9:30-9:45		54	17	71	23.9	1.0	3	20	0	20	0.0	2.5	1
9:45-10:00		73	15	88	17.0	1.3	3	9	0	9	0.0	1.1	0
1時間計		292	63	355	17.7	5.1	12	51	1	52	1.9	6.6	1
10:00-10:15		71	12	83	14.5	1.2	2	16	0	16	0.0	2.0	0
10:15-10:30		92	19	111	17.1	1.6	1	15	0	15	0.0	1.9	1
10:30-10:45		82	11	93	11.8	1.3	4	7	0	7	0.0	0.9	0
10:45-11:00		91	21	112	18.8	1.6	0	8	0	8	0.0	1.0	1
1時間計		336	63	399	15.8	5.8	7	46	0	46	0.0	5.9	2
11:00-11:15		64	14	78	17.9	1.1	2	5	1	6	16.7	0.8	0
11:15-11:30		66	21	87	24.1	1.3	1	15	3	18	16.7	2.3	0
11:30-11:45		80	20	100	20.0	1.4	3	11	0	11	0.0	1.4	0
11:45-12:00		86	22	108	20.4	1.6	3	9	0	9	0.0	1.1	0
1時間計		296	77	373	20.6	5.4	9	40	4	44	9.1	5.6	0
12:00-12:15		54	19	73	26.0	1.1	2	14	1	15	6.7	1.9	1
12:15-12:30		63	9	72	12.5	1.0	4	8	3	11	27.3	1.4	0
12:30-12:45		71	22	93	23.7	1.3	5	11	2	13	15.4	1.7	0
12:45-13:00		66	15	81	18.5	1.2	1	8	1	9	11.1	1.1	0
1時間計		254	65	319	20.4	4.6	12	41	7	48	14.6	6.1	1
13:00-13:15		92	16	108	14.8	1.6	3	9	1	10	10.0	1.3	0
13:15-13:30		91	17	108	15.7	1.6	9	17	1	18	5.6	2.3	0
13:30-13:45		79	13	92	14.1	1.3	3	11	1	12	8.3	1.5	0
13:45-14:00		69	21	90	23.3	1.3	1	10	0	10	0.0	1.3	1
1時間計		331	67	398	16.8	5.8	16	47	3	50	6.0	6.4	1
14:00-14:15		65	13	78	16.7	1.1	2	12	1	13	7.7	1.7	2
14:15-14:30		75	19	94	20.2	1.4	3	14	0	14	0.0	1.8	0
14:30-14:45		97	11	108	10.2	1.6	9	8	0	8	0.0	1.0	1
14:45-15:00		67	11	78	14.1	1.1	2	21	1	22	4.5	2.8	0
1時間計		304	54	358	15.1	5.2	16	55	2	57	3.5	7.3	3

方向別自動車交通量調査表

調査地点 : 地域社会5

調査年月日 : 令和元年 5月14日(火) 天候:雨のち曇り



時間帯	3						4					
	小型車 (台)	大型車 (台)	合計 (台)	大型車 混入率 (%)	時 間 係 数 (%)	二輪車 (台)	小型車 (台)	大型車 (台)	合計 (台)	大型車 混入率 (%)	時 間 係 数 (%)	二輪車 (台)
15:00-15:15	91	14	105	13.3	1.5	2	10	0	10	0.0	1.3	0
15:15-15:30	102	11	113	9.7	1.6	2	13	0	13	0.0	1.7	0
15:30-15:45	94	10	104	9.6	1.5	3	21	0	21	0.0	2.7	0
15:45-16:00	63	9	72	12.5	1.0	2	10	0	10	0.0	1.3	0
1時間計	350	44	394	11.2	5.7	9	54	0	54	0.0	6.9	0
16:00-16:15	90	10	100	10.0	1.4	1	8	1	9	11.1	1.1	1
16:15-16:30	77	9	86	10.5	1.2	6	7	0	7	0.0	0.9	0
16:30-16:45	86	15	101	14.9	1.5	6	6	0	6	0.0	0.8	1
16:45-17:00	66	9	75	12.0	1.1	1	11	0	11	0.0	1.4	1
1時間計	319	43	362	11.9	5.2	14	32	1	33	3.0	4.2	3
17:00-17:15	100	4	104	3.8	1.5	6	23	0	23	0.0	2.9	0
17:15-17:30	104	14	118	11.9	1.7	5	6	0	6	0.0	0.8	0
17:30-17:45	85	7	92	7.6	1.3	3	10	0	10	0.0	1.3	1
17:45-18:00	91	10	101	9.9	1.5	6	10	1	11	9.1	1.4	0
1時間計	380	35	415	8.4	6.0	20	49	1	50	2.0	6.4	1
18:00-18:15	94	6	100	6.0	1.4	9	14	0	14	0.0	1.8	0
18:15-18:30	91	7	98	7.1	1.4	6	9	0	9	0.0	1.1	0
18:30-18:45	84	5	89	5.6	1.3	5	7	0	7	0.0	0.9	1
18:45-19:00	78	10	88	11.4	1.3	7	6	0	6	0.0	0.8	1
1時間計	347	28	375	7.5	5.4	27	36	0	36	0.0	4.6	2
昼12時間計	4047	654	4701	13.9	68.0	233	603	22	625	3.5	79.6	18
19:00-19:15	70	0	70	0.0	1.0	5	16	0	16	0.0	2.0	0
19:15-19:30	82	5	87	5.7	1.3	4	9	0	9	0.0	1.1	0
19:30-19:45	73	3	76	3.9	1.1	2	4	0	4	0.0	0.5	1
19:45-20:00	66	2	68	2.9	1.0	6	1	0	1	0.0	0.1	1
1時間計	291	10	301	3.3	4.4	17	30	0	30	0.0	3.8	2
20:00-20:15	70	2	72	2.8	1.0	3	6	0	6	0.0	0.8	2
20:15-20:30	70	1	71	1.4	1.0	3	7	0	7	0.0	0.9	3
20:30-20:45	55	4	59	6.8	0.9	5	4	0	4	0.0	0.5	1
20:45-21:00	59	5	64	7.8	0.9	1	5	0	5	0.0	0.6	2
1時間計	254	12	266	4.5	3.8	12	22	0	22	0.0	2.8	8
21:00-21:15	39	1	40	2.5	0.6	2	2	1	3	33.3	0.4	0
21:15-21:30	41	4	45	8.9	0.7	2	2	1	3	33.3	0.4	0
21:30-21:45	39	2	41	4.9	0.6	5	2	0	2	0.0	0.3	0
21:45-22:00	49	4	53	7.5	0.8	3	2	0	2	0.0	0.3	0
1時間計	168	11	179	6.1	2.6	12	8	2	10	20.0	1.3	0
22:00-22:15	42	0	42	0.0	0.6	0	7	0	7	0.0	0.9	1
22:15-22:30	53	3	56	5.4	0.8	3	4	0	4	0.0	0.5	0
22:30-22:45	35	6	41	14.6	0.6	0	2	0	2	0.0	0.3	0
22:45-23:00	25	7	32	21.9	0.5	1	1	0	1	0.0	0.1	1
1時間計	155	16	171	9.4	2.5	4	14	0	14	0.0	1.8	2

方向別自動車交通量調査表

調査地点：地域社会5

調査年月日：令和元年 5月14日(火) 天候：雨のち曇り



方向 時間帯	3						4					
	種別 小型車 (台)	大型車 (台)	合計 (台)	大型車 混入率 (%)	時 間 係 数 (%)	二輪車 (台)	小型車 (台)	大型車 (台)	合計 (台)	大型車 混入率 (%)	時 間 係 数 (%)	二輪車 (台)
23:00-23:15	20	9	29	31.0	0.4	1	1	0	1	0.0	0.1	0
23:15-23:30	17	2	19	10.5	0.3	0	4	0	4	0.0	0.5	0
23:30-23:45	23	3	26	11.5	0.4	4	1	0	1	0.0	0.1	0
23:45-24:00	9	4	13	30.8	0.2	1	2	0	2	0.0	0.3	0
1時間計	69	18	87	20.7	1.3	6	8	0	8	0.0	1.0	0
0:00-0:15	9	1	10	10.0	0.1	2	0	0	0	0.0	0.0	0
0:15-0:30	10	1	11	9.1	0.2	1	2	0	2	0.0	0.3	0
0:30-0:45	8	3	11	27.3	0.2	0	0	0	0	0.0	0.0	0
0:45-1:00	15	4	19	21.1	0.3	1	0	0	0	0.0	0.0	0
1時間計	42	9	51	17.6	0.7	4	2	0	2	0.0	0.3	0
1:00-1:15	10	6	16	37.5	0.2	1	1	0	1	0.0	0.1	0
1:15-1:30	9	2	11	18.2	0.2	0	0	0	0	0.0	0.0	1
1:30-1:45	4	6	10	60.0	0.1	1	1	0	1	0.0	0.1	0
1:45-2:00	10	9	19	47.4	0.3	1	0	1	1	100.0	0.1	0
1時間計	33	23	56	41.1	0.8	3	2	1	3	33.3	0.4	1
2:00-2:15	14	0	14	0.0	0.2	1	0	1	1	100.0	0.1	1
2:15-2:30	22	6	28	21.4	0.4	1	0	2	2	100.0	0.3	1
2:30-2:45	10	7	17	41.2	0.2	1	0	0	0	0.0	0.0	0
2:45-3:00	5	8	13	61.5	0.2	1	1	0	1	0.0	0.1	0
1時間計	51	21	72	29.2	1.0	4	1	3	4	75.0	0.5	2
3:00-3:15	4	9	13	69.2	0.2	0	0	0	0	0.0	0.0	0
3:15-3:30	9	7	16	43.8	0.2	0	0	0	0	0.0	0.0	0
3:30-3:45	13	4	17	23.5	0.2	0	0	0	0	0.0	0.0	0
3:45-4:00	10	8	18	44.4	0.3	1	1	1	2	50.0	0.3	0
1時間計	36	28	64	43.8	0.9	1	1	1	2	50.0	0.3	0
4:00-4:15	12	6	18	33.3	0.3	3	0	0	0	0.0	0.0	1
4:15-4:30	19	7	26	26.9	0.4	1	1	0	1	0.0	0.1	0
4:30-4:45	17	13	30	43.3	0.4	6	1	0	1	0.0	0.1	0
4:45-5:00	30	14	44	31.8	0.6	2	1	0	1	0.0	0.1	0
1時間計	78	40	118	33.9	1.7	12	3	0	3	0.0	0.4	1
5:00-5:15	36	19	55	34.5	0.8	4	1	0	1	0.0	0.1	0
5:15-5:30	60	11	71	15.5	1.0	5	2	0	2	0.0	0.3	0
5:30-5:45	64	10	74	13.5	1.1	3	4	0	4	0.0	0.5	0
5:45-6:00	78	13	91	14.3	1.3	4	7	0	7	0.0	0.9	1
1時間計	238	53	291	18.2	4.2	16	14	0	14	0.0	1.8	1
6:00-6:15	86	24	110	21.8	1.6	6	12	0	12	0.0	1.5	2
6:15-6:30	128	17	145	11.7	2.1	7	10	0	10	0.0	1.3	1
6:30-6:45	134	17	151	11.3	2.2	9	14	3	17	17.6	2.2	0
6:45-7:00	142	13	155	8.4	2.2	19	9	0	9	0.0	1.1	1
1時間計	490	71	561	12.7	8.1	41	45	3	48	6.3	6.1	4
夜12時間計	1905	312	2217	14.1	32.0	132	150	10	160	6.3	20.4	21
全時間合計	5952	966	6918	14.0	100.0	365	753	32	785	4.1	100.0	39
昼 夜 率	1.47	1.48	1.47	-	-	1.57	1.25	1.45	1.26	-	-	2.17

方向別自動車交通量調査表

調査地点 : 地域社会5

調査年月日 : 令和元年 5月14日(火) 天候: 雨のち曇り



時間帯	方向 種別							B 合計 (3+4)					
		小型車 (台)	大型車 (台)	合計 (台)	大型車 混入率 (%)	時間 係数 (%)	二輪車 (台)	小型車 (台)	大型車 (台)	合計 (台)	大型車 混入率 (%)	時間 係数 (%)	二輪車 (台)
7:00-7:15							144	16	160	10.0	2.1	7	
7:15-7:30							129	15	144	10.4	1.9	14	
7:30-7:45							127	18	145	12.4	1.9	22	
7:45-8:00							114	13	127	10.2	1.6	9	
1時間計							514	62	576	10.8	7.5	52	
8:00-8:15							116	8	124	6.5	1.6	16	
8:15-8:30							125	12	137	8.8	1.8	8	
8:30-8:45							109	18	127	14.2	1.6	9	
8:45-9:00							126	18	144	12.5	1.9	10	
1時間計							476	56	532	10.5	6.9	43	
9:00-9:15							104	13	117	11.1	1.5	2	
9:15-9:30							83	19	102	18.6	1.3	4	
9:30-9:45							74	17	91	18.7	1.2	4	
9:45-10:00							82	15	97	15.5	1.3	3	
1時間計							343	64	407	15.7	5.3	13	
10:00-10:15							87	12	99	12.1	1.3	2	
10:15-10:30							107	19	126	15.1	1.6	2	
10:30-10:45							89	11	100	11.0	1.3	4	
10:45-11:00							99	21	120	17.5	1.6	1	
1時間計							382	63	445	14.2	5.8	9	
11:00-11:15							69	15	84	17.9	1.1	2	
11:15-11:30							81	24	105	22.9	1.4	1	
11:30-11:45							91	20	111	18.0	1.4	3	
11:45-12:00							95	22	117	18.8	1.5	3	
1時間計							336	81	417	19.4	5.4	9	
12:00-12:15							68	20	88	22.7	1.1	3	
12:15-12:30							71	12	83	14.5	1.1	4	
12:30-12:45							82	24	106	22.6	1.4	5	
12:45-13:00							74	16	90	17.8	1.2	1	
1時間計							295	72	367	19.6	4.8	13	
13:00-13:15							101	17	118	14.4	1.5	3	
13:15-13:30							108	18	126	14.3	1.6	9	
13:30-13:45							90	14	104	13.5	1.4	3	
13:45-14:00							79	21	100	21.0	1.3	2	
1時間計							378	70	448	15.6	5.8	17	
14:00-14:15							77	14	91	15.4	1.2	4	
14:15-14:30							89	19	108	17.6	1.4	3	
14:30-14:45							105	11	116	9.5	1.5	10	
14:45-15:00							88	12	100	12.0	1.3	2	
1時間計							359	56	415	13.5	5.4	19	

方向別自動車交通量調査表

調査地点：地域社会5

調査年月日：令和元年 5月14日(火) 天候：雨のち曇り



方向 時間帯							B 合計 (3+4)					
	種別 小型車 (台)	大型車 (台)	合計 (台)	大型車 混入率 (%)	時間 係数 (%)	二輪車 (台)	小型車 (台)	大型車 (台)	合計 (台)	大型車 混入率 (%)	時間 係数 (%)	二輪車 (台)
15:00-15:15							101	14	115	12.2	1.5	2
15:15-15:30							115	11	126	8.7	1.6	2
15:30-15:45							115	10	125	8.0	1.6	3
15:45-16:00							73	9	82	11.0	1.1	2
1時間計							404	44	448	9.8	5.8	9
16:00-16:15							98	11	109	10.1	1.4	2
16:15-16:30							84	9	93	9.7	1.2	6
16:30-16:45							92	15	107	14.0	1.4	7
16:45-17:00							77	9	86	10.5	1.1	2
1時間計							351	44	395	11.1	5.1	17
17:00-17:15							123	4	127	3.1	1.6	6
17:15-17:30							110	14	124	11.3	1.6	5
17:30-17:45							95	7	102	6.9	1.3	4
17:45-18:00							101	11	112	9.8	1.5	6
1時間計							429	36	465	7.7	6.0	21
18:00-18:15							108	6	114	5.3	1.5	9
18:15-18:30							100	7	107	6.5	1.4	6
18:30-18:45							91	5	96	5.2	1.2	6
18:45-19:00							84	10	94	10.6	1.2	8
1時間計							383	28	411	6.8	5.3	29
昼12時間計							4650	676	5326	12.7	69.1	251
19:00-19:15							86	0	86	0.0	1.1	5
19:15-19:30							91	5	96	5.2	1.2	4
19:30-19:45							77	3	80	3.8	1.0	3
19:45-20:00							67	2	69	2.9	0.9	7
1時間計							321	10	331	3.0	4.3	19
20:00-20:15							76	2	78	2.6	1.0	5
20:15-20:30							77	1	78	1.3	1.0	6
20:30-20:45							59	4	63	6.3	0.8	6
20:45-21:00							64	5	69	7.2	0.9	3
1時間計							276	12	288	4.2	3.7	20
21:00-21:15							41	2	43	4.7	0.6	2
21:15-21:30							43	5	48	10.4	0.6	2
21:30-21:45							41	2	43	4.7	0.6	5
21:45-22:00							51	4	55	7.3	0.7	3
1時間計							176	13	189	6.9	2.5	12
22:00-22:15							49	0	49	0.0	0.6	1
22:15-22:30							57	3	60	5.0	0.8	3
22:30-22:45							37	6	43	14.0	0.6	0
22:45-23:00							26	7	33	21.2	0.4	2
1時間計							169	16	185	8.6	2.4	6

方向別自動車交通量調査表

調査地点：地域社会5

調査年月日：令和元年 5月14日(火) 天候：雨のち曇り



時間帯	方向 種別							B 合計 (3+4)					
		小型車 (台)	大型車 (台)	合計 (台)	大型車 混入率 (%)	時間 係数 (%)	二輪車 (台)	小型車 (台)	大型車 (台)	合計 (台)	大型車 混入率 (%)	時間 係数 (%)	二輪車 (台)
23:00-23:15							21	9	30	30.0	0.4	1	
23:15-23:30							21	2	23	8.7	0.3	0	
23:30-23:45							24	3	27	11.1	0.4	4	
23:45-24:00							11	4	15	26.7	0.2	1	
1時間計							77	18	95	18.9	1.2	6	
0:00-0:15							9	1	10	10.0	0.1	2	
0:15-0:30							12	1	13	7.7	0.2	1	
0:30-0:45							8	3	11	27.3	0.1	0	
0:45-1:00							15	4	19	21.1	0.2	1	
1時間計							44	9	53	17.0	0.7	4	
1:00-1:15							11	6	17	35.3	0.2	1	
1:15-1:30							9	2	11	18.2	0.1	1	
1:30-1:45							5	6	11	54.5	0.1	1	
1:45-2:00							10	10	20	50.0	0.3	1	
1時間計							35	24	59	40.7	0.8	4	
2:00-2:15							14	1	15	6.7	0.2	2	
2:15-2:30							22	8	30	26.7	0.4	2	
2:30-2:45							10	7	17	41.2	0.2	1	
2:45-3:00							6	8	14	57.1	0.2	1	
1時間計							52	24	76	31.6	1.0	6	
3:00-3:15							4	9	13	69.2	0.2	0	
3:15-3:30							9	7	16	43.8	0.2	0	
3:30-3:45							13	4	17	23.5	0.2	0	
3:45-4:00							11	9	20	45.0	0.3	1	
1時間計							37	29	66	43.9	0.9	1	
4:00-4:15							12	6	18	33.3	0.2	4	
4:15-4:30							20	7	27	25.9	0.4	1	
4:30-4:45							18	13	31	41.9	0.4	6	
4:45-5:00							31	14	45	31.1	0.6	2	
1時間計							81	40	121	33.1	1.6	13	
5:00-5:15							37	19	56	33.9	0.7	4	
5:15-5:30							62	11	73	15.1	0.9	5	
5:30-5:45							68	10	78	12.8	1.0	3	
5:45-6:00							85	13	98	13.3	1.3	5	
1時間計							252	53	305	17.4	4.0	17	
6:00-6:15							98	24	122	19.7	1.6	8	
6:15-6:30							138	17	155	11.0	2.0	8	
6:30-6:45							148	20	168	11.9	2.2	9	
6:45-7:00							151	13	164	7.9	2.1	20	
1時間計							535	74	609	12.2	7.9	45	
夜12時間計							2055	322	2377	13.5	30.9	153	
全時間合計							6705	998	7703	13.0	100.0	404	
昼夜率							1.44	1.48	1.45	-	-	1.61	

方向別自動車交通量調査表

調査地点：地域社会5

調査年月日：令和元年 5月14日(火) 天候：雨のち曇り



方向	5						6						
	種別	小型車 (台)	大型車 (台)	合計 (台)	大型車 混入率 (%)	時間 係数 (%)	二輪車 (台)	小型車 (台)	大型車 (台)	合計 (台)	大型車 混入率 (%)	時間 係数 (%)	二輪車 (台)
7:00-7:15		16	2	18	11.1	2.0	3	44	1	45	2.2	2.2	2
7:15-7:30		5	0	5	0.0	0.5	1	41	1	42	2.4	2.1	5
7:30-7:45		22	0	22	0.0	2.4	3	46	0	46	0.0	2.3	2
7:45-8:00		22	0	22	0.0	2.4	1	37	4	41	9.8	2.0	2
1時間計		65	2	67	3.0	7.4	8	168	6	174	3.4	8.6	11
8:00-8:15		29	2	31	6.5	3.4	1	35	2	37	5.4	1.8	7
8:15-8:30		23	0	23	0.0	2.5	1	44	3	47	6.4	2.3	5
8:30-8:45		9	1	10	10.0	1.1	1	55	1	56	1.8	2.8	5
8:45-9:00		23	1	24	4.2	2.6	0	32	0	32	0.0	1.6	0
1時間計		84	4	88	4.5	9.7	3	166	6	172	3.5	8.5	17
9:00-9:15		15	4	19	21.1	2.1	0	42	1	43	2.3	2.1	3
9:15-9:30		15	2	17	11.8	1.9	1	38	1	39	2.6	1.9	1
9:30-9:45		14	0	14	0.0	1.5	0	36	2	38	5.3	1.9	1
9:45-10:00		9	1	10	10.0	1.1	0	34	1	35	2.9	1.7	1
1時間計		53	7	60	11.7	6.6	1	150	5	155	3.2	7.7	6
10:00-10:15		7	2	9	22.2	1.0	0	26	3	29	10.3	1.4	0
10:15-10:30		10	1	11	9.1	1.2	1	29	0	29	0.0	1.4	1
10:30-10:45		14	0	14	0.0	1.5	0	32	1	33	3.0	1.6	1
10:45-11:00		17	1	18	5.6	2.0	2	30	1	31	3.2	1.5	0
1時間計		48	4	52	7.7	5.7	3	117	5	122	4.1	6.1	2
11:00-11:15		18	2	20	10.0	2.2	0	27	2	29	6.9	1.4	0
11:15-11:30		9	0	9	0.0	1.0	0	21	0	21	0.0	1.0	1
11:30-11:45		10	0	10	0.0	1.1	0	18	4	22	18.2	1.1	0
11:45-12:00		15	0	15	0.0	1.6	0	26	1	27	3.7	1.3	0
1時間計		52	2	54	3.7	5.9	0	92	7	99	7.1	4.9	1
12:00-12:15		7	0	7	0.0	0.8	0	18	3	21	14.3	1.0	0
12:15-12:30		9	0	9	0.0	1.0	1	18	2	20	10.0	1.0	1
12:30-12:45		12	0	12	0.0	1.3	1	16	2	18	11.1	0.9	2
12:45-13:00		23	0	23	0.0	2.5	1	20	1	21	4.8	1.0	0
1時間計		51	0	51	0.0	5.6	3	72	8	80	10.0	4.0	3
13:00-13:15		14	1	15	6.7	1.6	1	43	5	48	10.4	2.4	4
13:15-13:30		12	0	12	0.0	1.3	0	29	1	30	3.3	1.5	1
13:30-13:45		10	0	10	0.0	1.1	1	24	4	28	14.3	1.4	1
13:45-14:00		16	0	16	0.0	1.8	1	30	1	31	3.2	1.5	2
1時間計		52	1	53	1.9	5.8	3	126	11	137	8.0	6.8	8
14:00-14:15		8	1	9	11.1	1.0	2	24	5	29	17.2	1.4	1
14:15-14:30		7	0	7	0.0	0.8	1	15	2	17	11.8	0.8	0
14:30-14:45		13	1	14	7.1	1.5	0	22	3	25	12.0	1.2	1
14:45-15:00		10	1	11	9.1	1.2	1	16	4	20	20.0	1.0	1
1時間計		38	3	41	7.3	4.5	4	77	14	91	15.4	4.5	3

方向別自動車交通量調査表

調査地点：地域社会5

調査年月日：令和元年 5月14日(火) 天候：雨のち曇り



方向 種別 時間帯	5						6					
	小型車 (台)	大型車 (台)	合計 (台)	大型車 混入率 (%)	時間 係数 (%)	二輪車 (台)	小型車 (台)	大型車 (台)	合計 (台)	大型車 混入率 (%)	時間 係数 (%)	二輪車 (台)
15:00-15:15	7	0	7	0.0	0.8	0	37	0	37	0.0	1.8	0
15:15-15:30	17	1	18	5.6	2.0	0	34	0	34	0.0	1.7	1
15:30-15:45	7	2	9	22.2	1.0	0	29	0	29	0.0	1.4	1
15:45-16:00	14	1	15	6.7	1.6	0	38	1	39	2.6	1.9	0
1時間計	45	4	49	8.2	5.4	0	138	1	139	0.7	6.9	2
16:00-16:15	18	0	18	0.0	2.0	0	33	0	33	0.0	1.6	1
16:15-16:30	17	1	18	5.6	2.0	1	31	1	32	3.1	1.6	0
16:30-16:45	16	2	18	11.1	2.0	0	31	1	32	3.1	1.6	2
16:45-17:00	26	2	28	7.1	3.1	1	24	3	27	11.1	1.3	2
1時間計	77	5	82	6.1	9.0	2	119	5	124	4.0	6.2	5
17:00-17:15	17	0	17	0.0	1.9	4	44	0	44	0.0	2.2	1
17:15-17:30	17	2	19	10.5	2.1	0	30	1	31	3.2	1.5	3
17:30-17:45	30	0	30	0.0	3.3	1	27	3	30	10.0	1.5	2
17:45-18:00	15	1	16	6.3	1.8	0	26	3	29	10.3	1.4	2
1時間計	79	3	82	3.7	9.0	5	127	7	134	5.2	6.6	8
18:00-18:15	15	0	15	0.0	1.6	0	45	0	45	0.0	2.2	1
18:15-18:30	15	0	15	0.0	1.6	0	37	0	37	0.0	1.8	1
18:30-18:45	24	0	24	0.0	2.6	0	30	0	30	0.0	1.5	0
18:45-19:00	37	0	37	0.0	4.1	0	35	1	36	2.8	1.8	4
1時間計	91	0	91	0.0	10.0	0	147	1	148	0.7	7.3	6
昼12時間計	735	35	770	4.5	84.5	32	1499	76	1575	4.8	78.1	72
19:00-19:15	14	0	14	0.0	1.5	0	27	0	27	0.0	1.3	2
19:15-19:30	26	0	26	0.0	2.9	0	29	1	30	3.3	1.5	1
19:30-19:45	7	0	7	0.0	0.8	1	23	0	23	0.0	1.1	0
19:45-20:00	4	0	4	0.0	0.4	0	25	1	26	3.8	1.3	2
1時間計	51	0	51	0.0	5.6	1	104	2	106	1.9	5.3	5
20:00-20:15	3	0	3	0.0	0.3	0	19	2	21	9.5	1.0	1
20:15-20:30	5	0	5	0.0	0.5	2	22	2	24	8.3	1.2	0
20:30-20:45	5	0	5	0.0	0.5	0	12	0	12	0.0	0.6	0
20:45-21:00	3	0	3	0.0	0.3	0	15	0	15	0.0	0.7	2
1時間計	16	0	16	0.0	1.8	2	68	4	72	5.6	3.6	3
21:00-21:15	5	0	5	0.0	0.5	0	16	0	16	0.0	0.8	0
21:15-21:30	2	0	2	0.0	0.2	0	7	1	8	12.5	0.4	0
21:30-21:45	3	0	3	0.0	0.3	1	8	2	10	20.0	0.5	1
21:45-22:00	1	0	1	0.0	0.1	0	9	0	9	0.0	0.4	1
1時間計	11	0	11	0.0	1.2	1	40	3	43	7.0	2.1	2
22:00-22:15	3	0	3	0.0	0.3	0	5	0	5	0.0	0.2	2
22:15-22:30	5	0	5	0.0	0.5	0	4	0	4	0.0	0.2	0
22:30-22:45	2	0	2	0.0	0.2	0	7	0	7	0.0	0.3	1
22:45-23:00	4	0	4	0.0	0.4	0	5	2	7	28.6	0.3	0
1時間計	14	0	14	0.0	1.5	0	21	2	23	8.7	1.1	3

方向別自動車交通量調査表

調査地点：地域社会5

調査年月日：令和元年 5月14日(火) 天候：雨のち曇り



方向 種別 時間帯	5						6					
	小型車 (台)	大型車 (台)	合計 (台)	大型車 混入率 (%)	時間 係数 (%)	二輪車 (台)	小型車 (台)	大型車 (台)	合計 (台)	大型車 混入率 (%)	時間 係数 (%)	二輪車 (台)
23:00-23:15	4	0	4	0.0	0.4	0	3	0	3	0.0	0.1	0
23:15-23:30	1	0	1	0.0	0.1	0	2	0	2	0.0	0.1	1
23:30-23:45	2	0	2	0.0	0.2	0	2	1	3	33.3	0.1	0
23:45-24:00	0	0	0	0.0	0.0	0	4	0	4	0.0	0.2	0
1時間計	7	0	7	0.0	0.8	0	11	1	12	8.3	0.6	1
0:00-0:15	1	0	1	0.0	0.1	0	2	0	2	0.0	0.1	0
0:15-0:30	1	0	1	0.0	0.1	0	1	0	1	0.0	0.0	0
0:30-0:45	2	0	2	0.0	0.2	0	2	0	2	0.0	0.1	0
0:45-1:00	0	0	0	0.0	0.0	0	0	0	0	0.0	0.0	0
1時間計	4	0	4	0.0	0.4	0	5	0	5	0.0	0.2	0
1:00-1:15	1	0	1	0.0	0.1	0	3	0	3	0.0	0.1	0
1:15-1:30	0	0	0	0.0	0.0	0	0	0	0	0.0	0.0	0
1:30-1:45	1	0	1	0.0	0.1	0	1	1	2	50.0	0.1	0
1:45-2:00	0	0	0	0.0	0.0	0	2	0	2	0.0	0.1	0
1時間計	2	0	2	0.0	0.2	0	6	1	7	14.3	0.3	0
2:00-2:15	0	0	0	0.0	0.0	0	1	1	2	50.0	0.1	0
2:15-2:30	2	0	2	0.0	0.2	0	1	2	3	66.7	0.1	1
2:30-2:45	0	0	0	0.0	0.0	0	0	0	0	0.0	0.0	0
2:45-3:00	0	0	0	0.0	0.0	0	0	0	0	0.0	0.0	0
1時間計	2	0	2	0.0	0.2	0	2	3	5	60.0	0.2	1
3:00-3:15	0	0	0	0.0	0.0	0	1	0	1	0.0	0.0	0
3:15-3:30	0	0	0	0.0	0.0	0	1	0	1	0.0	0.0	1
3:30-3:45	1	0	1	0.0	0.1	0	3	0	3	0.0	0.1	1
3:45-4:00	0	0	0	0.0	0.0	0	2	0	2	0.0	0.1	0
1時間計	1	0	1	0.0	0.1	0	7	0	7	0.0	0.3	2
4:00-4:15	1	0	1	0.0	0.1	0	0	0	0	0.0	0.0	0
4:15-4:30	1	0	1	0.0	0.1	0	1	0	1	0.0	0.0	0
4:30-4:45	0	0	0	0.0	0.0	0	2	0	2	0.0	0.1	0
4:45-5:00	0	0	0	0.0	0.0	0	5	0	5	0.0	0.2	0
1時間計	2	0	2	0.0	0.2	0	8	0	8	0.0	0.4	0
5:00-5:15	1	0	1	0.0	0.1	0	10	0	10	0.0	0.5	1
5:15-5:30	2	0	2	0.0	0.2	1	11	0	11	0.0	0.5	0
5:30-5:45	6	0	6	0.0	0.7	1	12	1	13	7.7	0.6	1
5:45-6:00	0	1	1	100.0	0.1	1	16	0	16	0.0	0.8	0
1時間計	9	1	10	10.0	1.1	3	49	1	50	2.0	2.5	2
6:00-6:15	7	1	8	12.5	0.9	0	20	0	20	0.0	1.0	2
6:15-6:30	4	0	4	0.0	0.4	0	20	1	21	4.8	1.0	2
6:30-6:45	1	3	4	75.0	0.4	0	40	0	40	0.0	2.0	1
6:45-7:00	5	0	5	0.0	0.5	1	22	0	22	0.0	1.1	2
1時間計	17	4	21	19.0	2.3	1	102	1	103	1.0	5.1	7
夜12時間計	136	5	141	3.5	15.5	8	423	18	441	4.1	21.9	26
全時間合計	871	40	911	4.4	100.0	40	1922	94	2016	4.7	100.0	98
昼夜率	1.19	1.14	1.18	-	-	1.25	1.28	1.24	1.28	-	-	1.36

方向別自動車交通量調査表

調査地点 : 地域社会5

調査年月日 : 令和元年 5月14日(火) 天候: 雨のち曇り



方向 時間帯	種別						C 合計 (5+6)					
		小型車 (台)	大型車 (台)	合計 (台)	大型車 混入率 (%)	時間 係数 (%)	二輪車 (台)	小型車 (台)	大型車 (台)	合計 (台)	大型車 混入率 (%)	時間 係数 (%)
7:00-7:15							60	3	63	4.8	2.2	5
7:15-7:30							46	1	47	2.1	1.6	6
7:30-7:45							68	0	68	0.0	2.3	5
7:45-8:00							59	4	63	6.3	2.2	3
1時間計							233	8	241	3.3	8.2	19
8:00-8:15							64	4	68	5.9	2.3	8
8:15-8:30							67	3	70	4.3	2.4	6
8:30-8:45							64	2	66	3.0	2.3	6
8:45-9:00							55	1	56	1.8	1.9	0
1時間計							250	10	260	3.8	8.9	20
9:00-9:15							57	5	62	8.1	2.1	3
9:15-9:30							53	3	56	5.4	1.9	2
9:30-9:45							50	2	52	3.8	1.8	1
9:45-10:00							43	2	45	4.4	1.5	1
1時間計							203	12	215	5.6	7.3	7
10:00-10:15							33	5	38	13.2	1.3	0
10:15-10:30							39	1	40	2.5	1.4	2
10:30-10:45							46	1	47	2.1	1.6	1
10:45-11:00							47	2	49	4.1	1.7	2
1時間計							165	9	174	5.2	5.9	5
11:00-11:15							45	4	49	8.2	1.7	0
11:15-11:30							30	0	30	0.0	1.0	1
11:30-11:45							28	4	32	12.5	1.1	0
11:45-12:00							41	1	42	2.4	1.4	0
1時間計							144	9	153	5.9	5.2	1
12:00-12:15							25	3	28	10.7	1.0	0
12:15-12:30							27	2	29	6.9	1.0	2
12:30-12:45							28	2	30	6.7	1.0	3
12:45-13:00							43	1	44	2.3	1.5	1
1時間計							123	8	131	6.1	4.5	6
13:00-13:15							57	6	63	9.5	2.2	5
13:15-13:30							41	1	42	2.4	1.4	1
13:30-13:45							34	4	38	10.5	1.3	2
13:45-14:00							46	1	47	2.1	1.6	3
1時間計							178	12	190	6.3	6.5	11
14:00-14:15							32	6	38	15.8	1.3	3
14:15-14:30							22	2	24	8.3	0.8	1
14:30-14:45							35	4	39	10.3	1.3	1
14:45-15:00							26	5	31	16.1	1.1	2
1時間計							115	17	132	12.9	4.5	7

方向別自動車交通量調査表

調査地点 : 地域社会5

調査年月日 : 令和元年 5月14日(火) 天候: 雨のち曇り



方向 時間帯	種別						C 合計 (5+6)					
		小型車 (台)	大型車 (台)	合計 (台)	大型車 混入率 (%)	時間 係数 (%)	二輪車 (台)	小型車 (台)	大型車 (台)	合計 (台)	大型車 混入率 (%)	時間 係数 (%)
15:00-15:15							44	0	44	0.0	1.5	0
15:15-15:30							51	1	52	1.9	1.8	1
15:30-15:45							36	2	38	5.3	1.3	1
15:45-16:00							52	2	54	3.7	1.8	0
1時間計							183	5	188	2.7	6.4	2
16:00-16:15							51	0	51	0.0	1.7	1
16:15-16:30							48	2	50	4.0	1.7	1
16:30-16:45							47	3	50	6.0	1.7	2
16:45-17:00							50	5	55	9.1	1.9	3
1時間計							196	10	206	4.9	7.0	7
17:00-17:15							61	0	61	0.0	2.1	5
17:15-17:30							47	3	50	6.0	1.7	3
17:30-17:45							57	3	60	5.0	2.0	3
17:45-18:00							41	4	45	8.9	1.5	2
1時間計							206	10	216	4.6	7.4	13
18:00-18:15							60	0	60	0.0	2.0	1
18:15-18:30							52	0	52	0.0	1.8	1
18:30-18:45							54	0	54	0.0	1.8	0
18:45-19:00							72	1	73	1.4	2.5	4
1時間計							238	1	239	0.4	8.2	6
昼12時間計							2234	111	2345	4.7	80.1	104
19:00-19:15							41	0	41	0.0	1.4	2
19:15-19:30							55	1	56	1.8	1.9	1
19:30-19:45							30	0	30	0.0	1.0	1
19:45-20:00							29	1	30	3.3	1.0	2
1時間計							155	2	157	1.3	5.4	6
20:00-20:15							22	2	24	8.3	0.8	1
20:15-20:30							27	2	29	6.9	1.0	2
20:30-20:45							17	0	17	0.0	0.6	0
20:45-21:00							18	0	18	0.0	0.6	2
1時間計							84	4	88	4.5	3.0	5
21:00-21:15							21	0	21	0.0	0.7	0
21:15-21:30							9	1	10	10.0	0.3	0
21:30-21:45							11	2	13	15.4	0.4	2
21:45-22:00							10	0	10	0.0	0.3	1
1時間計							51	3	54	5.6	1.8	3
22:00-22:15							8	0	8	0.0	0.3	2
22:15-22:30							9	0	9	0.0	0.3	0
22:30-22:45							9	0	9	0.0	0.3	1
22:45-23:00							9	2	11	18.2	0.4	0
1時間計							35	2	37	5.4	1.3	3

方向別自動車交通量調査表

調査地点：地域社会5

調査年月日：令和元年 5月14日(火) 天候：雨のち曇り



方向							C 合計 (5+6)						
	種別	小型車 (台)	大型車 (台)	合計 (台)	大型車 混入率 (%)	時間 係数 (%)	二輪車 (台)	小型車 (台)	大型車 (台)	合計 (台)	大型車 混入率 (%)	時間 係数 (%)	二輪車 (台)
時間帯													
23:00-23:15							7	0	7	0.0	0.2	0	
23:15-23:30							3	0	3	0.0	0.1	1	
23:30-23:45							4	1	5	20.0	0.2	0	
23:45-24:00							4	0	4	0.0	0.1	0	
1時間計							18	1	19	5.3	0.6	1	
0:00-0:15							3	0	3	0.0	0.1	0	
0:15-0:30							2	0	2	0.0	0.1	0	
0:30-0:45							4	0	4	0.0	0.1	0	
0:45-1:00							0	0	0	0.0	0.0	0	
1時間計							9	0	9	0.0	0.3	0	
1:00-1:15							4	0	4	0.0	0.1	0	
1:15-1:30							0	0	0	0.0	0.0	0	
1:30-1:45							2	1	3	33.3	0.1	0	
1:45-2:00							2	0	2	0.0	0.1	0	
1時間計							8	1	9	11.1	0.3	0	
2:00-2:15							1	1	2	50.0	0.1	0	
2:15-2:30							3	2	5	40.0	0.2	1	
2:30-2:45							0	0	0	0.0	0.0	0	
2:45-3:00							0	0	0	0.0	0.0	0	
1時間計							4	3	7	42.9	0.2	1	
3:00-3:15							1	0	1	0.0	0.0	0	
3:15-3:30							1	0	1	0.0	0.0	1	
3:30-3:45							4	0	4	0.0	0.1	1	
3:45-4:00							2	0	2	0.0	0.1	0	
1時間計							8	0	8	0.0	0.3	2	
4:00-4:15							1	0	1	0.0	0.0	0	
4:15-4:30							2	0	2	0.0	0.1	0	
4:30-4:45							2	0	2	0.0	0.1	0	
4:45-5:00							5	0	5	0.0	0.2	0	
1時間計							10	0	10	0.0	0.3	0	
5:00-5:15							11	0	11	0.0	0.4	1	
5:15-5:30							13	0	13	0.0	0.4	1	
5:30-5:45							18	1	19	5.3	0.6	2	
5:45-6:00							16	1	17	5.9	0.6	1	
1時間計							58	2	60	3.3	2.0	5	
6:00-6:15							27	1	28	3.6	1.0	2	
6:15-6:30							24	1	25	4.0	0.9	2	
6:30-6:45							41	3	44	6.8	1.5	1	
6:45-7:00							27	0	27	0.0	0.9	3	
1時間計							119	5	124	4.0	4.2	8	
夜12時間計							559	23	582	4.0	19.9	34	
全時間合計							2793	134	2927	4.6	100.0	138	
昼夜率							1.25	1.21	1.25	-	-	1.33	

方向別自動車交通量調査表

調査地点：地域社会6 瀬谷中学校前

調査年月日：令和元年 5月14日(火) 天候：雨のち曇り



方向 時間帯	1						2					
	種別 小型車 (台)	大型車 (台)	合計 (台)	大型車 混入率 (%)	時 間 係 数 (%)	二輪車 (台)	種別 小型車 (台)	大型車 (台)	合計 (台)	大型車 混入率 (%)	時 間 係 数 (%)	二輪車 (台)
7:00-7:15	24	0	24	0.0	1.7	0	67	18	85	21.2	1.6	11
7:15-7:30	24	2	26	7.7	1.8	1	59	13	72	18.1	1.3	8
7:30-7:45	22	3	25	12.0	1.7	3	58	17	75	22.7	1.4	7
7:45-8:00	23	2	25	8.0	1.7	0	49	15	64	23.4	1.2	8
1時間計	93	7	100	7.0	6.9	4	233	63	296	21.3	5.4	34
8:00-8:15	28	1	29	3.4	2.0	0	61	11	72	15.3	1.3	4
8:15-8:30	26	4	30	13.3	2.1	0	98	10	108	9.3	2.0	4
8:30-8:45	19	6	25	24.0	1.7	0	80	9	89	10.1	1.6	3
8:45-9:00	25	2	27	7.4	1.9	1	72	16	88	18.2	1.6	2
1時間計	98	13	111	11.7	7.7	1	311	46	357	12.9	6.6	13
9:00-9:15	16	5	21	23.8	1.5	0	59	14	73	19.2	1.3	1
9:15-9:30	18	1	19	5.3	1.3	0	78	9	87	10.3	1.6	3
9:30-9:45	16	3	19	15.8	1.3	1	61	18	79	22.8	1.5	3
9:45-10:00	17	3	20	15.0	1.4	0	68	19	87	21.8	1.6	4
1時間計	67	12	79	15.2	5.5	1	266	60	326	18.4	6.0	11
10:00-10:15	28	2	30	6.7	2.1	0	56	14	70	20.0	1.3	1
10:15-10:30	24	1	25	4.0	1.7	0	81	6	87	6.9	1.6	0
10:30-10:45	20	5	25	20.0	1.7	0	67	21	88	23.9	1.6	1
10:45-11:00	19	2	21	9.5	1.5	0	59	9	68	13.2	1.3	2
1時間計	91	10	101	9.9	7.0	0	263	50	313	16.0	5.8	4
11:00-11:15	16	4	20	20.0	1.4	0	51	22	73	30.1	1.3	1
11:15-11:30	22	2	24	8.3	1.7	0	74	8	82	9.8	1.5	1
11:30-11:45	18	2	20	10.0	1.4	0	67	12	79	15.2	1.5	0
11:45-12:00	23	2	25	8.0	1.7	0	75	13	88	14.8	1.6	1
1時間計	79	10	89	11.2	6.2	0	267	55	322	17.1	5.9	3
12:00-12:15	23	1	24	4.2	1.7	1	75	19	94	20.2	1.7	1
12:15-12:30	25	3	28	10.7	1.9	2	51	17	68	25.0	1.3	3
12:30-12:45	7	1	8	12.5	0.6	0	54	14	68	20.6	1.3	1
12:45-13:00	15	1	16	6.3	1.1	2	43	10	53	18.9	1.0	1
1時間計	70	6	76	7.9	5.3	5	223	60	283	21.2	5.2	6
13:00-13:15	17	0	17	0.0	1.2	0	53	19	72	26.4	1.3	2
13:15-13:30	19	0	19	0.0	1.3	1	56	8	64	12.5	1.2	3
13:30-13:45	16	2	18	11.1	1.3	0	40	12	52	23.1	1.0	0
13:45-14:00	22	4	26	15.4	1.8	1	55	14	69	20.3	1.3	3
1時間計	74	6	80	7.5	5.6	2	204	53	257	20.6	4.7	8
14:00-14:15	18	1	19	5.3	1.3	0	72	11	83	13.3	1.5	1
14:15-14:30	14	2	16	12.5	1.1	0	59	8	67	11.9	1.2	1
14:30-14:45	9	1	10	10.0	0.7	0	70	13	83	15.7	1.5	3
14:45-15:00	13	1	14	7.1	1.0	2	79	15	94	16.0	1.7	2
1時間計	54	5	59	8.5	4.1	2	280	47	327	14.4	6.0	7

方向別自動車交通量調査表

調査地点：地域社会6 瀬谷中学校前

調査年月日：令和元年 5月14日(火) 天候：雨のち曇り



方向 種別 時間帯	1						2					
	小型車 (台)	大型車 (台)	合計 (台)	大型車 混入率 (%)	時間 係数 (%)	二輪車 (台)	小型車 (台)	大型車 (台)	合計 (台)	大型車 混入率 (%)	時間 係数 (%)	二輪車 (台)
15:00-15:15	21	0	21	0.0	1.5	1	69	9	78	11.5	1.4	4
15:15-15:30	19	1	20	5.0	1.4	0	73	8	81	9.9	1.5	3
15:30-15:45	19	1	20	5.0	1.4	0	75	10	85	11.8	1.6	2
15:45-16:00	31	0	31	0.0	2.2	0	89	9	98	9.2	1.8	2
1時間計	90	2	92	2.2	6.4	1	306	36	342	10.5	6.3	11
16:00-16:15	21	0	21	0.0	1.5	0	70	10	80	12.5	1.5	1
16:15-16:30	16	1	17	5.9	1.2	0	83	10	93	10.8	1.7	2
16:30-16:45	16	1	17	5.9	1.2	2	82	6	88	6.8	1.6	9
16:45-17:00	18	1	19	5.3	1.3	0	70	4	74	5.4	1.4	1
1時間計	71	3	74	4.1	5.1	2	305	30	335	9.0	6.2	13
17:00-17:15	20	2	22	9.1	1.5	0	66	6	72	8.3	1.3	2
17:15-17:30	28	2	30	6.7	2.1	0	91	8	99	8.1	1.8	2
17:30-17:45	38	3	41	7.3	2.8	0	94	6	100	6.0	1.8	7
17:45-18:00	23	4	27	14.8	1.9	1	76	2	78	2.6	1.4	6
1時間計	109	11	120	9.2	8.3	1	327	22	349	6.3	6.4	17
18:00-18:15	20	0	20	0.0	1.4	0	74	2	76	2.6	1.4	10
18:15-18:30	23	2	25	8.0	1.7	4	75	5	80	6.3	1.5	8
18:30-18:45	18	2	20	10.0	1.4	0	81	4	85	4.7	1.6	3
18:45-19:00	11	1	12	8.3	0.8	1	59	1	60	1.7	1.1	1
1時間計	72	5	77	6.5	5.3	5	289	12	301	4.0	5.5	22
昼12時間計	968	90	1058	8.5	73.5	24	3274	534	3808	14.0	70.1	149
19:00-19:15	27	0	27	0.0	1.9	1	79	4	83	4.8	1.5	4
19:15-19:30	17	1	18	5.6	1.3	0	71	2	73	2.7	1.3	7
19:30-19:45	31	1	32	3.1	2.2	0	79	1	80	1.3	1.5	5
19:45-20:00	17	0	17	0.0	1.2	1	44	1	45	2.2	0.8	6
1時間計	92	2	94	2.1	6.5	2	273	8	281	2.8	5.2	22
20:00-20:15	22	0	22	0.0	1.5	0	81	2	83	2.4	1.5	6
20:15-20:30	15	0	15	0.0	1.0	0	72	2	74	2.7	1.4	3
20:30-20:45	10	1	11	9.1	0.8	0	63	2	65	3.1	1.2	1
20:45-21:00	17	1	18	5.6	1.3	1	49	3	52	5.8	1.0	4
1時間計	64	2	66	3.0	4.6	1	265	9	274	3.3	5.0	14
21:00-21:15	13	0	13	0.0	0.9	0	55	2	57	3.5	1.0	1
21:15-21:30	17	2	19	10.5	1.3	1	65	1	66	1.5	1.2	3
21:30-21:45	13	2	15	13.3	1.0	1	40	3	43	7.0	0.8	1
21:45-22:00	11	0	11	0.0	0.8	0	35	7	42	16.7	0.8	1
1時間計	54	4	58	6.9	4.0	2	195	13	208	6.3	3.8	6
22:00-22:15	6	1	7	14.3	0.5	0	32	3	35	8.6	0.6	4
22:15-22:30	8	1	9	11.1	0.6	0	31	7	38	18.4	0.7	1
22:30-22:45	8	1	9	11.1	0.6	0	27	5	32	15.6	0.6	3
22:45-23:00	10	0	10	0.0	0.7	1	38	1	39	2.6	0.7	0
1時間計	32	3	35	8.6	2.4	1	128	16	144	11.1	2.6	8

方向別自動車交通量調査表

調査地点：地域社会6 瀬谷中学校前

調査年月日：令和元年 5月14日(火) 天候：雨のち曇り



方向 時間帯	1						2					
	種別 小型車 (台)	大型車 (台)	合計 (台)	大型車 混入率 (%)	時間 係数 (%)	二輪車 (台)	小型車 (台)	大型車 (台)	合計 (台)	大型車 混入率 (%)	時間 係数 (%)	二輪車 (台)
23:00-23:15	5	1	6	16.7	0.4	0	18	5	23	21.7	0.4	1
23:15-23:30	7	1	8	12.5	0.6	0	25	4	29	13.8	0.5	0
23:30-23:45	6	0	6	0.0	0.4	0	10	2	12	16.7	0.2	1
23:45-24:00	1	0	1	0.0	0.1	0	18	3	21	14.3	0.4	2
1時間計	19	2	21	9.5	1.5	0	71	14	85	16.5	1.6	4
0:00-0:15	6	0	6	0.0	0.4	0	13	2	15	13.3	0.3	0
0:15-0:30	7	0	7	0.0	0.5	0	18	3	21	14.3	0.4	2
0:30-0:45	0	0	0	0.0	0.0	0	20	3	23	13.0	0.4	1
0:45-1:00	3	0	3	0.0	0.2	0	14	5	19	26.3	0.3	1
1時間計	16	0	16	0.0	1.1	0	65	13	78	16.7	1.4	4
1:00-1:15	3	0	3	0.0	0.2	0	18	3	21	14.3	0.4	1
1:15-1:30	1	0	1	0.0	0.1	0	10	0	10	0.0	0.2	0
1:30-1:45	0	0	0	0.0	0.0	0	12	5	17	29.4	0.3	2
1:45-2:00	3	0	3	0.0	0.2	0	9	1	10	10.0	0.2	0
1時間計	7	0	7	0.0	0.5	0	49	9	58	15.5	1.1	3
2:00-2:15	1	0	1	0.0	0.1	0	7	1	8	12.5	0.1	0
2:15-2:30	0	0	0	0.0	0.0	0	2	2	4	50.0	0.1	0
2:30-2:45	0	1	1	100.0	0.1	0	3	2	5	40.0	0.1	0
2:45-3:00	0	0	0	0.0	0.0	0	9	5	14	35.7	0.3	1
1時間計	1	1	2	50.0	0.1	0	21	10	31	32.3	0.6	1
3:00-3:15	0	0	0	0.0	0.0	0	7	4	11	36.4	0.2	1
3:15-3:30	1	1	2	50.0	0.1	0	7	2	9	22.2	0.2	0
3:30-3:45	5	0	5	0.0	0.3	0	5	3	8	37.5	0.1	1
3:45-4:00	0	1	1	100.0	0.1	1	6	1	7	14.3	0.1	1
1時間計	6	2	8	25.0	0.6	1	25	10	35	28.6	0.6	3
4:00-4:15	1	0	1	0.0	0.1	0	7	2	9	22.2	0.2	2
4:15-4:30	0	0	0	0.0	0.0	0	15	5	20	25.0	0.4	0
4:30-4:45	1	0	1	0.0	0.1	0	13	2	15	13.3	0.3	1
4:45-5:00	4	1	5	20.0	0.3	0	10	7	17	41.2	0.3	2
1時間計	6	1	7	14.3	0.5	0	45	16	61	26.2	1.1	5
5:00-5:15	4	0	4	0.0	0.3	0	10	12	22	54.5	0.4	2
5:15-5:30	3	0	3	0.0	0.2	0	15	2	17	11.8	0.3	0
5:30-5:45	4	1	5	20.0	0.3	0	24	8	32	25.0	0.6	6
5:45-6:00	0	1	1	100.0	0.1	0	34	10	44	22.7	0.8	2
1時間計	11	2	13	15.4	0.9	0	83	32	115	27.8	2.1	10
6:00-6:15	11	0	11	0.0	0.8	1	35	11	46	23.9	0.8	5
6:15-6:30	12	1	13	7.7	0.9	0	47	12	59	20.3	1.1	5
6:30-6:45	12	3	15	20.0	1.0	2	54	9	63	14.3	1.2	10
6:45-7:00	15	1	16	6.3	1.1	1	73	15	88	17.0	1.6	4
1時間計	50	5	55	9.1	3.8	4	209	47	256	18.4	4.7	24
夜12時間計	358	24	382	6.3	26.5	11	1429	197	1626	12.1	29.9	104
全時間合計	1326	114	1440	7.9	100.0	35	4703	731	5434	13.5	100.0	253
昼夜率	1.37	1.27	1.36	-	-	1.46	1.44	1.37	1.43	-	-	1.70

方向別自動車交通量調査表

調査地点：地域社会6 瀬谷中学校前

調査年月日：令和元年 5月14日(火) 天候：雨のち曇り



時間帯	種別	3						A 合計 (1+2+3)					
		小型車 (台)	大型車 (台)	合計 (台)	大型車 混入率 (%)	時係 数 (%)	二輪車 (台)	小型車 (台)	大型車 (台)	合計 (台)	大型車 混入率 (%)	時係 数 (%)	二輪車 (台)
7:00-7:15		3	0	3	0.0	0.9	0	94	18	112	16.1	1.6	11
7:15-7:30		4	0	4	0.0	1.1	0	87	15	102	14.7	1.4	9
7:30-7:45		4	0	4	0.0	1.1	0	84	20	104	19.2	1.4	10
7:45-8:00		1	1	2	50.0	0.6	0	73	18	91	19.8	1.3	8
1時間計		12	1	13	7.7	3.7	0	338	71	409	17.4	5.7	38
8:00-8:15		9	1	10	10.0	2.8	1	98	13	111	11.7	1.5	5
8:15-8:30		3	1	4	25.0	1.1	0	127	15	142	10.6	2.0	4
8:30-8:45		3	0	3	0.0	0.9	0	102	15	117	12.8	1.6	3
8:45-9:00		2	0	2	0.0	0.6	0	99	18	117	15.4	1.6	3
1時間計		17	2	19	10.5	5.4	1	426	61	487	12.5	6.7	15
9:00-9:15		3	0	3	0.0	0.9	0	78	19	97	19.6	1.3	1
9:15-9:30		4	1	5	20.0	1.4	0	100	11	111	9.9	1.5	3
9:30-9:45		2	0	2	0.0	0.6	0	79	21	100	21.0	1.4	4
9:45-10:00		2	2	4	50.0	1.1	1	87	24	111	21.6	1.5	5
1時間計		11	3	14	21.4	4.0	1	344	75	419	17.9	5.8	13
10:00-10:15		3	0	3	0.0	0.9	0	87	16	103	15.5	1.4	1
10:15-10:30		4	1	5	20.0	1.4	0	109	8	117	6.8	1.6	0
10:30-10:45		4	1	5	20.0	1.4	0	91	27	118	22.9	1.6	1
10:45-11:00		4	0	4	0.0	1.1	0	82	11	93	11.8	1.3	2
1時間計		15	2	17	11.8	4.8	0	369	62	431	14.4	6.0	4
11:00-11:15		6	0	6	0.0	1.7	0	73	26	99	26.3	1.4	1
11:15-11:30		4	0	4	0.0	1.1	0	100	10	110	9.1	1.5	1
11:30-11:45		4	0	4	0.0	1.1	0	89	14	103	13.6	1.4	0
11:45-12:00		1	0	1	0.0	0.3	0	99	15	114	13.2	1.6	1
1時間計		15	0	15	0.0	4.3	0	361	65	426	15.3	5.9	3
12:00-12:15		5	0	5	0.0	1.4	0	103	20	123	16.3	1.7	2
12:15-12:30		7	0	7	0.0	2.0	0	83	20	103	19.4	1.4	5
12:30-12:45		4	0	4	0.0	1.1	0	65	15	80	18.8	1.1	1
12:45-13:00		4	0	4	0.0	1.1	0	62	11	73	15.1	1.0	3
1時間計		20	0	20	0.0	5.7	0	313	66	379	17.4	5.2	11
13:00-13:15		3	0	3	0.0	0.9	0	73	19	92	20.7	1.3	2
13:15-13:30		5	0	5	0.0	1.4	0	80	8	88	9.1	1.2	4
13:30-13:45		4	0	4	0.0	1.1	0	60	14	74	18.9	1.0	0
13:45-14:00		11	2	13	15.4	3.7	0	88	20	108	18.5	1.5	4
1時間計		23	2	25	8.0	7.1	0	301	61	362	16.9	5.0	10
14:00-14:15		4	1	5	20.0	1.4	0	94	13	107	12.1	1.5	1
14:15-14:30		7	0	7	0.0	2.0	0	80	10	90	11.1	1.2	1
14:30-14:45		8	1	9	11.1	2.6	0	87	15	102	14.7	1.4	3
14:45-15:00		5	1	6	16.7	1.7	0	97	17	114	14.9	1.6	4
1時間計		24	3	27	11.1	7.7	0	358	55	413	13.3	5.7	9

方向別自動車交通量調査表

調査地点：地域社会6 瀬谷中学校前

調査年月日：令和元年 5月14日(火) 天候：雨のち曇り



方向 種別 時間帯	3						A 合計 (1+2+3)					
	小型車 (台)	大型車 (台)	合計 (台)	大型車 混入率 (%)	時 間 係 数 (%)	二輪車 (台)	小型車 (台)	大型車 (台)	合計 (台)	大型車 混入率 (%)	時 間 係 数 (%)	二輪車 (台)
15:00-15:15	3	0	3	0.0	0.9	0	93	9	102	8.8	1.4	5
15:15-15:30	7	0	7	0.0	2.0	0	99	9	108	8.3	1.5	3
15:30-15:45	11	1	12	8.3	3.4	0	105	12	117	10.3	1.6	2
15:45-16:00	7	1	8	12.5	2.3	0	127	10	137	7.3	1.9	2
1時間計	28	2	30	6.7	8.5	0	424	40	464	8.6	6.4	12
16:00-16:15	11	1	12	8.3	3.4	0	102	11	113	9.7	1.6	1
16:15-16:30	7	0	7	0.0	2.0	0	106	11	117	9.4	1.6	2
16:30-16:45	11	0	11	0.0	3.1	0	109	7	116	6.0	1.6	11
16:45-17:00	1	0	1	0.0	0.3	0	89	5	94	5.3	1.3	1
1時間計	30	1	31	3.2	8.8	0	406	34	440	7.7	6.1	15
17:00-17:15	4	0	4	0.0	1.1	0	90	8	98	8.2	1.4	2
17:15-17:30	12	0	12	0.0	3.4	1	131	10	141	7.1	2.0	3
17:30-17:45	7	0	7	0.0	2.0	1	139	9	148	6.1	2.0	8
17:45-18:00	5	0	5	0.0	1.4	0	104	6	110	5.5	1.5	7
1時間計	28	0	28	0.0	8.0	2	464	33	497	6.6	6.9	20
18:00-18:15	8	0	8	0.0	2.3	2	102	2	104	1.9	1.4	12
18:15-18:30	9	0	9	0.0	2.6	0	107	7	114	6.1	1.6	12
18:30-18:45	10	0	10	0.0	2.8	0	109	6	115	5.2	1.6	3
18:45-19:00	7	0	7	0.0	2.0	0	77	2	79	2.5	1.1	2
1時間計	34	0	34	0.0	9.7	2	395	17	412	4.1	5.7	29
昼12時間計	257	16	273	5.9	77.8	6	4499	640	5139	12.5	71.1	179
19:00-19:15	4	0	4	0.0	1.1	0	110	4	114	3.5	1.6	5
19:15-19:30	6	0	6	0.0	1.7	1	94	3	97	3.1	1.3	8
19:30-19:45	5	0	5	0.0	1.4	0	115	2	117	1.7	1.6	5
19:45-20:00	2	1	3	33.3	0.9	0	63	2	65	3.1	0.9	7
1時間計	17	1	18	5.6	5.1	1	382	11	393	2.8	5.4	25
20:00-20:15	4	1	5	20.0	1.4	1	107	3	110	2.7	1.5	7
20:15-20:30	7	1	8	12.5	2.3	1	94	3	97	3.1	1.3	4
20:30-20:45	2	0	2	0.0	0.6	0	75	3	78	3.8	1.1	1
20:45-21:00	2	0	2	0.0	0.6	0	68	4	72	5.6	1.0	5
1時間計	15	2	17	11.8	4.8	2	344	13	357	3.6	4.9	17
21:00-21:15	1	0	1	0.0	0.3	0	69	2	71	2.8	1.0	1
21:15-21:30	4	0	4	0.0	1.1	0	86	3	89	3.4	1.2	4
21:30-21:45	10	0	10	0.0	2.8	0	63	5	68	7.4	0.9	2
21:45-22:00	3	0	3	0.0	0.9	1	49	7	56	12.5	0.8	2
1時間計	18	0	18	0.0	5.1	1	267	17	284	6.0	3.9	9
22:00-22:15	0	0	0	0.0	0.0	0	38	4	42	9.5	0.6	4
22:15-22:30	4	0	4	0.0	1.1	0	43	8	51	15.7	0.7	1
22:30-22:45	3	0	3	0.0	0.9	1	38	6	44	13.6	0.6	4
22:45-23:00	0	0	0	0.0	0.0	0	48	1	49	2.0	0.7	1
1時間計	7	0	7	0.0	2.0	1	167	19	186	10.2	2.6	10

方向別自動車交通量調査表

調査地点：地域社会6 瀬谷中学校前

調査年月日：令和元年 5月14日(火) 天候：雨のち曇り



時間帯	3						A 合計 (1+2+3)						
	種別	小型車 (台)	大型車 (台)	合計 (台)	大型車 混入率 (%)	時係 数 (%)	二輪車 (台)	小型車 (台)	大型車 (台)	合計 (台)	大型車 混入率 (%)	時係 数 (%)	二輪車 (台)
23:00-23:15		1	0	1	0.0	0.3	0	24	6	30	20.0	0.4	1
23:15-23:30		2	0	2	0.0	0.6	0	34	5	39	12.8	0.5	0
23:30-23:45		1	0	1	0.0	0.3	0	17	2	19	10.5	0.3	1
23:45-24:00		0	0	0	0.0	0.0	0	19	3	22	13.6	0.3	2
1時間計		4	0	4	0.0	1.1	0	94	16	110	14.5	1.5	4
0:00-0:15		0	0	0	0.0	0.0	0	19	2	21	9.5	0.3	0
0:15-0:30		2	0	2	0.0	0.6	0	27	3	30	10.0	0.4	2
0:30-0:45		1	0	1	0.0	0.3	0	21	3	24	12.5	0.3	1
0:45-1:00		0	0	0	0.0	0.0	0	17	5	22	22.7	0.3	1
1時間計		3	0	3	0.0	0.9	0	84	13	97	13.4	1.3	4
1:00-1:15		0	0	0	0.0	0.0	0	21	3	24	12.5	0.3	1
1:15-1:30		1	0	1	0.0	0.3	0	12	0	12	0.0	0.2	0
1:30-1:45		0	0	0	0.0	0.0	1	12	5	17	29.4	0.2	3
1:45-2:00		0	0	0	0.0	0.0	0	12	1	13	7.7	0.2	0
1時間計		1	0	1	0.0	0.3	1	57	9	66	13.6	0.9	4
2:00-2:15		1	0	1	0.0	0.3	0	9	1	10	10.0	0.1	0
2:15-2:30		0	0	0	0.0	0.0	0	2	2	4	50.0	0.1	0
2:30-2:45		0	0	0	0.0	0.0	0	3	3	6	50.0	0.1	0
2:45-3:00		0	1	1	100.0	0.3	0	9	6	15	40.0	0.2	1
1時間計		1	1	2	50.0	0.6	0	23	12	35	34.3	0.5	1
3:00-3:15		0	0	0	0.0	0.0	0	7	4	11	36.4	0.2	1
3:15-3:30		0	0	0	0.0	0.0	0	8	3	11	27.3	0.2	0
3:30-3:45		0	0	0	0.0	0.0	0	10	3	13	23.1	0.2	1
3:45-4:00		0	0	0	0.0	0.0	0	6	2	8	25.0	0.1	2
1時間計		0	0	0	0.0	0.0	0	31	12	43	27.9	0.6	4
4:00-4:15		0	0	0	0.0	0.0	0	8	2	10	20.0	0.1	2
4:15-4:30		0	0	0	0.0	0.0	0	15	5	20	25.0	0.3	0
4:30-4:45		0	0	0	0.0	0.0	0	14	2	16	12.5	0.2	1
4:45-5:00		0	0	0	0.0	0.0	0	14	8	22	36.4	0.3	2
1時間計		0	0	0	0.0	0.0	0	51	17	68	25.0	0.9	5
5:00-5:15		0	0	0	0.0	0.0	0	14	12	26	46.2	0.4	2
5:15-5:30		0	0	0	0.0	0.0	0	18	2	20	10.0	0.3	0
5:30-5:45		1	0	1	0.0	0.3	0	29	9	38	23.7	0.5	6
5:45-6:00		1	0	1	0.0	0.3	0	35	11	46	23.9	0.6	2
1時間計		2	0	2	0.0	0.6	0	96	34	130	26.2	1.8	10
6:00-6:15		3	0	3	0.0	0.9	0	49	11	60	18.3	0.8	6
6:15-6:30		0	0	0	0.0	0.0	0	59	13	72	18.1	1.0	5
6:30-6:45		1	0	1	0.0	0.3	0	67	12	79	15.2	1.1	12
6:45-7:00		2	0	2	0.0	0.6	0	90	16	106	15.1	1.5	5
1時間計		6	0	6	0.0	1.7	0	265	52	317	16.4	4.4	28
夜12時間計		74	4	78	5.1	22.2	6	1861	225	2086	10.8	28.9	121
全時間合計		331	20	351	5.7	100.0	12	6360	865	7225	12.0	100.0	300
昼夜率		1.29	1.25	1.29	-	-	2.00	1.41	1.35	1.41	-	-	1.68

方向別自動車交通量調査表

調査地点：地域社会6 瀬谷中学校前

調査年月日：令和元年 5月14日(火) 天候：雨のち曇り



方向 時間帯	4						5					
	種別 小型車 (台)	大型車 (台)	合計 (台)	大型車 混入率 (%)	時係 数 (%)	二輪車 (台)	小型車 (台)	大型車 (台)	合計 (台)	大型車 混入率 (%)	時係 数 (%)	二輪車 (台)
7:00-7:15	3	0	3	0.0	1.1	0	79	4	83	4.8	2.2	5
7:15-7:30	0	0	0	0.0	0.0	0	74	5	79	6.3	2.1	2
7:30-7:45	7	0	7	0.0	2.5	0	91	4	95	4.2	2.5	1
7:45-8:00	4	0	4	0.0	1.4	0	78	5	83	6.0	2.2	2
1時間計	14	0	14	0.0	5.0	0	322	18	340	5.3	8.9	10
8:00-8:15	4	0	4	0.0	1.4	0	78	8	86	9.3	2.3	1
8:15-8:30	10	0	10	0.0	3.5	0	81	5	86	5.8	2.3	1
8:30-8:45	5	2	7	28.6	2.5	0	75	5	80	6.3	2.1	1
8:45-9:00	3	0	3	0.0	1.1	0	60	7	67	10.4	1.8	0
1時間計	22	2	24	8.3	8.5	0	294	25	319	7.8	8.4	3
9:00-9:15	5	2	7	28.6	2.5	0	57	9	66	13.6	1.7	1
9:15-9:30	3	0	3	0.0	1.1	1	53	6	59	10.2	1.5	3
9:30-9:45	6	1	7	14.3	2.5	0	49	9	58	15.5	1.5	1
9:45-10:00	4	0	4	0.0	1.4	0	46	5	51	9.8	1.3	0
1時間計	18	3	21	14.3	7.4	1	205	29	234	12.4	6.1	5
10:00-10:15	2	1	3	33.3	1.1	0	47	6	53	11.3	1.4	3
10:15-10:30	4	1	5	20.0	1.8	0	31	3	34	8.8	0.9	0
10:30-10:45	4	0	4	0.0	1.4	0	31	1	32	3.1	0.8	1
10:45-11:00	5	1	6	16.7	2.1	0	56	4	60	6.7	1.6	0
1時間計	15	3	18	16.7	6.4	0	165	14	179	7.8	4.7	4
11:00-11:15	1	0	1	0.0	0.4	0	35	5	40	12.5	1.0	3
11:15-11:30	3	0	3	0.0	1.1	0	44	3	47	6.4	1.2	1
11:30-11:45	6	0	6	0.0	2.1	0	31	2	33	6.1	0.9	1
11:45-12:00	1	1	2	50.0	0.7	0	29	1	30	3.3	0.8	2
1時間計	11	1	12	8.3	4.3	0	139	11	150	7.3	3.9	7
12:00-12:15	1	0	1	0.0	0.4	0	39	4	43	9.3	1.1	2
12:15-12:30	5	1	6	16.7	2.1	0	30	2	32	6.3	0.8	1
12:30-12:45	3	0	3	0.0	1.1	1	36	4	40	10.0	1.0	1
12:45-13:00	2	0	2	0.0	0.7	0	19	1	20	5.0	0.5	0
1時間計	11	1	12	8.3	4.3	1	124	11	135	8.1	3.5	4
13:00-13:15	5	0	5	0.0	1.8	0	30	2	32	6.3	0.8	1
13:15-13:30	3	0	3	0.0	1.1	0	40	4	44	9.1	1.2	0
13:30-13:45	0	0	0	0.0	0.0	0	48	5	53	9.4	1.4	1
13:45-14:00	3	0	3	0.0	1.1	0	47	3	50	6.0	1.3	4
1時間計	11	0	11	0.0	3.9	0	165	14	179	7.8	4.7	6
14:00-14:15	6	0	6	0.0	2.1	0	44	2	46	4.3	1.2	1
14:15-14:30	7	0	7	0.0	2.5	0	47	2	49	4.1	1.3	2
14:30-14:45	10	0	10	0.0	3.5	0	44	3	47	6.4	1.2	3
14:45-15:00	3	0	3	0.0	1.1	0	40	3	43	7.0	1.1	0
1時間計	26	0	26	0.0	9.2	0	175	10	185	5.4	4.9	6

方向別自動車交通量調査表

調査地点：地域社会6 瀬谷中学校前

調査年月日：令和元年 5月14日(火) 天候：雨のち曇り



方向 種別 時間帯	4						5					
	小型車 (台)	大型車 (台)	合計 (台)	大型車 混入率 (%)	時間 係数 (%)	二輪車 (台)	小型車 (台)	大型車 (台)	合計 (台)	大型車 混入率 (%)	時間 係数 (%)	二輪車 (台)
15:00-15:15	5	0	5	0.0	1.8	0	40	2	42	4.8	1.1	3
15:15-15:30	4	0	4	0.0	1.4	0	49	3	52	5.8	1.4	3
15:30-15:45	4	1	5	20.0	1.8	0	41	3	44	6.8	1.2	0
15:45-16:00	6	0	6	0.0	2.1	0	47	3	50	6.0	1.3	1
1時間計	19	1	20	5.0	7.1	0	177	11	188	5.9	4.9	7
16:00-16:15	6	0	6	0.0	2.1	0	60	5	65	7.7	1.7	0
16:15-16:30	9	0	9	0.0	3.2	0	59	6	65	9.2	1.7	2
16:30-16:45	4	2	6	33.3	2.1	1	54	2	56	3.6	1.5	2
16:45-17:00	6	0	6	0.0	2.1	0	51	1	52	1.9	1.4	2
1時間計	25	2	27	7.4	9.6	1	224	14	238	5.9	6.2	6
17:00-17:15	7	0	7	0.0	2.5	0	64	3	67	4.5	1.8	3
17:15-17:30	7	0	7	0.0	2.5	0	74	5	79	6.3	2.1	4
17:30-17:45	5	0	5	0.0	1.8	0	63	2	65	3.1	1.7	8
17:45-18:00	2	0	2	0.0	0.7	0	85	3	88	3.4	2.3	3
1時間計	21	0	21	0.0	7.4	0	286	13	299	4.3	7.8	18
18:00-18:15	6	0	6	0.0	2.1	0	65	0	65	0.0	1.7	5
18:15-18:30	8	1	9	11.1	3.2	0	68	1	69	1.4	1.8	3
18:30-18:45	2	0	2	0.0	0.7	0	84	3	87	3.4	2.3	8
18:45-19:00	3	1	4	25.0	1.4	0	73	3	76	3.9	2.0	3
1時間計	19	2	21	9.5	7.4	0	290	7	297	2.4	7.8	19
昼12時間計	212	15	227	6.6	80.5	3	2566	177	2743	6.5	71.9	95
19:00-19:15	7	1	8	12.5	2.8	0	48	1	49	2.0	1.3	4
19:15-19:30	4	0	4	0.0	1.4	0	58	2	60	3.3	1.6	2
19:30-19:45	4	0	4	0.0	1.4	0	59	1	60	1.7	1.6	4
19:45-20:00	1	0	1	0.0	0.4	0	34	2	36	5.6	0.9	2
1時間計	16	1	17	5.9	6.0	0	199	6	205	2.9	5.4	12
20:00-20:15	1	0	1	0.0	0.4	0	35	2	37	5.4	1.0	0
20:15-20:30	3	0	3	0.0	1.1	1	53	2	55	3.6	1.4	1
20:30-20:45	3	0	3	0.0	1.1	0	44	2	46	4.3	1.2	2
20:45-21:00	0	0	0	0.0	0.0	0	40	0	40	0.0	1.0	0
1時間計	7	0	7	0.0	2.5	1	172	6	178	3.4	4.7	3
21:00-21:15	1	0	1	0.0	0.4	0	30	1	31	3.2	0.8	0
21:15-21:30	1	0	1	0.0	0.4	0	20	0	20	0.0	0.5	0
21:30-21:45	6	0	6	0.0	2.1	0	41	3	44	6.8	1.2	4
21:45-22:00	2	0	2	0.0	0.7	0	37	0	37	0.0	1.0	2
1時間計	10	0	10	0.0	3.5	0	128	4	132	3.0	3.5	6
22:00-22:15	1	0	1	0.0	0.4	0	40	1	41	2.4	1.1	1
22:15-22:30	1	0	1	0.0	0.4	0	22	0	22	0.0	0.6	1
22:30-22:45	1	0	1	0.0	0.4	0	20	1	21	4.8	0.6	1
22:45-23:00	0	0	0	0.0	0.0	0	16	1	17	5.9	0.4	2
1時間計	3	0	3	0.0	1.1	0	98	3	101	3.0	2.6	5

方向別自動車交通量調査表

調査地点：地域社会6 瀬谷中学校前

調査年月日：令和元年 5月14日(火) 天候：雨のち曇り



方向	4						5						
	種別	小型車 (台)	大型車 (台)	合計 (台)	大型車 混入率 (%)	時間 係数 (%)	二輪車 (台)	小型車 (台)	大型車 (台)	合計 (台)	大型車 混入率 (%)	時間 係数 (%)	二輪車 (台)
23:00-23:15		0	0	0	0.0	0.0	0	15	0	15	0.0	0.4	0
23:15-23:30		0	0	0	0.0	0.0	0	14	0	14	0.0	0.4	0
23:30-23:45		1	0	1	0.0	0.4	0	13	0	13	0.0	0.3	0
23:45-24:00		0	0	0	0.0	0.0	0	8	0	8	0.0	0.2	1
1時間計		1	0	1	0.0	0.4	0	50	0	50	0.0	1.3	1
0:00-0:15		0	0	0	0.0	0.0	0	9	1	10	10.0	0.3	0
0:15-0:30		0	0	0	0.0	0.0	0	6	0	6	0.0	0.2	0
0:30-0:45		0	0	0	0.0	0.0	0	9	0	9	0.0	0.2	0
0:45-1:00		1	0	1	0.0	0.4	0	4	0	4	0.0	0.1	1
1時間計		1	0	1	0.0	0.4	0	28	1	29	3.4	0.8	1
1:00-1:15		0	0	0	0.0	0.0	0	3	0	3	0.0	0.1	2
1:15-1:30		0	0	0	0.0	0.0	0	1	0	1	0.0	0.0	1
1:30-1:45		0	0	0	0.0	0.0	0	4	0	4	0.0	0.1	0
1:45-2:00		0	0	0	0.0	0.0	0	2	1	3	33.3	0.1	0
1時間計		0	0	0	0.0	0.0	0	10	1	11	9.1	0.3	3
2:00-2:15		0	0	0	0.0	0.0	0	4	0	4	0.0	0.1	1
2:15-2:30		0	0	0	0.0	0.0	0	2	0	2	0.0	0.1	0
2:30-2:45		0	0	0	0.0	0.0	0	2	0	2	0.0	0.1	1
2:45-3:00		0	0	0	0.0	0.0	0	1	0	1	0.0	0.0	1
1時間計		0	0	0	0.0	0.0	0	9	0	9	0.0	0.2	3
3:00-3:15		0	0	0	0.0	0.0	0	3	0	3	0.0	0.1	2
3:15-3:30		0	0	0	0.0	0.0	0	2	1	3	33.3	0.1	0
3:30-3:45		0	0	0	0.0	0.0	0	3	0	3	0.0	0.1	0
3:45-4:00		0	0	0	0.0	0.0	0	7	0	7	0.0	0.2	1
1時間計		0	0	0	0.0	0.0	0	15	1	16	6.3	0.4	3
4:00-4:15		0	0	0	0.0	0.0	0	7	0	7	0.0	0.2	0
4:15-4:30		1	0	1	0.0	0.4	0	4	0	4	0.0	0.1	0
4:30-4:45		0	1	1	100.0	0.4	0	9	0	9	0.0	0.2	1
4:45-5:00		0	0	0	0.0	0.0	0	8	0	8	0.0	0.2	1
1時間計		1	1	2	50.0	0.7	0	28	0	28	0.0	0.7	2
5:00-5:15		1	0	1	0.0	0.4	0	12	0	12	0.0	0.3	2
5:15-5:30		2	0	2	0.0	0.7	0	18	0	18	0.0	0.5	1
5:30-5:45		2	0	2	0.0	0.7	0	20	1	21	4.8	0.6	1
5:45-6:00		3	0	3	0.0	1.1	0	34	3	37	8.1	1.0	2
1時間計		8	0	8	0.0	2.8	0	84	4	88	4.5	2.3	6
6:00-6:15		1	0	1	0.0	0.4	1	40	3	43	7.0	1.1	2
6:15-6:30		3	0	3	0.0	1.1	0	57	0	57	0.0	1.5	0
6:30-6:45		1	0	1	0.0	0.4	0	58	2	60	3.3	1.6	4
6:45-7:00		1	0	1	0.0	0.4	0	60	3	63	4.8	1.7	2
1時間計		6	0	6	0.0	2.1	1	215	8	223	3.6	5.8	8
夜12時間計		53	2	55	3.6	19.5	2	1036	34	1070	3.2	28.1	53
全時間合計		265	17	282	6.0	100.0	5	3602	211	3813	5.5	100.0	148
昼夜率		1.25	1.13	1.24	-	-	1.67	1.40	1.19	1.39	-	-	1.56

方向別自動車交通量調査表

調査地点：地域社会6 瀬谷中学校前

調査年月日：令和元年 5月14日(火) 天候：雨のち曇り



方向	6						B 合計 (4+5+6)						
	種別	小型車 (台)	大型車 (台)	合計 (台)	大型車 混入率 (%)	時間 係数 (%)	二輪車 (台)	小型車 (台)	大型車 (台)	合計 (台)	大型車 混入率 (%)	時間 係数 (%)	二輪車 (台)
7:00-7:15		51	4	55	7.3	1.8	6	133	8	141	5.7	2.0	11
7:15-7:30		42	3	45	6.7	1.5	0	116	8	124	6.5	1.7	2
7:30-7:45		37	6	43	14.0	1.4	2	135	10	145	6.9	2.0	3
7:45-8:00		38	2	40	5.0	1.3	2	120	7	127	5.5	1.8	4
1時間計		168	15	183	8.2	6.1	10	504	33	537	6.1	7.6	20
8:00-8:15		59	1	60	1.7	2.0	3	141	9	150	6.0	2.1	4
8:15-8:30		70	2	72	2.8	2.4	4	161	7	168	4.2	2.4	5
8:30-8:45		57	8	65	12.3	2.2	1	137	15	152	9.9	2.1	2
8:45-9:00		49	4	53	7.5	1.8	1	112	11	123	8.9	1.7	1
1時間計		235	15	250	6.0	8.4	9	551	42	593	7.1	8.4	12
9:00-9:15		40	3	43	7.0	1.4	2	102	14	116	12.1	1.6	3
9:15-9:30		42	6	48	12.5	1.6	2	98	12	110	10.9	1.6	6
9:30-9:45		38	2	40	5.0	1.3	0	93	12	105	11.4	1.5	1
9:45-10:00		31	3	34	8.8	1.1	1	81	8	89	9.0	1.3	1
1時間計		151	14	165	8.5	5.5	5	374	46	420	11.0	5.9	11
10:00-10:15		41	7	48	14.6	1.6	0	90	14	104	13.5	1.5	3
10:15-10:30		33	6	39	15.4	1.3	0	68	10	78	12.8	1.1	0
10:30-10:45		37	3	40	7.5	1.3	1	72	4	76	5.3	1.1	2
10:45-11:00		43	6	49	12.2	1.6	0	104	11	115	9.6	1.6	0
1時間計		154	22	176	12.5	5.9	1	334	39	373	10.5	5.3	5
11:00-11:15		29	3	32	9.4	1.1	0	65	8	73	11.0	1.0	3
11:15-11:30		36	4	40	10.0	1.3	2	83	7	90	7.8	1.3	3
11:30-11:45		26	3	29	10.3	1.0	0	63	5	68	7.4	1.0	1
11:45-12:00		34	3	37	8.1	1.2	1	64	5	69	7.2	1.0	3
1時間計		125	13	138	9.4	4.6	3	275	25	300	8.3	4.2	10
12:00-12:15		26	4	30	13.3	1.0	0	66	8	74	10.8	1.0	2
12:15-12:30		30	2	32	6.3	1.1	2	65	5	70	7.1	1.0	3
12:30-12:45		33	2	35	5.7	1.2	0	72	6	78	7.7	1.1	2
12:45-13:00		29	4	33	12.1	1.1	1	50	5	55	9.1	0.8	1
1時間計		118	12	130	9.2	4.3	3	253	24	277	8.7	3.9	8
13:00-13:15		17	1	18	5.6	0.6	0	52	3	55	5.5	0.8	1
13:15-13:30		26	1	27	3.7	0.9	0	69	5	74	6.8	1.0	0
13:30-13:45		29	2	31	6.5	1.0	0	77	7	84	8.3	1.2	1
13:45-14:00		28	2	30	6.7	1.0	0	78	5	83	6.0	1.2	4
1時間計		100	6	106	5.7	3.5	0	276	20	296	6.8	4.2	6
14:00-14:15		39	2	41	4.9	1.4	2	89	4	93	4.3	1.3	3
14:15-14:30		45	2	47	4.3	1.6	1	99	4	103	3.9	1.5	3
14:30-14:45		50	2	52	3.8	1.7	1	104	5	109	4.6	1.5	4
14:45-15:00		48	1	49	2.0	1.6	0	91	4	95	4.2	1.3	0
1時間計		182	7	189	3.7	6.3	4	383	17	400	4.3	5.6	10

方向別自動車交通量調査表

調査地点：地域社会6 瀬谷中学校前

調査年月日：令和元年 5月14日(火) 天候：雨のち曇り



方向 時間帯	6						B 合計 (4+ 5+ 6)					
	種別 小型車 (台)	大型車 (台)	合計 (台)	大型車 混入率 (%)	時係 数 (%)	二輪車 (台)	小型車 (台)	大型車 (台)	合計 (台)	大型車 混入率 (%)	時係 数 (%)	二輪車 (台)
15:00-15:15	30	2	32	6.3	1.1	1	75	4	79	5.1	1.1	4
15:15-15:30	34	3	37	8.1	1.2	1	87	6	93	6.5	1.3	4
15:30-15:45	39	3	42	7.1	1.4	5	84	7	91	7.7	1.3	5
15:45-16:00	42	5	47	10.6	1.6	3	95	8	103	7.8	1.5	4
1時間計	145	13	158	8.2	5.3	10	341	25	366	6.8	5.2	17
16:00-16:15	45	0	45	0.0	1.5	1	111	5	116	4.3	1.6	1
16:15-16:30	48	7	55	12.7	1.8	3	116	13	129	10.1	1.8	5
16:30-16:45	41	0	41	0.0	1.4	2	99	4	103	3.9	1.5	5
16:45-17:00	54	0	54	0.0	1.8	2	111	1	112	0.9	1.6	4
1時間計	188	7	195	3.6	6.5	8	437	23	460	5.0	6.5	15
17:00-17:15	54	4	58	6.9	1.9	2	125	7	132	5.3	1.9	5
17:15-17:30	76	0	76	0.0	2.5	2	157	5	162	3.1	2.3	6
17:30-17:45	62	0	62	0.0	2.1	3	130	2	132	1.5	1.9	11
17:45-18:00	56	3	59	5.1	2.0	1	143	6	149	4.0	2.1	4
1時間計	248	7	255	2.7	8.5	8	555	20	575	3.5	8.1	26
18:00-18:15	48	6	54	11.1	1.8	6	119	6	125	4.8	1.8	11
18:15-18:30	49	3	52	5.8	1.7	2	125	5	130	3.8	1.8	5
18:30-18:45	50	3	53	5.7	1.8	4	136	6	142	4.2	2.0	12
18:45-19:00	41	0	41	0.0	1.4	1	117	4	121	3.3	1.7	4
1時間計	188	12	200	6.0	6.7	13	497	21	518	4.1	7.3	32
昼12時間計	2002	143	2145	6.7	71.7	74	4780	335	5115	6.5	72.2	172
19:00-19:15	44	5	49	10.2	1.6	3	99	7	106	6.6	1.5	7
19:15-19:30	45	5	50	10.0	1.7	0	107	7	114	6.1	1.6	2
19:30-19:45	27	2	29	6.9	1.0	2	90	3	93	3.2	1.3	6
19:45-20:00	46	1	47	2.1	1.6	0	81	3	84	3.6	1.2	2
1時間計	162	13	175	7.4	5.8	5	377	20	397	5.0	5.6	17
20:00-20:15	34	1	35	2.9	1.2	3	70	3	73	4.1	1.0	3
20:15-20:30	41	1	42	2.4	1.4	1	97	3	100	3.0	1.4	3
20:30-20:45	21	3	24	12.5	0.8	0	68	5	73	6.8	1.0	2
20:45-21:00	17	0	17	0.0	0.6	1	57	0	57	0.0	0.8	1
1時間計	113	5	118	4.2	3.9	5	292	11	303	3.6	4.3	9
21:00-21:15	22	0	22	0.0	0.7	1	53	1	54	1.9	0.8	1
21:15-21:30	22	2	24	8.3	0.8	0	43	2	45	4.4	0.6	0
21:30-21:45	24	1	25	4.0	0.8	0	71	4	75	5.3	1.1	4
21:45-22:00	28	1	29	3.4	1.0	4	67	1	68	1.5	1.0	6
1時間計	96	4	100	4.0	3.3	5	234	8	242	3.3	3.4	11
22:00-22:15	20	0	20	0.0	0.7	0	61	1	62	1.6	0.9	1
22:15-22:30	20	2	22	9.1	0.7	0	43	2	45	4.4	0.6	1
22:30-22:45	18	0	18	0.0	0.6	1	39	1	40	2.5	0.6	2
22:45-23:00	5	0	5	0.0	0.2	2	21	1	22	4.5	0.3	4
1時間計	63	2	65	3.1	2.2	3	164	5	169	3.0	2.4	8

方向別自動車交通量調査表

調査地点：地域社会6 瀬谷中学校前

調査年月日：令和元年 5月14日(火) 天候：雨のち曇り



方向	6						B 合計 (4+5+6)						
	種別	小型車 (台)	大型車 (台)	合計 (台)	大型車 混入率 (%)	時間 係数 (%)	二輪車 (台)	小型車 (台)	大型車 (台)	合計 (台)	大型車 混入率 (%)	時間 係数 (%)	二輪車 (台)
23:00-23:15		12	1	13	7.7	0.4	0	27	1	28	3.6	0.4	0
23:15-23:30		6	0	6	0.0	0.2	0	20	0	20	0.0	0.3	0
23:30-23:45		11	0	11	0.0	0.4	0	25	0	25	0.0	0.4	0
23:45-24:00		4	0	4	0.0	0.1	1	12	0	12	0.0	0.2	2
1時間計		33	1	34	2.9	1.1	1	84	1	85	1.2	1.2	2
0:00-0:15		6	1	7	14.3	0.2	0	15	2	17	11.8	0.2	0
0:15-0:30		4	0	4	0.0	0.1	0	10	0	10	0.0	0.1	0
0:30-0:45		5	0	5	0.0	0.2	0	14	0	14	0.0	0.2	0
0:45-1:00		2	0	2	0.0	0.1	1	7	0	7	0.0	0.1	2
1時間計		17	1	18	5.6	0.6	1	46	2	48	4.2	0.7	2
1:00-1:15		3	0	3	0.0	0.1	1	6	0	6	0.0	0.1	3
1:15-1:30		4	1	5	20.0	0.2	0	5	1	6	16.7	0.1	1
1:30-1:45		3	0	3	0.0	0.1	0	7	0	7	0.0	0.1	0
1:45-2:00		4	0	4	0.0	0.1	1	6	1	7	14.3	0.1	1
1時間計		14	1	15	6.7	0.5	2	24	2	26	7.7	0.4	5
2:00-2:15		0	0	0	0.0	0.0	0	4	0	4	0.0	0.1	1
2:15-2:30		3	0	3	0.0	0.1	0	5	0	5	0.0	0.1	0
2:30-2:45		1	0	1	0.0	0.0	0	3	0	3	0.0	0.0	1
2:45-3:00		1	0	1	0.0	0.0	0	2	0	2	0.0	0.0	1
1時間計		5	0	5	0.0	0.2	0	14	0	14	0.0	0.2	3
3:00-3:15		5	0	5	0.0	0.2	0	8	0	8	0.0	0.1	2
3:15-3:30		1	0	1	0.0	0.0	0	3	1	4	25.0	0.1	0
3:30-3:45		1	0	1	0.0	0.0	1	4	0	4	0.0	0.1	1
3:45-4:00		5	0	5	0.0	0.2	0	12	0	12	0.0	0.2	1
1時間計		12	0	12	0.0	0.4	1	27	1	28	3.6	0.4	4
4:00-4:15		6	1	7	14.3	0.2	1	13	1	14	7.1	0.2	1
4:15-4:30		8	1	9	11.1	0.3	0	13	1	14	7.1	0.2	0
4:30-4:45		9	0	9	0.0	0.3	2	18	1	19	5.3	0.3	3
4:45-5:00		6	1	7	14.3	0.2	0	14	1	15	6.7	0.2	1
1時間計		29	3	32	9.4	1.1	3	58	4	62	6.5	0.9	5
5:00-5:15		10	1	11	9.1	0.4	0	23	1	24	4.2	0.3	2
5:15-5:30		11	2	13	15.4	0.4	1	31	2	33	6.1	0.5	2
5:30-5:45		18	1	19	5.3	0.6	2	40	2	42	4.8	0.6	3
5:45-6:00		28	1	29	3.4	1.0	3	65	4	69	5.8	1.0	5
1時間計		67	5	72	6.9	2.4	6	159	9	168	5.4	2.4	12
6:00-6:15		34	3	37	8.1	1.2	2	75	6	81	7.4	1.1	5
6:15-6:30		43	3	46	6.5	1.5	6	103	3	106	2.8	1.5	6
6:30-6:45		55	1	56	1.8	1.9	4	114	3	117	2.6	1.7	8
6:45-7:00		61	2	63	3.2	2.1	4	122	5	127	3.9	1.8	6
1時間計		193	9	202	4.5	6.7	16	414	17	431	3.9	6.1	25
夜12時間計		804	44	848	5.2	28.3	48	1893	80	1973	4.1	27.8	103
全時間合計		2806	187	2993	6.2	100.0	122	6673	415	7088	5.9	100.0	275
昼夜率		1.40	1.31	1.40	-	-	1.65	1.40	1.24	1.39	-	-	1.60

方向別自動車交通量調査表

調査地点：地域社会6 瀬谷中学校前

調査年月日：令和元年 5月14日(火) 天候：雨のち曇り



方向	7						8						
	種別	小型車 (台)	大型車 (台)	合計 (台)	大型車 混入率 (%)	時間 係数 (%)	二輪車 (台)	小型車 (台)	大型車 (台)	合計 (台)	大型車 混入率 (%)	時間 係数 (%)	二輪車 (台)
7:00-7:15		41	4	45	8.9	1.8	1	118	22	140	15.7	2.3	11
7:15-7:30		31	1	32	3.1	1.3	0	82	15	97	15.5	1.6	5
7:30-7:45		37	0	37	0.0	1.5	3	84	13	97	13.4	1.6	16
7:45-8:00		50	6	56	10.7	2.2	5	95	11	106	10.4	1.8	8
1時間計		159	11	170	6.5	6.7	9	379	61	440	13.9	7.3	40
8:00-8:15		56	0	56	0.0	2.2	2	87	7	94	7.4	1.6	12
8:15-8:30		62	3	65	4.6	2.6	0	95	12	107	11.2	1.8	11
8:30-8:45		54	1	55	1.8	2.2	2	72	8	80	10.0	1.3	9
8:45-9:00		44	2	46	4.3	1.8	0	60	6	66	9.1	1.1	4
1時間計		216	6	222	2.7	8.7	4	314	33	347	9.5	5.8	36
9:00-9:15		33	3	36	8.3	1.4	0	85	14	99	14.1	1.6	3
9:15-9:30		22	8	30	26.7	1.2	1	68	15	83	18.1	1.4	2
9:30-9:45		35	3	38	7.9	1.5	0	71	16	87	18.4	1.4	2
9:45-10:00		20	4	24	16.7	0.9	0	57	14	71	19.7	1.2	1
1時間計		110	18	128	14.1	5.0	1	281	59	340	17.4	5.7	8
10:00-10:15		24	3	27	11.1	1.1	1	47	19	66	28.8	1.1	3
10:15-10:30		26	7	33	21.2	1.3	2	71	25	96	26.0	1.6	3
10:30-10:45		27	4	31	12.9	1.2	0	57	17	74	23.0	1.2	4
10:45-11:00		31	6	37	16.2	1.5	1	61	19	80	23.8	1.3	2
1時間計		108	20	128	15.6	5.0	4	236	80	316	25.3	5.3	12
11:00-11:15		36	7	43	16.3	1.7	0	71	25	96	26.0	1.6	1
11:15-11:30		41	5	46	10.9	1.8	0	70	13	83	15.7	1.4	1
11:30-11:45		23	7	30	23.3	1.2	0	83	22	105	21.0	1.7	4
11:45-12:00		47	1	48	2.1	1.9	1	79	12	91	13.2	1.5	2
1時間計		147	20	167	12.0	6.6	1	303	72	375	19.2	6.2	8
12:00-12:15		37	2	39	5.1	1.5	0	51	16	67	23.9	1.1	3
12:15-12:30		38	3	41	7.3	1.6	1	65	9	74	12.2	1.2	2
12:30-12:45		40	2	42	4.8	1.7	0	72	26	98	26.5	1.6	1
12:45-13:00		25	1	26	3.8	1.0	1	81	21	102	20.6	1.7	3
1時間計		140	8	148	5.4	5.8	2	269	72	341	21.1	5.7	9
13:00-13:15		44	0	44	0.0	1.7	1	40	24	64	37.5	1.1	1
13:15-13:30		31	1	32	3.1	1.3	0	71	13	84	15.5	1.4	2
13:30-13:45		29	1	30	3.3	1.2	2	69	15	84	17.9	1.4	2
13:45-14:00		34	4	38	10.5	1.5	3	66	15	81	18.5	1.3	3
1時間計		138	6	144	4.2	5.7	6	246	67	313	21.4	5.2	8
14:00-14:15		37	2	39	5.1	1.5	1	67	11	78	14.1	1.3	1
14:15-14:30		32	3	35	8.6	1.4	1	62	13	75	17.3	1.2	2
14:30-14:45		37	3	40	7.5	1.6	0	74	8	82	9.8	1.4	3
14:45-15:00		39	1	40	2.5	1.6	1	69	12	81	14.8	1.3	2
1時間計		145	9	154	5.8	6.1	3	272	44	316	13.9	5.3	8

方向別自動車交通量調査表

調査地点：地域社会6 瀬谷中学校前

調査年月日：令和元年 5月14日(火) 天候：雨のち曇り



方向 種別 時間帯	7						8					
	小型車 (台)	大型車 (台)	合計 (台)	大型車 混入率 (%)	時間 係数 (%)	二輪車 (台)	小型車 (台)	大型車 (台)	合計 (台)	大型車 混入率 (%)	時間 係数 (%)	二輪車 (台)
15:00-15:15	26	5	31	16.1	1.2	4	76	16	92	17.4	1.5	1
15:15-15:30	27	6	33	18.2	1.3	1	83	18	101	17.8	1.7	2
15:30-15:45	38	10	48	20.8	1.9	2	77	16	93	17.2	1.5	0
15:45-16:00	31	6	37	16.2	1.5	1	76	10	86	11.6	1.4	2
1時間計	122	27	149	18.1	5.9	8	312	60	372	16.1	6.2	5
16:00-16:15	46	2	48	4.2	1.9	0	87	18	105	17.1	1.7	3
16:15-16:30	35	3	38	7.9	1.5	1	66	13	79	16.5	1.3	3
16:30-16:45	35	3	38	7.9	1.5	0	72	11	83	13.3	1.4	2
16:45-17:00	40	4	44	9.1	1.7	0	81	11	92	12.0	1.5	1
1時間計	156	12	168	7.1	6.6	1	306	53	359	14.8	6.0	9
17:00-17:15	41	4	45	8.9	1.8	4	103	10	113	8.8	1.9	5
17:15-17:30	61	1	62	1.6	2.4	4	97	13	110	11.8	1.8	6
17:30-17:45	36	1	37	2.7	1.5	1	82	6	88	6.8	1.5	6
17:45-18:00	44	0	44	0.0	1.7	1	96	8	104	7.7	1.7	8
1時間計	182	6	188	3.2	7.4	10	378	37	415	8.9	6.9	25
18:00-18:15	37	0	37	0.0	1.5	1	100	7	107	6.5	1.8	10
18:15-18:30	39	1	40	2.5	1.6	1	105	4	109	3.7	1.8	4
18:30-18:45	24	1	25	4.0	1.0	1	80	4	84	4.8	1.4	3
18:45-19:00	36	2	38	5.3	1.5	1	62	3	65	4.6	1.1	6
1時間計	136	4	140	2.9	5.5	4	347	18	365	4.9	6.1	23
昼12時間計	1759	147	1906	7.7	75.0	53	3643	656	4299	15.3	71.5	191
19:00-19:15	27	1	28	3.6	1.1	2	53	0	53	0.0	0.9	3
19:15-19:30	36	0	36	0.0	1.4	1	62	2	64	3.1	1.1	7
19:30-19:45	35	0	35	0.0	1.4	0	66	1	67	1.5	1.1	2
19:45-20:00	33	0	33	0.0	1.3	3	41	2	43	4.7	0.7	7
1時間計	131	1	132	0.8	5.2	6	222	5	227	2.2	3.8	19
20:00-20:15	23	0	23	0.0	0.9	0	60	1	61	1.6	1.0	3
20:15-20:30	30	0	30	0.0	1.2	3	47	1	48	2.1	0.8	3
20:30-20:45	21	0	21	0.0	0.8	0	40	4	44	9.1	0.7	4
20:45-21:00	13	1	14	7.1	0.6	0	34	2	36	5.6	0.6	0
1時間計	87	1	88	1.1	3.5	3	181	8	189	4.2	3.1	10
21:00-21:15	16	0	16	0.0	0.6	1	45	2	47	4.3	0.8	2
21:15-21:30	15	1	16	6.3	0.6	1	30	0	30	0.0	0.5	2
21:30-21:45	11	0	11	0.0	0.4	1	33	1	34	2.9	0.6	1
21:45-22:00	12	0	12	0.0	0.5	0	29	3	32	9.4	0.5	3
1時間計	54	1	55	1.8	2.2	3	137	6	143	4.2	2.4	8
22:00-22:15	11	1	12	8.3	0.5	0	37	0	37	0.0	0.6	1
22:15-22:30	10	1	11	9.1	0.4	0	32	2	34	5.9	0.6	2
22:30-22:45	13	1	14	7.1	0.6	0	29	2	31	6.5	0.5	0
22:45-23:00	19	1	20	5.0	0.8	0	23	3	26	11.5	0.4	1
1時間計	53	4	57	7.0	2.2	0	121	7	128	5.5	2.1	4

方向別自動車交通量調査表

調査地点：地域社会6 瀬谷中学校前

調査年月日：令和元年 5月14日(火) 天候：雨のち曇り



方向 種別 時間帯	7						8					
	小型車 (台)	大型車 (台)	合計 (台)	大型車 混入率 (%)	時間 係数 (%)	二輪車 (台)	小型車 (台)	大型車 (台)	合計 (台)	大型車 混入率 (%)	時間 係数 (%)	二輪車 (台)
23:00-23:15	5	0	5	0.0	0.2	0	23	5	28	17.9	0.5	2
23:15-23:30	3	0	3	0.0	0.1	2	14	1	15	6.7	0.2	1
23:30-23:45	5	0	5	0.0	0.2	0	14	1	15	6.7	0.2	1
23:45-24:00	4	0	4	0.0	0.2	0	6	3	9	33.3	0.1	0
1時間計	17	0	17	0.0	0.7	2	57	10	67	14.9	1.1	4
0:00-0:15	3	0	3	0.0	0.1	0	9	1	10	10.0	0.2	1
0:15-0:30	4	0	4	0.0	0.2	0	13	3	16	18.8	0.3	0
0:30-0:45	3	1	4	25.0	0.2	0	4	0	4	0.0	0.1	0
0:45-1:00	5	0	5	0.0	0.2	1	14	3	17	17.6	0.3	2
1時間計	15	1	16	6.3	0.6	1	40	7	47	14.9	0.8	3
1:00-1:15	5	3	8	37.5	0.3	0	6	6	12	50.0	0.2	1
1:15-1:30	7	1	8	12.5	0.3	0	8	5	13	38.5	0.2	0
1:30-1:45	11	1	12	8.3	0.5	0	12	9	21	42.9	0.3	0
1:45-2:00	3	1	4	25.0	0.2	1	6	9	15	60.0	0.2	1
1時間計	26	6	32	18.8	1.3	1	32	29	61	47.5	1.0	2
2:00-2:15	1	0	1	0.0	0.0	0	14	3	17	17.6	0.3	0
2:15-2:30	1	0	1	0.0	0.0	0	6	5	11	45.5	0.2	0
2:30-2:45	1	0	1	0.0	0.0	0	10	1	11	9.1	0.2	0
2:45-3:00	2	0	2	0.0	0.1	0	5	6	11	54.5	0.2	1
1時間計	5	0	5	0.0	0.2	0	35	15	50	30.0	0.8	1
3:00-3:15	4	2	6	33.3	0.2	0	5	6	11	54.5	0.2	0
3:15-3:30	4	0	4	0.0	0.2	0	8	5	13	38.5	0.2	0
3:30-3:45	2	0	2	0.0	0.1	0	12	3	15	20.0	0.2	0
3:45-4:00	5	0	5	0.0	0.2	0	4	7	11	63.6	0.2	0
1時間計	15	2	17	11.8	0.7	0	29	21	50	42.0	0.8	0
4:00-4:15	2	2	4	50.0	0.2	0	14	6	20	30.0	0.3	4
4:15-4:30	5	3	8	37.5	0.3	0	10	5	15	33.3	0.2	1
4:30-4:45	4	1	5	20.0	0.2	0	15	4	19	21.1	0.3	3
4:45-5:00	6	1	7	14.3	0.3	0	21	9	30	30.0	0.5	1
1時間計	17	7	24	29.2	0.9	0	60	24	84	28.6	1.4	9
5:00-5:15	4	3	7	42.9	0.3	0	28	19	47	40.4	0.8	3
5:15-5:30	13	1	14	7.1	0.6	0	45	11	56	19.6	0.9	4
5:30-5:45	22	3	25	12.0	1.0	1	55	11	66	16.7	1.1	4
5:45-6:00	20	0	20	0.0	0.8	2	61	12	73	16.4	1.2	2
1時間計	59	7	66	10.6	2.6	3	189	53	242	21.9	4.0	13
6:00-6:15	29	4	33	12.1	1.3	2	58	16	74	21.6	1.2	5
6:15-6:30	25	5	30	16.7	1.2	0	106	17	123	13.8	2.0	10
6:30-6:45	39	0	39	0.0	1.5	3	99	17	116	14.7	1.9	4
6:45-7:00	24	2	26	7.7	1.0	5	94	22	116	19.0	1.9	15
1時間計	117	11	128	8.6	5.0	10	357	72	429	16.8	7.1	34
夜12時間計	596	41	637	6.4	25.0	29	1460	257	1717	15.0	28.5	107
全時間合計	2355	188	2543	7.4	100.0	82	5103	913	6016	15.2	100.0	298
昼夜率	1.34	1.28	1.33	-	-	1.55	1.40	1.39	1.40	-	-	1.56

方向別自動車交通量調査表

調査地点：地域社会6 瀬谷中学校前

調査年月日：令和元年 5月14日(火) 天候：雨のち曇り



時間帯	種別	9						C 合計 (7+ 8+ 9)					
		小型車 (台)	大型車 (台)	合計 (台)	大型車 混入率 (%)	時 間 係 数 (%)	二輪車 (台)	小型車 (台)	大型車 (台)	合計 (台)	大型車 混入率 (%)	時 間 係 数 (%)	二輪車 (台)
7:00-7:15		27	7	34	20.6	1.8	1	186	33	219	15.1	2.1	13
7:15-7:30		13	2	15	13.3	0.8	1	126	18	144	12.5	1.4	6
7:30-7:45		34	3	37	8.1	1.9	2	155	16	171	9.4	1.6	21
7:45-8:00		17	2	19	10.5	1.0	2	162	19	181	10.5	1.7	15
1時間計		91	14	105	13.3	5.5	6	629	86	715	12.0	6.8	55
8:00-8:15		23	7	30	23.3	1.6	7	166	14	180	7.8	1.7	21
8:15-8:30		21	3	24	12.5	1.3	5	178	18	196	9.2	1.9	16
8:30-8:45		25	0	25	0.0	1.3	2	151	9	160	5.6	1.5	13
8:45-9:00		23	1	24	4.2	1.3	3	127	9	136	6.6	1.3	7
1時間計		92	11	103	10.7	5.4	17	622	50	672	7.4	6.4	57
9:00-9:15		31	3	34	8.8	1.8	0	149	20	169	11.8	1.6	3
9:15-9:30		22	4	26	15.4	1.4	0	112	27	139	19.4	1.3	3
9:30-9:45		22	1	23	4.3	1.2	0	128	20	148	13.5	1.4	2
9:45-10:00		25	2	27	7.4	1.4	0	102	20	122	16.4	1.2	1
1時間計		100	10	110	9.1	5.8	0	491	87	578	15.1	5.5	9
10:00-10:15		38	1	39	2.6	2.1	1	109	23	132	17.4	1.3	5
10:15-10:30		31	4	35	11.4	1.8	0	128	36	164	22.0	1.6	5
10:30-10:45		27	2	29	6.9	1.5	1	111	23	134	17.2	1.3	5
10:45-11:00		22	2	24	8.3	1.3	1	114	27	141	19.1	1.3	4
1時間計		118	9	127	7.1	6.7	3	462	109	571	19.1	5.5	19
11:00-11:15		32	3	35	8.6	1.8	0	139	35	174	20.1	1.7	1
11:15-11:30		33	2	35	5.7	1.8	1	144	20	164	12.2	1.6	2
11:30-11:45		23	1	24	4.2	1.3	1	129	30	159	18.9	1.5	5
11:45-12:00		34	4	38	10.5	2.0	1	160	17	177	9.6	1.7	4
1時間計		122	10	132	7.6	6.9	3	572	102	674	15.1	6.4	12
12:00-12:15		24	1	25	4.0	1.3	1	112	19	131	14.5	1.3	4
12:15-12:30		25	3	28	10.7	1.5	0	128	15	143	10.5	1.4	3
12:30-12:45		28	0	28	0.0	1.5	0	140	28	168	16.7	1.6	1
12:45-13:00		30	3	33	9.1	1.7	1	136	25	161	15.5	1.5	5
1時間計		107	7	114	6.1	6.0	2	516	87	603	14.4	5.8	13
13:00-13:15		19	4	23	17.4	1.2	0	103	28	131	21.4	1.3	2
13:15-13:30		26	1	27	3.7	1.4	0	128	15	143	10.5	1.4	2
13:30-13:45		25	3	28	10.7	1.5	1	123	19	142	13.4	1.4	5
13:45-14:00		23	2	25	8.0	1.3	0	123	21	144	14.6	1.4	6
1時間計		93	10	103	9.7	5.4	1	477	83	560	14.8	5.4	15
14:00-14:15		35	2	37	5.4	1.9	0	139	15	154	9.7	1.5	2
14:15-14:30		23	2	25	8.0	1.3	1	117	18	135	13.3	1.3	4
14:30-14:45		27	2	29	6.9	1.5	0	138	13	151	8.6	1.4	3
14:45-15:00		36	2	38	5.3	2.0	0	144	15	159	9.4	1.5	3
1時間計		121	8	129	6.2	6.8	1	538	61	599	10.2	5.7	12

方向別自動車交通量調査表

調査地点：地域社会6 瀬谷中学校前

調査年月日：令和元年 5月14日(火) 天候：雨のち曇り



方向 種別 時間帯	9						C 合計 (7+ 8+ 9)					
	小型車 (台)	大型車 (台)	合計 (台)	大型車 混入率 (%)	時 間 係 数 (%)	二輪車 (台)	小型車 (台)	大型車 (台)	合計 (台)	大型車 混入率 (%)	時 間 係 数 (%)	二輪車 (台)
15:00-15:15	28	2	30	6.7	1.6	0	130	23	153	15.0	1.5	5
15:15-15:30	25	2	27	7.4	1.4	1	135	26	161	16.1	1.5	4
15:30-15:45	21	2	23	8.7	1.2	2	136	28	164	17.1	1.6	4
15:45-16:00	35	0	35	0.0	1.8	3	142	16	158	10.1	1.5	6
1時間計	109	6	115	5.2	6.0	6	543	93	636	14.6	6.1	19
16:00-16:15	31	4	35	11.4	1.8	0	164	24	188	12.8	1.8	3
16:15-16:30	24	1	25	4.0	1.3	1	125	17	142	12.0	1.4	5
16:30-16:45	28	2	30	6.7	1.6	0	135	16	151	10.6	1.4	2
16:45-17:00	26	5	31	16.1	1.6	2	147	20	167	12.0	1.6	3
1時間計	109	12	121	9.9	6.4	3	571	77	648	11.9	6.2	13
17:00-17:15	44	2	46	4.3	2.4	1	188	16	204	7.8	2.0	10
17:15-17:30	34	1	35	2.9	1.8	1	192	15	207	7.2	2.0	11
17:30-17:45	23	2	25	8.0	1.3	3	141	9	150	6.0	1.4	10
17:45-18:00	27	0	27	0.0	1.4	0	167	8	175	4.6	1.7	9
1時間計	128	5	133	3.8	7.0	5	688	48	736	6.5	7.0	40
18:00-18:15	24	1	25	4.0	1.3	3	161	8	169	4.7	1.6	14
18:15-18:30	38	0	38	0.0	2.0	2	182	5	187	2.7	1.8	7
18:30-18:45	38	1	39	2.6	2.1	2	142	6	148	4.1	1.4	6
18:45-19:00	22	1	23	4.3	1.2	1	120	6	126	4.8	1.2	8
1時間計	122	3	125	2.4	6.6	8	605	25	630	4.0	6.0	35
昼12時間計	1312	105	1417	7.4	74.5	55	6714	908	7622	11.9	72.9	299
19:00-19:15	17	0	17	0.0	0.9	1	97	1	98	1.0	0.9	6
19:15-19:30	30	1	31	3.2	1.6	4	128	3	131	2.3	1.3	12
19:30-19:45	29	1	30	3.3	1.6	2	130	2	132	1.5	1.3	4
19:45-20:00	28	1	29	3.4	1.5	0	102	3	105	2.9	1.0	10
1時間計	104	3	107	2.8	5.6	7	457	9	466	1.9	4.5	32
20:00-20:15	19	0	19	0.0	1.0	2	102	1	103	1.0	1.0	5
20:15-20:30	21	2	23	8.7	1.2	4	98	3	101	3.0	1.0	10
20:30-20:45	20	2	22	9.1	1.2	1	81	6	87	6.9	0.8	5
20:45-21:00	14	0	14	0.0	0.7	1	61	3	64	4.7	0.6	1
1時間計	74	4	78	5.1	4.1	8	342	13	355	3.7	3.4	21
21:00-21:15	15	0	15	0.0	0.8	0	76	2	78	2.6	0.7	3
21:15-21:30	19	1	20	5.0	1.1	1	64	2	66	3.0	0.6	4
21:30-21:45	22	1	23	4.3	1.2	1	66	2	68	2.9	0.7	3
21:45-22:00	14	0	14	0.0	0.7	1	55	3	58	5.2	0.6	4
1時間計	70	2	72	2.8	3.8	3	261	9	270	3.3	2.6	14
22:00-22:15	18	0	18	0.0	0.9	2	66	1	67	1.5	0.6	3
22:15-22:30	4	0	4	0.0	0.2	0	46	3	49	6.1	0.5	2
22:30-22:45	12	0	12	0.0	0.6	0	54	3	57	5.3	0.5	0
22:45-23:00	20	0	20	0.0	1.1	2	62	4	66	6.1	0.6	3
1時間計	54	0	54	0.0	2.8	4	228	11	239	4.6	2.3	8

方向別自動車交通量調査表

調査地点：地域社会6 瀬谷中学校前

調査年月日：令和元年 5月14日(火) 天候：雨のち曇り



方向 時間帯	9						C 合計 (7+ 8+ 9)					
	種別 小型車 (台)	大型車 (台)	合計 (台)	大型車 混入率 (%)	時間 係数 (%)	二輪車 (台)	小型車 (台)	大型車 (台)	合計 (台)	大型車 混入率 (%)	時間 係数 (%)	二輪車 (台)
23:00-23:15	11	0	11	0.0	0.6	0	39	5	44	11.4	0.4	2
23:15-23:30	6	0	6	0.0	0.3	0	23	1	24	4.2	0.2	3
23:30-23:45	4	0	4	0.0	0.2	1	23	1	24	4.2	0.2	2
23:45-24:00	6	0	6	0.0	0.3	0	16	3	19	15.8	0.2	0
1時間計	27	0	27	0.0	1.4	1	101	10	111	9.0	1.1	7
0:00-0:15	2	0	2	0.0	0.1	0	14	1	15	6.7	0.1	1
0:15-0:30	1	2	3	66.7	0.2	0	18	5	23	21.7	0.2	0
0:30-0:45	4	0	4	0.0	0.2	0	11	1	12	8.3	0.1	0
0:45-1:00	5	0	5	0.0	0.3	1	24	3	27	11.1	0.3	4
1時間計	12	2	14	14.3	0.7	1	67	10	77	13.0	0.7	5
1:00-1:15	3	0	3	0.0	0.2	0	14	9	23	39.1	0.2	1
1:15-1:30	2	0	2	0.0	0.1	0	17	6	23	26.1	0.2	0
1:30-1:45	6	0	6	0.0	0.3	0	29	10	39	25.6	0.4	0
1:45-2:00	4	0	4	0.0	0.2	1	13	10	23	43.5	0.2	3
1時間計	15	0	15	0.0	0.8	1	73	35	108	32.4	1.0	4
2:00-2:15	3	0	3	0.0	0.2	0	18	3	21	14.3	0.2	0
2:15-2:30	2	2	4	50.0	0.2	0	9	7	16	43.8	0.2	0
2:30-2:45	1	0	1	0.0	0.1	0	12	1	13	7.7	0.1	0
2:45-3:00	0	0	0	0.0	0.0	0	7	6	13	46.2	0.1	1
1時間計	6	2	8	25.0	0.4	0	46	17	63	27.0	0.6	1
3:00-3:15	0	0	0	0.0	0.0	0	9	8	17	47.1	0.2	0
3:15-3:30	0	1	1	100.0	0.1	0	12	6	18	33.3	0.2	0
3:30-3:45	1	2	3	66.7	0.2	0	15	5	20	25.0	0.2	0
3:45-4:00	1	0	1	0.0	0.1	1	10	7	17	41.2	0.2	1
1時間計	2	3	5	60.0	0.3	1	46	26	72	36.1	0.7	1
4:00-4:15	3	1	4	25.0	0.2	0	19	9	28	32.1	0.3	4
4:15-4:30	1	2	3	66.7	0.2	0	16	10	26	38.5	0.2	1
4:30-4:45	3	0	3	0.0	0.2	0	22	5	27	18.5	0.3	3
4:45-5:00	0	0	0	0.0	0.0	1	27	10	37	27.0	0.4	2
1時間計	7	3	10	30.0	0.5	1	84	34	118	28.8	1.1	10
5:00-5:15	8	0	8	0.0	0.4	0	40	22	62	35.5	0.6	3
5:15-5:30	8	0	8	0.0	0.4	0	66	12	78	15.4	0.7	4
5:30-5:45	10	1	11	9.1	0.6	0	87	15	102	14.7	1.0	5
5:45-6:00	13	0	13	0.0	0.7	0	94	12	106	11.3	1.0	4
1時間計	39	1	40	2.5	2.1	0	287	61	348	17.5	3.3	16
6:00-6:15	11	0	11	0.0	0.6	0	98	20	118	16.9	1.1	7
6:15-6:30	10	1	11	9.1	0.6	0	141	23	164	14.0	1.6	10
6:30-6:45	10	3	13	23.1	0.7	2	148	20	168	11.9	1.6	9
6:45-7:00	19	1	20	5.0	1.1	1	137	25	162	15.4	1.5	21
1時間計	50	5	55	9.1	2.9	3	524	88	612	14.4	5.9	47
夜12時間計	460	25	485	5.2	25.5	30	2516	323	2839	11.4	27.1	166
全時間合計	1772	130	1902	6.8	100.0	85	9230	1231	10461	11.8	100.0	465
昼夜率	1.35	1.24	1.34	-	-	1.55	1.37	1.36	1.37	-	-	1.56

方向別自動車交通量調査表

調査地点：地域社会6 瀬谷中学校前

調査年月日：令和元年 5月14日(火) 天候：雨のち曇り



方向 時間帯	10						11					
	種別 小型車 (台)	大型車 (台)	合計 (台)	大型車 混入率 (%)	時 間 係 数 (%)	二輪車 (台)	小型車 (台)	大型車 (台)	合計 (台)	大型車 混入率 (%)	時 間 係 数 (%)	二輪車 (台)
7:00-7:15	15	4	19	21.1	1.2	1	55	3	58	5.2	1.7	3
7:15-7:30	26	1	27	3.7	1.7	0	61	3	64	4.7	1.9	1
7:30-7:45	19	1	20	5.0	1.3	0	56	5	61	8.2	1.8	2
7:45-8:00	17	0	17	0.0	1.1	0	58	4	62	6.5	1.8	4
1時間計	77	6	83	7.2	5.2	1	230	15	245	6.1	7.1	10
8:00-8:15	18	0	18	0.0	1.1	1	63	6	69	8.7	2.0	2
8:15-8:30	16	1	17	5.9	1.1	0	59	4	63	6.3	1.8	2
8:30-8:45	30	0	30	0.0	1.9	1	44	5	49	10.2	1.4	0
8:45-9:00	17	3	20	15.0	1.3	0	38	4	42	9.5	1.2	0
1時間計	81	4	85	4.7	5.4	2	204	19	223	8.5	6.5	4
9:00-9:15	30	4	34	11.8	2.1	0	57	7	64	10.9	1.9	0
9:15-9:30	8	8	16	50.0	1.0	0	48	4	52	7.7	1.5	1
9:30-9:45	27	2	29	6.9	1.8	0	52	9	61	14.8	1.8	1
9:45-10:00	34	1	35	2.9	2.2	0	56	4	60	6.7	1.7	2
1時間計	99	15	114	13.2	7.2	0	213	24	237	10.1	6.9	4
10:00-10:15	24	4	28	14.3	1.8	0	39	4	43	9.3	1.3	0
10:15-10:30	28	2	30	6.7	1.9	1	31	1	32	3.1	0.9	2
10:30-10:45	32	4	36	11.1	2.3	0	53	3	56	5.4	1.6	0
10:45-11:00	22	2	24	8.3	1.5	0	40	3	43	7.0	1.3	2
1時間計	106	12	118	10.2	7.4	1	163	11	174	6.3	5.1	4
11:00-11:15	26	0	26	0.0	1.6	0	40	6	46	13.0	1.3	0
11:15-11:30	25	2	27	7.4	1.7	0	34	2	36	5.6	1.0	0
11:30-11:45	19	2	21	9.5	1.3	0	41	0	41	0.0	1.2	0
11:45-12:00	17	5	22	22.7	1.4	0	43	10	53	18.9	1.5	1
1時間計	87	9	96	9.4	6.0	0	158	18	176	10.2	5.1	1
12:00-12:15	22	1	23	4.3	1.4	1	45	2	47	4.3	1.4	2
12:15-12:30	25	1	26	3.8	1.6	0	45	9	54	16.7	1.6	2
12:30-12:45	25	4	29	13.8	1.8	0	48	2	50	4.0	1.5	5
12:45-13:00	15	3	18	16.7	1.1	0	44	6	50	12.0	1.5	1
1時間計	87	9	96	9.4	6.0	1	182	19	201	9.5	5.9	10
13:00-13:15	18	2	20	10.0	1.3	0	38	6	44	13.6	1.3	1
13:15-13:30	27	3	30	10.0	1.9	0	39	12	51	23.5	1.5	1
13:30-13:45	28	0	28	0.0	1.8	0	21	11	32	34.4	0.9	0
13:45-14:00	18	5	23	21.7	1.4	0	49	5	54	9.3	1.6	0
1時間計	91	10	101	9.9	6.4	0	147	34	181	18.8	5.3	2
14:00-14:15	22	1	23	4.3	1.4	1	42	3	45	6.7	1.3	2
14:15-14:30	20	1	21	4.8	1.3	2	38	4	42	9.5	1.2	2
14:30-14:45	29	4	33	12.1	2.1	1	42	5	47	10.6	1.4	1
14:45-15:00	27	2	29	6.9	1.8	0	43	2	45	4.4	1.3	2
1時間計	98	8	106	7.5	6.7	4	165	14	179	7.8	5.2	7

方向別自動車交通量調査表

調査地点：地域社会6 瀬谷中学校前

調査年月日：令和元年 5月14日(火) 天候：雨のち曇り



方向 時間帯	10						11					
	種別 小型車 (台)	大型車 (台)	合計 (台)	大型車 混入率 (%)	時間 係数 (%)	二輪車 (台)	小型車 (台)	大型車 (台)	合計 (台)	大型車 混入率 (%)	時間 係数 (%)	二輪車 (台)
15:00-15:15	30	3	33	9.1	2.1	0	48	5	53	9.4	1.5	3
15:15-15:30	21	0	21	0.0	1.3	0	36	4	40	10.0	1.2	2
15:30-15:45	18	3	21	14.3	1.3	1	34	4	38	10.5	1.1	1
15:45-16:00	29	1	30	3.3	1.9	1	50	6	56	10.7	1.6	1
1時間計	98	7	105	6.7	6.6	2	168	19	187	10.2	5.4	7
16:00-16:15	25	1	26	3.8	1.6	0	26	2	28	7.1	0.8	0
16:15-16:30	28	1	29	3.4	1.8	0	38	4	42	9.5	1.2	4
16:30-16:45	30	2	32	6.3	2.0	0	58	3	61	4.9	1.8	4
16:45-17:00	16	0	16	0.0	1.0	0	31	3	34	8.8	1.0	1
1時間計	99	4	103	3.9	6.5	0	153	12	165	7.3	4.8	9
17:00-17:15	29	1	30	3.3	1.9	2	31	0	31	0.0	0.9	1
17:15-17:30	13	2	15	13.3	0.9	0	50	11	61	18.0	1.8	0
17:30-17:45	20	1	21	4.8	1.3	2	51	3	54	5.6	1.6	2
17:45-18:00	27	0	27	0.0	1.7	0	43	1	44	2.3	1.3	1
1時間計	89	4	93	4.3	5.9	4	175	15	190	7.9	5.5	4
18:00-18:15	21	1	22	4.5	1.4	1	67	4	71	5.6	2.1	1
18:15-18:30	21	0	21	0.0	1.3	0	68	4	72	5.6	2.1	3
18:30-18:45	27	3	30	10.0	1.9	0	73	6	79	7.6	2.3	3
18:45-19:00	23	0	23	0.0	1.4	1	50	2	52	3.8	1.5	5
1時間計	92	4	96	4.2	6.0	2	258	16	274	5.8	8.0	12
昼12時間計	1104	92	1196	7.7	75.4	17	2216	216	2432	8.9	70.8	74
19:00-19:15	16	0	16	0.0	1.0	1	62	0	62	0.0	1.8	1
19:15-19:30	22	1	23	4.3	1.4	0	43	2	45	4.4	1.3	0
19:30-19:45	18	1	19	5.3	1.2	0	61	6	67	9.0	2.0	3
19:45-20:00	16	1	17	5.9	1.1	1	51	3	54	5.6	1.6	1
1時間計	72	3	75	4.0	4.7	2	217	11	228	4.8	6.6	5
20:00-20:15	30	1	31	3.2	2.0	1	58	0	58	0.0	1.7	2
20:15-20:30	20	0	20	0.0	1.3	0	41	4	45	8.9	1.3	3
20:30-20:45	18	0	18	0.0	1.1	2	41	4	45	8.9	1.3	2
20:45-21:00	18	1	19	5.3	1.2	0	28	1	29	3.4	0.8	6
1時間計	86	2	88	2.3	5.5	3	168	9	177	5.1	5.2	13
21:00-21:15	6	2	8	25.0	0.5	1	30	1	31	3.2	0.9	2
21:15-21:30	11	1	12	8.3	0.8	0	35	2	37	5.4	1.1	4
21:30-21:45	15	0	15	0.0	0.9	0	29	4	33	12.1	1.0	2
21:45-22:00	14	2	16	12.5	1.0	0	41	2	43	4.7	1.3	1
1時間計	46	5	51	9.8	3.2	1	135	9	144	6.3	4.2	9
22:00-22:15	10	0	10	0.0	0.6	1	42	2	44	4.5	1.3	1
22:15-22:30	7	1	8	12.5	0.5	4	21	1	22	4.5	0.6	1
22:30-22:45	13	0	13	0.0	0.8	1	18	0	18	0.0	0.5	1
22:45-23:00	7	0	7	0.0	0.4	0	14	1	15	6.7	0.4	0
1時間計	37	1	38	2.6	2.4	6	95	4	99	4.0	2.9	3

方向別自動車交通量調査表

調査地点：地域社会6 瀬谷中学校前

調査年月日：令和元年 5月14日(火) 天候：雨のち曇り



方向 種別 時間帯	10						11					
	小型車 (台)	大型車 (台)	合計 (台)	大型車 混入率 (%)	時間 係数 (%)	二輪車 (台)	小型車 (台)	大型車 (台)	合計 (台)	大型車 混入率 (%)	時間 係数 (%)	二輪車 (台)
23:00-23:15	10	0	10	0.0	0.6	0	8	0	8	0.0	0.2	0
23:15-23:30	8	0	8	0.0	0.5	0	10	0	10	0.0	0.3	0
23:30-23:45	2	0	2	0.0	0.1	0	6	0	6	0.0	0.2	0
23:45-24:00	5	0	5	0.0	0.3	0	10	0	10	0.0	0.3	0
1時間計	25	0	25	0.0	1.6	0	34	0	34	0.0	1.0	0
0:00-0:15	5	0	5	0.0	0.3	0	10	0	10	0.0	0.3	0
0:15-0:30	0	1	1	100.0	0.1	0	15	0	15	0.0	0.4	0
0:30-0:45	1	1	2	50.0	0.1	0	6	0	6	0.0	0.2	0
0:45-1:00	1	0	1	0.0	0.1	0	6	1	7	14.3	0.2	0
1時間計	7	2	9	22.2	0.6	0	37	1	38	2.6	1.1	0
1:00-1:15	5	0	5	0.0	0.3	0	6	0	6	0.0	0.2	0
1:15-1:30	2	0	2	0.0	0.1	1	8	0	8	0.0	0.2	0
1:30-1:45	3	1	4	25.0	0.3	0	4	0	4	0.0	0.1	3
1:45-2:00	3	0	3	0.0	0.2	0	1	0	1	0.0	0.0	0
1時間計	13	1	14	7.1	0.9	1	19	0	19	0.0	0.6	3
2:00-2:15	3	0	3	0.0	0.2	0	4	1	5	20.0	0.1	0
2:15-2:30	0	1	1	100.0	0.1	0	1	1	2	50.0	0.1	0
2:30-2:45	2	1	3	33.3	0.2	0	2	0	2	0.0	0.1	0
2:45-3:00	2	1	3	33.3	0.2	1	4	0	4	0.0	0.1	0
1時間計	7	3	10	30.0	0.6	1	11	2	13	15.4	0.4	0
3:00-3:15	1	0	1	0.0	0.1	0	0	0	0	0.0	0.0	1
3:15-3:30	0	0	0	0.0	0.0	0	1	0	1	0.0	0.0	1
3:30-3:45	2	0	2	0.0	0.1	0	2	1	3	33.3	0.1	0
3:45-4:00	0	1	1	100.0	0.1	0	3	2	5	40.0	0.1	0
1時間計	3	1	4	25.0	0.3	0	6	3	9	33.3	0.3	2
4:00-4:15	0	0	0	0.0	0.0	0	2	0	2	0.0	0.1	0
4:15-4:30	2	0	2	0.0	0.1	0	6	0	6	0.0	0.2	0
4:30-4:45	2	0	2	0.0	0.1	0	4	0	4	0.0	0.1	0
4:45-5:00	2	1	3	33.3	0.2	0	6	0	6	0.0	0.2	2
1時間計	6	1	7	14.3	0.4	0	18	0	18	0.0	0.5	2
5:00-5:15	1	0	1	0.0	0.1	0	5	0	5	0.0	0.1	0
5:15-5:30	9	0	9	0.0	0.6	0	17	0	17	0.0	0.5	1
5:30-5:45	3	0	3	0.0	0.2	0	9	4	13	30.8	0.4	0
5:45-6:00	5	2	7	28.6	0.4	1	23	0	23	0.0	0.7	3
1時間計	18	2	20	10.0	1.3	1	54	4	58	6.9	1.7	4
6:00-6:15	7	0	7	0.0	0.4	0	29	2	31	6.5	0.9	1
6:15-6:30	21	0	21	0.0	1.3	0	44	1	45	2.2	1.3	7
6:30-6:45	4	1	5	20.0	0.3	3	38	2	40	5.0	1.2	1
6:45-7:00	14	3	17	17.6	1.1	1	47	3	50	6.0	1.5	3
1時間計	46	4	50	8.0	3.2	4	158	8	166	4.8	4.8	12
夜12時間計	366	25	391	6.4	24.6	19	952	51	1003	5.1	29.2	53
全時間合計	1470	117	1587	7.4	100.0	36	3168	267	3435	7.8	100.0	127
昼夜率	1.33	1.27	1.33	-	-	2.12	1.43	1.24	1.41	-	-	1.72

方向別自動車交通量調査表

調査地点：地域社会6 瀬谷中学校前

調査年月日：令和元年 5月14日(火) 天候：雨のち曇り



方向 時間帯	12						D 合計 (10+11+12)					
	種別 小型車 (台)	大型車 (台)	合計 (台)	大型車 混入率 (%)	時係 数 (%)	二輪車 (台)	小型車 (台)	大型車 (台)	合計 (台)	大型車 混入率 (%)	時係 数 (%)	二輪車 (台)
7:00-7:15	27	1	28	3.6	1.9	2	97	8	105	7.6	1.6	6
7:15-7:30	21	6	27	22.2	1.8	0	108	10	118	8.5	1.8	1
7:30-7:45	22	1	23	4.3	1.5	0	97	7	104	6.7	1.6	2
7:45-8:00	17	0	17	0.0	1.1	0	92	4	96	4.2	1.5	4
1時間計	87	8	95	8.4	6.3	2	394	29	423	6.9	6.5	13
8:00-8:15	22	0	22	0.0	1.5	0	103	6	109	5.5	1.7	3
8:15-8:30	30	6	36	16.7	2.4	0	105	11	116	9.5	1.8	2
8:30-8:45	19	1	20	5.0	1.3	0	93	6	99	6.1	1.5	1
8:45-9:00	13	2	15	13.3	1.0	1	68	9	77	11.7	1.2	1
1時間計	84	9	93	9.7	6.2	1	369	32	401	8.0	6.1	7
9:00-9:15	19	4	23	17.4	1.5	1	106	15	121	12.4	1.9	1
9:15-9:30	10	1	11	9.1	0.7	0	66	13	79	16.5	1.2	1
9:30-9:45	23	2	25	8.0	1.7	1	102	13	115	11.3	1.8	2
9:45-10:00	18	2	20	10.0	1.3	1	108	7	115	6.1	1.8	3
1時間計	70	9	79	11.4	5.3	3	382	48	430	11.2	6.6	7
10:00-10:15	25	0	25	0.0	1.7	0	88	8	96	8.3	1.5	0
10:15-10:30	25	2	27	7.4	1.8	1	84	5	89	5.6	1.4	4
10:30-10:45	40	3	43	7.0	2.9	2	125	10	135	7.4	2.1	2
10:45-11:00	13	0	13	0.0	0.9	0	75	5	80	6.3	1.2	2
1時間計	103	5	108	4.6	7.2	3	372	28	400	7.0	6.1	8
11:00-11:15	24	2	26	7.7	1.7	1	90	8	98	8.2	1.5	1
11:15-11:30	18	3	21	14.3	1.4	0	77	7	84	8.3	1.3	0
11:30-11:45	21	2	23	8.7	1.5	0	81	4	85	4.7	1.3	0
11:45-12:00	24	2	26	7.7	1.7	0	84	17	101	16.8	1.5	1
1時間計	87	9	96	9.4	6.4	1	332	36	368	9.8	5.6	2
12:00-12:15	14	1	15	6.7	1.0	1	81	4	85	4.7	1.3	4
12:15-12:30	18	1	19	5.3	1.3	0	88	11	99	11.1	1.5	2
12:30-12:45	17	1	18	5.6	1.2	1	90	7	97	7.2	1.5	6
12:45-13:00	12	0	12	0.0	0.8	0	71	9	80	11.3	1.2	1
1時間計	61	3	64	4.7	4.3	2	330	31	361	8.6	5.5	13
13:00-13:15	28	2	30	6.7	2.0	1	84	10	94	10.6	1.4	2
13:15-13:30	19	2	21	9.5	1.4	0	85	17	102	16.7	1.6	1
13:30-13:45	17	1	18	5.6	1.2	0	66	12	78	15.4	1.2	0
13:45-14:00	18	1	19	5.3	1.3	0	85	11	96	11.5	1.5	0
1時間計	82	6	88	6.8	5.9	1	320	50	370	13.5	5.7	3
14:00-14:15	10	1	11	9.1	0.7	1	74	5	79	6.3	1.2	4
14:15-14:30	19	2	21	9.5	1.4	0	77	7	84	8.3	1.3	4
14:30-14:45	11	2	13	15.4	0.9	1	82	11	93	11.8	1.4	3
14:45-15:00	16	1	17	5.9	1.1	1	86	5	91	5.5	1.4	3
1時間計	56	6	62	9.7	4.1	3	319	28	347	8.1	5.3	14

方向別自動車交通量調査表

調査地点：地域社会6 瀬谷中学校前

調査年月日：令和元年 5月14日(火) 天候：雨のち曇り



方向 種別 時間帯	12						D 合計 (10+11+12)					
	小型車 (台)	大型車 (台)	合計 (台)	大型車 混入率 (%)	時間 係数 (%)	二輪車 (台)	小型車 (台)	大型車 (台)	合計 (台)	大型車 混入率 (%)	時間 係数 (%)	二輪車 (台)
15:00-15:15	24	1	25	4.0	1.7	0	102	9	111	8.1	1.7	3
15:15-15:30	22	2	24	8.3	1.6	0	79	6	85	7.1	1.3	2
15:30-15:45	13	1	14	7.1	0.9	1	65	8	73	11.0	1.1	3
15:45-16:00	24	0	24	0.0	1.6	1	103	7	110	6.4	1.7	3
1時間計	83	4	87	4.6	5.8	2	349	30	379	7.9	5.8	11
16:00-16:15	18	1	19	5.3	1.3	1	69	4	73	5.5	1.1	1
16:15-16:30	37	1	38	2.6	2.5	3	103	6	109	5.5	1.7	7
16:30-16:45	24	2	26	7.7	1.7	1	112	7	119	5.9	1.8	5
16:45-17:00	15	1	16	6.3	1.1	2	62	4	66	6.1	1.0	3
1時間計	94	5	99	5.1	6.6	7	346	21	367	5.7	5.6	16
17:00-17:15	13	1	14	7.1	0.9	0	73	2	75	2.7	1.1	3
17:15-17:30	8	1	9	11.1	0.6	2	71	14	85	16.5	1.3	2
17:30-17:45	31	1	32	3.1	2.1	1	102	5	107	4.7	1.6	5
17:45-18:00	14	1	15	6.7	1.0	1	84	2	86	2.3	1.3	2
1時間計	66	4	70	5.7	4.7	4	330	23	353	6.5	5.4	12
18:00-18:15	30	1	31	3.2	2.1	3	118	6	124	4.8	1.9	5
18:15-18:30	22	2	24	8.3	1.6	2	111	6	117	5.1	1.8	5
18:30-18:45	34	3	37	8.1	2.5	4	134	12	146	8.2	2.2	7
18:45-19:00	15	2	17	11.8	1.1	0	88	4	92	4.3	1.4	6
1時間計	101	8	109	7.3	7.3	9	451	28	479	5.8	7.3	23
昼12時間計	974	76	1050	7.2	69.9	38	4294	384	4678	8.2	71.7	129
19:00-19:15	24	1	25	4.0	1.7	0	102	1	103	1.0	1.6	2
19:15-19:30	25	1	26	3.8	1.7	1	90	4	94	4.3	1.4	1
19:30-19:45	30	0	30	0.0	2.0	1	109	7	116	6.0	1.8	4
19:45-20:00	19	0	19	0.0	1.3	1	86	4	90	4.4	1.4	3
1時間計	98	2	100	2.0	6.7	3	387	16	403	4.0	6.2	10
20:00-20:15	27	0	27	0.0	1.8	2	115	1	116	0.9	1.8	5
20:15-20:30	21	0	21	0.0	1.4	1	82	4	86	4.7	1.3	4
20:30-20:45	22	0	22	0.0	1.5	2	81	4	85	4.7	1.3	6
20:45-21:00	18	0	18	0.0	1.2	0	64	2	66	3.0	1.0	6
1時間計	88	0	88	0.0	5.9	5	342	11	353	3.1	5.4	21
21:00-21:15	18	0	18	0.0	1.2	1	54	3	57	5.3	0.9	4
21:15-21:30	13	4	17	23.5	1.1	0	59	7	66	10.6	1.0	4
21:30-21:45	21	0	21	0.0	1.4	0	65	4	69	5.8	1.1	2
21:45-22:00	14	0	14	0.0	0.9	0	69	4	73	5.5	1.1	1
1時間計	66	4	70	5.7	4.7	1	247	18	265	6.8	4.1	11
22:00-22:15	12	0	12	0.0	0.8	0	64	2	66	3.0	1.0	2
22:15-22:30	13	2	15	13.3	1.0	1	41	4	45	8.9	0.7	6
22:30-22:45	14	0	14	0.0	0.9	4	45	0	45	0.0	0.7	6
22:45-23:00	3	0	3	0.0	0.2	1	24	1	25	4.0	0.4	1
1時間計	42	2	44	4.5	2.9	6	174	7	181	3.9	2.8	15

方向別自動車交通量調査表

調査地点：地域社会6 瀬谷中学校前

調査年月日：令和元年 5月14日(火) 天候：雨のち曇り



方向	12						D 合計 (10+11+12)						
	種別	小型車 (台)	大型車 (台)	合計 (台)	大型車混入率 (%)	時間係数 (%)	二輪車 (台)	小型車 (台)	大型車 (台)	合計 (台)	大型車混入率 (%)	時間係数 (%)	二輪車 (台)
23:00-23:15		5	0	5	0.0	0.3	1	23	0	23	0.0	0.4	1
23:15-23:30		5	0	5	0.0	0.3	1	23	0	23	0.0	0.4	1
23:30-23:45		4	0	4	0.0	0.3	0	12	0	12	0.0	0.2	0
23:45-24:00		1	0	1	0.0	0.1	0	16	0	16	0.0	0.2	0
1時間計		15	0	15	0.0	1.0	2	74	0	74	0.0	1.1	2
0:00-0:15		10	0	10	0.0	0.7	0	25	0	25	0.0	0.4	0
0:15-0:30		1	1	2	50.0	0.1	1	16	2	18	11.1	0.3	1
0:30-0:45		4	1	5	20.0	0.3	0	11	2	13	15.4	0.2	0
0:45-1:00		1	0	1	0.0	0.1	0	8	1	9	11.1	0.1	0
1時間計		16	2	18	11.1	1.2	1	60	5	65	7.7	1.0	1
1:00-1:15		3	2	5	40.0	0.3	1	14	2	16	12.5	0.2	1
1:15-1:30		1	0	1	0.0	0.1	0	11	0	11	0.0	0.2	1
1:30-1:45		0	0	0	0.0	0.0	0	7	1	8	12.5	0.1	3
1:45-2:00		1	1	2	50.0	0.1	0	5	1	6	16.7	0.1	0
1時間計		5	3	8	37.5	0.5	1	37	4	41	9.8	0.6	5
2:00-2:15		2	0	2	0.0	0.1	0	9	1	10	10.0	0.2	0
2:15-2:30		1	0	1	0.0	0.1	0	2	2	4	50.0	0.1	0
2:30-2:45		2	1	3	33.3	0.2	1	6	2	8	25.0	0.1	1
2:45-3:00		0	0	0	0.0	0.0	0	6	1	7	14.3	0.1	1
1時間計		5	1	6	16.7	0.4	1	23	6	29	20.7	0.4	2
3:00-3:15		0	0	0	0.0	0.0	0	1	0	1	0.0	0.0	1
3:15-3:30		1	1	2	50.0	0.1	0	2	1	3	33.3	0.0	1
3:30-3:45		0	1	1	100.0	0.1	0	4	2	6	33.3	0.1	0
3:45-4:00		4	0	4	0.0	0.3	0	7	3	10	30.0	0.2	0
1時間計		5	2	7	28.6	0.5	0	14	6	20	30.0	0.3	2
4:00-4:15		0	0	0	0.0	0.0	0	2	0	2	0.0	0.0	0
4:15-4:30		2	0	2	0.0	0.1	0	10	0	10	0.0	0.2	0
4:30-4:45		0	0	0	0.0	0.0	0	6	0	6	0.0	0.1	0
4:45-5:00		0	0	0	0.0	0.0	0	8	1	9	11.1	0.1	2
1時間計		2	0	2	0.0	0.1	0	26	1	27	3.7	0.4	2
5:00-5:15		3	0	3	0.0	0.2	0	9	0	9	0.0	0.1	0
5:15-5:30		8	0	8	0.0	0.5	0	34	0	34	0.0	0.5	1
5:30-5:45		7	0	7	0.0	0.5	0	19	4	23	17.4	0.4	0
5:45-6:00		7	1	8	12.5	0.5	0	35	3	38	7.9	0.6	4
1時間計		25	1	26	3.8	1.7	0	97	7	104	6.7	1.6	5
6:00-6:15		13	1	14	7.1	0.9	0	49	3	52	5.8	0.8	1
6:15-6:30		16	0	16	0.0	1.1	1	81	1	82	1.2	1.3	8
6:30-6:45		17	0	17	0.0	1.1	0	59	3	62	4.8	1.0	4
6:45-7:00		18	3	21	14.3	1.4	0	79	9	88	10.2	1.3	4
1時間計		64	4	68	5.9	4.5	1	268	16	284	5.6	4.4	17
夜12時間計		431	21	452	4.6	30.1	21	1749	97	1846	5.3	28.3	93
全時間合計		1405	97	1502	6.5	100.0	59	6043	481	6524	7.4	100.0	222
昼夜率		1.44	1.28	1.43	-	-	1.55	1.41	1.25	1.39	-	-	1.72

交差点合計自動車交通量調査表

調査地点：地域社会1 目黒

調査年月日：令和元年 5月14日(火) 天候：雨のち曇り

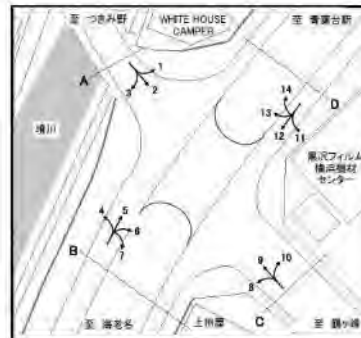

時間帯	種別	交差点合計(1+2+3+4+5+6+7+8+9+10+11+12+13+14)											
		小型車 (台)	大型車 (台)	合計 (台)	大型車 混入率 (%)	時 間 係 数 (%)	二輪車 (台)	小型車 (台)	大型車 (台)	合計 (台)	大型車 混入率 (%)	時 間 係 数 (%)	二輪車 (台)
7:00-7:15		340	156	496	31.5	1.4	22						
7:15-7:30		354	130	484	26.9	1.3	39						
7:30-7:45		362	164	526	31.2	1.5	35						
7:45-8:00		376	135	511	26.4	1.4	40						
8:00-8:15		385	103	488	21.1	1.4	36						
8:15-8:30		320	156	476	32.8	1.3	33						
8:30-8:45		309	134	443	30.2	1.2	16						
8:45-9:00		377	159	536	29.7	1.5	16						
9:00-9:15		305	159	464	34.3	1.3	8						
9:15-9:30		272	123	395	31.1	1.1	7						
9:30-9:45		291	166	457	36.3	1.3	14						
9:45-10:00		276	183	459	39.9	1.3	6						
10:00-10:15		291	184	475	38.7	1.3	16						
10:15-10:30		300	165	465	35.5	1.3	6						
10:30-10:45		296	167	463	36.1	1.3	5						
10:45-11:00		263	188	451	41.7	1.3	9						
11:00-11:15		306	170	476	35.7	1.3	6						
11:15-11:30		319	178	497	35.8	1.4	11						
11:30-11:45		293	188	481	39.1	1.3	5						
11:45-12:00		300	175	475	36.8	1.3	6						
12:00-12:15		275	177	452	39.2	1.3	5						
12:15-12:30		336	179	515	34.8	1.4	8						
12:30-12:45		339	143	482	29.7	1.3	8						
12:45-13:00		327	124	451	27.5	1.3	7						
13:00-13:15		321	143	464	30.8	1.3	7						
13:15-13:30		298	133	431	30.9	1.2	3						
13:30-13:45		305	144	449	32.1	1.2	11						
13:45-14:00		301	157	458	34.3	1.3	2						
14:00-14:15		374	177	551	32.1	1.5	7						
14:15-14:30		311	133	444	30.0	1.2	3						
14:30-14:45		341	167	508	32.9	1.4	5						
14:45-15:00		315	158	473	33.4	1.3	8						
15:00-15:15		365	154	519	29.7	1.4	6						
15:15-15:30		365	124	489	25.4	1.4	7						
15:30-15:45		347	121	468	25.9	1.3	10						
15:45-16:00		317	126	443	28.4	1.2	9						
16:00-16:15		408	142	550	25.8	1.5	12						
16:15-16:30		414	125	539	23.2	1.5	15						
16:30-16:45		362	125	487	25.7	1.4	15						
16:45-17:00		406	124	530	23.4	1.5	17						
17:00-17:15		477	109	586	18.6	1.6	22						
17:15-17:30		473	65	538	12.1	1.5	25						
17:30-17:45		442	90	532	16.9	1.5	26						
17:45-18:00		472	75	547	13.7	1.5	25						
18:00-18:15		525	97	622	15.6	1.7	26						
18:15-18:30		497	73	570	12.8	1.6	21						
18:30-18:45		459	86	545	15.8	1.5	19						
18:45-19:00		374	55	429	12.8	1.2	14						

交差点合計自動車交通量調査表

調査地点：地域社会1 目黒

調査年月日：令和元年 5月14日(火) 天候：雨のち曇り

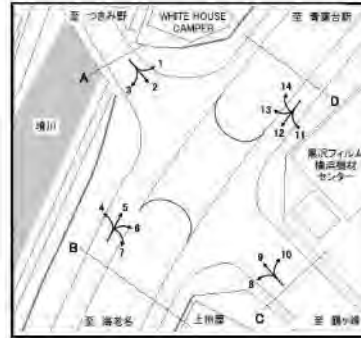

時間帯	種別	交差点合計 (1+2+3+4+5+6+7+8+9+10+11+12+13+14)					
		小型車 (台)	大型車 (台)	合計 (台)	大型車 混入率 (%)	時 間 係 数 (%)	二輪車 (台)
19:00-19:15		467	75	542	13.8	1.5	37
19:15-19:30		434	46	480	9.6	1.3	16
19:30-19:45		390	42	432	9.7	1.2	21
19:45-20:00		404	50	454	11.0	1.3	19
20:00-20:15		381	48	429	11.2	1.2	19
20:15-20:30		368	56	424	13.2	1.2	18
20:30-20:45		360	52	412	12.6	1.1	15
20:45-21:00		369	55	424	13.0	1.2	15
21:00-21:15		301	54	355	15.2	1.0	4
21:15-21:30		346	64	410	15.6	1.1	10
21:30-21:45		236	52	288	18.1	0.8	10
21:45-22:00		231	53	284	18.7	0.8	11
22:00-22:15		242	55	297	18.5	0.8	10
22:15-22:30		248	47	295	15.9	0.8	7
22:30-22:45		229	45	274	16.4	0.8	8
22:45-23:00		187	36	223	16.1	0.6	7
23:00-23:15		158	58	216	26.9	0.6	6
23:15-23:30		116	50	166	30.1	0.5	3
23:30-23:45		120	42	162	25.9	0.4	7
23:45-24:00		95	52	147	35.4	0.4	5
0:00-0:15		86	39	125	31.2	0.3	4
0:15-0:30		98	48	146	32.9	0.4	4
0:30-0:45		71	54	125	43.2	0.3	1
0:45-1:00		80	51	131	38.9	0.4	5
1:00-1:15		95	59	154	38.3	0.4	6
1:15-1:30		57	42	99	42.4	0.3	4
1:30-1:45		64	45	109	41.3	0.3	1
1:45-2:00		34	36	70	51.4	0.2	2
2:00-2:15		48	43	91	47.3	0.3	4
2:15-2:30		55	66	121	54.5	0.3	2
2:30-2:45		33	68	101	67.3	0.3	3
2:45-3:00		48	72	120	60.0	0.3	4
3:00-3:15		47	94	141	66.7	0.4	3
3:15-3:30		37	58	95	61.1	0.3	2
3:30-3:45		64	86	150	57.3	0.4	5
3:45-4:00		35	80	115	69.6	0.3	1
4:00-4:15		77	87	164	53.0	0.5	1
4:15-4:30		55	69	124	55.6	0.3	2
4:30-4:45		59	99	158	62.7	0.4	8
4:45-5:00		106	112	218	51.4	0.6	12
5:00-5:15		117	113	230	49.1	0.6	5
5:15-5:30		168	146	314	46.5	0.9	14
5:30-5:45		201	148	349	42.4	1.0	15
5:45-6:00		241	184	425	43.3	1.2	8
6:00-6:15		272	150	422	35.5	1.2	12
6:15-6:30		320	162	482	33.6	1.3	22
6:30-6:45		338	145	483	30.0	1.3	33
6:45-7:00		351	157	508	30.9	1.4	29
全時間合計		25820	10254	36074	28.4	100.0	1139

交差点合計自動車交通量調査表

調査地点：地域社会2 目黒交番前

調査年月日：令和元年 5月14日(火) 天候：雨のち曇り



時間帯	種別	交差点合計 (1+2+3+4+5+6+7+8+9+10+11+12+13+14)											
		小型車 (台)	大型車 (台)	合計 (台)	大型車 混入率 (%)	時 間 係 数 (%)	二輪車 (台)	小型車 (台)	大型車 (台)	合計 (台)	大型車 混入率 (%)	時 間 係 数 (%)	二輪車 (台)
7:00-7:15		422	115	537	21.4	1.4	34						
7:15-7:30		485	132	617	21.4	1.6	48						
7:30-7:45		465	144	609	23.6	1.5	54						
7:45-8:00		462	112	574	19.5	1.5	41						
8:00-8:15		488	123	611	20.1	1.5	36						
8:15-8:30		397	120	517	23.2	1.3	37						
8:30-8:45		434	134	568	23.6	1.4	17						
8:45-9:00		446	167	613	27.2	1.6	26						
9:00-9:15		402	161	563	28.6	1.4	12						
9:15-9:30		333	172	505	34.1	1.3	8						
9:30-9:45		373	190	563	33.7	1.4	5						
9:45-10:00		380	188	568	33.1	1.4	8						
10:00-10:15		333	186	519	35.8	1.3	8						
10:15-10:30		362	166	528	31.4	1.3	6						
10:30-10:45		360	177	537	33.0	1.4	6						
10:45-11:00		360	182	542	33.6	1.4	14						
11:00-11:15		317	157	474	33.1	1.2	5						
11:15-11:30		345	182	527	34.5	1.3	10						
11:30-11:45		343	183	526	34.8	1.3	6						
11:45-12:00		359	165	524	31.5	1.3	8						
12:00-12:15		368	182	550	33.1	1.4	4						
12:15-12:30		306	160	466	34.3	1.2	10						
12:30-12:45		351	144	495	29.1	1.3	15						
12:45-13:00		380	167	547	30.5	1.4	7						
13:00-13:15		330	139	469	29.6	1.2	4						
13:15-13:30		374	161	535	30.1	1.4	9						
13:30-13:45		363	151	514	29.4	1.3	5						
13:45-14:00		319	134	453	29.6	1.1	8						
14:00-14:15		430	158	588	26.9	1.5	8						
14:15-14:30		310	153	463	33.0	1.2	8						
14:30-14:45		397	162	559	29.0	1.4	15						
14:45-15:00		393	139	532	26.1	1.3	10						
15:00-15:15		410	147	557	26.4	1.4	14						
15:15-15:30		374	128	502	25.5	1.3	10						
15:30-15:45		384	110	494	22.3	1.3	8						
15:45-16:00		383	116	499	23.2	1.3	8						
16:00-16:15		452	135	587	23.0	1.5	11						
16:15-16:30		444	132	576	22.9	1.5	19						
16:30-16:45		366	122	488	25.0	1.2	14						
16:45-17:00		467	132	599	22.0	1.5	16						
17:00-17:15		514	109	623	17.5	1.6	25						
17:15-17:30		560	71	631	11.3	1.6	19						
17:30-17:45		556	89	645	13.8	1.6	37						
17:45-18:00		560	88	648	13.6	1.6	36						
18:00-18:15		515	69	584	11.8	1.5	37						
18:15-18:30		490	75	565	13.3	1.4	28						
18:30-18:45		541	64	605	10.6	1.5	24						
18:45-19:00		528	59	587	10.1	1.5	30						

交差点合計自動車交通量調査表

調査地点：地域社会2 目黒交番前

調査年月日：令和元年 5月14日(火) 天候：雨のち曇り



時間帯	種別	交差点合計 (1+2+3+4+5+6+7+8+9+10+11+12+13+14)											
		小型車 (台)	大型車 (台)	合計 (台)	大型車 混入率 (%)	時間 係数 (%)	二輪車 (台)	小型車 (台)	大型車 (台)	合計 (台)	大型車 混入率 (%)	時間 係数 (%)	二輪車 (台)
19:00-19:15		498	74	572	12.9	1.4	33						
19:15-19:30		478	50	528	9.5	1.3	22						
19:30-19:45		420	36	456	7.9	1.2	21						
19:45-20:00		415	34	449	7.6	1.1	25						
20:00-20:15		393	48	441	10.9	1.1	20						
20:15-20:30		378	49	427	11.5	1.1	23						
20:30-20:45		366	42	408	10.3	1.0	13						
20:45-21:00		327	49	376	13.0	1.0	15						
21:00-21:15		278	42	320	13.1	0.8	13						
21:15-21:30		278	61	339	18.0	0.9	15						
21:30-21:45		232	57	289	19.7	0.7	9						
21:45-22:00		206	43	249	17.3	0.6	15						
22:00-22:15		213	45	258	17.4	0.7	11						
22:15-22:30		262	69	331	20.8	0.8	9						
22:30-22:45		230	55	285	19.3	0.7	9						
22:45-23:00		257	79	336	23.5	0.9	10						
23:00-23:15		156	61	217	28.1	0.5	6						
23:15-23:30		105	39	144	27.1	0.4	0						
23:30-23:45		105	40	145	27.6	0.4	8						
23:45-24:00		86	38	124	30.6	0.3	4						
0:00-0:15		89	41	130	31.5	0.3	2						
0:15-0:30		75	48	123	39.0	0.3	1						
0:30-0:45		92	59	151	39.1	0.4	2						
0:45-1:00		68	53	121	43.8	0.3	2						
1:00-1:15		72	63	135	46.7	0.3	2						
1:15-1:30		59	46	105	43.8	0.3	2						
1:30-1:45		50	38	88	43.2	0.2	4						
1:45-2:00		51	43	94	45.7	0.2	1						
2:00-2:15		40	53	93	57.0	0.2	3						
2:15-2:30		46	41	87	47.1	0.2	1						
2:30-2:45		51	52	103	50.5	0.3	1						
2:45-3:00		38	67	105	63.8	0.3	2						
3:00-3:15		62	60	122	49.2	0.3	1						
3:15-3:30		39	50	89	56.2	0.2	0						
3:30-3:45		67	71	138	51.4	0.3	1						
3:45-4:00		76	62	138	44.9	0.3	7						
4:00-4:15		51	79	130	60.8	0.3	4						
4:15-4:30		76	70	146	47.9	0.4	6						
4:30-4:45		62	81	143	56.6	0.4	14						
4:45-5:00		114	112	226	49.6	0.6	8						
5:00-5:15		137	135	272	49.6	0.7	10						
5:15-5:30		246	149	395	37.7	1.0	20						
5:30-5:45		285	122	407	30.0	1.0	18						
5:45-6:00		351	158	509	31.0	1.3	13						
6:00-6:15		408	145	553	26.2	1.4	25						
6:15-6:30		435	149	584	25.5	1.5	20						
6:30-6:45		479	132	611	21.6	1.5	32						
6:45-7:00		485	115	600	19.2	1.5	26						
全時間合計		29518	9957	39475	25.2	100.0	1337						

交差点合計自動車交通量調査表

調査地点：地域社会3 上川井IC

調査年月日：令和元年 5月14日(火) 天候：雨のち曇り

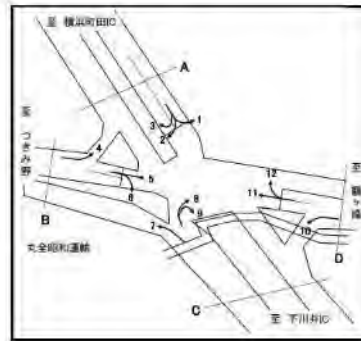

時間帯	種別	交差点合計 (1+2+3+4+5+6+7+8+9+10+11+12)											
		小型車 (台)	大型車 (台)	合計 (台)	大型車 混入率 (%)	時 間 係 数 (%)	二輪車 (台)	小型車 (台)	大型車 (台)	合計 (台)	大型車 混入率 (%)	時 間 係 数 (%)	二輪車 (台)
7:00-7:15		243	106	349	30.4	1.1	18						
7:15-7:30		307	100	407	24.6	1.3	27						
7:30-7:45		287	122	409	29.8	1.3	30						
7:45-8:00		280	109	399	27.3	1.3	31						
8:00-8:15		327	141	468	30.1	1.5	28						
8:15-8:30		335	89	424	21.0	1.4	22						
8:30-8:45		341	125	466	26.8	1.5	18						
8:45-9:00		283	132	415	31.8	1.4	16						
9:00-9:15		262	159	421	37.8	1.4	9						
9:15-9:30		266	157	423	37.1	1.4	3						
9:30-9:45		284	164	448	36.6	1.5	4						
9:45-10:00		260	152	412	36.9	1.4	10						
10:00-10:15		257	163	420	38.8	1.4	5						
10:15-10:30		257	170	427	39.8	1.4	3						
10:30-10:45		266	152	418	36.4	1.4	6						
10:45-11:00		241	153	394	38.8	1.3	8						
11:00-11:15		266	159	425	37.4	1.4	5						
11:15-11:30		276	147	423	34.8	1.4	4						
11:30-11:45		261	154	415	37.1	1.4	7						
11:45-12:00		262	141	403	35.0	1.3	1						
12:00-12:15		278	153	431	35.5	1.4	4						
12:15-12:30		252	155	407	38.1	1.3	4						
12:30-12:45		282	134	416	32.2	1.4	6						
12:45-13:00		251	133	384	34.6	1.3	2						
13:00-13:15		265	136	401	33.9	1.3	2						
13:15-13:30		289	135	424	31.8	1.4	5						
13:30-13:45		269	159	428	37.1	1.4	3						
13:45-14:00		247	142	389	36.5	1.3	3						
14:00-14:15		261	130	391	33.2	1.3	4						
14:15-14:30		258	150	408	36.8	1.3	5						
14:30-14:45		263	123	386	31.9	1.3	9						
14:45-15:00		293	152	445	34.2	1.5	3						
15:00-15:15		291	127	418	30.4	1.4	9						
15:15-15:30		306	132	438	30.1	1.4	10						
15:30-15:45		307	114	421	27.1	1.4	9						
15:45-16:00		329	129	458	28.2	1.5	3						
16:00-16:15		293	121	414	29.2	1.4	10						
16:15-16:30		350	123	473	26.0	1.6	10						
16:30-16:45		345	131	476	27.5	1.6	13						
16:45-17:00		316	128	444	28.8	1.5	11						
17:00-17:15		384	99	483	20.5	1.6	16						
17:15-17:30		425	88	513	17.2	1.7	22						
17:30-17:45		409	86	495	17.4	1.6	32						
17:45-18:00		386	71	457	15.5	1.5	31						
18:00-18:15		398	72	470	15.3	1.5	32						
18:15-18:30		357	74	431	17.2	1.4	19						
18:30-18:45		336	74	410	18.0	1.3	21						
18:45-19:00		375	83	458	18.1	1.5	22						

交差点合計自動車交通量調査表

調査地点：地域社会3 上川井IC

調査年月日：令和元年 5月14日(火) 天候：雨のち曇り

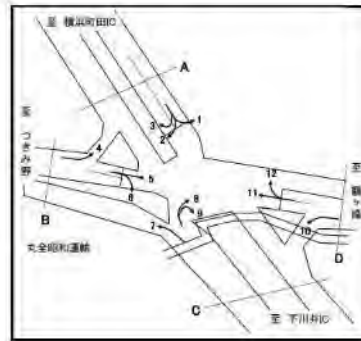

時間帯	交差点合計 (1+2+3+4+5+6+7+8+9+10+11+12)												
	種別	小型車 (台)	大型車 (台)	合計 (台)	大型車 混入率 (%)	時 間 係 数 (%)	二輪車 (台)	小型車 (台)	大型車 (台)	合計 (台)	大型車 混入率 (%)	時 間 係 数 (%)	二輪車 (台)
19:00-19:15		298	53	351	15.1	1.2	15						
19:15-19:30		326	64	390	16.4	1.3	18						
19:30-19:45		314	45	359	12.5	1.2	18						
19:45-20:00		228	28	256	10.9	0.8	18						
20:00-20:15		259	50	309	16.2	1.0	15						
20:15-20:30		254	46	300	15.3	1.0	11						
20:30-20:45		266	34	300	11.3	1.0	6						
20:45-21:00		190	54	244	22.1	0.8	18						
21:00-21:15		185	49	234	20.9	0.8	9						
21:15-21:30		168	52	220	23.6	0.7	6						
21:30-21:45		165	40	205	19.5	0.7	7						
21:45-22:00		165	39	204	19.1	0.7	7						
22:00-22:15		129	49	178	27.5	0.6	3						
22:15-22:30		159	45	204	22.1	0.7	7						
22:30-22:45		158	47	205	22.9	0.7	8						
22:45-23:00		105	46	151	30.5	0.5	9						
23:00-23:15		96	40	136	29.4	0.4	3						
23:15-23:30		79	42	121	34.7	0.4	1						
23:30-23:45		78	37	115	32.2	0.4	5						
23:45-24:00		69	36	105	34.3	0.3	5						
0:00-0:15		56	38	94	40.4	0.3	0						
0:15-0:30		61	40	101	39.6	0.3	3						
0:30-0:45		57	44	101	43.6	0.3	2						
0:45-1:00		40	42	82	51.2	0.3	3						
1:00-1:15		54	55	109	50.5	0.4	4						
1:15-1:30		61	54	115	47.0	0.4	1						
1:30-1:45		40	42	82	51.2	0.3	2						
1:45-2:00		39	34	73	46.6	0.2	1						
2:00-2:15		44	46	90	51.1	0.3	4						
2:15-2:30		24	43	67	64.2	0.2	2						
2:30-2:45		37	51	88	58.0	0.3	0						
2:45-3:00		32	71	103	68.9	0.3	5						
3:00-3:15		32	59	91	64.8	0.3	2						
3:15-3:30		22	44	66	66.7	0.2	2						
3:30-3:45		42	63	105	60.0	0.3	2						
3:45-4:00		30	69	99	69.7	0.3	4						
4:00-4:15		43	59	102	57.8	0.3	2						
4:15-4:30		53	72	125	57.6	0.4	4						
4:30-4:45		67	70	137	51.1	0.5	8						
4:45-5:00		111	103	214	48.1	0.7	12						
5:00-5:15		112	142	254	55.9	0.8	11						
5:15-5:30		150	125	275	45.5	0.9	17						
5:30-5:45		240	141	381	37.0	1.3	24						
5:45-6:00		261	160	421	38.0	1.4	18						
6:00-6:15		322	137	459	29.8	1.5	18						
6:15-6:30		349	131	480	27.3	1.6	24						
6:30-6:45		358	163	521	31.3	1.7	34						
6:45-7:00		299	128	427	30.0	1.4	29						
全時間合計		21,113	9,271	30,384	30.5	100.0	1002						

交差点合計自動車交通量調査表

調査地点：地域社会4 滝沢

調査年月日：令和 2年 9月29日(火) 天候：曇りのち晴れ



時間帯	方向 種別	交差点合計(1+2+3+4+5+6)					
		小型車 (台)	大型車 (台)	合計 (台)	大型車 混入率 (%)	時間 係数 (%)	二輪車 (台)
7:00-7:15		383	60	443	13.5	1.7	43
7:15-7:30		389	81	470	17.2	1.8	35
7:30-7:45		405	87	492	17.7	1.9	34
7:45-8:00		429	58	487	11.9	1.9	30
1時間計		1606	286	1892	15.1	7.4	142
8:00-8:15		441	83	524	15.8	2.1	38
8:15-8:30		384	75	459	16.3	1.8	34
8:30-8:45		336	83	419	19.8	1.6	20
8:45-9:00		294	73	367	19.9	1.4	14
1時間計		1455	314	1769	17.8	6.9	106
9:00-9:15		324	80	404	19.8	1.6	22
9:15-9:30		263	78	341	22.9	1.3	15
9:30-9:45		291	86	377	22.8	1.5	13
9:45-10:00		269	82	351	23.4	1.4	14
1時間計		1147	326	1473	22.1	5.8	64
10:00-10:15		288	99	387	25.6	1.5	19
10:15-10:30		236	69	305	22.6	1.2	15
10:30-10:45		255	82	337	24.3	1.3	11
10:45-11:00		239	98	337	29.1	1.3	15
1時間計		1018	348	1366	25.5	5.4	60
11:00-11:15		236	83	319	26.0	1.3	13
11:15-11:30		237	65	302	21.5	1.2	9
11:30-11:45		300	80	380	21.1	1.5	19
11:45-12:00		251	70	321	21.8	1.3	11
1時間計		1024	298	1322	22.5	5.2	52
12:00-12:15		257	69	326	21.2	1.3	14
12:15-12:30		242	66	308	21.4	1.2	13
12:30-12:45		266	67	333	20.1	1.3	23
12:45-13:00		244	54	298	18.1	1.2	10
1時間計		1009	256	1265	20.2	5.0	60
13:00-13:15		284	85	369	23.0	1.4	12
13:15-13:30		310	50	360	13.9	1.4	7
13:30-13:45		283	78	361	21.6	1.4	12
13:45-14:00		254	64	318	20.1	1.2	16
1時間計		1131	277	1408	19.7	5.5	47
14:00-14:15		248	87	335	26.0	1.3	11
14:15-14:30		283	68	351	19.4	1.4	10
14:30-14:45		266	64	330	19.4	1.3	6
14:45-15:00		291	66	357	18.5	1.4	13
1時間計		1088	285	1373	20.8	5.4	40

交差点合計自動車交通量調査表

調査地点：地域社会4 滝沢

調査年月日：令和 2年 9月29日(火) 天候：曇りのち晴れ



時間帯	種別	交差点合計(1+2+3+4+5+6)					
		小型車 (台)	大型車 (台)	合計 (台)	大型車 混入率 (%)	時間 係数 (%)	二輪車 (台)
15:00-15:15		322	61	383	15.9	1.5	15
15:15-15:30		342	61	403	15.1	1.6	13
15:30-15:45		330	50	380	13.2	1.5	26
15:45-16:00		296	61	357	17.1	1.4	20
1時間計		1290	233	1523	15.3	6.0	74
16:00-16:15		370	70	440	15.9	1.7	17
16:15-16:30		354	55	409	13.4	1.6	11
16:30-16:45		361	60	421	14.3	1.7	22
16:45-17:00		353	45	398	11.3	1.6	27
1時間計		1438	230	1668	13.8	6.6	77
17:00-17:15		382	54	436	12.4	1.7	12
17:15-17:30		365	45	410	11.0	1.6	28
17:30-17:45		496	58	554	10.5	2.2	41
17:45-18:00		437	38	475	8.0	1.9	27
1時間計		1680	195	1875	10.4	7.4	108
18:00-18:15		502	46	548	8.4	2.2	30
18:15-18:30		434	33	467	7.1	1.8	28
18:30-18:45		490	37	527	7.0	2.1	32
18:45-19:00		445	38	483	7.9	1.9	25
1時間計		1871	154	2025	7.6	8.0	115
昼12時間計		15757	3202	18959	16.9	74.5	945
19:00-19:15		422	25	447	5.6	1.8	25
19:15-19:30		419	20	439	4.6	1.7	16
19:30-19:45		396	31	427	7.3	1.7	31
19:45-20:00		278	14	292	4.8	1.1	20
1時間計		1515	90	1605	5.6	6.3	92
20:00-20:15		282	24	306	7.8	1.2	28
20:15-20:30		222	16	238	6.7	0.9	14
20:30-20:45		202	14	216	6.5	0.8	16
20:45-21:00		165	8	173	4.6	0.7	27
1時間計		871	62	933	6.6	3.7	85
21:00-21:15		207	14	221	6.3	0.9	14
21:15-21:30		154	14	168	8.3	0.7	7
21:30-21:45		141	15	156	9.6	0.6	7
21:45-22:00		103	12	115	10.4	0.5	9
1時間計		605	55	660	8.3	2.6	37
22:00-22:15		117	10	127	7.9	0.5	6
22:15-22:30		115	8	123	6.5	0.5	7
22:30-22:45		105	9	114	7.9	0.4	13
22:45-23:00		57	11	68	16.2	0.3	8
1時間計		394	38	432	8.8	1.7	34

交差点合計自動車交通量調査表

調査地点：地域社会4 滝沢

調査年月日：令和 2年 9月29日(火) 天候：曇りのち晴れ



時間帯	方向 種別	交差点合計(1+2+3+4+5+6)					
		小型車 (台)	大型車 (台)	合計 (台)	大型車 混入率 (%)	時間 係数 (%)	二輪車 (台)
23:00-23:15		58	14	72	19.4	0.3	12
23:15-23:30		41	9	50	18.0	0.2	3
23:30-23:45		37	17	54	31.5	0.2	5
23:45-24:00		44	13	57	22.8	0.2	4
1時間計		180	53	233	22.7	0.9	24
0:00-0:15		29	25	54	46.3	0.2	2
0:15-0:30		30	18	48	37.5	0.2	0
0:30-0:45		26	23	49	46.9	0.2	4
0:45-1:00		23	15	38	39.5	0.1	2
1時間計		108	81	189	42.9	0.7	8
1:00-1:15		30	21	51	41.2	0.2	1
1:15-1:30		30	23	53	43.4	0.2	2
1:30-1:45		28	14	42	33.3	0.2	3
1:45-2:00		22	16	38	42.1	0.1	0
1時間計		110	74	184	40.2	0.7	6
2:00-2:15		26	15	41	36.6	0.2	0
2:15-2:30		18	16	34	47.1	0.1	2
2:30-2:45		25	15	40	37.5	0.2	5
2:45-3:00		16	11	27	40.7	0.1	1
1時間計		85	57	142	40.1	0.6	8
3:00-3:15		17	15	32	46.9	0.1	4
3:15-3:30		19	16	35	45.7	0.1	5
3:30-3:45		24	11	35	31.4	0.1	3
3:45-4:00		25	13	38	34.2	0.1	1
1時間計		85	55	140	39.3	0.6	13
4:00-4:15		20	15	35	42.9	0.1	1
4:15-4:30		29	12	41	29.3	0.2	2
4:30-4:45		42	22	64	34.4	0.3	6
4:45-5:00		49	23	72	31.9	0.3	7
1時間計		140	72	212	34.0	0.8	16
5:00-5:15		58	31	89	34.8	0.3	3
5:15-5:30		72	27	99	27.3	0.4	8
5:30-5:45		98	32	130	24.6	0.5	7
5:45-6:00		141	40	181	22.1	0.7	9
1時間計		369	130	499	26.1	2.0	27
6:00-6:15		209	49	258	19.0	1.0	19
6:15-6:30		216	43	259	16.6	1.0	20
6:30-6:45		280	64	344	18.6	1.4	35
6:45-7:00		339	66	405	16.3	1.6	31
1時間計		1044	222	1266	17.5	5.0	105
夜12時間計		5506	989	6495	15.2	25.5	455
18時間計		20366	3722	24088	15.5	94.6	1322
全時間合計		21263	4191	25454	16.5	100.0	1400
昼夜率		1.35	1.31	1.34	-	-	1.48

交差点合計自動車交通量調査表

調査地点：地域社会4 瀬谷土橋公園入口

調査年月日：令和 2年 9月29日(火) 天候：曇りのち晴れ



方向 時間帯	交差点合計(1+2+3+4+5+6)					
	種別 小型車 (台)	大型車 (台)	合計 (台)	大型車 混入率 (%)	時間 係数 (%)	二輪車 (台)
7:00-7:15	342	57	399	14.3	1.8	36
7:15-7:30	345	66	411	16.1	1.9	36
7:30-7:45	351	70	421	16.6	1.9	26
7:45-8:00	363	53	416	12.7	1.9	28
1時間計	1401	246	1647	14.9	7.6	126
8:00-8:15	355	63	418	15.1	1.9	28
8:15-8:30	340	80	420	19.0	1.9	29
8:30-8:45	298	87	385	22.6	1.8	16
8:45-9:00	249	66	315	21.0	1.5	17
1時間計	1242	296	1538	19.2	7.1	90
9:00-9:15	263	81	344	23.5	1.6	16
9:15-9:30	229	74	303	24.4	1.4	15
9:30-9:45	227	85	312	27.2	1.4	9
9:45-10:00	237	70	307	22.8	1.4	10
1時間計	956	310	1266	24.5	5.8	50
10:00-10:15	247	83	330	25.2	1.5	14
10:15-10:30	213	63	276	22.8	1.3	11
10:30-10:45	224	84	308	27.3	1.4	9
10:45-11:00	196	100	296	33.8	1.4	13
1時間計	880	330	1210	27.3	5.6	47
11:00-11:15	204	88	292	30.1	1.3	12
11:15-11:30	226	57	283	20.1	1.3	10
11:30-11:45	221	71	292	24.3	1.3	10
11:45-12:00	228	63	291	21.6	1.3	9
1時間計	879	279	1158	24.1	5.3	41
12:00-12:15	214	61	275	22.2	1.3	15
12:15-12:30	208	58	266	21.8	1.2	16
12:30-12:45	225	62	287	21.6	1.3	19
12:45-13:00	200	52	252	20.6	1.2	8
1時間計	847	233	1080	21.6	5.0	58
13:00-13:15	243	69	312	22.1	1.4	8
13:15-13:30	239	51	290	17.6	1.3	7
13:30-13:45	224	75	299	25.1	1.4	9
13:45-14:00	200	68	268	25.4	1.2	13
1時間計	906	263	1169	22.5	5.4	37
14:00-14:15	214	76	290	26.2	1.3	13
14:15-14:30	201	74	275	26.9	1.3	9
14:30-14:45	234	64	298	21.5	1.4	5
14:45-15:00	227	65	292	22.3	1.3	10
1時間計	876	279	1155	24.2	5.3	37

交差点合計自動車交通量調査表

調査地点：地域社会4 瀬谷土橋公園入口

調査年月日：令和 2年 9月29日(火) 天候：曇りのち晴れ



方向 時間帯	交差点合計(1+2+3+4+5+6)					
	種別 小型車 (台)	大型車 (台)	合計 (台)	大型車 混入率 (%)	時間 係数 (%)	二輪車 (台)
15:00-15:15	269	65	334	19.5	1.5	12
15:15-15:30	282	60	342	17.5	1.6	14
15:30-15:45	288	50	338	14.8	1.6	20
15:45-16:00	212	59	271	21.8	1.2	20
1時間計	1051	234	1285	18.2	5.9	66
16:00-16:15	287	65	352	18.5	1.6	18
16:15-16:30	314	54	368	14.7	1.7	13
16:30-16:45	290	64	354	18.1	1.6	13
16:45-17:00	273	38	311	12.2	1.4	21
1時間計	1164	221	1385	16.0	6.4	65
17:00-17:15	297	43	340	12.6	1.6	16
17:15-17:30	339	33	372	8.9	1.7	24
17:30-17:45	393	37	430	8.6	2.0	38
17:45-18:00	364	42	406	10.3	1.9	22
1時間計	1393	155	1548	10.0	7.1	100
18:00-18:15	392	33	425	7.8	2.0	19
18:15-18:30	369	34	403	8.4	1.9	23
18:30-18:45	390	34	424	8.0	2.0	36
18:45-19:00	365	29	394	7.4	1.8	27
1時間計	1516	130	1646	7.9	7.6	105
昼12時間計	13111	2976	16087	18.5	74.1	822
19:00-19:15	360	23	383	6.0	1.8	23
19:15-19:30	353	23	376	6.1	1.7	17
19:30-19:45	315	30	345	8.7	1.6	24
19:45-20:00	220	17	237	7.2	1.1	15
1時間計	1248	93	1341	6.9	6.2	79
20:00-20:15	247	24	271	8.9	1.2	26
20:15-20:30	187	15	202	7.4	0.9	13
20:30-20:45	184	18	202	8.9	0.9	17
20:45-21:00	130	12	142	8.5	0.7	21
1時間計	748	69	817	8.4	3.8	77
21:00-21:15	159	11	170	6.5	0.8	8
21:15-21:30	147	9	156	5.8	0.7	13
21:30-21:45	112	17	129	13.2	0.6	3
21:45-22:00	88	11	99	11.1	0.5	8
1時間計	506	48	554	8.7	2.6	32
22:00-22:15	91	13	104	12.5	0.5	4
22:15-22:30	91	13	104	12.5	0.5	6
22:30-22:45	93	8	101	7.9	0.5	6
22:45-23:00	53	13	66	19.7	0.3	8
1時間計	328	47	375	12.5	1.7	24

交差点合計自動車交通量調査表

調査地点：地域社会4 瀬谷土橋公園入口

調査年月日：令和 2年 9月29日(火) 天候：曇りのち晴れ



方向 時間帯	交差点合計(1+2+3+4+5+6)					
	種別 小型車 (台)	大型車 (台)	合計 (台)	大型車 混入率 (%)	時間 係数 (%)	二輪車 (台)
23:00-23:15	55	11	66	16.7	0.3	8
23:15-23:30	40	15	55	27.3	0.3	1
23:30-23:45	21	12	33	36.4	0.2	5
23:45-24:00	39	13	52	25.0	0.2	3
1時間計	155	51	206	24.8	0.9	17
0:00-0:15	26	20	46	43.5	0.2	2
0:15-0:30	30	12	42	28.6	0.2	1
0:30-0:45	19	15	34	44.1	0.2	4
0:45-1:00	20	8	28	28.6	0.1	2
1時間計	95	55	150	36.7	0.7	9
1:00-1:15	21	19	40	47.5	0.2	0
1:15-1:30	22	15	37	40.5	0.2	1
1:30-1:45	19	16	35	45.7	0.2	3
1:45-2:00	15	16	31	51.6	0.1	2
1時間計	77	66	143	46.2	0.7	6
2:00-2:15	21	14	35	40.0	0.2	0
2:15-2:30	11	10	21	47.6	0.1	2
2:30-2:45	13	10	23	43.5	0.1	3
2:45-3:00	17	12	29	41.4	0.1	2
1時間計	62	46	108	42.6	0.5	7
3:00-3:15	9	11	20	55.0	0.1	4
3:15-3:30	23	11	34	32.4	0.2	4
3:30-3:45	20	12	32	37.5	0.1	1
3:45-4:00	25	14	39	35.9	0.2	2
1時間計	77	48	125	38.4	0.6	11
4:00-4:15	12	13	25	52.0	0.1	0
4:15-4:30	28	12	40	30.0	0.2	2
4:30-4:45	29	17	46	37.0	0.2	3
4:45-5:00	37	16	53	30.2	0.2	6
1時間計	106	58	164	35.4	0.8	11
5:00-5:15	50	27	77	35.1	0.4	5
5:15-5:30	58	29	87	33.3	0.4	6
5:30-5:45	89	28	117	23.9	0.5	5
5:45-6:00	132	33	165	20.0	0.8	3
1時間計	329	117	446	26.2	2.1	19
6:00-6:15	195	43	238	18.1	1.1	20
6:15-6:30	207	42	249	16.9	1.1	18
6:30-6:45	240	56	296	18.9	1.4	29
6:45-7:00	330	68	398	17.1	1.8	25
1時間計	972	209	1181	17.7	5.4	92
夜12時間計	4703	907	5610	16.2	25.9	384
18時間計	17068	3493	20561	17.0	94.8	1143
全時間合計	17814	3883	21697	17.9	100.0	1206
昼夜率	1.36	1.30	1.35	-	-	1.47

交差点合計自動車交通量調査表

調査地点：地域社会4 瀬谷土橋公園前

調査年月日：令和 2年 9月29日(火) 天候：曇りのち晴れ



方向 時間帯	種別	交差点合計(1+2+3+4+5+6)					
		小型車 (台)	大型車 (台)	合計 (台)	大型車 混入率 (%)	時間 係数 (%)	二輪車 (台)
7:00-7:15		149	40	189	21.2	1.8	4
7:15-7:30		166	45	211	21.3	2.0	11
7:30-7:45		165	37	202	18.3	1.9	8
7:45-8:00		177	42	219	19.2	2.0	6
1時間計		657	164	821	20.0	7.6	29
8:00-8:15		146	45	191	23.6	1.8	7
8:15-8:30		175	38	213	17.8	2.0	6
8:30-8:45		120	37	157	23.6	1.5	9
8:45-9:00		139	41	180	22.8	1.7	3
1時間計		580	161	741	21.7	6.9	25
9:00-9:15		122	48	170	28.2	1.6	5
9:15-9:30		115	43	158	27.2	1.5	5
9:30-9:45		82	52	134	38.8	1.2	1
9:45-10:00		104	35	139	25.2	1.3	1
1時間計		423	178	601	29.6	5.6	12
10:00-10:15		108	45	153	29.4	1.4	3
10:15-10:30		96	31	127	24.4	1.2	4
10:30-10:45		92	55	147	37.4	1.4	2
10:45-11:00		107	52	159	32.7	1.5	3
1時間計		403	183	586	31.2	5.4	12
11:00-11:15		95	57	152	37.5	1.4	3
11:15-11:30		107	45	152	29.6	1.4	7
11:30-11:45		106	47	153	30.7	1.4	2
11:45-12:00		109	48	157	30.6	1.5	4
1時間計		417	197	614	32.1	5.7	16
12:00-12:15		104	74	178	41.6	1.6	1
12:15-12:30		90	57	147	38.8	1.4	2
12:30-12:45		117	58	175	33.1	1.6	6
12:45-13:00		87	61	148	41.2	1.4	4
1時間計		398	250	648	38.6	6.0	13
13:00-13:15		126	52	178	29.2	1.6	4
13:15-13:30		103	51	154	33.1	1.4	1
13:30-13:45		93	42	135	31.1	1.3	3
13:45-14:00		95	45	140	32.1	1.3	2
1時間計		417	190	607	31.3	5.6	10
14:00-14:15		99	53	152	34.9	1.4	6
14:15-14:30		98	58	156	37.2	1.4	3
14:30-14:45		127	34	161	21.1	1.5	2
14:45-15:00		121	56	177	31.6	1.6	3
1時間計		445	201	646	31.1	6.0	14

交差点合計自動車交通量調査表

調査地点：地域社会4 瀬谷土橋公園前

調査年月日：令和 2年 9月29日(火) 天候：曇りのち晴れ



方向 時間帯	交差点合計(1+2+3+4+5+6)					
	種別 小型車 (台)	大型車 (台)	合計 (台)	大型車 混入率 (%)	時間 係数 (%)	二輪車 (台)
15:00-15:15	129	58	187	31.0	1.7	1
15:15-15:30	141	41	182	22.5	1.7	6
15:30-15:45	139	36	175	20.6	1.6	4
15:45-16:00	115	44	159	27.7	1.5	5
1時間計	524	179	703	25.5	6.5	16
16:00-16:15	124	32	156	20.5	1.4	3
16:15-16:30	122	41	163	25.2	1.5	1
16:30-16:45	110	37	147	25.2	1.4	4
16:45-17:00	119	27	146	18.5	1.4	6
1時間計	475	137	612	22.4	5.7	14
17:00-17:15	132	32	164	19.5	1.5	7
17:15-17:30	144	30	174	17.2	1.6	7
17:30-17:45	134	27	161	16.8	1.5	9
17:45-18:00	172	36	208	17.3	1.9	8
1時間計	582	125	707	17.7	6.5	31
18:00-18:15	175	28	203	13.8	1.9	13
18:15-18:30	178	30	208	14.4	1.9	14
18:30-18:45	164	27	191	14.1	1.8	8
18:45-19:00	157	28	185	15.1	1.7	14
1時間計	674	113	787	14.4	7.3	49
昼12時間計	5995	2078	8073	25.7	74.8	241
19:00-19:15	172	26	198	13.1	1.8	10
19:15-19:30	180	27	207	13.0	1.9	6
19:30-19:45	104	22	126	17.5	1.2	4
19:45-20:00	111	22	133	16.5	1.2	5
1時間計	567	97	664	14.6	6.1	25
20:00-20:15	71	16	87	18.4	0.8	4
20:15-20:30	60	11	71	15.5	0.7	2
20:30-20:45	58	11	69	15.9	0.6	5
20:45-21:00	37	8	45	17.8	0.4	4
1時間計	226	46	272	16.9	2.5	15
21:00-21:15	56	14	70	20.0	0.6	2
21:15-21:30	55	18	73	24.7	0.7	3
21:30-21:45	58	16	74	21.6	0.7	0
21:45-22:00	32	11	43	25.6	0.4	1
1時間計	201	59	260	22.7	2.4	6
22:00-22:15	24	13	37	35.1	0.3	1
22:15-22:30	35	12	47	25.5	0.4	5
22:30-22:45	36	11	47	23.4	0.4	2
22:45-23:00	25	8	33	24.2	0.3	3
1時間計	120	44	164	26.8	1.5	11

交差点合計自動車交通量調査表

調査地点：地域社会4 瀬谷土橋公園前

調査年月日：令和 2年 9月29日(火) 天候：曇りのち晴れ



方向 時間帯	交差点合計(1+2+3+4+5+6)					
	種別 小型車 (台)	大型車 (台)	合計 (台)	大型車 混入率 (%)	時間 係数 (%)	二輪車 (台)
23:00-23:15	21	3	24	12.5	0.2	3
23:15-23:30	16	5	21	23.8	0.2	0
23:30-23:45	15	13	28	46.4	0.3	3
23:45-24:00	16	12	28	42.9	0.3	0
1時間計	68	33	101	32.7	0.9	6
0:00-0:15	5	13	18	72.2	0.2	0
0:15-0:30	12	9	21	42.9	0.2	0
0:30-0:45	12	14	26	53.8	0.2	0
0:45-1:00	8	7	15	46.7	0.1	0
1時間計	37	43	80	53.8	0.7	0
1:00-1:15	14	13	27	48.1	0.3	0
1:15-1:30	14	11	25	44.0	0.2	2
1:30-1:45	13	14	27	51.9	0.3	0
1:45-2:00	9	16	25	64.0	0.2	2
1時間計	50	54	104	51.9	1.0	4
2:00-2:15	5	10	15	66.7	0.1	0
2:15-2:30	12	12	24	50.0	0.2	3
2:30-2:45	5	8	13	61.5	0.1	3
2:45-3:00	10	14	24	58.3	0.2	1
1時間計	32	44	76	57.9	0.7	7
3:00-3:15	6	19	25	76.0	0.2	3
3:15-3:30	11	10	21	47.6	0.2	0
3:30-3:45	10	12	22	54.5	0.2	0
3:45-4:00	11	11	22	50.0	0.2	1
1時間計	38	52	90	57.8	0.8	4
4:00-4:15	10	10	20	50.0	0.2	1
4:15-4:30	12	9	21	42.9	0.2	3
4:30-4:45	16	9	25	36.0	0.2	1
4:45-5:00	22	12	34	35.3	0.3	2
1時間計	60	40	100	40.0	0.9	7
5:00-5:15	18	21	39	53.8	0.4	0
5:15-5:30	39	27	66	40.9	0.6	3
5:30-5:45	45	16	61	26.2	0.6	2
5:45-6:00	69	29	98	29.6	0.9	2
1時間計	171	93	264	35.2	2.4	7
6:00-6:15	73	32	105	30.5	1.0	3
6:15-6:30	96	43	139	30.9	1.3	4
6:30-6:45	77	45	122	36.9	1.1	6
6:45-7:00	139	44	183	24.0	1.7	5
1時間計	385	164	549	29.9	5.1	18
夜12時間計	1955	769	2724	28.2	25.2	110
18時間計	7562	2521	10083	25.0	93.4	322
全時間合計	7950	2847	10797	26.4	100.0	351
昼夜率	1.33	1.37	1.34	-	-	1.46

交差点合計自動車交通量調査表

調査地点：地域社会5

調査年月日：令和元年 5月14日(火) 天候：雨のち曇り



方向	交差点合計(1+2+3+4+5+6)						小型車 (台)	大型車 (台)	合計 (台)	大型車 混入率 (%)	時 間 係 数 (%)	二輪車 (台)
	種別	小型車 (台)	大型車 (台)	合計 (台)	大型車 混入率 (%)	時 間 係 数 (%)						
時間帯												
7:00-7:15		337	38	375	10.1	2.0	19					
7:15-7:30		283	39	322	12.1	1.7	34					
7:30-7:45		313	34	347	9.8	1.8	38					
7:45-8:00		274	34	308	11.0	1.6	19					
8:00-8:15		280	30	310	9.7	1.6	28					
8:15-8:30		290	33	323	10.2	1.7	19					
8:30-8:45		267	44	311	14.1	1.6	20					
8:45-9:00		289	40	329	12.2	1.7	14					
9:00-9:15		243	40	283	14.1	1.5	7					
9:15-9:30		226	41	267	15.4	1.4	11					
9:30-9:45		197	58	255	22.7	1.3	8					
9:45-10:00		201	33	234	14.1	1.2	10					
10:00-10:15		218	40	258	15.5	1.4	3					
10:15-10:30		244	35	279	12.5	1.5	4					
10:30-10:45		238	41	279	14.7	1.5	6					
10:45-11:00		236	35	271	12.9	1.4	6					
11:00-11:15		186	47	233	20.2	1.2	5					
11:15-11:30		211	33	244	13.5	1.3	4					
11:30-11:45		217	42	259	16.2	1.4	3					
11:45-12:00		224	39	263	14.8	1.4	4					
12:00-12:15		176	40	216	18.5	1.1	4					
12:15-12:30		211	33	244	13.5	1.3	7					
12:30-12:45		198	40	238	16.8	1.3	8					
12:45-13:00		169	26	195	13.3	1.0	3					
13:00-13:15		245	40	285	14.0	1.5	9					
13:15-13:30		223	40	263	15.2	1.4	12					
13:30-13:45		209	28	237	11.8	1.3	6					
13:45-14:00		227	35	262	13.4	1.4	7					
14:00-14:15		220	38	258	14.7	1.4	14					
14:15-14:30		197	38	235	16.2	1.2	8					
14:30-14:45		261	35	296	11.8	1.6	15					
14:45-15:00		198	27	225	12.0	1.2	7					
15:00-15:15		237	29	266	10.9	1.4	9					
15:15-15:30		282	33	315	10.5	1.7	7					
15:30-15:45		238	21	259	8.1	1.4	7					
15:45-16:00		243	25	268	9.3	1.4	5					
16:00-16:15		279	30	309	9.7	1.6	11					
16:15-16:30		273	25	298	8.4	1.6	17					
16:30-16:45		253	28	281	10.0	1.5	16					
16:45-17:00		239	25	264	9.5	1.4	7					
17:00-17:15		301	12	313	3.8	1.7	14					
17:15-17:30		328	24	352	6.8	1.9	15					
17:30-17:45		294	21	315	6.7	1.7	17					
17:45-18:00		295	23	318	7.2	1.7	25					
18:00-18:15		323	11	334	3.3	1.8	21					
18:15-18:30		315	14	329	4.3	1.7	20					
18:30-18:45		270	11	281	3.9	1.5	10					
18:45-19:00		274	14	288	4.9	1.5	18					

交差点合計自動車交通量調査表

調査地点：地域社会5

調査年月日：令和元年 5月14日(火) 天候：雨のち曇り



時間帯	方向						交差点合計(1+2+3+4+5+6)						
	種別	小型車 (台)	大型車 (台)	合計 (台)	大型車 混入率 (%)	時 間 係 数 (%)	二輪車 (台)	小型車 (台)	大型車 (台)	合計 (台)	大型車 混入率 (%)	時 間 係 数 (%)	二輪車 (台)
19:00-19:15		234	7	241	2.9	1.3	15						
19:15-19:30		256	11	267	4.1	1.4	11						
19:30-19:45		252	6	258	2.3	1.4	14						
19:45-20:00		190	5	195	2.6	1.0	16						
20:00-20:15		223	8	231	3.5	1.2	19						
20:15-20:30		219	6	225	2.7	1.2	14						
20:30-20:45		187	9	196	4.6	1.0	11						
20:45-21:00		169	6	175	3.4	0.9	12						
21:00-21:15		157	5	162	3.1	0.9	7						
21:15-21:30		127	7	134	5.2	0.7	5						
21:30-21:45		110	7	117	6.0	0.6	9						
21:45-22:00		111	8	119	6.7	0.6	10						
22:00-22:15		134	9	143	6.3	0.8	9						
22:15-22:30		115	7	122	5.7	0.6	4						
22:30-22:45		113	8	121	6.6	0.6	8						
22:45-23:00		77	11	88	12.5	0.5	2						
23:00-23:15		73	15	88	17.0	0.5	3						
23:15-23:30		55	5	60	8.3	0.3	3						
23:30-23:45		52	6	58	10.3	0.3	5						
23:45-24:00		38	8	46	17.4	0.2	2						
0:00-0:15		39	4	43	9.3	0.2	3						
0:15-0:30		38	5	43	11.6	0.2	2						
0:30-0:45		23	10	33	30.3	0.2	0						
0:45-1:00		26	8	34	23.5	0.2	2						
1:00-1:15		30	10	40	25.0	0.2	2						
1:15-1:30		22	6	28	21.4	0.1	1						
1:30-1:45		16	13	29	44.8	0.2	2						
1:45-2:00		27	13	40	32.5	0.2	1						
2:00-2:15		19	5	24	20.8	0.1	2						
2:15-2:30		44	15	59	25.4	0.3	3						
2:30-2:45		21	11	32	34.4	0.2	1						
2:45-3:00		10	13	23	56.5	0.1	2						
3:00-3:15		13	12	25	48.0	0.1	2						
3:15-3:30		17	11	28	39.3	0.1	2						
3:30-3:45		24	6	30	20.0	0.2	1						
3:45-4:00		21	10	31	32.3	0.2	2						
4:00-4:15		21	8	29	27.6	0.2	5						
4:15-4:30		36	11	47	23.4	0.2	2						
4:30-4:45		32	16	48	33.3	0.3	8						
4:45-5:00		56	21	77	27.3	0.4	4						
5:00-5:15		58	29	87	33.3	0.5	8						
5:15-5:30		100	16	116	13.8	0.6	7						
5:30-5:45		113	20	133	15.0	0.7	7						
5:45-6:00		151	30	181	16.6	1.0	8						
6:00-6:15		178	37	215	17.2	1.1	15						
6:15-6:30		240	34	274	12.4	1.4	18						
6:30-6:45		291	42	333	12.6	1.8	22						
6:45-7:00		266	28	294	9.5	1.6	33						
全時間合計		16,776	2,140	18,916	11.3	100.0	925						

交差点合計自動車交通量調査表

調査地点：地域社会6 瀬谷中学校前

調査年月日：令和元年 5月14日(火) 天候：雨のち曇り



方向 時間帯	交差点合計(1+2+3+4+5+6+7+8+9+10+11+12)											
	種別 小型車 (台)	大型車 (台)	合計 (台)	大型車 混入率 (%)	時間 係数 (%)	二輪車 (台)	小型車 (台)	大型車 (台)	合計 (台)	大型車 混入率 (%)	時間 係数 (%)	二輪車 (台)
7:00-7:15	510	67	577	11.6	1.8	41						
7:15-7:30	437	51	488	10.5	1.6	18						
7:30-7:45	471	53	524	10.1	1.7	36						
7:45-8:00	447	48	495	9.7	1.6	31						
8:00-8:15	508	42	550	7.6	1.8	33						
8:15-8:30	571	51	622	8.2	2.0	27						
8:30-8:45	483	45	528	8.5	1.7	19						
8:45-9:00	406	47	453	10.4	1.4	12						
9:00-9:15	435	68	503	13.5	1.6	8						
9:15-9:30	376	63	439	14.4	1.4	13						
9:30-9:45	402	66	468	14.1	1.5	9						
9:45-10:00	378	59	437	13.5	1.4	10						
10:00-10:15	374	61	435	14.0	1.4	9						
10:15-10:30	389	59	448	13.2	1.4	9						
10:30-10:45	399	64	463	13.8	1.5	10						
10:45-11:00	375	54	429	12.6	1.4	8						
11:00-11:15	367	77	444	17.3	1.4	6						
11:15-11:30	404	44	448	9.8	1.4	6						
11:30-11:45	362	53	415	12.8	1.3	6						
11:45-12:00	407	54	461	11.7	1.5	9						
12:00-12:15	362	51	413	12.3	1.3	12						
12:15-12:30	364	51	415	12.3	1.3	13						
12:30-12:45	367	56	423	13.2	1.4	10						
12:45-13:00	319	50	369	13.6	1.2	10						
13:00-13:15	312	60	372	16.1	1.2	7						
13:15-13:30	362	45	407	11.1	1.3	7						
13:30-13:45	326	52	378	13.8	1.2	6						
13:45-14:00	374	57	431	13.2	1.4	14						
14:00-14:15	396	37	433	8.5	1.4	10						
14:15-14:30	373	39	412	9.5	1.3	12						
14:30-14:45	411	44	455	9.7	1.5	13						
14:45-15:00	418	41	459	8.9	1.5	10						
15:00-15:15	400	45	445	10.1	1.4	17						
15:15-15:30	400	47	447	10.5	1.4	13						
15:30-15:45	390	55	445	12.4	1.4	14						
15:45-16:00	467	41	508	8.1	1.6	15						
16:00-16:15	446	44	490	9.0	1.6	6						
16:15-16:30	450	47	497	9.5	1.6	19						
16:30-16:45	455	34	489	7.0	1.6	23						
16:45-17:00	409	30	439	6.8	1.4	11						
17:00-17:15	476	33	509	6.5	1.6	20						
17:15-17:30	551	44	595	7.4	1.9	22						
17:30-17:45	512	25	537	4.7	1.7	34						
17:45-18:00	498	22	520	4.2	1.7	22						
18:00-18:15	500	22	522	4.2	1.7	42						
18:15-18:30	525	23	548	4.2	1.8	29						
18:30-18:45	521	30	551	5.4	1.8	28						
18:45-19:00	402	16	418	3.8	1.3	20						

交差点合計自動車交通量調査表

調査地点：地域社会6 瀬谷中学校前

調査年月日：令和元年 5月14日(火) 天候：雨のち曇り



方向	交差点合計(1+2+3+4+5+6+7+8+9+10+11+12)												
	種別	小型車 (台)	大型車 (台)	合計 (台)	大型車 混入率 (%)	時 間 係 数 (%)	二輪車 (台)	小型車 (台)	大型車 (台)	合計 (台)	大型車 混入率 (%)	時 間 係 数 (%)	二輪車 (台)
19:00-19:15		408	13	421	3.1	1.3	20						
19:15-19:30		419	17	436	3.9	1.4	23						
19:30-19:45		444	14	458	3.1	1.5	19						
19:45-20:00		332	12	344	3.5	1.1	22						
20:00-20:15		394	8	402	2.0	1.3	20						
20:15-20:30		371	13	384	3.4	1.2	21						
20:30-20:45		305	18	323	5.6	1.0	14						
20:45-21:00		250	9	259	3.5	0.8	13						
21:00-21:15		252	8	260	3.1	0.8	9						
21:15-21:30		252	14	266	5.3	0.8	12						
21:30-21:45		265	15	280	5.4	0.9	11						
21:45-22:00		240	15	255	5.9	0.8	13						
22:00-22:15		229	8	237	3.4	0.8	10						
22:15-22:30		173	17	190	8.9	0.6	10						
22:30-22:45		176	10	186	5.4	0.6	12						
22:45-23:00		155	7	162	4.3	0.5	9						
23:00-23:15		113	12	125	9.6	0.4	4						
23:15-23:30		100	6	106	5.7	0.3	4						
23:30-23:45		77	3	80	3.8	0.3	3						
23:45-24:00		63	6	69	8.7	0.2	4						
0:00-0:15		73	5	78	6.4	0.2	1						
0:15-0:30		71	10	81	12.3	0.3	3						
0:30-0:45		57	6	63	9.5	0.2	1						
0:45-1:00		56	9	65	13.8	0.2	7						
1:00-1:15		55	14	69	20.3	0.2	6						
1:15-1:30		45	7	52	13.5	0.2	2						
1:30-1:45		55	16	71	22.5	0.2	6						
1:45-2:00		36	13	49	26.5	0.2	4						
2:00-2:15		40	5	45	11.1	0.1	1						
2:15-2:30		18	11	29	37.9	0.1	0						
2:30-2:45		24	6	30	20.0	0.1	2						
2:45-3:00		24	13	37	35.1	0.1	4						
3:00-3:15		25	12	37	32.4	0.1	4						
3:15-3:30		25	11	36	30.6	0.1	1						
3:30-3:45		33	10	43	23.3	0.1	2						
3:45-4:00		35	12	47	25.5	0.2	4						
4:00-4:15		42	12	54	22.2	0.2	7						
4:15-4:30		54	16	70	22.9	0.2	1						
4:30-4:45		60	8	68	11.8	0.2	7						
4:45-5:00		63	20	83	24.1	0.3	7						
5:00-5:15		86	35	121	28.9	0.4	7						
5:15-5:30		149	16	165	9.7	0.5	7						
5:30-5:45		175	30	205	14.6	0.7	14						
5:45-6:00		229	30	259	11.6	0.8	15						
6:00-6:15		271	40	311	12.9	1.0	19						
6:15-6:30		384	40	424	9.4	1.4	29						
6:30-6:45		388	38	426	8.9	1.4	33						
6:45-7:00		428	55	483	11.4	1.5	36						
全時間合計		28,306	2,992	31,298	9.6	100.0	1262						

方向別自動車交通量調査表

調査地点：地域社会1 目黒

調査年月日：令和元年 5月11日(土) 天候：晴れ時々曇り

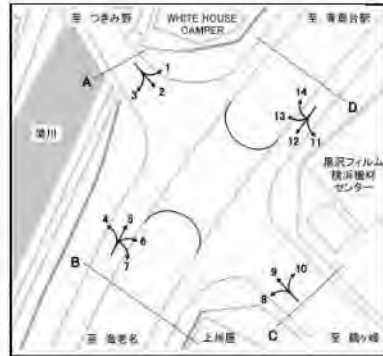

方向	1						2						
	種別	小型車 (台)	大型車 (台)	合計 (台)	大型車 混入率 (%)	時間 係数 (%)	二輪車 (台)	小型車 (台)	大型車 (台)	合計 (台)	大型車 混入率 (%)	時間 係数 (%)	二輪車 (台)
22:00-22:15		15	1	16	6.3	1.0	0	56	6	62	9.7	1.2	3
22:15-22:30		12	2	14	14.3	0.9	0	41	5	46	10.9	0.9	4
22:30-22:45		12	1	13	7.7	0.8	0	40	6	46	13.0	0.9	3
22:45-23:00		9	0	9	0.0	0.6	0	25	8	33	24.2	0.6	5
1時間計		48	4	52	7.7	3.3	0	162	25	187	13.4	3.5	15
23:00-23:15		14	4	18	22.2	1.1	0	41	10	51	19.6	1.0	4
23:15-23:30		9	1	10	10.0	0.6	0	26	0	26	0.0	0.5	3
23:30-23:45		4	1	5	20.0	0.3	1	23	9	32	28.1	0.6	3
23:45-24:00		6	2	8	25.0	0.5	0	13	3	16	18.8	0.3	4
1時間計		33	8	41	19.5	2.6	1	103	22	125	17.6	2.3	14
0:00-0:15		4	2	6	33.3	0.4	0	22	3	25	12.0	0.5	3
0:15-0:30		2	1	3	33.3	0.2	0	18	6	24	25.0	0.4	1
0:30-0:45		3	0	3	0.0	0.2	0	21	4	25	16.0	0.5	0
0:45-1:00		2	0	2	0.0	0.1	0	12	5	17	29.4	0.3	0
1時間計		11	3	14	21.4	0.9	0	73	18	91	19.8	1.7	4
1:00-1:15		2	0	2	0.0	0.1	0	6	7	13	53.8	0.2	1
1:15-1:30		3	1	4	25.0	0.3	0	11	4	15	26.7	0.3	1
1:30-1:45		1	1	2	50.0	0.1	0	11	4	15	26.7	0.3	0
1:45-2:00		3	0	3	0.0	0.2	0	5	2	7	28.6	0.1	0
1時間計		9	2	11	18.2	0.7	0	33	17	50	34.0	0.9	2
2:00-2:15		4	0	4	0.0	0.3	0	13	3	16	18.8	0.3	0
2:15-2:30		4	0	4	0.0	0.3	0	10	6	16	37.5	0.3	0
2:30-2:45		2	2	4	50.0	0.3	0	16	6	22	27.3	0.4	0
2:45-3:00		3	1	4	25.0	0.3	0	9	5	14	35.7	0.3	0
1時間計		13	3	16	18.8	1.0	0	48	20	68	29.4	1.3	0
3:00-3:15		3	1	4	25.0	0.3	0	5	3	8	37.5	0.1	2
3:15-3:30		1	0	1	0.0	0.1	0	8	7	15	46.7	0.3	0
3:30-3:45		7	0	7	0.0	0.4	0	10	11	21	52.4	0.4	1
3:45-4:00		4	0	4	0.0	0.3	0	9	5	14	35.7	0.3	1
1時間計		15	1	16	6.3	1.0	0	32	26	58	44.8	1.1	4
4:00-4:15		2	1	3	33.3	0.2	0	9	8	17	47.1	0.3	2
4:15-4:30		3	1	4	25.0	0.3	1	11	9	20	45.0	0.4	0
4:30-4:45		2	3	5	60.0	0.3	0	9	4	13	30.8	0.2	5
4:45-5:00		1	2	3	66.7	0.2	0	6	5	11	45.5	0.2	2
1時間計		8	7	15	46.7	0.9	1	35	26	61	42.6	1.1	9
5:00-5:15		4	2	6	33.3	0.4	0	15	11	26	42.3	0.5	0
5:15-5:30		7	1	8	12.5	0.5	3	25	12	37	32.4	0.7	2
5:30-5:45		2	0	2	0.0	0.1	0	23	12	35	34.3	0.7	2
5:45-6:00		7	1	8	12.5	0.5	0	27	4	31	12.9	0.6	1
1時間計		20	4	24	16.7	1.5	3	90	39	129	30.2	2.4	5

方向別自動車交通量調査表

調査地点：地域社会1 目黒

調査年月日：令和元年 5月11日(土) 天候：晴れ時々曇り

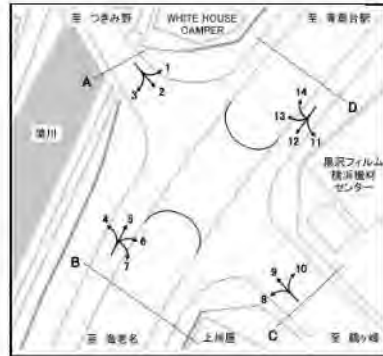

方向 時間帯	1						2					
	種別 小型車 (台)	大型車 (台)	合計 (台)	大型車 混入率 (%)	時間 係数 (%)	二輪車 (台)	小型車 (台)	大型車 (台)	合計 (台)	大型車 混入率 (%)	時間 係数 (%)	二輪車 (台)
6:00-6:15	6	1	7	14.3	0.4	0	26	2	28	7.1	0.5	1
6:15-6:30	5	0	5	0.0	0.3	0	32	4	36	11.1	0.7	5
6:30-6:45	6	4	10	40.0	0.6	3	21	4	25	16.0	0.5	3
6:45-7:00	4	0	4	0.0	0.3	2	20	2	22	9.1	0.4	1
1時間計	21	5	26	19.2	1.6	5	99	12	111	10.8	2.1	10
7:00-7:15	4	2	6	33.3	0.4	0	35	6	41	14.6	0.8	3
7:15-7:30	11	2	13	15.4	0.8	0	44	2	46	4.3	0.9	2
7:30-7:45	13	1	14	7.1	0.9	0	49	12	61	19.7	1.1	4
7:45-8:00	12	4	16	25.0	1.0	0	49	6	55	10.9	1.0	3
1時間計	40	9	49	18.4	3.1	0	177	26	203	12.8	3.8	12
8:00-8:15	14	0	14	0.0	0.9	1	42	3	45	6.7	0.8	3
8:15-8:30	13	0	13	0.0	0.8	0	64	3	67	4.5	1.3	6
8:30-8:45	13	1	14	7.1	0.9	0	74	3	77	3.9	1.4	2
8:45-9:00	14	1	15	6.7	0.9	0	84	4	88	4.5	1.6	9
1時間計	54	2	56	3.6	3.5	1	264	13	277	4.7	5.2	20
9:00-9:15	16	0	16	0.0	1.0	1	59	3	62	4.8	1.2	6
9:15-9:30	16	1	17	5.9	1.1	0	66	7	73	9.6	1.4	7
9:30-9:45	22	1	23	4.3	1.5	0	72	5	77	6.5	1.4	4
9:45-10:00	25	3	28	10.7	1.8	0	59	3	62	4.8	1.2	5
1時間計	79	5	84	6.0	5.3	1	256	18	274	6.6	5.1	22
10:00-10:15	22	0	22	0.0	1.4	1	68	7	75	9.3	1.4	6
10:15-10:30	19	2	21	9.5	1.3	1	52	4	56	7.1	1.0	4
10:30-10:45	21	0	21	0.0	1.3	0	100	5	105	4.8	2.0	4
10:45-11:00	20	2	22	9.1	1.4	0	83	5	88	5.7	1.6	5
1時間計	82	4	86	4.7	5.4	2	303	21	324	6.5	6.0	19
11:00-11:15	28	3	31	9.7	2.0	2	89	2	91	2.2	1.7	1
11:15-11:30	18	2	20	10.0	1.3	1	82	5	87	5.7	1.6	4
11:30-11:45	42	0	42	0.0	2.6	1	83	4	87	4.6	1.6	5
11:45-12:00	21	1	22	4.5	1.4	0	63	4	67	6.0	1.3	5
1時間計	109	6	115	5.2	7.3	4	317	15	332	4.5	6.2	15
12:00-12:15	28	3	31	9.7	2.0	3	62	5	67	7.5	1.3	2
12:15-12:30	21	0	21	0.0	1.3	0	65	3	68	4.4	1.3	5
12:30-12:45	25	4	29	13.8	1.8	1	98	3	101	3.0	1.9	4
12:45-13:00	12	0	12	0.0	0.8	0	58	5	63	7.9	1.2	1
1時間計	86	7	93	7.5	5.9	4	283	16	299	5.4	5.6	12
13:00-13:15	18	0	18	0.0	1.1	1	55	4	59	6.8	1.1	1
13:15-13:30	24	0	24	0.0	1.5	1	95	5	100	5.0	1.9	5
13:30-13:45	14	1	15	6.7	0.9	1	39	0	39	0.0	0.7	1
13:45-14:00	13	2	15	13.3	0.9	1	35	5	40	12.5	0.7	2
1時間計	69	3	72	4.2	4.5	4	224	14	238	5.9	4.4	9

方向別自動車交通量調査表

調査地点：地域社会1 目黒

調査年月日：令和元年 5月11日(土) 天候：晴れ時々曇り

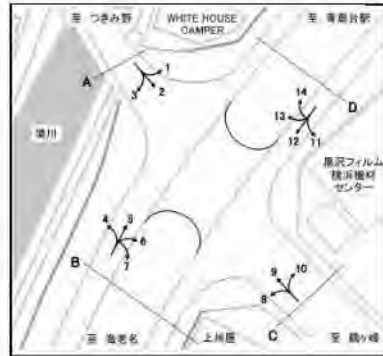

方向 種別 時間帯	1						2					
	小型車 (台)	大型車 (台)	合計 (台)	大型車 混入率 (%)	時間 係数 (%)	二輪車 (台)	小型車 (台)	大型車 (台)	合計 (台)	大型車 混入率 (%)	時間 係数 (%)	二輪車 (台)
14:00-14:15	27	2	29	6.9	1.8	0	88	12	100	12.0	1.9	3
14:15-14:30	25	2	27	7.4	1.7	2	75	5	80	6.3	1.5	2
14:30-14:45	25	0	25	0.0	1.6	0	79	6	85	7.1	1.6	4
14:45-15:00	25	1	26	3.8	1.6	2	83	5	88	5.7	1.6	4
1時間計	102	5	107	4.7	6.7	4	325	28	353	7.9	6.6	13
15:00-15:15	23	2	25	8.0	1.6	1	75	5	80	6.3	1.5	6
15:15-15:30	30	1	31	3.2	2.0	6	87	5	92	5.4	1.7	4
15:30-15:45	29	0	29	0.0	1.8	0	86	5	91	5.5	1.7	0
15:45-16:00	31	0	31	0.0	2.0	4	72	5	77	6.5	1.4	5
1時間計	113	3	116	2.6	7.3	11	320	20	340	5.9	6.3	15
16:00-16:15	22	2	24	8.3	1.5	0	90	6	96	6.3	1.8	5
16:15-16:30	34	0	34	0.0	2.1	0	87	3	90	3.3	1.7	2
16:30-16:45	27	0	27	0.0	1.7	1	82	8	90	8.9	1.7	3
16:45-17:00	31	3	34	8.8	2.1	0	95	8	103	7.8	1.9	4
1時間計	114	5	119	4.2	7.5	1	354	25	379	6.6	7.1	14
17:00-17:15	31	5	36	13.9	2.3	0	83	7	90	7.8	1.7	2
17:15-17:30	23	4	27	14.8	1.7	0	79	3	82	3.7	1.5	0
17:30-17:45	36	0	36	0.0	2.3	-3	117	5	122	4.1	2.3	8
17:45-18:00	26	2	28	7.1	1.8	0	87	5	92	5.4	1.7	4
1時間計	116	11	127	8.7	8.0	3	366	20	386	5.2	7.2	14
18:00-18:15	19	4	23	17.4	1.5	1	74	6	80	7.5	1.5	4
18:15-18:30	28	3	31	9.7	2.0	1	77	5	82	6.1	1.5	6
18:30-18:45	24	3	27	11.1	1.7	0	83	1	84	1.2	1.6	4
18:45-19:00	25	2	27	7.4	1.7	0	59	6	65	9.2	1.2	3
1時間計	96	12	108	11.1	6.8	2	293	18	311	5.8	5.8	17
19:00-19:15	29	1	30	3.3	1.9	1	91	10	101	9.9	1.9	3
19:15-19:30	24	4	28	14.3	1.8	1	65	4	69	5.8	1.3	5
19:30-19:45	24	1	25	4.0	1.6	1	75	4	79	5.1	1.5	7
19:45-20:00	23	0	23	0.0	1.5	3	65	4	69	5.8	1.3	2
1時間計	100	6	106	5.7	6.7	6	296	22	318	6.9	5.9	17
20:00-20:15	19	2	21	9.5	1.3	1	66	3	69	4.3	1.3	4
20:15-20:30	18	2	20	10.0	1.3	1	41	7	48	14.6	0.9	2
20:30-20:45	16	1	17	5.9	1.1	2	54	2	56	3.6	1.0	1
20:45-21:00	10	0	10	0.0	0.6	0	60	5	65	7.7	1.2	1
1時間計	63	5	68	7.4	4.3	4	221	17	238	7.1	4.4	8
21:00-21:15	16	2	18	11.1	1.1	0	51	7	58	12.1	1.1	4
21:15-21:30	21	2	23	8.7	1.5	1	44	10	54	18.5	1.0	0
21:30-21:45	8	1	9	11.1	0.6	2	41	5	46	10.9	0.9	4
21:45-22:00	15	0	15	0.0	0.9	1	40	6	46	13.0	0.9	4
1時間計	60	5	65	7.7	4.1	4	176	28	204	13.7	3.8	12
昼12時間計	1060	72	1132	6.4	71.4	37	3482	234	3716	6.3	69.4	182
夜12時間計	401	53	454	11.7	28.6	24	1368	272	1640	16.6	30.6	100
全時間合計	1461	125	1586	7.9	100.0	61	4850	506	5356	9.4	100.0	282
昼夜率	1.38	1.74	1.40	-	-	1.65	1.39	2.16	1.44	-	-	1.55

方向別自動車交通量調査表

調査地点 : 地域社会1 目黒

調査年月日 : 令和元年 5月11日(土) 天候:晴れ時々曇り

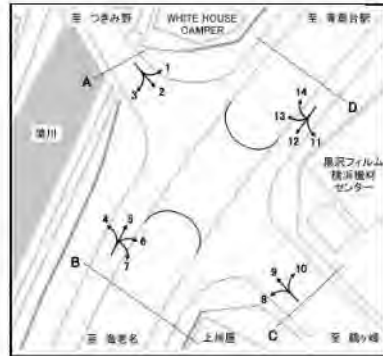

方向 種別 時間帯	3						A 合計 (1+ 3)					
	小型車 (台)	大型車 (台)	合計 (台)	大型車 混入率 (%)	時間 係数 (%)	二輪車 (台)	小型車 (台)	大型車 (台)	合計 (台)	大型車 混入率 (%)	時間 係数 (%)	二輪車 (台)
22:00-22:15	13	1	14	7.1	0.9	0	84	8	92	8.7	1.1	3
22:15-22:30	13	0	13	0.0	0.9	0	66	7	73	9.6	0.9	4
22:30-22:45	13	1	14	7.1	0.9	1	65	8	73	11.0	0.9	4
22:45-23:00	14	1	15	6.7	1.0	1	48	9	57	15.8	0.7	6
1時間計	53	3	56	5.4	3.8	2	263	32	295	10.8	3.5	17
23:00-23:15	13	0	13	0.0	0.9	1	68	14	82	17.1	1.0	5
23:15-23:30	10	1	11	9.1	0.7	0	45	2	47	4.3	0.6	3
23:30-23:45	16	0	16	0.0	1.1	0	43	10	53	18.9	0.6	4
23:45-24:00	6	1	7	14.3	0.5	0	25	6	31	19.4	0.4	4
1時間計	45	2	47	4.3	3.2	1	181	32	213	15.0	2.5	16
0:00- 0:15	12	9	21	42.9	1.4	1	38	14	52	26.9	0.6	4
0:15- 0:30	9	0	9	0.0	0.6	0	29	7	36	19.4	0.4	1
0:30- 0:45	12	1	13	7.7	0.9	0	36	5	41	12.2	0.5	0
0:45- 1:00	7	2	9	22.2	0.6	0	21	7	28	25.0	0.3	0
1時間計	40	12	52	23.1	3.5	1	124	33	157	21.0	1.9	5
1:00- 1:15	10	1	11	9.1	0.7	1	18	8	26	30.8	0.3	2
1:15- 1:30	1	0	1	0.0	0.1	0	15	5	20	25.0	0.2	1
1:30- 1:45	14	1	15	6.7	1.0	0	26	6	32	18.8	0.4	0
1:45- 2:00	1	0	1	0.0	0.1	0	9	2	11	18.2	0.1	0
1時間計	26	2	28	7.1	1.9	1	68	21	89	23.6	1.1	3
2:00- 2:15	7	2	9	22.2	0.6	1	24	5	29	17.2	0.3	1
2:15- 2:30	5	1	6	16.7	0.4	1	19	7	26	26.9	0.3	1
2:30- 2:45	6	0	6	0.0	0.4	2	24	8	32	25.0	0.4	2
2:45- 3:00	6	0	6	0.0	0.4	1	18	6	24	25.0	0.3	1
1時間計	24	3	27	11.1	1.8	5	85	26	111	23.4	1.3	5
3:00- 3:15	10	2	12	16.7	0.8	0	18	6	24	25.0	0.3	2
3:15- 3:30	6	1	7	14.3	0.5	0	15	8	23	34.8	0.3	0
3:30- 3:45	2	1	3	33.3	0.2	0	19	12	31	38.7	0.4	1
3:45- 4:00	3	2	5	40.0	0.3	0	16	7	23	30.4	0.3	1
1時間計	21	6	27	22.2	1.8	0	68	33	101	32.7	1.2	4
4:00- 4:15	5	1	6	16.7	0.4	0	16	10	26	38.5	0.3	2
4:15- 4:30	2	0	2	0.0	0.1	0	16	10	26	38.5	0.3	1
4:30- 4:45	0	0	0	0.0	0.0	0	11	7	18	38.9	0.2	5
4:45- 5:00	4	0	4	0.0	0.3	0	11	7	18	38.9	0.2	2
1時間計	11	1	12	8.3	0.8	0	54	34	88	38.6	1.0	10
5:00- 5:15	7	1	8	12.5	0.5	0	26	14	40	35.0	0.5	0
5:15- 5:30	4	0	4	0.0	0.3	1	36	13	49	26.5	0.6	6
5:30- 5:45	3	0	3	0.0	0.2	1	28	12	40	30.0	0.5	3
5:45- 6:00	3	0	3	0.0	0.2	1	37	5	42	11.9	0.5	2
1時間計	17	1	18	5.6	1.2	3	127	44	171	25.7	2.0	11

方向別自動車交通量調査表

調査地点：地域社会1 目黒

調査年月日：令和元年 5月11日(土) 天候：晴れ時々曇り

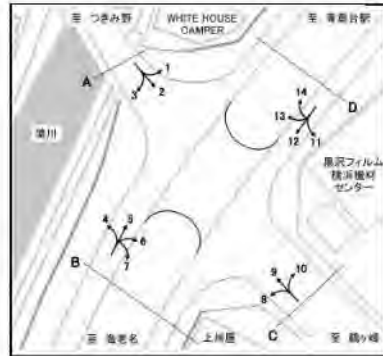

時間帯	種別	3						A 合計 (1+ 3)					
		小型車 (台)	大型車 (台)	合計 (台)	大型車 混入率 (%)	時間 係数 (%)	二輪車 (台)	小型車 (台)	大型車 (台)	合計 (台)	大型車 混入率 (%)	時間 係数 (%)	二輪車 (台)
6:00-6:15		7	2	9	22.2	0.6	1	39	5	44	11.4	0.5	2
6:15-6:30		5	0	5	0.0	0.3	1	42	4	46	8.7	0.5	6
6:30-6:45		8	2	10	20.0	0.7	1	35	10	45	22.2	0.5	7
6:45-7:00		13	1	14	7.1	0.9	0	37	3	40	7.5	0.5	3
1時間計		33	5	38	13.2	2.6	3	153	22	175	12.6	2.1	18
7:00-7:15		13	0	13	0.0	0.9	4	52	8	60	13.3	0.7	7
7:15-7:30		16	2	18	11.1	1.2	0	71	6	77	7.8	0.9	2
7:30-7:45		14	0	14	0.0	0.9	2	76	13	89	14.6	1.1	6
7:45-8:00		13	0	13	0.0	0.9	2	74	10	84	11.9	1.0	5
1時間計		56	2	58	3.4	3.9	8	273	37	310	11.9	3.7	20
8:00-8:15		24	1	25	4.0	1.7	1	80	4	84	4.8	1.0	5
8:15-8:30		23	0	23	0.0	1.5	1	100	3	103	2.9	1.2	7
8:30-8:45		42	1	43	2.3	2.9	1	129	5	134	3.7	1.6	3
8:45-9:00		17	0	17	0.0	1.1	0	115	5	120	4.2	1.4	9
1時間計		106	2	108	1.9	7.3	3	424	17	441	3.9	5.2	24
9:00-9:15		16	1	17	5.9	1.1	1	91	4	95	4.2	1.1	8
9:15-9:30		13	2	15	13.3	1.0	0	95	10	105	9.5	1.2	7
9:30-9:45		19	1	20	5.0	1.3	0	113	7	120	5.8	1.4	4
9:45-10:00		36	3	39	7.7	2.6	2	120	9	129	7.0	1.5	7
1時間計		84	7	91	7.7	6.1	3	419	30	449	6.7	5.3	26
10:00-10:15		59	4	63	6.3	4.2	9	149	11	160	6.9	1.9	16
10:15-10:30		15	1	16	6.3	1.1	0	86	7	93	7.5	1.1	5
10:30-10:45		30	0	30	0.0	2.0	2	151	5	156	3.2	1.9	6
10:45-11:00		16	2	18	11.1	1.2	1	119	9	128	7.0	1.5	6
1時間計		120	7	127	5.5	8.5	12	505	32	537	6.0	6.4	33
11:00-11:15		18	0	18	0.0	1.2	2	135	5	140	3.6	1.7	5
11:15-11:30		26	0	26	0.0	1.7	0	126	7	133	5.3	1.6	5
11:30-11:45		14	2	16	12.5	1.1	0	139	6	145	4.1	1.7	6
11:45-12:00		22	0	22	0.0	1.5	0	106	5	111	4.5	1.3	5
1時間計		80	2	82	2.4	5.5	2	506	23	529	4.3	6.3	21
12:00-12:15		24	0	24	0.0	1.6	2	114	8	122	6.6	1.4	7
12:15-12:30		14	0	14	0.0	0.9	1	100	3	103	2.9	1.2	6
12:30-12:45		14	2	16	12.5	1.1	1	137	9	146	6.2	1.7	6
12:45-13:00		15	7	22	31.8	1.5	2	85	12	97	12.4	1.2	3
1時間計		67	9	76	11.8	5.1	6	436	32	468	6.8	5.6	22
13:00-13:15		10	0	10	0.0	0.7	0	83	4	87	4.6	1.0	2
13:15-13:30		15	0	15	0.0	1.0	1	134	5	139	3.6	1.6	7
13:30-13:45		14	1	15	6.7	1.0	0	67	2	69	2.9	0.8	2
13:45-14:00		11	0	11	0.0	0.7	1	59	7	66	10.6	0.8	4
1時間計		50	1	51	2.0	3.4	2	343	18	361	5.0	4.3	15

方向別自動車交通量調査表

調査地点：地域社会1 目黒

調査年月日：令和元年 5月11日(土) 天候：晴れ時々曇り

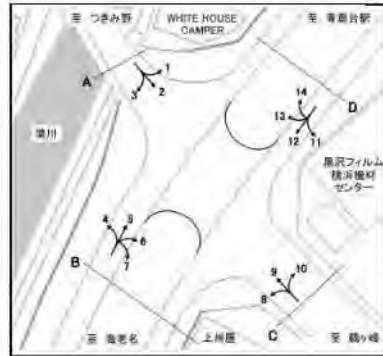

方向	3						A 合計 (1+ 3)					
	種別 小型車 (台)	大型車 (台)	合計 (台)	大型車 混入率 (%)	時間 係数 (%)	二輪車 (台)	小型車 (台)	大型車 (台)	合計 (台)	大型車 混入率 (%)	時間 係数 (%)	二輪車 (台)
14:00-14:15	16	0	16	0.0	1.1	0	131	14	145	9.7	1.7	3
14:15-14:30	26	0	26	0.0	1.7	0	126	7	133	5.3	1.6	4
14:30-14:45	16	1	17	5.9	1.1	1	120	7	127	5.5	1.5	5
14:45-15:00	16	0	16	0.0	1.1	3	124	6	130	4.6	1.5	9
1時間計	74	1	75	1.3	5.0	4	501	34	535	6.4	6.3	21
15:00-15:15	22	1	23	4.3	1.5	1	120	8	128	6.3	1.5	8
15:15-15:30	24	0	24	0.0	1.6	2	141	6	147	4.1	1.7	12
15:30-15:45	31	0	31	0.0	2.1	0	146	5	151	3.3	1.8	0
15:45-16:00	23	1	24	4.2	1.6	2	126	6	132	4.5	1.6	11
1時間計	100	2	102	2.0	6.9	5	533	25	558	4.5	6.6	31
16:00-16:15	17	0	17	0.0	1.1	0	129	8	137	5.8	1.6	5
16:15-16:30	21	2	23	8.7	1.5	2	142	5	147	3.4	1.7	4
16:30-16:45	8	1	9	11.1	0.6	1	117	9	126	7.1	1.5	5
16:45-17:00	13	1	14	7.1	0.9	1	139	12	151	7.9	1.8	5
1時間計	59	4	63	6.3	4.2	4	527	34	561	6.1	6.7	19
17:00-17:15	11	1	12	8.3	0.8	2	125	13	138	9.4	1.6	4
17:15-17:30	12	0	12	0.0	0.8	0	114	7	121	5.8	1.4	0
17:30-17:45	19	1	20	5.0	1.3	0	172	6	178	3.4	2.1	11
17:45-18:00	19	0	19	0.0	1.3	2	132	7	139	5.0	1.6	6
1時間計	61	2	63	3.2	4.2	4	543	33	576	5.7	6.8	21
18:00-18:15	19	2	21	9.5	1.4	2	112	12	124	9.7	1.5	7
18:15-18:30	16	1	17	5.9	1.1	1	121	9	130	6.9	1.5	8
18:30-18:45	19	0	19	0.0	1.3	1	126	4	130	3.1	1.5	5
18:45-19:00	9	2	11	18.2	0.7	0	93	10	103	9.7	1.2	3
1時間計	63	5	68	7.4	4.6	4	452	35	487	7.2	5.8	23
19:00-19:15	12	2	14	14.3	0.9	1	132	13	145	9.0	1.7	5
19:15-19:30	27	0	27	0.0	1.8	2	116	8	124	6.5	1.5	8
19:30-19:45	14	1	15	6.7	1.0	0	113	6	119	5.0	1.4	8
19:45-20:00	26	1	27	3.7	1.8	0	114	5	119	4.2	1.4	5
1時間計	79	4	83	4.8	5.6	3	475	32	507	6.3	6.0	26
20:00-20:15	18	1	19	5.3	1.3	0	103	6	109	5.5	1.3	5
20:15-20:30	18	0	18	0.0	1.2	0	77	9	86	10.5	1.0	3
20:30-20:45	22	2	24	8.3	1.6	2	92	5	97	5.2	1.2	5
20:45-21:00	10	1	11	9.1	0.7	0	80	6	86	7.0	1.0	1
1時間計	68	4	72	5.6	4.8	2	352	26	378	6.9	4.5	14
21:00-21:15	16	0	16	0.0	1.1	0	83	9	92	9.8	1.1	4
21:15-21:30	13	1	14	7.1	0.9	2	78	13	91	14.3	1.1	3
21:30-21:45	14	1	15	6.7	1.0	1	63	7	70	10.0	0.8	7
21:45-22:00	18	1	19	5.3	1.3	1	73	7	80	8.8	0.9	6
1時間計	61	3	64	4.7	4.3	4	297	36	333	10.8	4.0	20
昼12時間計	920	44	964	4.6	64.8	57	5462	350	5812	6.0	68.9	276
夜12時間計	478	46	524	8.8	35.2	25	2247	371	2618	14.2	31.1	149
全時間合計	1398	90	1488	6.0	100.0	82	7709	721	8430	8.6	100.0	425
昼夜率	1.52	2.05	1.54	-	-	1.44	1.41	2.06	1.45	-	-	1.54

方向別自動車交通量調査表

調査地点：地域社会1 目黒

調査年月日：令和元年 5月11日(土) 天候：晴れ時々曇り

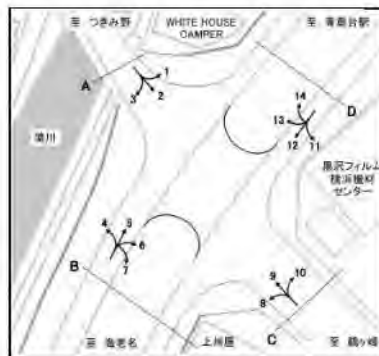

方向	4						5						
	種別	小型車 (台)	大型車 (台)	合計 (台)	大型車 混入率 (%)	時間 係数 (%)	二輪車 (台)	小型車 (台)	大型車 (台)	合計 (台)	大型車 混入率 (%)	時間 係数 (%)	二輪車 (台)
22:00-22:15		12	0	12	0.0	0.9	0	9	0	9	0.0	1.1	0
22:15-22:30		13	1	14	7.1	1.0	0	6	0	6	0.0	0.7	0
22:30-22:45		9	0	9	0.0	0.6	0	2	0	2	0.0	0.2	1
22:45-23:00		10	0	10	0.0	0.7	0	7	0	7	0.0	0.8	0
1時間計		44	1	45	2.2	3.2	0	24	0	24	0.0	2.9	1
23:00-23:15		9	1	10	10.0	0.7	0	2	1	3	33.3	0.4	0
23:15-23:30		13	0	13	0.0	0.9	0	1	0	1	0.0	0.1	0
23:30-23:45		5	0	5	0.0	0.4	0	2	0	2	0.0	0.2	0
23:45-24:00		17	1	18	5.6	1.3	1	2	0	2	0.0	0.2	0
1時間計		44	2	46	4.3	3.3	1	7	1	8	12.5	1.0	0
0:00-0:15		6	1	7	14.3	0.5	0	0	0	0	0.0	0.0	0
0:15-0:30		7	0	7	0.0	0.5	0	5	0	5	0.0	0.6	0
0:30-0:45		6	1	7	14.3	0.5	0	1	0	1	0.0	0.1	0
0:45-1:00		3	0	3	0.0	0.2	1	0	1	1	100.0	0.1	0
1時間計		22	2	24	8.3	1.7	1	6	1	7	14.3	0.8	0
1:00-1:15		4	0	4	0.0	0.3	1	0	0	0	0.0	0.0	0
1:15-1:30		5	3	8	37.5	0.6	0	2	0	2	0.0	0.2	0
1:30-1:45		7	3	10	30.0	0.7	1	1	1	2	50.0	0.2	0
1:45-2:00		4	2	6	33.3	0.4	0	1	2	3	66.7	0.4	0
1時間計		20	8	28	28.6	2.0	2	4	3	7	42.9	0.8	0
2:00-2:15		5	0	5	0.0	0.4	0	0	1	1	100.0	0.1	1
2:15-2:30		6	1	7	14.3	0.5	1	2	1	3	33.3	0.4	1
2:30-2:45		5	4	9	44.4	0.6	0	0	1	1	100.0	0.1	0
2:45-3:00		7	5	12	41.7	0.9	0	1	0	1	0.0	0.1	0
1時間計		23	10	33	30.3	2.4	1	3	3	6	50.0	0.7	2
3:00-3:15		3	0	3	0.0	0.2	1	2	0	2	0.0	0.2	0
3:15-3:30		3	0	3	0.0	0.2	0	3	1	4	25.0	0.5	0
3:30-3:45		2	0	2	0.0	0.1	0	4	0	4	0.0	0.5	0
3:45-4:00		1	0	1	0.0	0.1	0	1	0	1	0.0	0.1	0
1時間計		9	0	9	0.0	0.6	1	10	1	11	9.1	1.3	0
4:00-4:15		1	0	1	0.0	0.1	0	1	1	2	50.0	0.2	0
4:15-4:30		1	0	1	0.0	0.1	0	1	1	2	50.0	0.2	1
4:30-4:45		0	3	3	100.0	0.2	0	1	0	1	0.0	0.1	1
4:45-5:00		3	0	3	0.0	0.2	0	3	0	3	0.0	0.4	0
1時間計		5	3	8	37.5	0.6	0	6	2	8	25.0	1.0	2
5:00-5:15		4	0	4	0.0	0.3	0	1	0	1	0.0	0.1	0
5:15-5:30		5	2	7	28.6	0.5	0	10	0	10	0.0	1.2	0
5:30-5:45		5	0	5	0.0	0.4	0	2	0	2	0.0	0.2	0
5:45-6:00		4	1	5	20.0	0.4	0	5	2	7	28.6	0.8	0
1時間計		18	3	21	14.3	1.5	0	18	2	20	10.0	2.4	0

方向別自動車交通量調査表

調査地点 : 地域社会1 目黒

調査年月日 : 令和元年 5月11日(土) 天候:晴れ時々曇り

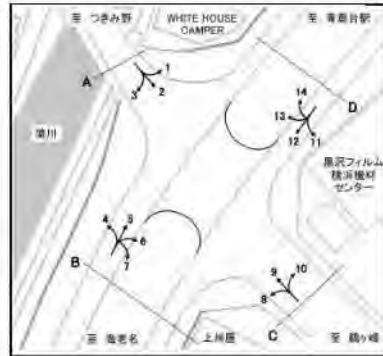

方向 時間帯	4						5					
	種別 小型車 (台)	大型車 (台)	合計 (台)	大型車 混入率 (%)	時間 係数 (%)	二輪車 (台)	小型車 (台)	大型車 (台)	合計 (台)	大型車 混入率 (%)	時間 係数 (%)	二輪車 (台)
6:00-6:15	3	0	3	0.0	0.2	0	6	0	6	0.0	0.7	0
6:15-6:30	2	0	2	0.0	0.1	2	7	3	10	30.0	1.2	1
6:30-6:45	5	0	5	0.0	0.4	0	6	0	6	0.0	0.7	1
6:45-7:00	6	0	6	0.0	0.4	0	8	1	9	11.1	1.1	1
1時間計	16	0	16	0.0	1.2	2	27	4	31	12.9	3.7	3
7:00-7:15	7	2	9	22.2	0.6	0	6	4	10	40.0	1.2	0
7:15-7:30	5	1	6	16.7	0.4	0	9	0	9	0.0	1.1	1
7:30-7:45	17	1	18	5.6	1.3	2	13	1	14	7.1	1.7	1
7:45-8:00	5	2	7	28.6	0.5	0	24	1	25	4.0	3.0	3
1時間計	34	6	40	15.0	2.9	2	52	6	58	10.3	7.0	5
8:00-8:15	12	1	13	7.7	0.9	1	7	1	8	12.5	1.0	8
8:15-8:30	14	2	16	12.5	1.2	0	18	0	18	0.0	2.2	2
8:30-8:45	9	1	10	10.0	0.7	0	7	0	7	0.0	0.8	0
8:45-9:00	17	2	19	10.5	1.4	0	5	0	5	0.0	0.6	0
1時間計	52	6	58	10.3	4.2	1	37	1	38	2.6	4.6	10
9:00-9:15	15	0	15	0.0	1.1	1	7	0	7	0.0	0.8	0
9:15-9:30	21	0	21	0.0	1.5	3	11	2	13	15.4	1.6	0
9:30-9:45	15	0	15	0.0	1.1	0	10	0	10	0.0	1.2	0
9:45-10:00	18	1	19	5.3	1.4	0	14	0	14	0.0	1.7	1
1時間計	69	1	70	1.4	5.0	4	42	2	44	4.5	5.3	1
10:00-10:15	17	0	17	0.0	1.2	0	17	1	18	5.6	2.2	0
10:15-10:30	33	0	33	0.0	2.4	1	18	2	20	10.0	2.4	2
10:30-10:45	14	1	15	6.7	1.1	1	5	2	7	28.6	0.8	1
10:45-11:00	20	1	21	4.8	1.5	0	8	0	8	0.0	1.0	1
1時間計	84	2	86	2.3	6.2	2	48	5	53	9.4	6.4	4
11:00-11:15	22	0	22	0.0	1.6	0	9	0	9	0.0	1.1	0
11:15-11:30	25	1	26	3.8	1.9	0	9	2	11	18.2	1.3	3
11:30-11:45	32	0	32	0.0	2.3	0	9	1	10	10.0	1.2	0
11:45-12:00	25	0	25	0.0	1.8	0	16	1	17	5.9	2.0	1
1時間計	104	1	105	1.0	7.5	0	43	4	47	8.5	5.6	4
12:00-12:15	24	0	24	0.0	1.7	0	10	1	11	9.1	1.3	2
12:15-12:30	27	1	28	3.6	2.0	0	14	3	17	17.6	2.0	1
12:30-12:45	26	2	28	7.1	2.0	1	8	0	8	0.0	1.0	1
12:45-13:00	27	2	29	6.9	2.1	0	14	1	15	6.7	1.8	1
1時間計	104	5	109	4.6	7.8	1	46	5	51	9.8	6.1	5
13:00-13:15	25	1	26	3.8	1.9	3	11	0	11	0.0	1.3	1
13:15-13:30	23	1	24	4.2	1.7	0	12	0	12	0.0	1.4	1
13:30-13:45	19	0	19	0.0	1.4	2	11	0	11	0.0	1.3	2
13:45-14:00	25	2	27	7.4	1.9	3	12	2	14	14.3	1.7	2
1時間計	92	4	96	4.2	6.9	8	46	2	48	4.2	5.8	6

方向別自動車交通量調査表

調査地点：地域社会1 目黒

調査年月日：令和元年 5月11日(土) 天候：晴れ時々曇り

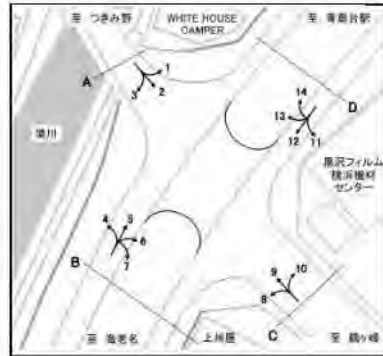

方向 種別 時間帯	4						5					
	小型車 (台)	大型車 (台)	合計 (台)	大型車 混入率 (%)	時間 係数 (%)	二輪車 (台)	小型車 (台)	大型車 (台)	合計 (台)	大型車 混入率 (%)	時間 係数 (%)	二輪車 (台)
14:00-14:15	19	1	20	5.0	1.4	2	10	1	11	9.1	1.3	1
14:15-14:30	26	0	26	0.0	1.9	2	7	1	8	12.5	1.0	0
14:30-14:45	24	2	26	7.7	1.9	1	12	3	15	20.0	1.8	1
14:45-15:00	24	0	24	0.0	1.7	0	6	0	6	0.0	0.7	0
1時間計	93	3	96	3.1	6.9	5	35	5	40	12.5	4.8	2
15:00-15:15	12	1	13	7.7	0.9	0	12	0	12	0.0	1.4	0
15:15-15:30	26	0	26	0.0	1.9	2	23	0	23	0.0	2.8	1
15:30-15:45	23	0	23	0.0	1.7	0	22	0	22	0.0	2.6	4
15:45-16:00	21	1	22	4.5	1.6	0	12	0	12	0.0	1.4	2
1時間計	82	2	84	2.4	6.0	2	69	0	69	0.0	8.3	7
16:00-16:15	22	1	23	4.3	1.7	2	13	1	14	7.1	1.7	1
16:15-16:30	25	0	25	0.0	1.8	0	17	0	17	0.0	2.0	1
16:30-16:45	13	1	14	7.1	1.0	1	8	0	8	0.0	1.0	1
16:45-17:00	13	0	13	0.0	0.9	2	14	0	14	0.0	1.7	1
1時間計	73	2	75	2.7	5.4	5	52	1	53	1.9	6.4	4
17:00-17:15	15	0	15	0.0	1.1	1	14	0	14	0.0	1.7	0
17:15-17:30	13	1	14	7.1	1.0	1	13	0	13	0.0	1.6	2
17:30-17:45	19	1	20	5.0	1.4	1	14	0	14	0.0	1.7	2
17:45-18:00	23	0	23	0.0	1.7	3	11	2	13	15.4	1.6	0
1時間計	70	2	72	2.8	5.2	6	52	2	54	3.7	6.5	4
18:00-18:15	26	0	26	0.0	1.9	0	10	1	11	9.1	1.3	1
18:15-18:30	31	2	33	6.1	2.4	0	15	1	16	6.3	1.9	2
18:30-18:45	24	1	25	4.0	1.8	0	11	2	13	15.4	1.6	1
18:45-19:00	23	0	23	0.0	1.7	0	3	0	3	0.0	0.4	0
1時間計	104	3	107	2.8	7.7	0	39	4	43	9.3	5.2	4
19:00-19:15	17	2	19	10.5	1.4	0	14	0	14	0.0	1.7	2
19:15-19:30	11	1	12	8.3	0.9	0	14	0	14	0.0	1.7	1
19:30-19:45	17	1	18	5.6	1.3	1	7	0	7	0.0	0.8	0
19:45-20:00	16	0	16	0.0	1.2	0	7	1	8	12.5	1.0	0
1時間計	61	4	65	6.2	4.7	1	42	1	43	2.3	5.2	3
20:00-20:15	22	0	22	0.0	1.6	0	25	1	26	3.8	3.1	0
20:15-20:30	16	1	17	5.9	1.2	0	5	0	5	0.0	0.6	0
20:30-20:45	15	2	17	11.8	1.2	1	10	1	11	9.1	1.3	0
20:45-21:00	18	0	18	0.0	1.3	1	7	0	7	0.0	0.8	0
1時間計	71	3	74	4.1	5.3	2	47	2	49	4.1	5.9	0
21:00-21:15	9	0	9	0.0	0.6	0	10	0	10	0.0	1.2	1
21:15-21:30	5	0	5	0.0	0.4	0	4	0	4	0.0	0.5	0
21:30-21:45	8	0	8	0.0	0.6	2	5	0	5	0.0	0.6	1
21:45-22:00	2	0	2	0.0	0.1	0	0	2	2	100.0	0.2	0
1時間計	24	0	24	0.0	1.7	2	19	2	21	9.5	2.5	2
昼12時間計	961	37	998	3.7	71.7	36	561	37	598	6.2	71.8	56
夜12時間計	357	36	393	9.2	28.3	13	213	22	235	9.4	28.2	13
全時間合計	1318	73	1391	5.2	100.0	49	774	59	833	7.1	100.0	69
昼夜率	1.37	1.97	1.39	-	-	1.36	1.38	1.59	1.39	-	-	1.23

方向別自動車交通量調査表

調査地点：地域社会1 目黒

調査年月日：令和元年 5月11日(土) 天候：晴れ時々曇り

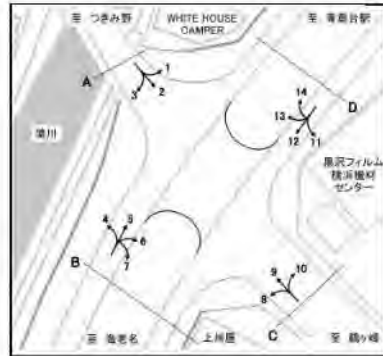

方向	6						7					
	小型車 (台)	大型車 (台)	合計 (台)	大型車 混入率 (%)	時間 係数 (%)	二輪車 (台)	小型車 (台)	大型車 (台)	合計 (台)	大型車 混入率 (%)	時間 係数 (%)	二輪車 (台)
22:00-22:15	46	11	57	19.3	1.6	5	0	0	0	0.0	0.0	0
22:15-22:30	21	3	24	12.5	0.7	5	0	0	0	0.0	0.0	0
22:30-22:45	17	4	21	19.0	0.6	4	0	0	0	0.0	0.0	0
22:45-23:00	31	6	37	16.2	1.0	0	0	0	0	0.0	0.0	0
1時間計	115	24	139	17.3	3.9	14	0	0	0	0.0	0.0	0
23:00-23:15	35	12	47	25.5	1.3	1	2	0	2	0.0	4.7	0
23:15-23:30	15	7	22	31.8	0.6	2	0	0	0	0.0	0.0	0
23:30-23:45	15	2	17	11.8	0.5	0	1	0	1	0.0	2.3	0
23:45-24:00	13	3	16	18.8	0.5	2	1	0	1	0.0	2.3	0
1時間計	78	24	102	23.5	2.9	5	4	0	4	0.0	9.3	0
0:00-0:15	22	6	28	21.4	0.8	1	1	0	1	0.0	2.3	0
0:15-0:30	10	4	14	28.6	0.4	1	0	0	0	0.0	0.0	0
0:30-0:45	9	6	15	40.0	0.4	1	1	0	1	0.0	2.3	0
0:45-1:00	8	5	13	38.5	0.4	0	1	0	1	0.0	2.3	0
1時間計	49	21	70	30.0	2.0	3	3	0	3	0.0	7.0	0
1:00-1:15	9	3	12	25.0	0.3	0	0	0	0	0.0	0.0	0
1:15-1:30	12	6	18	33.3	0.5	0	0	0	0	0.0	0.0	0
1:30-1:45	8	7	15	46.7	0.4	0	0	0	0	0.0	0.0	0
1:45-2:00	7	6	13	46.2	0.4	0	0	0	0	0.0	0.0	0
1時間計	36	22	58	37.9	1.6	0	0	0	0	0.0	0.0	0
2:00-2:15	8	7	15	46.7	0.4	0	0	0	0	0.0	0.0	0
2:15-2:30	9	8	17	47.1	0.5	0	0	0	0	0.0	0.0	0
2:30-2:45	7	3	10	30.0	0.3	1	0	0	0	0.0	0.0	0
2:45-3:00	8	7	15	46.7	0.4	0	1	0	1	0.0	2.3	0
1時間計	32	25	57	43.9	1.6	1	1	0	1	0.0	2.3	0
3:00-3:15	3	6	9	66.7	0.3	0	0	0	0	0.0	0.0	0
3:15-3:30	2	4	6	66.7	0.2	0	0	0	0	0.0	0.0	0
3:30-3:45	2	7	9	77.8	0.3	0	0	0	0	0.0	0.0	0
3:45-4:00	0	4	4	100.0	0.1	0	0	0	0	0.0	0.0	0
1時間計	7	21	28	75.0	0.8	0	0	0	0	0.0	0.0	0
4:00-4:15	2	3	5	60.0	0.1	0	0	0	0	0.0	0.0	0
4:15-4:30	2	7	9	77.8	0.3	0	0	0	0	0.0	0.0	0
4:30-4:45	5	12	17	70.6	0.5	0	1	0	1	0.0	2.3	0
4:45-5:00	11	6	17	35.3	0.5	1	1	0	1	0.0	2.3	0
1時間計	20	28	48	58.3	1.4	1	2	0	2	0.0	4.7	0
5:00-5:15	10	4	14	28.6	0.4	2	1	0	1	0.0	2.3	0
5:15-5:30	10	8	18	44.4	0.5	1	1	0	1	0.0	2.3	0
5:30-5:45	11	10	21	47.6	0.6	3	0	0	0	0.0	0.0	0
5:45-6:00	14	4	18	22.2	0.5	1	0	0	0	0.0	0.0	0
1時間計	45	26	71	36.6	2.0	7	2	0	2	0.0	4.7	0

方向別自動車交通量調査表

調査地点：地域社会1 目黒

調査年月日：令和元年 5月11日(土) 天候：晴れ時々曇り

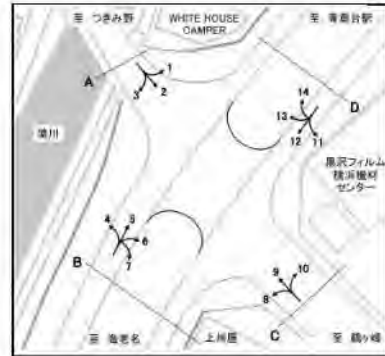

方向	6						7						
	種別	小型車 (台)	大型車 (台)	合計 (台)	大型車 混入率 (%)	時間 係数 (%)	二輪車 (台)	小型車 (台)	大型車 (台)	合計 (台)	大型車 混入率 (%)	時間 係数 (%)	二輪車 (台)
6:00-6:15		21	6	27	22.2	0.8	3	2	0	2	0.0	4.7	0
6:15-6:30		19	7	26	26.9	0.7	4	0	0	0	0.0	0.0	0
6:30-6:45		26	4	30	13.3	0.8	0	0	0	0	0.0	0.0	0
6:45-7:00		29	11	40	27.5	1.1	1	0	0	0	0.0	0.0	0
1時間計		95	28	123	22.8	3.5	8	2	0	2	0.0	4.7	0
7:00-7:15		27	6	33	18.2	0.9	0	0	0	0	0.0	0.0	0
7:15-7:30		27	7	34	20.6	1.0	2	1	0	1	0.0	2.3	0
7:30-7:45		26	6	32	18.8	0.9	4	1	0	1	0.0	2.3	0
7:45-8:00		40	5	45	11.1	1.3	3	0	0	0	0.0	0.0	0
1時間計		120	24	144	16.7	4.1	9	2	0	2	0.0	4.7	0
8:00-8:15		37	8	45	17.8	1.3	3	0	0	0	0.0	0.0	0
8:15-8:30		56	11	67	16.4	1.9	2	0	0	0	0.0	0.0	0
8:30-8:45		41	11	52	21.2	1.5	0	0	0	0	0.0	0.0	0
8:45-9:00		27	5	32	15.6	0.9	1	1	0	1	0.0	2.3	0
1時間計		161	35	196	17.9	5.5	6	1	0	1	0.0	2.3	0
9:00-9:15		33	5	38	13.2	1.1	3	0	0	0	0.0	0.0	0
9:15-9:30		47	4	51	7.8	1.4	3	0	0	0	0.0	0.0	0
9:30-9:45		30	6	36	16.7	1.0	1	0	0	0	0.0	0.0	0
9:45-10:00		48	10	58	17.2	1.6	0	0	0	0	0.0	0.0	0
1時間計		158	25	183	13.7	5.2	7	0	0	0	0.0	0.0	0
10:00-10:15		59	7	66	10.6	1.9	1	0	0	0	0.0	0.0	0
10:15-10:30		30	3	33	9.1	0.9	0	0	0	0	0.0	0.0	0
10:30-10:45		36	3	39	7.7	1.1	2	1	0	1	0.0	2.3	0
10:45-11:00		49	4	53	7.5	1.5	0	0	0	0	0.0	0.0	0
1時間計		174	17	191	8.9	5.4	3	1	0	1	0.0	2.3	0
11:00-11:15		52	8	60	13.3	1.7	3	1	0	1	0.0	2.3	0
11:15-11:30		46	7	53	13.2	1.5	1	0	0	0	0.0	0.0	0
11:30-11:45		45	7	52	13.5	1.5	4	2	0	2	0.0	4.7	0
11:45-12:00		36	8	44	18.2	1.2	1	1	0	1	0.0	2.3	0
1時間計		179	30	209	14.4	5.9	9	4	0	4	0.0	9.3	0
12:00-12:15		46	5	51	9.8	1.4	2	0	0	0	0.0	0.0	0
12:15-12:30		49	8	57	14.0	1.6	1	2	0	2	0.0	4.7	0
12:30-12:45		49	12	61	19.7	1.7	4	0	0	0	0.0	0.0	0
12:45-13:00		51	11	62	17.7	1.7	1	0	0	0	0.0	0.0	0
1時間計		195	36	231	15.6	6.5	8	2	0	2	0.0	4.7	0
13:00-13:15		44	0	44	0.0	1.2	2	1	0	1	0.0	2.3	0
13:15-13:30		54	3	57	5.3	1.6	3	0	0	0	0.0	0.0	0
13:30-13:45		58	5	63	7.9	1.8	4	2	0	2	0.0	4.7	0
13:45-14:00		65	3	68	4.4	1.9	6	1	0	1	0.0	2.3	0
1時間計		221	11	232	4.7	6.5	15	4	0	4	0.0	9.3	0

方向別自動車交通量調査表

調査地点：地域社会1 目黒

調査年月日：令和元年 5月11日(土) 天候：晴れ時々曇り

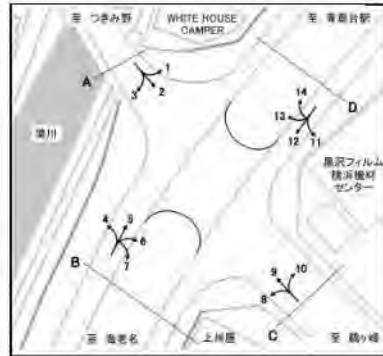

方向	6						7						
	種別	小型車 (台)	大型車 (台)	合計 (台)	大型車 混入率 (%)	時間 係数 (%)	二輪車 (台)	小型車 (台)	大型車 (台)	合計 (台)	大型車 混入率 (%)	時間 係数 (%)	二輪車 (台)
14:00-14:15		39	5	44	11.4	1.2	5	1	0	1	0.0	2.3	0
14:15-14:30		46	1	47	2.1	1.3	2	1	0	1	0.0	2.3	0
14:30-14:45		35	4	39	10.3	1.1	3	1	0	1	0.0	2.3	0
14:45-15:00		25	1	26	3.8	0.7	6	1	0	1	0.0	2.3	0
1時間計		145	11	156	7.1	4.4	16	4	0	4	0.0	9.3	0
15:00-15:15		36	4	40	10.0	1.1	2	0	0	0	0.0	0.0	0
15:15-15:30		59	13	72	18.1	2.0	6	3	1	4	25.0	9.3	0
15:30-15:45		45	5	50	10.0	1.4	7	1	0	1	0.0	2.3	0
15:45-16:00		65	6	71	8.5	2.0	6	2	0	2	0.0	4.7	0
1時間計		205	28	233	12.0	6.6	21	6	1	7	14.3	16.3	0
16:00-16:15		54	5	59	8.5	1.7	8	0	0	0	0.0	0.0	0
16:15-16:30		40	2	42	4.8	1.2	2	1	0	1	0.0	2.3	0
16:30-16:45		46	5	51	9.8	1.4	2	0	0	0	0.0	0.0	0
16:45-17:00		41	4	45	8.9	1.3	4	0	0	0	0.0	0.0	0
1時間計		181	16	197	8.1	5.5	16	1	0	1	0.0	2.3	0
17:00-17:15		47	5	52	9.6	1.5	1	0	0	0	0.0	0.0	0
17:15-17:30		57	6	63	9.5	1.8	2	0	0	0	0.0	0.0	0
17:30-17:45		33	8	41	19.5	1.2	2	0	0	0	0.0	0.0	0
17:45-18:00		41	9	50	18.0	1.4	3	0	0	0	0.0	0.0	0
1時間計		178	28	206	13.6	5.8	8	0	0	0	0.0	0.0	0
18:00-18:15		50	3	53	5.7	1.5	2	0	0	0	0.0	0.0	0
18:15-18:30		32	6	38	15.8	1.1	2	0	0	0	0.0	0.0	0
18:30-18:45		39	9	48	18.8	1.4	0	0	0	0	0.0	0.0	0
18:45-19:00		49	5	54	9.3	1.5	0	0	0	0	0.0	0.0	0
1時間計		170	23	193	11.9	5.4	4	0	0	0	0.0	0.0	0
19:00-19:15		43	5	48	10.4	1.4	3	0	0	0	0.0	0.0	0
19:15-19:30		46	10	56	17.9	1.6	3	2	0	2	0.0	4.7	0
19:30-19:45		52	7	59	11.9	1.7	1	1	0	1	0.0	2.3	0
19:45-20:00		44	4	48	8.3	1.4	3	0	0	0	0.0	0.0	0
1時間計		185	26	211	12.3	5.9	10	3	0	3	0.0	7.0	0
20:00-20:15		54	12	66	18.2	1.9	1	0	0	0	0.0	0.0	0
20:15-20:30		50	6	56	10.7	1.6	0	0	0	0	0.0	0.0	0
20:30-20:45		33	8	41	19.5	1.2	2	0	0	0	0.0	0.0	0
20:45-21:00		14	8	22	36.4	0.6	1	0	0	0	0.0	0.0	0
1時間計		151	34	185	18.4	5.2	4	0	0	0	0.0	0.0	0
21:00-21:15		18	7	25	28.0	0.7	1	0	0	0	0.0	0.0	0
21:15-21:30		10	0	10	0.0	0.3	0	0	0	0	0.0	0.0	0
21:30-21:45		21	5	26	19.2	0.7	0	0	0	0	0.0	0.0	0
21:45-22:00		18	8	26	30.8	0.7	1	0	0	0	0.0	0.0	0
1時間計		67	20	87	23.0	2.5	2	0	0	0	0.0	0.0	0
昼12時間計		2087	284	2371	12.0	66.8	122	25	1	26	3.8	60.5	0
夜12時間計		880	299	1179	25.4	33.2	55	17	0	17	0.0	39.5	0
全時間合計		2967	583	3550	16.4	100.0	177	42	1	43	2.3	100.0	0
昼夜率		1.42	2.05	1.50	-	-	1.45	1.68	1.00	1.65	-	-	0.00

方向別自動車交通量調査表

調査地点：地域社会1 目黒

調査年月日：令和元年 5月11日(土) 天候：晴れ時々曇り

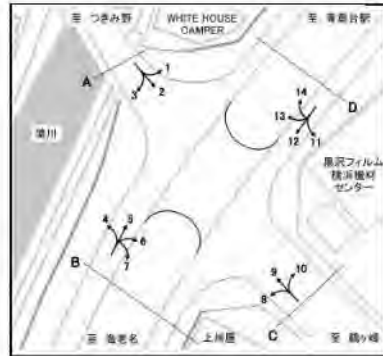

方向 種別 時間帯							B 合計 (4+ 5+ 6+ 7)					
	小型車 (台)	大型車 (台)	合計 (台)	大型車 混入率 (%)	時間 係数 (%)	二輪車 (台)	小型車 (台)	大型車 (台)	合計 (台)	大型車 混入率 (%)	時間 係数 (%)	二輪車 (台)
22:00-22:15							67	11	78	14.1	1.3	5
22:15-22:30							40	4	44	9.1	0.8	5
22:30-22:45							28	4	32	12.5	0.6	5
22:45-23:00							48	6	54	11.1	0.9	0
1時間計							183	25	208	12.0	3.6	15
23:00-23:15							48	14	62	22.6	1.1	1
23:15-23:30							29	7	36	19.4	0.6	2
23:30-23:45							23	2	25	8.0	0.4	0
23:45-24:00							33	4	37	10.8	0.6	3
1時間計							133	27	160	16.9	2.8	6
0:00- 0:15							29	7	36	19.4	0.6	1
0:15- 0:30							22	4	26	15.4	0.4	1
0:30- 0:45							17	7	24	29.2	0.4	1
0:45- 1:00							12	6	18	33.3	0.3	1
1時間計							80	24	104	23.1	1.8	4
1:00- 1:15							13	3	16	18.8	0.3	1
1:15- 1:30							19	9	28	32.1	0.5	0
1:30- 1:45							16	11	27	40.7	0.5	1
1:45- 2:00							12	10	22	45.5	0.4	0
1時間計							60	33	93	35.5	1.6	2
2:00- 2:15							13	8	21	38.1	0.4	1
2:15- 2:30							17	10	27	37.0	0.5	2
2:30- 2:45							12	8	20	40.0	0.3	1
2:45- 3:00							17	12	29	41.4	0.5	0
1時間計							59	38	97	39.2	1.7	4
3:00- 3:15							8	6	14	42.9	0.2	1
3:15- 3:30							8	5	13	38.5	0.2	0
3:30- 3:45							8	7	15	46.7	0.3	0
3:45- 4:00							2	4	6	66.7	0.1	0
1時間計							26	22	48	45.8	0.8	1
4:00- 4:15							4	4	8	50.0	0.1	0
4:15- 4:30							4	8	12	66.7	0.2	1
4:30- 4:45							7	15	22	68.2	0.4	1
4:45- 5:00							18	6	24	25.0	0.4	1
1時間計							33	33	66	50.0	1.1	3
5:00- 5:15							16	4	20	20.0	0.3	2
5:15- 5:30							26	10	36	27.8	0.6	1
5:30- 5:45							18	10	28	35.7	0.5	3
5:45- 6:00							23	7	30	23.3	0.5	1
1時間計							83	31	114	27.2	2.0	7

方向別自動車交通量調査表

調査地点：地域社会1 目黒

調査年月日：令和元年 5月11日(土) 天候：晴れ時々曇り

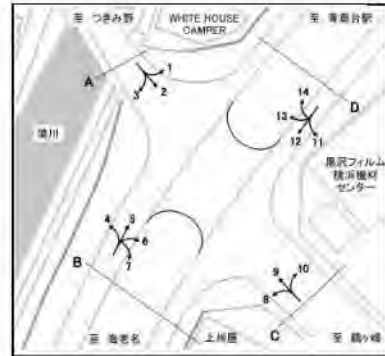

時間帯	方向 種別						B 合計 (4+ 5+ 6+ 7)					
		小型車 (台)	大型車 (台)	合計 (台)	大型車 混入率 (%)	時 間 係 数 (%)	二輪車 (台)	小型車 (台)	大型車 (台)	合計 (台)	大型車 混入率 (%)	時 間 係 数 (%)
6:00-6:15							32	6	38	15.8	0.7	3
6:15-6:30							28	10	38	26.3	0.7	7
6:30-6:45							37	4	41	9.8	0.7	1
6:45-7:00							43	12	55	21.8	0.9	2
1時間計							140	32	172	18.6	3.0	13
7:00-7:15							40	12	52	23.1	0.9	0
7:15-7:30							42	8	50	16.0	0.9	3
7:30-7:45							57	8	65	12.3	1.1	7
7:45-8:00							69	8	77	10.4	1.3	6
1時間計							208	36	244	14.8	4.2	16
8:00-8:15							56	10	66	15.2	1.1	12
8:15-8:30							88	13	101	12.9	1.7	4
8:30-8:45							57	12	69	17.4	1.2	0
8:45-9:00							50	7	57	12.3	1.0	1
1時間計							251	42	293	14.3	5.0	17
9:00-9:15							55	5	60	8.3	1.0	4
9:15-9:30							79	6	85	7.1	1.5	6
9:30-9:45							55	6	61	9.8	1.0	1
9:45-10:00							80	11	91	12.1	1.6	1
1時間計							269	28	297	9.4	5.1	12
10:00-10:15							93	8	101	7.9	1.7	1
10:15-10:30							81	5	86	5.8	1.5	3
10:30-10:45							56	6	62	9.7	1.1	4
10:45-11:00							77	5	82	6.1	1.4	1
1時間計							307	24	331	7.3	5.7	9
11:00-11:15							84	8	92	8.7	1.6	3
11:15-11:30							80	10	90	11.1	1.5	4
11:30-11:45							88	8	96	8.3	1.7	4
11:45-12:00							78	9	87	10.3	1.5	2
1時間計							330	35	365	9.6	6.3	13
12:00-12:15							80	6	86	7.0	1.5	4
12:15-12:30							92	12	104	11.5	1.8	2
12:30-12:45							83	14	97	14.4	1.7	6
12:45-13:00							92	14	106	13.2	1.8	2
1時間計							347	46	393	11.7	6.8	14
13:00-13:15							81	1	82	1.2	1.4	6
13:15-13:30							89	4	93	4.3	1.6	4
13:30-13:45							90	5	95	5.3	1.6	8
13:45-14:00							103	7	110	6.4	1.9	11
1時間計							363	17	380	4.5	6.5	29

方向別自動車交通量調査表

調査地点：地域社会1 目黒

調査年月日：令和元年 5月11日(土) 天候：晴れ時々曇り

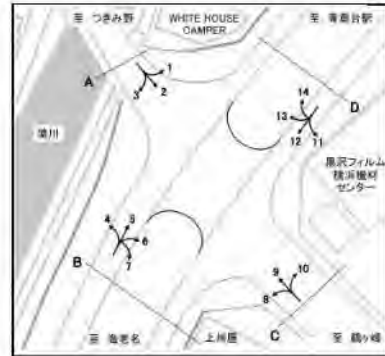

方向							B 合計 (4+ 5+ 6+ 7)						
	種別	小型車 (台)	大型車 (台)	合計 (台)	大型車 混入率 (%)	時 間 係 数 (%)	二輪車 (台)	小型車 (台)	大型車 (台)	合計 (台)	大型車 混入率 (%)	時 間 係 数 (%)	二輪車 (台)
14:00-14:15								69	7	76	9.2	1.3	8
14:15-14:30								80	2	82	2.4	1.4	4
14:30-14:45								72	9	81	11.1	1.4	5
14:45-15:00								56	1	57	1.8	1.0	6
1時間計								277	19	296	6.4	5.1	23
15:00-15:15								60	5	65	7.7	1.1	2
15:15-15:30								111	14	125	11.2	2.1	9
15:30-15:45								91	5	96	5.2	1.7	11
15:45-16:00								100	7	107	6.5	1.8	8
1時間計								362	31	393	7.9	6.8	30
16:00-16:15								89	7	96	7.3	1.7	11
16:15-16:30								83	2	85	2.4	1.5	3
16:30-16:45								67	6	73	8.2	1.3	4
16:45-17:00								68	4	72	5.6	1.2	7
1時間計								307	19	326	5.8	5.6	25
17:00-17:15								76	5	81	6.2	1.4	2
17:15-17:30								83	7	90	7.8	1.5	5
17:30-17:45								66	9	75	12.0	1.3	5
17:45-18:00								75	11	86	12.8	1.5	6
1時間計								300	32	332	9.6	5.7	18
18:00-18:15								86	4	90	4.4	1.5	3
18:15-18:30								78	9	87	10.3	1.5	4
18:30-18:45								74	12	86	14.0	1.5	1
18:45-19:00								75	5	80	6.3	1.4	0
1時間計								313	30	343	8.7	5.9	8
19:00-19:15								74	7	81	8.6	1.4	5
19:15-19:30								73	11	84	13.1	1.4	4
19:30-19:45								77	8	85	9.4	1.5	2
19:45-20:00								67	5	72	6.9	1.2	3
1時間計								291	31	322	9.6	5.5	14
20:00-20:15								101	13	114	11.4	2.0	1
20:15-20:30								71	7	78	9.0	1.3	0
20:30-20:45								58	11	69	15.9	1.2	3
20:45-21:00								39	8	47	17.0	0.8	2
1時間計								269	39	308	12.7	5.3	6
21:00-21:15								37	7	44	15.9	0.8	2
21:15-21:30								19	0	19	0.0	0.3	0
21:30-21:45								34	5	39	12.8	0.7	3
21:45-22:00								20	10	30	33.3	0.5	1
1時間計								110	22	132	16.7	2.3	6
昼12時間計								3634	359	3993	9.0	68.6	214
夜12時間計								1467	357	1824	19.6	31.4	81
全時間合計								5101	716	5817	12.3	100.0	295
昼 夜 率								1.40	1.99	1.46	-	-	1.38

方向別自動車交通量調査表

調査地点：地域社会1 目黒

調査年月日：令和元年 5月11日(土) 天候：晴れ時々曇り

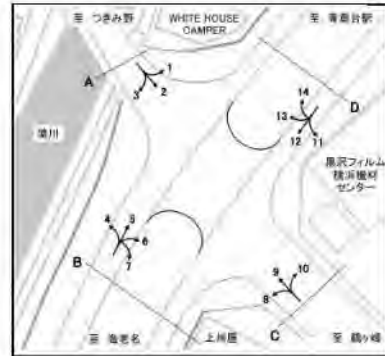

方向	8						9						
	種別	小型車 (台)	大型車 (台)	合計 (台)	大型車 混入率 (%)	時間 係数 (%)	二輪車 (台)	小型車 (台)	大型車 (台)	合計 (台)	大型車 混入率 (%)	時間 係数 (%)	二輪車 (台)
22:00-22:15		87	12	99	12.1	1.8	6	74	4	78	5.1	1.1	5
22:15-22:30		43	6	49	12.2	0.9	2	71	6	77	7.8	1.1	7
22:30-22:45		44	12	56	21.4	1.0	6	63	4	67	6.0	1.0	1
22:45-23:00		51	13	64	20.3	1.2	1	53	3	56	5.4	0.8	6
1時間計		225	43	268	16.0	4.8	15	261	17	278	6.1	4.0	19
23:00-23:15		40	6	46	13.0	0.8	4	41	4	45	8.9	0.7	4
23:15-23:30		19	7	26	26.9	0.5	3	24	4	28	14.3	0.4	3
23:30-23:45		27	10	37	27.0	0.7	1	27	3	30	10.0	0.4	1
23:45-24:00		17	9	26	34.6	0.5	2	21	7	28	25.0	0.4	5
1時間計		103	32	135	23.7	2.4	10	113	18	131	13.7	1.9	13
0:00-0:15		14	8	22	36.4	0.4	0	20	5	25	20.0	0.4	1
0:15-0:30		23	9	32	28.1	0.6	2	18	10	28	35.7	0.4	1
0:30-0:45		20	3	23	13.0	0.4	1	20	8	28	28.6	0.4	3
0:45-1:00		18	9	27	33.3	0.5	1	22	6	28	21.4	0.4	3
1時間計		75	29	104	27.9	1.9	4	80	29	109	26.6	1.6	8
1:00-1:15		31	22	53	41.5	1.0	5	38	9	47	19.1	0.7	5
1:15-1:30		8	5	13	38.5	0.2	0	9	6	15	40.0	0.2	1
1:30-1:45		17	7	24	29.2	0.4	0	11	4	15	26.7	0.2	0
1:45-2:00		10	4	14	28.6	0.3	0	14	1	15	6.7	0.2	0
1時間計		66	38	104	36.5	1.9	5	72	20	92	21.7	1.3	6
2:00-2:15		10	12	22	54.5	0.4	0	12	3	15	20.0	0.2	0
2:15-2:30		14	11	25	44.0	0.5	0	9	6	15	40.0	0.2	3
2:30-2:45		13	7	20	35.0	0.4	0	10	5	15	33.3	0.2	2
2:45-3:00		13	11	24	45.8	0.4	0	8	6	14	42.9	0.2	2
1時間計		50	41	91	45.1	1.6	0	39	20	59	33.9	0.9	7
3:00-3:15		11	13	24	54.2	0.4	0	10	8	18	44.4	0.3	1
3:15-3:30		5	14	19	73.7	0.3	0	7	5	12	41.7	0.2	0
3:30-3:45		13	8	21	38.1	0.4	0	10	4	14	28.6	0.2	0
3:45-4:00		10	3	13	23.1	0.2	0	12	13	25	52.0	0.4	1
1時間計		39	38	77	49.4	1.4	0	39	30	69	43.5	1.0	2
4:00-4:15		7	7	14	50.0	0.3	2	9	11	20	55.0	0.3	0
4:15-4:30		15	5	20	25.0	0.4	1	9	3	12	25.0	0.2	1
4:30-4:45		10	5	15	33.3	0.3	2	3	4	7	57.1	0.1	1
4:45-5:00		7	5	12	41.7	0.2	0	10	5	15	33.3	0.2	2
1時間計		39	22	61	36.1	1.1	5	31	23	54	42.6	0.8	4
5:00-5:15		22	7	29	24.1	0.5	2	11	5	16	31.3	0.2	1
5:15-5:30		15	6	21	28.6	0.4	2	14	7	21	33.3	0.3	2
5:30-5:45		19	15	34	44.1	0.6	3	15	6	21	28.6	0.3	0
5:45-6:00		22	5	27	18.5	0.5	0	17	5	22	22.7	0.3	1
1時間計		78	33	111	29.7	2.0	7	57	23	80	28.8	1.2	4

方向別自動車交通量調査表

調査地点：地域社会1 目黒

調査年月日：令和元年 5月11日(土) 天候：晴れ時々曇り

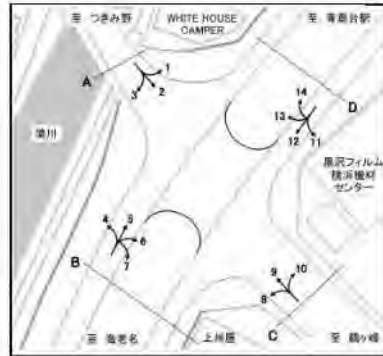

方向 種別 時間帯	8						9					
	小型車 (台)	大型車 (台)	合計 (台)	大型車 混入率 (%)	時間 係数 (%)	二輪車 (台)	小型車 (台)	大型車 (台)	合計 (台)	大型車 混入率 (%)	時間 係数 (%)	二輪車 (台)
6:00-6:15	24	12	36	33.3	0.7	1	24	9	33	27.3	0.5	3
6:15-6:30	26	13	39	33.3	0.7	0	28	5	33	15.2	0.5	3
6:30-6:45	49	11	60	18.3	1.1	6	18	5	23	21.7	0.3	2
6:45-7:00	58	7	65	10.8	1.2	3	25	7	32	21.9	0.5	5
1時間計	157	43	200	21.5	3.6	10	95	26	121	21.5	1.8	13
7:00-7:15	43	7	50	14.0	0.9	7	37	11	48	22.9	0.7	3
7:15-7:30	40	16	56	28.6	1.0	8	43	8	51	15.7	0.7	9
7:30-7:45	49	6	55	10.9	1.0	6	54	14	68	20.6	1.0	7
7:45-8:00	34	10	44	22.7	0.8	3	45	5	50	10.0	0.7	3
1時間計	166	39	205	19.0	3.7	24	179	38	217	17.5	3.2	22
8:00-8:15	54	11	65	16.9	1.2	4	87	10	97	10.3	1.4	6
8:15-8:30	56	8	64	12.5	1.2	11	56	3	59	5.1	0.9	4
8:30-8:45	57	18	75	24.0	1.4	2	81	8	89	9.0	1.3	8
8:45-9:00	59	7	66	10.6	1.2	10	75	1	76	1.3	1.1	3
1時間計	226	44	270	16.3	4.9	27	299	22	321	6.9	4.7	21
9:00-9:15	61	9	70	12.9	1.3	4	73	5	78	6.4	1.1	3
9:15-9:30	59	10	69	14.5	1.2	7	78	6	84	7.1	1.2	7
9:30-9:45	57	11	68	16.2	1.2	3	103	5	108	4.6	1.6	5
9:45-10:00	66	12	78	15.4	1.4	4	110	7	117	6.0	1.7	6
1時間計	243	42	285	14.7	5.1	18	364	23	387	5.9	5.6	21
10:00-10:15	83	17	100	17.0	1.8	3	110	7	117	6.0	1.7	5
10:15-10:30	96	5	101	5.0	1.8	4	117	8	125	6.4	1.8	5
10:30-10:45	74	7	81	8.6	1.5	5	116	14	130	10.8	1.9	4
10:45-11:00	93	11	104	10.6	1.9	4	105	9	114	7.9	1.7	3
1時間計	346	40	386	10.4	7.0	16	448	38	486	7.8	7.1	17
11:00-11:15	60	10	70	14.3	1.3	12	98	6	104	5.8	1.5	3
11:15-11:30	73	20	93	21.5	1.7	5	90	5	95	5.3	1.4	8
11:30-11:45	87	9	96	9.4	1.7	7	141	12	153	7.8	2.2	9
11:45-12:00	58	15	73	20.5	1.3	5	111	5	116	4.3	1.7	5
1時間計	278	54	332	16.3	6.0	29	440	28	468	6.0	6.8	25
12:00-12:15	55	10	65	15.4	1.2	3	97	5	102	4.9	1.5	1
12:15-12:30	69	10	79	12.7	1.4	7	115	6	121	5.0	1.8	4
12:30-12:45	51	8	59	13.6	1.1	3	90	8	98	8.2	1.4	2
12:45-13:00	61	9	70	12.9	1.3	6	72	7	79	8.9	1.2	5
1時間計	236	37	273	13.6	4.9	19	374	26	400	6.5	5.8	12
13:00-13:15	89	11	100	11.0	1.8	5	138	10	148	6.8	2.2	5
13:15-13:30	64	16	80	20.0	1.4	6	110	8	118	6.8	1.7	3
13:30-13:45	79	11	90	12.2	1.6	1	88	6	94	6.4	1.4	8
13:45-14:00	87	11	98	11.2	1.8	4	111	6	117	5.1	1.7	10
1時間計	319	49	368	13.3	6.6	16	447	30	477	6.3	6.9	26

方向別自動車交通量調査表

調査地点：地域社会1 目黒

調査年月日：令和元年 5月11日(土) 天候：晴れ時々曇り

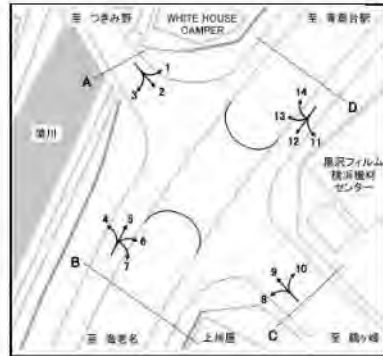

方向	8						9						
	種別	小型車 (台)	大型車 (台)	合計 (台)	大型車 混入率 (%)	時間 係数 (%)	二輪車 (台)	小型車 (台)	大型車 (台)	合計 (台)	大型車 混入率 (%)	時間 係数 (%)	二輪車 (台)
14:00-14:15		80	19	99	19.2	1.8	7	117	11	128	8.6	1.9	13
14:15-14:30		59	3	62	4.8	1.1	2	95	4	99	4.0	1.4	6
14:30-14:45		64	5	69	7.2	1.2	2	98	5	103	4.9	1.5	11
14:45-15:00		76	6	82	7.3	1.5	2	98	4	102	3.9	1.5	3
1時間計		279	33	312	10.6	5.6	13	408	24	432	5.6	6.3	33
15:00-15:15		73	8	81	9.9	1.5	3	112	4	116	3.4	1.7	8
15:15-15:30		67	9	76	11.8	1.4	6	102	6	108	5.6	1.6	2
15:30-15:45		66	5	71	7.0	1.3	2	102	6	108	5.6	1.6	6
15:45-16:00		54	4	58	6.9	1.0	2	95	7	102	6.9	1.5	0
1時間計		260	26	286	9.1	5.2	13	411	23	434	5.3	6.3	16
16:00-16:15		55	2	57	3.5	1.0	3	128	9	137	6.6	2.0	3
16:15-16:30		71	11	82	13.4	1.5	2	117	4	121	3.3	1.8	1
16:30-16:45		73	10	83	12.0	1.5	6	88	8	96	8.3	1.4	5
16:45-17:00		93	5	98	5.1	1.8	2	108	3	111	2.7	1.6	3
1時間計		292	28	320	8.8	5.8	13	441	24	465	5.2	6.8	12
17:00-17:15		82	15	97	15.5	1.8	5	89	4	93	4.3	1.4	6
17:15-17:30		94	16	110	14.5	2.0	1	96	3	99	3.0	1.4	4
17:30-17:45		80	2	82	2.4	1.5	11	113	6	119	5.0	1.7	9
17:45-18:00		61	2	63	3.2	1.1	3	90	5	95	5.3	1.4	7
1時間計		317	35	352	9.9	6.4	20	388	18	406	4.4	5.9	26
18:00-18:15		58	10	68	14.7	1.2	4	80	2	82	2.4	1.2	6
18:15-18:30		75	14	89	15.7	1.6	2	107	8	115	7.0	1.7	6
18:30-18:45		60	11	71	15.5	1.3	3	114	15	129	11.6	1.9	4
18:45-19:00		68	12	80	15.0	1.4	2	105	5	110	4.5	1.6	9
1時間計		261	47	308	15.3	5.6	11	406	30	436	6.9	6.3	25
19:00-19:15		51	11	62	17.7	1.1	1	76	7	83	8.4	1.2	6
19:15-19:30		64	13	77	16.9	1.4	8	105	6	111	5.4	1.6	11
19:30-19:45		38	6	44	13.6	0.8	3	84	5	89	5.6	1.3	1
19:45-20:00		49	10	59	16.9	1.1	8	84	8	92	8.7	1.3	4
1時間計		202	40	242	16.5	4.4	20	349	26	375	6.9	5.5	22
20:00-20:15		52	11	63	17.5	1.1	3	89	1	90	1.1	1.3	7
20:15-20:30		42	8	50	16.0	0.9	1	52	5	57	8.8	0.8	5
20:30-20:45		38	6	44	13.6	0.8	2	64	9	73	12.3	1.1	1
20:45-21:00		47	10	57	17.5	1.0	1	66	6	72	8.3	1.0	3
1時間計		179	35	214	16.4	3.9	7	271	21	292	7.2	4.3	16
21:00-21:15		48	9	57	15.8	1.0	1	66	8	74	10.8	1.1	3
21:15-21:30		55	15	70	21.4	1.3	4	79	5	84	6.0	1.2	4
21:30-21:45		54	14	68	20.6	1.2	2	59	7	66	10.6	1.0	7
21:45-22:00		31	5	36	13.9	0.7	3	49	7	56	12.5	0.8	2
1時間計		188	43	231	18.6	4.2	10	253	27	280	9.6	4.1	16
昼12時間計		3223	474	3697	12.8	66.8	219	4605	324	4929	6.6	71.8	256
夜12時間計		1401	437	1838	23.8	33.2	93	1660	280	1940	14.4	28.2	130
全時間合計		4624	911	5535	16.5	100.0	312	6265	604	6869	8.8	100.0	386
昼夜率		1.43	1.92	1.50	-	-	1.42	1.36	1.86	1.39	-	-	1.51

方向別自動車交通量調査表

調査地点：地域社会1 目黒

調査年月日：令和元年 5月11日(土) 天候：晴れ時々曇り

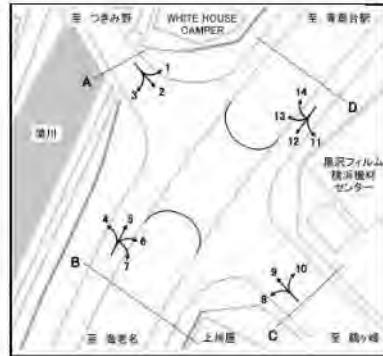

方向	10						C 合計 (8+9+10)					
	小型車 (台)	大型車 (台)	合計 (台)	大型車 混入率 (%)	時間 係数 (%)	二輪車 (台)	小型車 (台)	大型車 (台)	合計 (台)	大型車 混入率 (%)	時間 係数 (%)	二輪車 (台)
22:00-22:15	37	2	39	5.1	2.6	1	198	18	216	8.3	1.6	12
22:15-22:30	22	1	23	4.3	1.6	1	136	13	149	8.7	1.1	10
22:30-22:45	15	3	18	16.7	1.2	1	122	19	141	13.5	1.0	8
22:45-23:00	18	12	30	40.0	2.0	0	122	28	150	18.7	1.1	7
1時間計	92	18	110	16.4	7.4	3	578	78	656	11.9	4.7	37
23:00-23:15	13	7	20	35.0	1.4	1	94	17	111	15.3	0.8	9
23:15-23:30	10	5	15	33.3	1.0	0	53	16	69	23.2	0.5	6
23:30-23:45	3	4	7	57.1	0.5	0	57	17	74	23.0	0.5	2
23:45-24:00	2	8	10	80.0	0.7	0	40	24	64	37.5	0.5	7
1時間計	28	24	52	46.2	3.5	1	244	74	318	23.3	2.3	24
0:00-0:15	9	2	11	18.2	0.7	0	43	15	58	25.9	0.4	1
0:15-0:30	3	6	9	66.7	0.6	0	44	25	69	36.2	0.5	3
0:30-0:45	2	3	5	60.0	0.3	0	42	14	56	25.0	0.4	4
0:45-1:00	4	11	15	73.3	1.0	0	44	26	70	37.1	0.5	4
1時間計	18	22	40	55.0	2.7	0	173	80	253	31.6	1.8	12
1:00-1:15	7	16	23	69.6	1.6	1	76	47	123	38.2	0.9	11
1:15-1:30	2	3	5	60.0	0.3	0	19	14	33	42.4	0.2	1
1:30-1:45	1	6	7	85.7	0.5	0	29	17	46	37.0	0.3	0
1:45-2:00	1	1	2	50.0	0.1	0	25	6	31	19.4	0.2	0
1時間計	11	26	37	70.3	2.5	1	149	84	233	36.1	1.7	12
2:00-2:15	0	4	4	100.0	0.3	0	22	19	41	46.3	0.3	0
2:15-2:30	0	8	8	100.0	0.5	0	23	25	48	52.1	0.3	3
2:30-2:45	2	5	7	71.4	0.5	0	25	17	42	40.5	0.3	2
2:45-3:00	0	4	4	100.0	0.3	0	21	21	42	50.0	0.3	2
1時間計	2	21	23	91.3	1.6	0	91	82	173	47.4	1.2	7
3:00-3:15	1	5	6	83.3	0.4	0	22	26	48	54.2	0.3	1
3:15-3:30	0	5	5	100.0	0.3	2	12	24	36	66.7	0.3	2
3:30-3:45	2	4	6	66.7	0.4	0	25	16	41	39.0	0.3	0
3:45-4:00	2	5	7	71.4	0.5	1	24	21	45	46.7	0.3	2
1時間計	5	19	24	79.2	1.6	3	83	87	170	51.2	1.2	5
4:00-4:15	0	7	7	100.0	0.5	0	16	25	41	61.0	0.3	2
4:15-4:30	2	2	4	50.0	0.3	0	26	10	36	27.8	0.3	2
4:30-4:45	1	1	2	50.0	0.1	0	14	10	24	41.7	0.2	3
4:45-5:00	1	1	2	50.0	0.1	0	18	11	29	37.9	0.2	2
1時間計	4	11	15	73.3	1.0	0	74	56	130	43.1	0.9	9
5:00-5:15	5	8	13	61.5	0.9	0	38	20	58	34.5	0.4	3
5:15-5:30	2	2	4	50.0	0.3	1	31	15	46	32.6	0.3	5
5:30-5:45	4	3	7	42.9	0.5	0	38	24	62	38.7	0.4	3
5:45-6:00	3	4	7	57.1	0.5	0	42	14	56	25.0	0.4	1
1時間計	14	17	31	54.8	2.1	1	149	73	222	32.9	1.6	12

方向別自動車交通量調査表

調査地点 : 地域社会1 目黒

調査年月日 : 令和元年 5月11日(土) 天候:晴れ時々曇り

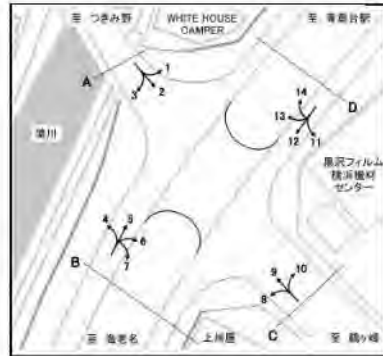

方向	10						C 合計 (8+ 9+10)						
	種別	小型車 (台)	大型車 (台)	合計 (台)	大型車 混入率 (%)	時間 係数 (%)	二輪車 (台)	小型車 (台)	大型車 (台)	合計 (台)	大型車 混入率 (%)	時間 係数 (%)	二輪車 (台)
6:00-6:15		5	3	8	37.5	0.5	0	53	24	77	31.2	0.6	4
6:15-6:30		4	3	7	42.9	0.5	0	58	21	79	26.6	0.6	3
6:30-6:45		5	9	14	64.3	0.9	1	72	25	97	25.8	0.7	9
6:45-7:00		10	1	11	9.1	0.7	3	93	15	108	13.9	0.8	11
1時間計		24	16	40	40.0	2.7	4	276	85	361	23.5	2.6	27
7:00-7:15		5	2	7	28.6	0.5	0	85	20	105	19.0	0.8	10
7:15-7:30		9	1	10	10.0	0.7	0	92	25	117	21.4	0.8	17
7:30-7:45		17	3	20	15.0	1.4	1	120	23	143	16.1	1.0	14
7:45-8:00		5	2	7	28.6	0.5	2	84	17	101	16.8	0.7	8
1時間計		36	8	44	18.2	3.0	3	381	85	466	18.2	3.4	49
8:00-8:15		16	1	17	5.9	1.2	2	157	22	179	12.3	1.3	12
8:15-8:30		11	2	13	15.4	0.9	1	123	13	136	9.6	1.0	16
8:30-8:45		20	5	25	20.0	1.7	4	158	31	189	16.4	1.4	14
8:45-9:00		18	6	24	25.0	1.6	6	152	14	166	8.4	1.2	19
1時間計		65	14	79	17.7	5.3	13	590	80	670	11.9	4.8	61
9:00-9:15		14	1	15	6.7	1.0	0	148	15	163	9.2	1.2	7
9:15-9:30		16	5	21	23.8	1.4	3	153	21	174	12.1	1.3	17
9:30-9:45		14	3	17	17.6	1.2	3	174	19	193	9.8	1.4	11
9:45-10:00		15	3	18	16.7	1.2	0	191	22	213	10.3	1.5	10
1時間計		59	12	71	16.9	4.8	6	666	77	743	10.4	5.4	45
10:00-10:15		23	5	28	17.9	1.9	0	216	29	245	11.8	1.8	8
10:15-10:30		17	1	18	5.6	1.2	0	230	14	244	5.7	1.8	9
10:30-10:45		14	1	15	6.7	1.0	0	204	22	226	9.7	1.6	9
10:45-11:00		14	2	16	12.5	1.1	1	212	22	234	9.4	1.7	8
1時間計		68	9	77	11.7	5.2	1	862	87	949	9.2	6.8	34
11:00-11:15		6	2	8	25.0	0.5	0	164	18	182	9.9	1.3	15
11:15-11:30		18	1	19	5.3	1.3	1	181	26	207	12.6	1.5	14
11:30-11:45		13	3	16	18.8	1.1	2	241	24	265	9.1	1.9	18
11:45-12:00		12	3	15	20.0	1.0	2	181	23	204	11.3	1.5	12
1時間計		49	9	58	15.5	3.9	5	767	91	858	10.6	6.2	59
12:00-12:15		9	3	12	25.0	0.8	0	161	18	179	10.1	1.3	4
12:15-12:30		22	3	25	12.0	1.7	1	206	19	225	8.4	1.6	12
12:30-12:45		13	0	13	0.0	0.9	0	154	16	170	9.4	1.2	5
12:45-13:00		14	3	17	17.6	1.2	0	147	19	166	11.4	1.2	11
1時間計		58	9	67	13.4	4.5	1	668	72	740	9.7	5.3	32
13:00-13:15		29	3	32	9.4	2.2	2	256	24	280	8.6	2.0	12
13:15-13:30		18	2	20	10.0	1.4	1	192	26	218	11.9	1.6	10
13:30-13:45		17	2	19	10.5	1.3	1	184	19	203	9.4	1.5	10
13:45-14:00		25	0	25	0.0	1.7	0	223	17	240	7.1	1.7	14
1時間計		89	7	96	7.3	6.5	4	855	86	941	9.1	6.8	46

方向別自動車交通量調査表

調査地点：地域社会1 目黒

調査年月日：令和元年 5月11日(土) 天候：晴れ時々曇り

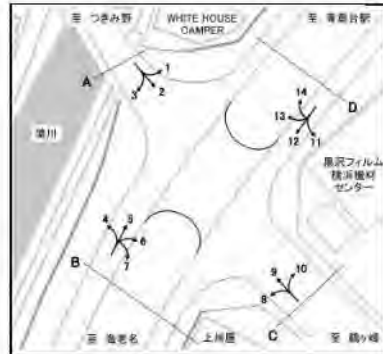

方向 種別 時間帯	10						C 合計 (8+9+10)					
	小型車 (台)	大型車 (台)	合計 (台)	大型車 混入率 (%)	時間 係数 (%)	二輪車 (台)	小型車 (台)	大型車 (台)	合計 (台)	大型車 混入率 (%)	時間 係数 (%)	二輪車 (台)
14:00-14:15	18	3	21	14.3	1.4	0	215	33	248	13.3	1.8	20
14:15-14:30	14	2	16	12.5	1.1	0	168	9	177	5.1	1.3	8
14:30-14:45	13	1	14	7.1	0.9	1	175	11	186	5.9	1.3	14
14:45-15:00	20	0	20	0.0	1.4	3	194	10	204	4.9	1.5	8
1時間計	65	6	71	8.5	4.8	4	752	63	815	7.7	5.9	50
15:00-15:15	22	4	26	15.4	1.8	0	207	16	223	7.2	1.6	11
15:15-15:30	16	1	17	5.9	1.2	0	185	16	201	8.0	1.4	8
15:30-15:45	10	3	13	23.1	0.9	0	178	14	192	7.3	1.4	8
15:45-16:00	12	2	14	14.3	0.9	1	161	13	174	7.5	1.3	3
1時間計	60	10	70	14.3	4.7	1	731	59	790	7.5	5.7	30
16:00-16:15	24	2	26	7.7	1.8	0	207	13	220	5.9	1.6	6
16:15-16:30	32	0	32	0.0	2.2	1	220	15	235	6.4	1.7	4
16:30-16:45	22	2	24	8.3	1.6	0	183	20	203	9.9	1.5	11
16:45-17:00	15	1	16	6.3	1.1	2	216	9	225	4.0	1.6	7
1時間計	93	5	98	5.1	6.6	3	826	57	883	6.5	6.4	28
17:00-17:15	16	0	16	0.0	1.1	0	187	19	206	9.2	1.5	11
17:15-17:30	19	1	20	5.0	1.4	1	209	20	229	8.7	1.6	6
17:30-17:45	14	0	14	0.0	0.9	0	207	8	215	3.7	1.5	20
17:45-18:00	13	1	14	7.1	0.9	0	164	8	172	4.7	1.2	10
1時間計	62	2	64	3.1	4.3	1	767	55	822	6.7	5.9	47
18:00-18:15	18	1	19	5.3	1.3	0	156	13	169	7.7	1.2	10
18:15-18:30	12	3	15	20.0	1.0	0	194	25	219	11.4	1.6	8
18:30-18:45	16	2	18	11.1	1.2	2	190	28	218	12.8	1.6	9
18:45-19:00	20	3	23	13.0	1.6	2	193	20	213	9.4	1.5	13
1時間計	66	9	75	12.0	5.1	4	733	86	819	10.5	5.9	40
19:00-19:15	19	2	21	9.5	1.4	0	146	20	166	12.0	1.2	7
19:15-19:30	39	1	40	2.5	2.7	0	208	20	228	8.8	1.6	19
19:30-19:45	21	1	22	4.5	1.5	1	143	12	155	7.7	1.1	5
19:45-20:00	22	1	23	4.3	1.6	2	155	19	174	10.9	1.3	14
1時間計	101	5	106	4.7	7.2	3	652	71	723	9.8	5.2	45
20:00-20:15	17	1	18	5.6	1.2	0	158	13	171	7.6	1.2	10
20:15-20:30	17	2	19	10.5	1.3	2	111	15	126	11.9	0.9	8
20:30-20:45	11	0	11	0.0	0.7	1	113	15	128	11.7	0.9	4
20:45-21:00	9	2	11	18.2	0.7	1	122	18	140	12.9	1.0	5
1時間計	54	5	59	8.5	4.0	4	504	61	565	10.8	4.1	27
21:00-21:15	8	3	11	27.3	0.7	0	122	20	142	14.1	1.0	4
21:15-21:30	13	1	14	7.1	0.9	2	147	21	168	12.5	1.2	10
21:30-21:45	18	4	22	18.2	1.5	1	131	25	156	16.0	1.1	10
21:45-22:00	20	4	24	16.7	1.6	0	100	16	116	13.8	0.8	5
1時間計	59	12	71	16.9	4.8	3	500	82	582	14.1	4.2	29
昼12時間計	770	100	870	11.5	58.9	46	8598	898	9496	9.5	68.4	521
夜12時間計	412	196	608	32.2	41.1	23	3473	913	4386	20.8	31.6	246
全時間合計	1182	296	1478	20.0	100.0	69	12071	1811	13882	13.0	100.0	767
昼夜率	1.54	2.96	1.70	-	-	1.50	1.40	2.02	1.46	-	-	1.47

方向別自動車交通量調査表

調査地点：地域社会1 目黒

調査年月日：令和元年 5月11日(土) 天候：晴れ時々曇り

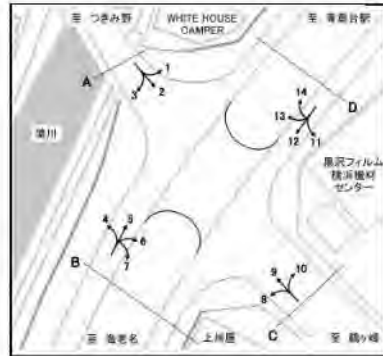

方向 種別 時間帯	11						12					
	小型車 (台)	大型車 (台)	合計 (台)	大型車 混入率 (%)	時間 係数 (%)	二輪車 (台)	小型車 (台)	大型車 (台)	合計 (台)	大型車 混入率 (%)	時間 係数 (%)	二輪車 (台)
22:00-22:15	4	10	14	71.4	1.3	0	11	0	11	0.0	1.6	0
22:15-22:30	11	6	17	35.3	1.5	0	5	0	5	0.0	0.7	0
22:30-22:45	2	5	7	71.4	0.6	0	4	0	4	0.0	0.6	0
22:45-23:00	3	5	8	62.5	0.7	0	2	1	3	33.3	0.4	2
1時間計	20	26	46	56.5	4.1	0	22	1	23	4.3	3.3	2
23:00-23:15	3	2	5	40.0	0.4	0	2	1	3	33.3	0.4	0
23:15-23:30	2	4	6	66.7	0.5	0	3	0	3	0.0	0.4	0
23:30-23:45	4	4	8	50.0	0.7	0	2	0	2	0.0	0.3	0
23:45-24:00	10	10	20	50.0	1.8	1	2	0	2	0.0	0.3	0
1時間計	19	20	39	51.3	3.5	1	9	1	10	10.0	1.4	0
0:00-0:15	1	4	5	80.0	0.4	0	2	0	2	0.0	0.3	0
0:15-0:30	5	0	5	0.0	0.4	0	6	0	6	0.0	0.8	0
0:30-0:45	2	3	5	60.0	0.4	0	0	0	0	0.0	0.0	0
0:45-1:00	1	3	4	75.0	0.4	0	3	0	3	0.0	0.4	0
1時間計	9	10	19	52.6	1.7	0	11	0	11	0.0	1.6	0
1:00-1:15	1	5	6	83.3	0.5	0	8	0	8	0.0	1.1	1
1:15-1:30	3	5	8	62.5	0.7	0	6	0	6	0.0	0.8	0
1:30-1:45	5	1	6	16.7	0.5	0	1	0	1	0.0	0.1	0
1:45-2:00	2	5	7	71.4	0.6	0	1	0	1	0.0	0.1	1
1時間計	11	16	27	59.3	2.4	0	16	0	16	0.0	2.3	2
2:00-2:15	1	11	12	91.7	1.1	1	2	0	2	0.0	0.3	0
2:15-2:30	0	3	3	100.0	0.3	0	3	0	3	0.0	0.4	0
2:30-2:45	0	7	7	100.0	0.6	0	1	0	1	0.0	0.1	0
2:45-3:00	2	4	6	66.7	0.5	0	2	0	2	0.0	0.3	0
1時間計	3	25	28	89.3	2.5	1	8	0	8	0.0	1.1	0
3:00-3:15	3	4	7	57.1	0.6	0	5	0	5	0.0	0.7	0
3:15-3:30	1	3	4	75.0	0.4	0	5	0	5	0.0	0.7	0
3:30-3:45	3	8	11	72.7	1.0	0	3	0	3	0.0	0.4	0
3:45-4:00	4	3	7	42.9	0.6	0	1	0	1	0.0	0.1	0
1時間計	11	18	29	62.1	2.6	0	14	0	14	0.0	2.0	0
4:00-4:15	6	0	6	0.0	0.5	0	1	0	1	0.0	0.1	0
4:15-4:30	1	5	6	83.3	0.5	0	1	0	1	0.0	0.1	0
4:30-4:45	1	4	5	80.0	0.4	0	2	0	2	0.0	0.3	0
4:45-5:00	1	1	2	50.0	0.2	0	3	0	3	0.0	0.4	0
1時間計	9	10	19	52.6	1.7	0	7	0	7	0.0	1.0	0
5:00-5:15	2	5	7	71.4	0.6	0	1	0	1	0.0	0.1	0
5:15-5:30	1	3	4	75.0	0.4	1	3	0	3	0.0	0.4	0
5:30-5:45	1	4	5	80.0	0.4	0	4	0	4	0.0	0.6	0
5:45-6:00	1	4	5	80.0	0.4	0	2	0	2	0.0	0.3	0
1時間計	5	16	21	76.2	1.9	1	10	0	10	0.0	1.4	0

方向別自動車交通量調査表

調査地点：地域社会1 目黒

調査年月日：令和元年 5月11日(土) 天候：晴れ時々曇り

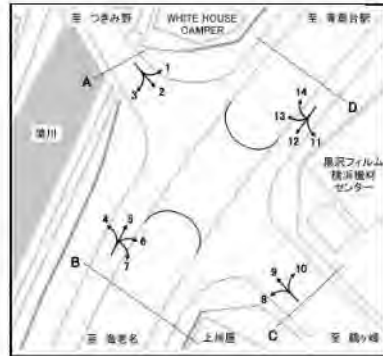

方向 時間帯	11						12					
	種別 小型車 (台)	大型車 (台)	合計 (台)	大型車 混入率 (%)	時間 係数 (%)	二輪車 (台)	小型車 (台)	大型車 (台)	合計 (台)	大型車 混入率 (%)	時間 係数 (%)	二輪車 (台)
6:00-6:15	2	1	3	33.3	0.3	0	2	0	2	0.0	0.3	1
6:15-6:30	4	3	7	42.9	0.6	0	5	1	6	16.7	0.8	0
6:30-6:45	2	2	4	50.0	0.4	0	2	0	2	0.0	0.3	0
6:45-7:00	5	1	6	16.7	0.5	0	2	2	4	50.0	0.6	0
1時間計	13	7	20	35.0	1.8	0	11	3	14	21.4	2.0	1
7:00-7:15	4	4	8	50.0	0.7	0	9	2	11	18.2	1.6	0
7:15-7:30	4	2	6	33.3	0.5	1	3	1	4	25.0	0.6	0
7:30-7:45	2	3	5	60.0	0.4	0	4	0	4	0.0	0.6	0
7:45-8:00	10	3	13	23.1	1.2	1	2	0	2	0.0	0.3	0
1時間計	20	12	32	37.5	2.9	2	18	3	21	14.3	3.0	0
8:00-8:15	21	2	23	8.7	2.1	2	7	0	7	0.0	1.0	1
8:15-8:30	12	3	15	20.0	1.3	0	1	0	1	0.0	0.1	1
8:30-8:45	5	2	7	28.6	0.6	0	8	0	8	0.0	1.1	0
8:45-9:00	15	7	22	31.8	2.0	0	7	1	8	12.5	1.1	1
1時間計	53	14	67	20.9	6.0	2	23	1	24	4.2	3.4	3
9:00-9:15	17	1	18	5.6	1.6	1	7	1	8	12.5	1.1	0
9:15-9:30	16	4	20	20.0	1.8	1	5	1	6	16.7	0.8	0
9:30-9:45	14	6	20	30.0	1.8	3	12	0	12	0.0	1.7	0
9:45-10:00	10	2	12	16.7	1.1	0	5	0	5	0.0	0.7	0
1時間計	57	13	70	18.6	6.3	5	29	2	31	6.5	4.4	0
10:00-10:15	1	1	2	50.0	0.2	0	10	0	10	0.0	1.4	0
10:15-10:30	9	1	10	10.0	0.9	1	2	0	2	0.0	0.3	3
10:30-10:45	9	6	15	40.0	1.3	2	9	1	10	10.0	1.4	3
10:45-11:00	11	1	12	8.3	1.1	0	7	1	8	12.5	1.1	0
1時間計	30	9	39	23.1	3.5	3	28	2	30	6.7	4.2	6
11:00-11:15	17	2	19	10.5	1.7	0	10	0	10	0.0	1.4	1
11:15-11:30	8	0	8	0.0	0.7	1	7	0	7	0.0	1.0	2
11:30-11:45	5	2	7	28.6	0.6	4	14	0	14	0.0	2.0	2
11:45-12:00	7	0	7	0.0	0.6	1	5	2	7	28.6	1.0	1
1時間計	37	4	41	9.8	3.7	6	36	2	38	5.3	5.4	6
12:00-12:15	14	2	16	12.5	1.4	0	13	2	15	13.3	2.1	1
12:15-12:30	15	3	18	16.7	1.6	2	15	1	16	6.3	2.3	3
12:30-12:45	18	4	22	18.2	2.0	0	6	0	6	0.0	0.8	0
12:45-13:00	10	5	15	33.3	1.3	1	15	1	16	6.3	2.3	1
1時間計	57	14	71	19.7	6.3	3	49	4	53	7.5	7.5	5
13:00-13:15	18	3	21	14.3	1.9	1	8	0	8	0.0	1.1	2
13:15-13:30	10	3	13	23.1	1.2	0	20	0	20	0.0	2.8	1
13:30-13:45	12	3	15	20.0	1.3	0	10	0	10	0.0	1.4	2
13:45-14:00	19	3	22	13.6	2.0	1	7	1	8	12.5	1.1	1
1時間計	59	12	71	16.9	6.3	2	45	1	46	2.2	6.5	6

方向別自動車交通量調査表

調査地点：地域社会1 目黒

調査年月日：令和元年 5月11日(土) 天候：晴れ時々曇り

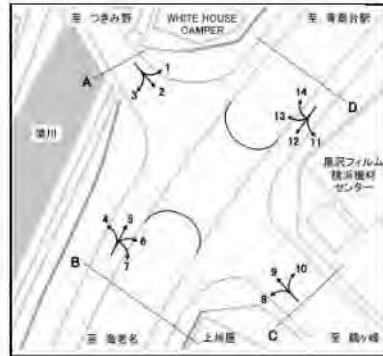

方向	11						12						
	種別	小型車 (台)	大型車 (台)	合計 (台)	大型車 混入率 (%)	時間 係数 (%)	二輪車 (台)	小型車 (台)	大型車 (台)	合計 (台)	大型車 混入率 (%)	時間 係数 (%)	二輪車 (台)
14:00-14:15		14	2	16	12.5	1.4	2	6	0	6	0.0	0.8	1
14:15-14:30		10	2	12	16.7	1.1	0	14	0	14	0.0	2.0	3
14:30-14:45		23	3	26	11.5	2.3	1	13	0	13	0.0	1.8	1
14:45-15:00		15	1	16	6.3	1.4	5	18	0	18	0.0	2.5	1
1時間計		62	8	70	11.4	6.3	8	51	0	51	0.0	7.2	6
15:00-15:15		10	2	12	16.7	1.1	2	10	0	10	0.0	1.4	0
15:15-15:30		7	3	10	30.0	0.9	1	6	0	6	0.0	0.8	2
15:30-15:45		8	1	9	11.1	0.8	0	15	1	16	6.3	2.3	1
15:45-16:00		9	0	9	0.0	0.8	0	12	0	12	0.0	1.7	3
1時間計		34	6	40	15.0	3.6	3	43	1	44	2.3	6.2	6
16:00-16:15		12	2	14	14.3	1.3	0	13	0	13	0.0	1.8	1
16:15-16:30		8	5	13	38.5	1.2	1	4	0	4	0.0	0.6	2
16:30-16:45		7	2	9	22.2	0.8	2	11	0	11	0.0	1.6	0
16:45-17:00		20	1	21	4.8	1.9	3	14	1	15	6.7	2.1	0
1時間計		47	10	57	17.5	5.1	6	42	1	43	2.3	6.1	3
17:00-17:15		22	2	24	8.3	2.1	0	17	0	17	0.0	2.4	2
17:15-17:30		15	6	21	28.6	1.9	1	21	0	21	0.0	3.0	1
17:30-17:45		17	1	18	5.6	1.6	1	17	0	17	0.0	2.4	1
17:45-18:00		11	1	12	8.3	1.1	2	13	0	13	0.0	1.8	0
1時間計		65	10	75	13.3	6.7	4	68	0	68	0.0	9.6	4
18:00-18:15		11	3	14	21.4	1.3	0	12	0	12	0.0	1.7	1
18:15-18:30		17	2	19	10.5	1.7	0	12	1	13	7.7	1.8	0
18:30-18:45		15	3	18	16.7	1.6	1	10	1	11	9.1	1.6	1
18:45-19:00		13	3	16	18.8	1.4	0	14	0	14	0.0	2.0	1
1時間計		56	11	67	16.4	6.0	1	48	2	50	4.0	7.1	3
19:00-19:15		14	3	17	17.6	1.5	0	14	0	14	0.0	2.0	0
19:15-19:30		11	1	12	8.3	1.1	0	6	0	6	0.0	0.8	0
19:30-19:45		9	3	12	25.0	1.1	0	4	0	4	0.0	0.6	0
19:45-20:00		9	6	15	40.0	1.3	0	15	0	15	0.0	2.1	1
1時間計		43	13	56	23.2	5.0	0	39	0	39	0.0	5.5	1
20:00-20:15		6	5	11	45.5	1.0	0	11	0	11	0.0	1.6	0
20:15-20:30		17	12	29	41.4	2.6	0	7	0	7	0.0	1.0	1
20:30-20:45		6	4	10	40.0	0.9	0	6	0	6	0.0	0.8	1
20:45-21:00		12	7	19	36.8	1.7	0	5	0	5	0.0	0.7	0
1時間計		41	28	69	40.6	6.2	0	29	0	29	0.0	4.1	2
21:00-21:15		8	5	13	38.5	1.2	0	10	4	14	28.6	2.0	1
21:15-21:30		8	7	15	46.7	1.3	0	5	0	5	0.0	0.7	0
21:30-21:45		6	4	10	40.0	0.9	1	2	0	2	0.0	0.3	0
21:45-22:00		5	4	9	44.4	0.8	0	5	0	5	0.0	0.7	0
1時間計		27	20	47	42.6	4.2	1	22	4	26	15.4	3.7	1
昼12時間計		577	123	700	17.6	62.5	45	480	19	499	3.8	70.7	48
夜12時間計		211	209	420	49.8	37.5	4	198	9	207	4.3	29.3	9
全時間合計		788	332	1120	29.6	100.0	49	678	28	706	4.0	100.0	57
昼夜率		1.37	2.70	1.60	-	-	1.09	1.41	1.47	1.41	-	-	1.19

方向別自動車交通量調査表

調査地点：地域社会1 目黒

調査年月日：令和元年 5月11日(土) 天候：晴れ時々曇り

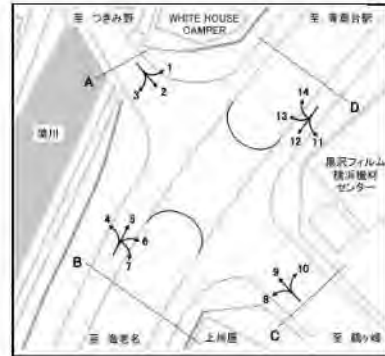

方向	13						14						
	種別	小型車 (台)	大型車 (台)	合計 (台)	大型車 混入率 (%)	時間 係数 (%)	二輪車 (台)	小型車 (台)	大型車 (台)	合計 (台)	大型車 混入率 (%)	時間 係数 (%)	二輪車 (台)
22:00-22:15		21	5	26	19.2	0.9	1	1	0	1	0.0	0.7	0
22:15-22:30		27	1	28	3.6	1.0	0	3	0	3	0.0	2.2	0
22:30-22:45		11	1	12	8.3	0.4	0	2	0	2	0.0	1.4	0
22:45-23:00		14	0	14	0.0	0.5	2	0	0	0	0.0	0.0	0
1時間計		73	7	80	8.8	2.7	3	6	0	6	0.0	4.3	0
23:00-23:15		17	0	17	0.0	0.6	1	1	0	1	0.0	0.7	0
23:15-23:30		6	3	9	33.3	0.3	1	1	0	1	0.0	0.7	0
23:30-23:45		12	0	12	0.0	0.4	1	0	0	0	0.0	0.0	0
23:45-24:00		15	3	18	16.7	0.6	0	0	1	1	100.0	0.7	0
1時間計		50	6	56	10.7	1.9	3	2	1	3	33.3	2.2	0
0:00-0:15		10	0	10	0.0	0.3	2	0	0	0	0.0	0.0	0
0:15-0:30		10	3	13	23.1	0.4	2	0	0	0	0.0	0.0	0
0:30-0:45		7	2	9	22.2	0.3	1	2	0	2	0.0	1.4	0
0:45-1:00		12	1	13	7.7	0.4	0	0	1	1	100.0	0.7	0
1時間計		39	6	45	13.3	1.5	5	2	1	3	33.3	2.2	0
1:00-1:15		9	2	11	18.2	0.4	0	1	0	1	0.0	0.7	0
1:15-1:30		11	1	12	8.3	0.4	1	0	0	0	0.0	0.0	0
1:30-1:45		3	1	4	25.0	0.1	1	0	0	0	0.0	0.0	0
1:45-2:00		9	1	10	10.0	0.3	1	0	1	1	100.0	0.7	0
1時間計		32	5	37	13.5	1.3	3	1	1	2	50.0	1.4	0
2:00-2:15		10	1	11	9.1	0.4	0	0	0	0	0.0	0.0	0
2:15-2:30		5	2	7	28.6	0.2	0	0	0	0	0.0	0.0	0
2:30-2:45		6	1	7	14.3	0.2	0	0	0	0	0.0	0.0	0
2:45-3:00		5	2	7	28.6	0.2	1	1	0	1	0.0	0.7	0
1時間計		26	6	32	18.8	1.1	1	1	0	1	0.0	0.7	0
3:00-3:15		2	1	3	33.3	0.1	0	0	0	0	0.0	0.0	0
3:15-3:30		4	4	8	50.0	0.3	0	0	0	0	0.0	0.0	0
3:30-3:45		2	0	2	0.0	0.1	0	0	0	0	0.0	0.0	0
3:45-4:00		3	1	4	25.0	0.1	0	0	0	0	0.0	0.0	0
1時間計		11	6	17	35.3	0.6	0	0	0	0	0.0	0.0	0
4:00-4:15		8	2	10	20.0	0.3	1	0	2	2	100.0	1.4	0
4:15-4:30		6	1	7	14.3	0.2	0	1	0	1	0.0	0.7	0
4:30-4:45		6	2	8	25.0	0.3	0	0	0	0	0.0	0.0	0
4:45-5:00		6	1	7	14.3	0.2	1	0	0	0	0.0	0.0	0
1時間計		26	6	32	18.8	1.1	2	1	2	3	66.7	2.2	0
5:00-5:15		5	1	6	16.7	0.2	0	0	0	0	0.0	0.0	0
5:15-5:30		6	2	8	25.0	0.3	0	1	1	2	50.0	1.4	0
5:30-5:45		10	3	13	23.1	0.4	1	0	0	0	0.0	0.0	0
5:45-6:00		3	3	6	50.0	0.2	1	0	0	0	0.0	0.0	0
1時間計		24	9	33	27.3	1.1	2	1	1	2	50.0	1.4	0

方向別自動車交通量調査表

調査地点：地域社会1 目黒

調査年月日：令和元年 5月11日(土) 天候：晴れ時々曇り

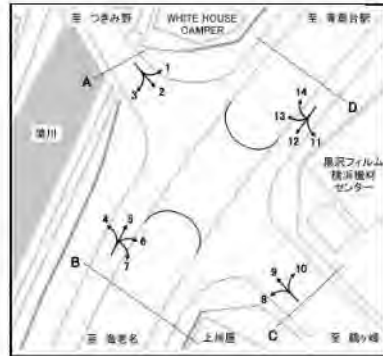

方向	13						14						
	種別	小型車 (台)	大型車 (台)	合計 (台)	大型車 混入率 (%)	時間 係数 (%)	二輪車 (台)	小型車 (台)	大型車 (台)	合計 (台)	大型車 混入率 (%)	時間 係数 (%)	二輪車 (台)
6:00-6:15		3	1	4	25.0	0.1	0	0	0	0	0.0	0.0	0
6:15-6:30		8	3	11	27.3	0.4	1	0	0	0	0.0	0.0	0
6:30-6:45		15	0	15	0.0	0.5	0	0	0	0	0.0	0.0	0
6:45-7:00		7	0	7	0.0	0.2	0	0	0	0	0.0	0.0	0
1時間計		33	4	37	10.8	1.3	1	0	0	0	0.0	0.0	0
7:00-7:15		10	0	10	0.0	0.3	3	0	0	0	0.0	0.0	0
7:15-7:30		14	2	16	12.5	0.5	0	1	0	1	0.0	0.7	0
7:30-7:45		22	4	26	15.4	0.9	2	0	0	0	0.0	0.0	0
7:45-8:00		14	2	16	12.5	0.5	1	1	0	1	0.0	0.7	0
1時間計		60	8	68	11.8	2.3	6	2	0	2	0.0	1.4	0
8:00-8:15		28	4	32	12.5	1.1	3	2	0	2	0.0	1.4	0
8:15-8:30		24	1	25	4.0	0.8	2	2	1	3	33.3	2.2	0
8:30-8:45		14	1	15	6.7	0.5	1	0	0	0	0.0	0.0	0
8:45-9:00		34	1	35	2.9	1.2	2	0	1	1	100.0	0.7	0
1時間計		100	7	107	6.5	3.6	8	4	2	6	33.3	4.3	0
9:00-9:15		39	3	42	7.1	1.4	1	0	1	1	100.0	0.7	0
9:15-9:30		35	3	38	7.9	1.3	1	1	0	1	0.0	0.7	0
9:30-9:45		44	5	49	10.2	1.7	1	5	0	5	0.0	3.6	0
9:45-10:00		22	3	25	12.0	0.8	1	1	0	1	0.0	0.7	0
1時間計		140	14	154	9.1	5.2	4	7	1	8	12.5	5.8	0
10:00-10:15		54	3	57	5.3	1.9	1	2	1	3	33.3	2.2	0
10:15-10:30		49	5	54	9.3	1.8	4	4	0	4	0.0	2.9	0
10:30-10:45		43	1	44	2.3	1.5	2	2	0	2	0.0	1.4	0
10:45-11:00		46	0	46	0.0	1.6	1	1	0	1	0.0	0.7	0
1時間計		192	9	201	4.5	6.8	8	9	1	10	10.0	7.2	0
11:00-11:15		56	3	59	5.1	2.0	5	1	0	1	0.0	0.7	0
11:15-11:30		40	2	42	4.8	1.4	0	0	0	0	0.0	0.0	0
11:30-11:45		55	1	56	1.8	1.9	4	0	0	0	0.0	0.0	0
11:45-12:00		39	0	39	0.0	1.3	4	2	0	2	0.0	1.4	0
1時間計		190	6	196	3.1	6.7	13	3	0	3	0.0	2.2	0
12:00-12:15		60	0	60	0.0	2.0	2	6	0	6	0.0	4.3	0
12:15-12:30		54	1	55	1.8	1.9	2	3	0	3	0.0	2.2	0
12:30-12:45		47	1	48	2.1	1.6	1	1	0	1	0.0	0.7	0
12:45-13:00		47	0	47	0.0	1.6	4	3	0	3	0.0	2.2	0
1時間計		208	2	210	1.0	7.1	9	13	0	13	0.0	9.4	0
13:00-13:15		50	3	53	5.7	1.8	3	2	0	2	0.0	1.4	0
13:15-13:30		40	2	42	4.8	1.4	1	3	0	3	0.0	2.2	0
13:30-13:45		51	3	54	5.6	1.8	2	3	0	3	0.0	2.2	0
13:45-14:00		45	5	50	10.0	1.7	2	2	0	2	0.0	1.4	0
1時間計		186	13	199	6.5	6.8	8	10	0	10	0.0	7.2	0

方向別自動車交通量調査表

調査地点：地域社会1 目黒

調査年月日：令和元年 5月11日(土) 天候：晴れ時々曇り

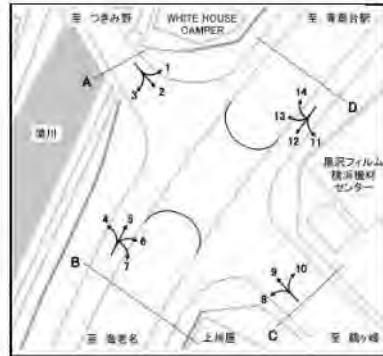

方向 種別 時間帯	13						14					
	小型車 (台)	大型車 (台)	合計 (台)	大型車 混入率 (%)	時間 係数 (%)	二輪車 (台)	小型車 (台)	大型車 (台)	合計 (台)	大型車 混入率 (%)	時間 係数 (%)	二輪車 (台)
14:00-14:15	51	4	55	7.3	1.9	1	3	0	3	0.0	2.2	0
14:15-14:30	41	3	44	6.8	1.5	4	2	0	2	0.0	1.4	0
14:30-14:45	62	2	64	3.1	2.2	5	6	0	6	0.0	4.3	1
14:45-15:00	46	2	48	4.2	1.6	0	4	0	4	0.0	2.9	0
1時間計	200	11	211	5.2	7.2	10	15	0	15	0.0	10.8	1
15:00-15:15	57	1	58	1.7	2.0	1	2	0	2	0.0	1.4	0
15:15-15:30	35	4	39	10.3	1.3	1	2	0	2	0.0	1.4	0
15:30-15:45	40	0	40	0.0	1.4	3	1	0	1	0.0	0.7	0
15:45-16:00	40	2	42	4.8	1.4	3	0	1	1	100.0	0.7	0
1時間計	172	7	179	3.9	6.1	8	5	1	6	16.7	4.3	0
16:00-16:15	43	5	48	10.4	1.6	4	1	0	1	0.0	0.7	0
16:15-16:30	53	4	57	7.0	1.9	1	1	0	1	0.0	0.7	0
16:30-16:45	46	1	47	2.1	1.6	2	5	0	5	0.0	3.6	1
16:45-17:00	54	2	56	3.6	1.9	2	0	2	2	100.0	1.4	0
1時間計	196	12	208	5.8	7.1	9	7	2	9	22.2	6.5	1
17:00-17:15	46	5	51	9.8	1.7	2	1	0	1	0.0	0.7	0
17:15-17:30	56	1	57	1.8	1.9	2	0	0	0	0.0	0.0	1
17:30-17:45	50	3	53	5.7	1.8	6	4	0	4	0.0	2.9	0
17:45-18:00	52	4	56	7.1	1.9	3	0	0	0	0.0	0.0	0
1時間計	204	13	217	6.0	7.4	13	5	0	5	0.0	3.6	1
18:00-18:15	44	4	48	8.3	1.6	1	3	0	3	0.0	2.2	0
18:15-18:30	45	1	46	2.2	1.6	1	0	0	0	0.0	0.0	0
18:30-18:45	40	3	43	7.0	1.5	1	3	0	3	0.0	2.2	0
18:45-19:00	51	1	52	1.9	1.8	3	4	0	4	0.0	2.9	0
1時間計	180	9	189	4.8	6.4	6	10	0	10	0.0	7.2	0
19:00-19:15	56	2	58	3.4	2.0	3	3	0	3	0.0	2.2	0
19:15-19:30	44	1	45	2.2	1.5	2	0	0	0	0.0	0.0	0
19:30-19:45	38	2	40	5.0	1.4	3	3	0	3	0.0	2.2	0
19:45-20:00	49	5	54	9.3	1.8	2	1	1	2	50.0	1.4	0
1時間計	187	10	197	5.1	6.7	10	7	1	8	12.5	5.8	0
20:00-20:15	17	2	19	10.5	0.6	0	1	0	1	0.0	0.7	0
20:15-20:30	31	2	33	6.1	1.1	2	2	1	3	33.3	2.2	0
20:30-20:45	26	2	28	7.1	1.0	0	0	0	0	0.0	0.0	0
20:45-21:00	39	1	40	2.5	1.4	4	0	0	0	0.0	0.0	0
1時間計	113	7	120	5.8	4.1	6	3	1	4	25.0	2.9	0
21:00-21:15	28	3	31	9.7	1.1	1	5	1	6	16.7	4.3	0
21:15-21:30	26	0	26	0.0	0.9	1	0	0	0	0.0	0.0	0
21:30-21:45	22	0	22	0.0	0.7	0	3	0	3	0.0	2.2	0
21:45-22:00	37	4	41	9.8	1.4	0	0	1	1	100.0	0.7	0
1時間計	113	7	120	5.8	4.1	2	8	2	10	20.0	7.2	0
昼12時間計	2028	111	2139	5.2	72.6	102	90	7	97	7.2	69.8	3
夜12時間計	727	79	806	9.8	27.4	38	32	10	42	23.8	30.2	0
全時間合計	2755	190	2945	6.5	100.0	140	122	17	139	12.2	100.0	3
昼夜率	1.36	1.71	1.38	-	-	1.37	1.36	2.43	1.43	-	-	1.00

方向別自動車交通量調査表

調査地点 : 地域社会1 目黒

調査年月日 : 令和元年 5月11日(土) 天候:晴れ時々曇り

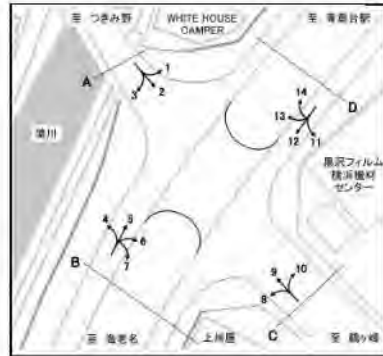

方向 種別 時間帯							D 合計 (11+12+13+14)					
	小型車 (台)	大型車 (台)	合計 (台)	大型車 混入率 (%)	時間 係数 (%)	二輪車 (台)	小型車 (台)	大型車 (台)	合計 (台)	大型車 混入率 (%)	時間 係数 (%)	二輪車 (台)
22:00-22:15							37	15	52	28.8	1.1	1
22:15-22:30							46	7	53	13.2	1.1	0
22:30-22:45							19	6	25	24.0	0.5	0
22:45-23:00							19	6	25	24.0	0.5	4
1時間計							121	34	155	21.9	3.2	5
23:00-23:15							23	3	26	11.5	0.5	1
23:15-23:30							12	7	19	36.8	0.4	1
23:30-23:45							18	4	22	18.2	0.4	1
23:45-24:00							27	14	41	34.1	0.8	1
1時間計							80	28	108	25.9	2.2	4
0:00- 0:15							13	4	17	23.5	0.3	2
0:15- 0:30							21	3	24	12.5	0.5	2
0:30- 0:45							11	5	16	31.3	0.3	1
0:45- 1:00							16	5	21	23.8	0.4	0
1時間計							61	17	78	21.8	1.6	5
1:00- 1:15							19	7	26	26.9	0.5	1
1:15- 1:30							20	6	26	23.1	0.5	1
1:30- 1:45							9	2	11	18.2	0.2	1
1:45- 2:00							12	7	19	36.8	0.4	2
1時間計							60	22	82	26.8	1.7	5
2:00- 2:15							13	12	25	48.0	0.5	1
2:15- 2:30							8	5	13	38.5	0.3	0
2:30- 2:45							7	8	15	53.3	0.3	0
2:45- 3:00							10	6	16	37.5	0.3	1
1時間計							38	31	69	44.9	1.4	2
3:00- 3:15							10	5	15	33.3	0.3	0
3:15- 3:30							10	7	17	41.2	0.3	0
3:30- 3:45							8	8	16	50.0	0.3	0
3:45- 4:00							8	4	12	33.3	0.2	0
1時間計							36	24	60	40.0	1.2	0
4:00- 4:15							15	4	19	21.1	0.4	1
4:15- 4:30							9	6	15	40.0	0.3	0
4:30- 4:45							9	6	15	40.0	0.3	0
4:45- 5:00							10	2	12	16.7	0.2	1
1時間計							43	18	61	29.5	1.2	2
5:00- 5:15							8	6	14	42.9	0.3	0
5:15- 5:30							11	6	17	35.3	0.3	1
5:30- 5:45							15	7	22	31.8	0.4	1
5:45- 6:00							6	7	13	53.8	0.3	1
1時間計							40	26	66	39.4	1.3	3

方向別自動車交通量調査表

調査地点：地域社会1 目黒

調査年月日：令和元年 5月11日(土) 天候：晴れ時々曇り

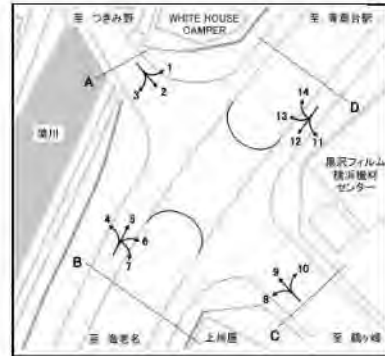

時間帯	方向 種別						D 合計 (11+12+13+14)					
		小型車 (台)	大型車 (台)	合計 (台)	大型車 混入率 (%)	時 間 係 数 (%)	二輪車 (台)	小型車 (台)	大型車 (台)	合計 (台)	大型車 混入率 (%)	時 間 係 数 (%)
6:00-6:15							7	2	9	22.2	0.2	1
6:15-6:30							17	7	24	29.2	0.5	1
6:30-6:45							19	2	21	9.5	0.4	0
6:45-7:00							14	3	17	17.6	0.3	0
1時間計							57	14	71	19.7	1.4	2
7:00-7:15							23	6	29	20.7	0.6	3
7:15-7:30							22	5	27	18.5	0.5	1
7:30-7:45							28	7	35	20.0	0.7	2
7:45-8:00							27	5	32	15.6	0.7	2
1時間計							100	23	123	18.7	2.5	8
8:00-8:15							58	6	64	9.4	1.3	6
8:15-8:30							39	5	44	11.4	0.9	3
8:30-8:45							27	3	30	10.0	0.6	1
8:45-9:00							56	10	66	15.2	1.3	3
1時間計							180	24	204	11.8	4.2	13
9:00-9:15							63	6	69	8.7	1.4	2
9:15-9:30							57	8	65	12.3	1.3	2
9:30-9:45							75	11	86	12.8	1.8	4
9:45-10:00							38	5	43	11.6	0.9	1
1時間計							233	30	263	11.4	5.4	9
10:00-10:15							67	5	72	6.9	1.5	1
10:15-10:30							64	6	70	8.6	1.4	8
10:30-10:45							63	8	71	11.3	1.4	7
10:45-11:00							65	2	67	3.0	1.4	1
1時間計							259	21	280	7.5	5.7	17
11:00-11:15							84	5	89	5.6	1.8	6
11:15-11:30							55	2	57	3.5	1.2	3
11:30-11:45							74	3	77	3.9	1.6	10
11:45-12:00							53	2	55	3.6	1.1	6
1時間計							266	12	278	4.3	5.7	25
12:00-12:15							93	4	97	4.1	2.0	3
12:15-12:30							87	5	92	5.4	1.9	7
12:30-12:45							72	5	77	6.5	1.6	1
12:45-13:00							75	6	81	7.4	1.6	6
1時間計							327	20	347	5.8	7.1	17
13:00-13:15							78	6	84	7.1	1.7	6
13:15-13:30							73	5	78	6.4	1.6	2
13:30-13:45							76	6	82	7.3	1.7	4
13:45-14:00							73	9	82	11.0	1.7	4
1時間計							300	26	326	8.0	6.6	16

方向別自動車交通量調査表

調査地点：地域社会1 目黒

調査年月日：令和元年 5月11日(土) 天候：晴れ時々曇り

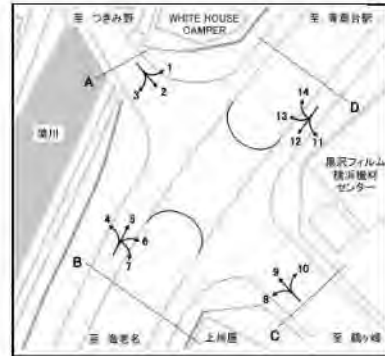

時間帯	方向 種別						D 合計 (11+12+13+14)					
		小型車 (台)	大型車 (台)	合計 (台)	大型車 混入率 (%)	時間 係数 (%)	二輪車 (台)	小型車 (台)	大型車 (台)	合計 (台)	大型車 混入率 (%)	時間 係数 (%)
14:00-14:15							74	6	80	7.5	1.6	4
14:15-14:30							67	5	72	6.9	1.5	7
14:30-14:45							104	5	109	4.6	2.2	8
14:45-15:00							83	3	86	3.5	1.8	6
1時間計							328	19	347	5.5	7.1	25
15:00-15:15							79	3	82	3.7	1.7	3
15:15-15:30							50	7	57	12.3	1.2	4
15:30-15:45							64	2	66	3.0	1.3	4
15:45-16:00							61	3	64	4.7	1.3	6
1時間計							254	15	269	5.6	5.5	17
16:00-16:15							69	7	76	9.2	1.5	5
16:15-16:30							66	9	75	12.0	1.5	4
16:30-16:45							69	3	72	4.2	1.5	5
16:45-17:00							88	6	94	6.4	1.9	5
1時間計							292	25	317	7.9	6.5	19
17:00-17:15							86	7	93	7.5	1.9	4
17:15-17:30							92	7	99	7.1	2.0	5
17:30-17:45							88	4	92	4.3	1.9	8
17:45-18:00							76	5	81	6.2	1.6	5
1時間計							342	23	365	6.3	7.4	22
18:00-18:15							70	7	77	9.1	1.6	2
18:15-18:30							74	4	78	5.1	1.6	1
18:30-18:45							68	7	75	9.3	1.5	3
18:45-19:00							82	4	86	4.7	1.8	4
1時間計							294	22	316	7.0	6.4	10
19:00-19:15							87	5	92	5.4	1.9	3
19:15-19:30							61	2	63	3.2	1.3	2
19:30-19:45							54	5	59	8.5	1.2	3
19:45-20:00							74	12	86	14.0	1.8	3
1時間計							276	24	300	8.0	6.1	11
20:00-20:15							35	7	42	16.7	0.9	0
20:15-20:30							57	15	72	20.8	1.5	3
20:30-20:45							38	6	44	13.6	0.9	1
20:45-21:00							56	8	64	12.5	1.3	4
1時間計							186	36	222	16.2	4.5	8
21:00-21:15							51	13	64	20.3	1.3	2
21:15-21:30							39	7	46	15.2	0.9	1
21:30-21:45							33	4	37	10.8	0.8	1
21:45-22:00							47	9	56	16.1	1.1	0
1時間計							170	33	203	16.3	4.1	4
昼12時間計							3175	260	3435	7.6	70.0	198
夜12時間計							1168	307	1475	20.8	30.0	51
全時間合計							4343	567	4910	11.5	100.0	249
昼夜率							1.37	2.18	1.43	-	-	1.26

方向別自動車交通量調査表

調査地点：地域社会2 目黒交番前

調査年月日：令和元年 5月11日(土) 天候：晴れ時々曇り

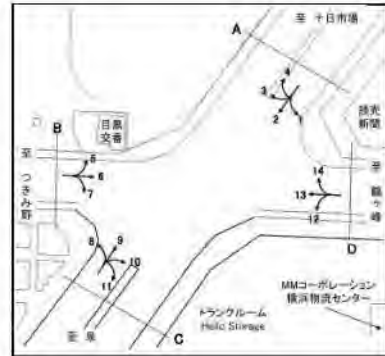

方向 種別 時間帯	1						2					
	小型車 (台)	大型車 (台)	合計 (台)	大型車 混入率 (%)	時間 係数 (%)	二輪車 (台)	小型車 (台)	大型車 (台)	合計 (台)	大型車 混入率 (%)	時間 係数 (%)	二輪車 (台)
22:00-22:15	0	0	0	0.0	0.0	0	30	1	31	3.2	0.9	4
22:15-22:30	0	0	0	0.0	0.0	0	28	1	29	3.4	0.8	0
22:30-22:45	0	0	0	0.0	0.0	0	20	1	21	4.8	0.6	2
22:45-23:00	0	0	0	0.0	0.0	0	22	2	24	8.3	0.7	0
1時間計	0	0	0	0.0	0.0	0	100	5	105	4.8	3.0	6
23:00-23:15	0	0	0	0.0	0.0	0	23	0	23	0.0	0.7	2
23:15-23:30	0	0	0	0.0	0.0	0	20	1	21	4.8	0.6	2
23:30-23:45	0	0	0	0.0	0.0	0	19	2	21	9.5	0.6	2
23:45-24:00	0	0	0	0.0	0.0	0	17	0	17	0.0	0.5	0
1時間計	0	0	0	0.0	0.0	0	79	3	82	3.7	2.4	6
0:00-0:15	0	0	0	0.0	0.0	0	14	0	14	0.0	0.4	0
0:15-0:30	0	0	0	0.0	0.0	0	9	0	9	0.0	0.3	0
0:30-0:45	0	0	0	0.0	0.0	0	6	0	6	0.0	0.2	0
0:45-1:00	0	0	0	0.0	0.0	0	13	2	15	13.3	0.4	0
1時間計	0	0	0	0.0	0.0	0	42	2	44	4.5	1.3	0
1:00-1:15	0	0	0	0.0	0.0	0	8	1	9	11.1	0.3	0
1:15-1:30	0	0	0	0.0	0.0	0	4	2	6	33.3	0.2	1
1:30-1:45	0	0	0	0.0	0.0	0	5	2	7	28.6	0.2	1
1:45-2:00	0	0	0	0.0	0.0	0	3	0	3	0.0	0.1	1
1時間計	0	0	0	0.0	0.0	0	20	5	25	20.0	0.7	3
2:00-2:15	0	0	0	0.0	0.0	0	6	1	7	14.3	0.2	0
2:15-2:30	0	2	2	100.0	3.7	0	7	1	8	12.5	0.2	0
2:30-2:45	0	1	1	100.0	1.9	0	11	0	11	0.0	0.3	0
2:45-3:00	1	0	1	0.0	1.9	0	6	0	6	0.0	0.2	0
1時間計	1	3	4	75.0	7.4	0	30	2	32	6.3	0.9	0
3:00-3:15	0	1	1	100.0	1.9	0	4	0	4	0.0	0.1	1
3:15-3:30	0	0	0	0.0	0.0	0	7	0	7	0.0	0.2	1
3:30-3:45	0	0	0	0.0	0.0	0	5	0	5	0.0	0.1	1
3:45-4:00	0	0	0	0.0	0.0	0	13	2	15	13.3	0.4	0
1時間計	0	1	1	100.0	1.9	0	29	2	31	6.5	0.9	3
4:00-4:15	0	0	0	0.0	0.0	0	6	1	7	14.3	0.2	0
4:15-4:30	1	0	1	0.0	1.9	0	6	2	8	25.0	0.2	1
4:30-4:45	0	0	0	0.0	0.0	0	6	0	6	0.0	0.2	2
4:45-5:00	0	0	0	0.0	0.0	0	7	2	9	22.2	0.3	1
1時間計	1	0	1	0.0	1.9	0	25	5	30	16.7	0.9	4
5:00-5:15	0	1	1	100.0	1.9	0	5	2	7	28.6	0.2	0
5:15-5:30	0	0	0	0.0	0.0	0	5	0	5	0.0	0.1	0
5:30-5:45	0	0	0	0.0	0.0	0	10	0	10	0.0	0.3	1
5:45-6:00	1	0	1	0.0	1.9	0	10	1	11	9.1	0.3	1
1時間計	1	1	2	50.0	3.7	0	30	3	33	9.1	0.9	2

方向別自動車交通量調査表

調査地点：地域社会2 目黒交番前

調査年月日：令和元年 5月11日(土) 天候：晴れ時々曇り



方向 時間帯	1						2					
	種別 小型車 (台)	大型車 (台)	合計 (台)	大型車 混入率 (%)	時間 係数 (%)	二輪車 (台)	小型車 (台)	大型車 (台)	合計 (台)	大型車 混入率 (%)	時間 係数 (%)	二輪車 (台)
6:00-6:15	0	0	0	0.0	0.0	0	10	3	13	23.1	0.4	0
6:15-6:30	0	1	1	100.0	1.9	0	23	3	26	11.5	0.7	1
6:30-6:45	0	0	0	0.0	0.0	0	13	3	16	18.8	0.5	0
6:45-7:00	0	0	0	0.0	0.0	0	16	2	18	11.1	0.5	0
1時間計	0	1	1	100.0	1.9	0	62	11	73	15.1	2.1	1
7:00-7:15	1	0	1	0.0	1.9	0	27	3	30	10.0	0.9	1
7:15-7:30	0	0	0	0.0	0.0	0	36	1	37	2.7	1.1	3
7:30-7:45	0	0	0	0.0	0.0	0	30	0	30	0.0	0.9	1
7:45-8:00	0	0	0	0.0	0.0	0	37	3	40	7.5	1.1	2
1時間計	1	0	1	0.0	1.9	0	130	7	137	5.1	3.9	7
8:00-8:15	1	0	1	0.0	1.9	0	39	5	44	11.4	1.3	1
8:15-8:30	0	0	0	0.0	0.0	0	31	4	35	11.4	1.0	4
8:30-8:45	1	0	1	0.0	1.9	0	37	2	39	5.1	1.1	6
8:45-9:00	0	1	1	100.0	1.9	0	40	1	41	2.4	1.2	3
1時間計	2	1	3	33.3	5.6	0	147	12	159	7.5	4.6	14
9:00-9:15	0	1	1	100.0	1.9	0	36	1	37	2.7	1.1	11
9:15-9:30	0	0	0	0.0	0.0	0	36	2	38	5.3	1.1	2
9:30-9:45	0	0	0	0.0	0.0	1	30	3	33	9.1	0.9	2
9:45-10:00	2	1	3	33.3	5.6	0	41	2	43	4.7	1.2	2
1時間計	2	2	4	50.0	7.4	1	143	8	151	5.3	4.3	17
10:00-10:15	0	0	0	0.0	0.0	0	36	3	39	7.7	1.1	2
10:15-10:30	1	0	1	0.0	1.9	0	30	3	33	9.1	0.9	5
10:30-10:45	1	0	1	0.0	1.9	0	54	2	56	3.6	1.6	2
10:45-11:00	0	0	0	0.0	0.0	0	38	1	39	2.6	1.1	3
1時間計	2	0	2	0.0	3.7	0	158	9	167	5.4	4.8	12
11:00-11:15	1	0	1	0.0	1.9	0	63	0	63	0.0	1.8	5
11:15-11:30	0	0	0	0.0	0.0	0	47	3	50	6.0	1.4	1
11:30-11:45	0	0	0	0.0	0.0	0	69	2	71	2.8	2.0	6
11:45-12:00	0	0	0	0.0	0.0	0	64	2	66	3.0	1.9	4
1時間計	1	0	1	0.0	1.9	0	243	7	250	2.8	7.2	16
12:00-12:15	0	0	0	0.0	0.0	0	55	3	58	5.2	1.7	5
12:15-12:30	0	0	0	0.0	0.0	0	50	1	51	2.0	1.5	2
12:30-12:45	0	0	0	0.0	0.0	0	50	0	50	0.0	1.4	4
12:45-13:00	0	1	1	100.0	1.9	0	66	1	67	1.5	1.9	5
1時間計	0	1	1	100.0	1.9	0	221	5	226	2.2	6.5	16
13:00-13:15	0	0	0	0.0	0.0	0	46	0	46	0.0	1.3	4
13:15-13:30	2	0	2	0.0	3.7	0	65	1	66	1.5	1.9	2
13:30-13:45	0	0	0	0.0	0.0	0	57	3	60	5.0	1.7	2
13:45-14:00	1	0	1	0.0	1.9	0	43	0	43	0.0	1.2	5
1時間計	3	0	3	0.0	5.6	0	211	4	215	1.9	6.2	13

方向別自動車交通量調査表

調査地点 : 地域社会2 目黒交番前

調査年月日 : 令和元年 5月11日(土) 天候:晴れ時々曇り



方向 種別 時間帯	1						2					
	小型車 (台)	大型車 (台)	合計 (台)	大型車 混入率 (%)	時間 係数 (%)	二輪車 (台)	小型車 (台)	大型車 (台)	合計 (台)	大型車 混入率 (%)	時間 係数 (%)	二輪車 (台)
14:00-14:15	2	0	2	0.0	3.7	0	64	1	65	1.5	1.9	4
14:15-14:30	0	0	0	0.0	0.0	0	57	3	60	5.0	1.7	6
14:30-14:45	1	0	1	0.0	1.9	0	65	2	67	3.0	1.9	2
14:45-15:00	0	0	0	0.0	0.0	0	59	0	59	0.0	1.7	1
1時間計	3	0	3	0.0	5.6	0	245	6	251	2.4	7.2	13
15:00-15:15	1	0	1	0.0	1.9	0	63	3	66	4.5	1.9	3
15:15-15:30	1	1	2	50.0	3.7	0	67	2	69	2.9	2.0	5
15:30-15:45	1	0	1	0.0	1.9	0	67	2	69	2.9	2.0	7
15:45-16:00	2	0	2	0.0	3.7	0	80	1	81	1.2	2.3	3
1時間計	5	1	6	16.7	11.1	0	277	8	285	2.8	8.2	18
16:00-16:15	0	0	0	0.0	0.0	0	57	1	58	1.7	1.7	6
16:15-16:30	0	0	0	0.0	0.0	0	50	2	52	3.8	1.5	3
16:30-16:45	2	0	2	0.0	3.7	0	80	3	83	3.6	2.4	5
16:45-17:00	0	1	1	100.0	1.9	0	72	2	74	2.7	2.1	4
1時間計	2	1	3	33.3	5.6	0	259	8	267	3.0	7.7	18
17:00-17:15	4	0	4	0.0	7.4	1	45	0	45	0.0	1.3	2
17:15-17:30	0	0	0	0.0	0.0	0	50	5	55	9.1	1.6	4
17:30-17:45	2	1	3	33.3	5.6	0	69	0	69	0.0	2.0	8
17:45-18:00	0	0	0	0.0	0.0	0	62	1	63	1.6	1.8	4
1時間計	6	1	7	14.3	13.0	1	226	6	232	2.6	6.7	18
18:00-18:15	0	0	0	0.0	0.0	0	48	0	48	0.0	1.4	6
18:15-18:30	1	0	1	0.0	1.9	0	44	2	46	4.3	1.3	4
18:30-18:45	1	1	2	50.0	3.7	2	51	1	52	1.9	1.5	6
18:45-19:00	1	0	1	0.0	1.9	0	54	1	55	1.8	1.6	2
1時間計	3	1	4	25.0	7.4	2	197	4	201	2.0	5.8	18
19:00-19:15	0	0	0	0.0	0.0	0	40	0	40	0.0	1.1	2
19:15-19:30	2	0	2	0.0	3.7	0	54	3	57	5.3	1.6	3
19:30-19:45	0	0	0	0.0	0.0	0	46	1	47	2.1	1.3	3
19:45-20:00	0	0	0	0.0	0.0	0	44	2	46	4.3	1.3	3
1時間計	2	0	2	0.0	3.7	0	184	6	190	3.2	5.5	11
20:00-20:15	0	0	0	0.0	0.0	0	30	1	31	3.2	0.9	1
20:15-20:30	0	0	0	0.0	0.0	0	49	1	50	2.0	1.4	1
20:30-20:45	0	0	0	0.0	0.0	0	45	0	45	0.0	1.3	2
20:45-21:00	0	1	1	100.0	1.9	0	34	1	35	2.9	1.0	2
1時間計	0	1	1	100.0	1.9	0	158	3	161	1.9	4.6	6
21:00-21:15	0	0	0	0.0	0.0	1	47	4	51	7.8	1.5	2
21:15-21:30	1	0	1	0.0	1.9	0	33	0	33	0.0	0.9	1
21:30-21:45	0	1	1	100.0	1.9	0	31	0	31	0.0	0.9	3
21:45-22:00	2	0	2	0.0	3.7	0	21	1	22	4.5	0.6	0
1時間計	3	1	4	25.0	7.4	1	132	5	137	3.6	3.9	6
昼12時間計	30	8	38	21.1	70.4	4	2457	84	2541	3.3	72.9	180
夜12時間計	8	8	16	50.0	29.6	1	891	52	943	5.5	27.1	48
全時間合計	38	16	54	29.6	100.0	5	3348	136	3484	3.9	100.0	228
昼夜率	1.27	2.00	1.42	-	-	1.25	1.36	1.62	1.37	-	-	1.27

方向別自動車交通量調査表

調査地点：地域社会2 目黒交番前

調査年月日：令和元年 5月11日(土) 天候：晴れ時々曇り



方向	3						4						
	種別	小型車 (台)	大型車 (台)	合計 (台)	大型車 混入率 (%)	時間 係数 (%)	二輪車 (台)	小型車 (台)	大型車 (台)	合計 (台)	大型車 混入率 (%)	時間 係数 (%)	二輪車 (台)
22:00-22:15		15	2	17	11.8	0.8	2	0	0	0	0.0	0.0	0
22:15-22:30		9	0	9	0.0	0.4	0	0	0	0	0.0	0.0	0
22:30-22:45		11	1	12	8.3	0.6	0	0	0	0	0.0	0.0	0
22:45-23:00		7	3	10	30.0	0.5	2	0	0	0	0.0	0.0	0
1時間計		42	6	48	12.5	2.2	4	0	0	0	0.0	0.0	0
23:00-23:15		7	4	11	36.4	0.5	0	0	0	0	0.0	0.0	0
23:15-23:30		4	2	6	33.3	0.3	0	0	0	0	0.0	0.0	0
23:30-23:45		11	2	13	15.4	0.6	0	0	0	0	0.0	0.0	0
23:45-24:00		7	0	7	0.0	0.3	1	0	0	0	0.0	0.0	0
1時間計		29	8	37	21.6	1.7	1	0	0	0	0.0	0.0	0
0:00-0:15		5	1	6	16.7	0.3	0	0	0	0	0.0	0.0	0
0:15-0:30		2	2	4	50.0	0.2	0	0	0	0	0.0	0.0	0
0:30-0:45		5	2	7	28.6	0.3	0	0	0	0	0.0	0.0	0
0:45-1:00		3	0	3	0.0	0.1	0	0	0	0	0.0	0.0	0
1時間計		15	5	20	25.0	0.9	0	0	0	0	0.0	0.0	0
1:00-1:15		5	1	6	16.7	0.3	0	0	0	0	0.0	0.0	0
1:15-1:30		4	1	5	20.0	0.2	1	0	0	0	0.0	0.0	0
1:30-1:45		2	0	2	0.0	0.1	0	0	0	0	0.0	0.0	0
1:45-2:00		3	2	5	40.0	0.2	0	0	0	0	0.0	0.0	0
1時間計		14	4	18	22.2	0.8	1	0	0	0	0.0	0.0	0
2:00-2:15		4	0	4	0.0	0.2	0	0	0	0	0.0	0.0	0
2:15-2:30		4	2	6	33.3	0.3	0	0	0	0	0.0	0.0	0
2:30-2:45		5	2	7	28.6	0.3	2	0	0	0	0.0	0.0	0
2:45-3:00		2	0	2	0.0	0.1	1	0	0	0	0.0	0.0	0
1時間計		15	4	19	21.1	0.9	3	0	0	0	0.0	0.0	0
3:00-3:15		0	1	1	100.0	0.0	1	0	0	0	0.0	0.0	0
3:15-3:30		1	3	4	75.0	0.2	0	0	0	0	0.0	0.0	0
3:30-3:45		5	2	7	28.6	0.3	1	0	0	0	0.0	0.0	0
3:45-4:00		5	0	5	0.0	0.2	0	0	0	0	0.0	0.0	0
1時間計		11	6	17	35.3	0.8	2	0	0	0	0.0	0.0	0
4:00-4:15		1	0	1	0.0	0.0	0	0	0	0	0.0	0.0	0
4:15-4:30		1	1	2	50.0	0.1	1	0	0	0	0.0	0.0	0
4:30-4:45		3	0	3	0.0	0.1	0	0	0	0	0.0	0.0	0
4:45-5:00		4	0	4	0.0	0.2	0	0	0	0	0.0	0.0	0
1時間計		9	1	10	10.0	0.5	1	0	0	0	0.0	0.0	0
5:00-5:15		2	0	2	0.0	0.1	0	0	0	0	0.0	0.0	0
5:15-5:30		5	0	5	0.0	0.2	0	0	0	0	0.0	0.0	0
5:30-5:45		2	0	2	0.0	0.1	0	0	0	0	0.0	0.0	0
5:45-6:00		5	0	5	0.0	0.2	1	0	0	0	0.0	0.0	0
1時間計		14	0	14	0.0	0.7	1	0	0	0	0.0	0.0	0

方向別自動車交通量調査表

調査地点 : 地域社会2 目黒交番前

調査年月日 : 令和元年 5月11日(土) 天候:晴れ時々曇り



方向 時間帯	3						4					
	種別 小型車 (台)	大型車 (台)	合計 (台)	大型車 混入率 (%)	時間 係数 (%)	二輪車 (台)	小型車 (台)	大型車 (台)	合計 (台)	大型車 混入率 (%)	時間 係数 (%)	二輪車 (台)
6:00-6:15	2	0	2	0.0	0.1	0	0	0	0	0.0	0.0	0
6:15-6:30	6	1	7	14.3	0.3	1	0	0	0	0.0	0.0	0
6:30-6:45	10	0	10	0.0	0.5	1	0	0	0	0.0	0.0	0
6:45-7:00	15	1	16	6.3	0.7	0	0	0	0	0.0	0.0	0
1時間計	33	2	35	5.7	1.6	2	0	0	0	0.0	0.0	0
7:00-7:15	9	4	13	30.8	0.6	2	0	0	0	0.0	0.0	0
7:15-7:30	16	4	20	20.0	0.9	2	0	0	0	0.0	0.0	0
7:30-7:45	17	5	22	22.7	1.0	3	0	0	0	0.0	0.0	0
7:45-8:00	21	1	22	4.5	1.0	3	0	0	0	0.0	0.0	0
1時間計	63	14	77	18.2	3.6	10	0	0	0	0.0	0.0	0
8:00-8:15	26	2	28	7.1	1.3	2	0	0	0	0.0	0.0	0
8:15-8:30	30	4	34	11.8	1.6	5	0	0	0	0.0	0.0	0
8:30-8:45	33	3	36	8.3	1.7	5	0	0	0	0.0	0.0	0
8:45-9:00	36	1	37	2.7	1.7	2	0	0	0	0.0	0.0	0
1時間計	125	10	135	7.4	6.3	14	0	0	0	0.0	0.0	0
9:00-9:15	28	2	30	6.7	1.4	0	0	0	0	0.0	0.0	0
9:15-9:30	27	2	29	6.9	1.4	1	0	0	0	0.0	0.0	0
9:30-9:45	24	1	25	4.0	1.2	4	0	0	0	0.0	0.0	0
9:45-10:00	29	3	32	9.4	1.5	1	0	0	0	0.0	0.0	0
1時間計	108	8	116	6.9	5.4	6	0	0	0	0.0	0.0	0
10:00-10:15	40	2	42	4.8	2.0	3	0	0	0	0.0	0.0	0
10:15-10:30	37	2	39	5.1	1.8	2	0	0	0	0.0	0.0	0
10:30-10:45	31	2	33	6.1	1.5	2	0	0	0	0.0	0.0	0
10:45-11:00	36	0	36	0.0	1.7	1	0	0	0	0.0	0.0	0
1時間計	144	6	150	4.0	7.0	8	0	0	0	0.0	0.0	0
11:00-11:15	33	1	34	2.9	1.6	2	0	0	0	0.0	0.0	0
11:15-11:30	31	2	33	6.1	1.5	3	0	0	0	0.0	0.0	0
11:30-11:45	38	3	41	7.3	1.9	2	0	0	0	0.0	0.0	0
11:45-12:00	44	1	45	2.2	2.1	1	0	0	0	0.0	0.0	0
1時間計	146	7	153	4.6	7.1	8	0	0	0	0.0	0.0	0
12:00-12:15	34	2	36	5.6	1.7	0	0	0	0	0.0	0.0	0
12:15-12:30	30	1	31	3.2	1.4	0	0	0	0	0.0	0.0	0
12:30-12:45	33	4	37	10.8	1.7	0	0	0	0	0.0	0.0	0
12:45-13:00	37	3	40	7.5	1.9	0	0	0	0	0.0	0.0	0
1時間計	134	10	144	6.9	6.7	0	0	0	0	0.0	0.0	0
13:00-13:15	43	1	44	2.3	2.1	3	0	0	0	0.0	0.0	0
13:15-13:30	35	2	37	5.4	1.7	0	0	0	0	0.0	0.0	0
13:30-13:45	43	1	44	2.3	2.1	1	0	0	0	0.0	0.0	0
13:45-14:00	37	2	39	5.1	1.8	1	0	0	0	0.0	0.0	0
1時間計	158	6	164	3.7	7.6	5	0	0	0	0.0	0.0	0

方向別自動車交通量調査表

調査地点：地域社会2 目黒交番前

調査年月日：令和元年 5月11日(土) 天候：晴れ時々曇り



方向 種別 時間帯	3						4					
	小型車 (台)	大型車 (台)	合計 (台)	大型車 混入率 (%)	時間 係数 (%)	二輪車 (台)	小型車 (台)	大型車 (台)	合計 (台)	大型車 混入率 (%)	時間 係数 (%)	二輪車 (台)
14:00-14:15	45	2	47	4.3	2.2	1	0	0	0	0.0	0.0	0
14:15-14:30	36	0	36	0.0	1.7	2	0	0	0	0.0	0.0	0
14:30-14:45	37	2	39	5.1	1.8	2	0	0	0	0.0	0.0	0
14:45-15:00	40	3	43	7.0	2.0	0	0	0	0	0.0	0.0	0
1時間計	158	7	165	4.2	7.7	5	0	0	0	0.0	0.0	0
15:00-15:15	38	0	38	0.0	1.8	2	0	0	0	0.0	0.0	0
15:15-15:30	38	3	41	7.3	1.9	1	0	0	0	0.0	0.0	0
15:30-15:45	47	2	49	4.1	2.3	1	0	0	0	0.0	0.0	0
15:45-16:00	42	1	43	2.3	2.0	1	0	0	0	0.0	0.0	0
1時間計	165	6	171	3.5	8.0	5	0	0	0	0.0	0.0	0
16:00-16:15	36	4	40	10.0	1.9	2	0	0	0	0.0	0.0	0
16:15-16:30	32	0	32	0.0	1.5	1	0	0	0	0.0	0.0	0
16:30-16:45	31	2	33	6.1	1.5	1	0	0	0	0.0	0.0	0
16:45-17:00	42	1	43	2.3	2.0	2	0	0	0	0.0	0.0	0
1時間計	141	7	148	4.7	6.9	6	0	0	0	0.0	0.0	0
17:00-17:15	27	3	30	10.0	1.4	1	0	0	0	0.0	0.0	0
17:15-17:30	24	5	29	17.2	1.4	1	0	0	0	0.0	0.0	0
17:30-17:45	34	1	35	2.9	1.6	1	0	0	0	0.0	0.0	0
17:45-18:00	40	1	41	2.4	1.9	1	0	0	0	0.0	0.0	0
1時間計	125	10	135	7.4	6.3	4	0	0	0	0.0	0.0	0
18:00-18:15	36	1	37	2.7	1.7	2	0	0	0	0.0	0.0	0
18:15-18:30	30	2	32	6.3	1.5	1	0	0	0	0.0	0.0	0
18:30-18:45	31	1	32	3.1	1.5	0	0	0	0	0.0	0.0	0
18:45-19:00	34	3	37	8.1	1.7	1	0	0	0	0.0	0.0	0
1時間計	131	7	138	5.1	6.4	4	0	0	0	0.0	0.0	0
19:00-19:15	24	0	24	0.0	1.1	0	0	0	0	0.0	0.0	0
19:15-19:30	28	0	28	0.0	1.3	0	0	0	0	0.0	0.0	0
19:30-19:45	20	1	21	4.8	1.0	1	0	0	0	0.0	0.0	0
19:45-20:00	17	0	17	0.0	0.8	0	0	0	0	0.0	0.0	0
1時間計	89	1	90	1.1	4.2	1	0	0	0	0.0	0.0	0
20:00-20:15	16	0	16	0.0	0.7	0	0	0	0	0.0	0.0	0
20:15-20:30	18	0	18	0.0	0.8	2	0	0	0	0.0	0.0	0
20:30-20:45	21	2	23	8.7	1.1	2	0	0	0	0.0	0.0	0
20:45-21:00	15	1	16	6.3	0.7	1	0	0	0	0.0	0.0	0
1時間計	70	3	73	4.1	3.4	5	0	0	0	0.0	0.0	0
21:00-21:15	22	5	27	18.5	1.3	4	0	0	0	0.0	0.0	0
21:15-21:30	12	0	12	0.0	0.6	2	0	0	0	0.0	0.0	0
21:30-21:45	18	0	18	0.0	0.8	2	0	0	0	0.0	0.0	0
21:45-22:00	10	1	11	9.1	0.5	0	0	0	0	0.0	0.0	0
1時間計	62	6	68	8.8	3.2	8	0	0	0	0.0	0.0	0
昼12時間計	1598	98	1696	5.8	79.1	75	0	0	0	0.0	0.0	0
夜12時間計	403	46	449	10.2	20.9	29	0	0	0	0.0	0.0	0
全時間合計	2001	144	2145	6.7	100.0	104	0	0	0	0.0	0.0	0
昼夜率	1.25	1.47	1.26	-	-	1.39	0.00	0.00	0.00	-	-	0.00

方向別自動車交通量調査表

調査地点 : 地域社会2 目黒交番前

調査年月日 : 令和元年 5月11日(土) 天候:晴れ時々曇り



方向							A 合計 (1+ 2+ 3+ 4)					
	種別	小型車 (台)	大型車 (台)	合計 (台)	大型車 混入率 (%)	時 間 係 数 (%)	二輪車 (台)	小型車 (台)	大型車 (台)	合計 (台)	大型車 混入率 (%)	時 間 係 数 (%)
22:00-22:15							45	3	48	6.3	0.8	6
22:15-22:30							37	1	38	2.6	0.7	0
22:30-22:45							31	2	33	6.1	0.6	2
22:45-23:00							29	5	34	14.7	0.6	2
1 時間計							142	11	153	7.2	2.7	10
23:00-23:15							30	4	34	11.8	0.6	2
23:15-23:30							24	3	27	11.1	0.5	2
23:30-23:45							30	4	34	11.8	0.6	2
23:45-24:00							24	0	24	0.0	0.4	1
1 時間計							108	11	119	9.2	2.1	7
0:00- 0:15							19	1	20	5.0	0.4	0
0:15- 0:30							11	2	13	15.4	0.2	0
0:30- 0:45							11	2	13	15.4	0.2	0
0:45- 1:00							16	2	18	11.1	0.3	0
1 時間計							57	7	64	10.9	1.1	0
1:00- 1:15							13	2	15	13.3	0.3	0
1:15- 1:30							8	3	11	27.3	0.2	2
1:30- 1:45							7	2	9	22.2	0.2	1
1:45- 2:00							6	2	8	25.0	0.1	1
1 時間計							34	9	43	20.9	0.8	4
2:00- 2:15							10	1	11	9.1	0.2	0
2:15- 2:30							11	5	16	31.3	0.3	0
2:30- 2:45							16	3	19	15.8	0.3	2
2:45- 3:00							9	0	9	0.0	0.2	1
1 時間計							46	9	55	16.4	1.0	3
3:00- 3:15							4	2	6	33.3	0.1	2
3:15- 3:30							8	3	11	27.3	0.2	1
3:30- 3:45							10	2	12	16.7	0.2	2
3:45- 4:00							18	2	20	10.0	0.4	0
1 時間計							40	9	49	18.4	0.9	5
4:00- 4:15							7	1	8	12.5	0.1	0
4:15- 4:30							8	3	11	27.3	0.2	2
4:30- 4:45							9	0	9	0.0	0.2	2
4:45- 5:00							11	2	13	15.4	0.2	1
1 時間計							35	6	41	14.6	0.7	5
5:00- 5:15							7	3	10	30.0	0.2	0
5:15- 5:30							10	0	10	0.0	0.2	0
5:30- 5:45							12	0	12	0.0	0.2	1
5:45- 6:00							16	1	17	5.9	0.3	2
1 時間計							45	4	49	8.2	0.9	3

方向別自動車交通量調査表

調査地点：地域社会2 目黒交番前

調査年月日：令和元年 5月11日(土) 天候：晴れ時々曇り



時間帯	方向 種別						A 合計 (1+ 2+ 3+ 4)					
		小型車 (台)	大型車 (台)	合計 (台)	大型車 混入率 (%)	時間 係数 (%)	二輪車 (台)	小型車 (台)	大型車 (台)	合計 (台)	大型車 混入率 (%)	時間 係数 (%)
6:00-6:15							12	3	15	20.0	0.3	0
6:15-6:30							29	5	34	14.7	0.6	2
6:30-6:45							23	3	26	11.5	0.5	1
6:45-7:00							31	3	34	8.8	0.6	0
1時間計							95	14	109	12.8	1.9	3
7:00-7:15							37	7	44	15.9	0.8	3
7:15-7:30							52	5	57	8.8	1.0	5
7:30-7:45							47	5	52	9.6	0.9	4
7:45-8:00							58	4	62	6.5	1.1	5
1時間計							194	21	215	9.8	3.8	17
8:00-8:15							66	7	73	9.6	1.3	3
8:15-8:30							61	8	69	11.6	1.2	9
8:30-8:45							71	5	76	6.6	1.3	11
8:45-9:00							76	3	79	3.8	1.4	5
1時間計							274	23	297	7.7	5.2	28
9:00-9:15							64	4	68	5.9	1.2	11
9:15-9:30							63	4	67	6.0	1.2	3
9:30-9:45							54	4	58	6.9	1.0	7
9:45-10:00							72	6	78	7.7	1.4	3
1時間計							253	18	271	6.6	4.8	24
10:00-10:15							76	5	81	6.2	1.4	5
10:15-10:30							68	5	73	6.8	1.3	7
10:30-10:45							86	4	90	4.4	1.6	4
10:45-11:00							74	1	75	1.3	1.3	4
1時間計							304	15	319	4.7	5.6	20
11:00-11:15							97	1	98	1.0	1.7	7
11:15-11:30							78	5	83	6.0	1.5	4
11:30-11:45							107	5	112	4.5	2.0	8
11:45-12:00							108	3	111	2.7	2.0	5
1時間計							390	14	404	3.5	7.1	24
12:00-12:15							89	5	94	5.3	1.7	5
12:15-12:30							80	2	82	2.4	1.4	2
12:30-12:45							83	4	87	4.6	1.5	4
12:45-13:00							103	5	108	4.6	1.9	5
1時間計							355	16	371	4.3	6.5	16
13:00-13:15							89	1	90	1.1	1.6	7
13:15-13:30							102	3	105	2.9	1.8	2
13:30-13:45							100	4	104	3.8	1.8	3
13:45-14:00							81	2	83	2.4	1.5	6
1時間計							372	10	382	2.6	6.7	18

方向別自動車交通量調査表

調査地点 : 地域社会2 目黒交番前

調査年月日 : 令和元年 5月11日(土) 天候: 晴れ時々曇り



方向 種別 時間帯							A 合計 (1+ 2+ 3+ 4)					
	小型車 (台)	大型車 (台)	合計 (台)	大型車 混入率 (%)	時間 係数 (%)	二輪車 (台)	小型車 (台)	大型車 (台)	合計 (台)	大型車 混入率 (%)	時間 係数 (%)	二輪車 (台)
14:00-14:15							111	3	114	2.6	2.0	5
14:15-14:30							93	3	96	3.1	1.7	8
14:30-14:45							103	4	107	3.7	1.9	4
14:45-15:00							99	3	102	2.9	1.8	1
1時間計							406	13	419	3.1	7.4	18
15:00-15:15							102	3	105	2.9	1.8	5
15:15-15:30							106	6	112	5.4	2.0	6
15:30-15:45							115	4	119	3.4	2.1	8
15:45-16:00							124	2	126	1.6	2.2	4
1時間計							447	15	462	3.2	8.1	23
16:00-16:15							93	5	98	5.1	1.7	8
16:15-16:30							82	2	84	2.4	1.5	4
16:30-16:45							113	5	118	4.2	2.1	6
16:45-17:00							114	4	118	3.4	2.1	6
1時間計							402	16	418	3.8	7.4	24
17:00-17:15							76	3	79	3.8	1.4	4
17:15-17:30							74	10	84	11.9	1.5	5
17:30-17:45							105	2	107	1.9	1.9	9
17:45-18:00							102	2	104	1.9	1.8	5
1時間計							357	17	374	4.5	6.6	23
18:00-18:15							84	1	85	1.2	1.5	8
18:15-18:30							75	4	79	5.1	1.4	5
18:30-18:45							83	3	86	3.5	1.5	8
18:45-19:00							89	4	93	4.3	1.6	3
1時間計							331	12	343	3.5	6.0	24
19:00-19:15							64	0	64	0.0	1.1	2
19:15-19:30							84	3	87	3.4	1.5	3
19:30-19:45							66	2	68	2.9	1.2	4
19:45-20:00							61	2	63	3.2	1.1	3
1時間計							275	7	282	2.5	5.0	12
20:00-20:15							46	1	47	2.1	0.8	1
20:15-20:30							67	1	68	1.5	1.2	3
20:30-20:45							66	2	68	2.9	1.2	4
20:45-21:00							49	3	52	5.8	0.9	3
1時間計							228	7	235	3.0	4.1	11
21:00-21:15							69	9	78	11.5	1.4	7
21:15-21:30							46	0	46	0.0	0.8	3
21:30-21:45							49	1	50	2.0	0.9	5
21:45-22:00							33	2	35	5.7	0.6	0
1時間計							197	12	209	5.7	3.7	15
昼12時間計							4085	190	4275	4.4	75.2	259
夜12時間計							1302	106	1408	7.5	24.8	78
全時間合計							5387	296	5683	5.2	100.0	337
昼夜率							1.32	1.56	1.33	-	-	1.30

方向別自動車交通量調査表

調査地点：地域社会2 目黒交番前

調査年月日：令和元年 5月11日(土) 天候：晴れ時々曇り



方向 種別 時間帯	5						6					
	小型車 (台)	大型車 (台)	合計 (台)	大型車 混入率 (%)	時間 係数 (%)	二輪車 (台)	小型車 (台)	大型車 (台)	合計 (台)	大型車 混入率 (%)	時間 係数 (%)	二輪車 (台)
22:00-22:15	18	2	20	10.0	1.0	5	97	12	109	11.0	1.3	5
22:15-22:30	24	1	25	4.0	1.2	4	67	10	77	13.0	0.9	9
22:30-22:45	22	2	24	8.3	1.2	0	94	8	102	7.8	1.2	5
22:45-23:00	20	0	20	0.0	1.0	1	95	17	112	15.2	1.3	5
1時間計	84	5	89	5.6	4.4	10	353	47	400	11.8	4.6	24
23:00-23:15	7	1	8	12.5	0.4	0	66	14	80	17.5	0.9	6
23:15-23:30	12	3	15	20.0	0.7	1	46	10	56	17.9	0.6	1
23:30-23:45	7	1	8	12.5	0.4	0	40	11	51	21.6	0.6	2
23:45-24:00	6	0	6	0.0	0.3	0	33	6	39	15.4	0.4	3
1時間計	32	5	37	13.5	1.8	1	185	41	226	18.1	2.6	12
0:00- 0:15	8	3	11	27.3	0.5	1	40	13	53	24.5	0.6	1
0:15- 0:30	5	0	5	0.0	0.2	1	32	13	45	28.9	0.5	3
0:30- 0:45	2	1	3	33.3	0.1	0	17	8	25	32.0	0.3	1
0:45- 1:00	3	1	4	25.0	0.2	0	26	16	42	38.1	0.5	1
1時間計	18	5	23	21.7	1.1	2	115	50	165	30.3	1.9	6
1:00- 1:15	1	1	2	50.0	0.1	0	21	13	34	38.2	0.4	1
1:15- 1:30	2	1	3	33.3	0.1	1	20	12	32	37.5	0.4	0
1:30- 1:45	2	1	3	33.3	0.1	0	21	12	33	36.4	0.4	0
1:45- 2:00	3	0	3	0.0	0.1	1	9	8	17	47.1	0.2	1
1時間計	8	3	11	27.3	0.5	2	71	45	116	38.8	1.3	2
2:00- 2:15	1	0	1	0.0	0.0	0	19	9	28	32.1	0.3	1
2:15- 2:30	2	1	3	33.3	0.1	0	8	9	17	52.9	0.2	2
2:30- 2:45	1	0	1	0.0	0.0	0	21	14	35	40.0	0.4	0
2:45- 3:00	1	1	2	50.0	0.1	0	17	10	27	37.0	0.3	0
1時間計	5	2	7	28.6	0.3	0	65	42	107	39.3	1.2	3
3:00- 3:15	3	0	3	0.0	0.1	0	10	10	20	50.0	0.2	0
3:15- 3:30	1	1	2	50.0	0.1	0	11	14	25	56.0	0.3	0
3:30- 3:45	3	1	4	25.0	0.2	0	15	10	25	40.0	0.3	1
3:45- 4:00	0	1	1	100.0	0.0	0	11	7	18	38.9	0.2	0
1時間計	7	3	10	30.0	0.5	0	47	41	88	46.6	1.0	1
4:00- 4:15	2	0	2	0.0	0.1	0	10	13	23	56.5	0.3	2
4:15- 4:30	4	0	4	0.0	0.2	0	13	15	28	53.6	0.3	2
4:30- 4:45	2	0	2	0.0	0.1	0	23	18	41	43.9	0.5	0
4:45- 5:00	3	0	3	0.0	0.1	1	18	14	32	43.8	0.4	2
1時間計	11	0	11	0.0	0.5	1	64	60	124	48.4	1.4	6
5:00- 5:15	1	0	1	0.0	0.0	0	37	19	56	33.9	0.6	1
5:15- 5:30	5	1	6	16.7	0.3	1	33	10	43	23.3	0.5	0
5:30- 5:45	4	0	4	0.0	0.2	0	33	24	57	42.1	0.7	6
5:45- 6:00	7	1	8	12.5	0.4	1	43	15	58	25.9	0.7	4
1時間計	17	2	19	10.5	0.9	2	146	68	214	31.8	2.5	11

方向別自動車交通量調査表

調査地点：地域社会2 目黒交番前

調査年月日：令和元年 5月11日(土) 天候：晴れ時々曇り

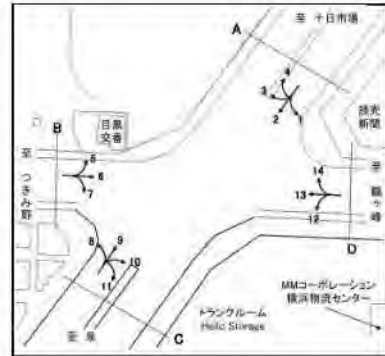

方向 時間帯	5						6					
	種別 小型車 (台)	大型車 (台)	合計 (台)	大型車 混入率 (%)	時間 係数 (%)	二輪車 (台)	小型車 (台)	大型車 (台)	合計 (台)	大型車 混入率 (%)	時間 係数 (%)	二輪車 (台)
6:00-6:15	7	1	8	12.5	0.4	0	46	10	56	17.9	0.6	4
6:15-6:30	9	2	11	18.2	0.5	1	58	5	63	7.9	0.7	3
6:30-6:45	11	1	12	8.3	0.6	0	51	12	63	19.0	0.7	7
6:45-7:00	5	1	6	16.7	0.3	0	50	10	60	16.7	0.7	7
1時間計	32	5	37	13.5	1.8	1	205	37	242	15.3	2.8	21
7:00-7:15	5	0	5	0.0	0.2	1	68	14	82	17.1	0.9	2
7:15-7:30	18	1	19	5.3	0.9	2	69	11	80	13.8	0.9	4
7:30-7:45	12	2	14	14.3	0.7	3	66	19	85	22.4	1.0	5
7:45-8:00	14	1	15	6.7	0.7	1	83	7	90	7.8	1.0	6
1時間計	49	4	53	7.5	2.6	7	286	51	337	15.1	3.9	17
8:00-8:15	19	4	23	17.4	1.1	2	91	14	105	13.3	1.2	7
8:15-8:30	23	1	24	4.2	1.2	3	91	19	110	17.3	1.3	9
8:30-8:45	24	4	28	14.3	1.4	3	111	21	132	15.9	1.5	8
8:45-9:00	26	7	33	21.2	1.6	0	91	14	105	13.3	1.2	2
1時間計	92	16	108	14.8	5.4	8	384	68	452	15.0	5.2	26
9:00-9:15	15	8	23	34.8	1.1	1	101	11	112	9.8	1.3	3
9:15-9:30	22	10	32	31.3	1.6	0	114	17	131	13.0	1.5	4
9:30-9:45	35	11	46	23.9	2.3	3	82	11	93	11.8	1.1	5
9:45-10:00	24	6	30	20.0	1.5	1	99	12	111	10.8	1.3	4
1時間計	96	35	131	26.7	6.5	5	396	51	447	11.4	5.2	16
10:00-10:15	15	4	19	21.1	0.9	1	103	12	115	10.4	1.3	2
10:15-10:30	40	2	42	4.8	2.1	2	82	8	90	8.9	1.0	7
10:30-10:45	26	2	28	7.1	1.4	1	122	7	129	5.4	1.5	5
10:45-11:00	18	0	18	0.0	0.9	1	109	13	122	10.7	1.4	4
1時間計	99	8	107	7.5	5.3	5	416	40	456	8.8	5.3	18
11:00-11:15	21	2	23	8.7	1.1	1	117	13	130	10.0	1.5	3
11:15-11:30	22	0	22	0.0	1.1	0	106	14	120	11.7	1.4	5
11:30-11:45	32	2	34	5.9	1.7	1	83	13	96	13.5	1.1	12
11:45-12:00	28	1	29	3.4	1.4	1	81	10	91	11.0	1.0	3
1時間計	103	5	108	4.6	5.4	3	387	50	437	11.4	5.0	23
12:00-12:15	32	1	33	3.0	1.6	3	103	12	115	10.4	1.3	3
12:15-12:30	28	0	28	0.0	1.4	1	97	17	114	14.9	1.3	5
12:30-12:45	25	0	25	0.0	1.2	1	115	14	129	10.9	1.5	5
12:45-13:00	27	0	27	0.0	1.3	1	107	15	122	12.3	1.4	6
1時間計	112	1	113	0.9	5.6	6	422	58	480	12.1	5.5	19
13:00-13:15	27	1	28	3.6	1.4	3	115	10	125	8.0	1.4	3
13:15-13:30	28	0	28	0.0	1.4	1	119	5	124	4.0	1.4	4
13:30-13:45	39	3	42	7.1	2.1	4	135	11	146	7.5	1.7	10
13:45-14:00	39	1	40	2.5	2.0	5	112	13	125	10.4	1.4	8
1時間計	133	5	138	3.6	6.8	13	481	39	520	7.5	6.0	25

方向別自動車交通量調査表

調査地点：地域社会2 目黒交番前

調査年月日：令和元年 5月11日(土) 天候：晴れ時々曇り



方向 種別 時間帯	5						6					
	小型車 (台)	大型車 (台)	合計 (台)	大型車 混入率 (%)	時間 係数 (%)	二輪車 (台)	小型車 (台)	大型車 (台)	合計 (台)	大型車 混入率 (%)	時間 係数 (%)	二輪車 (台)
14:00-14:15	37	5	42	11.9	2.1	0	97	16	113	14.2	1.3	5
14:15-14:30	29	0	29	0.0	1.4	3	98	5	103	4.9	1.2	1
14:30-14:45	31	1	32	3.1	1.6	3	103	10	113	8.8	1.3	3
14:45-15:00	34	0	34	0.0	1.7	1	123	15	138	10.9	1.6	8
1時間計	131	6	137	4.4	6.8	7	421	46	467	9.9	5.4	17
15:00-15:15	29	0	29	0.0	1.4	2	90	10	100	10.0	1.2	3
15:15-15:30	31	4	35	11.4	1.7	3	154	6	160	3.8	1.8	11
15:30-15:45	29	1	30	3.3	1.5	1	102	9	111	8.1	1.3	8
15:45-16:00	23	0	23	0.0	1.1	3	151	8	159	5.0	1.8	12
1時間計	112	5	117	4.3	5.8	9	497	33	530	6.2	6.1	34
16:00-16:15	31	0	31	0.0	1.5	1	102	12	114	10.5	1.3	6
16:15-16:30	42	2	44	4.5	2.2	4	113	9	122	7.4	1.4	9
16:30-16:45	28	0	28	0.0	1.4	3	108	7	115	6.1	1.3	6
16:45-17:00	30	2	32	6.3	1.6	1	116	9	125	7.2	1.4	8
1時間計	131	4	135	3.0	6.7	9	439	37	476	7.8	5.5	29
17:00-17:15	46	3	49	6.1	2.4	3	137	12	149	8.1	1.7	6
17:15-17:30	42	5	47	10.6	2.3	5	144	19	163	11.7	1.9	5
17:30-17:45	53	0	53	0.0	2.6	0	135	10	145	6.9	1.7	5
17:45-18:00	37	2	39	5.1	1.9	2	104	12	116	10.3	1.3	3
1時間計	178	10	188	5.3	9.3	10	520	53	573	9.2	6.6	19
18:00-18:15	40	3	43	7.0	2.1	3	134	10	144	6.9	1.7	6
18:15-18:30	35	3	38	7.9	1.9	0	113	19	132	14.4	1.5	5
18:30-18:45	40	0	40	0.0	2.0	2	133	12	145	8.3	1.7	4
18:45-19:00	40	0	40	0.0	2.0	1	114	14	128	10.9	1.5	2
1時間計	155	6	161	3.7	8.0	6	494	55	549	10.0	6.3	17
19:00-19:15	39	3	42	7.1	2.1	2	95	28	123	22.8	1.4	7
19:15-19:30	30	3	33	9.1	1.6	5	102	15	117	12.8	1.3	7
19:30-19:45	21	0	21	0.0	1.0	3	138	13	151	8.6	1.7	4
19:45-20:00	31	0	31	0.0	1.5	0	120	14	134	10.4	1.5	4
1時間計	121	6	127	4.7	6.3	10	455	70	525	13.3	6.1	22
20:00-20:15	24	1	25	4.0	1.2	0	96	12	108	11.1	1.2	6
20:15-20:30	19	1	20	5.0	1.0	0	71	16	87	18.4	1.0	3
20:30-20:45	30	2	32	6.3	1.6	0	99	12	111	10.8	1.3	9
20:45-21:00	10	0	10	0.0	0.5	0	79	14	93	15.1	1.1	6
1時間計	83	4	87	4.6	4.3	0	345	54	399	13.5	4.6	24
21:00-21:15	16	1	17	5.9	0.8	1	77	13	90	14.4	1.0	4
21:15-21:30	21	1	22	4.5	1.1	0	79	14	93	15.1	1.1	3
21:30-21:45	10	1	11	9.1	0.5	3	63	17	80	21.3	0.9	2
21:45-22:00	13	1	14	7.1	0.7	1	68	15	83	18.1	1.0	2
1時間計	60	4	64	6.3	3.2	5	287	59	346	17.1	4.0	11
昼12時間計	1391	105	1496	7.0	74.1	88	5143	581	5724	10.2	66.0	260
夜12時間計	478	44	522	8.4	25.9	34	2338	614	2952	20.8	34.0	143
全時間合計	1869	149	2018	7.4	100.0	122	7481	1195	8676	13.8	100.0	403
昼夜率	1.34	1.42	1.35	-	-	1.39	1.45	2.06	1.52	-	-	1.55

方向別自動車交通量調査表

調査地点：地域社会2 目黒交番前

調査年月日：令和元年 5月11日(土) 天候：晴れ時々曇り



方向 種別 時間帯	7						B 合計 (5+ 6+ 7)					
	小型車 (台)	大型車 (台)	合計 (台)	大型車 混入率 (%)	時間 係数 (%)	二輪車 (台)	小型車 (台)	大型車 (台)	合計 (台)	大型車 混入率 (%)	時間 係数 (%)	二輪車 (台)
22:00-22:15	24	2	26	7.7	2.0	1	139	16	155	10.3	1.3	11
22:15-22:30	18	1	19	5.3	1.5	0	109	12	121	9.9	1.0	13
22:30-22:45	19	1	20	5.0	1.5	0	135	11	146	7.5	1.2	5
22:45-23:00	14	3	17	17.6	1.3	2	129	20	149	13.4	1.2	8
1時間計	75	7	82	8.5	6.3	3	512	59	571	10.3	4.8	37
23:00-23:15	8	0	8	0.0	0.6	1	81	15	96	15.6	0.8	7
23:15-23:30	9	0	9	0.0	0.7	1	67	13	80	16.3	0.7	3
23:30-23:45	6	0	6	0.0	0.5	2	53	12	65	18.5	0.5	4
23:45-24:00	6	0	6	0.0	0.5	1	45	6	51	11.8	0.4	4
1時間計	29	0	29	0.0	2.2	5	246	46	292	15.8	2.4	18
0:00- 0:15	5	4	9	44.4	0.7	0	53	20	73	27.4	0.6	2
0:15- 0:30	5	4	9	44.4	0.7	0	42	17	59	28.8	0.5	4
0:30- 0:45	12	2	14	14.3	1.1	0	31	11	42	26.2	0.4	1
0:45- 1:00	3	3	6	50.0	0.5	0	32	20	52	38.5	0.4	1
1時間計	25	13	38	34.2	2.9	0	158	68	226	30.1	1.9	8
1:00- 1:15	5	0	5	0.0	0.4	0	27	14	41	34.1	0.3	1
1:15- 1:30	4	2	6	33.3	0.5	0	26	15	41	36.6	0.3	1
1:30- 1:45	6	2	8	25.0	0.6	0	29	15	44	34.1	0.4	0
1:45- 2:00	3	3	6	50.0	0.5	0	15	11	26	42.3	0.2	2
1時間計	18	7	25	28.0	1.9	0	97	55	152	36.2	1.3	4
2:00- 2:15	2	1	3	33.3	0.2	0	22	10	32	31.3	0.3	1
2:15- 2:30	2	2	4	50.0	0.3	0	12	12	24	50.0	0.2	2
2:30- 2:45	1	1	2	50.0	0.2	0	23	15	38	39.5	0.3	0
2:45- 3:00	3	1	4	25.0	0.3	0	21	12	33	36.4	0.3	0
1時間計	8	5	13	38.5	1.0	0	78	49	127	38.6	1.1	3
3:00- 3:15	4	0	4	0.0	0.3	0	17	10	27	37.0	0.2	0
3:15- 3:30	2	0	2	0.0	0.2	0	14	15	29	51.7	0.2	0
3:30- 3:45	1	2	3	66.7	0.2	0	19	13	32	40.6	0.3	1
3:45- 4:00	0	0	0	0.0	0.0	0	11	8	19	42.1	0.2	0
1時間計	7	2	9	22.2	0.7	0	61	46	107	43.0	0.9	1
4:00- 4:15	2	2	4	50.0	0.3	0	14	15	29	51.7	0.2	2
4:15- 4:30	3	6	9	66.7	0.7	0	20	21	41	51.2	0.3	2
4:30- 4:45	2	3	5	60.0	0.4	0	27	21	48	43.8	0.4	0
4:45- 5:00	1	3	4	75.0	0.3	1	22	17	39	43.6	0.3	4
1時間計	8	14	22	63.6	1.7	1	83	74	157	47.1	1.3	8
5:00- 5:15	1	0	1	0.0	0.1	0	39	19	58	32.8	0.5	1
5:15- 5:30	4	0	4	0.0	0.3	0	42	11	53	20.8	0.4	1
5:30- 5:45	4	8	12	66.7	0.9	0	41	32	73	43.8	0.6	6
5:45- 6:00	1	2	3	66.7	0.2	0	51	18	69	26.1	0.6	5
1時間計	10	10	20	50.0	1.5	0	173	80	253	31.6	2.1	13

方向別自動車交通量調査表

調査地点：地域社会2 目黒交番前

調査年月日：令和元年 5月11日(土) 天候：晴れ時々曇り



時間帯	種別	7						B 合計 (5+ 6+ 7)					
		小型車 (台)	大型車 (台)	合計 (台)	大型車 混入率 (%)	時間 係数 (%)	二輪車 (台)	小型車 (台)	大型車 (台)	合計 (台)	大型車 混入率 (%)	時間 係数 (%)	二輪車 (台)
6:00-6:15		7	0	7	0.0	0.5	1	60	11	71	15.5	0.6	5
6:15-6:30		5	3	8	37.5	0.6	1	72	10	82	12.2	0.7	5
6:30-6:45		5	2	7	28.6	0.5	1	67	15	82	18.3	0.7	8
6:45-7:00		10	1	11	9.1	0.8	0	65	12	77	15.6	0.6	7
1時間計		27	6	33	18.2	2.5	3	264	48	312	15.4	2.6	25
7:00-7:15		7	1	8	12.5	0.6	0	80	15	95	15.8	0.8	3
7:15-7:30		8	4	12	33.3	0.9	0	95	16	111	14.4	0.9	6
7:30-7:45		16	1	17	5.9	1.3	1	94	22	116	19.0	1.0	9
7:45-8:00		5	3	8	37.5	0.6	1	102	11	113	9.7	0.9	8
1時間計		36	9	45	20.0	3.5	2	371	64	435	14.7	3.6	26
8:00-8:15		17	4	21	19.0	1.6	1	127	22	149	14.8	1.2	10
8:15-8:30		7	1	8	12.5	0.6	1	121	21	142	14.8	1.2	13
8:30-8:45		11	8	19	42.1	1.5	0	146	33	179	18.4	1.5	11
8:45-9:00		11	1	12	8.3	0.9	1	128	22	150	14.7	1.3	3
1時間計		46	14	60	23.3	4.6	3	522	98	620	15.8	5.2	37
9:00-9:15		12	2	14	14.3	1.1	0	128	21	149	14.1	1.2	4
9:15-9:30		17	2	19	10.5	1.5	1	153	29	182	15.9	1.5	5
9:30-9:45		28	3	31	9.7	2.4	1	145	25	170	14.7	1.4	9
9:45-10:00		9	3	12	25.0	0.9	0	132	21	153	13.7	1.3	5
1時間計		66	10	76	13.2	5.8	2	558	96	654	14.7	5.5	23
10:00-10:15		13	0	13	0.0	1.0	0	131	16	147	10.9	1.2	3
10:15-10:30		10	1	11	9.1	0.8	2	132	11	143	7.7	1.2	11
10:30-10:45		22	0	22	0.0	1.7	1	170	9	179	5.0	1.5	7
10:45-11:00		26	1	27	3.7	2.1	0	153	14	167	8.4	1.4	5
1時間計		71	2	73	2.7	5.6	3	586	50	636	7.9	5.3	26
11:00-11:15		17	1	18	5.6	1.4	0	155	16	171	9.4	1.4	4
11:15-11:30		13	1	14	7.1	1.1	1	141	15	156	9.6	1.3	6
11:30-11:45		16	1	17	5.9	1.3	1	131	16	147	10.9	1.2	14
11:45-12:00		13	0	13	0.0	1.0	0	122	11	133	8.3	1.1	4
1時間計		59	3	62	4.8	4.8	2	549	58	607	9.6	5.1	28
12:00-12:15		13	1	14	7.1	1.1	1	148	14	162	8.6	1.4	7
12:15-12:30		13	0	13	0.0	1.0	0	138	17	155	11.0	1.3	6
12:30-12:45		15	1	16	6.3	1.2	1	155	15	170	8.8	1.4	7
12:45-13:00		18	0	18	0.0	1.4	0	152	15	167	9.0	1.4	7
1時間計		59	2	61	3.3	4.7	2	593	61	654	9.3	5.5	27
13:00-13:15		17	0	17	0.0	1.3	1	159	11	170	6.5	1.4	7
13:15-13:30		14	1	15	6.7	1.2	0	161	6	167	3.6	1.4	5
13:30-13:45		25	1	26	3.8	2.0	1	199	15	214	7.0	1.8	15
13:45-14:00		22	0	22	0.0	1.7	2	173	14	187	7.5	1.6	15
1時間計		78	2	80	2.5	6.1	4	692	46	738	6.2	6.2	42

方向別自動車交通量調査表

調査地点 : 地域社会2 目黒交番前

調査年月日 : 令和元年 5月11日(土) 天候:晴れ時々曇り



方向	7						B 合計 (5+ 6+ 7)					
	小型車 (台)	大型車 (台)	合計 (台)	大型車 混入率 (%)	時間 係数 (%)	二輪車 (台)	小型車 (台)	大型車 (台)	合計 (台)	大型車 混入率 (%)	時間 係数 (%)	二輪車 (台)
14:00-14:15	13	3	16	18.8	1.2	0	147	24	171	14.0	1.4	5
14:15-14:30	15	1	16	6.3	1.2	1	142	6	148	4.1	1.2	5
14:30-14:45	21	0	21	0.0	1.6	0	155	11	166	6.6	1.4	6
14:45-15:00	16	1	17	5.9	1.3	0	173	16	189	8.5	1.6	9
1時間計	65	5	70	7.1	5.4	1	617	57	674	8.5	5.6	25
15:00-15:15	5	0	5	0.0	0.4	0	124	10	134	7.5	1.1	5
15:15-15:30	19	3	22	13.6	1.7	1	204	13	217	6.0	1.8	15
15:30-15:45	22	1	23	4.3	1.8	2	153	11	164	6.7	1.4	11
15:45-16:00	14	0	14	0.0	1.1	0	188	8	196	4.1	1.6	15
1時間計	60	4	64	6.3	4.9	3	669	42	711	5.9	5.9	46
16:00-16:15	16	0	16	0.0	1.2	4	149	12	161	7.5	1.3	11
16:15-16:30	27	1	28	3.6	2.2	3	182	12	194	6.2	1.6	16
16:30-16:45	15	0	15	0.0	1.2	0	151	7	158	4.4	1.3	9
16:45-17:00	11	0	11	0.0	0.8	1	157	11	168	6.5	1.4	10
1時間計	69	1	70	1.4	5.4	8	639	42	681	6.2	5.7	46
17:00-17:15	12	0	12	0.0	0.9	1	195	15	210	7.1	1.8	10
17:15-17:30	17	1	18	5.6	1.4	0	203	25	228	11.0	1.9	10
17:30-17:45	17	2	19	10.5	1.5	5	205	12	217	5.5	1.8	10
17:45-18:00	21	2	23	8.7	1.8	3	162	16	178	9.0	1.5	8
1時間計	67	5	72	6.9	5.5	9	765	68	833	8.2	6.9	38
18:00-18:15	24	1	25	4.0	1.9	1	198	14	212	6.6	1.8	10
18:15-18:30	19	3	22	13.6	1.7	0	167	25	192	13.0	1.6	5
18:30-18:45	25	3	28	10.7	2.2	1	198	15	213	7.0	1.8	7
18:45-19:00	16	1	17	5.9	1.3	1	170	15	185	8.1	1.5	4
1時間計	84	8	92	8.7	7.1	3	733	69	802	8.6	6.7	26
19:00-19:15	25	1	26	3.8	2.0	2	159	32	191	16.8	1.6	11
19:15-19:30	17	0	17	0.0	1.3	2	149	18	167	10.8	1.4	14
19:30-19:45	20	1	21	4.8	1.6	0	179	14	193	7.3	1.6	7
19:45-20:00	31	3	34	8.8	2.6	1	182	17	199	8.5	1.7	5
1時間計	93	5	98	5.1	7.5	5	669	81	750	10.8	6.3	37
20:00-20:15	12	0	12	0.0	0.9	0	132	13	145	9.0	1.2	6
20:15-20:30	16	0	16	0.0	1.2	0	106	17	123	13.8	1.0	3
20:30-20:45	14	0	14	0.0	1.1	0	143	14	157	8.9	1.3	9
20:45-21:00	14	0	14	0.0	1.1	0	103	14	117	12.0	1.0	6
1時間計	56	0	56	0.0	4.3	0	484	58	542	10.7	4.5	24
21:00-21:15	16	1	17	5.9	1.3	1	109	15	124	12.1	1.0	6
21:15-21:30	7	1	8	12.5	0.6	1	107	16	123	13.0	1.0	4
21:30-21:45	13	1	14	7.1	1.1	0	86	19	105	18.1	0.9	5
21:45-22:00	11	1	12	8.3	0.9	0	92	17	109	15.6	0.9	3
1時間計	47	4	51	7.8	3.9	2	394	67	461	14.5	3.8	18
昼12時間計	760	65	825	7.9	63.4	42	7294	751	8045	9.3	67.1	390
夜12時間計	403	73	476	15.3	36.6	19	3219	731	3950	18.5	32.9	196
全時間合計	1163	138	1301	10.6	100.0	61	10513	1482	11995	12.4	100.0	586
昼夜率	1.53	2.12	1.58	-	-	1.45	1.44	1.97	1.49	-	-	1.50

方向別自動車交通量調査表

調査地点 : 地域社会2 目黒交番前

調査年月日 : 令和元年 5月11日(土) 天候:晴れ時々曇り



方向 種別 時間帯	8						9					
	小型車 (台)	大型車 (台)	合計 (台)	大型車 混入率 (%)	時間 係数 (%)	二輪車 (台)	小型車 (台)	大型車 (台)	合計 (台)	大型車 混入率 (%)	時間 係数 (%)	二輪車 (台)
22:00-22:15	6	0	6	0.0	0.8	0	19	0	19	0.0	0.6	1
22:15-22:30	3	1	4	25.0	0.5	0	12	1	13	7.7	0.4	2
22:30-22:45	5	1	6	16.7	0.8	0	16	1	17	5.9	0.5	1
22:45-23:00	0	0	0	0.0	0.0	0	17	1	18	5.6	0.5	0
1時間計	14	2	16	12.5	2.2	0	64	3	67	4.5	1.9	4
23:00-23:15	2	0	2	0.0	0.3	1	14	3	17	17.6	0.5	0
23:15-23:30	0	0	0	0.0	0.0	0	8	2	10	20.0	0.3	3
23:30-23:45	0	1	1	100.0	0.1	0	12	0	12	0.0	0.3	1
23:45-24:00	2	0	2	0.0	0.3	0	12	1	13	7.7	0.4	1
1時間計	4	1	5	20.0	0.7	1	46	6	52	11.5	1.5	5
0:00- 0:15	3	1	4	25.0	0.5	1	8	0	8	0.0	0.2	0
0:15- 0:30	3	0	3	0.0	0.4	0	3	0	3	0.0	0.1	0
0:30- 0:45	2	0	2	0.0	0.3	0	7	0	7	0.0	0.2	0
0:45- 1:00	2	0	2	0.0	0.3	0	5	1	6	16.7	0.2	1
1時間計	10	1	11	9.1	1.5	1	23	1	24	4.2	0.7	1
1:00- 1:15	0	0	0	0.0	0.0	0	10	3	13	23.1	0.4	0
1:15- 1:30	1	0	1	0.0	0.1	0	5	1	6	16.7	0.2	1
1:30- 1:45	1	0	1	0.0	0.1	0	6	0	6	0.0	0.2	0
1:45- 2:00	3	0	3	0.0	0.4	0	3	0	3	0.0	0.1	0
1時間計	5	0	5	0.0	0.7	0	24	4	28	14.3	0.8	1
2:00- 2:15	1	0	1	0.0	0.1	0	2	1	3	33.3	0.1	0
2:15- 2:30	2	0	2	0.0	0.3	0	3	1	4	25.0	0.1	0
2:30- 2:45	0	0	0	0.0	0.0	0	6	1	7	14.3	0.2	0
2:45- 3:00	0	0	0	0.0	0.0	0	3	2	5	40.0	0.1	0
1時間計	3	0	3	0.0	0.4	0	14	5	19	26.3	0.6	0
3:00- 3:15	3	2	5	40.0	0.7	0	1	1	2	50.0	0.1	0
3:15- 3:30	2	0	2	0.0	0.3	1	7	4	11	36.4	0.3	0
3:30- 3:45	0	0	0	0.0	0.0	0	9	1	10	10.0	0.3	0
3:45- 4:00	0	3	3	100.0	0.4	0	3	0	3	0.0	0.1	0
1時間計	5	5	10	50.0	1.4	1	20	6	26	23.1	0.8	0
4:00- 4:15	1	0	1	0.0	0.1	0	9	2	11	18.2	0.3	1
4:15- 4:30	0	1	1	100.0	0.1	0	5	1	6	16.7	0.2	0
4:30- 4:45	1	1	2	50.0	0.3	0	4	0	4	0.0	0.1	1
4:45- 5:00	0	1	1	100.0	0.1	0	10	1	11	9.1	0.3	2
1時間計	2	3	5	60.0	0.7	0	28	4	32	12.5	0.9	4
5:00- 5:15	1	0	1	0.0	0.1	0	17	5	22	22.7	0.6	0
5:15- 5:30	3	1	4	25.0	0.5	0	9	1	10	10.0	0.3	0
5:30- 5:45	3	1	4	25.0	0.5	0	14	2	16	12.5	0.5	2
5:45- 6:00	2	1	3	33.3	0.4	0	15	4	19	21.1	0.6	0
1時間計	9	3	12	25.0	1.6	0	55	12	67	17.9	1.9	2

方向別自動車交通量調査表

調査地点 : 地域社会2 目黒交番前

調査年月日 : 令和元年 5月11日(土) 天候:晴れ時々曇り

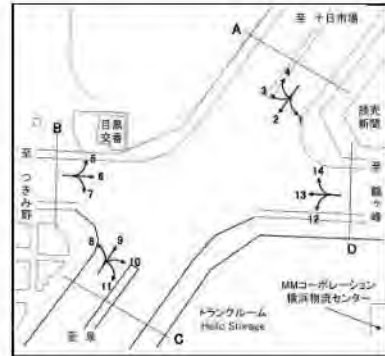

方向 時間帯	8						9					
	種別 小型車 (台)	大型車 (台)	合計 (台)	大型車 混入率 (%)	時間 係数 (%)	二輪車 (台)	小型車 (台)	大型車 (台)	合計 (台)	大型車 混入率 (%)	時間 係数 (%)	二輪車 (台)
6:00-6:15	1	1	2	50.0	0.3	0	21	2	23	8.7	0.7	2
6:15-6:30	2	0	2	0.0	0.3	0	17	2	19	10.5	0.6	1
6:30-6:45	4	1	5	20.0	0.7	0	27	2	29	6.9	0.8	4
6:45-7:00	7	1	8	12.5	1.1	0	32	1	33	3.0	1.0	2
1時間計	14	3	17	17.6	2.3	0	97	7	104	6.7	3.0	9
7:00-7:15	4	1	5	20.0	0.7	3	40	5	45	11.1	1.3	4
7:15-7:30	4	1	5	20.0	0.7	0	46	3	49	6.1	1.4	3
7:30-7:45	8	1	9	11.1	1.2	0	48	4	52	7.7	1.5	7
7:45-8:00	7	4	11	36.4	1.5	1	34	2	36	5.6	1.0	5
1時間計	23	7	30	23.3	4.1	4	168	14	182	7.7	5.3	19
8:00-8:15	14	0	14	0.0	1.9	0	59	1	60	1.7	1.7	10
8:15-8:30	5	3	8	37.5	1.1	2	55	5	60	8.3	1.7	1
8:30-8:45	13	3	16	18.8	2.2	2	59	0	59	0.0	1.7	5
8:45-9:00	11	1	12	8.3	1.6	1	54	2	56	3.6	1.6	3
1時間計	43	7	50	14.0	6.8	5	227	8	235	3.4	6.8	19
9:00-9:15	14	2	16	12.5	2.2	0	37	2	39	5.1	1.1	5
9:15-9:30	9	3	12	25.0	1.6	0	38	3	41	7.3	1.2	5
9:30-9:45	14	0	14	0.0	1.9	1	53	1	54	1.9	1.6	11
9:45-10:00	5	0	5	0.0	0.7	0	57	1	58	1.7	1.7	2
1時間計	42	5	47	10.6	6.4	1	185	7	192	3.6	5.6	23
10:00-10:15	17	2	19	10.5	2.6	0	47	3	50	6.0	1.5	2
10:15-10:30	11	0	11	0.0	1.5	1	65	0	65	0.0	1.9	4
10:30-10:45	10	1	11	9.1	1.5	0	49	1	50	2.0	1.5	2
10:45-11:00	9	1	10	10.0	1.4	3	48	0	48	0.0	1.4	7
1時間計	47	4	51	7.8	7.0	4	209	4	213	1.9	6.2	15
11:00-11:15	8	0	8	0.0	1.1	0	67	0	67	0.0	1.9	3
11:15-11:30	14	0	14	0.0	1.9	3	56	3	59	5.1	1.7	5
11:30-11:45	14	2	16	12.5	2.2	1	47	2	49	4.1	1.4	1
11:45-12:00	12	0	12	0.0	1.6	1	53	2	55	3.6	1.6	3
1時間計	48	2	50	4.0	6.8	5	223	7	230	3.0	6.7	12
12:00-12:15	11	2	13	15.4	1.8	0	43	2	45	4.4	1.3	5
12:15-12:30	14	1	15	6.7	2.1	0	47	0	47	0.0	1.4	2
12:30-12:45	14	2	16	12.5	2.2	2	56	1	57	1.8	1.7	4
12:45-13:00	11	0	11	0.0	1.5	0	59	1	60	1.7	1.7	4
1時間計	50	5	55	9.1	7.5	2	205	4	209	1.9	6.1	15
13:00-13:15	19	1	20	5.0	2.7	0	61	2	63	3.2	1.8	3
13:15-13:30	11	1	12	8.3	1.6	1	48	0	48	0.0	1.4	3
13:30-13:45	19	0	19	0.0	2.6	0	62	2	64	3.1	1.9	4
13:45-14:00	6	2	8	25.0	1.1	0	50	2	52	3.8	1.5	3
1時間計	55	4	59	6.8	8.1	1	221	6	227	2.6	6.6	13

方向別自動車交通量調査表

調査地点：地域社会2 目黒交番前

調査年月日：令和元年 5月11日(土) 天候：晴れ時々曇り



方向 種別 時間帯	8						9					
	小型車 (台)	大型車 (台)	合計 (台)	大型車 混入率 (%)	時間 係数 (%)	二輪車 (台)	小型車 (台)	大型車 (台)	合計 (台)	大型車 混入率 (%)	時間 係数 (%)	二輪車 (台)
14:00-14:15	12	0	12	0.0	1.6	0	53	4	57	7.0	1.7	4
14:15-14:30	14	0	14	0.0	1.9	0	47	3	50	6.0	1.5	1
14:30-14:45	8	1	9	11.1	1.2	0	66	0	66	0.0	1.9	6
14:45-15:00	14	2	16	12.5	2.2	0	68	1	69	1.4	2.0	6
1時間計	48	3	51	5.9	7.0	0	234	8	242	3.3	7.0	17
15:00-15:15	5	0	5	0.0	0.7	0	57	1	58	1.7	1.7	5
15:15-15:30	10	1	11	9.1	1.5	0	53	1	54	1.9	1.6	7
15:30-15:45	7	1	8	12.5	1.1	0	63	1	64	1.6	1.9	5
15:45-16:00	14	1	15	6.7	2.1	1	55	0	55	0.0	1.6	4
1時間計	36	3	39	7.7	5.3	1	228	3	231	1.3	6.7	21
16:00-16:15	12	0	12	0.0	1.6	1	67	0	67	0.0	1.9	2
16:15-16:30	11	0	11	0.0	1.5	2	53	1	54	1.9	1.6	2
16:30-16:45	14	1	15	6.7	2.1	0	71	1	72	1.4	2.1	5
16:45-17:00	8	0	8	0.0	1.1	1	73	1	74	1.4	2.1	9
1時間計	45	1	46	2.2	6.3	4	264	3	267	1.1	7.7	18
17:00-17:15	8	1	9	11.1	1.2	0	62	1	63	1.6	1.8	5
17:15-17:30	7	1	8	12.5	1.1	1	62	3	65	4.6	1.9	6
17:30-17:45	7	1	8	12.5	1.1	0	42	0	42	0.0	1.2	4
17:45-18:00	7	0	7	0.0	1.0	0	71	2	73	2.7	2.1	7
1時間計	29	3	32	9.4	4.4	1	237	6	243	2.5	7.0	22
18:00-18:15	11	1	12	8.3	1.6	0	49	0	49	0.0	1.4	3
18:15-18:30	9	2	11	18.2	1.5	1	30	2	32	6.3	0.9	0
18:30-18:45	12	4	16	25.0	2.2	0	41	0	41	0.0	1.2	3
18:45-19:00	7	2	9	22.2	1.2	0	42	0	42	0.0	1.2	3
1時間計	39	9	48	18.8	6.6	1	162	2	164	1.2	4.8	9
19:00-19:15	13	0	13	0.0	1.8	0	41	2	43	4.7	1.2	4
19:15-19:30	12	1	13	7.7	1.8	0	34	1	35	2.9	1.0	3
19:30-19:45	6	1	7	14.3	1.0	0	34	0	34	0.0	1.0	2
19:45-20:00	6	0	6	0.0	0.8	0	32	0	32	0.0	0.9	1
1時間計	37	2	39	5.1	5.3	0	141	3	144	2.1	4.2	10
20:00-20:15	6	1	7	14.3	1.0	0	35	2	37	5.4	1.1	3
20:15-20:30	8	2	10	20.0	1.4	0	29	0	29	0.0	0.8	2
20:30-20:45	3	0	3	0.0	0.4	0	24	0	24	0.0	0.7	0
20:45-21:00	7	0	7	0.0	1.0	0	35	1	36	2.8	1.0	4
1時間計	24	3	27	11.1	3.7	0	123	3	126	2.4	3.7	9
21:00-21:15	5	0	5	0.0	0.7	0	34	0	34	0.0	1.0	1
21:15-21:30	3	2	5	40.0	0.7	0	26	0	26	0.0	0.8	4
21:30-21:45	10	1	11	9.1	1.5	1	42	0	42	0.0	1.2	2
21:45-22:00	2	0	2	0.0	0.3	0	21	0	21	0.0	0.6	0
1時間計	20	3	23	13.0	3.1	1	123	0	123	0.0	3.6	7
昼12時間計	505	53	558	9.5	76.3	29	2563	72	2635	2.7	76.4	203
夜12時間計	147	26	173	15.0	23.7	4	758	54	812	6.7	23.6	52
全時間合計	652	79	731	10.8	100.0	33	3321	126	3447	3.7	100.0	255
昼夜率	1.29	1.49	1.31	-	-	1.14	1.30	1.75	1.31	-	-	1.26

方向別自動車交通量調査表

調査地点 : 地域社会2 目黒交番前

調査年月日 : 令和元年 5月11日(土) 天候:晴れ時々曇り

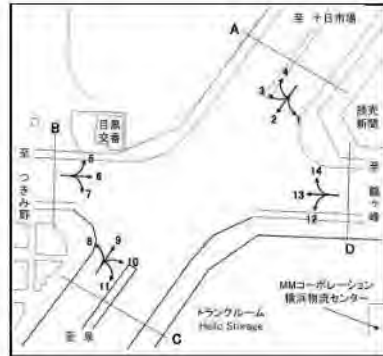

方向 種別 時間帯	10						11					
	小型車 (台)	大型車 (台)	合計 (台)	大型車 混入率 (%)	時間 係数 (%)	二輪車 (台)	小型車 (台)	大型車 (台)	合計 (台)	大型車 混入率 (%)	時間 係数 (%)	二輪車 (台)
22:00-22:15	9	0	9	0.0	0.7	2	0	0	0	0.0	0.0	0
22:15-22:30	6	0	6	0.0	0.5	0	0	0	0	0.0	0.0	0
22:30-22:45	6	1	7	14.3	0.6	2	0	0	0	0.0	0.0	0
22:45-23:00	7	2	9	22.2	0.7	0	0	0	0	0.0	0.0	0
1時間計	28	3	31	9.7	2.5	4	0	0	0	0.0	0.0	0
23:00-23:15	9	4	13	30.8	1.1	1	0	0	0	0.0	0.0	0
23:15-23:30	11	3	14	21.4	1.1	0	0	0	0	0.0	0.0	0
23:30-23:45	4	1	5	20.0	0.4	0	0	0	0	0.0	0.0	0
23:45-24:00	4	0	4	0.0	0.3	0	0	0	0	0.0	0.0	0
1時間計	28	8	36	22.2	3.0	1	0	0	0	0.0	0.0	0
0:00-0:15	1	0	1	0.0	0.1	0	0	0	0	0.0	0.0	0
0:15-0:30	2	0	2	0.0	0.2	0	0	0	0	0.0	0.0	0
0:30-0:45	4	0	4	0.0	0.3	0	0	0	0	0.0	0.0	0
0:45-1:00	4	1	5	20.0	0.4	0	0	0	0	0.0	0.0	0
1時間計	11	1	12	8.3	1.0	0	0	0	0	0.0	0.0	0
1:00-1:15	4	2	6	33.3	0.5	0	0	0	0	0.0	0.0	0
1:15-1:30	1	0	1	0.0	0.1	0	0	0	0	0.0	0.0	0
1:30-1:45	4	0	4	0.0	0.3	0	0	0	0	0.0	0.0	0
1:45-2:00	5	2	7	28.6	0.6	0	0	0	0	0.0	0.0	0
1時間計	14	4	18	22.2	1.5	0	0	0	0	0.0	0.0	0
2:00-2:15	5	1	6	16.7	0.5	1	0	0	0	0.0	0.0	0
2:15-2:30	0	1	1	100.0	0.1	0	0	0	0	0.0	0.0	0
2:30-2:45	1	1	2	50.0	0.2	0	0	0	0	0.0	0.0	0
2:45-3:00	3	1	4	25.0	0.3	0	0	0	0	0.0	0.0	0
1時間計	9	4	13	30.8	1.1	1	0	0	0	0.0	0.0	0
3:00-3:15	0	1	1	100.0	0.1	0	0	0	0	0.0	0.0	0
3:15-3:30	1	1	2	50.0	0.2	0	0	0	0	0.0	0.0	0
3:30-3:45	2	0	2	0.0	0.2	0	0	0	0	0.0	0.0	0
3:45-4:00	1	0	1	0.0	0.1	1	0	0	0	0.0	0.0	0
1時間計	4	2	6	33.3	0.5	1	0	0	0	0.0	0.0	0
4:00-4:15	1	0	1	0.0	0.1	0	0	0	0	0.0	0.0	0
4:15-4:30	3	0	3	0.0	0.2	0	0	0	0	0.0	0.0	0
4:30-4:45	7	1	8	12.5	0.7	0	0	0	0	0.0	0.0	0
4:45-5:00	9	0	9	0.0	0.7	0	0	0	0	0.0	0.0	0
1時間計	20	1	21	4.8	1.7	0	0	0	0	0.0	0.0	0
5:00-5:15	2	0	2	0.0	0.2	4	0	0	0	0.0	0.0	0
5:15-5:30	8	2	10	20.0	0.8	1	0	0	0	0.0	0.0	0
5:30-5:45	4	1	5	20.0	0.4	1	0	0	0	0.0	0.0	0
5:45-6:00	6	0	6	0.0	0.5	1	0	0	0	0.0	0.0	0
1時間計	20	3	23	13.0	1.9	7	0	0	0	0.0	0.0	0

方向別自動車交通量調査表

調査地点 : 地域社会2 目黒交番前

調査年月日 : 令和元年 5月11日(土) 天候:晴れ時々曇り



方向 時間帯	10						11					
	種別 小型車 (台)	大型車 (台)	合計 (台)	大型車 混入率 (%)	時間 係数 (%)	二輪車 (台)	小型車 (台)	大型車 (台)	合計 (台)	大型車 混入率 (%)	時間 係数 (%)	二輪車 (台)
6:00-6:15	10	1	11	9.1	0.9	1	0	0	0	0.0	0.0	0
6:15-6:30	12	2	14	14.3	1.1	0	0	0	0	0.0	0.0	0
6:30-6:45	14	1	15	6.7	1.2	1	0	0	0	0.0	0.0	0
6:45-7:00	12	0	12	0.0	1.0	2	0	0	0	0.0	0.0	0
1時間計	48	4	52	7.7	4.3	4	0	0	0	0.0	0.0	0
7:00-7:15	18	1	19	5.3	1.6	0	0	0	0	0.0	0.0	0
7:15-7:30	16	0	16	0.0	1.3	0	0	0	0	0.0	0.0	0
7:30-7:45	17	1	18	5.6	1.5	2	0	0	0	0.0	0.0	0
7:45-8:00	21	0	21	0.0	1.7	0	0	0	0	0.0	0.0	0
1時間計	72	2	74	2.7	6.1	2	0	0	0	0.0	0.0	0
8:00-8:15	12	0	12	0.0	1.0	3	0	0	0	0.0	0.0	0
8:15-8:30	17	2	19	10.5	1.6	1	0	0	0	0.0	0.0	0
8:30-8:45	15	1	16	6.3	1.3	0	0	0	0	0.0	0.0	0
8:45-9:00	25	2	27	7.4	2.2	3	1	0	1	0.0	25.0	0
1時間計	69	5	74	6.8	6.1	7	1	0	1	0.0	25.0	0
9:00-9:15	23	0	23	0.0	1.9	1	0	0	0	0.0	0.0	0
9:15-9:30	14	0	14	0.0	1.1	1	1	0	1	0.0	25.0	0
9:30-9:45	24	0	24	0.0	2.0	2	0	0	0	0.0	0.0	0
9:45-10:00	17	0	17	0.0	1.4	2	0	0	0	0.0	0.0	0
1時間計	78	0	78	0.0	6.4	6	1	0	1	0.0	25.0	0
10:00-10:15	25	0	25	0.0	2.1	0	0	0	0	0.0	0.0	0
10:15-10:30	21	2	23	8.7	1.9	1	0	0	0	0.0	0.0	0
10:30-10:45	16	3	19	15.8	1.6	1	0	0	0	0.0	0.0	0
10:45-11:00	13	2	15	13.3	1.2	2	0	0	0	0.0	0.0	0
1時間計	75	7	82	8.5	6.7	4	0	0	0	0.0	0.0	0
11:00-11:15	21	1	22	4.5	1.8	1	0	0	0	0.0	0.0	0
11:15-11:30	17	0	17	0.0	1.4	3	0	0	0	0.0	0.0	0
11:30-11:45	16	0	16	0.0	1.3	2	0	0	0	0.0	0.0	0
11:45-12:00	27	0	27	0.0	2.2	2	0	0	0	0.0	0.0	0
1時間計	81	1	82	1.2	6.7	8	0	0	0	0.0	0.0	0
12:00-12:15	14	2	16	12.5	1.3	0	0	0	0	0.0	0.0	0
12:15-12:30	14	1	15	6.7	1.2	0	0	0	0	0.0	0.0	0
12:30-12:45	21	1	22	4.5	1.8	0	0	0	0	0.0	0.0	0
12:45-13:00	18	1	19	5.3	1.6	1	0	0	0	0.0	0.0	0
1時間計	67	5	72	6.9	5.9	1	0	0	0	0.0	0.0	0
13:00-13:15	13	0	13	0.0	1.1	0	0	0	0	0.0	0.0	0
13:15-13:30	11	0	11	0.0	0.9	0	0	0	0	0.0	0.0	0
13:30-13:45	21	2	23	8.7	1.9	2	1	0	1	0.0	25.0	0
13:45-14:00	20	0	20	0.0	1.6	1	1	0	1	0.0	25.0	0
1時間計	65	2	67	3.0	5.5	3	2	0	2	0.0	50.0	0

方向別自動車交通量調査表

調査地点：地域社会2 目黒交番前

調査年月日：令和元年 5月11日(土) 天候：晴れ時々曇り

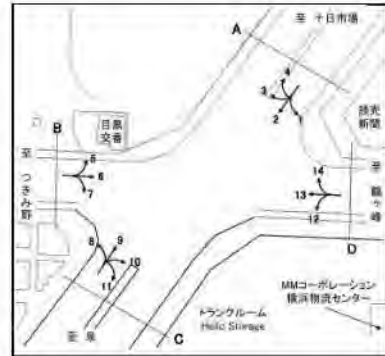

方向 種別 時間帯	10						11					
	小型車 (台)	大型車 (台)	合計 (台)	大型車 混入率 (%)	時間 係数 (%)	二輪車 (台)	小型車 (台)	大型車 (台)	合計 (台)	大型車 混入率 (%)	時間 係数 (%)	二輪車 (台)
14:00-14:15	18	0	18	0.0	1.5	0	0	0	0	0.0	0.0	0
14:15-14:30	18	0	18	0.0	1.5	2	0	0	0	0.0	0.0	0
14:30-14:45	16	0	16	0.0	1.3	2	0	0	0	0.0	0.0	0
14:45-15:00	18	0	18	0.0	1.5	0	0	0	0	0.0	0.0	0
1時間計	70	0	70	0.0	5.7	4	0	0	0	0.0	0.0	0
15:00-15:15	14	1	15	6.7	1.2	1	0	0	0	0.0	0.0	0
15:15-15:30	22	0	22	0.0	1.8	1	0	0	0	0.0	0.0	0
15:30-15:45	8	1	9	11.1	0.7	1	0	0	0	0.0	0.0	0
15:45-16:00	27	4	31	12.9	2.5	2	0	0	0	0.0	0.0	0
1時間計	71	6	77	7.8	6.3	5	0	0	0	0.0	0.0	0
16:00-16:15	18	1	19	5.3	1.6	1	0	0	0	0.0	0.0	0
16:15-16:30	15	0	15	0.0	1.2	2	0	0	0	0.0	0.0	0
16:30-16:45	25	1	26	3.8	2.1	3	0	0	0	0.0	0.0	0
16:45-17:00	14	1	15	6.7	1.2	0	0	0	0	0.0	0.0	0
1時間計	72	3	75	4.0	6.2	6	0	0	0	0.0	0.0	0
17:00-17:15	18	1	19	5.3	1.6	3	0	0	0	0.0	0.0	0
17:15-17:30	15	3	18	16.7	1.5	0	0	0	0	0.0	0.0	0
17:30-17:45	12	3	15	20.0	1.2	0	0	0	0	0.0	0.0	0
17:45-18:00	22	1	23	4.3	1.9	0	0	0	0	0.0	0.0	0
1時間計	67	8	75	10.7	6.2	3	0	0	0	0.0	0.0	0
18:00-18:15	21	0	21	0.0	1.7	1	0	0	0	0.0	0.0	0
18:15-18:30	14	0	14	0.0	1.1	1	0	0	0	0.0	0.0	0
18:30-18:45	9	0	9	0.0	0.7	1	0	0	0	0.0	0.0	0
18:45-19:00	12	0	12	0.0	1.0	1	0	0	0	0.0	0.0	0
1時間計	56	0	56	0.0	4.6	4	0	0	0	0.0	0.0	0
19:00-19:15	11	0	11	0.0	0.9	0	0	0	0	0.0	0.0	0
19:15-19:30	16	1	17	5.9	1.4	1	0	0	0	0.0	0.0	0
19:30-19:45	13	0	13	0.0	1.1	0	0	0	0	0.0	0.0	0
19:45-20:00	9	1	10	10.0	0.8	0	0	0	0	0.0	0.0	0
1時間計	49	2	51	3.9	4.2	1	0	0	0	0.0	0.0	0
20:00-20:15	6	0	6	0.0	0.5	0	0	0	0	0.0	0.0	0
20:15-20:30	11	1	12	8.3	1.0	1	0	0	0	0.0	0.0	0
20:30-20:45	9	1	10	10.0	0.8	0	0	0	0	0.0	0.0	0
20:45-21:00	9	0	9	0.0	0.7	1	0	0	0	0.0	0.0	0
1時間計	35	2	37	5.4	3.0	2	0	0	0	0.0	0.0	0
21:00-21:15	8	0	8	0.0	0.7	1	0	0	0	0.0	0.0	0
21:15-21:30	10	0	10	0.0	0.8	0	0	0	0	0.0	0.0	0
21:30-21:45	8	0	8	0.0	0.7	0	0	0	0	0.0	0.0	0
21:45-22:00	9	1	10	10.0	0.8	1	0	0	0	0.0	0.0	0
1時間計	35	1	36	2.8	3.0	2	0	0	0	0.0	0.0	0
昼12時間計	843	39	882	4.4	72.4	53	4	0	4	0.0	100.0	0
夜12時間計	301	35	336	10.4	27.6	23	0	0	0	0.0	0.0	0
全時間合計	1144	74	1218	6.1	100.0	76	4	0	4	0.0	100.0	0
昼夜率	1.36	1.90	1.38	-	-	1.43	1.00	0.00	1.00	-	-	0.00

方向別自動車交通量調査表

調査地点：地域社会2 目黒交番前

調査年月日：令和元年 5月11日(土) 天候：晴れ時々曇り



方向 種別 時間帯							C 合計 (8+ 9+10+11)					
	小型車 (台)	大型車 (台)	合計 (台)	大型車 混入率 (%)	時間 係数 (%)	二輪車 (台)	小型車 (台)	大型車 (台)	合計 (台)	大型車 混入率 (%)	時間 係数 (%)	二輪車 (台)
22:00-22:15							34	0	34	0.0	0.6	3
22:15-22:30							21	2	23	8.7	0.4	2
22:30-22:45							27	3	30	10.0	0.6	3
22:45-23:00							24	3	27	11.1	0.5	0
1 時間計							106	8	114	7.0	2.1	8
23:00-23:15							25	7	32	21.9	0.6	2
23:15-23:30							19	5	24	20.8	0.4	3
23:30-23:45							16	2	18	11.1	0.3	1
23:45-24:00							18	1	19	5.3	0.4	1
1 時間計							78	15	93	16.1	1.7	7
0:00- 0:15							12	1	13	7.7	0.2	1
0:15- 0:30							8	0	8	0.0	0.1	0
0:30- 0:45							13	0	13	0.0	0.2	0
0:45- 1:00							11	2	13	15.4	0.2	1
1 時間計							44	3	47	6.4	0.9	2
1:00- 1:15							14	5	19	26.3	0.4	0
1:15- 1:30							7	1	8	12.5	0.1	1
1:30- 1:45							11	0	11	0.0	0.2	0
1:45- 2:00							11	2	13	15.4	0.2	0
1 時間計							43	8	51	15.7	0.9	1
2:00- 2:15							8	2	10	20.0	0.2	1
2:15- 2:30							5	2	7	28.6	0.1	0
2:30- 2:45							7	2	9	22.2	0.2	0
2:45- 3:00							6	3	9	33.3	0.2	0
1 時間計							26	9	35	25.7	0.6	1
3:00- 3:15							4	4	8	50.0	0.1	0
3:15- 3:30							10	5	15	33.3	0.3	1
3:30- 3:45							11	1	12	8.3	0.2	0
3:45- 4:00							4	3	7	42.9	0.1	1
1 時間計							29	13	42	31.0	0.8	2
4:00- 4:15							11	2	13	15.4	0.2	1
4:15- 4:30							8	2	10	20.0	0.2	0
4:30- 4:45							12	2	14	14.3	0.3	1
4:45- 5:00							19	2	21	9.5	0.4	2
1 時間計							50	8	58	13.8	1.1	4
5:00- 5:15							20	5	25	20.0	0.5	4
5:15- 5:30							20	4	24	16.7	0.4	1
5:30- 5:45							21	4	25	16.0	0.5	3
5:45- 6:00							23	5	28	17.9	0.5	1
1 時間計							84	18	102	17.6	1.9	9

方向別自動車交通量調査表

調査地点 : 地域社会2 目黒交番前

調査年月日 : 令和元年 5月11日(土) 天候:晴れ時々曇り



方向	種別	C 合計 (8+ 9+10+11)					C 合計 (8+ 9+10+11)					
		小型車 (台)	大型車 (台)	合計 (台)	大型車 混入率 (%)	時 間 係 数 (%)	二輪車 (台)	小型車 (台)	大型車 (台)	合計 (台)	大型車 混入率 (%)	時 間 係 数 (%)
6:00-6:15							32	4	36	11.1	0.7	3
6:15-6:30							31	4	35	11.4	0.6	1
6:30-6:45							45	4	49	8.2	0.9	5
6:45-7:00							51	2	53	3.8	1.0	4
1時間計							159	14	173	8.1	3.2	13
7:00-7:15							62	7	69	10.1	1.3	7
7:15-7:30							66	4	70	5.7	1.3	3
7:30-7:45							73	6	79	7.6	1.5	9
7:45-8:00							62	6	68	8.8	1.3	6
1時間計							263	23	286	8.0	5.3	25
8:00-8:15							85	1	86	1.2	1.6	13
8:15-8:30							77	10	87	11.5	1.6	4
8:30-8:45							87	4	91	4.4	1.7	7
8:45-9:00							91	5	96	5.2	1.8	7
1時間計							340	20	360	5.6	6.7	31
9:00-9:15							74	4	78	5.1	1.4	6
9:15-9:30							62	6	68	8.8	1.3	6
9:30-9:45							91	1	92	1.1	1.7	14
9:45-10:00							79	1	80	1.3	1.5	4
1時間計							306	12	318	3.8	5.9	30
10:00-10:15							89	5	94	5.3	1.7	2
10:15-10:30							97	2	99	2.0	1.8	6
10:30-10:45							75	5	80	6.3	1.5	3
10:45-11:00							70	3	73	4.1	1.4	12
1時間計							331	15	346	4.3	6.4	23
11:00-11:15							96	1	97	1.0	1.8	4
11:15-11:30							87	3	90	3.3	1.7	11
11:30-11:45							77	4	81	4.9	1.5	4
11:45-12:00							92	2	94	2.1	1.7	6
1時間計							352	10	362	2.8	6.7	25
12:00-12:15							68	6	74	8.1	1.4	5
12:15-12:30							75	2	77	2.6	1.4	2
12:30-12:45							91	4	95	4.2	1.8	6
12:45-13:00							88	2	90	2.2	1.7	5
1時間計							322	14	336	4.2	6.2	18
13:00-13:15							93	3	96	3.1	1.8	3
13:15-13:30							70	1	71	1.4	1.3	4
13:30-13:45							103	4	107	3.7	2.0	6
13:45-14:00							77	4	81	4.9	1.5	4
1時間計							343	12	355	3.4	6.6	17

方向別自動車交通量調査表

調査地点：地域社会2 目黒交番前

調査年月日：令和元年 5月11日(土) 天候：晴れ時々曇り



方向 種別 時間帯							C 合計 (8+ 9+10+11)					
	小型車 (台)	大型車 (台)	合計 (台)	大型車 混入率 (%)	時間 係数 (%)	二輪車 (台)	小型車 (台)	大型車 (台)	合計 (台)	大型車 混入率 (%)	時間 係数 (%)	二輪車 (台)
14:00-14:15							83	4	87	4.6	1.6	4
14:15-14:30							79	3	82	3.7	1.5	3
14:30-14:45							90	1	91	1.1	1.7	8
14:45-15:00							100	3	103	2.9	1.9	6
1時間計							352	11	363	3.0	6.7	21
15:00-15:15							76	2	78	2.6	1.4	6
15:15-15:30							85	2	87	2.3	1.6	8
15:30-15:45							78	3	81	3.7	1.5	6
15:45-16:00							96	5	101	5.0	1.9	7
1時間計							335	12	347	3.5	6.4	27
16:00-16:15							97	1	98	1.0	1.8	4
16:15-16:30							79	1	80	1.3	1.5	6
16:30-16:45							110	3	113	2.7	2.1	8
16:45-17:00							95	2	97	2.1	1.8	10
1時間計							381	7	388	1.8	7.2	28
17:00-17:15							88	3	91	3.3	1.7	8
17:15-17:30							84	7	91	7.7	1.7	7
17:30-17:45							61	4	65	6.2	1.2	4
17:45-18:00							100	3	103	2.9	1.9	7
1時間計							333	17	350	4.9	6.5	26
18:00-18:15							81	1	82	1.2	1.5	4
18:15-18:30							53	4	57	7.0	1.1	2
18:30-18:45							62	4	66	6.1	1.2	4
18:45-19:00							61	2	63	3.2	1.2	4
1時間計							257	11	268	4.1	5.0	14
19:00-19:15							65	2	67	3.0	1.2	4
19:15-19:30							62	3	65	4.6	1.2	4
19:30-19:45							53	1	54	1.9	1.0	2
19:45-20:00							47	1	48	2.1	0.9	1
1時間計							227	7	234	3.0	4.3	11
20:00-20:15							47	3	50	6.0	0.9	3
20:15-20:30							48	3	51	5.9	0.9	3
20:30-20:45							36	1	37	2.7	0.7	0
20:45-21:00							51	1	52	1.9	1.0	5
1時間計							182	8	190	4.2	3.5	11
21:00-21:15							47	0	47	0.0	0.9	2
21:15-21:30							39	2	41	4.9	0.8	4
21:30-21:45							60	1	61	1.6	1.1	3
21:45-22:00							32	1	33	3.0	0.6	1
1時間計							178	4	182	2.2	3.4	10
昼12時間計							3915	164	4079	4.0	75.5	285
夜12時間計							1206	115	1321	8.7	24.5	79
全時間合計							5121	279	5400	5.2	100.0	364
昼夜率							1.31	1.70	1.32	-	-	1.28

方向別自動車交通量調査表

調査地点 : 地域社会2 目黒交番前

調査年月日 : 令和元年 5月11日(土) 天候:晴れ時々曇り



方向 種別 時間帯	12						13					
	小型車 (台)	大型車 (台)	合計 (台)	大型車 混入率 (%)	時間 係数 (%)	二輪車 (台)	小型車 (台)	大型車 (台)	合計 (台)	大型車 混入率 (%)	時間 係数 (%)	二輪車 (台)
22:00-22:15	10	3	13	23.1	1.2	1	56	14	70	20.0	0.8	4
22:15-22:30	10	3	13	23.1	1.2	0	68	9	77	11.7	0.9	3
22:30-22:45	11	1	12	8.3	1.1	2	55	11	66	16.7	0.7	5
22:45-23:00	3	1	4	25.0	0.4	0	60	18	78	23.1	0.9	2
1時間計	34	8	42	19.0	3.8	3	239	52	291	17.9	3.2	14
23:00-23:15	9	4	13	30.8	1.2	2	39	8	47	17.0	0.5	4
23:15-23:30	5	0	5	0.0	0.5	0	33	11	44	25.0	0.5	1
23:30-23:45	5	0	5	0.0	0.5	2	40	14	54	25.9	0.6	2
23:45-24:00	7	1	8	12.5	0.7	0	35	16	51	31.4	0.6	4
1時間計	26	5	31	16.1	2.8	4	147	49	196	25.0	2.2	11
0:00- 0:15	3	0	3	0.0	0.3	1	29	8	37	21.6	0.4	2
0:15- 0:30	8	0	8	0.0	0.7	1	31	8	39	20.5	0.4	2
0:30- 0:45	10	2	12	16.7	1.1	1	42	12	54	22.2	0.6	6
0:45- 1:00	1	0	1	0.0	0.1	0	20	15	35	42.9	0.4	0
1時間計	22	2	24	8.3	2.2	3	122	43	165	26.1	1.8	10
1:00- 1:15	6	0	6	0.0	0.5	0	24	15	39	38.5	0.4	3
1:15- 1:30	3	0	3	0.0	0.3	0	14	14	28	50.0	0.3	0
1:30- 1:45	5	3	8	37.5	0.7	0	16	9	25	36.0	0.3	0
1:45- 2:00	1	0	1	0.0	0.1	1	18	5	23	21.7	0.3	2
1時間計	15	3	18	16.7	1.6	1	72	43	115	37.4	1.3	5
2:00- 2:15	2	0	2	0.0	0.2	1	19	15	34	44.1	0.4	1
2:15- 2:30	4	0	4	0.0	0.4	0	16	14	30	46.7	0.3	1
2:30- 2:45	4	2	6	33.3	0.5	2	18	8	26	30.8	0.3	3
2:45- 3:00	1	0	1	0.0	0.1	0	19	9	28	32.1	0.3	0
1時間計	11	2	13	15.4	1.2	3	72	46	118	39.0	1.3	5
3:00- 3:15	0	0	0	0.0	0.0	2	19	12	31	38.7	0.3	0
3:15- 3:30	3	0	3	0.0	0.3	2	16	18	34	52.9	0.4	0
3:30- 3:45	4	1	5	20.0	0.5	0	14	10	24	41.7	0.3	0
3:45- 4:00	3	1	4	25.0	0.4	0	21	8	29	27.6	0.3	1
1時間計	10	2	12	16.7	1.1	4	70	48	118	40.7	1.3	1
4:00- 4:15	1	0	1	0.0	0.1	1	13	7	20	35.0	0.2	3
4:15- 4:30	4	0	4	0.0	0.4	0	25	7	32	21.9	0.4	1
4:30- 4:45	5	1	6	16.7	0.5	0	17	8	25	32.0	0.3	2
4:45- 5:00	2	1	3	33.3	0.3	3	10	8	18	44.4	0.2	3
1時間計	12	2	14	14.3	1.3	4	65	30	95	31.6	1.1	9
5:00- 5:15	3	0	3	0.0	0.3	0	35	9	44	20.5	0.5	3
5:15- 5:30	6	2	8	25.0	0.7	1	25	9	34	26.5	0.4	4
5:30- 5:45	8	0	8	0.0	0.7	0	27	17	44	38.6	0.5	3
5:45- 6:00	6	0	6	0.0	0.5	0	35	11	46	23.9	0.5	5
1時間計	23	2	25	8.0	2.3	1	122	46	168	27.4	1.9	15

方向別自動車交通量調査表

調査地点：地域社会2 目黒交番前

調査年月日：令和元年 5月11日(土) 天候：晴れ時々曇り



方向 時間帯	12						13					
	小型車 (台)	大型車 (台)	合計 (台)	大型車 混入率 (%)	時間 係数 (%)	二輪車 (台)	小型車 (台)	大型車 (台)	合計 (台)	大型車 混入率 (%)	時間 係数 (%)	二輪車 (台)
6:00-6:15	6	0	6	0.0	0.5	0	49	15	64	23.4	0.7	0
6:15-6:30	9	1	10	10.0	0.9	1	46	10	56	17.9	0.6	3
6:30-6:45	8	1	9	11.1	0.8	1	70	17	87	19.5	1.0	6
6:45-7:00	6	2	8	25.0	0.7	0	61	15	76	19.7	0.8	5
1時間計	29	4	33	12.1	3.0	2	226	57	283	20.1	3.1	14
7:00-7:15	14	3	17	17.6	1.5	1	76	16	92	17.4	1.0	12
7:15-7:30	11	2	13	15.4	1.2	1	71	16	87	18.4	1.0	8
7:30-7:45	8	0	8	0.0	0.7	0	72	18	90	20.0	1.0	4
7:45-8:00	12	1	13	7.7	1.2	1	81	15	96	15.6	1.1	2
1時間計	45	6	51	11.8	4.6	3	300	65	365	17.8	4.1	26
8:00-8:15	10	0	10	0.0	0.9	1	122	9	131	6.9	1.5	8
8:15-8:30	15	1	16	6.3	1.5	1	94	16	110	14.5	1.2	15
8:30-8:45	11	0	11	0.0	1.0	3	100	15	115	13.0	1.3	6
8:45-9:00	15	2	17	11.8	1.5	0	133	12	145	8.3	1.6	11
1時間計	51	3	54	5.6	4.9	5	449	52	501	10.4	5.6	40
9:00-9:15	23	2	25	8.0	2.3	0	112	14	126	11.1	1.4	7
9:15-9:30	10	0	10	0.0	0.9	1	116	11	127	8.7	1.4	16
9:30-9:45	6	0	6	0.0	0.5	0	130	16	146	11.0	1.6	5
9:45-10:00	19	1	20	5.0	1.8	2	143	18	161	11.2	1.8	6
1時間計	58	3	61	4.9	5.6	3	501	59	560	10.5	6.2	34
10:00-10:15	14	2	16	12.5	1.5	0	141	20	161	12.4	1.8	9
10:15-10:30	13	0	13	0.0	1.2	1	141	17	158	10.8	1.8	5
10:30-10:45	22	1	23	4.3	2.1	1	154	16	170	9.4	1.9	9
10:45-11:00	20	1	21	4.8	1.9	1	150	18	168	10.7	1.9	9
1時間計	69	4	73	5.5	6.6	3	586	71	657	10.8	7.3	32
11:00-11:15	23	0	23	0.0	2.1	2	124	16	140	11.4	1.6	15
11:15-11:30	14	1	15	6.7	1.4	2	129	13	142	9.2	1.6	14
11:30-11:45	12	0	12	0.0	1.1	0	126	13	139	9.4	1.5	8
11:45-12:00	13	1	14	7.1	1.3	1	130	15	145	10.3	1.6	5
1時間計	62	2	64	3.1	5.8	5	509	57	566	10.1	6.3	42
12:00-12:15	27	3	30	10.0	2.7	2	136	10	146	6.8	1.6	10
12:15-12:30	16	1	17	5.9	1.5	1	102	13	115	11.3	1.3	4
12:30-12:45	11	3	14	21.4	1.3	2	105	19	124	15.3	1.4	6
12:45-13:00	14	2	16	12.5	1.5	1	112	9	121	7.4	1.3	7
1時間計	68	9	77	11.7	7.0	6	455	51	506	10.1	5.6	27
13:00-13:15	12	0	12	0.0	1.1	1	106	9	115	7.8	1.3	8
13:15-13:30	10	1	11	9.1	1.0	1	114	17	131	13.0	1.5	8
13:30-13:45	7	1	8	12.5	0.7	1	103	16	119	13.4	1.3	9
13:45-14:00	18	1	19	5.3	1.7	1	134	9	143	6.3	1.6	12
1時間計	47	3	50	6.0	4.6	4	457	51	508	10.0	5.6	37

方向別自動車交通量調査表

調査地点 : 地域社会2 目黒交番前

調査年月日 : 令和元年 5月11日(土) 天候:晴れ時々曇り



方向 種別 時間帯	12						13					
	小型車 (台)	大型車 (台)	合計 (台)	大型車 混入率 (%)	時間 係数 (%)	二輪車 (台)	小型車 (台)	大型車 (台)	合計 (台)	大型車 混入率 (%)	時間 係数 (%)	二輪車 (台)
14:00-14:15	25	0	25	0.0	2.3	3	132	15	147	10.2	1.6	4
14:15-14:30	16	1	17	5.9	1.5	1	113	8	121	6.6	1.3	9
14:30-14:45	20	0	20	0.0	1.8	3	124	14	138	10.1	1.5	6
14:45-15:00	12	2	14	14.3	1.3	2	122	11	133	8.3	1.5	1
1時間計	73	3	76	3.9	6.9	9	491	48	539	8.9	6.0	20
15:00-15:15	14	1	15	6.7	1.4	3	121	7	128	5.5	1.4	4
15:15-15:30	21	1	22	4.5	2.0	1	121	18	139	12.9	1.5	7
15:30-15:45	19	0	19	0.0	1.7	3	124	13	137	9.5	1.5	5
15:45-16:00	28	0	28	0.0	2.6	3	119	16	135	11.9	1.5	3
1時間計	82	2	84	2.4	7.7	10	485	54	539	10.0	6.0	19
16:00-16:15	9	1	10	10.0	0.9	1	131	10	141	7.1	1.6	6
16:15-16:30	14	1	15	6.7	1.4	1	127	19	146	13.0	1.6	2
16:30-16:45	20	1	21	4.8	1.9	2	125	16	141	11.3	1.6	10
16:45-17:00	14	2	16	12.5	1.5	3	139	13	152	8.6	1.7	6
1時間計	57	5	62	8.1	5.6	7	522	58	580	10.0	6.4	24
17:00-17:15	14	0	14	0.0	1.3	3	133	17	150	11.3	1.7	7
17:15-17:30	16	0	16	0.0	1.5	0	116	11	127	8.7	1.4	6
17:30-17:45	11	1	12	8.3	1.1	1	143	11	154	7.1	1.7	7
17:45-18:00	9	0	9	0.0	0.8	1	100	5	105	4.8	1.2	7
1時間計	50	1	51	2.0	4.6	5	492	44	536	8.2	5.9	27
18:00-18:15	16	0	16	0.0	1.5	1	115	10	125	8.0	1.4	9
18:15-18:30	13	0	13	0.0	1.2	0	103	13	116	11.2	1.3	4
18:30-18:45	17	0	17	0.0	1.5	2	134	21	155	13.5	1.7	5
18:45-19:00	10	1	11	9.1	1.0	0	96	16	112	14.3	1.2	4
1時間計	56	1	57	1.8	5.2	3	448	60	508	11.8	5.6	22
19:00-19:15	11	0	11	0.0	1.0	0	73	14	87	16.1	1.0	8
19:15-19:30	15	0	15	0.0	1.4	0	91	17	108	15.7	1.2	3
19:30-19:45	10	1	11	9.1	1.0	0	69	15	84	17.9	0.9	5
19:45-20:00	13	0	13	0.0	1.2	2	65	10	75	13.3	0.8	10
1時間計	49	1	50	2.0	4.6	2	298	56	354	15.8	3.9	26
20:00-20:15	6	0	6	0.0	0.5	1	84	15	99	15.2	1.1	6
20:15-20:30	10	0	10	0.0	0.9	3	64	14	78	17.9	0.9	2
20:30-20:45	9	1	10	10.0	0.9	2	75	20	95	21.1	1.1	4
20:45-21:00	9	0	9	0.0	0.8	0	64	14	78	17.9	0.9	3
1時間計	34	1	35	2.9	3.2	6	287	63	350	18.0	3.9	15
21:00-21:15	9	1	10	10.0	0.9	0	89	18	107	16.8	1.2	3
21:15-21:30	11	1	12	8.3	1.1	2	95	17	112	15.2	1.2	7
21:30-21:45	10	2	12	16.7	1.1	1	68	19	87	21.8	1.0	4
21:45-22:00	5	2	7	28.6	0.6	2	65	20	85	23.5	0.9	2
1時間計	35	6	41	14.6	3.7	5	317	74	391	18.9	4.3	16
昼12時間計	718	42	760	5.5	69.2	63	5695	670	6365	10.5	70.7	350
夜12時間計	300	38	338	11.2	30.8	38	2037	607	2644	23.0	29.3	141
全時間合計	1018	80	1098	7.3	100.0	101	7732	1277	9009	14.2	100.0	491
昼夜率	1.42	1.90	1.44	-	-	1.60	1.36	1.91	1.42	-	-	1.40

方向別自動車交通量調査表

調査地点 : 地域社会2 目黒交番前

調査年月日 : 令和元年 5月11日(土) 天候:晴れ時々曇り

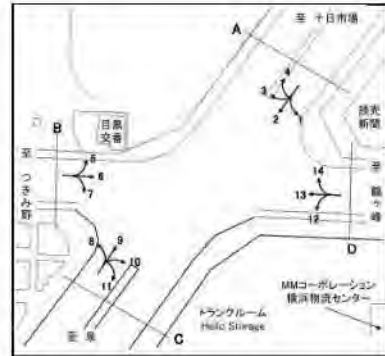

方向 種別 時間帯	14						D 合計 (12+13+14)					
	小型車 (台)	大型車 (台)	合計 (台)	大型車 混入率 (%)	時間 係数 (%)	二輪車 (台)	小型車 (台)	大型車 (台)	合計 (台)	大型車 混入率 (%)	時間 係数 (%)	二輪車 (台)
22:00-22:15	2	0	2	0.0	0.8	1	68	17	85	20.0	0.8	6
22:15-22:30	2	2	4	50.0	1.6	0	80	14	94	14.9	0.9	3
22:30-22:45	2	0	2	0.0	0.8	0	68	12	80	15.0	0.8	7
22:45-23:00	1	0	1	0.0	0.4	0	64	19	83	22.9	0.8	2
1時間計	7	2	9	22.2	3.5	1	280	62	342	18.1	3.3	18
23:00-23:15	1	0	1	0.0	0.4	0	49	12	61	19.7	0.6	6
23:15-23:30	0	0	0	0.0	0.0	0	38	11	49	22.4	0.5	1
23:30-23:45	1	1	2	50.0	0.8	0	46	15	61	24.6	0.6	4
23:45-24:00	3	0	3	0.0	1.2	0	45	17	62	27.4	0.6	4
1時間計	5	1	6	16.7	2.4	0	178	55	233	23.6	2.2	15
0:00- 0:15	3	0	3	0.0	1.2	0	35	8	43	18.6	0.4	3
0:15- 0:30	3	0	3	0.0	1.2	0	42	8	50	16.0	0.5	3
0:30- 0:45	0	0	0	0.0	0.0	0	52	14	66	21.2	0.6	7
0:45- 1:00	0	0	0	0.0	0.0	0	21	15	36	41.7	0.3	0
1時間計	6	0	6	0.0	2.4	0	150	45	195	23.1	1.9	13
1:00- 1:15	1	0	1	0.0	0.4	0	31	15	46	32.6	0.4	3
1:15- 1:30	1	0	1	0.0	0.4	0	18	14	32	43.8	0.3	0
1:30- 1:45	1	1	2	50.0	0.8	0	22	13	35	37.1	0.3	0
1:45- 2:00	2	0	2	0.0	0.8	0	21	5	26	19.2	0.3	3
1時間計	5	1	6	16.7	2.4	0	92	47	139	33.8	1.3	6
2:00- 2:15	0	0	0	0.0	0.0	0	21	15	36	41.7	0.3	2
2:15- 2:30	0	0	0	0.0	0.0	0	20	14	34	41.2	0.3	1
2:30- 2:45	1	0	1	0.0	0.4	0	23	10	33	30.3	0.3	5
2:45- 3:00	0	0	0	0.0	0.0	0	20	9	29	31.0	0.3	0
1時間計	1	0	1	0.0	0.4	0	84	48	132	36.4	1.3	8
3:00- 3:15	0	0	0	0.0	0.0	0	19	12	31	38.7	0.3	2
3:15- 3:30	1	0	1	0.0	0.4	0	20	18	38	47.4	0.4	2
3:30- 3:45	0	0	0	0.0	0.0	0	18	11	29	37.9	0.3	0
3:45- 4:00	0	0	0	0.0	0.0	0	24	9	33	27.3	0.3	1
1時間計	1	0	1	0.0	0.4	0	81	50	131	38.2	1.3	5
4:00- 4:15	0	0	0	0.0	0.0	0	14	7	21	33.3	0.2	4
4:15- 4:30	0	0	0	0.0	0.0	0	29	7	36	19.4	0.3	1
4:30- 4:45	0	0	0	0.0	0.0	0	22	9	31	29.0	0.3	2
4:45- 5:00	1	1	2	50.0	0.8	1	13	10	23	43.5	0.2	7
1時間計	1	1	2	50.0	0.8	1	78	33	111	29.7	1.1	14
5:00- 5:15	0	0	0	0.0	0.0	0	38	9	47	19.1	0.5	3
5:15- 5:30	0	0	0	0.0	0.0	0	31	11	42	26.2	0.4	5
5:30- 5:45	2	0	2	0.0	0.8	0	37	17	54	31.5	0.5	3
5:45- 6:00	1	1	2	50.0	0.8	0	42	12	54	22.2	0.5	5
1時間計	3	1	4	25.0	1.6	0	148	49	197	24.9	1.9	16

方向別自動車交通量調査表

調査地点：地域社会2 目黒交番前

調査年月日：令和元年 5月11日(土) 天候：晴れ時々曇り

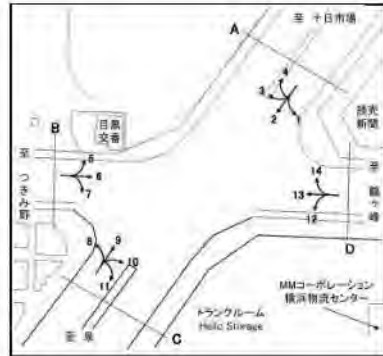

時間帯	14						D 合計 (12+13+14)					
	小型車 (台)	大型車 (台)	合計 (台)	大型車 混入率 (%)	時間 係数 (%)	二輪車 (台)	小型車 (台)	大型車 (台)	合計 (台)	大型車 混入率 (%)	時間 係数 (%)	二輪車 (台)
6:00-6:15	0	0	0	0.0	0.0	0	55	15	70	21.4	0.7	0
6:15-6:30	2	1	3	33.3	1.2	0	57	12	69	17.4	0.7	4
6:30-6:45	1	0	1	0.0	0.4	0	79	18	97	18.6	0.9	7
6:45-7:00	0	0	0	0.0	0.0	0	67	17	84	20.2	0.8	5
1時間計	3	1	4	25.0	1.6	0	258	62	320	19.4	3.1	16
7:00-7:15	6	0	6	0.0	2.4	0	96	19	115	16.5	1.1	13
7:15-7:30	3	1	4	25.0	1.6	0	85	19	104	18.3	1.0	9
7:30-7:45	0	0	0	0.0	0.0	0	80	18	98	18.4	0.9	4
7:45-8:00	4	0	4	0.0	1.6	0	97	16	113	14.2	1.1	3
1時間計	13	1	14	7.1	5.5	0	358	72	430	16.7	4.1	29
8:00-8:15	0	1	1	100.0	0.4	0	132	10	142	7.0	1.4	9
8:15-8:30	1	1	2	50.0	0.8	1	110	18	128	14.1	1.2	17
8:30-8:45	5	0	5	0.0	2.0	0	116	15	131	11.5	1.3	9
8:45-9:00	1	0	1	0.0	0.4	0	149	14	163	8.6	1.6	11
1時間計	7	2	9	22.2	3.5	1	507	57	564	10.1	5.4	46
9:00-9:15	4	0	4	0.0	1.6	0	139	16	155	10.3	1.5	7
9:15-9:30	7	0	7	0.0	2.7	0	133	11	144	7.6	1.4	17
9:30-9:45	5	0	5	0.0	2.0	0	141	16	157	10.2	1.5	5
9:45-10:00	3	0	3	0.0	1.2	0	165	19	184	10.3	1.8	8
1時間計	19	0	19	0.0	7.5	0	578	62	640	9.7	6.2	37
10:00-10:15	3	0	3	0.0	1.2	0	158	22	180	12.2	1.7	9
10:15-10:30	4	1	5	20.0	2.0	0	158	18	176	10.2	1.7	6
10:30-10:45	3	0	3	0.0	1.2	0	179	17	196	8.7	1.9	10
10:45-11:00	1	0	1	0.0	0.4	0	171	19	190	10.0	1.8	10
1時間計	11	1	12	8.3	4.7	0	666	76	742	10.2	7.2	35
11:00-11:15	0	2	2	100.0	0.8	0	147	18	165	10.9	1.6	17
11:15-11:30	3	0	3	0.0	1.2	0	146	14	160	8.8	1.5	16
11:30-11:45	6	0	6	0.0	2.4	1	144	13	157	8.3	1.5	9
11:45-12:00	1	0	1	0.0	0.4	0	144	16	160	10.0	1.5	6
1時間計	10	2	12	16.7	4.7	1	581	61	642	9.5	6.2	48
12:00-12:15	1	0	1	0.0	0.4	1	164	13	177	7.3	1.7	13
12:15-12:30	3	0	3	0.0	1.2	0	121	14	135	10.4	1.3	5
12:30-12:45	4	2	6	33.3	2.4	0	120	24	144	16.7	1.4	8
12:45-13:00	6	0	6	0.0	2.4	1	132	11	143	7.7	1.4	9
1時間計	14	2	16	12.5	6.3	2	537	62	599	10.4	5.8	35
13:00-13:15	4	0	4	0.0	1.6	1	122	9	131	6.9	1.3	10
13:15-13:30	9	0	9	0.0	3.5	0	133	18	151	11.9	1.5	9
13:30-13:45	4	0	4	0.0	1.6	0	114	17	131	13.0	1.3	10
13:45-14:00	7	0	7	0.0	2.7	0	159	10	169	5.9	1.6	13
1時間計	24	0	24	0.0	9.4	1	528	54	582	9.3	5.6	42

方向別自動車交通量調査表

調査地点 : 地域社会2 目黒交番前

調査年月日 : 令和元年 5月11日(土) 天候:晴れ時々曇り



方向 種別 時間帯	14						D 合計 (12+13+14)					
	小型車 (台)	大型車 (台)	合計 (台)	大型車 混入率 (%)	時間 係数 (%)	二輪車 (台)	小型車 (台)	大型車 (台)	合計 (台)	大型車 混入率 (%)	時間 係数 (%)	二輪車 (台)
14:00-14:15	7	0	7	0.0	2.7	1	164	15	179	8.4	1.7	8
14:15-14:30	1	0	1	0.0	0.4	0	130	9	139	6.5	1.3	10
14:30-14:45	6	1	7	14.3	2.7	0	150	15	165	9.1	1.6	9
14:45-15:00	4	0	4	0.0	1.6	1	138	13	151	8.6	1.5	4
1時間計	18	1	19	5.3	7.5	2	582	52	634	8.2	6.1	31
15:00-15:15	4	2	6	33.3	2.4	0	139	10	149	6.7	1.4	7
15:15-15:30	4	0	4	0.0	1.6	0	146	19	165	11.5	1.6	8
15:30-15:45	5	0	5	0.0	2.0	0	148	13	161	8.1	1.6	8
15:45-16:00	3	0	3	0.0	1.2	0	150	16	166	9.6	1.6	6
1時間計	16	2	18	11.1	7.1	0	583	58	641	9.0	6.2	29
16:00-16:15	3	0	3	0.0	1.2	0	143	11	154	7.1	1.5	7
16:15-16:30	2	0	2	0.0	0.8	0	143	20	163	12.3	1.6	3
16:30-16:45	5	0	5	0.0	2.0	0	150	17	167	10.2	1.6	12
16:45-17:00	7	0	7	0.0	2.7	0	160	15	175	8.6	1.7	9
1時間計	17	0	17	0.0	6.7	0	596	63	659	9.6	6.4	31
17:00-17:15	4	0	4	0.0	1.6	2	151	17	168	10.1	1.6	12
17:15-17:30	5	0	5	0.0	2.0	0	137	11	148	7.4	1.4	6
17:30-17:45	5	1	6	16.7	2.4	0	159	13	172	7.6	1.7	8
17:45-18:00	2	2	4	50.0	1.6	0	111	7	118	5.9	1.1	8
1時間計	16	3	19	15.8	7.5	2	558	48	606	7.9	5.8	34
18:00-18:15	2	3	5	60.0	2.0	0	133	13	146	8.9	1.4	10
18:15-18:30	3	0	3	0.0	1.2	0	119	13	132	9.8	1.3	4
18:30-18:45	2	0	2	0.0	0.8	0	153	21	174	12.1	1.7	7
18:45-19:00	2	0	2	0.0	0.8	0	108	17	125	13.6	1.2	4
1時間計	9	3	12	25.0	4.7	0	513	64	577	11.1	5.6	25
19:00-19:15	3	0	3	0.0	1.2	0	87	14	101	13.9	1.0	8
19:15-19:30	2	0	2	0.0	0.8	0	108	17	125	13.6	1.2	3
19:30-19:45	1	0	1	0.0	0.4	0	80	16	96	16.7	0.9	5
19:45-20:00	1	0	1	0.0	0.4	0	79	10	89	11.2	0.9	12
1時間計	7	0	7	0.0	2.7	0	354	57	411	13.9	4.0	28
20:00-20:15	1	0	1	0.0	0.4	0	91	15	106	14.2	1.0	7
20:15-20:30	5	0	5	0.0	2.0	0	79	14	93	15.1	0.9	5
20:30-20:45	1	0	1	0.0	0.4	0	85	21	106	19.8	1.0	6
20:45-21:00	3	0	3	0.0	1.2	0	76	14	90	15.6	0.9	3
1時間計	10	0	10	0.0	3.9	0	331	64	395	16.2	3.8	21
21:00-21:15	4	0	4	0.0	1.6	0	102	19	121	15.7	1.2	3
21:15-21:30	1	0	1	0.0	0.4	0	107	18	125	14.4	1.2	9
21:30-21:45	2	1	3	33.3	1.2	0	80	22	102	21.6	1.0	5
21:45-22:00	0	0	0	0.0	0.0	0	70	22	92	23.9	0.9	4
1時間計	7	1	8	12.5	3.1	0	359	81	440	18.4	4.2	21
昼12時間計	174	17	191	8.9	74.9	9	6587	729	7316	10.0	70.6	422
夜12時間計	56	8	64	12.5	25.1	2	2393	653	3046	21.4	29.4	181
全時間合計	230	25	255	9.8	100.0	11	8980	1382	10362	13.3	100.0	603
昼夜率	1.32	1.47	1.34	-	-	1.22	1.36	1.90	1.42	-	-	1.43

方向別自動車交通量調査表

調査地点 : 地域社会3 上川井1C

調査年月日 : 令和元年 5月11日(土) 天候:晴れ時々曇り

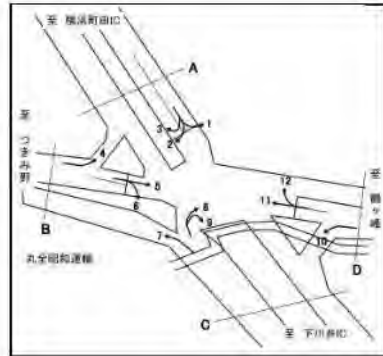

方向 種別 時間帯	1						2					
	小型車 (台)	大型車 (台)	合計 (台)	大型車 混入率 (%)	時間 係数 (%)	二輪車 (台)	小型車 (台)	大型車 (台)	合計 (台)	大型車 混入率 (%)	時間 係数 (%)	二輪車 (台)
22:00-22:15	6	0	6	0.0	0.4	2	1	2	3	66.7	1.6	0
22:15-22:30	7	1	8	12.5	0.6	1	4	0	4	0.0	2.2	0
22:30-22:45	9	1	10	10.0	0.7	1	0	0	0	0.0	0.0	0
22:45-23:00	8	0	8	0.0	0.6	2	1	0	1	0.0	0.5	0
1時間計	30	2	32	6.3	2.2	6	6	2	8	25.0	4.4	0
23:00-23:15	4	0	4	0.0	0.3	1	1	0	1	0.0	0.5	1
23:15-23:30	5	0	5	0.0	0.4	1	2	0	2	0.0	1.1	0
23:30-23:45	8	0	8	0.0	0.6	0	3	0	3	0.0	1.6	0
23:45-24:00	2	1	3	33.3	0.2	0	2	1	3	33.3	1.6	0
1時間計	19	1	20	5.0	1.4	2	8	1	9	11.1	4.9	1
0:00-0:15	17	0	17	0.0	1.2	1	1	0	1	0.0	0.5	0
0:15-0:30	5	0	5	0.0	0.4	0	1	0	1	0.0	0.5	1
0:30-0:45	4	0	4	0.0	0.3	0	0	0	0	0.0	0.0	0
0:45-1:00	5	1	6	16.7	0.4	1	2	2	4	50.0	2.2	0
1時間計	31	1	32	3.1	2.2	2	4	2	6	33.3	3.3	1
1:00-1:15	3	0	3	0.0	0.2	2	0	0	0	0.0	0.0	0
1:15-1:30	3	0	3	0.0	0.2	0	1	1	2	50.0	1.1	0
1:30-1:45	1	0	1	0.0	0.1	0	2	1	3	33.3	1.6	0
1:45-2:00	6	0	6	0.0	0.4	1	1	3	4	75.0	2.2	0
1時間計	13	0	13	0.0	0.9	3	4	5	9	55.6	4.9	0
2:00-2:15	1	1	2	50.0	0.1	0	1	0	1	0.0	0.5	0
2:15-2:30	3	0	3	0.0	0.2	0	2	0	2	0.0	1.1	0
2:30-2:45	3	0	3	0.0	0.2	0	4	0	4	0.0	2.2	1
2:45-3:00	2	1	3	33.3	0.2	0	4	1	5	20.0	2.7	0
1時間計	9	2	11	18.2	0.8	0	11	1	12	8.3	6.6	1
3:00-3:15	0	0	0	0.0	0.0	1	0	0	0	0.0	0.0	0
3:15-3:30	5	0	5	0.0	0.4	0	1	0	1	0.0	0.5	0
3:30-3:45	3	1	4	25.0	0.3	1	1	0	1	0.0	0.5	0
3:45-4:00	1	0	1	0.0	0.1	0	1	0	1	0.0	0.5	0
1時間計	9	1	10	10.0	0.7	2	3	0	3	0.0	1.6	0
4:00-4:15	5	1	6	16.7	0.4	2	0	0	0	0.0	0.0	0
4:15-4:30	2	1	3	33.3	0.2	0	1	0	1	0.0	0.5	0
4:30-4:45	4	1	5	20.0	0.4	1	1	0	1	0.0	0.5	0
4:45-5:00	5	0	5	0.0	0.4	0	1	1	2	50.0	1.1	0
1時間計	16	3	19	15.8	1.3	3	3	1	4	25.0	2.2	0
5:00-5:15	7	1	8	12.5	0.6	1	0	0	0	0.0	0.0	0
5:15-5:30	2	1	3	33.3	0.2	2	0	0	0	0.0	0.0	0
5:30-5:45	5	0	5	0.0	0.4	3	3	1	4	25.0	2.2	0
5:45-6:00	3	1	4	25.0	0.3	0	1	1	2	50.0	1.1	0
1時間計	17	3	20	15.0	1.4	6	4	2	6	33.3	3.3	0

方向別自動車交通量調査表

調査地点 : 地域社会3 上川井1C

調査年月日 : 令和元年 5月11日(土) 天候:晴れ時々曇り

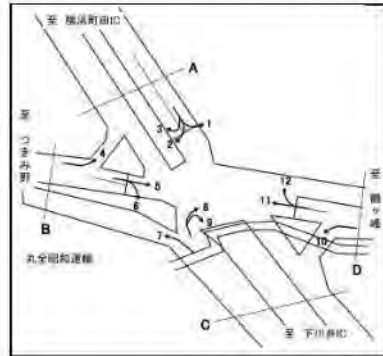

方向 時間帯	1						2					
	種別 小型車 (台)	大型車 (台)	合計 (台)	大型車 混入率 (%)	時間 係数 (%)	二輪車 (台)	小型車 (台)	大型車 (台)	合計 (台)	大型車 混入率 (%)	時間 係数 (%)	二輪車 (台)
6:00-6:15	6	1	7	14.3	0.5	1	0	0	0	0.0	0.0	0
6:15-6:30	12	1	13	7.7	0.9	0	1	1	2	50.0	1.1	0
6:30-6:45	10	1	11	9.1	0.8	1	0	0	0	0.0	0.0	0
6:45-7:00	11	0	11	0.0	0.8	0	0	0	0	0.0	0.0	0
1時間計	39	3	42	7.1	2.9	2	1	1	2	50.0	1.1	0
7:00-7:15	19	0	19	0.0	1.3	4	0	0	0	0.0	0.0	0
7:15-7:30	18	0	18	0.0	1.3	2	1	0	1	0.0	0.5	0
7:30-7:45	31	1	32	3.1	2.2	2	0	0	0	0.0	0.0	0
7:45-8:00	10	2	12	16.7	0.8	2	2	0	2	0.0	1.1	0
1時間計	78	3	81	3.7	5.7	10	3	0	3	0.0	1.6	0
8:00-8:15	24	1	25	4.0	1.8	3	1	0	1	0.0	0.5	0
8:15-8:30	20	3	23	13.0	1.6	3	1	0	1	0.0	0.5	0
8:30-8:45	25	1	26	3.8	1.8	0	0	0	0	0.0	0.0	0
8:45-9:00	16	1	17	5.9	1.2	1	1	0	1	0.0	0.5	0
1時間計	85	6	91	6.6	6.4	7	3	0	3	0.0	1.6	0
9:00-9:15	15	1	16	6.3	1.1	3	0	0	0	0.0	0.0	0
9:15-9:30	20	6	26	23.1	1.8	4	2	0	2	0.0	1.1	0
9:30-9:45	27	3	30	10.0	2.1	2	0	0	0	0.0	0.0	0
9:45-10:00	17	1	18	5.6	1.3	5	2	0	2	0.0	1.1	0
1時間計	79	11	90	12.2	6.3	14	4	0	4	0.0	2.2	0
10:00-10:15	18	1	19	5.3	1.3	3	2	0	2	0.0	1.1	0
10:15-10:30	33	3	36	8.3	2.5	5	4	0	4	0.0	2.2	0
10:30-10:45	12	1	13	7.7	0.9	2	2	1	3	33.3	1.6	0
10:45-11:00	27	5	32	15.6	2.2	2	1	0	1	0.0	0.5	0
1時間計	90	10	100	10.0	7.0	12	9	1	10	10.0	5.5	0
11:00-11:15	16	2	18	11.1	1.3	3	1	0	1	0.0	0.5	0
11:15-11:30	25	1	26	3.8	1.8	4	2	0	2	0.0	1.1	0
11:30-11:45	20	1	21	4.8	1.5	5	3	0	3	0.0	1.6	0
11:45-12:00	9	1	10	10.0	0.7	1	1	0	1	0.0	0.5	0
1時間計	70	5	75	6.7	5.3	13	7	0	7	0.0	3.8	0
12:00-12:15	24	3	27	11.1	1.9	3	1	1	2	50.0	1.1	0
12:15-12:30	25	1	26	3.8	1.8	6	3	0	3	0.0	1.6	0
12:30-12:45	25	0	25	0.0	1.8	1	2	1	3	33.3	1.6	0
12:45-13:00	26	0	26	0.0	1.8	6	3	0	3	0.0	1.6	0
1時間計	100	4	104	3.8	7.3	16	9	2	11	18.2	6.0	0
13:00-13:15	22	3	25	12.0	1.8	7	3	0	3	0.0	1.6	0
13:15-13:30	17	1	18	5.6	1.3	1	1	1	2	50.0	1.1	0
13:30-13:45	28	1	29	3.4	2.0	3	3	0	3	0.0	1.6	1
13:45-14:00	17	1	18	5.6	1.3	6	2	1	3	33.3	1.6	0
1時間計	84	6	90	6.7	6.3	17	9	2	11	18.2	6.0	1

方向別自動車交通量調査表

調査地点 : 地域社会3 上川井1C

調査年月日 : 令和元年 5月11日(土) 天候:晴れ時々曇り

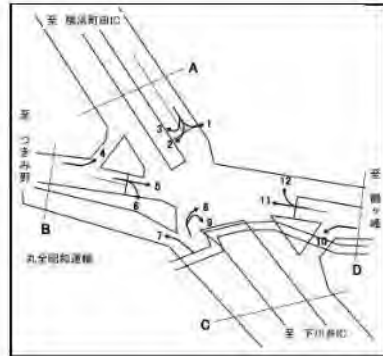

方向 種別 時間帯	1						2					
	小型車 (台)	大型車 (台)	合計 (台)	大型車 混入率 (%)	時間 係数 (%)	二輪車 (台)	小型車 (台)	大型車 (台)	合計 (台)	大型車 混入率 (%)	時間 係数 (%)	二輪車 (台)
14:00-14:15	21	0	21	0.0	1.5	1	5	0	5	0.0	2.7	1
14:15-14:30	17	3	20	15.0	1.4	5	3	0	3	0.0	1.6	0
14:30-14:45	25	2	27	7.4	1.9	2	3	1	4	25.0	2.2	0
14:45-15:00	34	0	34	0.0	2.4	3	2	0	2	0.0	1.1	0
1時間計	97	5	102	4.9	7.2	11	13	1	14	7.1	7.7	1
15:00-15:15	34	1	35	2.9	2.5	7	4	0	4	0.0	2.2	1
15:15-15:30	28	4	32	12.5	2.2	4	4	0	4	0.0	2.2	0
15:30-15:45	21	3	24	12.5	1.7	5	1	0	1	0.0	0.5	0
15:45-16:00	21	4	25	16.0	1.8	6	1	0	1	0.0	0.5	0
1時間計	104	12	116	10.3	8.1	22	10	0	10	0.0	5.5	1
16:00-16:15	17	4	21	19.0	1.5	1	2	0	2	0.0	1.1	0
16:15-16:30	13	0	13	0.0	0.9	2	0	0	0	0.0	0.0	0
16:30-16:45	20	2	22	9.1	1.5	4	1	0	1	0.0	0.5	0
16:45-17:00	16	1	17	5.9	1.2	7	1	2	3	66.7	1.6	0
1時間計	66	7	73	9.6	5.1	14	4	2	6	33.3	3.3	0
17:00-17:15	26	1	27	3.7	1.9	2	2	0	2	0.0	1.1	0
17:15-17:30	18	2	20	10.0	1.4	3	2	0	2	0.0	1.1	0
17:30-17:45	16	2	18	11.1	1.3	5	2	1	3	33.3	1.6	0
17:45-18:00	13	1	14	7.1	1.0	4	1	0	1	0.0	0.5	0
1時間計	73	6	79	7.6	5.5	14	7	1	8	12.5	4.4	0
18:00-18:15	18	0	18	0.0	1.3	2	1	0	1	0.0	0.5	0
18:15-18:30	15	1	16	6.3	1.1	3	0	1	1	100.0	0.5	0
18:30-18:45	11	0	11	0.0	0.8	1	5	1	6	16.7	3.3	0
18:45-19:00	24	0	24	0.0	1.7	1	3	0	3	0.0	1.6	0
1時間計	68	1	69	1.4	4.8	7	9	2	11	18.2	6.0	0
19:00-19:15	19	0	19	0.0	1.3	2	1	0	1	0.0	0.5	0
19:15-19:30	16	1	17	5.9	1.2	3	3	0	3	0.0	1.6	0
19:30-19:45	18	1	19	5.3	1.3	4	0	1	1	100.0	0.5	0
19:45-20:00	16	1	17	5.9	1.2	0	3	1	4	25.0	2.2	0
1時間計	69	3	72	4.2	5.1	9	7	2	9	22.2	4.9	0
20:00-20:15	12	0	12	0.0	0.8	0	1	1	2	50.0	1.1	0
20:15-20:30	17	1	18	5.6	1.3	0	2	2	4	50.0	2.2	0
20:30-20:45	11	0	11	0.0	0.8	3	1	1	2	50.0	1.1	0
20:45-21:00	9	0	9	0.0	0.6	4	2	0	2	0.0	1.1	0
1時間計	49	1	50	2.0	3.5	7	6	4	10	40.0	5.5	0
21:00-21:15	10	0	10	0.0	0.7	0	1	0	1	0.0	0.5	0
21:15-21:30	6	0	6	0.0	0.4	2	0	2	2	100.0	1.1	0
21:30-21:45	9	0	9	0.0	0.6	0	0	0	0	0.0	0.0	0
21:45-22:00	8	0	8	0.0	0.6	0	1	2	3	66.7	1.6	0
1時間計	33	0	33	0.0	2.3	2	2	4	6	66.7	3.3	0
昼12時間計	994	76	1070	7.1	75.1	157	87	11	98	11.2	53.8	3
夜12時間計	334	20	354	5.6	24.9	44	59	25	84	29.8	46.2	3
全時間合計	1328	96	1424	6.7	100.0	201	146	36	182	19.8	100.0	6
昼夜率	1.34	1.26	1.33	-	-	1.28	1.68	3.27	1.86	-	-	2.00

方向別自動車交通量調査表

調査地点 : 地域社会3 上川井1C

調査年月日 : 令和元年 5月11日(土) 天候:晴れ時々曇り

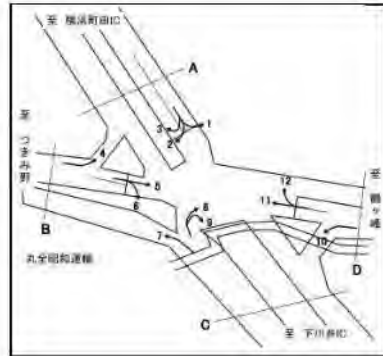

方向	3						A 合計 (1+2+3)						
	種別	小型車 (台)	大型車 (台)	合計 (台)	大型車 混入率 (%)	時 間 係 数 (%)	二輪車 (台)	小型車 (台)	大型車 (台)	合計 (台)	大型車 混入率 (%)	時 間 係 数 (%)	二輪車 (台)
22:00-22:15		2	0	2	0.0	1.2	0	9	2	11	18.2	0.6	2
22:15-22:30		2	0	2	0.0	1.2	0	13	1	14	7.1	0.8	1
22:30-22:45		2	0	2	0.0	1.2	0	11	1	12	8.3	0.7	1
22:45-23:00		1	0	1	0.0	0.6	0	10	0	10	0.0	0.6	2
1時間計		7	0	7	0.0	4.1	0	43	4	47	8.5	2.6	6
23:00-23:15		0	0	0	0.0	0.0	0	5	0	5	0.0	0.3	2
23:15-23:30		0	1	1	100.0	0.6	0	7	1	8	12.5	0.4	1
23:30-23:45		0	0	0	0.0	0.0	0	11	0	11	0.0	0.6	0
23:45-24:00		0	1	1	100.0	0.6	0	4	3	7	42.9	0.4	0
1時間計		0	2	2	100.0	1.2	0	27	4	31	12.9	1.7	3
0:00-0:15		1	0	1	0.0	0.6	0	19	0	19	0.0	1.1	1
0:15-0:30		1	0	1	0.0	0.6	0	7	0	7	0.0	0.4	1
0:30-0:45		4	1	5	20.0	2.9	0	8	1	9	11.1	0.5	0
0:45-1:00		0	1	1	100.0	0.6	0	7	4	11	36.4	0.6	1
1時間計		6	2	8	25.0	4.7	0	41	5	46	10.9	2.6	3
1:00-1:15		1	0	1	0.0	0.6	0	4	0	4	0.0	0.2	2
1:15-1:30		1	0	1	0.0	0.6	0	5	1	6	16.7	0.3	0
1:30-1:45		0	0	0	0.0	0.0	0	3	1	4	25.0	0.2	0
1:45-2:00		0	0	0	0.0	0.0	0	7	3	10	30.0	0.6	1
1時間計		2	0	2	0.0	1.2	0	19	5	24	20.8	1.3	3
2:00-2:15		2	0	2	0.0	1.2	0	4	1	5	20.0	0.3	0
2:15-2:30		2	0	2	0.0	1.2	0	7	0	7	0.0	0.4	0
2:30-2:45		2	1	3	33.3	1.7	0	9	1	10	10.0	0.6	1
2:45-3:00		2	0	2	0.0	1.2	0	8	2	10	20.0	0.6	0
1時間計		8	1	9	11.1	5.2	0	28	4	32	12.5	1.8	1
3:00-3:15		0	1	1	100.0	0.6	0	0	1	1	100.0	0.1	1
3:15-3:30		1	1	2	50.0	1.2	0	7	1	8	12.5	0.4	0
3:30-3:45		2	0	2	0.0	1.2	0	6	1	7	14.3	0.4	1
3:45-4:00		2	1	3	33.3	1.7	0	4	1	5	20.0	0.3	0
1時間計		5	3	8	37.5	4.7	0	17	4	21	19.0	1.2	2
4:00-4:15		0	0	0	0.0	0.0	0	5	1	6	16.7	0.3	2
4:15-4:30		1	3	4	75.0	2.3	0	4	4	8	50.0	0.4	0
4:30-4:45		0	1	1	100.0	0.6	0	5	2	7	28.6	0.4	1
4:45-5:00		3	0	3	0.0	1.7	0	9	1	10	10.0	0.6	0
1時間計		4	4	8	50.0	4.7	0	23	8	31	25.8	1.7	3
5:00-5:15		3	2	5	40.0	2.9	0	10	3	13	23.1	0.7	1
5:15-5:30		0	1	1	100.0	0.6	0	2	2	4	50.0	0.2	2
5:30-5:45		0	1	1	100.0	0.6	1	8	2	10	20.0	0.6	4
5:45-6:00		0	0	0	0.0	0.0	0	4	2	6	33.3	0.3	0
1時間計		3	4	7	57.1	4.1	1	24	9	33	27.3	1.9	7

方向別自動車交通量調査表

調査地点 : 地域社会3 上川井1C

調査年月日 : 令和元年 5月11日(土) 天候:晴れ時々曇り



時間帯	方向	3						A 合計 (1+2+3)					
		種別 小型車 (台)	大型車 (台)	合計 (台)	大型車 混入率 (%)	時間 係数 (%)	二輪車 (台)	小型車 (台)	大型車 (台)	合計 (台)	大型車 混入率 (%)	時間 係数 (%)	二輪車 (台)
6:00-6:15		0	0	0	0.0	0.0	0	6	1	7	14.3	0.4	1
6:15-6:30		1	0	1	0.0	0.6	0	14	2	16	12.5	0.9	0
6:30-6:45		0	0	0	0.0	0.0	0	10	1	11	9.1	0.6	1
6:45-7:00		0	0	0	0.0	0.0	0	11	0	11	0.0	0.6	0
1時間計		1	0	1	0.0	0.6	0	41	4	45	8.9	2.5	2
7:00-7:15		2	0	2	0.0	1.2	0	21	0	21	0.0	1.2	4
7:15-7:30		1	0	1	0.0	0.6	0	20	0	20	0.0	1.1	2
7:30-7:45		0	0	0	0.0	0.0	0	31	1	32	3.1	1.8	2
7:45-8:00		2	0	2	0.0	1.2	0	14	2	16	12.5	0.9	2
1時間計		5	0	5	0.0	2.9	0	86	3	89	3.4	5.0	10
8:00-8:15		1	1	2	50.0	1.2	0	26	2	28	7.1	1.6	3
8:15-8:30		2	0	2	0.0	1.2	0	23	3	26	11.5	1.5	3
8:30-8:45		0	0	0	0.0	0.0	0	25	1	26	3.8	1.5	0
8:45-9:00		1	1	2	50.0	1.2	0	18	2	20	10.0	1.1	1
1時間計		4	2	6	33.3	3.5	0	92	8	100	8.0	5.6	7
9:00-9:15		0	0	0	0.0	0.0	0	15	1	16	6.3	0.9	3
9:15-9:30		0	0	0	0.0	0.0	0	22	6	28	21.4	1.6	4
9:30-9:45		0	0	0	0.0	0.0	0	27	3	30	10.0	1.7	2
9:45-10:00		2	0	2	0.0	1.2	0	21	1	22	4.5	1.2	5
1時間計		2	0	2	0.0	1.2	0	85	11	96	11.5	5.4	14
10:00-10:15		1	0	1	0.0	0.6	0	21	1	22	4.5	1.2	3
10:15-10:30		2	0	2	0.0	1.2	0	39	3	42	7.1	2.4	5
10:30-10:45		0	0	0	0.0	0.0	0	14	2	16	12.5	0.9	2
10:45-11:00		1	1	2	50.0	1.2	0	29	6	35	17.1	2.0	2
1時間計		4	1	5	20.0	2.9	0	103	12	115	10.4	6.5	12
11:00-11:15		2	1	3	33.3	1.7	0	19	3	22	13.6	1.2	3
11:15-11:30		1	2	3	66.7	1.7	0	28	3	31	9.7	1.7	4
11:30-11:45		1	1	2	50.0	1.2	0	24	2	26	7.7	1.5	5
11:45-12:00		3	2	5	40.0	2.9	0	13	3	16	18.8	0.9	1
1時間計		7	6	13	46.2	7.6	0	84	11	95	11.6	5.3	13
12:00-12:15		2	2	4	50.0	2.3	0	27	6	33	18.2	1.9	3
12:15-12:30		0	3	3	100.0	1.7	0	28	4	32	12.5	1.8	6
12:30-12:45		2	2	4	50.0	2.3	0	29	3	32	9.4	1.8	1
12:45-13:00		0	1	1	100.0	0.6	0	29	1	30	3.3	1.7	6
1時間計		4	8	12	66.7	7.0	0	113	14	127	11.0	7.1	16
13:00-13:15		1	0	1	0.0	0.6	0	26	3	29	10.3	1.6	7
13:15-13:30		1	4	5	80.0	2.9	0	19	6	25	24.0	1.4	1
13:30-13:45		0	1	1	100.0	0.6	0	31	2	33	6.1	1.9	4
13:45-14:00		4	2	6	33.3	3.5	0	23	4	27	14.8	1.5	6
1時間計		6	7	13	53.8	7.6	0	99	15	114	13.2	6.4	18

方向別自動車交通量調査表

調査地点 : 地域社会3 上川井IC

調査年月日 : 令和元年 5月11日(土) 天候:晴れ時々曇り

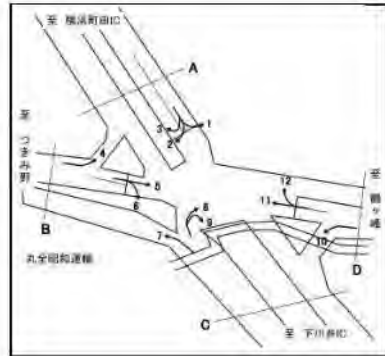

方向 種別 時間帯	3						A 合計 (1+2+3)					
	小型車 (台)	大型車 (台)	合計 (台)	大型車 混入率 (%)	時間 係数 (%)	二輪車 (台)	小型車 (台)	大型車 (台)	合計 (台)	大型車 混入率 (%)	時間 係数 (%)	二輪車 (台)
14:00-14:15	3	0	3	0.0	1.7	0	29	0	29	0.0	1.6	2
14:15-14:30	2	2	4	50.0	2.3	0	22	5	27	18.5	1.5	5
14:30-14:45	1	0	1	0.0	0.6	1	29	3	32	9.4	1.8	3
14:45-15:00	0	1	1	100.0	0.6	0	36	1	37	2.7	2.1	3
1時間計	6	3	9	33.3	5.2	1	116	9	125	7.2	7.0	13
15:00-15:15	3	1	4	25.0	2.3	0	41	2	43	4.7	2.4	8
15:15-15:30	1	1	2	50.0	1.2	0	33	5	38	13.2	2.1	4
15:30-15:45	1	0	1	0.0	0.6	0	23	3	26	11.5	1.5	5
15:45-16:00	3	1	4	25.0	2.3	0	25	5	30	16.7	1.7	6
1時間計	8	3	11	27.3	6.4	0	122	15	137	10.9	7.7	23
16:00-16:15	0	0	0	0.0	0.0	0	19	4	23	17.4	1.3	1
16:15-16:30	2	0	2	0.0	1.2	0	15	0	15	0.0	0.8	2
16:30-16:45	0	1	1	100.0	0.6	0	21	3	24	12.5	1.3	4
16:45-17:00	4	0	4	0.0	2.3	0	21	3	24	12.5	1.3	7
1時間計	6	1	7	14.3	4.1	0	76	10	86	11.6	4.8	14
17:00-17:15	0	0	0	0.0	0.0	0	28	1	29	3.4	1.6	2
17:15-17:30	1	0	1	0.0	0.6	0	21	2	23	8.7	1.3	3
17:30-17:45	2	1	3	33.3	1.7	0	20	4	24	16.7	1.3	5
17:45-18:00	4	0	4	0.0	2.3	0	18	1	19	5.3	1.1	4
1時間計	7	1	8	12.5	4.7	0	87	8	95	8.4	5.3	14
18:00-18:15	1	0	1	0.0	0.6	0	20	0	20	0.0	1.1	2
18:15-18:30	2	0	2	0.0	1.2	0	17	2	19	10.5	1.1	3
18:30-18:45	0	0	0	0.0	0.0	0	16	1	17	5.9	1.0	1
18:45-19:00	1	2	3	66.7	1.7	0	28	2	30	6.7	1.7	1
1時間計	4	2	6	33.3	3.5	0	81	5	86	5.8	4.8	7
19:00-19:15	1	0	1	0.0	0.6	0	21	0	21	0.0	1.2	2
19:15-19:30	0	1	1	100.0	0.6	0	19	2	21	9.5	1.2	3
19:30-19:45	0	2	2	100.0	1.2	0	18	4	22	18.2	1.2	4
19:45-20:00	1	0	1	0.0	0.6	0	20	2	22	9.1	1.2	0
1時間計	2	3	5	60.0	2.9	0	78	8	86	9.3	4.8	9
20:00-20:15	3	0	3	0.0	1.7	0	16	1	17	5.9	1.0	0
20:15-20:30	6	0	6	0.0	3.5	0	25	3	28	10.7	1.6	0
20:30-20:45	2	0	2	0.0	1.2	0	14	1	15	6.7	0.8	3
20:45-21:00	1	0	1	0.0	0.6	0	12	0	12	0.0	0.7	4
1時間計	12	0	12	0.0	7.0	0	67	5	72	6.9	4.0	7
21:00-21:15	2	0	2	0.0	1.2	0	13	0	13	0.0	0.7	0
21:15-21:30	0	1	1	100.0	0.6	0	6	3	9	33.3	0.5	2
21:30-21:45	0	0	0	0.0	0.0	0	9	0	9	0.0	0.5	0
21:45-22:00	3	0	3	0.0	1.7	0	12	2	14	14.3	0.8	0
1時間計	5	1	6	16.7	3.5	0	40	5	45	11.1	2.5	2
昼12時間計	63	34	97	35.1	56.4	1	1144	121	1265	9.6	71.1	161
夜12時間計	55	20	75	26.7	43.6	1	448	65	513	12.7	28.9	48
全時間合計	118	54	172	31.4	100.0	2	1592	186	1778	10.5	100.0	209
昼夜率	1.87	1.59	1.77	-	-	2.00	1.39	1.54	1.41	-	-	1.30

方向別自動車交通量調査表

調査地点 : 地域社会3 上川井1C

調査年月日 : 令和元年 5月11日(土) 天候:晴れ時々曇り

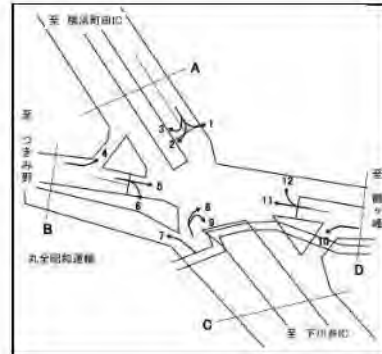

方向 種別 時間帯	4						5					
	小型車 (台)	大型車 (台)	合計 (台)	大型車 混入率 (%)	時間 係数 (%)	二輪車 (台)	小型車 (台)	大型車 (台)	合計 (台)	大型車 混入率 (%)	時間 係数 (%)	二輪車 (台)
22:00-22:15	2	0	2	0.0	2.0	0	33	2	35	5.7	1.0	6
22:15-22:30	1	0	1	0.0	1.0	0	32	1	33	3.0	1.0	4
22:30-22:45	1	1	2	50.0	2.0	1	32	1	33	3.0	1.0	5
22:45-23:00	1	2	3	66.7	3.0	0	38	2	40	5.0	1.2	6
1時間計	5	3	8	37.5	7.9	1	135	6	141	4.3	4.2	21
23:00-23:15	0	0	0	0.0	0.0	0	29	3	32	9.4	0.9	5
23:15-23:30	0	0	0	0.0	0.0	0	22	1	23	4.3	0.7	1
23:30-23:45	1	0	1	0.0	1.0	0	18	1	19	5.3	0.6	0
23:45-24:00	0	0	0	0.0	0.0	0	21	1	22	4.5	0.7	3
1時間計	1	0	1	0.0	1.0	0	90	6	96	6.3	2.8	9
0:00- 0:15	0	0	0	0.0	0.0	0	12	1	13	7.7	0.4	1
0:15- 0:30	0	0	0	0.0	0.0	0	18	2	20	10.0	0.6	2
0:30- 0:45	0	0	0	0.0	0.0	0	14	0	14	0.0	0.4	1
0:45- 1:00	0	0	0	0.0	0.0	0	7	2	9	22.2	0.3	1
1時間計	0	0	0	0.0	0.0	0	51	5	56	8.9	1.7	5
1:00- 1:15	0	0	0	0.0	0.0	0	11	4	15	26.7	0.4	1
1:15- 1:30	0	0	0	0.0	0.0	0	8	4	12	33.3	0.4	0
1:30- 1:45	0	0	0	0.0	0.0	0	7	1	8	12.5	0.2	0
1:45- 2:00	1	0	1	0.0	1.0	0	6	1	7	14.3	0.2	1
1時間計	1	0	1	0.0	1.0	0	32	10	42	23.8	1.2	2
2:00- 2:15	0	0	0	0.0	0.0	0	8	2	10	20.0	0.3	1
2:15- 2:30	0	0	0	0.0	0.0	0	2	2	4	50.0	0.1	2
2:30- 2:45	0	0	0	0.0	0.0	0	13	2	15	13.3	0.4	0
2:45- 3:00	1	0	1	0.0	1.0	0	10	1	11	9.1	0.3	1
1時間計	1	0	1	0.0	1.0	0	33	7	40	17.5	1.2	4
3:00- 3:15	0	0	0	0.0	0.0	0	2	0	2	0.0	0.1	1
3:15- 3:30	0	0	0	0.0	0.0	0	5	1	6	16.7	0.2	0
3:30- 3:45	1	0	1	0.0	1.0	0	1	1	2	50.0	0.1	0
3:45- 4:00	0	0	0	0.0	0.0	0	2	1	3	33.3	0.1	1
1時間計	1	0	1	0.0	1.0	0	10	3	13	23.1	0.4	2
4:00- 4:15	1	0	1	0.0	1.0	0	0	1	1	100.0	0.0	1
4:15- 4:30	0	0	0	0.0	0.0	0	6	4	10	40.0	0.3	3
4:30- 4:45	1	0	1	0.0	1.0	1	4	3	7	42.9	0.2	0
4:45- 5:00	3	0	3	0.0	3.0	0	6	4	10	40.0	0.3	2
1時間計	5	0	5	0.0	5.0	1	16	12	28	42.9	0.8	6
5:00- 5:15	1	0	1	0.0	1.0	0	7	2	9	22.2	0.3	3
5:15- 5:30	0	0	0	0.0	0.0	0	8	2	10	20.0	0.3	0
5:30- 5:45	0	1	1	100.0	1.0	0	8	2	10	20.0	0.3	3
5:45- 6:00	0	0	0	0.0	0.0	0	12	1	13	7.7	0.4	1
1時間計	1	1	2	50.0	2.0	0	35	7	42	16.7	1.2	7

方向別自動車交通量調査表

調査地点 : 地域社会3 上川井1C

調査年月日 : 令和元年 5月11日(土) 天候:晴れ時々曇り

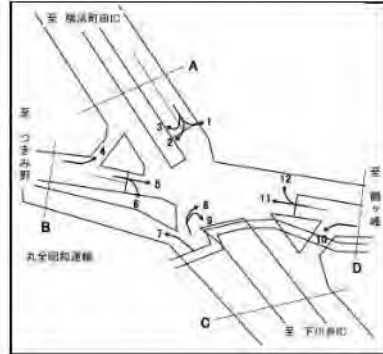

方向 時間帯	4						5					
	種別 小型車 (台)	大型車 (台)	合計 (台)	大型車 混入率 (%)	時間 係数 (%)	二輪車 (台)	小型車 (台)	大型車 (台)	合計 (台)	大型車 混入率 (%)	時間 係数 (%)	二輪車 (台)
6:00-6:15	0	0	0	0.0	0.0	0	14	0	14	0.0	0.4	0
6:15-6:30	0	1	1	100.0	1.0	1	16	1	17	5.9	0.5	2
6:30-6:45	1	0	1	0.0	1.0	0	15	1	16	6.3	0.5	7
6:45-7:00	0	0	0	0.0	0.0	0	20	2	22	9.1	0.7	2
1時間計	1	1	2	50.0	2.0	1	65	4	69	5.8	2.0	11
7:00-7:15	0	0	0	0.0	0.0	0	25	2	27	7.4	0.8	2
7:15-7:30	1	0	1	0.0	1.0	0	25	3	28	10.7	0.8	4
7:30-7:45	1	0	1	0.0	1.0	0	23	3	26	11.5	0.8	5
7:45-8:00	0	0	0	0.0	0.0	0	23	3	26	11.5	0.8	4
1時間計	2	0	2	0.0	2.0	0	96	11	107	10.3	3.2	15
8:00-8:15	0	0	0	0.0	0.0	0	26	1	27	3.7	0.8	7
8:15-8:30	1	0	1	0.0	1.0	0	37	8	45	17.8	1.3	8
8:30-8:45	2	1	3	33.3	3.0	0	31	6	37	16.2	1.1	3
8:45-9:00	1	0	1	0.0	1.0	0	46	4	50	8.0	1.5	5
1時間計	4	1	5	20.0	5.0	0	140	19	159	11.9	4.7	23
9:00-9:15	0	0	0	0.0	0.0	0	45	5	50	10.0	1.5	9
9:15-9:30	2	0	2	0.0	2.0	0	35	5	40	12.5	1.2	3
9:30-9:45	1	1	2	50.0	2.0	0	27	2	29	6.9	0.9	4
9:45-10:00	2	0	2	0.0	2.0	0	35	9	44	20.5	1.3	3
1時間計	5	1	6	16.7	5.9	0	142	21	163	12.9	4.8	19
10:00-10:15	0	0	0	0.0	0.0	0	40	2	42	4.8	1.2	2
10:15-10:30	4	0	4	0.0	4.0	0	50	3	53	5.7	1.6	5
10:30-10:45	2	1	3	33.3	3.0	0	45	4	49	8.2	1.5	6
10:45-11:00	3	1	4	25.0	4.0	0	40	3	43	7.0	1.3	4
1時間計	9	2	11	18.2	10.9	0	175	12	187	6.4	5.5	17
11:00-11:15	4	0	4	0.0	4.0	0	53	2	55	3.6	1.6	1
11:15-11:30	1	2	3	66.7	3.0	0	66	3	69	4.3	2.0	6
11:30-11:45	0	0	0	0.0	0.0	0	40	3	43	7.0	1.3	10
11:45-12:00	0	0	0	0.0	0.0	0	40	1	41	2.4	1.2	4
1時間計	5	2	7	28.6	6.9	0	199	9	208	4.3	6.2	21
12:00-12:15	2	0	2	0.0	2.0	0	49	0	49	0.0	1.5	1
12:15-12:30	1	0	1	0.0	1.0	0	47	2	49	4.1	1.5	3
12:30-12:45	1	1	2	50.0	2.0	0	53	0	53	0.0	1.6	3
12:45-13:00	2	0	2	0.0	2.0	0	58	1	59	1.7	1.7	3
1時間計	6	1	7	14.3	6.9	0	207	3	210	1.4	6.2	10
13:00-13:15	0	0	0	0.0	0.0	0	54	4	58	6.9	1.7	3
13:15-13:30	0	0	0	0.0	0.0	0	53	2	55	3.6	1.6	3
13:30-13:45	0	0	0	0.0	0.0	0	57	2	59	3.4	1.7	7
13:45-14:00	2	0	2	0.0	2.0	0	55	4	59	6.8	1.7	5
1時間計	2	0	2	0.0	2.0	0	219	12	231	5.2	6.8	18

方向別自動車交通量調査表

調査地点 : 地域社会3 上川井1C

調査年月日 : 令和元年 5月11日(土) 天候:晴れ時々曇り



方向 種別 時間帯	4						5					
	小型車 (台)	大型車 (台)	合計 (台)	大型車 混入率 (%)	時間 係数 (%)	二輪車 (台)	小型車 (台)	大型車 (台)	合計 (台)	大型車 混入率 (%)	時間 係数 (%)	二輪車 (台)
14:00-14:15	2	1	3	33.3	3.0	0	60	2	62	3.2	1.8	3
14:15-14:30	3	1	4	25.0	4.0	0	53	7	60	11.7	1.8	2
14:30-14:45	2	0	2	0.0	2.0	0	40	1	41	2.4	1.2	2
14:45-15:00	0	0	0	0.0	0.0	0	44	4	48	8.3	1.4	8
1時間計	7	2	9	22.2	8.9	0	197	14	211	6.6	6.2	15
15:00-15:15	1	2	3	66.7	3.0	0	43	4	47	8.5	1.4	2
15:15-15:30	0	1	1	100.0	1.0	0	59	3	62	4.8	1.8	9
15:30-15:45	1	0	1	0.0	1.0	0	46	0	46	0.0	1.4	6
15:45-16:00	2	0	2	0.0	2.0	1	61	1	62	1.6	1.8	7
1時間計	4	3	7	42.9	6.9	1	209	8	217	3.7	6.4	24
16:00-16:15	1	1	2	50.0	2.0	0	45	3	48	6.3	1.4	2
16:15-16:30	0	0	0	0.0	0.0	1	52	2	54	3.7	1.6	8
16:30-16:45	3	1	4	25.0	4.0	0	58	0	58	0.0	1.7	3
16:45-17:00	0	0	0	0.0	0.0	1	50	4	54	7.4	1.6	10
1時間計	4	2	6	33.3	5.9	2	205	9	214	4.2	6.3	23
17:00-17:15	2	0	2	0.0	2.0	0	61	3	64	4.7	1.9	8
17:15-17:30	0	1	1	100.0	1.0	0	49	2	51	3.9	1.5	6
17:30-17:45	3	0	3	0.0	3.0	0	59	4	63	6.3	1.9	4
17:45-18:00	1	0	1	0.0	1.0	0	62	1	63	1.6	1.9	5
1時間計	6	1	7	14.3	6.9	0	231	10	241	4.1	7.1	23
18:00-18:15	1	0	1	0.0	1.0	0	61	0	61	0.0	1.8	4
18:15-18:30	0	0	0	0.0	0.0	0	44	5	49	10.2	1.5	1
18:30-18:45	0	0	0	0.0	0.0	0	46	0	46	0.0	1.4	6
18:45-19:00	1	1	2	50.0	2.0	0	47	3	50	6.0	1.5	2
1時間計	2	1	3	33.3	3.0	0	198	8	206	3.9	6.1	13
19:00-19:15	0	0	0	0.0	0.0	0	51	4	55	7.3	1.6	4
19:15-19:30	1	0	1	0.0	1.0	1	46	1	47	2.1	1.4	4
19:30-19:45	1	0	1	0.0	1.0	0	42	4	46	8.7	1.4	1
19:45-20:00	0	0	0	0.0	0.0	0	34	5	39	12.8	1.2	4
1時間計	2	0	2	0.0	2.0	1	173	14	187	7.5	5.5	13
20:00-20:15	2	0	2	0.0	2.0	0	37	2	39	5.1	1.2	8
20:15-20:30	1	0	1	0.0	1.0	0	43	5	48	10.4	1.4	3
20:30-20:45	0	1	1	100.0	1.0	0	41	2	43	4.7	1.3	2
20:45-21:00	0	0	0	0.0	0.0	0	28	1	29	3.4	0.9	4
1時間計	3	1	4	25.0	4.0	0	149	10	159	6.3	4.7	17
21:00-21:15	0	0	0	0.0	0.0	0	41	1	42	2.4	1.2	3
21:15-21:30	0	0	0	0.0	0.0	0	36	3	39	7.7	1.2	3
21:30-21:45	0	1	1	100.0	1.0	0	33	0	33	0.0	1.0	4
21:45-22:00	0	1	1	100.0	1.0	0	35	1	36	2.8	1.1	3
1時間計	0	2	2	100.0	2.0	0	145	5	150	3.3	4.4	13
昼12時間計	56	16	72	22.2	71.3	3	2218	136	2354	5.8	69.7	221
夜12時間計	21	8	29	27.6	28.7	4	934	89	1023	8.7	30.3	110
全時間合計	77	24	101	23.8	100.0	7	3152	225	3377	6.7	100.0	331
昼夜率	1.38	1.50	1.40	-	-	2.33	1.42	1.65	1.43	-	-	1.50

方向別自動車交通量調査表

調査地点 : 地域社会3 上川井IC

調査年月日 : 令和元年 5月11日(土) 天候:晴れ時々曇り

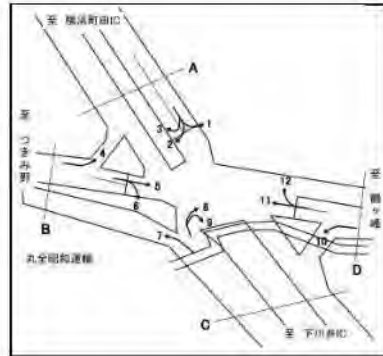

方向	6						B 合計 (4+ 5+ 6)					
	種別 時間帯	小型車 (台)	大型車 (台)	合計 (台)	大型車 混入率 (%)	時間 係数 (%)	二輪車 (台)	小型車 (台)	大型車 (台)	合計 (台)	大型車 混入率 (%)	時間 係数 (%)
22:00-22:15	53	8	61	13.1	1.0	2	88	10	98	10.2	1.0	8
22:15-22:30	38	8	46	17.4	0.8	5	71	9	80	11.3	0.8	9
22:30-22:45	42	5	47	10.6	0.8	1	75	7	82	8.5	0.9	7
22:45-23:00	51	12	63	19.0	1.1	1	90	16	106	15.1	1.1	7
1時間計	184	33	217	15.2	3.6	9	324	42	366	11.5	3.9	31
23:00-23:15	49	13	62	21.0	1.0	2	78	16	94	17.0	1.0	7
23:15-23:30	39	13	52	25.0	0.9	0	61	14	75	18.7	0.8	1
23:30-23:45	23	12	35	34.3	0.6	2	42	13	55	23.6	0.6	2
23:45-24:00	19	6	25	24.0	0.4	2	40	7	47	14.9	0.5	5
1時間計	130	44	174	25.3	2.9	6	221	50	271	18.5	2.9	15
0:00- 0:15	22	14	36	38.9	0.6	0	34	15	49	30.6	0.5	1
0:15- 0:30	16	9	25	36.0	0.4	0	34	11	45	24.4	0.5	2
0:30- 0:45	15	10	25	40.0	0.4	0	29	10	39	25.6	0.4	1
0:45- 1:00	14	13	27	48.1	0.5	0	21	15	36	41.7	0.4	1
1時間計	67	46	113	40.7	1.9	0	118	51	169	30.2	1.8	5
1:00- 1:15	19	13	32	40.6	0.5	0	30	17	47	36.2	0.5	1
1:15- 1:30	17	9	26	34.6	0.4	0	25	13	38	34.2	0.4	0
1:30- 1:45	15	5	20	25.0	0.3	0	22	6	28	21.4	0.3	0
1:45- 2:00	14	5	19	26.3	0.3	0	21	6	27	22.2	0.3	1
1時間計	65	32	97	33.0	1.6	0	98	42	140	30.0	1.5	2
2:00- 2:15	11	9	20	45.0	0.3	1	19	11	30	36.7	0.3	2
2:15- 2:30	8	9	17	52.9	0.3	0	10	11	21	52.4	0.2	2
2:30- 2:45	11	11	22	50.0	0.4	0	24	13	37	35.1	0.4	0
2:45- 3:00	13	9	22	40.9	0.4	0	24	10	34	29.4	0.4	1
1時間計	43	38	81	46.9	1.4	1	77	45	122	36.9	1.3	5
3:00- 3:15	10	10	20	50.0	0.3	0	12	10	22	45.5	0.2	1
3:15- 3:30	8	11	19	57.9	0.3	0	13	12	25	48.0	0.3	0
3:30- 3:45	15	11	26	42.3	0.4	1	17	12	29	41.4	0.3	1
3:45- 4:00	6	13	19	68.4	0.3	1	8	14	22	63.6	0.2	2
1時間計	39	45	84	53.6	1.4	2	50	48	98	49.0	1.0	4
4:00- 4:15	9	11	20	55.0	0.3	1	10	12	22	54.5	0.2	2
4:15- 4:30	13	13	26	50.0	0.4	0	19	17	36	47.2	0.4	3
4:30- 4:45	22	12	34	35.3	0.6	1	27	15	42	35.7	0.4	2
4:45- 5:00	16	8	24	33.3	0.4	0	25	12	37	32.4	0.4	2
1時間計	60	44	104	42.3	1.7	2	81	56	137	40.9	1.4	9
5:00- 5:15	24	18	42	42.9	0.7	2	32	20	52	38.5	0.6	5
5:15- 5:30	33	9	42	21.4	0.7	0	41	11	52	21.2	0.6	0
5:30- 5:45	22	20	42	47.6	0.7	3	30	23	53	43.4	0.6	6
5:45- 6:00	29	15	44	34.1	0.7	2	41	16	57	28.1	0.6	3
1時間計	108	62	170	36.5	2.8	7	144	70	214	32.7	2.3	14

方向別自動車交通量調査表

調査地点 : 地域社会3 上川井1C

調査年月日 : 令和元年 5月11日(土) 天候:晴れ時々曇り



方向 時間帯	6						B 合計 (4+ 5+ 6)					
	種別 小型車 (台)	大型車 (台)	合計 (台)	大型車 混入率 (%)	時間 係数 (%)	二輪車 (台)	小型車 (台)	大型車 (台)	合計 (台)	大型車 混入率 (%)	時間 係数 (%)	二輪車 (台)
6:00-6:15	34	11	45	24.4	0.8	3	48	11	59	18.6	0.6	3
6:15-6:30	42	11	53	20.8	0.9	0	58	13	71	18.3	0.8	3
6:30-6:45	32	11	43	25.6	0.7	1	48	12	60	20.0	0.6	8
6:45-7:00	44	11	55	20.0	0.9	5	64	13	77	16.9	0.8	7
1時間計	152	44	196	22.4	3.3	9	218	49	267	18.4	2.8	21
7:00-7:15	50	11	61	18.0	1.0	0	75	13	88	14.8	0.9	2
7:15-7:30	46	9	55	16.4	0.9	0	72	12	84	14.3	0.9	4
7:30-7:45	56	12	68	17.6	1.1	1	80	15	95	15.8	1.0	6
7:45-8:00	70	7	77	9.1	1.3	1	93	10	103	9.7	1.1	5
1時間計	222	39	261	14.9	4.4	2	320	50	370	13.5	3.9	17
8:00-8:15	68	9	77	11.7	1.3	2	94	10	104	9.6	1.1	9
8:15-8:30	70	17	87	19.5	1.5	3	108	25	133	18.8	1.4	11
8:30-8:45	69	16	85	18.8	1.4	0	102	23	125	18.4	1.3	3
8:45-9:00	63	14	77	18.2	1.3	1	110	18	128	14.1	1.4	6
1時間計	270	56	326	17.2	5.5	6	414	76	490	15.5	5.2	29
9:00-9:15	87	10	97	10.3	1.6	0	132	15	147	10.2	1.6	9
9:15-9:30	79	7	86	8.1	1.4	5	116	12	128	9.4	1.4	8
9:30-9:45	69	9	78	11.5	1.3	3	97	12	109	11.0	1.2	7
9:45-10:00	68	7	75	9.3	1.3	1	105	16	121	13.2	1.3	4
1時間計	303	33	336	9.8	5.6	9	450	55	505	10.9	5.3	28
10:00-10:15	71	11	82	13.4	1.4	0	111	13	124	10.5	1.3	2
10:15-10:30	80	9	89	10.1	1.5	2	134	12	146	8.2	1.5	7
10:30-10:45	67	8	75	10.7	1.3	1	114	13	127	10.2	1.3	7
10:45-11:00	75	9	84	10.7	1.4	3	118	13	131	9.9	1.4	7
1時間計	293	37	330	11.2	5.5	6	477	51	528	9.7	5.6	23
11:00-11:15	70	7	77	9.1	1.3	2	127	9	136	6.6	1.4	3
11:15-11:30	67	12	79	15.2	1.3	1	134	17	151	11.3	1.6	7
11:30-11:45	69	12	81	14.8	1.4	3	109	15	124	12.1	1.3	13
11:45-12:00	71	8	79	10.1	1.3	3	111	9	120	7.5	1.3	7
1時間計	277	39	316	12.3	5.3	9	481	50	531	9.4	5.6	30
12:00-12:15	58	8	66	12.1	1.1	3	109	8	117	6.8	1.2	4
12:15-12:30	65	14	79	17.7	1.3	2	113	16	129	12.4	1.4	5
12:30-12:45	72	20	92	21.7	1.5	1	126	21	147	14.3	1.6	4
12:45-13:00	64	12	76	15.8	1.3	5	124	13	137	9.5	1.4	8
1時間計	259	54	313	17.3	5.2	11	472	58	530	10.9	5.6	21
13:00-13:15	78	13	91	14.3	1.5	0	132	17	149	11.4	1.6	3
13:15-13:30	68	8	76	10.5	1.3	1	121	10	131	7.6	1.4	4
13:30-13:45	65	9	74	12.2	1.2	4	122	11	133	8.3	1.4	11
13:45-14:00	53	8	61	13.1	1.0	3	110	12	122	9.8	1.3	8
1時間計	264	38	302	12.6	5.1	8	485	50	535	9.3	5.7	26

方向別自動車交通量調査表

調査地点 : 地域社会3 上川井IC

調査年月日 : 令和元年 5月11日(土) 天候:晴れ時々曇り

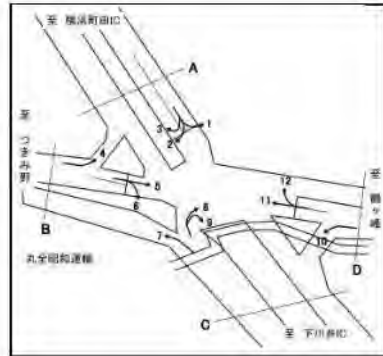

方向 種別 時間帯	6						B 合計 (4+ 5+ 6)					
	小型車 (台)	大型車 (台)	合計 (台)	大型車 混入率 (%)	時間 係数 (%)	二輪車 (台)	小型車 (台)	大型車 (台)	合計 (台)	大型車 混入率 (%)	時間 係数 (%)	二輪車 (台)
14:00-14:15	69	17	86	19.8	1.4	2	131	20	151	13.2	1.6	5
14:15-14:30	64	5	69	7.2	1.2	2	120	13	133	9.8	1.4	4
14:30-14:45	67	13	80	16.3	1.3	5	109	14	123	11.4	1.3	7
14:45-15:00	60	9	69	13.0	1.2	1	104	13	117	11.1	1.2	9
1時間計	260	44	304	14.5	5.1	10	464	60	524	11.5	5.5	25
15:00-15:15	52	6	58	10.3	1.0	2	96	12	108	11.1	1.1	4
15:15-15:30	89	11	100	11.0	1.7	0	148	15	163	9.2	1.7	9
15:30-15:45	88	6	94	6.4	1.6	3	135	6	141	4.3	1.5	9
15:45-16:00	85	8	93	8.6	1.6	8	148	9	157	5.7	1.7	16
1時間計	314	31	345	9.0	5.8	13	527	42	569	7.4	6.0	38
16:00-16:15	90	12	102	11.8	1.7	4	136	16	152	10.5	1.6	6
16:15-16:30	60	6	66	9.1	1.1	4	112	8	120	6.7	1.3	13
16:30-16:45	92	11	103	10.7	1.7	4	153	12	165	7.3	1.7	7
16:45-17:00	83	11	94	11.7	1.6	4	133	15	148	10.1	1.6	15
1時間計	325	40	365	11.0	6.1	16	534	51	585	8.7	6.2	41
17:00-17:15	82	11	93	11.8	1.6	1	145	14	159	8.8	1.7	9
17:15-17:30	95	11	106	10.4	1.8	1	144	14	158	8.9	1.7	7
17:30-17:45	91	10	101	9.9	1.7	2	153	14	167	8.4	1.8	6
17:45-18:00	69	11	80	13.8	1.3	0	132	12	144	8.3	1.5	5
1時間計	337	43	380	11.3	6.4	4	574	54	628	8.6	6.6	27
18:00-18:15	80	8	88	9.1	1.5	2	142	8	150	5.3	1.6	6
18:15-18:30	73	12	85	14.1	1.4	1	117	17	134	12.7	1.4	2
18:30-18:45	83	8	91	8.8	1.5	2	129	8	137	5.8	1.4	8
18:45-19:00	75	10	85	11.8	1.4	2	123	14	137	10.2	1.4	4
1時間計	311	38	349	10.9	5.8	7	511	47	558	8.4	5.9	20
19:00-19:15	45	24	69	34.8	1.2	3	96	28	124	22.6	1.3	7
19:15-19:30	62	13	75	17.3	1.3	2	109	14	123	11.4	1.3	7
19:30-19:45	67	6	73	8.2	1.2	0	110	10	120	8.3	1.3	1
19:45-20:00	70	13	83	15.7	1.4	1	104	18	122	14.8	1.3	5
1時間計	244	56	300	18.7	5.0	6	419	70	489	14.3	5.2	20
20:00-20:15	79	10	89	11.2	1.5	2	118	12	130	9.2	1.4	10
20:15-20:30	42	16	58	27.6	1.0	2	86	21	107	19.6	1.1	5
20:30-20:45	48	14	62	22.6	1.0	3	89	17	106	16.0	1.1	5
20:45-21:00	41	11	52	21.2	0.9	0	69	12	81	14.8	0.9	4
1時間計	210	51	261	19.5	4.4	7	362	62	424	14.6	4.5	24
21:00-21:15	51	11	62	17.7	1.0	1	92	12	104	11.5	1.1	4
21:15-21:30	48	14	62	22.6	1.0	0	84	17	101	16.8	1.1	3
21:30-21:45	55	16	71	22.5	1.2	1	88	17	105	16.2	1.1	5
21:45-22:00	43	9	52	17.3	0.9	0	78	11	89	12.4	0.9	3
1時間計	197	50	247	20.2	4.1	2	342	57	399	14.3	4.2	15
昼12時間計	3435	492	3927	12.5	65.8	101	5709	644	6353	10.1	67.2	325
夜12時間計	1499	545	2044	26.7	34.2	51	2454	642	3096	20.7	32.8	165
全時間合計	4934	1037	5971	17.4	100.0	152	8163	1286	9449	13.6	100.0	490
昼夜率	1.44	2.11	1.52	-	-	1.50	1.43	2.00	1.49	-	-	1.51

方向別自動車交通量調査表

調査地点 : 地域社会3 上川井1C

調査年月日 : 令和元年 5月11日(土) 天候:晴れ時々曇り

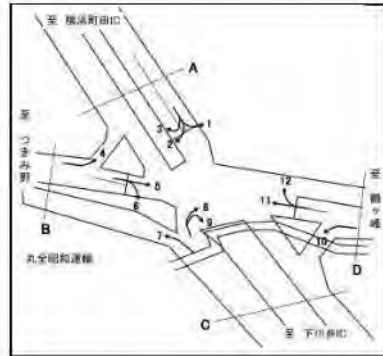

方向	7						8						
	種別	小型車 (台)	大型車 (台)	合計 (台)	大型車 混入率 (%)	時間 係数 (%)	二輪車 (台)	小型車 (台)	大型車 (台)	合計 (台)	大型車 混入率 (%)	時間 係数 (%)	二輪車 (台)
22:00-22:15		42	10	52	19.2	0.8	1	6	0	6	0.0	0.3	1
22:15-22:30		37	4	41	9.8	0.6	1	8	0	8	0.0	0.4	0
22:30-22:45		48	11	59	18.6	0.9	1	13	0	13	0.0	0.7	0
22:45-23:00		36	17	53	32.1	0.8	4	9	0	9	0.0	0.5	0
1時間計		163	42	205	20.5	3.2	7	36	0	36	0.0	2.0	1
23:00-23:15		30	7	37	18.9	0.6	1	4	0	4	0.0	0.2	0
23:15-23:30		20	3	23	13.0	0.4	2	6	1	7	14.3	0.4	1
23:30-23:45		35	8	43	18.6	0.7	0	4	0	4	0.0	0.2	1
23:45-24:00		23	11	34	32.4	0.5	1	6	0	6	0.0	0.3	1
1時間計		108	29	137	21.2	2.2	4	20	1	21	4.8	1.2	3
0:00-0:15		24	5	29	17.2	0.5	0	4	0	4	0.0	0.2	0
0:15-0:30		33	7	40	17.5	0.6	1	4	0	4	0.0	0.2	0
0:30-0:45		26	5	31	16.1	0.5	3	3	1	4	25.0	0.2	1
0:45-1:00		14	14	28	50.0	0.4	0	5	1	6	16.7	0.3	0
1時間計		97	31	128	24.2	2.0	4	16	2	18	11.1	1.0	1
1:00-1:15		18	15	33	45.5	0.5	1	5	2	7	28.6	0.4	0
1:15-1:30		8	7	15	46.7	0.2	0	2	0	2	0.0	0.1	0
1:30-1:45		11	12	23	52.2	0.4	0	3	0	3	0.0	0.2	0
1:45-2:00		17	12	29	41.4	0.5	0	4	0	4	0.0	0.2	0
1時間計		54	46	100	46.0	1.6	1	14	2	16	12.5	0.9	0
2:00-2:15		14	14	28	50.0	0.4	0	5	0	5	0.0	0.3	0
2:15-2:30		11	13	24	54.2	0.4	0	3	0	3	0.0	0.2	0
2:30-2:45		14	13	27	48.1	0.4	1	2	0	2	0.0	0.1	0
2:45-3:00		14	11	25	44.0	0.4	0	3	0	3	0.0	0.2	0
1時間計		53	51	104	49.0	1.6	1	13	0	13	0.0	0.7	0
3:00-3:15		11	14	25	56.0	0.4	0	2	1	3	33.3	0.2	0
3:15-3:30		11	12	23	52.2	0.4	0	3	2	5	40.0	0.3	0
3:30-3:45		12	10	22	45.5	0.3	0	3	1	4	25.0	0.2	0
3:45-4:00		11	9	20	45.0	0.3	0	2	0	2	0.0	0.1	4
1時間計		45	45	90	50.0	1.4	0	10	4	14	28.6	0.8	4
4:00-4:15		13	2	15	13.3	0.2	0	2	2	4	50.0	0.2	0
4:15-4:30		16	3	19	15.8	0.3	1	3	1	4	25.0	0.2	0
4:30-4:45		9	12	21	57.1	0.3	0	4	1	5	20.0	0.3	0
4:45-5:00		10	5	15	33.3	0.2	2	1	0	1	0.0	0.1	0
1時間計		48	22	70	31.4	1.1	3	10	4	14	28.6	0.8	0
5:00-5:15		32	10	42	23.8	0.7	0	5	0	5	0.0	0.3	0
5:15-5:30		23	9	32	28.1	0.5	0	2	1	3	33.3	0.2	0
5:30-5:45		26	12	38	31.6	0.6	4	4	0	4	0.0	0.2	0
5:45-6:00		28	9	37	24.3	0.6	0	5	0	5	0.0	0.3	0
1時間計		109	40	149	26.8	2.3	4	16	1	17	5.9	1.0	0

方向別自動車交通量調査表

調査地点 : 地域社会3 上川井1C

調査年月日 : 令和元年 5月11日(土) 天候:晴れ時々曇り

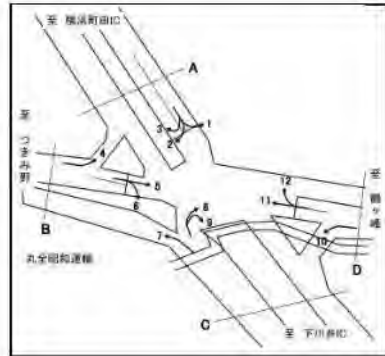

時間帯	7						8					
	小型車 (台)	大型車 (台)	合計 (台)	大型車 混入率 (%)	時間 係数 (%)	二輪車 (台)	小型車 (台)	大型車 (台)	合計 (台)	大型車 混入率 (%)	時間 係数 (%)	二輪車 (台)
6:00-6:15	37	14	51	27.5	0.8	0	5	0	5	0.0	0.3	0
6:15-6:30	45	11	56	19.6	0.9	2	9	2	11	18.2	0.6	0
6:30-6:45	54	12	66	18.2	1.0	4	7	1	8	12.5	0.4	1
6:45-7:00	38	19	57	33.3	0.9	0	9	0	9	0.0	0.5	0
1時間計	174	56	230	24.3	3.6	6	30	3	33	9.1	1.8	1
7:00-7:15	50	17	67	25.4	1.1	1	4	2	6	33.3	0.3	1
7:15-7:30	45	17	62	27.4	1.0	3	13	1	14	7.1	0.8	0
7:30-7:45	49	17	66	25.8	1.0	1	26	2	28	7.1	1.6	2
7:45-8:00	72	17	89	19.1	1.4	1	19	2	21	9.5	1.2	0
1時間計	216	68	284	23.9	4.5	6	62	7	69	10.1	3.9	3
8:00-8:15	85	12	97	12.4	1.5	5	43	1	44	2.3	2.5	1
8:15-8:30	70	11	81	13.6	1.3	5	20	0	20	0.0	1.1	0
8:30-8:45	75	10	85	11.8	1.3	2	33	3	36	8.3	2.0	1
8:45-9:00	79	12	91	13.2	1.4	3	29	0	29	0.0	1.6	0
1時間計	309	45	354	12.7	5.6	15	125	4	129	3.1	7.2	2
9:00-9:15	87	8	95	8.4	1.5	2	32	0	32	0.0	1.8	1
9:15-9:30	71	10	81	12.3	1.3	1	33	1	34	2.9	1.9	1
9:30-9:45	86	17	103	16.5	1.6	0	37	0	37	0.0	2.1	1
9:45-10:00	74	16	90	17.8	1.4	0	42	1	43	2.3	2.4	2
1時間計	318	51	369	13.8	5.8	3	144	2	146	1.4	8.2	5
10:00-10:15	78	18	96	18.8	1.5	2	31	1	32	3.1	1.8	1
10:15-10:30	109	10	119	8.4	1.9	2	21	1	22	4.5	1.2	1
10:30-10:45	90	11	101	10.9	1.6	4	38	2	40	5.0	2.2	0
10:45-11:00	64	14	78	17.9	1.2	6	31	1	32	3.1	1.8	0
1時間計	341	53	394	13.5	6.2	14	121	5	126	4.0	7.1	2
11:00-11:15	78	16	94	17.0	1.5	3	27	1	28	3.6	1.6	0
11:15-11:30	81	8	89	9.0	1.4	4	34	1	35	2.9	2.0	0
11:30-11:45	93	11	104	10.6	1.6	3	31	0	31	0.0	1.7	1
11:45-12:00	75	13	88	14.8	1.4	1	26	1	27	3.7	1.5	2
1時間計	327	48	375	12.8	5.9	11	118	3	121	2.5	6.8	3
12:00-12:15	82	14	96	14.6	1.5	4	28	2	30	6.7	1.7	0
12:15-12:30	93	13	106	12.3	1.7	2	28	0	28	0.0	1.6	0
12:30-12:45	70	15	85	17.6	1.3	2	27	4	31	12.9	1.7	0
12:45-13:00	82	11	93	11.8	1.5	4	25	2	27	7.4	1.5	3
1時間計	327	53	380	13.9	6.0	12	108	8	116	6.9	6.5	3
13:00-13:15	70	5	75	6.7	1.2	4	32	1	33	3.0	1.8	3
13:15-13:30	63	10	73	13.7	1.1	5	37	1	38	2.6	2.1	6
13:30-13:45	72	15	87	17.2	1.4	3	36	5	41	12.2	2.3	1
13:45-14:00	85	6	91	6.6	1.4	1	17	3	20	15.0	1.1	2
1時間計	290	36	326	11.0	5.1	13	122	10	132	7.6	7.4	12

方向別自動車交通量調査表

調査地点 : 地域社会3 上川井IC

調査年月日 : 令和元年 5月11日(土) 天候:晴れ時々曇り

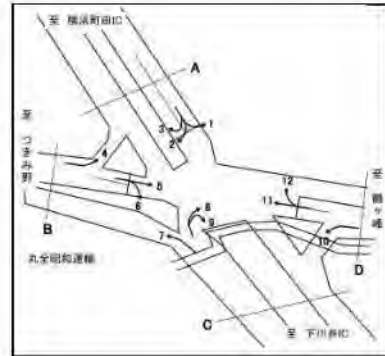

時間帯	7						8					
	小型車 (台)	大型車 (台)	合計 (台)	大型車 混入率 (%)	時間 係数 (%)	二輪車 (台)	小型車 (台)	大型車 (台)	合計 (台)	大型車 混入率 (%)	時間 係数 (%)	二輪車 (台)
14:00-14:15	84	13	97	13.4	1.5	3	31	1	32	3.1	1.8	0
14:15-14:30	60	10	70	14.3	1.1	1	30	0	30	0.0	1.7	0
14:30-14:45	101	13	114	11.4	1.8	2	39	2	41	4.9	2.3	0
14:45-15:00	72	15	87	17.2	1.4	1	25	0	25	0.0	1.4	1
1時間計	317	51	368	13.9	5.8	7	125	3	128	2.3	7.2	1
15:00-15:15	83	8	91	8.8	1.4	2	26	0	26	0.0	1.5	1
15:15-15:30	66	17	83	20.5	1.3	4	25	1	26	3.8	1.5	1
15:30-15:45	81	12	93	12.9	1.5	0	27	1	28	3.6	1.6	2
15:45-16:00	82	12	94	12.8	1.5	1	25	1	26	3.8	1.5	2
1時間計	312	49	361	13.6	5.7	7	103	3	106	2.8	5.9	6
16:00-16:15	83	9	92	9.8	1.4	3	30	0	30	0.0	1.7	0
16:15-16:30	89	14	103	13.6	1.6	1	34	2	36	5.6	2.0	0
16:30-16:45	84	12	96	12.5	1.5	2	36	0	36	0.0	2.0	2
16:45-17:00	84	9	93	9.7	1.5	0	44	0	44	0.0	2.5	0
1時間計	340	44	384	11.5	6.0	6	144	2	146	1.4	8.2	2
17:00-17:15	93	12	105	11.4	1.7	3	18	0	18	0.0	1.0	0
17:15-17:30	96	16	112	14.3	1.8	2	26	1	27	3.7	1.5	0
17:30-17:45	91	6	97	6.2	1.5	3	36	0	36	0.0	2.0	0
17:45-18:00	89	9	98	9.2	1.5	7	27	2	29	6.9	1.6	0
1時間計	369	43	412	10.4	6.5	15	107	3	110	2.7	6.2	0
18:00-18:15	72	10	82	12.2	1.3	2	24	0	24	0.0	1.3	0
18:15-18:30	84	11	95	11.6	1.5	2	23	0	23	0.0	1.3	0
18:30-18:45	73	14	87	16.1	1.4	0	19	0	19	0.0	1.1	0
18:45-19:00	67	15	82	18.3	1.3	1	13	0	13	0.0	0.7	0
1時間計	296	50	346	14.5	5.4	5	79	0	79	0.0	4.4	0
19:00-19:15	62	14	76	18.4	1.2	0	30	0	30	0.0	1.7	0
19:15-19:30	51	8	59	13.6	0.9	0	16	1	17	5.9	1.0	0
19:30-19:45	53	13	66	19.7	1.0	2	8	0	8	0.0	0.4	0
19:45-20:00	55	16	71	22.5	1.1	5	13	0	13	0.0	0.7	1
1時間計	221	51	272	18.8	4.3	7	67	1	68	1.5	3.8	1
20:00-20:15	53	9	62	14.5	1.0	1	28	0	28	0.0	1.6	0
20:15-20:30	51	10	61	16.4	1.0	1	25	1	26	3.8	1.5	0
20:30-20:45	42	12	54	22.2	0.8	0	19	4	23	17.4	1.3	0
20:45-21:00	63	18	81	22.2	1.3	0	15	0	15	0.0	0.8	0
1時間計	209	49	258	19.0	4.1	2	87	5	92	5.4	5.1	0
21:00-21:15	50	12	62	19.4	1.0	1	13	1	14	7.1	0.8	0
21:15-21:30	49	12	61	19.7	1.0	1	8	0	8	0.0	0.4	0
21:30-21:45	56	20	76	26.3	1.2	0	4	1	5	20.0	0.3	0
21:45-22:00	45	16	61	26.2	1.0	0	10	0	10	0.0	0.6	0
1時間計	200	60	260	23.1	4.1	2	35	2	37	5.4	2.1	0
昼12時間計	3762	591	4353	13.6	68.5	114	1358	50	1408	3.6	78.8	39
夜12時間計	1481	522	2003	26.1	31.5	41	354	25	379	6.6	21.2	11
全時間合計	5243	1113	6356	17.5	100.0	155	1712	75	1787	4.2	100.0	50
昼夜率	1.39	1.88	1.46	-	-	1.36	1.26	1.50	1.27	-	-	1.28

方向別自動車交通量調査表

調査地点 : 地域社会3 上川井1C

調査年月日 : 令和元年 5月11日(土) 天候:晴れ時々曇り

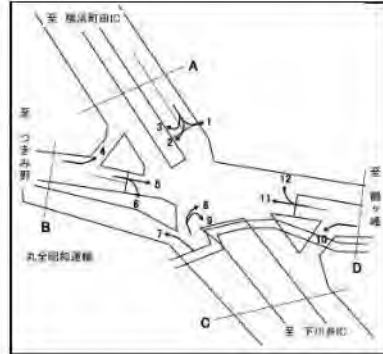

方向 種別 時間帯	9						C 合計 (7+ 8+ 9)					
	小型車 (台)	大型車 (台)	合計 (台)	大型車 混入率 (%)	時間 係数 (%)	二輪車 (台)	小型車 (台)	大型車 (台)	合計 (台)	大型車 混入率 (%)	時間 係数 (%)	二輪車 (台)
22:00-22:15	0	0	0	0.0	0.0	0	48	10	58	17.2	0.7	2
22:15-22:30	0	0	0	0.0	0.0	1	45	4	49	8.2	0.6	2
22:30-22:45	0	0	0	0.0	0.0	0	61	11	72	15.3	0.9	1
22:45-23:00	0	0	0	0.0	0.0	0	45	17	62	27.4	0.8	4
1時間計	0	0	0	0.0	0.0	1	199	42	241	17.4	2.9	9
23:00-23:15	0	0	0	0.0	0.0	0	34	7	41	17.1	0.5	1
23:15-23:30	0	0	0	0.0	0.0	0	26	4	30	13.3	0.4	3
23:30-23:45	0	0	0	0.0	0.0	0	39	8	47	17.0	0.6	1
23:45-24:00	0	0	0	0.0	0.0	0	29	11	40	27.5	0.5	2
1時間計	0	0	0	0.0	0.0	0	128	30	158	19.0	1.9	7
0:00- 0:15	0	0	0	0.0	0.0	0	28	5	33	15.2	0.4	0
0:15- 0:30	0	0	0	0.0	0.0	0	37	7	44	15.9	0.5	1
0:30- 0:45	1	0	1	0.0	2.7	0	30	6	36	16.7	0.4	4
0:45- 1:00	0	0	0	0.0	0.0	0	19	15	34	44.1	0.4	0
1時間計	1	0	1	0.0	2.7	0	114	33	147	22.4	1.8	5
1:00- 1:15	1	0	1	0.0	2.7	0	24	17	41	41.5	0.5	1
1:15- 1:30	0	0	0	0.0	0.0	0	10	7	17	41.2	0.2	0
1:30- 1:45	0	0	0	0.0	0.0	0	14	12	26	46.2	0.3	0
1:45- 2:00	0	0	0	0.0	0.0	0	21	12	33	36.4	0.4	0
1時間計	1	0	1	0.0	2.7	0	69	48	117	41.0	1.4	1
2:00- 2:15	0	0	0	0.0	0.0	0	19	14	33	42.4	0.4	0
2:15- 2:30	1	0	1	0.0	2.7	0	15	13	28	46.4	0.3	0
2:30- 2:45	0	0	0	0.0	0.0	0	16	13	29	44.8	0.4	1
2:45- 3:00	0	0	0	0.0	0.0	0	17	11	28	39.3	0.3	0
1時間計	1	0	1	0.0	2.7	0	67	51	118	43.2	1.4	1
3:00- 3:15	0	0	0	0.0	0.0	0	13	15	28	53.6	0.3	0
3:15- 3:30	0	0	0	0.0	0.0	0	14	14	28	50.0	0.3	0
3:30- 3:45	2	0	2	0.0	5.4	0	17	11	28	39.3	0.3	0
3:45- 4:00	0	0	0	0.0	0.0	0	13	9	22	40.9	0.3	4
1時間計	2	0	2	0.0	5.4	0	57	49	106	46.2	1.3	4
4:00- 4:15	0	0	0	0.0	0.0	0	15	4	19	21.1	0.2	0
4:15- 4:30	0	0	0	0.0	0.0	0	19	4	23	17.4	0.3	1
4:30- 4:45	0	0	0	0.0	0.0	0	13	13	26	50.0	0.3	0
4:45- 5:00	0	0	0	0.0	0.0	0	11	5	16	31.3	0.2	2
1時間計	0	0	0	0.0	0.0	0	58	26	84	31.0	1.0	3
5:00- 5:15	0	0	0	0.0	0.0	0	37	10	47	21.3	0.6	0
5:15- 5:30	0	0	0	0.0	0.0	0	25	10	35	28.6	0.4	0
5:30- 5:45	2	0	2	0.0	5.4	0	32	12	44	27.3	0.5	4
5:45- 6:00	2	0	2	0.0	5.4	0	35	9	44	20.5	0.5	0
1時間計	4	0	4	0.0	10.8	0	129	41	170	24.1	2.1	4

方向別自動車交通量調査表

調査地点 : 地域社会3 上川井1C

調査年月日 : 令和元年 5月11日(土) 天候:晴れ時々曇り

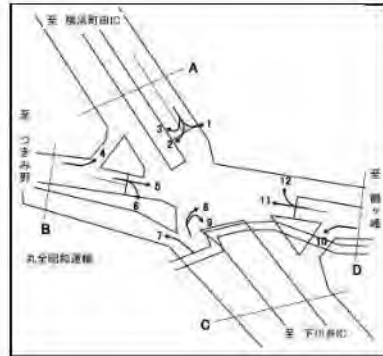

時間帯	種別	9						C 合計 (7+ 8+ 9)					
		小型車 (台)	大型車 (台)	合計 (台)	大型車 混入率 (%)	時間 係数 (%)	二輪車 (台)	小型車 (台)	大型車 (台)	合計 (台)	大型車 混入率 (%)	時間 係数 (%)	二輪車 (台)
6:00-6:15		2	0	2	0.0	5.4	0	44	14	58	24.1	0.7	0
6:15-6:30		4	0	4	0.0	10.8	0	58	13	71	18.3	0.9	2
6:30-6:45		2	0	2	0.0	5.4	0	63	13	76	17.1	0.9	5
6:45-7:00		0	0	0	0.0	0.0	0	47	19	66	28.8	0.8	0
1時間計		8	0	8	0.0	21.6	0	212	59	271	21.8	3.3	7
7:00-7:15		0	0	0	0.0	0.0	0	54	19	73	26.0	0.9	2
7:15-7:30		0	0	0	0.0	0.0	0	58	18	76	23.7	0.9	3
7:30-7:45		0	0	0	0.0	0.0	0	75	19	94	20.2	1.1	3
7:45-8:00		0	0	0	0.0	0.0	0	91	19	110	17.3	1.3	1
1時間計		0	0	0	0.0	0.0	0	278	75	353	21.2	4.3	9
8:00-8:15		0	0	0	0.0	0.0	0	128	13	141	9.2	1.7	6
8:15-8:30		0	0	0	0.0	0.0	0	90	11	101	10.9	1.2	5
8:30-8:45		0	0	0	0.0	0.0	0	108	13	121	10.7	1.5	3
8:45-9:00		1	0	1	0.0	2.7	0	109	12	121	9.9	1.5	3
1時間計		1	0	1	0.0	2.7	0	435	49	484	10.1	5.9	17
9:00-9:15		0	0	0	0.0	0.0	0	119	8	127	6.3	1.6	3
9:15-9:30		1	0	1	0.0	2.7	0	105	11	116	9.5	1.4	2
9:30-9:45		0	0	0	0.0	0.0	0	123	17	140	12.1	1.7	1
9:45-10:00		0	0	0	0.0	0.0	0	116	17	133	12.8	1.6	2
1時間計		1	0	1	0.0	2.7	0	463	53	516	10.3	6.3	8
10:00-10:15		0	0	0	0.0	0.0	0	109	19	128	14.8	1.6	3
10:15-10:30		0	0	0	0.0	0.0	0	130	11	141	7.8	1.7	3
10:30-10:45		3	0	3	0.0	8.1	0	131	13	144	9.0	1.8	4
10:45-11:00		0	0	0	0.0	0.0	0	95	15	110	13.6	1.3	6
1時間計		3	0	3	0.0	8.1	0	465	58	523	11.1	6.4	16
11:00-11:15		0	0	0	0.0	0.0	0	105	17	122	13.9	1.5	3
11:15-11:30		0	0	0	0.0	0.0	0	115	9	124	7.3	1.5	4
11:30-11:45		0	0	0	0.0	0.0	1	124	11	135	8.1	1.7	5
11:45-12:00		0	0	0	0.0	0.0	0	101	14	115	12.2	1.4	3
1時間計		0	0	0	0.0	0.0	1	445	51	496	10.3	6.1	15
12:00-12:15		0	0	0	0.0	0.0	0	110	16	126	12.7	1.5	4
12:15-12:30		0	0	0	0.0	0.0	0	121	13	134	9.7	1.6	2
12:30-12:45		0	0	0	0.0	0.0	0	97	19	116	16.4	1.4	2
12:45-13:00		0	0	0	0.0	0.0	0	107	13	120	10.8	1.5	7
1時間計		0	0	0	0.0	0.0	0	435	61	496	12.3	6.1	15
13:00-13:15		1	1	2	50.0	5.4	1	103	7	110	6.4	1.3	8
13:15-13:30		1	1	2	50.0	5.4	0	101	12	113	10.6	1.4	11
13:30-13:45		0	1	1	100.0	2.7	0	108	21	129	16.3	1.6	4
13:45-14:00		1	0	1	0.0	2.7	0	103	9	112	8.0	1.4	3
1時間計		3	3	6	50.0	16.2	1	415	49	464	10.6	5.7	26

方向別自動車交通量調査表

調査地点 : 地域社会3 上川井1C

調査年月日 : 令和元年 5月11日(土) 天候:晴れ時々曇り

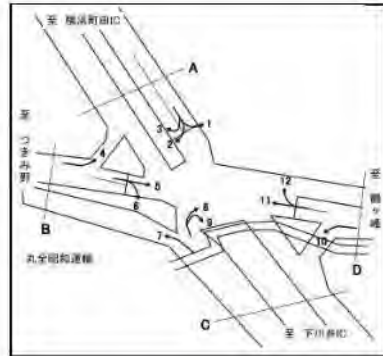

方向 種別 時間帯	9						C 合計 (7+ 8+ 9)					
	小型車 (台)	大型車 (台)	合計 (台)	大型車 混入率 (%)	時 間 係 数 (%)	二輪車 (台)	小型車 (台)	大型車 (台)	合計 (台)	大型車 混入率 (%)	時 間 係 数 (%)	二輪車 (台)
14:00-14:15	0	0	0	0.0	0.0	0	115	14	129	10.9	1.6	3
14:15-14:30	0	0	0	0.0	0.0	0	90	10	100	10.0	1.2	1
14:30-14:45	1	0	1	0.0	2.7	0	141	15	156	9.6	1.9	2
14:45-15:00	0	1	1	100.0	2.7	0	97	16	113	14.2	1.4	2
1時間計	1	1	2	50.0	5.4	0	443	55	498	11.0	6.1	8
15:00-15:15	2	0	2	0.0	5.4	0	111	8	119	6.7	1.5	3
15:15-15:30	0	0	0	0.0	0.0	0	91	18	109	16.5	1.3	5
15:30-15:45	1	0	1	0.0	2.7	0	109	13	122	10.7	1.5	2
15:45-16:00	1	0	1	0.0	2.7	0	108	13	121	10.7	1.5	3
1時間計	4	0	4	0.0	10.8	0	419	52	471	11.0	5.8	13
16:00-16:15	0	0	0	0.0	0.0	1	113	9	122	7.4	1.5	4
16:15-16:30	1	0	1	0.0	2.7	0	124	16	140	11.4	1.7	1
16:30-16:45	0	0	0	0.0	0.0	0	120	12	132	9.1	1.6	4
16:45-17:00	0	0	0	0.0	0.0	1	128	9	137	6.6	1.7	1
1時間計	1	0	1	0.0	2.7	2	485	46	531	8.7	6.5	10
17:00-17:15	1	0	1	0.0	2.7	0	112	12	124	9.7	1.5	3
17:15-17:30	0	0	0	0.0	0.0	0	122	17	139	12.2	1.7	2
17:30-17:45	0	0	0	0.0	0.0	0	127	6	133	4.5	1.6	3
17:45-18:00	0	0	0	0.0	0.0	0	116	11	127	8.7	1.6	7
1時間計	1	0	1	0.0	2.7	0	477	46	523	8.8	6.4	15
18:00-18:15	0	0	0	0.0	0.0	0	96	10	106	9.4	1.3	2
18:15-18:30	0	0	0	0.0	0.0	0	107	11	118	9.3	1.4	2
18:30-18:45	0	0	0	0.0	0.0	0	92	14	106	13.2	1.3	0
18:45-19:00	0	0	0	0.0	0.0	0	80	15	95	15.8	1.2	1
1時間計	0	0	0	0.0	0.0	0	375	50	425	11.8	5.2	5
19:00-19:15	0	0	0	0.0	0.0	1	92	14	106	13.2	1.3	1
19:15-19:30	1	0	1	0.0	2.7	0	68	9	77	11.7	0.9	0
19:30-19:45	0	0	0	0.0	0.0	0	61	13	74	17.6	0.9	2
19:45-20:00	0	0	0	0.0	0.0	0	68	16	84	19.0	1.0	6
1時間計	1	0	1	0.0	2.7	1	289	52	341	15.2	4.2	9
20:00-20:15	0	0	0	0.0	0.0	0	81	9	90	10.0	1.1	1
20:15-20:30	0	0	0	0.0	0.0	0	76	11	87	12.6	1.1	1
20:30-20:45	0	0	0	0.0	0.0	0	61	16	77	20.8	0.9	0
20:45-21:00	0	0	0	0.0	0.0	0	78	18	96	18.8	1.2	0
1時間計	0	0	0	0.0	0.0	0	296	54	350	15.4	4.3	2
21:00-21:15	0	0	0	0.0	0.0	0	63	13	76	17.1	0.9	1
21:15-21:30	0	0	0	0.0	0.0	0	57	12	69	17.4	0.8	1
21:30-21:45	0	0	0	0.0	0.0	0	60	21	81	25.9	1.0	0
21:45-22:00	0	0	0	0.0	0.0	0	55	16	71	22.5	0.9	0
1時間計	0	0	0	0.0	0.0	0	235	62	297	20.9	3.6	2
昼12時間計	15	4	19	21.1	51.4	4	5135	645	5780	11.2	70.7	157
夜12時間計	18	0	18	0.0	48.6	2	1853	547	2400	22.8	29.3	54
全時間合計	33	4	37	10.8	100.0	6	6988	1192	8180	14.6	100.0	211
昼 夜 率	2.20	1.00	1.95	-	-	1.50	1.36	1.85	1.42	-	-	1.34

方向別自動車交通量調査表

調査地点 : 地域社会3 上川井IC

調査年月日 : 令和元年 5月11日(土) 天候:晴れ時々曇り

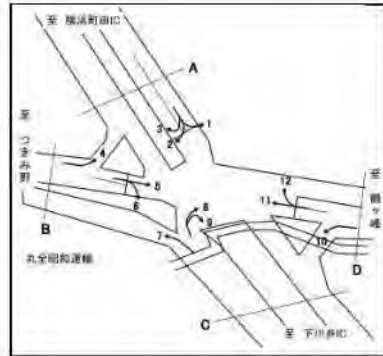

方向	10						11					
	小型車 (台)	大型車 (台)	合計 (台)	大型車 混入率 (%)	時 間 係 数 (%)	二輪車 (台)	小型車 (台)	大型車 (台)	合計 (台)	大型車 混入率 (%)	時 間 係 数 (%)	二輪車 (台)
22:00-22:15	2	0	2	0.0	0.2	0	27	3	30	10.0	0.9	3
22:15-22:30	0	0	0	0.0	0.0	0	18	2	20	10.0	0.6	2
22:30-22:45	1	0	1	0.0	0.1	0	21	2	23	8.7	0.7	3
22:45-23:00	3	0	3	0.0	0.3	0	23	3	26	11.5	0.8	1
1時間計	6	0	6	0.0	0.5	0	89	10	99	10.1	3.0	9
23:00-23:15	4	0	4	0.0	0.4	0	18	1	19	5.3	0.6	2
23:15-23:30	3	0	3	0.0	0.3	0	7	2	9	22.2	0.3	1
23:30-23:45	4	0	4	0.0	0.4	0	20	4	24	16.7	0.7	2
23:45-24:00	3	0	3	0.0	0.3	0	8	3	11	27.3	0.3	3
1時間計	14	0	14	0.0	1.2	0	53	10	63	15.9	1.9	8
0:00- 0:15	3	0	3	0.0	0.3	0	14	4	18	22.2	0.6	6
0:15- 0:30	2	0	2	0.0	0.2	0	3	1	4	25.0	0.1	2
0:30- 0:45	2	0	2	0.0	0.2	0	10	3	13	23.1	0.4	2
0:45- 1:00	1	0	1	0.0	0.1	0	7	1	8	12.5	0.2	0
1時間計	8	0	8	0.0	0.7	0	34	9	43	20.9	1.3	10
1:00- 1:15	0	0	0	0.0	0.0	1	8	3	11	27.3	0.3	1
1:15- 1:30	2	0	2	0.0	0.2	0	4	3	7	42.9	0.2	0
1:30- 1:45	0	0	0	0.0	0.0	0	4	4	8	50.0	0.2	0
1:45- 2:00	1	0	1	0.0	0.1	0	4	0	4	0.0	0.1	1
1時間計	3	0	3	0.0	0.3	1	20	10	30	33.3	0.9	2
2:00- 2:15	0	0	0	0.0	0.0	0	6	1	7	14.3	0.2	0
2:15- 2:30	0	0	0	0.0	0.0	0	6	4	10	40.0	0.3	1
2:30- 2:45	2	0	2	0.0	0.2	0	4	1	5	20.0	0.2	3
2:45- 3:00	1	0	1	0.0	0.1	0	5	1	6	16.7	0.2	0
1時間計	3	0	3	0.0	0.3	0	21	7	28	25.0	0.9	4
3:00- 3:15	1	0	1	0.0	0.1	0	4	0	4	0.0	0.1	0
3:15- 3:30	2	0	2	0.0	0.2	0	7	1	8	12.5	0.2	1
3:30- 3:45	4	1	5	20.0	0.4	0	2	1	3	33.3	0.1	0
3:45- 4:00	0	0	0	0.0	0.0	0	4	0	4	0.0	0.1	0
1時間計	7	1	8	12.5	0.7	0	17	2	19	10.5	0.6	1
4:00- 4:15	2	0	2	0.0	0.2	0	6	5	11	45.5	0.3	3
4:15- 4:30	2	0	2	0.0	0.2	0	4	2	6	33.3	0.2	1
4:30- 4:45	6	0	6	0.0	0.5	0	5	0	5	0.0	0.2	1
4:45- 5:00	0	2	2	100.0	0.2	1	10	0	10	0.0	0.3	3
1時間計	10	2	12	16.7	1.1	1	25	7	32	21.9	1.0	8
5:00- 5:15	6	1	7	14.3	0.6	0	5	0	5	0.0	0.2	2
5:15- 5:30	2	0	2	0.0	0.2	1	10	3	13	23.1	0.4	6
5:30- 5:45	2	1	3	33.3	0.3	0	7	1	8	12.5	0.2	1
5:45- 6:00	4	0	4	0.0	0.4	2	12	2	14	14.3	0.4	2
1時間計	14	2	16	12.5	1.4	3	34	6	40	15.0	1.2	11

方向別自動車交通量調査表

調査地点 : 地域社会3 上川井1C

調査年月日 : 令和元年 5月11日(土) 天候:晴れ時々曇り

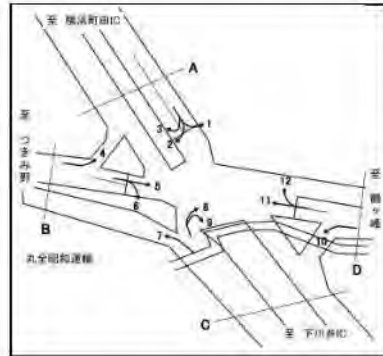

方向 時間帯	10						11					
	種別 小型車 (台)	大型車 (台)	合計 (台)	大型車 混入率 (%)	時間 係数 (%)	二輪車 (台)	小型車 (台)	大型車 (台)	合計 (台)	大型車 混入率 (%)	時間 係数 (%)	二輪車 (台)
6:00-6:15	4	2	6	33.3	0.5	0	12	2	14	14.3	0.4	1
6:15-6:30	8	0	8	0.0	0.7	0	20	4	24	16.7	0.7	3
6:30-6:45	14	1	15	6.7	1.3	0	22	3	25	12.0	0.8	2
6:45-7:00	8	1	9	11.1	0.8	0	30	2	32	6.3	1.0	7
1時間計	34	4	38	10.5	3.4	0	84	11	95	11.6	2.9	13
7:00-7:15	7	1	8	12.5	0.7	1	18	0	18	0.0	0.6	3
7:15-7:30	10	1	11	9.1	1.0	0	25	1	26	3.8	0.8	5
7:30-7:45	10	0	10	0.0	0.9	1	32	3	35	8.6	1.1	4
7:45-8:00	13	0	13	0.0	1.1	0	29	2	31	6.5	0.9	3
1時間計	40	2	42	4.8	3.7	2	104	6	110	5.5	3.4	15
8:00-8:15	19	0	19	0.0	1.7	0	33	0	33	0.0	1.0	7
8:15-8:30	13	0	13	0.0	1.1	0	43	2	45	4.4	1.4	7
8:30-8:45	21	0	21	0.0	1.9	1	44	2	46	4.3	1.4	8
8:45-9:00	10	0	10	0.0	0.9	0	52	2	54	3.7	1.7	9
1時間計	63	0	63	0.0	5.6	1	172	6	178	3.4	5.5	31
9:00-9:15	15	1	16	6.3	1.4	0	59	5	64	7.8	2.0	4
9:15-9:30	18	1	19	5.3	1.7	0	54	2	56	3.6	1.7	11
9:30-9:45	22	1	23	4.3	2.0	0	58	0	58	0.0	1.8	8
9:45-10:00	16	1	17	5.9	1.5	0	49	4	53	7.5	1.6	4
1時間計	71	4	75	5.3	6.6	0	220	11	231	4.8	7.1	27
10:00-10:15	19	2	21	9.5	1.9	1	56	3	59	5.1	1.8	6
10:15-10:30	12	0	12	0.0	1.1	0	64	7	71	9.9	2.2	4
10:30-10:45	24	1	25	4.0	2.2	1	60	3	63	4.8	1.9	7
10:45-11:00	14	1	15	6.7	1.3	0	62	8	70	11.4	2.1	4
1時間計	69	4	73	5.5	6.4	2	242	21	263	8.0	8.1	21
11:00-11:15	16	1	17	5.9	1.5	0	49	4	53	7.5	1.6	10
11:15-11:30	18	0	18	0.0	1.6	0	42	2	44	4.5	1.3	8
11:30-11:45	27	1	28	3.6	2.5	1	53	5	58	8.6	1.8	7
11:45-12:00	18	0	18	0.0	1.6	1	52	3	55	5.5	1.7	4
1時間計	79	2	81	2.5	7.2	2	196	14	210	6.7	6.4	29
12:00-12:15	21	1	22	4.5	1.9	2	39	3	42	7.1	1.3	3
12:15-12:30	21	0	21	0.0	1.9	0	49	5	54	9.3	1.7	1
12:30-12:45	25	0	25	0.0	2.2	1	52	4	56	7.1	1.7	7
12:45-13:00	24	0	24	0.0	2.1	0	47	3	50	6.0	1.5	2
1時間計	91	1	92	1.1	8.1	3	187	15	202	7.4	6.2	13
13:00-13:15	25	3	28	10.7	2.5	1	51	4	55	7.3	1.7	3
13:15-13:30	17	0	17	0.0	1.5	0	52	6	58	10.3	1.8	4
13:30-13:45	18	0	18	0.0	1.6	3	47	1	48	2.1	1.5	4
13:45-14:00	16	1	17	5.9	1.5	0	49	5	54	9.3	1.7	3
1時間計	76	4	80	5.0	7.1	4	199	16	215	7.4	6.6	14

方向別自動車交通量調査表

調査地点 : 地域社会3 上川井IC

調査年月日 : 令和元年 5月11日(土) 天候:晴れ時々曇り

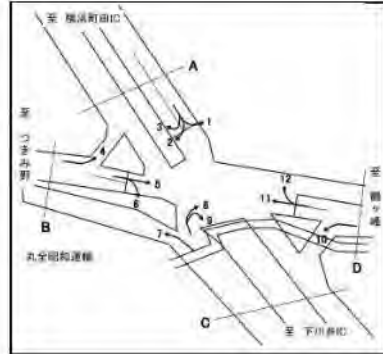

方向 種別 時間帯	10						11					
	小型車 (台)	大型車 (台)	合計 (台)	大型車 混入率 (%)	時間 係数 (%)	二輪車 (台)	小型車 (台)	大型車 (台)	合計 (台)	大型車 混入率 (%)	時間 係数 (%)	二輪車 (台)
14:00-14:15	29	0	29	0.0	2.6	0	57	0	57	0.0	1.7	2
14:15-14:30	28	1	29	3.4	2.6	1	67	2	69	2.9	2.1	10
14:30-14:45	32	0	32	0.0	2.8	1	62	3	65	4.6	2.0	6
14:45-15:00	39	0	39	0.0	3.4	1	59	1	60	1.7	1.8	2
1時間計	128	1	129	0.8	11.4	3	245	6	251	2.4	7.7	20
15:00-15:15	18	0	18	0.0	1.6	0	52	2	54	3.7	1.7	0
15:15-15:30	21	0	21	0.0	1.9	1	56	1	57	1.8	1.7	3
15:30-15:45	14	1	15	6.7	1.3	2	61	4	65	6.2	2.0	4
15:45-16:00	20	0	20	0.0	1.8	1	51	5	56	8.9	1.7	3
1時間計	73	1	74	1.4	6.5	4	220	12	232	5.2	7.1	10
16:00-16:15	16	0	16	0.0	1.4	0	67	1	68	1.5	2.1	2
16:15-16:30	15	0	15	0.0	1.3	0	42	4	46	8.7	1.4	1
16:30-16:45	10	0	10	0.0	0.9	0	56	2	58	3.4	1.8	12
16:45-17:00	15	0	15	0.0	1.3	0	39	1	40	2.5	1.2	6
1時間計	56	0	56	0.0	4.9	0	204	8	212	3.8	6.5	21
17:00-17:15	23	2	25	8.0	2.2	2	50	4	54	7.4	1.7	7
17:15-17:30	19	0	19	0.0	1.7	0	49	2	51	3.9	1.6	6
17:30-17:45	25	1	26	3.8	2.3	0	46	4	50	8.0	1.5	4
17:45-18:00	22	1	23	4.3	2.0	0	48	1	49	2.0	1.5	3
1時間計	89	4	93	4.3	8.2	2	193	11	204	5.4	6.3	20
18:00-18:15	10	0	10	0.0	0.9	0	29	2	31	6.5	0.9	3
18:15-18:30	11	0	11	0.0	1.0	0	52	2	54	3.7	1.7	1
18:30-18:45	12	0	12	0.0	1.1	0	33	1	34	2.9	1.0	3
18:45-19:00	12	0	12	0.0	1.1	0	28	1	29	3.4	0.9	1
1時間計	45	0	45	0.0	4.0	0	142	6	148	4.1	4.5	8
19:00-19:15	14	1	15	6.7	1.3	0	32	2	34	5.9	1.0	3
19:15-19:30	16	1	17	5.9	1.5	0	28	5	33	15.2	1.0	2
19:30-19:45	12	0	12	0.0	1.1	0	25	2	27	7.4	0.8	4
19:45-20:00	15	0	15	0.0	1.3	0	31	0	31	0.0	0.9	4
1時間計	57	2	59	3.4	5.2	0	116	9	125	7.2	3.8	13
20:00-20:15	13	0	13	0.0	1.1	0	30	3	33	9.1	1.0	3
20:15-20:30	12	0	12	0.0	1.1	0	20	3	23	13.0	0.7	5
20:30-20:45	10	0	10	0.0	0.9	0	31	3	34	8.8	1.0	3
20:45-21:00	11	0	11	0.0	1.0	0	23	2	25	8.0	0.8	0
1時間計	46	0	46	0.0	4.1	0	104	11	115	9.6	3.5	11
21:00-21:15	5	0	5	0.0	0.4	0	41	1	42	2.4	1.3	2
21:15-21:30	4	0	4	0.0	0.4	0	29	2	31	6.5	0.9	4
21:30-21:45	6	0	6	0.0	0.5	0	19	7	26	26.9	0.8	2
21:45-22:00	1	0	1	0.0	0.1	0	20	0	20	0.0	0.6	2
1時間計	16	0	16	0.0	1.4	0	109	10	119	8.4	3.6	10
昼12時間計	880	23	903	2.5	79.8	23	2324	132	2456	5.4	75.2	229
夜12時間計	218	11	229	4.8	20.2	5	706	102	808	12.6	24.8	100
全時間合計	1098	34	1132	3.0	100.0	28	3030	234	3264	7.2	100.0	329
昼夜率	1.25	1.48	1.25	-	-	1.22	1.30	1.77	1.33	-	-	1.44

方向別自動車交通量調査表

調査地点 : 地域社会3 上川井IC

調査年月日 : 令和元年 5月11日(土) 天候:晴れ時々曇り

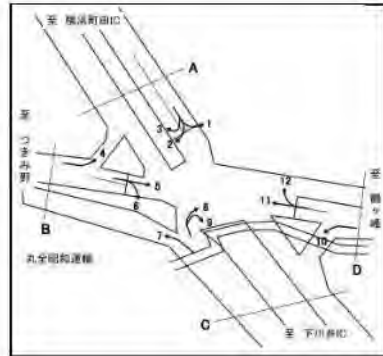

方向 種別 時間帯	12						D 合計 (10+11+12)					
	小型車 (台)	大型車 (台)	合計 (台)	大型車 混入率 (%)	時間 係数 (%)	二輪車 (台)	小型車 (台)	大型車 (台)	合計 (台)	大型車 混入率 (%)	時間 係数 (%)	二輪車 (台)
22:00-22:15	7	0	7	0.0	0.4	0	36	3	39	7.7	0.6	3
22:15-22:30	10	0	10	0.0	0.6	1	28	2	30	6.7	0.5	3
22:30-22:45	8	1	9	11.1	0.5	1	30	3	33	9.1	0.5	4
22:45-23:00	19	0	19	0.0	1.1	1	45	3	48	6.3	0.8	2
1時間計	44	1	45	2.2	2.6	3	139	11	150	7.3	2.4	12
23:00-23:15	1	0	1	0.0	0.1	1	23	1	24	4.2	0.4	3
23:15-23:30	6	3	9	33.3	0.5	1	16	5	21	23.8	0.3	2
23:30-23:45	8	0	8	0.0	0.5	0	32	4	36	11.1	0.6	2
23:45-24:00	2	0	2	0.0	0.1	0	13	3	16	18.8	0.3	3
1時間計	17	3	20	15.0	1.1	2	84	13	97	13.4	1.6	10
0:00- 0:15	2	2	4	50.0	0.2	0	19	6	25	24.0	0.4	6
0:15- 0:30	4	0	4	0.0	0.2	0	9	1	10	10.0	0.2	2
0:30- 0:45	5	2	7	28.6	0.4	0	17	5	22	22.7	0.4	2
0:45- 1:00	7	0	7	0.0	0.4	0	15	1	16	6.3	0.3	0
1時間計	18	4	22	18.2	1.3	0	60	13	73	17.8	1.2	10
1:00- 1:15	3	0	3	0.0	0.2	0	11	3	14	21.4	0.2	2
1:15- 1:30	2	3	5	60.0	0.3	1	8	6	14	42.9	0.2	1
1:30- 1:45	0	1	1	100.0	0.1	1	4	5	9	55.6	0.1	1
1:45- 2:00	1	0	1	0.0	0.1	0	6	0	6	0.0	0.1	1
1時間計	6	4	10	40.0	0.6	2	29	14	43	32.6	0.7	5
2:00- 2:15	4	0	4	0.0	0.2	0	10	1	11	9.1	0.2	0
2:15- 2:30	4	0	4	0.0	0.2	0	10	4	14	28.6	0.2	1
2:30- 2:45	4	1	5	20.0	0.3	1	10	2	12	16.7	0.2	4
2:45- 3:00	2	0	2	0.0	0.1	1	8	1	9	11.1	0.1	1
1時間計	14	1	15	6.7	0.9	2	38	8	46	17.4	0.7	6
3:00- 3:15	3	1	4	25.0	0.2	2	8	1	9	11.1	0.1	2
3:15- 3:30	1	0	1	0.0	0.1	0	10	1	11	9.1	0.2	1
3:30- 3:45	3	1	4	25.0	0.2	0	9	3	12	25.0	0.2	0
3:45- 4:00	1	1	2	50.0	0.1	0	5	1	6	16.7	0.1	0
1時間計	8	3	11	27.3	0.6	2	32	6	38	15.8	0.6	3
4:00- 4:15	4	1	5	20.0	0.3	2	12	6	18	33.3	0.3	5
4:15- 4:30	4	4	8	50.0	0.5	0	10	6	16	37.5	0.3	1
4:30- 4:45	1	2	3	66.7	0.2	0	12	2	14	14.3	0.2	1
4:45- 5:00	7	0	7	0.0	0.4	0	17	2	19	10.5	0.3	4
1時間計	16	7	23	30.4	1.3	2	51	16	67	23.9	1.1	11
5:00- 5:15	9	2	11	18.2	0.6	1	20	3	23	13.0	0.4	3
5:15- 5:30	4	3	7	42.9	0.4	0	16	6	22	27.3	0.4	7
5:30- 5:45	7	2	9	22.2	0.5	5	16	4	20	20.0	0.3	6
5:45- 6:00	6	1	7	14.3	0.4	1	22	3	25	12.0	0.4	5
1時間計	26	8	34	23.5	1.9	7	74	16	90	17.8	1.5	21

方向別自動車交通量調査表

調査地点 : 地域社会3 上川井1C

調査年月日 : 令和元年 5月11日(土) 天候:晴れ時々曇り

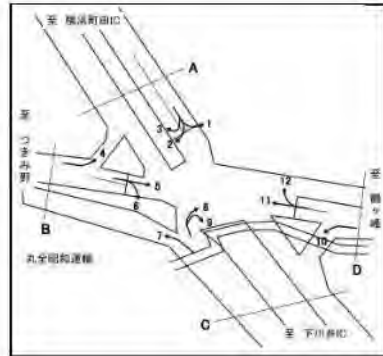

方向 時間帯	12						D 合計 (10+11+12)					
	種別 小型車 (台)	大型車 (台)	合計 (台)	大型車 混入率 (%)	時間 係数 (%)	二輪車 (台)	小型車 (台)	大型車 (台)	合計 (台)	大型車 混入率 (%)	時間 係数 (%)	二輪車 (台)
6:00-6:15	9	1	10	10.0	0.6	0	25	5	30	16.7	0.5	1
6:15-6:30	12	1	13	7.7	0.7	0	40	5	45	11.1	0.7	3
6:30-6:45	9	0	9	0.0	0.5	9	45	4	49	8.2	0.8	11
6:45-7:00	13	2	15	13.3	0.9	0	51	5	56	8.9	0.9	7
1時間計	43	4	47	8.5	2.7	9	161	19	180	10.6	2.9	22
7:00-7:15	21	6	27	22.2	1.5	3	46	7	53	13.2	0.9	7
7:15-7:30	23	1	24	4.2	1.4	5	58	3	61	4.9	1.0	10
7:30-7:45	21	1	22	4.5	1.3	5	63	4	67	6.0	1.1	10
7:45-8:00	16	1	17	5.9	1.0	5	58	3	61	4.9	1.0	8
1時間計	81	9	90	10.0	5.1	18	225	17	242	7.0	3.9	35
8:00-8:15	22	3	25	12.0	1.4	1	74	3	77	3.9	1.3	8
8:15-8:30	28	0	28	0.0	1.6	1	84	2	86	2.3	1.4	8
8:30-8:45	25	0	25	0.0	1.4	2	90	2	92	2.2	1.5	11
8:45-9:00	21	2	23	8.7	1.3	2	83	4	87	4.6	1.4	11
1時間計	96	5	101	5.0	5.7	6	331	11	342	3.2	5.6	38
9:00-9:15	30	1	31	3.2	1.8	3	104	7	111	6.3	1.8	7
9:15-9:30	19	1	20	5.0	1.1	10	91	4	95	4.2	1.5	21
9:30-9:45	24	3	27	11.1	1.5	4	104	4	108	3.7	1.8	12
9:45-10:00	27	1	28	3.6	1.6	1	92	6	98	6.1	1.6	5
1時間計	100	6	106	5.7	6.0	18	391	21	412	5.1	6.7	45
10:00-10:15	28	0	28	0.0	1.6	5	103	5	108	4.6	1.8	12
10:15-10:30	42	0	42	0.0	2.4	4	118	7	125	5.6	2.0	8
10:30-10:45	30	1	31	3.2	1.8	1	114	5	119	4.2	1.9	9
10:45-11:00	29	4	33	12.1	1.9	3	105	13	118	11.0	1.9	7
1時間計	129	5	134	3.7	7.6	13	440	30	470	6.4	7.6	36
11:00-11:15	27	3	30	10.0	1.7	5	92	8	100	8.0	1.6	15
11:15-11:30	28	3	31	9.7	1.8	1	88	5	93	5.4	1.5	9
11:30-11:45	28	1	29	3.4	1.6	3	108	7	115	6.1	1.9	11
11:45-12:00	23	3	26	11.5	1.5	1	93	6	99	6.1	1.6	6
1時間計	106	10	116	8.6	6.6	10	381	26	407	6.4	6.6	41
12:00-12:15	27	6	33	18.2	1.9	4	87	10	97	10.3	1.6	9
12:15-12:30	28	2	30	6.7	1.7	3	98	7	105	6.7	1.7	4
12:30-12:45	32	2	34	5.9	1.9	5	109	6	115	5.2	1.9	13
12:45-13:00	20	1	21	4.8	1.2	0	91	4	95	4.2	1.5	2
1時間計	107	11	118	9.3	6.7	12	385	27	412	6.6	6.7	28
13:00-13:15	25	3	28	10.7	1.6	1	101	10	111	9.0	1.8	5
13:15-13:30	30	3	33	9.1	1.9	0	99	9	108	8.3	1.8	4
13:30-13:45	34	0	34	0.0	1.9	1	99	1	100	1.0	1.6	8
13:45-14:00	16	1	17	5.9	1.0	4	81	7	88	8.0	1.4	7
1時間計	105	7	112	6.3	6.4	6	380	27	407	6.6	6.6	24

方向別自動車交通量調査表

調査地点 : 地域社会3 上川井1C

調査年月日 : 令和元年 5月11日(土) 天候:晴れ時々曇り

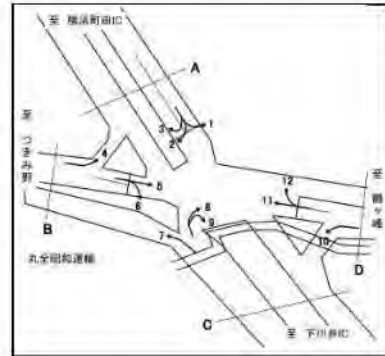

方向 種別 時間帯	12						D 合計 (10+11+12)					
	小型車 (台)	大型車 (台)	合計 (台)	大型車 混入率 (%)	時間 係数 (%)	二輪車 (台)	小型車 (台)	大型車 (台)	合計 (台)	大型車 混入率 (%)	時間 係数 (%)	二輪車 (台)
14:00-14:15	28	0	28	0.0	1.6	0	114	0	114	0.0	1.9	2
14:15-14:30	22	3	25	12.0	1.4	2	117	6	123	4.9	2.0	13
14:30-14:45	38	2	40	5.0	2.3	7	132	5	137	3.6	2.2	14
14:45-15:00	31	2	33	6.1	1.9	2	129	3	132	2.3	2.1	5
1時間計	119	7	126	5.6	7.2	11	492	14	506	2.8	8.2	34
15:00-15:15	28	1	29	3.4	1.6	2	98	3	101	3.0	1.6	2
15:15-15:30	23	1	24	4.2	1.4	9	100	2	102	2.0	1.7	13
15:30-15:45	25	3	28	10.7	1.6	1	100	8	108	7.4	1.8	7
15:45-16:00	28	3	31	9.7	1.8	2	99	8	107	7.5	1.7	6
1時間計	104	8	112	7.1	6.4	14	397	21	418	5.0	6.8	28
16:00-16:15	25	1	26	3.8	1.5	3	108	2	110	1.8	1.8	5
16:15-16:30	26	0	26	0.0	1.5	4	83	4	87	4.6	1.4	5
16:30-16:45	27	2	29	6.9	1.6	3	93	4	97	4.1	1.6	15
16:45-17:00	50	3	53	5.7	3.0	6	104	4	108	3.7	1.8	12
1時間計	128	6	134	4.5	7.6	16	388	14	402	3.5	6.5	37
17:00-17:15	45	0	45	0.0	2.6	4	118	6	124	4.8	2.0	13
17:15-17:30	38	1	39	2.6	2.2	2	106	3	109	2.8	1.8	8
17:30-17:45	31	1	32	3.1	1.8	3	102	6	108	5.6	1.8	7
17:45-18:00	24	0	24	0.0	1.4	1	94	2	96	2.1	1.6	4
1時間計	138	2	140	1.4	8.0	10	420	17	437	3.9	7.1	32
18:00-18:15	18	0	18	0.0	1.0	1	57	2	59	3.4	1.0	4
18:15-18:30	18	0	18	0.0	1.0	0	81	2	83	2.4	1.3	1
18:30-18:45	17	1	18	5.6	1.0	2	62	2	64	3.1	1.0	5
18:45-19:00	19	3	22	13.6	1.3	2	59	4	63	6.3	1.0	3
1時間計	72	4	76	5.3	4.3	5	259	10	269	3.7	4.4	13
19:00-19:15	16	0	16	0.0	0.9	0	62	3	65	4.6	1.1	3
19:15-19:30	17	1	18	5.6	1.0	1	61	7	68	10.3	1.1	3
19:30-19:45	16	0	16	0.0	0.9	3	53	2	55	3.6	0.9	7
19:45-20:00	15	2	17	11.8	1.0	5	61	2	63	3.2	1.0	9
1時間計	64	3	67	4.5	3.8	9	237	14	251	5.6	4.1	22
20:00-20:15	22	1	23	4.3	1.3	5	65	4	69	5.8	1.1	8
20:15-20:30	12	1	13	7.7	0.7	1	44	4	48	8.3	0.8	6
20:30-20:45	10	2	12	16.7	0.7	1	51	5	56	8.9	0.9	4
20:45-21:00	11	0	11	0.0	0.6	2	45	2	47	4.3	0.8	2
1時間計	55	4	59	6.8	3.4	9	205	15	220	6.8	3.6	20
21:00-21:15	7	1	8	12.5	0.5	1	53	2	55	3.6	0.9	3
21:15-21:30	7	0	7	0.0	0.4	0	40	2	42	4.8	0.7	4
21:30-21:45	17	1	18	5.6	1.0	1	42	8	50	16.0	0.8	3
21:45-22:00	8	0	8	0.0	0.5	0	29	0	29	0.0	0.5	2
1時間計	39	2	41	4.9	2.3	2	164	12	176	6.8	2.9	12
昼12時間計	1285	80	1365	5.9	77.6	139	4489	235	4724	5.0	76.8	391
夜12時間計	350	44	394	11.2	22.4	49	1274	157	1431	11.0	23.2	154
全時間合計	1635	124	1759	7.0	100.0	188	5763	392	6155	6.4	100.0	545
昼夜率	1.27	1.55	1.29	-	-	1.35	1.28	1.67	1.30	-	-	1.39

方向別自動車交通量調査表

調査地点：地域社会4 滝沢

調査年月日：令和2年9月26日(土) 天候：晴れ一時雨



方向 種別 時間帯	1						2					
	小型車 (台)	大型車 (台)	合計 (台)	大型車 混入率 (%)	時間 係数 (%)	二輪車 (台)	小型車 (台)	大型車 (台)	合計 (台)	大型車 混入率 (%)	時間 係数 (%)	二輪車 (台)
22:00-22:15	8	0	8	0.0	0.4	1	30	2	32	6.3	0.6	3
22:15-22:30	9	0	9	0.0	0.5	0	29	1	30	3.3	0.5	0
22:30-22:45	14	1	15	6.7	0.8	1	21	1	22	4.5	0.4	2
22:45-23:00	7	1	8	12.5	0.4	0	20	1	21	4.8	0.4	0
1時間計	38	2	40	5.0	2.2	2	100	5	105	4.8	1.9	5
23:00-23:15	12	0	12	0.0	0.7	0	20	6	26	23.1	0.5	6
23:15-23:30	8	1	9	11.1	0.5	0	21	1	22	4.5	0.4	0
23:30-23:45	7	0	7	0.0	0.4	1	17	3	20	15.0	0.4	1
23:45-24:00	4	1	5	20.0	0.3	1	20	1	21	4.8	0.4	1
1時間計	31	2	33	6.1	1.8	2	78	11	89	12.4	1.6	8
0:00-0:15	3	0	3	0.0	0.2	0	21	0	21	0.0	0.4	1
0:15-0:30	5	0	5	0.0	0.3	0	16	3	19	15.8	0.3	0
0:30-0:45	1	0	1	0.0	0.1	0	11	3	14	21.4	0.2	0
0:45-1:00	5	3	8	37.5	0.4	0	15	4	19	21.1	0.3	1
1時間計	14	3	17	17.6	0.9	0	63	10	73	13.7	1.3	2
1:00-1:15	6	0	6	0.0	0.3	0	9	4	13	30.8	0.2	1
1:15-1:30	4	1	5	20.0	0.3	1	9	2	11	18.2	0.2	1
1:30-1:45	4	1	5	20.0	0.3	1	6	1	7	14.3	0.1	0
1:45-2:00	6	0	6	0.0	0.3	0	8	3	11	27.3	0.2	4
1時間計	20	2	22	9.1	1.2	2	32	10	42	23.8	0.7	6
2:00-2:15	6	0	6	0.0	0.3	0	6	3	9	33.3	0.2	0
2:15-2:30	1	1	2	50.0	0.1	1	10	3	13	23.1	0.2	0
2:30-2:45	4	0	4	0.0	0.2	0	9	1	10	10.0	0.2	0
2:45-3:00	7	0	7	0.0	0.4	0	8	0	8	0.0	0.1	2
1時間計	18	1	19	5.3	1.0	1	33	7	40	17.5	0.7	2
3:00-3:15	3	1	4	25.0	0.2	0	3	0	3	0.0	0.1	0
3:15-3:30	2	0	2	0.0	0.1	0	1	1	2	50.0	0.0	1
3:30-3:45	0	0	0	0.0	0.0	0	6	0	6	0.0	0.1	3
3:45-4:00	3	0	3	0.0	0.2	0	7	3	10	30.0	0.2	1
1時間計	8	1	9	11.1	0.5	0	17	4	21	19.0	0.4	5
4:00-4:15	0	1	1	100.0	0.1	0	7	1	8	12.5	0.1	0
4:15-4:30	4	1	5	20.0	0.3	0	8	0	8	0.0	0.1	0
4:30-4:45	4	0	4	0.0	0.2	1	10	0	10	0.0	0.2	0
4:45-5:00	3	0	3	0.0	0.2	0	8	0	8	0.0	0.1	3
1時間計	11	2	13	15.4	0.7	1	33	1	34	2.9	0.6	3
5:00-5:15	9	0	9	0.0	0.5	0	9	0	9	0.0	0.2	1
5:15-5:30	3	0	3	0.0	0.2	0	12	2	14	14.3	0.2	1
5:30-5:45	2	0	2	0.0	0.1	0	20	6	26	23.1	0.5	2
5:45-6:00	7	0	7	0.0	0.4	1	19	1	20	5.0	0.4	0
1時間計	21	0	21	0.0	1.1	1	60	9	69	13.0	1.2	4

方向別自動車交通量調査表

調査地点 : 地域社会 4 滝沢

調査年月日 : 令和 2年 9月26日(土) 天候:晴れ一時雨



方向 時間帯	1						2					
	種別 小型車 (台)	大型車 (台)	合計 (台)	大型車 混入率 (%)	時間 係数 (%)	二輪車 (台)	小型車 (台)	大型車 (台)	合計 (台)	大型車 混入率 (%)	時間 係数 (%)	二輪車 (台)
6:00-6:15	3	0	3	0.0	0.2	0	36	3	39	7.7	0.7	4
6:15-6:30	8	0	8	0.0	0.4	0	35	2	37	5.4	0.7	2
6:30-6:45	7	0	7	0.0	0.4	2	50	1	51	2.0	0.9	2
6:45-7:00	11	1	12	8.3	0.7	0	31	5	36	13.9	0.6	0
1時間計	29	1	30	3.3	1.6	2	152	11	163	6.7	2.9	8
7:00-7:15	11	4	15	26.7	0.8	1	55	8	63	12.7	1.1	4
7:15-7:30	12	1	13	7.7	0.7	0	43	8	51	15.7	0.9	5
7:30-7:45	19	1	20	5.0	1.1	2	77	10	87	11.5	1.6	8
7:45-8:00	17	0	17	0.0	0.9	1	65	4	69	5.8	1.2	9
1時間計	59	6	65	9.2	3.5	4	240	30	270	11.1	4.8	26
8:00-8:15	16	1	17	5.9	0.9	2	79	7	86	8.1	1.5	13
8:15-8:30	14	0	14	0.0	0.8	2	83	7	90	7.8	1.6	1
8:30-8:45	21	3	24	12.5	1.3	2	92	3	95	3.2	1.7	7
8:45-9:00	33	0	33	0.0	1.8	0	73	0	73	0.0	1.3	7
1時間計	84	4	88	4.5	4.8	6	327	17	344	4.9	6.1	28
9:00-9:15	20	1	21	4.8	1.1	0	69	5	74	6.8	1.3	7
9:15-9:30	20	1	21	4.8	1.1	1	61	5	66	7.6	1.2	3
9:30-9:45	24	1	25	4.0	1.4	0	80	6	86	7.0	1.5	9
9:45-10:00	29	2	31	6.5	1.7	2	99	2	101	2.0	1.8	7
1時間計	93	5	98	5.1	5.3	3	309	18	327	5.5	5.8	26
10:00-10:15	22	2	24	8.3	1.3	0	98	6	104	5.8	1.9	3
10:15-10:30	28	2	30	6.7	1.6	1	89	6	95	6.3	1.7	9
10:30-10:45	37	0	37	0.0	2.0	2	77	4	81	4.9	1.4	3
10:45-11:00	28	0	28	0.0	1.5	2	105	9	114	7.9	2.0	8
1時間計	115	4	119	3.4	6.5	5	369	25	394	6.3	7.0	23
11:00-11:15	34	3	37	8.1	2.0	1	88	5	93	5.4	1.7	10
11:15-11:30	30	1	31	3.2	1.7	1	111	6	117	5.1	2.1	3
11:30-11:45	32	1	33	3.0	1.8	1	97	3	100	3.0	1.8	3
11:45-12:00	37	3	40	7.5	2.2	0	94	1	95	1.1	1.7	7
1時間計	133	8	141	5.7	7.7	3	390	15	405	3.7	7.2	23
12:00-12:15	28	1	29	3.4	1.6	2	90	4	94	4.3	1.7	7
12:15-12:30	31	1	32	3.1	1.7	0	98	4	102	3.9	1.8	2
12:30-12:45	37	2	39	5.1	2.1	2	83	6	89	6.7	1.6	10
12:45-13:00	26	0	26	0.0	1.4	0	110	4	114	3.5	2.0	5
1時間計	122	4	126	3.2	6.9	4	381	18	399	4.5	7.1	24
13:00-13:15	34	0	34	0.0	1.9	1	92	2	94	2.1	1.7	6
13:15-13:30	35	2	37	5.4	2.0	0	99	2	101	2.0	1.8	6
13:30-13:45	32	0	32	0.0	1.7	3	95	3	98	3.1	1.7	3
13:45-14:00	39	2	41	4.9	2.2	1	108	6	114	5.3	2.0	8
1時間計	140	4	144	2.8	7.8	5	394	13	407	3.2	7.3	23

方向別自動車交通量調査表

調査地点：地域社会4 滝沢

調査年月日：令和2年9月26日(土) 天候：晴れ一時雨



方向 種別 時間帯	1						2					
	小型車 (台)	大型車 (台)	合計 (台)	大型車 混入率 (%)	時間 係数 (%)	二輪車 (台)	小型車 (台)	大型車 (台)	合計 (台)	大型車 混入率 (%)	時間 係数 (%)	二輪車 (台)
14:00-14:15	30	3	33	9.1	1.8	0	99	6	105	5.7	1.9	6
14:15-14:30	30	4	34	11.8	1.9	1	87	4	91	4.4	1.6	12
14:30-14:45	32	0	32	0.0	1.7	1	103	8	111	7.2	2.0	9
14:45-15:00	29	4	33	12.1	1.8	1	80	2	82	2.4	1.5	7
1時間計	121	11	132	8.3	7.2	3	369	20	389	5.1	6.9	34
15:00-15:15	37	1	38	2.6	2.1	1	95	3	98	3.1	1.7	6
15:15-15:30	44	2	46	4.3	2.5	5	80	7	87	8.0	1.6	7
15:30-15:45	26	1	27	3.7	1.5	2	87	4	91	4.4	1.6	9
15:45-16:00	34	2	36	5.6	2.0	5	78	6	84	7.1	1.5	7
1時間計	141	6	147	4.1	8.0	13	340	20	360	5.6	6.4	29
16:00-16:15	26	1	27	3.7	1.5	0	93	5	98	5.1	1.7	4
16:15-16:30	31	0	31	0.0	1.7	1	82	2	84	2.4	1.5	16
16:30-16:45	36	0	36	0.0	2.0	0	111	4	115	3.5	2.1	12
16:45-17:00	30	0	30	0.0	1.6	1	76	4	80	5.0	1.4	6
1時間計	123	1	124	0.8	6.8	2	362	15	377	4.0	6.7	38
17:00-17:15	38	0	38	0.0	2.1	2	84	4	88	4.5	1.6	4
17:15-17:30	29	1	30	3.3	1.6	0	73	4	77	5.2	1.4	4
17:30-17:45	34	1	35	2.9	1.9	2	104	4	108	3.7	1.9	6
17:45-18:00	23	1	24	4.2	1.3	5	71	2	73	2.7	1.3	9
1時間計	124	3	127	2.4	6.9	9	332	14	346	4.0	6.2	23
18:00-18:15	30	1	31	3.2	1.7	2	83	5	88	5.7	1.6	5
18:15-18:30	19	0	19	0.0	1.0	0	61	1	62	1.6	1.1	4
18:30-18:45	24	0	24	0.0	1.3	0	73	5	78	6.4	1.4	6
18:45-19:00	18	0	18	0.0	1.0	0	81	1	82	1.2	1.5	4
1時間計	91	1	92	1.1	5.0	2	298	12	310	3.9	5.5	19
19:00-19:15	22	1	23	4.3	1.3	1	71	4	75	5.3	1.3	4
19:15-19:30	25	0	25	0.0	1.4	2	82	1	83	1.2	1.5	4
19:30-19:45	25	0	25	0.0	1.4	1	57	4	61	6.6	1.1	4
19:45-20:00	23	1	24	4.2	1.3	0	55	2	57	3.5	1.0	2
1時間計	95	2	97	2.1	5.3	4	265	11	276	4.0	4.9	14
20:00-20:15	14	0	14	0.0	0.8	0	56	2	58	3.4	1.0	4
20:15-20:30	29	0	29	0.0	1.6	0	47	2	49	4.1	0.9	5
20:30-20:45	10	1	11	9.1	0.6	1	54	2	56	3.6	1.0	2
20:45-21:00	19	0	19	0.0	1.0	1	40	0	40	0.0	0.7	5
1時間計	72	1	73	1.4	4.0	2	197	6	203	3.0	3.6	16
21:00-21:15	12	1	13	7.7	0.7	0	45	0	45	0.0	0.8	1
21:15-21:30	18	0	18	0.0	1.0	1	36	1	37	2.7	0.7	2
21:30-21:45	12	1	13	7.7	0.7	0	37	2	39	5.1	0.7	1
21:45-22:00	13	1	14	7.1	0.8	1	38	2	40	5.0	0.7	2
1時間計	55	3	58	5.2	3.2	2	156	5	161	3.1	2.9	6
昼12時間計	1346	57	1403	4.1	76.5	59	4111	217	4328	5.0	77.2	316
夜12時間計	412	20	432	4.6	23.5	19	1186	90	1276	7.1	22.8	79
全時間合計	1758	77	1835	4.2	100.0	78	5297	307	5604	5.5	100.0	395
昼夜率	1.31	1.35	1.31	-	-	1.32	1.29	1.41	1.29	-	-	1.25

方向別自動車交通量調査表

調査地点：地域社会4 滝沢

調査年月日：令和2年9月26日(土) 天候：晴れ一時雨



方向 種別 時間帯							A 合計 (1+2)					
	小型車 (台)	大型車 (台)	合計 (台)	大型車 混入率 (%)	時間 係数 (%)	二輪車 (台)	小型車 (台)	大型車 (台)	合計 (台)	大型車 混入率 (%)	時間 係数 (%)	二輪車 (台)
22:00-22:15							38	2	40	5.0	0.5	4
22:15-22:30							38	1	39	2.6	0.5	0
22:30-22:45							35	2	37	5.4	0.5	3
22:45-23:00							27	2	29	6.9	0.4	0
1時間計							138	7	145	4.8	1.9	7
23:00-23:15							32	6	38	15.8	0.5	6
23:15-23:30							29	2	31	6.5	0.4	0
23:30-23:45							24	3	27	11.1	0.4	2
23:45-24:00							24	2	26	7.7	0.3	2
1時間計							109	13	122	10.7	1.6	10
0:00-0:15							24	0	24	0.0	0.3	1
0:15-0:30							21	3	24	12.5	0.3	0
0:30-0:45							12	3	15	20.0	0.2	0
0:45-1:00							20	7	27	25.9	0.4	1
1時間計							77	13	90	14.4	1.2	2
1:00-1:15							15	4	19	21.1	0.3	1
1:15-1:30							13	3	16	18.8	0.2	2
1:30-1:45							10	2	12	16.7	0.2	1
1:45-2:00							14	3	17	17.6	0.2	4
1時間計							52	12	64	18.8	0.9	8
2:00-2:15							12	3	15	20.0	0.2	0
2:15-2:30							11	4	15	26.7	0.2	1
2:30-2:45							13	1	14	7.1	0.2	0
2:45-3:00							15	0	15	0.0	0.2	2
1時間計							51	8	59	13.6	0.8	3
3:00-3:15							6	1	7	14.3	0.1	0
3:15-3:30							3	1	4	25.0	0.1	1
3:30-3:45							6	0	6	0.0	0.1	3
3:45-4:00							10	3	13	23.1	0.2	1
1時間計							25	5	30	16.7	0.4	5
4:00-4:15							7	2	9	22.2	0.1	0
4:15-4:30							12	1	13	7.7	0.2	0
4:30-4:45							14	0	14	0.0	0.2	1
4:45-5:00							11	0	11	0.0	0.1	3
1時間計							44	3	47	6.4	0.6	4
5:00-5:15							18	0	18	0.0	0.2	1
5:15-5:30							15	2	17	11.8	0.2	1
5:30-5:45							22	6	28	21.4	0.4	2
5:45-6:00							26	1	27	3.7	0.4	1
1時間計							81	9	90	10.0	1.2	5

方向別自動車交通量調査表

調査地点：地域社会4 滝沢

調査年月日：令和2年9月26日(土) 天候：晴れ一時雨



時間帯	方向 種別						A 合計 (1+2)					
		小型車 (台)	大型車 (台)	合計 (台)	大型車 混入率 (%)	時間 係数 (%)	二輪車 (台)	小型車 (台)	大型車 (台)	合計 (台)	大型車 混入率 (%)	時間 係数 (%)
6:00-6:15							39	3	42	7.1	0.6	4
6:15-6:30							43	2	45	4.4	0.6	2
6:30-6:45							57	1	58	1.7	0.8	4
6:45-7:00							42	6	48	12.5	0.6	0
1時間計							181	12	193	6.2	2.6	10
7:00-7:15							66	12	78	15.4	1.0	5
7:15-7:30							55	9	64	14.1	0.9	5
7:30-7:45							96	11	107	10.3	1.4	10
7:45-8:00							82	4	86	4.7	1.2	10
1時間計							299	36	335	10.7	4.5	30
8:00-8:15							95	8	103	7.8	1.4	15
8:15-8:30							97	7	104	6.7	1.4	3
8:30-8:45							113	6	119	5.0	1.6	9
8:45-9:00							106	0	106	0.0	1.4	7
1時間計							411	21	432	4.9	5.8	34
9:00-9:15							89	6	95	6.3	1.3	7
9:15-9:30							81	6	87	6.9	1.2	4
9:30-9:45							104	7	111	6.3	1.5	9
9:45-10:00							128	4	132	3.0	1.8	9
1時間計							402	23	425	5.4	5.7	29
10:00-10:15							120	8	128	6.3	1.7	3
10:15-10:30							117	8	125	6.4	1.7	10
10:30-10:45							114	4	118	3.4	1.6	5
10:45-11:00							133	9	142	6.3	1.9	10
1時間計							484	29	513	5.7	6.9	28
11:00-11:15							122	8	130	6.2	1.7	11
11:15-11:30							141	7	148	4.7	2.0	4
11:30-11:45							129	4	133	3.0	1.8	4
11:45-12:00							131	4	135	3.0	1.8	7
1時間計							523	23	546	4.2	7.3	26
12:00-12:15							118	5	123	4.1	1.7	9
12:15-12:30							129	5	134	3.7	1.8	2
12:30-12:45							120	8	128	6.3	1.7	12
12:45-13:00							136	4	140	2.9	1.9	5
1時間計							503	22	525	4.2	7.1	28
13:00-13:15							126	2	128	1.6	1.7	7
13:15-13:30							134	4	138	2.9	1.9	6
13:30-13:45							127	3	130	2.3	1.7	6
13:45-14:00							147	8	155	5.2	2.1	9
1時間計							534	17	551	3.1	7.4	28

方向別自動車交通量調査表

調査地点：地域社会4 滝沢

調査年月日：令和2年9月26日(土) 天候：晴れ一時雨



方向 種別 時間帯							A 合計 (1+2)					
	小型車 (台)	大型車 (台)	合計 (台)	大型車 混入率 (%)	時間 係数 (%)	二輪車 (台)	小型車 (台)	大型車 (台)	合計 (台)	大型車 混入率 (%)	時間 係数 (%)	二輪車 (台)
14:00-14:15							129	9	138	6.5	1.9	6
14:15-14:30							117	8	125	6.4	1.7	13
14:30-14:45							135	8	143	5.6	1.9	10
14:45-15:00							109	6	115	5.2	1.5	8
1時間計							490	31	521	6.0	7.0	37
15:00-15:15							132	4	136	2.9	1.8	7
15:15-15:30							124	9	133	6.8	1.8	12
15:30-15:45							113	5	118	4.2	1.6	11
15:45-16:00							112	8	120	6.7	1.6	12
1時間計							481	26	507	5.1	6.8	42
16:00-16:15							119	6	125	4.8	1.7	4
16:15-16:30							113	2	115	1.7	1.5	17
16:30-16:45							147	4	151	2.6	2.0	12
16:45-17:00							106	4	110	3.6	1.5	7
1時間計							485	16	501	3.2	6.7	40
17:00-17:15							122	4	126	3.2	1.7	6
17:15-17:30							102	5	107	4.7	1.4	4
17:30-17:45							138	5	143	3.5	1.9	8
17:45-18:00							94	3	97	3.1	1.3	14
1時間計							456	17	473	3.6	6.4	32
18:00-18:15							113	6	119	5.0	1.6	7
18:15-18:30							80	1	81	1.2	1.1	4
18:30-18:45							97	5	102	4.9	1.4	6
18:45-19:00							99	1	100	1.0	1.3	4
1時間計							389	13	402	3.2	5.4	21
19:00-19:15							93	5	98	5.1	1.3	5
19:15-19:30							107	1	108	0.9	1.5	6
19:30-19:45							82	4	86	4.7	1.2	5
19:45-20:00							78	3	81	3.7	1.1	2
1時間計							360	13	373	3.5	5.0	18
20:00-20:15							70	2	72	2.8	1.0	4
20:15-20:30							76	2	78	2.6	1.0	5
20:30-20:45							64	3	67	4.5	0.9	3
20:45-21:00							59	0	59	0.0	0.8	6
1時間計							269	7	276	2.5	3.7	18
21:00-21:15							57	1	58	1.7	0.8	1
21:15-21:30							54	1	55	1.8	0.7	3
21:30-21:45							49	3	52	5.8	0.7	1
21:45-22:00							51	3	54	5.6	0.7	3
1時間計							211	8	219	3.7	2.9	8
昼12時間計							5457	274	5731	4.8	77.0	375
夜12時間計							1598	110	1708	6.4	23.0	98
全時間合計							7055	384	7439	5.2	100.0	473
昼夜率							1.29	1.40	1.30	-	-	1.26

方向別自動車交通量調査表

調査地点 : 地域社会 4 滝沢

調査年月日 : 令和 2年 9月26日(土) 天候:晴れ一時雨



方向 種別 時間帯	3						4					
	小型車 (台)	大型車 (台)	合計 (台)	大型車 混入率 (%)	時間 係数 (%)	二輪車 (台)	小型車 (台)	大型車 (台)	合計 (台)	大型車 混入率 (%)	時間 係数 (%)	二輪車 (台)
22:00-22:15	53	4	57	7.0	0.8	1	0	2	2	100.0	1.0	0
22:15-22:30	51	4	55	7.3	0.7	0	0	1	1	100.0	0.5	0
22:30-22:45	52	3	55	5.5	0.7	2	1	1	2	50.0	1.0	0
22:45-23:00	42	1	43	2.3	0.6	2	3	1	4	25.0	2.0	0
1時間計	198	12	210	5.7	2.8	5	4	5	9	55.6	4.4	0
23:00-23:15	22	1	23	4.3	0.3	1	1	0	1	0.0	0.5	0
23:15-23:30	17	2	19	10.5	0.3	0	0	0	0	0.0	0.0	0
23:30-23:45	11	2	13	15.4	0.2	1	0	0	0	0.0	0.0	1
23:45-24:00	21	3	24	12.5	0.3	3	1	1	2	50.0	1.0	0
1時間計	71	8	79	10.1	1.0	5	2	1	3	33.3	1.5	1
0:00-0:15	25	4	29	13.8	0.4	2	0	0	0	0.0	0.0	1
0:15-0:30	15	1	16	6.3	0.2	3	1	0	1	0.0	0.5	0
0:30-0:45	16	2	18	11.1	0.2	2	0	0	0	0.0	0.0	0
0:45-1:00	8	0	8	0.0	0.1	0	1	0	1	0.0	0.5	0
1時間計	64	7	71	9.9	0.9	7	2	0	2	0.0	1.0	1
1:00-1:15	13	3	16	18.8	0.2	0	1	2	3	66.7	1.5	0
1:15-1:30	8	4	12	33.3	0.2	0	0	2	2	100.0	1.0	0
1:30-1:45	9	1	10	10.0	0.1	0	0	1	1	100.0	0.5	0
1:45-2:00	8	1	9	11.1	0.1	0	1	0	1	0.0	0.5	0
1時間計	38	9	47	19.1	0.6	0	2	5	7	71.4	3.4	0
2:00-2:15	8	0	8	0.0	0.1	1	1	2	3	66.7	1.5	0
2:15-2:30	6	0	6	0.0	0.1	0	2	0	2	0.0	1.0	0
2:30-2:45	7	2	9	22.2	0.1	0	0	0	0	0.0	0.0	0
2:45-3:00	2	0	2	0.0	0.0	0	0	0	0	0.0	0.0	0
1時間計	23	2	25	8.0	0.3	1	3	2	5	40.0	2.5	0
3:00-3:15	8	1	9	11.1	0.1	0	1	0	1	0.0	0.5	0
3:15-3:30	7	1	8	12.5	0.1	0	0	0	0	0.0	0.0	0
3:30-3:45	5	1	6	16.7	0.1	0	0	0	0	0.0	0.0	0
3:45-4:00	11	4	15	26.7	0.2	2	0	1	1	100.0	0.5	0
1時間計	31	7	38	18.4	0.5	2	1	1	2	50.0	1.0	0
4:00-4:15	6	1	7	14.3	0.1	0	1	0	1	0.0	0.5	0
4:15-4:30	12	1	13	7.7	0.2	0	1	0	1	0.0	0.5	0
4:30-4:45	9	1	10	10.0	0.1	0	0	1	1	100.0	0.5	0
4:45-5:00	7	5	12	41.7	0.2	2	0	0	0	0.0	0.0	0
1時間計	34	8	42	19.0	0.6	2	2	1	3	33.3	1.5	0
5:00-5:15	18	3	21	14.3	0.3	1	1	1	2	50.0	1.0	0
5:15-5:30	13	2	15	13.3	0.2	1	1	0	1	0.0	0.5	0
5:30-5:45	12	1	13	7.7	0.2	1	0	0	0	0.0	0.0	0
5:45-6:00	25	2	27	7.4	0.4	0	1	0	1	0.0	0.5	0
1時間計	68	8	76	10.5	1.0	3	3	1	4	25.0	2.0	0

方向別自動車交通量調査表

調査地点 : 地域社会 4 滝沢

調査年月日 : 令和 2年 9月26日(土) 天候:晴れ一時雨



方向 時間帯	3						4					
	種別 小型車 (台)	大型車 (台)	合計 (台)	大型車 混入率 (%)	時間 係数 (%)	二輪車 (台)	小型車 (台)	大型車 (台)	合計 (台)	大型車 混入率 (%)	時間 係数 (%)	二輪車 (台)
6:00-6:15	26	2	28	7.1	0.4	2	1	0	1	0.0	0.5	0
6:15-6:30	24	5	29	17.2	0.4	1	0	0	0	0.0	0.0	0
6:30-6:45	40	8	48	16.7	0.6	1	0	0	0	0.0	0.0	0
6:45-7:00	39	1	40	2.5	0.5	2	0	0	0	0.0	0.0	0
1時間計	129	16	145	11.0	1.9	6	1	0	1	0.0	0.5	0
7:00-7:15	45	4	49	8.2	0.6	3	1	0	1	0.0	0.5	0
7:15-7:30	53	5	58	8.6	0.8	4	1	2	3	66.7	1.5	1
7:30-7:45	67	4	71	5.6	0.9	6	3	0	3	0.0	1.5	0
7:45-8:00	80	9	89	10.1	1.2	11	1	0	1	0.0	0.5	1
1時間計	245	22	267	8.2	3.5	24	6	2	8	25.0	3.9	2
8:00-8:15	107	11	118	9.3	1.6	8	1	1	2	50.0	1.0	1
8:15-8:30	94	6	100	6.0	1.3	7	3	1	4	25.0	2.0	1
8:30-8:45	109	11	120	9.2	1.6	9	1	2	3	66.7	1.5	0
8:45-9:00	92	5	97	5.2	1.3	4	3	0	3	0.0	1.5	1
1時間計	402	33	435	7.6	5.7	28	8	4	12	33.3	5.9	3
9:00-9:15	120	10	130	7.7	1.7	6	2	0	2	0.0	1.0	0
9:15-9:30	111	11	122	9.0	1.6	6	1	0	1	0.0	0.5	0
9:30-9:45	102	7	109	6.4	1.4	4	2	2	4	50.0	2.0	0
9:45-10:00	108	9	117	7.7	1.5	4	4	0	4	0.0	2.0	0
1時間計	441	37	478	7.7	6.3	20	9	2	11	18.2	5.4	0
10:00-10:15	122	5	127	3.9	1.7	4	3	0	3	0.0	1.5	0
10:15-10:30	109	8	117	6.8	1.5	4	4	3	7	42.9	3.4	0
10:30-10:45	111	6	117	5.1	1.5	5	5	0	5	0.0	2.5	0
10:45-11:00	112	2	114	1.8	1.5	5	3	0	3	0.0	1.5	2
1時間計	454	21	475	4.4	6.3	18	15	3	18	16.7	8.8	2
11:00-11:15	109	4	113	3.5	1.5	4	9	0	9	0.0	4.4	0
11:15-11:30	108	4	112	3.6	1.5	11	0	0	0	0.0	0.0	1
11:30-11:45	124	4	128	3.1	1.7	8	0	0	0	0.0	0.0	0
11:45-12:00	109	2	111	1.8	1.5	7	1	0	1	0.0	0.5	0
1時間計	450	14	464	3.0	6.1	30	10	0	10	0.0	4.9	1
12:00-12:15	137	8	145	5.5	1.9	7	2	0	2	0.0	1.0	1
12:15-12:30	116	5	121	4.1	1.6	11	1	0	1	0.0	0.5	0
12:30-12:45	143	8	151	5.3	2.0	5	2	0	2	0.0	1.0	0
12:45-13:00	105	2	107	1.9	1.4	7	5	0	5	0.0	2.5	0
1時間計	501	23	524	4.4	6.9	30	10	0	10	0.0	4.9	1
13:00-13:15	102	5	107	4.7	1.4	6	2	1	3	33.3	1.5	0
13:15-13:30	137	3	140	2.1	1.8	7	5	0	5	0.0	2.5	2
13:30-13:45	118	5	123	4.1	1.6	8	0	0	0	0.0	0.0	0
13:45-14:00	118	5	123	4.1	1.6	7	1	0	1	0.0	0.5	0
1時間計	475	18	493	3.7	6.5	28	8	1	9	11.1	4.4	2

方向別自動車交通量調査表

調査地点 : 地域社会 4 滝沢

調査年月日 : 令和 2年 9月26日(土) 天候:晴れ一時雨



方向 種別 時間帯	3						4					
	小型車 (台)	大型車 (台)	合計 (台)	大型車 混入率 (%)	時間 係数 (%)	二輪車 (台)	小型車 (台)	大型車 (台)	合計 (台)	大型車 混入率 (%)	時間 係数 (%)	二輪車 (台)
14:00-14:15	131	7	138	5.1	1.8	14	3	0	3	0.0	1.5	0
14:15-14:30	121	3	124	2.4	1.6	5	3	0	3	0.0	1.5	0
14:30-14:45	132	3	135	2.2	1.8	12	4	0	4	0.0	2.0	1
14:45-15:00	147	1	148	0.7	2.0	10	1	0	1	0.0	0.5	2
1時間計	531	14	545	2.6	7.2	41	11	0	11	0.0	5.4	3
15:00-15:15	149	4	153	2.6	2.0	8	9	0	9	0.0	4.4	1
15:15-15:30	127	3	130	2.3	1.7	12	1	1	2	50.0	1.0	0
15:30-15:45	143	2	145	1.4	1.9	6	1	0	1	0.0	0.5	1
15:45-16:00	163	2	165	1.2	2.2	7	5	0	5	0.0	2.5	0
1時間計	582	11	593	1.9	7.8	33	16	1	17	5.9	8.3	2
16:00-16:15	153	6	159	3.8	2.1	12	3	2	5	40.0	2.5	0
16:15-16:30	133	4	137	2.9	1.8	14	6	1	7	14.3	3.4	0
16:30-16:45	147	2	149	1.3	2.0	11	2	2	4	50.0	2.0	0
16:45-17:00	135	2	137	1.5	1.8	21	5	0	5	0.0	2.5	1
1時間計	568	14	582	2.4	7.7	58	16	5	21	23.8	10.3	1
17:00-17:15	132	2	134	1.5	1.8	5	3	4	7	57.1	3.4	2
17:15-17:30	157	4	161	2.5	2.1	9	1	0	1	0.0	0.5	0
17:30-17:45	161	4	165	2.4	2.2	9	2	3	5	60.0	2.5	0
17:45-18:00	150	1	151	0.7	2.0	6	0	0	0	0.0	0.0	0
1時間計	600	11	611	1.8	8.1	29	6	7	13	53.8	6.4	2
18:00-18:15	125	4	129	3.1	1.7	8	2	0	2	0.0	1.0	1
18:15-18:30	151	1	152	0.7	2.0	6	0	0	0	0.0	0.0	0
18:30-18:45	121	3	124	2.4	1.6	3	1	1	2	50.0	1.0	0
18:45-19:00	120	4	124	3.2	1.6	7	4	0	4	0.0	2.0	0
1時間計	517	12	529	2.3	7.0	24	7	1	8	12.5	3.9	1
19:00-19:15	102	7	109	6.4	1.4	5	1	0	1	0.0	0.5	0
19:15-19:30	80	2	82	2.4	1.1	7	1	0	1	0.0	0.5	0
19:30-19:45	81	2	83	2.4	1.1	2	4	0	4	0.0	2.0	0
19:45-20:00	96	1	97	1.0	1.3	4	2	1	3	33.3	1.5	0
1時間計	359	12	371	3.2	4.9	18	8	1	9	11.1	4.4	0
20:00-20:15	79	3	82	3.7	1.1	2	0	1	1	100.0	0.5	0
20:15-20:30	66	2	68	2.9	0.9	2	3	1	4	25.0	2.0	0
20:30-20:45	67	2	69	2.9	0.9	4	1	0	1	0.0	0.5	0
20:45-21:00	45	1	46	2.2	0.6	4	1	0	1	0.0	0.5	0
1時間計	257	8	265	3.0	3.5	12	5	2	7	28.6	3.4	0
21:00-21:15	45	1	46	2.2	0.6	3	0	0	0	0.0	0.0	0
21:15-21:30	56	5	61	8.2	0.8	0	0	1	1	100.0	0.5	0
21:30-21:45	60	2	62	3.2	0.8	2	1	0	1	0.0	0.5	0
21:45-22:00	40	2	42	4.8	0.6	2	0	2	2	100.0	1.0	0
1時間計	201	10	211	4.7	2.8	7	1	3	4	75.0	2.0	0
昼12時間計	5766	230	5996	3.8	79.1	363	122	26	148	17.6	72.5	20
夜12時間計	1473	107	1580	6.8	20.9	68	34	22	56	39.3	27.5	2
全時間合計	7239	337	7576	4.4	100.0	431	156	48	204	23.5	100.0	22
昼夜率	1.26	1.47	1.26	-	-	1.19	1.28	1.85	1.38	-	-	1.10

方向別自動車交通量調査表

調査地点：地域社会4 滝沢

調査年月日：令和2年9月26日(土) 天候：晴れ一時雨



方向 種別 時間帯							B 合計 (3+4)					
	小型車 (台)	大型車 (台)	合計 (台)	大型車 混入率 (%)	時間 係数 (%)	二輪車 (台)	小型車 (台)	大型車 (台)	合計 (台)	大型車 混入率 (%)	時間 係数 (%)	二輪車 (台)
22:00-22:15							53	6	59	10.2	0.8	1
22:15-22:30							51	5	56	8.9	0.7	0
22:30-22:45							53	4	57	7.0	0.7	2
22:45-23:00							45	2	47	4.3	0.6	2
1時間計							202	17	219	7.8	2.8	5
23:00-23:15							23	1	24	4.2	0.3	1
23:15-23:30							17	2	19	10.5	0.2	0
23:30-23:45							11	2	13	15.4	0.2	2
23:45-24:00							22	4	26	15.4	0.3	3
1時間計							73	9	82	11.0	1.1	6
0:00-0:15							25	4	29	13.8	0.4	3
0:15-0:30							16	1	17	5.9	0.2	3
0:30-0:45							16	2	18	11.1	0.2	2
0:45-1:00							9	0	9	0.0	0.1	0
1時間計							66	7	73	9.6	0.9	8
1:00-1:15							14	5	19	26.3	0.2	0
1:15-1:30							8	6	14	42.9	0.2	0
1:30-1:45							9	2	11	18.2	0.1	0
1:45-2:00							9	1	10	10.0	0.1	0
1時間計							40	14	54	25.9	0.7	0
2:00-2:15							9	2	11	18.2	0.1	1
2:15-2:30							8	0	8	0.0	0.1	0
2:30-2:45							7	2	9	22.2	0.1	0
2:45-3:00							2	0	2	0.0	0.0	0
1時間計							26	4	30	13.3	0.4	1
3:00-3:15							9	1	10	10.0	0.1	0
3:15-3:30							7	1	8	12.5	0.1	0
3:30-3:45							5	1	6	16.7	0.1	0
3:45-4:00							11	5	16	31.3	0.2	2
1時間計							32	8	40	20.0	0.5	2
4:00-4:15							7	1	8	12.5	0.1	0
4:15-4:30							13	1	14	7.1	0.2	0
4:30-4:45							9	2	11	18.2	0.1	0
4:45-5:00							7	5	12	41.7	0.2	2
1時間計							36	9	45	20.0	0.6	2
5:00-5:15							19	4	23	17.4	0.3	1
5:15-5:30							14	2	16	12.5	0.2	1
5:30-5:45							12	1	13	7.7	0.2	1
5:45-6:00							26	2	28	7.1	0.4	0
1時間計							71	9	80	11.3	1.0	3

方向別自動車交通量調査表

調査地点：地域社会4 滝沢

調査年月日：令和2年9月26日(土) 天候：晴れ一時雨



時間帯	方向 種別						B 合計 (3+4)					
		小型車 (台)	大型車 (台)	合計 (台)	大型車 混入率 (%)	時間 係数 (%)	二輪車 (台)	小型車 (台)	大型車 (台)	合計 (台)	大型車 混入率 (%)	時間 係数 (%)
6:00-6:15							27	2	29	6.9	0.4	2
6:15-6:30							24	5	29	17.2	0.4	1
6:30-6:45							40	8	48	16.7	0.6	1
6:45-7:00							39	1	40	2.5	0.5	2
1時間計							130	16	146	11.0	1.9	6
7:00-7:15							46	4	50	8.0	0.6	3
7:15-7:30							54	7	61	11.5	0.8	5
7:30-7:45							70	4	74	5.4	1.0	6
7:45-8:00							81	9	90	10.0	1.2	12
1時間計							251	24	275	8.7	3.5	26
8:00-8:15							108	12	120	10.0	1.5	9
8:15-8:30							97	7	104	6.7	1.3	8
8:30-8:45							110	13	123	10.6	1.6	9
8:45-9:00							95	5	100	5.0	1.3	5
1時間計							410	37	447	8.3	5.7	31
9:00-9:15							122	10	132	7.6	1.7	6
9:15-9:30							112	11	123	8.9	1.6	6
9:30-9:45							104	9	113	8.0	1.5	4
9:45-10:00							112	9	121	7.4	1.6	4
1時間計							450	39	489	8.0	6.3	20
10:00-10:15							125	5	130	3.8	1.7	4
10:15-10:30							113	11	124	8.9	1.6	4
10:30-10:45							116	6	122	4.9	1.6	5
10:45-11:00							115	2	117	1.7	1.5	7
1時間計							469	24	493	4.9	6.3	20
11:00-11:15							118	4	122	3.3	1.6	4
11:15-11:30							108	4	112	3.6	1.4	12
11:30-11:45							124	4	128	3.1	1.6	8
11:45-12:00							110	2	112	1.8	1.4	7
1時間計							460	14	474	3.0	6.1	31
12:00-12:15							139	8	147	5.4	1.9	8
12:15-12:30							117	5	122	4.1	1.6	11
12:30-12:45							145	8	153	5.2	2.0	5
12:45-13:00							110	2	112	1.8	1.4	7
1時間計							511	23	534	4.3	6.9	31
13:00-13:15							104	6	110	5.5	1.4	6
13:15-13:30							142	3	145	2.1	1.9	9
13:30-13:45							118	5	123	4.1	1.6	8
13:45-14:00							119	5	124	4.0	1.6	7
1時間計							483	19	502	3.8	6.5	30

方向別自動車交通量調査表

調査地点 : 地域社会 4 滝沢

調査年月日 : 令和 2年 9月26日(土) 天候:晴れ一時雨



時間帯	方向 種別						B 合計 (3+ 4)					
		小型車 (台)	大型車 (台)	合計 (台)	大型車 混入率 (%)	時間 係数 (%)	二輪車 (台)	小型車 (台)	大型車 (台)	合計 (台)	大型車 混入率 (%)	時間 係数 (%)
14:00-14:15							134	7	141	5.0	1.8	14
14:15-14:30							124	3	127	2.4	1.6	5
14:30-14:45							136	3	139	2.2	1.8	13
14:45-15:00							148	1	149	0.7	1.9	12
1時間計							542	14	556	2.5	7.1	44
15:00-15:15							158	4	162	2.5	2.1	9
15:15-15:30							128	4	132	3.0	1.7	12
15:30-15:45							144	2	146	1.4	1.9	7
15:45-16:00							168	2	170	1.2	2.2	7
1時間計							598	12	610	2.0	7.8	35
16:00-16:15							156	8	164	4.9	2.1	12
16:15-16:30							139	5	144	3.5	1.9	14
16:30-16:45							149	4	153	2.6	2.0	11
16:45-17:00							140	2	142	1.4	1.8	22
1時間計							584	19	603	3.2	7.8	59
17:00-17:15							135	6	141	4.3	1.8	7
17:15-17:30							158	4	162	2.5	2.1	9
17:30-17:45							163	7	170	4.1	2.2	9
17:45-18:00							150	1	151	0.7	1.9	6
1時間計							606	18	624	2.9	8.0	31
18:00-18:15							127	4	131	3.1	1.7	9
18:15-18:30							151	1	152	0.7	2.0	6
18:30-18:45							122	4	126	3.2	1.6	3
18:45-19:00							124	4	128	3.1	1.6	7
1時間計							524	13	537	2.4	6.9	25
19:00-19:15							103	7	110	6.4	1.4	5
19:15-19:30							81	2	83	2.4	1.1	7
19:30-19:45							85	2	87	2.3	1.1	2
19:45-20:00							98	2	100	2.0	1.3	4
1時間計							367	13	380	3.4	4.9	18
20:00-20:15							79	4	83	4.8	1.1	2
20:15-20:30							69	3	72	4.2	0.9	2
20:30-20:45							68	2	70	2.9	0.9	4
20:45-21:00							46	1	47	2.1	0.6	4
1時間計							262	10	272	3.7	3.5	12
21:00-21:15							45	1	46	2.2	0.6	3
21:15-21:30							56	6	62	9.7	0.8	0
21:30-21:45							61	2	63	3.2	0.8	2
21:45-22:00							40	4	44	9.1	0.6	2
1時間計							202	13	215	6.0	2.8	7
昼12時間計							5888	256	6144	4.2	79.0	383
夜12時間計							1507	129	1636	7.9	21.0	70
全時間合計							7395	385	7780	4.9	100.0	453
昼夜率							1.26	1.50	1.27	-	-	1.18

方向別自動車交通量調査表

調査地点 : 地域社会 4 滝沢

調査年月日 : 令和 2年 9月26日(土) 天候:晴れ一時雨



方向 種別 時間帯	5						6					
	小型車 (台)	大型車 (台)	合計 (台)	大型車 混入率 (%)	時間 係数 (%)	二輪車 (台)	小型車 (台)	大型車 (台)	合計 (台)	大型車 混入率 (%)	時間 係数 (%)	二輪車 (台)
22:00-22:15	21	4	25	16.0	1.6	1	15	0	15	0.0	0.6	0
22:15-22:30	13	6	19	31.6	1.2	0	12	0	12	0.0	0.5	0
22:30-22:45	6	2	8	25.0	0.5	0	11	0	11	0.0	0.4	0
22:45-23:00	4	2	6	33.3	0.4	0	13	1	14	7.1	0.5	1
1時間計	44	14	58	24.1	3.7	1	51	1	52	1.9	2.0	1
23:00-23:15	10	8	18	44.4	1.1	0	16	0	16	0.0	0.6	0
23:15-23:30	8	6	14	42.9	0.9	0	6	0	6	0.0	0.2	2
23:30-23:45	7	8	15	53.3	1.0	0	8	0	8	0.0	0.3	1
23:45-24:00	6	3	9	33.3	0.6	1	16	0	16	0.0	0.6	0
1時間計	31	25	56	44.6	3.6	1	46	0	46	0.0	1.8	3
0:00- 0:15	8	4	12	33.3	0.8	0	9	0	9	0.0	0.3	1
0:15- 0:30	1	3	4	75.0	0.3	0	6	0	6	0.0	0.2	0
0:30- 0:45	5	6	11	54.5	0.7	0	5	1	6	16.7	0.2	0
0:45- 1:00	3	6	9	66.7	0.6	0	8	0	8	0.0	0.3	0
1時間計	17	19	36	52.8	2.3	0	28	1	29	3.4	1.1	1
1:00- 1:15	4	4	8	50.0	0.5	0	0	0	0	0.0	0.0	0
1:15- 1:30	7	4	11	36.4	0.7	0	6	0	6	0.0	0.2	0
1:30- 1:45	4	6	10	60.0	0.6	0	3	0	3	0.0	0.1	0
1:45- 2:00	1	5	6	83.3	0.4	0	3	1	4	25.0	0.2	0
1時間計	16	19	35	54.3	2.2	0	12	1	13	7.7	0.5	0
2:00- 2:15	2	1	3	33.3	0.2	0	6	0	6	0.0	0.2	0
2:15- 2:30	3	5	8	62.5	0.5	0	3	0	3	0.0	0.1	0
2:30- 2:45	2	3	5	60.0	0.3	0	6	0	6	0.0	0.2	0
2:45- 3:00	0	4	4	100.0	0.3	0	3	0	3	0.0	0.1	0
1時間計	7	13	20	65.0	1.3	0	18	0	18	0.0	0.7	0
3:00- 3:15	5	3	8	37.5	0.5	0	2	1	3	33.3	0.1	1
3:15- 3:30	1	0	1	0.0	0.1	0	6	2	8	25.0	0.3	0
3:30- 3:45	3	2	5	40.0	0.3	0	3	0	3	0.0	0.1	0
3:45- 4:00	1	4	5	80.0	0.3	0	1	2	3	66.7	0.1	0
1時間計	10	9	19	47.4	1.2	0	12	5	17	29.4	0.6	1
4:00- 4:15	2	2	4	50.0	0.3	0	2	0	2	0.0	0.1	0
4:15- 4:30	1	2	3	66.7	0.2	0	2	2	4	50.0	0.2	0
4:30- 4:45	1	2	3	66.7	0.2	0	1	3	4	75.0	0.2	0
4:45- 5:00	0	0	0	0.0	0.0	3	2	2	4	50.0	0.2	0
1時間計	4	6	10	60.0	0.6	3	7	7	14	50.0	0.5	0
5:00- 5:15	2	4	6	66.7	0.4	0	3	1	4	25.0	0.2	0
5:15- 5:30	4	2	6	33.3	0.4	2	10	2	12	16.7	0.5	2
5:30- 5:45	5	3	8	37.5	0.5	0	2	0	2	0.0	0.1	0
5:45- 6:00	2	4	6	66.7	0.4	2	4	2	6	33.3	0.2	0
1時間計	13	13	26	50.0	1.6	4	19	5	24	20.8	0.9	2

方向別自動車交通量調査表

調査地点 : 地域社会 4 滝沢

調査年月日 : 令和 2年 9月26日(土) 天候:晴れ一時雨



方向 時間帯	5						6					
	種別 小型車 (台)	大型車 (台)	合計 (台)	大型車 混入率 (%)	時間 係数 (%)	二輪車 (台)	小型車 (台)	大型車 (台)	合計 (台)	大型車 混入率 (%)	時間 係数 (%)	二輪車 (台)
6:00-6:15	6	2	8	25.0	0.5	0	6	3	9	33.3	0.3	0
6:15-6:30	2	6	8	75.0	0.5	0	10	1	11	9.1	0.4	0
6:30-6:45	10	3	13	23.1	0.8	1	5	2	7	28.6	0.3	0
6:45-7:00	11	4	15	26.7	1.0	1	13	3	16	18.8	0.6	0
1時間計	29	15	44	34.1	2.8	2	34	9	43	20.9	1.6	0
7:00-7:15	7	2	9	22.2	0.6	0	8	1	9	11.1	0.3	0
7:15-7:30	10	7	17	41.2	1.1	1	12	1	13	7.7	0.5	0
7:30-7:45	11	5	16	31.3	1.0	0	15	0	15	0.0	0.6	1
7:45-8:00	14	2	16	12.5	1.0	1	21	2	23	8.7	0.9	2
1時間計	42	16	58	27.6	3.7	2	56	4	60	6.7	2.3	3
8:00-8:15	13	3	16	18.8	1.0	0	18	4	22	18.2	0.8	2
8:15-8:30	14	0	14	0.0	0.9	0	19	2	21	9.5	0.8	1
8:30-8:45	13	4	17	23.5	1.1	4	23	0	23	0.0	0.9	1
8:45-9:00	9	5	14	35.7	0.9	0	42	3	45	6.7	1.7	2
1時間計	49	12	61	19.7	3.9	4	102	9	111	8.1	4.2	6
9:00-9:15	15	1	16	6.3	1.0	0	27	3	30	10.0	1.1	0
9:15-9:30	12	3	15	20.0	1.0	0	24	2	26	7.7	1.0	1
9:30-9:45	12	2	14	14.3	0.9	0	33	3	36	8.3	1.4	0
9:45-10:00	16	2	18	11.1	1.1	0	27	0	27	0.0	1.0	0
1時間計	55	8	63	12.7	4.0	0	111	8	119	6.7	4.5	1
10:00-10:15	24	6	30	20.0	1.9	0	28	4	32	12.5	1.2	1
10:15-10:30	12	11	23	47.8	1.5	0	29	2	31	6.5	1.2	2
10:30-10:45	16	6	22	27.3	1.4	2	31	2	33	6.1	1.3	1
10:45-11:00	12	9	21	42.9	1.3	1	38	2	40	5.0	1.5	1
1時間計	64	32	96	33.3	6.1	3	126	10	136	7.4	5.2	5
11:00-11:15	17	3	20	15.0	1.3	0	47	1	48	2.1	1.8	0
11:15-11:30	25	4	29	13.8	1.8	0	33	2	35	5.7	1.3	2
11:30-11:45	26	4	30	13.3	1.9	0	48	3	51	5.9	1.9	2
11:45-12:00	14	4	18	22.2	1.1	1	42	4	46	8.7	1.8	0
1時間計	82	15	97	15.5	6.2	1	170	10	180	5.6	6.9	4
12:00-12:15	16	1	17	5.9	1.1	0	61	0	61	0.0	2.3	1
12:15-12:30	23	6	29	20.7	1.8	2	42	2	44	4.5	1.7	2
12:30-12:45	19	2	21	9.5	1.3	0	58	3	61	4.9	2.3	1
12:45-13:00	24	6	30	20.0	1.9	0	45	3	48	6.3	1.8	3
1時間計	82	15	97	15.5	6.2	2	206	8	214	3.7	8.2	7
13:00-13:15	19	3	22	13.6	1.4	0	35	0	35	0.0	1.3	3
13:15-13:30	19	5	24	20.8	1.5	2	36	2	38	5.3	1.5	2
13:30-13:45	22	10	32	31.3	2.0	1	48	1	49	2.0	1.9	1
13:45-14:00	27	3	30	10.0	1.9	1	50	2	52	3.8	2.0	3
1時間計	87	21	108	19.4	6.8	4	169	5	174	2.9	6.6	9

方向別自動車交通量調査表

調査地点 : 地域社会 4 滝沢

調査年月日 : 令和 2年 9月26日(土) 天候:晴れ一時雨



方向 種別 時間帯	5						6					
	小型車 (台)	大型車 (台)	合計 (台)	大型車 混入率 (%)	時間 係数 (%)	二輪車 (台)	小型車 (台)	大型車 (台)	合計 (台)	大型車 混入率 (%)	時間 係数 (%)	二輪車 (台)
14:00-14:15	30	8	38	21.1	2.4	0	58	4	62	6.5	2.4	3
14:15-14:30	20	3	23	13.0	1.5	0	38	0	38	0.0	1.5	0
14:30-14:45	16	1	17	5.9	1.1	0	47	1	48	2.1	1.8	1
14:45-15:00	26	2	28	7.1	1.8	0	31	0	31	0.0	1.2	1
1時間計	92	14	106	13.2	6.7	0	174	5	179	2.8	6.8	5
15:00-15:15	22	2	24	8.3	1.5	0	48	1	49	2.0	1.9	9
15:15-15:30	22	2	24	8.3	1.5	0	33	3	36	8.3	1.4	6
15:30-15:45	24	2	26	7.7	1.6	0	44	0	44	0.0	1.7	8
15:45-16:00	16	6	22	27.3	1.4	0	38	0	38	0.0	1.5	5
1時間計	84	12	96	12.5	6.1	0	163	4	167	2.4	6.4	28
16:00-16:15	29	3	32	9.4	2.0	1	58	0	58	0.0	2.2	2
16:15-16:30	24	8	32	25.0	2.0	1	64	0	64	0.0	2.4	0
16:30-16:45	30	6	36	16.7	2.3	0	54	2	56	3.6	2.1	1
16:45-17:00	24	3	27	11.1	1.7	0	54	2	56	3.6	2.1	5
1時間計	107	20	127	15.7	8.1	2	230	4	234	1.7	8.9	8
17:00-17:15	18	11	29	37.9	1.8	1	45	3	48	6.3	1.8	3
17:15-17:30	17	3	20	15.0	1.3	0	52	0	52	0.0	2.0	0
17:30-17:45	26	6	32	18.8	2.0	1	66	0	66	0.0	2.5	3
17:45-18:00	16	2	18	11.1	1.1	1	58	0	58	0.0	2.2	2
1時間計	77	22	99	22.2	6.3	3	221	3	224	1.3	8.5	8
18:00-18:15	26	5	31	16.1	2.0	0	66	2	68	2.9	2.6	1
18:15-18:30	18	2	20	10.0	1.3	1	60	2	62	3.2	2.4	1
18:30-18:45	21	1	22	4.5	1.4	0	57	2	59	3.4	2.3	3
18:45-19:00	13	1	14	7.1	0.9	0	44	1	45	2.2	1.7	1
1時間計	78	9	87	10.3	5.5	1	227	7	234	3.0	8.9	6
19:00-19:15	17	6	23	26.1	1.5	0	49	1	50	2.0	1.9	0
19:15-19:30	17	1	18	5.6	1.1	0	33	0	33	0.0	1.3	2
19:30-19:45	10	1	11	9.1	0.7	0	42	0	42	0.0	1.6	6
19:45-20:00	12	2	14	14.3	0.9	0	36	1	37	2.7	1.4	1
1時間計	56	10	66	15.2	4.2	0	160	2	162	1.2	6.2	9
20:00-20:15	17	0	17	0.0	1.1	1	30	1	31	3.2	1.2	1
20:15-20:30	9	2	11	18.2	0.7	1	25	0	25	0.0	1.0	1
20:30-20:45	6	1	7	14.3	0.4	1	19	2	21	9.5	0.8	0
20:45-21:00	8	1	9	11.1	0.6	0	20	0	20	0.0	0.8	1
1時間計	40	4	44	9.1	2.8	3	94	3	97	3.1	3.7	3
21:00-21:15	7	5	12	41.7	0.8	1	26	1	27	3.7	1.0	2
21:15-21:30	21	9	30	30.0	1.9	1	15	1	16	6.3	0.6	1
21:30-21:45	10	2	12	16.7	0.8	0	18	2	20	10.0	0.8	0
21:45-22:00	12	2	14	14.3	0.9	0	10	0	10	0.0	0.4	1
1時間計	50	18	68	26.5	4.3	2	69	4	73	5.5	2.8	4
昼12時間計	899	196	1095	17.9	69.4	22	1955	77	2032	3.8	77.6	90
夜12時間計	317	165	482	34.2	30.6	16	550	38	588	6.5	22.4	24
全時間合計	1216	361	1577	22.9	100.0	38	2505	115	2620	4.4	100.0	114
昼夜率	1.35	1.84	1.44	-	-	1.73	1.28	1.49	1.29	-	-	1.27

方向別自動車交通量調査表

調査地点 : 地域社会 4 滝沢

調査年月日 : 令和 2年 9月26日(土) 天候:晴れ一時雨



方向 種別 時間帯							C 合計 (5+ 6)					
	小型車 (台)	大型車 (台)	合計 (台)	大型車 混入率 (%)	時間 係数 (%)	二輪車 (台)	小型車 (台)	大型車 (台)	合計 (台)	大型車 混入率 (%)	時間 係数 (%)	二輪車 (台)
22:00-22:15							36	4	40	10.0	1.0	1
22:15-22:30							25	6	31	19.4	0.7	0
22:30-22:45							17	2	19	10.5	0.5	0
22:45-23:00							17	3	20	15.0	0.5	1
1時間計							95	15	110	13.6	2.6	2
23:00-23:15							26	8	34	23.5	0.8	0
23:15-23:30							14	6	20	30.0	0.5	2
23:30-23:45							15	8	23	34.8	0.5	1
23:45-24:00							22	3	25	12.0	0.6	1
1時間計							77	25	102	24.5	2.4	4
0:00- 0:15							17	4	21	19.0	0.5	1
0:15- 0:30							7	3	10	30.0	0.2	0
0:30- 0:45							10	7	17	41.2	0.4	0
0:45- 1:00							11	6	17	35.3	0.4	0
1時間計							45	20	65	30.8	1.5	1
1:00- 1:15							4	4	8	50.0	0.2	0
1:15- 1:30							13	4	17	23.5	0.4	0
1:30- 1:45							7	6	13	46.2	0.3	0
1:45- 2:00							4	6	10	60.0	0.2	0
1時間計							28	20	48	41.7	1.1	0
2:00- 2:15							8	1	9	11.1	0.2	0
2:15- 2:30							6	5	11	45.5	0.3	0
2:30- 2:45							8	3	11	27.3	0.3	0
2:45- 3:00							3	4	7	57.1	0.2	0
1時間計							25	13	38	34.2	0.9	0
3:00- 3:15							7	4	11	36.4	0.3	1
3:15- 3:30							7	2	9	22.2	0.2	0
3:30- 3:45							6	2	8	25.0	0.2	0
3:45- 4:00							2	6	8	75.0	0.2	0
1時間計							22	14	36	38.9	0.9	1
4:00- 4:15							4	2	6	33.3	0.1	0
4:15- 4:30							3	4	7	57.1	0.2	0
4:30- 4:45							2	5	7	71.4	0.2	0
4:45- 5:00							2	2	4	50.0	0.1	3
1時間計							11	13	24	54.2	0.6	3
5:00- 5:15							5	5	10	50.0	0.2	0
5:15- 5:30							14	4	18	22.2	0.4	4
5:30- 5:45							7	3	10	30.0	0.2	0
5:45- 6:00							6	6	12	50.0	0.3	2
1時間計							32	18	50	36.0	1.2	6

方向別自動車交通量調査表

調査地点：地域社会4 滝沢

調査年月日：令和2年9月26日(土) 天候：晴れ一時雨



時間帯	方向 種別						C 合計 (5+6)					
		小型車 (台)	大型車 (台)	合計 (台)	大型車 混入率 (%)	時間 係数 (%)	二輪車 (台)	小型車 (台)	大型車 (台)	合計 (台)	大型車 混入率 (%)	時間 係数 (%)
6:00-6:15							12	5	17	29.4	0.4	0
6:15-6:30							12	7	19	36.8	0.5	0
6:30-6:45							15	5	20	25.0	0.5	1
6:45-7:00							24	7	31	22.6	0.7	1
1時間計							63	24	87	27.6	2.1	2
7:00-7:15							15	3	18	16.7	0.4	0
7:15-7:30							22	8	30	26.7	0.7	1
7:30-7:45							26	5	31	16.1	0.7	1
7:45-8:00							35	4	39	10.3	0.9	3
1時間計							98	20	118	16.9	2.8	5
8:00-8:15							31	7	38	18.4	0.9	2
8:15-8:30							33	2	35	5.7	0.8	1
8:30-8:45							36	4	40	10.0	1.0	5
8:45-9:00							51	8	59	13.6	1.4	2
1時間計							151	21	172	12.2	4.1	10
9:00-9:15							42	4	46	8.7	1.1	0
9:15-9:30							36	5	41	12.2	1.0	1
9:30-9:45							45	5	50	10.0	1.2	0
9:45-10:00							43	2	45	4.4	1.1	0
1時間計							166	16	182	8.8	4.3	1
10:00-10:15							52	10	62	16.1	1.5	1
10:15-10:30							41	13	54	24.1	1.3	2
10:30-10:45							47	8	55	14.5	1.3	3
10:45-11:00							50	11	61	18.0	1.5	2
1時間計							190	42	232	18.1	5.5	8
11:00-11:15							64	4	68	5.9	1.6	0
11:15-11:30							58	6	64	9.4	1.5	2
11:30-11:45							74	7	81	8.6	1.9	2
11:45-12:00							56	8	64	12.5	1.5	1
1時間計							252	25	277	9.0	6.6	5
12:00-12:15							77	1	78	1.3	1.9	1
12:15-12:30							65	8	73	11.0	1.7	4
12:30-12:45							77	5	82	6.1	2.0	1
12:45-13:00							69	9	78	11.5	1.9	3
1時間計							288	23	311	7.4	7.4	9
13:00-13:15							54	3	57	5.3	1.4	3
13:15-13:30							55	7	62	11.3	1.5	4
13:30-13:45							70	11	81	13.6	1.9	2
13:45-14:00							77	5	82	6.1	2.0	4
1時間計							256	26	282	9.2	6.7	13

方向別自動車交通量調査表

調査地点 : 地域社会 4 滝沢

調査年月日 : 令和 2年 9月26日(土) 天候:晴れ一時雨



方向 種別 時間帯							C 合計 (5+ 6)					
	小型車 (台)	大型車 (台)	合計 (台)	大型車 混入率 (%)	時間 係数 (%)	二輪車 (台)	小型車 (台)	大型車 (台)	合計 (台)	大型車 混入率 (%)	時間 係数 (%)	二輪車 (台)
14:00-14:15							88	12	100	12.0	2.4	3
14:15-14:30							58	3	61	4.9	1.5	0
14:30-14:45							63	2	65	3.1	1.5	1
14:45-15:00							57	2	59	3.4	1.4	1
1時間計							266	19	285	6.7	6.8	5
15:00-15:15							70	3	73	4.1	1.7	9
15:15-15:30							55	5	60	8.3	1.4	6
15:30-15:45							68	2	70	2.9	1.7	8
15:45-16:00							54	6	60	10.0	1.4	5
1時間計							247	16	263	6.1	6.3	28
16:00-16:15							87	3	90	3.3	2.1	3
16:15-16:30							88	8	96	8.3	2.3	1
16:30-16:45							84	8	92	8.7	2.2	1
16:45-17:00							78	5	83	6.0	2.0	5
1時間計							337	24	361	6.6	8.6	10
17:00-17:15							63	14	77	18.2	1.8	4
17:15-17:30							69	3	72	4.2	1.7	0
17:30-17:45							92	6	98	6.1	2.3	4
17:45-18:00							74	2	76	2.6	1.8	3
1時間計							298	25	323	7.7	7.7	11
18:00-18:15							92	7	99	7.1	2.4	1
18:15-18:30							78	4	82	4.9	2.0	2
18:30-18:45							78	3	81	3.7	1.9	3
18:45-19:00							57	2	59	3.4	1.4	1
1時間計							305	16	321	5.0	7.6	7
19:00-19:15							66	7	73	9.6	1.7	0
19:15-19:30							50	1	51	2.0	1.2	2
19:30-19:45							52	1	53	1.9	1.3	6
19:45-20:00							48	3	51	5.9	1.2	1
1時間計							216	12	228	5.3	5.4	9
20:00-20:15							47	1	48	2.1	1.1	2
20:15-20:30							34	2	36	5.6	0.9	2
20:30-20:45							25	3	28	10.7	0.7	1
20:45-21:00							28	1	29	3.4	0.7	1
1時間計							134	7	141	5.0	3.4	6
21:00-21:15							33	6	39	15.4	0.9	3
21:15-21:30							36	10	46	21.7	1.1	2
21:30-21:45							28	4	32	12.5	0.8	0
21:45-22:00							22	2	24	8.3	0.6	1
1時間計							119	22	141	15.6	3.4	6
昼12時間計							2854	273	3127	8.7	74.5	112
夜12時間計							867	203	1070	19.0	25.5	40
全時間合計							3721	476	4197	11.3	100.0	152
昼夜率							1.30	1.74	1.34	-	-	1.36

方向別自動車交通量調査表

調査地点：地域社会4 瀬谷土橋公園入口

調査年月日：令和2年9月26日(土) 天候：晴れ一時雨



方向 種別 時間帯	1						2					
	小型車 (台)	大型車 (台)	合計 (台)	大型車 混入率 (%)	時間 係数 (%)	二輪車 (台)	小型車 (台)	大型車 (台)	合計 (台)	大型車 混入率 (%)	時間 係数 (%)	二輪車 (台)
22:00-22:15	5	1	6	16.7	0.5	0	34	3	37	8.1	0.7	2
22:15-22:30	6	1	7	14.3	0.6	0	30	1	31	3.2	0.6	0
22:30-22:45	2	0	2	0.0	0.2	0	24	2	26	7.7	0.5	2
22:45-23:00	7	0	7	0.0	0.6	0	18	1	19	5.3	0.4	0
1時間計	20	2	22	9.1	1.9	0	106	7	113	6.2	2.1	4
23:00-23:15	2	5	7	71.4	0.6	1	28	5	33	15.2	0.6	3
23:15-23:30	5	4	9	44.4	0.8	0	19	0	19	0.0	0.4	1
23:30-23:45	1	2	3	66.7	0.3	0	24	2	26	7.7	0.5	1
23:45-24:00	3	2	5	40.0	0.4	0	22	2	24	8.3	0.4	1
1時間計	11	13	24	54.2	2.0	1	93	9	102	8.8	1.9	6
0:00-0:15	1	1	2	50.0	0.2	1	27	2	29	6.9	0.5	0
0:15-0:30	4	1	5	20.0	0.4	0	11	3	14	21.4	0.3	0
0:30-0:45	3	5	8	62.5	0.7	0	18	6	24	25.0	0.4	0
0:45-1:00	0	2	2	100.0	0.2	0	11	4	15	26.7	0.3	1
1時間計	8	9	17	52.9	1.4	1	67	15	82	18.3	1.5	1
1:00-1:15	1	3	4	75.0	0.3	0	11	5	16	31.3	0.3	1
1:15-1:30	0	1	1	100.0	0.1	0	10	3	13	23.1	0.2	1
1:30-1:45	3	2	5	40.0	0.4	0	7	5	12	41.7	0.2	0
1:45-2:00	2	3	5	60.0	0.4	0	10	2	12	16.7	0.2	1
1時間計	6	9	15	60.0	1.3	0	38	15	53	28.3	1.0	3
2:00-2:15	1	4	5	80.0	0.4	0	3	2	5	40.0	0.1	0
2:15-2:30	3	4	7	57.1	0.6	0	8	2	10	20.0	0.2	0
2:30-2:45	2	0	2	0.0	0.2	0	9	4	13	30.8	0.2	0
2:45-3:00	2	2	4	50.0	0.3	0	6	0	6	0.0	0.1	1
1時間計	8	10	18	55.6	1.5	0	26	8	34	23.5	0.6	1
3:00-3:15	1	0	1	0.0	0.1	0	6	2	8	25.0	0.1	1
3:15-3:30	0	0	0	0.0	0.0	0	2	1	3	33.3	0.1	1
3:30-3:45	2	1	3	33.3	0.3	0	6	1	7	14.3	0.1	2
3:45-4:00	0	2	2	100.0	0.2	0	4	2	6	33.3	0.1	1
1時間計	3	3	6	50.0	0.5	0	18	6	24	25.0	0.4	5
4:00-4:15	4	0	4	0.0	0.3	0	13	1	14	7.1	0.3	0
4:15-4:30	0	1	1	100.0	0.1	0	9	1	10	10.0	0.2	0
4:30-4:45	2	0	2	0.0	0.2	0	4	1	5	20.0	0.1	0
4:45-5:00	5	1	6	16.7	0.5	0	3	0	3	0.0	0.1	1
1時間計	11	2	13	15.4	1.1	0	29	3	32	9.4	0.6	1
5:00-5:15	3	1	4	25.0	0.3	0	8	2	10	20.0	0.2	0
5:15-5:30	6	1	7	14.3	0.6	0	10	2	12	16.7	0.2	1
5:30-5:45	5	3	8	37.5	0.7	0	13	5	18	27.8	0.3	1
5:45-6:00	6	1	7	14.3	0.6	0	14	1	15	6.7	0.3	0
1時間計	20	6	26	23.1	2.2	0	45	10	55	18.2	1.0	2

方向別自動車交通量調査表

調査地点：地域社会4 瀬谷土橋公園入口

調査年月日：令和2年9月26日(土) 天候：晴れ一時雨



方向 時間帯	1						2					
	種別 小型車 (台)	大型車 (台)	合計 (台)	大型車 混入率 (%)	時間 係数 (%)	二輪車 (台)	小型車 (台)	大型車 (台)	合計 (台)	大型車 混入率 (%)	時間 係数 (%)	二輪車 (台)
6:00-6:15	4	1	5	20.0	0.4	0	31	4	35	11.4	0.7	4
6:15-6:30	7	1	8	12.5	0.7	0	24	6	30	20.0	0.6	2
6:30-6:45	6	1	7	14.3	0.6	0	42	4	46	8.7	0.9	3
6:45-7:00	8	3	11	27.3	0.9	0	33	5	38	13.2	0.7	2
1時間計	25	6	31	19.4	2.6	0	130	19	149	12.8	2.8	11
7:00-7:15	3	5	8	62.5	0.7	0	48	4	52	7.7	1.0	3
7:15-7:30	9	2	11	18.2	0.9	0	36	7	43	16.3	0.8	4
7:30-7:45	9	9	18	50.0	1.5	1	69	7	76	9.2	1.4	6
7:45-8:00	5	2	7	28.6	0.6	2	63	4	67	6.0	1.3	5
1時間計	26	18	44	40.9	3.8	3	216	22	238	9.2	4.5	18
8:00-8:15	9	5	14	35.7	1.2	2	72	4	76	5.3	1.4	8
8:15-8:30	17	1	18	5.6	1.5	0	71	6	77	7.8	1.4	1
8:30-8:45	23	2	25	8.0	2.1	0	65	4	69	5.8	1.3	7
8:45-9:00	12	2	14	14.3	1.2	2	60	0	60	0.0	1.1	7
1時間計	61	10	71	14.1	6.1	4	268	14	282	5.0	5.3	23
9:00-9:15	4	1	5	20.0	0.4	0	72	5	77	6.5	1.4	6
9:15-9:30	13	2	15	13.3	1.3	1	59	2	61	3.3	1.1	3
9:30-9:45	21	3	24	12.5	2.0	0	71	6	77	7.8	1.4	7
9:45-10:00	15	2	17	11.8	1.4	0	80	1	81	1.2	1.5	6
1時間計	53	8	61	13.1	5.2	1	282	14	296	4.7	5.5	22
10:00-10:15	26	4	30	13.3	2.6	1	81	4	85	4.7	1.6	7
10:15-10:30	16	5	21	23.8	1.8	1	65	7	72	9.7	1.3	8
10:30-10:45	24	7	31	22.6	2.6	0	63	2	65	3.1	1.2	4
10:45-11:00	18	5	23	21.7	2.0	0	80	3	83	3.6	1.6	9
1時間計	84	21	105	20.0	9.0	2	289	16	305	5.2	5.7	28
11:00-11:15	15	6	21	28.6	1.8	1	93	5	98	5.1	1.8	10
11:15-11:30	23	1	24	4.2	2.0	1	84	7	91	7.7	1.7	3
11:30-11:45	17	1	18	5.6	1.5	0	99	5	104	4.8	1.9	3
11:45-12:00	14	0	14	0.0	1.2	0	67	3	70	4.3	1.3	8
1時間計	69	8	77	10.4	6.6	2	343	20	363	5.5	6.8	24
12:00-12:15	25	1	26	3.8	2.2	2	89	3	92	3.3	1.7	3
12:15-12:30	25	5	30	16.7	2.6	1	98	5	103	4.9	1.9	2
12:30-12:45	18	3	21	14.3	1.8	3	71	6	77	7.8	1.4	6
12:45-13:00	18	7	25	28.0	2.1	0	103	2	105	1.9	2.0	2
1時間計	86	16	102	15.7	8.7	6	361	16	377	4.2	7.1	13
13:00-13:15	24	7	31	22.6	2.6	2	117	4	121	3.3	2.3	8
13:15-13:30	11	3	14	21.4	1.2	0	100	2	102	2.0	1.9	4
13:30-13:45	9	6	15	40.0	1.3	0	88	5	93	5.4	1.7	4
13:45-14:00	18	4	22	18.2	1.9	1	96	5	101	5.0	1.9	6
1時間計	62	20	82	24.4	7.0	3	401	16	417	3.8	7.8	22

方向別自動車交通量調査表

調査地点：地域社会4 瀬谷土橋公園入口

調査年月日：令和2年9月26日(土) 天候：晴れ一時雨



方向 種別 時間帯	1						2					
	小型車 (台)	大型車 (台)	合計 (台)	大型車 混入率 (%)	時間 係数 (%)	二輪車 (台)	小型車 (台)	大型車 (台)	合計 (台)	大型車 混入率 (%)	時間 係数 (%)	二輪車 (台)
14:00-14:15	31	6	37	16.2	3.2	2	109	5	114	4.4	2.1	6
14:15-14:30	27	4	31	12.9	2.6	1	75	3	78	3.8	1.5	9
14:30-14:45	18	4	22	18.2	1.9	0	80	3	83	3.6	1.6	8
14:45-15:00	28	3	31	9.7	2.6	0	85	3	88	3.4	1.6	8
1時間計	104	17	121	14.0	10.3	3	349	14	363	3.9	6.8	31
15:00-15:15	17	2	19	10.5	1.6	0	84	2	86	2.3	1.6	5
15:15-15:30	12	0	12	0.0	1.0	1	95	7	102	6.9	1.9	8
15:30-15:45	16	4	20	20.0	1.7	0	83	0	83	0.0	1.6	7
15:45-16:00	15	3	18	16.7	1.5	0	84	8	92	8.7	1.7	7
1時間計	60	9	69	13.0	5.9	1	346	17	363	4.7	6.8	27
16:00-16:15	15	3	18	16.7	1.5	1	103	2	105	1.9	2.0	5
16:15-16:30	19	2	21	9.5	1.8	3	86	3	89	3.4	1.7	13
16:30-16:45	13	1	14	7.1	1.2	0	117	6	123	4.9	2.3	11
16:45-17:00	10	1	11	9.1	0.9	1	75	2	77	2.6	1.4	5
1時間計	57	7	64	10.9	5.5	5	381	13	394	3.3	7.4	34
17:00-17:15	16	4	20	20.0	1.7	2	109	6	115	5.2	2.2	5
17:15-17:30	9	5	14	35.7	1.2	0	58	2	60	3.3	1.1	2
17:30-17:45	18	1	19	5.3	1.6	1	87	6	93	6.5	1.7	5
17:45-18:00	11	4	15	26.7	1.3	2	76	1	77	1.3	1.4	8
1時間計	54	14	68	20.6	5.8	5	330	15	345	4.3	6.5	20
18:00-18:15	7	8	15	53.3	1.3	0	101	2	103	1.9	1.9	5
18:15-18:30	5	0	5	0.0	0.4	1	69	1	70	1.4	1.3	3
18:30-18:45	8	2	10	20.0	0.9	0	70	3	73	4.1	1.4	5
18:45-19:00	6	0	6	0.0	0.5	0	65	1	66	1.5	1.2	0
1時間計	26	10	36	27.8	3.1	1	305	7	312	2.2	5.8	13
19:00-19:15	11	5	16	31.3	1.4	2	81	2	83	2.4	1.6	2
19:15-19:30	13	1	14	7.1	1.2	0	82	1	83	1.2	1.6	2
19:30-19:45	6	1	7	14.3	0.6	1	50	4	54	7.4	1.0	3
19:45-20:00	9	3	12	25.0	1.0	0	49	1	50	2.0	0.9	1
1時間計	39	10	49	20.4	4.2	3	262	8	270	3.0	5.1	8
20:00-20:15	7	0	7	0.0	0.6	1	50	1	51	2.0	1.0	3
20:15-20:30	7	1	8	12.5	0.7	0	50	2	52	3.8	1.0	7
20:30-20:45	5	1	6	16.7	0.5	0	48	2	50	4.0	0.9	3
20:45-21:00	5	1	6	16.7	0.5	0	39	1	40	2.5	0.7	5
1時間計	24	3	27	11.1	2.3	1	187	6	193	3.1	3.6	18
21:00-21:15	3	2	5	40.0	0.4	0	54	3	57	5.3	1.1	2
21:15-21:30	6	1	7	14.3	0.6	0	40	2	42	4.8	0.8	2
21:30-21:45	8	2	10	20.0	0.9	0	33	2	35	5.7	0.7	1
21:45-22:00	3	0	3	0.0	0.3	0	42	4	46	8.7	0.9	2
1時間計	20	5	25	20.0	2.1	0	169	11	180	6.1	3.4	7
昼12時間計	742	158	900	17.6	76.7	36	3871	184	4055	4.5	75.9	275
夜12時間計	195	78	273	28.6	23.3	6	1170	117	1287	9.1	24.1	67
全時間合計	937	236	1173	20.1	100.0	42	5041	301	5342	5.6	100.0	342
昼夜率	1.26	1.49	1.30	-	-	1.17	1.30	1.64	1.32	-	-	1.24

方向別自動車交通量調査表

調査地点：地域社会4 瀬谷土橋公園入口

調査年月日：令和2年9月26日(土) 天候：晴れ一時雨



方向 種別 時間帯							A 合計 (1+2)					
	小型車 (台)	大型車 (台)	合計 (台)	大型車 混入率 (%)	時間 係数 (%)	二輪車 (台)	小型車 (台)	大型車 (台)	合計 (台)	大型車 混入率 (%)	時間 係数 (%)	二輪車 (台)
22:00-22:15							39	4	43	9.3	0.7	2
22:15-22:30							36	2	38	5.3	0.6	0
22:30-22:45							26	2	28	7.1	0.4	2
22:45-23:00							25	1	26	3.8	0.4	0
1時間計							126	9	135	6.7	2.1	4
23:00-23:15							30	10	40	25.0	0.6	4
23:15-23:30							24	4	28	14.3	0.4	1
23:30-23:45							25	4	29	13.8	0.4	1
23:45-24:00							25	4	29	13.8	0.4	1
1時間計							104	22	126	17.5	1.9	7
0:00-0:15							28	3	31	9.7	0.5	1
0:15-0:30							15	4	19	21.1	0.3	0
0:30-0:45							21	11	32	34.4	0.5	0
0:45-1:00							11	6	17	35.3	0.3	1
1時間計							75	24	99	24.2	1.5	2
1:00-1:15							12	8	20	40.0	0.3	1
1:15-1:30							10	4	14	28.6	0.2	1
1:30-1:45							10	7	17	41.2	0.3	0
1:45-2:00							12	5	17	29.4	0.3	1
1時間計							44	24	68	35.3	1.0	3
2:00-2:15							4	6	10	60.0	0.2	0
2:15-2:30							11	6	17	35.3	0.3	0
2:30-2:45							11	4	15	26.7	0.2	0
2:45-3:00							8	2	10	20.0	0.2	1
1時間計							34	18	52	34.6	0.8	1
3:00-3:15							7	2	9	22.2	0.1	1
3:15-3:30							2	1	3	33.3	0.0	1
3:30-3:45							8	2	10	20.0	0.2	2
3:45-4:00							4	4	8	50.0	0.1	1
1時間計							21	9	30	30.0	0.5	5
4:00-4:15							17	1	18	5.6	0.3	0
4:15-4:30							9	2	11	18.2	0.2	0
4:30-4:45							6	1	7	14.3	0.1	0
4:45-5:00							8	1	9	11.1	0.1	1
1時間計							40	5	45	11.1	0.7	1
5:00-5:15							11	3	14	21.4	0.2	0
5:15-5:30							16	3	19	15.8	0.3	1
5:30-5:45							18	8	26	30.8	0.4	1
5:45-6:00							20	2	22	9.1	0.3	0
1時間計							65	16	81	19.8	1.2	2

方向別自動車交通量調査表

調査地点：地域社会4 瀬谷土橋公園入口

調査年月日：令和2年9月26日(土) 天候：晴れ一時雨



方向 種別 時間帯							A 合計 (1+2)					
	小型車 (台)	大型車 (台)	合計 (台)	大型車 混入率 (%)	時間 係数 (%)	二輪車 (台)	小型車 (台)	大型車 (台)	合計 (台)	大型車 混入率 (%)	時間 係数 (%)	二輪車 (台)
6:00-6:15							35	5	40	12.5	0.6	4
6:15-6:30							31	7	38	18.4	0.6	2
6:30-6:45							48	5	53	9.4	0.8	3
6:45-7:00							41	8	49	16.3	0.8	2
1時間計							155	25	180	13.9	2.8	11
7:00-7:15							51	9	60	15.0	0.9	3
7:15-7:30							45	9	54	16.7	0.8	4
7:30-7:45							78	16	94	17.0	1.4	7
7:45-8:00							68	6	74	8.1	1.1	7
1時間計							242	40	282	14.2	4.3	21
8:00-8:15							81	9	90	10.0	1.4	10
8:15-8:30							88	7	95	7.4	1.5	1
8:30-8:45							88	6	94	6.4	1.4	7
8:45-9:00							72	2	74	2.7	1.1	9
1時間計							329	24	353	6.8	5.4	27
9:00-9:15							76	6	82	7.3	1.3	6
9:15-9:30							72	4	76	5.3	1.2	4
9:30-9:45							92	9	101	8.9	1.6	7
9:45-10:00							95	3	98	3.1	1.5	6
1時間計							335	22	357	6.2	5.5	23
10:00-10:15							107	8	115	7.0	1.8	8
10:15-10:30							81	12	93	12.9	1.4	9
10:30-10:45							87	9	96	9.4	1.5	4
10:45-11:00							98	8	106	7.5	1.6	9
1時間計							373	37	410	9.0	6.3	30
11:00-11:15							108	11	119	9.2	1.8	11
11:15-11:30							107	8	115	7.0	1.8	4
11:30-11:45							116	6	122	4.9	1.9	3
11:45-12:00							81	3	84	3.6	1.3	8
1時間計							412	28	440	6.4	6.8	26
12:00-12:15							114	4	118	3.4	1.8	5
12:15-12:30							123	10	133	7.5	2.0	3
12:30-12:45							89	9	98	9.2	1.5	9
12:45-13:00							121	9	130	6.9	2.0	2
1時間計							447	32	479	6.7	7.4	19
13:00-13:15							141	11	152	7.2	2.3	10
13:15-13:30							111	5	116	4.3	1.8	4
13:30-13:45							97	11	108	10.2	1.7	4
13:45-14:00							114	9	123	7.3	1.9	7
1時間計							463	36	499	7.2	7.7	25

方向別自動車交通量調査表

調査地点：地域社会4 瀬谷土橋公園入口

調査年月日：令和2年9月26日(土) 天候：晴れ一時雨



時間帯	方向 種別						A 合計 (1+2)					
		小型車 (台)	大型車 (台)	合計 (台)	大型車 混入率 (%)	時 間 係 数 (%)	二輪車 (台)	小型車 (台)	大型車 (台)	合計 (台)	大型車 混入率 (%)	時 間 係 数 (%)
14:00-14:15							140	11	151	7.3	2.3	8
14:15-14:30							102	7	109	6.4	1.7	10
14:30-14:45							98	7	105	6.7	1.6	8
14:45-15:00							113	6	119	5.0	1.8	8
1時間計							453	31	484	6.4	7.4	34
15:00-15:15							101	4	105	3.8	1.6	5
15:15-15:30							107	7	114	6.1	1.7	9
15:30-15:45							99	4	103	3.9	1.6	7
15:45-16:00							99	11	110	10.0	1.7	7
1時間計							406	26	432	6.0	6.6	28
16:00-16:15							118	5	123	4.1	1.9	6
16:15-16:30							105	5	110	4.5	1.7	16
16:30-16:45							130	7	137	5.1	2.1	11
16:45-17:00							85	3	88	3.4	1.4	6
1時間計							438	20	458	4.4	7.0	39
17:00-17:15							125	10	135	7.4	2.1	7
17:15-17:30							67	7	74	9.5	1.1	2
17:30-17:45							105	7	112	6.3	1.7	6
17:45-18:00							87	5	92	5.4	1.4	10
1時間計							384	29	413	7.0	6.3	25
18:00-18:15							108	10	118	8.5	1.8	5
18:15-18:30							74	1	75	1.3	1.2	4
18:30-18:45							78	5	83	6.0	1.3	5
18:45-19:00							71	1	72	1.4	1.1	0
1時間計							331	17	348	4.9	5.3	14
19:00-19:15							92	7	99	7.1	1.5	4
19:15-19:30							95	2	97	2.1	1.5	2
19:30-19:45							56	5	61	8.2	0.9	4
19:45-20:00							58	4	62	6.5	1.0	1
1時間計							301	18	319	5.6	4.9	11
20:00-20:15							57	1	58	1.7	0.9	4
20:15-20:30							57	3	60	5.0	0.9	7
20:30-20:45							53	3	56	5.4	0.9	3
20:45-21:00							44	2	46	4.3	0.7	5
1時間計							211	9	220	4.1	3.4	19
21:00-21:15							57	5	62	8.1	1.0	2
21:15-21:30							46	3	49	6.1	0.8	2
21:30-21:45							41	4	45	8.9	0.7	1
21:45-22:00							45	4	49	8.2	0.8	2
1時間計							189	16	205	7.8	3.1	7
昼12時間計							4613	342	4955	6.9	76.1	311
夜12時間計							1365	195	1560	12.5	23.9	73
全時間合計							5978	537	6515	8.2	100.0	384
昼 夜 率							1.30	1.57	1.31	-	-	1.23

方向別自動車交通量調査表

調査地点 : 地域社会4 瀬谷土橋公園入口

調査年月日 : 令和 2年 9月26日(土) 天候:晴れ一時雨



方向 種別 時間帯	3						4					
	小型車 (台)	大型車 (台)	合計 (台)	大型車 混入率 (%)	時間 係数 (%)	二輪車 (台)	小型車 (台)	大型車 (台)	合計 (台)	大型車 混入率 (%)	時間 係数 (%)	二輪車 (台)
22:00-22:15	33	3	36	8.3	0.7	1	4	1	5	20.0	0.6	0
22:15-22:30	37	3	40	7.5	0.8	1	8	1	9	11.1	1.1	0
22:30-22:45	38	2	40	5.0	0.8	1	8	0	8	0.0	0.9	0
22:45-23:00	29	0	29	0.0	0.6	2	7	1	8	12.5	0.9	0
1時間計	137	8	145	5.5	2.9	5	27	3	30	10.0	3.6	0
23:00-23:15	18	1	19	5.3	0.4	0	4	1	5	20.0	0.6	0
23:15-23:30	9	2	11	18.2	0.2	0	1	0	1	0.0	0.1	0
23:30-23:45	8	1	9	11.1	0.2	2	4	1	5	20.0	0.6	0
23:45-24:00	12	1	13	7.7	0.3	2	1	1	2	50.0	0.2	0
1時間計	47	5	52	9.6	1.0	4	10	3	13	23.1	1.5	0
0:00- 0:15	18	2	20	10.0	0.4	2	2	1	3	33.3	0.4	0
0:15- 0:30	10	1	11	9.1	0.2	1	2	0	2	0.0	0.2	0
0:30- 0:45	13	2	15	13.3	0.3	1	2	1	3	33.3	0.4	0
0:45- 1:00	4	0	4	0.0	0.1	0	1	0	1	0.0	0.1	0
1時間計	45	5	50	10.0	1.0	4	7	2	9	22.2	1.1	0
1:00- 1:15	5	2	7	28.6	0.1	0	0	0	0	0.0	0.0	0
1:15- 1:30	5	3	8	37.5	0.2	0	5	1	6	16.7	0.7	0
1:30- 1:45	5	1	6	16.7	0.1	0	4	0	4	0.0	0.5	0
1:45- 2:00	6	1	7	14.3	0.1	0	0	0	0	0.0	0.0	0
1時間計	21	7	28	25.0	0.6	0	9	1	10	10.0	1.2	0
2:00- 2:15	5	2	7	28.6	0.1	0	0	0	0	0.0	0.0	0
2:15- 2:30	3	0	3	0.0	0.1	0	1	0	1	0.0	0.1	0
2:30- 2:45	6	2	8	25.0	0.2	0	2	0	2	0.0	0.2	0
2:45- 3:00	4	1	5	20.0	0.1	1	0	0	0	0.0	0.0	0
1時間計	18	5	23	21.7	0.5	1	3	0	3	0.0	0.4	0
3:00- 3:15	5	0	5	0.0	0.1	0	0	0	0	0.0	0.0	0
3:15- 3:30	4	2	6	33.3	0.1	0	0	0	0	0.0	0.0	0
3:30- 3:45	3	1	4	25.0	0.1	1	2	2	4	50.0	0.5	0
3:45- 4:00	8	2	10	20.0	0.2	0	2	2	4	50.0	0.5	0
1時間計	20	5	25	20.0	0.5	1	4	4	8	50.0	0.9	0
4:00- 4:15	5	2	7	28.6	0.1	0	4	0	4	0.0	0.5	0
4:15- 4:30	8	1	9	11.1	0.2	0	2	0	2	0.0	0.2	0
4:30- 4:45	5	1	6	16.7	0.1	1	0	0	0	0.0	0.0	0
4:45- 5:00	6	4	10	40.0	0.2	2	5	1	6	16.7	0.7	0
1時間計	24	8	32	25.0	0.6	3	11	1	12	8.3	1.4	0
5:00- 5:15	14	4	18	22.2	0.4	0	6	2	8	25.0	0.9	0
5:15- 5:30	12	1	13	7.7	0.3	1	4	0	4	0.0	0.5	0
5:30- 5:45	10	1	11	9.1	0.2	1	4	0	4	0.0	0.5	0
5:45- 6:00	17	3	20	15.0	0.4	0	10	1	11	9.1	1.3	0
1時間計	53	9	62	14.5	1.3	2	24	3	27	11.1	3.2	0

方向別自動車交通量調査表

調査地点 : 地域社会 4 瀬谷土橋公園入口

調査年月日 : 令和 2年 9月26日(土) 天候:晴れ一時雨



方向	3						4						
	種別	小型車 (台)	大型車 (台)	合計 (台)	大型車 混入率 (%)	時間 係数 (%)	二輪車 (台)	小型車 (台)	大型車 (台)	合計 (台)	大型車 混入率 (%)	時間 係数 (%)	二輪車 (台)
6:00-6:15		18	1	19	5.3	0.4	2	10	0	10	0.0	1.2	0
6:15-6:30		18	2	20	10.0	0.4	1	7	0	7	0.0	0.8	0
6:30-6:45		34	3	37	8.1	0.7	1	4	1	5	20.0	0.6	0
6:45-7:00		32	1	33	3.0	0.7	1	7	2	9	22.2	1.1	0
1時間計		102	7	109	6.4	2.2	5	28	3	31	9.7	3.7	0
7:00-7:15		28	2	30	6.7	0.6	1	9	1	10	10.0	1.2	0
7:15-7:30		35	5	40	12.5	0.8	3	16	0	16	0.0	1.9	0
7:30-7:45		48	2	50	4.0	1.0	6	11	1	12	8.3	1.4	1
7:45-8:00		53	4	57	7.0	1.1	8	19	2	21	9.5	2.5	1
1時間計		164	13	177	7.3	3.6	18	55	4	59	6.8	7.0	2
8:00-8:15		61	8	69	11.6	1.4	10	18	1	19	5.3	2.3	1
8:15-8:30		63	5	68	7.4	1.4	6	9	2	11	18.2	1.3	1
8:30-8:45		70	6	76	7.9	1.5	7	10	1	11	9.1	1.3	3
8:45-9:00		64	6	70	8.6	1.4	5	9	0	9	0.0	1.1	0
1時間計		258	25	283	8.8	5.7	28	46	4	50	8.0	5.9	5
9:00-9:15		69	8	77	10.4	1.6	3	13	8	21	38.1	2.5	0
9:15-9:30		67	9	76	11.8	1.5	4	14	1	15	6.7	1.8	1
9:30-9:45		52	6	58	10.3	1.2	4	11	0	11	0.0	1.3	0
9:45-10:00		77	9	86	10.5	1.7	3	16	1	17	5.9	2.0	0
1時間計		265	32	297	10.8	6.0	14	54	10	64	15.6	7.6	1
10:00-10:15		69	3	72	4.2	1.5	3	9	0	9	0.0	1.1	0
10:15-10:30		51	7	58	12.1	1.2	2	13	1	14	7.1	1.7	2
10:30-10:45		85	4	89	4.5	1.8	4	3	0	3	0.0	0.4	1
10:45-11:00		79	3	82	3.7	1.7	6	7	1	8	12.5	0.9	0
1時間計		284	17	301	5.6	6.1	15	32	2	34	5.9	4.0	3
11:00-11:15		61	1	62	1.6	1.3	3	16	0	16	0.0	1.9	0
11:15-11:30		67	1	68	1.5	1.4	8	12	0	12	0.0	1.4	0
11:30-11:45		64	1	65	1.5	1.3	6	16	0	16	0.0	1.9	0
11:45-12:00		61	3	64	4.7	1.3	5	12	2	14	14.3	1.7	2
1時間計		253	6	259	2.3	5.2	22	56	2	58	3.4	6.9	2
12:00-12:15		89	6	95	6.3	1.9	7	16	0	16	0.0	1.9	0
12:15-12:30		63	4	67	6.0	1.4	11	10	0	10	0.0	1.2	0
12:30-12:45		97	2	99	2.0	2.0	3	14	1	15	6.7	1.8	0
12:45-13:00		75	2	77	2.6	1.6	5	11	6	17	35.3	2.0	1
1時間計		324	14	338	4.1	6.8	26	51	7	58	12.1	6.9	1
13:00-13:15		55	1	56	1.8	1.1	6	15	1	16	6.3	1.9	1
13:15-13:30		87	2	89	2.2	1.8	7	13	1	14	7.1	1.7	0
13:30-13:45		78	3	81	3.7	1.6	7	9	0	9	0.0	1.1	0
13:45-14:00		63	1	64	1.6	1.3	6	8	2	10	20.0	1.2	0
1時間計		283	7	290	2.4	5.8	26	45	4	49	8.2	5.8	1

方向別自動車交通量調査表

調査地点 : 地域社会 4 瀬谷土橋公園入口

調査年月日 : 令和 2年 9月26日(土) 天候:晴れ一時雨



方向	3						4						
	種別	小型車 (台)	大型車 (台)	合計 (台)	大型車 混入率 (%)	時 間 係 数 (%)	二輪車 (台)	小型車 (台)	大型車 (台)	合計 (台)	大型車 混入率 (%)	時 間 係 数 (%)	二輪車 (台)
14:00-14:15		97	5	102	4.9	2.1	8	16	1	17	5.9	2.0	4
14:15-14:30		68	0	68	0.0	1.4	5	14	0	14	0.0	1.7	0
14:30-14:45		83	1	84	1.2	1.7	10	8	1	9	11.1	1.1	0
14:45-15:00		95	0	95	0.0	1.9	7	13	0	13	0.0	1.5	0
1時間計		343	6	349	1.7	7.0	30	51	2	53	3.8	6.3	4
15:00-15:15		114	1	115	0.9	2.3	7	6	0	6	0.0	0.7	0
15:15-15:30		96	3	99	3.0	2.0	10	19	0	19	0.0	2.3	2
15:30-15:45		91	2	93	2.2	1.9	6	14	0	14	0.0	1.7	0
15:45-16:00		106	1	107	0.9	2.2	4	12	2	14	14.3	1.7	2
1時間計		407	7	414	1.7	8.3	27	51	2	53	3.8	6.3	4
16:00-16:15		97	5	102	4.9	2.1	8	14	0	14	0.0	1.7	0
16:15-16:30		100	3	103	2.9	2.1	10	15	0	15	0.0	1.8	0
16:30-16:45		81	5	86	5.8	1.7	6	6	0	6	0.0	0.7	0
16:45-17:00		83	1	84	1.2	1.7	14	14	0	14	0.0	1.7	1
1時間計		361	14	375	3.7	7.6	38	49	0	49	0.0	5.8	1
17:00-17:15		86	6	92	6.5	1.9	5	13	3	16	18.8	1.9	0
17:15-17:30		112	2	114	1.8	2.3	6	15	1	16	6.3	1.9	0
17:30-17:45		100	4	104	3.8	2.1	8	10	0	10	0.0	1.2	0
17:45-18:00		93	1	94	1.1	1.9	4	5	1	6	16.7	0.7	0
1時間計		391	13	404	3.2	8.1	23	43	5	48	10.4	5.7	0
18:00-18:15		91	3	94	3.2	1.9	6	13	1	14	7.1	1.7	0
18:15-18:30		111	1	112	0.9	2.3	4	8	4	12	33.3	1.4	0
18:30-18:45		82	3	85	3.5	1.7	3	7	2	9	22.2	1.1	0
18:45-19:00		91	4	95	4.2	1.9	4	10	0	10	0.0	1.2	0
1時間計		375	11	386	2.8	7.8	17	38	7	45	15.6	5.3	0
19:00-19:15		56	5	61	8.2	1.2	6	15	3	18	16.7	2.1	0
19:15-19:30		47	2	49	4.1	1.0	5	7	0	7	0.0	0.8	0
19:30-19:45		66	1	67	1.5	1.4	4	9	1	10	10.0	1.2	1
19:45-20:00		72	3	75	4.0	1.5	3	7	0	7	0.0	0.8	1
1時間計		241	11	252	4.4	5.1	18	38	4	42	9.5	5.0	2
20:00-20:15		50	1	51	2.0	1.0	2	5	0	5	0.0	0.6	1
20:15-20:30		46	2	48	4.2	1.0	1	6	1	7	14.3	0.8	0
20:30-20:45		45	1	46	2.2	0.9	2	3	1	4	25.0	0.5	0
20:45-21:00		33	1	34	2.9	0.7	4	5	0	5	0.0	0.6	1
1時間計		174	5	179	2.8	3.6	9	19	2	21	9.5	2.5	2
21:00-21:15		26	2	28	7.1	0.6	2	3	1	4	25.0	0.5	0
21:15-21:30		34	2	36	5.6	0.7	0	5	0	5	0.0	0.6	0
21:30-21:45		34	1	35	2.9	0.7	1	3	2	5	40.0	0.6	0
21:45-22:00		29	1	30	3.3	0.6	2	4	0	4	0.0	0.5	0
1時間計		123	6	129	4.7	2.6	5	15	3	18	16.7	2.1	0
昼12時間計		3708	165	3873	4.3	78.1	284	571	49	620	7.9	73.5	24
夜12時間計		1005	81	1086	7.5	21.9	57	195	29	224	12.9	26.5	4
全時間合計		4713	246	4959	5.0	100.0	341	766	78	844	9.2	100.0	28
昼 夜 率		1.27	1.49	1.28	-	-	1.20	1.34	1.59	1.36	-	-	1.17

方向別自動車交通量調査表

調査地点：地域社会4 瀬谷土橋公園入口

調査年月日：令和2年9月26日(土) 天候：晴れ一時雨



方向 種別 時間帯							B 合計 (3+4)					
	小型車 (台)	大型車 (台)	合計 (台)	大型車 混入率 (%)	時間 係数 (%)	二輪車 (台)	小型車 (台)	大型車 (台)	合計 (台)	大型車 混入率 (%)	時間 係数 (%)	二輪車 (台)
22:00-22:15							37	4	41	9.8	0.7	1
22:15-22:30							45	4	49	8.2	0.8	1
22:30-22:45							46	2	48	4.2	0.8	1
22:45-23:00							36	1	37	2.7	0.6	2
1時間計							164	11	175	6.3	3.0	5
23:00-23:15							22	2	24	8.3	0.4	0
23:15-23:30							10	2	12	16.7	0.2	0
23:30-23:45							12	2	14	14.3	0.2	2
23:45-24:00							13	2	15	13.3	0.3	2
1時間計							57	8	65	12.3	1.1	4
0:00-0:15							20	3	23	13.0	0.4	2
0:15-0:30							12	1	13	7.7	0.2	1
0:30-0:45							15	3	18	16.7	0.3	1
0:45-1:00							5	0	5	0.0	0.1	0
1時間計							52	7	59	11.9	1.0	4
1:00-1:15							5	2	7	28.6	0.1	0
1:15-1:30							10	4	14	28.6	0.2	0
1:30-1:45							9	1	10	10.0	0.2	0
1:45-2:00							6	1	7	14.3	0.1	0
1時間計							30	8	38	21.1	0.7	0
2:00-2:15							5	2	7	28.6	0.1	0
2:15-2:30							4	0	4	0.0	0.1	0
2:30-2:45							8	2	10	20.0	0.2	0
2:45-3:00							4	1	5	20.0	0.1	1
1時間計							21	5	26	19.2	0.4	1
3:00-3:15							5	0	5	0.0	0.1	0
3:15-3:30							4	2	6	33.3	0.1	0
3:30-3:45							5	3	8	37.5	0.1	1
3:45-4:00							10	4	14	28.6	0.2	0
1時間計							24	9	33	27.3	0.6	1
4:00-4:15							9	2	11	18.2	0.2	0
4:15-4:30							10	1	11	9.1	0.2	0
4:30-4:45							5	1	6	16.7	0.1	1
4:45-5:00							11	5	16	31.3	0.3	2
1時間計							35	9	44	20.5	0.8	3
5:00-5:15							20	6	26	23.1	0.4	0
5:15-5:30							16	1	17	5.9	0.3	1
5:30-5:45							14	1	15	6.7	0.3	1
5:45-6:00							27	4	31	12.9	0.5	0
1時間計							77	12	89	13.5	1.5	2

方向別自動車交通量調査表

調査地点：地域社会4 瀬谷土橋公園入口

調査年月日：令和2年9月26日(土) 天候：晴れ一時雨



時間帯	方向 種別						B 合計 (3+4)					
		小型車 (台)	大型車 (台)	合計 (台)	大型車 混入率 (%)	時係 数 (%)	二輪車 (台)	小型車 (台)	大型車 (台)	合計 (台)	大型車 混入率 (%)	時係 数 (%)
6:00-6:15							28	1	29	3.4	0.5	2
6:15-6:30							25	2	27	7.4	0.5	1
6:30-6:45							38	4	42	9.5	0.7	1
6:45-7:00							39	3	42	7.1	0.7	1
1時間計							130	10	140	7.1	2.4	5
7:00-7:15							37	3	40	7.5	0.7	1
7:15-7:30							51	5	56	8.9	1.0	3
7:30-7:45							59	3	62	4.8	1.1	7
7:45-8:00							72	6	78	7.7	1.3	9
1時間計							219	17	236	7.2	4.1	20
8:00-8:15							79	9	88	10.2	1.5	11
8:15-8:30							72	7	79	8.9	1.4	7
8:30-8:45							80	7	87	8.0	1.5	10
8:45-9:00							73	6	79	7.6	1.4	5
1時間計							304	29	333	8.7	5.7	33
9:00-9:15							82	16	98	16.3	1.7	3
9:15-9:30							81	10	91	11.0	1.6	5
9:30-9:45							63	6	69	8.7	1.2	4
9:45-10:00							93	10	103	9.7	1.8	3
1時間計							319	42	361	11.6	6.2	15
10:00-10:15							78	3	81	3.7	1.4	3
10:15-10:30							64	8	72	11.1	1.2	4
10:30-10:45							88	4	92	4.3	1.6	5
10:45-11:00							86	4	90	4.4	1.6	6
1時間計							316	19	335	5.7	5.8	18
11:00-11:15							77	1	78	1.3	1.3	3
11:15-11:30							79	1	80	1.3	1.4	8
11:30-11:45							80	1	81	1.2	1.4	6
11:45-12:00							73	5	78	6.4	1.3	7
1時間計							309	8	317	2.5	5.5	24
12:00-12:15							105	6	111	5.4	1.9	7
12:15-12:30							73	4	77	5.2	1.3	11
12:30-12:45							111	3	114	2.6	2.0	3
12:45-13:00							86	8	94	8.5	1.6	6
1時間計							375	21	396	5.3	6.8	27
13:00-13:15							70	2	72	2.8	1.2	7
13:15-13:30							100	3	103	2.9	1.8	7
13:30-13:45							87	3	90	3.3	1.6	7
13:45-14:00							71	3	74	4.1	1.3	6
1時間計							328	11	339	3.2	5.8	27

方向別自動車交通量調査表

調査地点：地域社会4 瀬谷土橋公園入口

調査年月日：令和2年9月26日(土) 天候：晴れ一時雨



方向							B 合計 (3+4)						
	種別	小型車 (台)	大型車 (台)	合計 (台)	大型車 混入率 (%)	時 間 係 数 (%)	二輪車 (台)	小型車 (台)	大型車 (台)	合計 (台)	大型車 混入率 (%)	時 間 係 数 (%)	二輪車 (台)
14:00-14:15								113	6	119	5.0	2.1	12
14:15-14:30								82	0	82	0.0	1.4	5
14:30-14:45								91	2	93	2.2	1.6	10
14:45-15:00								108	0	108	0.0	1.9	7
1時間計								394	8	402	2.0	6.9	34
15:00-15:15								120	1	121	0.8	2.1	7
15:15-15:30								115	3	118	2.5	2.0	12
15:30-15:45								105	2	107	1.9	1.8	6
15:45-16:00								118	3	121	2.5	2.1	6
1時間計								458	9	467	1.9	8.0	31
16:00-16:15								111	5	116	4.3	2.0	8
16:15-16:30								115	3	118	2.5	2.0	10
16:30-16:45								87	5	92	5.4	1.6	6
16:45-17:00								97	1	98	1.0	1.7	15
1時間計								410	14	424	3.3	7.3	39
17:00-17:15								99	9	108	8.3	1.9	5
17:15-17:30								127	3	130	2.3	2.2	6
17:30-17:45								110	4	114	3.5	2.0	8
17:45-18:00								98	2	100	2.0	1.7	4
1時間計								434	18	452	4.0	7.8	23
18:00-18:15								104	4	108	3.7	1.9	6
18:15-18:30								119	5	124	4.0	2.1	4
18:30-18:45								89	5	94	5.3	1.6	3
18:45-19:00								101	4	105	3.8	1.8	4
1時間計								413	18	431	4.2	7.4	17
19:00-19:15								71	8	79	10.1	1.4	6
19:15-19:30								54	2	56	3.6	1.0	5
19:30-19:45								75	2	77	2.6	1.3	5
19:45-20:00								79	3	82	3.7	1.4	4
1時間計								279	15	294	5.1	5.1	20
20:00-20:15								55	1	56	1.8	1.0	3
20:15-20:30								52	3	55	5.5	0.9	1
20:30-20:45								48	2	50	4.0	0.9	2
20:45-21:00								38	1	39	2.6	0.7	5
1時間計								193	7	200	3.5	3.4	11
21:00-21:15								29	3	32	9.4	0.6	2
21:15-21:30								39	2	41	4.9	0.7	0
21:30-21:45								37	3	40	7.5	0.7	1
21:45-22:00								33	1	34	2.9	0.6	2
1時間計								138	9	147	6.1	2.5	5
昼12時間計								4279	214	4493	4.8	77.4	308
夜12時間計								1200	110	1310	8.4	22.6	61
全時間合計								5479	324	5803	5.6	100.0	369
昼 夜 率								1.28	1.51	1.29	-	-	1.20

方向別自動車交通量調査表

調査地点：地域社会4 瀬谷土橋公園入口

調査年月日：令和2年9月26日(土) 天候：晴れ一時雨



方向 種別 時間帯	5						6					
	小型車 (台)	大型車 (台)	合計 (台)	大型車 混入率 (%)	時間 係数 (%)	二輪車 (台)	小型車 (台)	大型車 (台)	合計 (台)	大型車 混入率 (%)	時間 係数 (%)	二輪車 (台)
22:00-22:15	5	1	6	16.7	2.0	0	17	4	21	19.0	0.7	0
22:15-22:30	3	2	5	40.0	1.7	0	17	1	18	5.8	0.6	0
22:30-22:45	1	0	1	0.0	0.3	0	14	3	17	17.6	0.6	0
22:45-23:00	1	0	1	0.0	0.3	0	13	1	14	7.1	0.5	0
1時間計	10	3	13	23.1	4.3	0	61	9	70	12.9	2.5	0
23:00-23:15	5	1	6	16.7	2.0	0	8	0	8	0.0	0.3	1
23:15-23:30	1	0	1	0.0	0.3	0	8	1	9	11.1	0.3	0
23:30-23:45	3	0	3	0.0	1.0	0	5	0	5	0.0	0.2	0
23:45-24:00	3	0	3	0.0	1.0	0	10	4	14	28.6	0.5	1
1時間計	12	1	13	7.7	4.3	0	31	5	36	13.9	1.3	2
0:00-0:15	1	0	1	0.0	0.3	0	9	1	10	10.0	0.4	1
0:15-0:30	2	1	3	33.3	1.0	0	3	0	3	0.0	0.1	1
0:30-0:45	0	0	0	0.0	0.0	0	5	1	6	16.7	0.2	1
0:45-1:00	0	0	0	0.0	0.0	0	3	0	3	0.0	0.1	0
1時間計	3	1	4	25.0	1.3	0	20	2	22	9.1	0.8	3
1:00-1:15	0	0	0	0.0	0.0	0	9	3	12	25.0	0.4	0
1:15-1:30	1	1	2	50.0	0.7	0	5	2	7	28.6	0.2	0
1:30-1:45	0	0	0	0.0	0.0	0	5	1	6	16.7	0.2	0
1:45-2:00	4	0	4	0.0	1.3	0	3	0	3	0.0	0.1	0
1時間計	5	1	6	16.7	2.0	0	22	6	28	21.4	1.0	0
2:00-2:15	2	0	2	0.0	0.7	0	5	0	5	0.0	0.2	0
2:15-2:30	1	0	1	0.0	0.3	0	2	0	2	0.0	0.1	0
2:30-2:45	0	0	0	0.0	0.0	0	2	0	2	0.0	0.1	0
2:45-3:00	0	0	0	0.0	0.0	2	0	0	0	0.0	0.0	0
1時間計	3	0	3	0.0	1.0	2	9	0	9	0.0	0.3	0
3:00-3:15	0	0	0	0.0	0.0	0	3	0	3	0.0	0.1	0
3:15-3:30	4	0	4	0.0	1.3	0	3	1	4	25.0	0.1	0
3:30-3:45	1	0	1	0.0	0.3	0	3	1	4	25.0	0.1	0
3:45-4:00	1	0	1	0.0	0.3	1	2	1	3	33.3	0.1	1
1時間計	6	0	6	0.0	2.0	1	11	3	14	21.4	0.5	1
4:00-4:15	1	1	2	50.0	0.7	0	1	0	1	0.0	0.0	0
4:15-4:30	1	0	1	0.0	0.3	0	7	0	7	0.0	0.2	0
4:30-4:45	1	0	1	0.0	0.3	0	4	1	5	20.0	0.2	0
4:45-5:00	1	0	1	0.0	0.3	0	3	0	3	0.0	0.1	0
1時間計	4	1	5	20.0	1.7	0	15	1	16	6.3	0.6	0
5:00-5:15	1	0	1	0.0	0.3	0	4	0	4	0.0	0.1	1
5:15-5:30	2	1	3	33.3	1.0	1	2	1	3	33.3	0.1	0
5:30-5:45	0	0	0	0.0	0.0	0	3	0	3	0.0	0.1	0
5:45-6:00	0	0	0	0.0	0.0	0	6	0	6	0.0	0.2	0
1時間計	3	1	4	25.0	1.3	1	15	1	16	6.3	0.6	1

方向別自動車交通量調査表

調査地点：地域社会4 瀬谷土橋公園入口

調査年月日：令和2年9月26日(土) 天候：晴れ一時雨



方向 時間帯	5						6					
	種別 小型車 (台)	大型車 (台)	合計 (台)	大型車 混入率 (%)	時間 係数 (%)	二輪車 (台)	小型車 (台)	大型車 (台)	合計 (台)	大型車 混入率 (%)	時間 係数 (%)	二輪車 (台)
6:00-6:15	0	0	0	0.0	0.0	0	8	2	10	20.0	0.4	0
6:15-6:30	3	0	3	0.0	1.0	0	7	3	10	30.0	0.4	0
6:30-6:45	0	0	0	0.0	0.0	0	7	4	11	36.4	0.4	0
6:45-7:00	0	0	0	0.0	0.0	0	6	0	6	0.0	0.2	1
1時間計	3	0	3	0.0	1.0	0	28	9	37	24.3	1.3	1
7:00-7:15	0	0	0	0.0	0.0	0	14	1	15	6.7	0.5	1
7:15-7:30	2	0	2	0.0	0.7	0	25	3	28	10.7	1.0	0
7:30-7:45	4	1	5	20.0	1.7	0	22	2	24	8.3	0.8	2
7:45-8:00	0	0	0	0.0	0.0	1	32	5	37	13.5	1.3	3
1時間計	6	1	7	14.3	2.3	1	93	11	104	10.6	3.7	6
8:00-8:15	1	0	1	0.0	0.3	2	41	3	44	6.8	1.6	0
8:15-8:30	3	0	3	0.0	1.0	0	33	2	35	5.7	1.2	0
8:30-8:45	6	0	6	0.0	2.0	0	46	6	52	11.5	1.8	2
8:45-9:00	4	0	4	0.0	1.3	0	33	0	33	0.0	1.2	0
1時間計	14	0	14	0.0	4.7	2	153	11	164	6.7	5.8	2
9:00-9:15	2	1	3	33.3	1.0	1	45	3	48	6.3	1.7	3
9:15-9:30	4	0	4	0.0	1.3	1	45	1	46	2.2	1.6	2
9:30-9:45	2	0	2	0.0	0.7	0	60	3	63	4.8	2.2	0
9:45-10:00	3	2	5	40.0	1.7	0	38	1	39	2.6	1.4	1
1時間計	11	3	14	21.4	4.7	2	188	8	196	4.1	6.9	6
10:00-10:15	2	0	2	0.0	0.7	1	50	0	50	0.0	1.8	1
10:15-10:30	4	0	4	0.0	1.3	0	55	1	56	1.8	2.0	3
10:30-10:45	9	1	10	10.0	3.3	2	41	6	47	12.8	1.7	0
10:45-11:00	3	0	3	0.0	1.0	0	35	0	35	0.0	1.2	1
1時間計	18	1	19	5.3	6.4	3	181	7	188	3.7	6.7	5
11:00-11:15	5	0	5	0.0	1.7	1	55	1	56	1.8	2.0	1
11:15-11:30	4	0	4	0.0	1.3	0	48	5	53	9.4	1.9	4
11:30-11:45	4	0	4	0.0	1.3	0	52	1	53	1.9	1.9	1
11:45-12:00	5	0	5	0.0	1.7	0	51	0	51	0.0	1.8	2
1時間計	18	0	18	0.0	6.0	1	206	7	213	3.3	7.5	8
12:00-12:15	3	2	5	40.0	1.7	0	58	4	62	6.5	2.2	1
12:15-12:30	3	0	3	0.0	1.0	0	44	2	46	4.3	1.6	0
12:30-12:45	5	0	5	0.0	1.7	0	57	4	61	6.6	2.2	4
12:45-13:00	6	1	7	14.3	2.3	0	34	1	35	2.9	1.2	2
1時間計	17	3	20	15.0	6.7	0	193	11	204	5.4	7.2	7
13:00-13:15	9	1	10	10.0	3.3	2	54	3	57	5.3	2.0	1
13:15-13:30	4	0	4	0.0	1.3	0	52	1	53	1.9	1.9	0
13:30-13:45	5	0	5	0.0	1.7	0	46	3	49	6.1	1.7	1
13:45-14:00	4	0	4	0.0	1.3	0	48	3	51	5.9	1.8	1
1時間計	22	1	23	4.3	7.7	2	200	10	210	4.8	7.4	3

方向別自動車交通量調査表

調査地点：地域社会4 瀬谷土橋公園入口

調査年月日：令和2年9月26日(土) 天候：晴れ一時雨



方向 種別 時間帯	5						6					
	小型車 (台)	大型車 (台)	合計 (台)	大型車 混入率 (%)	時間 係数 (%)	二輪車 (台)	小型車 (台)	大型車 (台)	合計 (台)	大型車 混入率 (%)	時間 係数 (%)	二輪車 (台)
14:00-14:15	4	1	5	20.0	1.7	1	45	1	46	2.2	1.6	4
14:15-14:30	4	0	4	0.0	1.3	1	49	1	50	2.0	1.8	1
14:30-14:45	4	0	4	0.0	1.3	0	47	3	50	6.0	1.8	3
14:45-15:00	2	1	3	33.3	1.0	1	54	0	54	0.0	1.9	4
1時間計	14	2	16	12.5	5.4	3	195	5	200	2.5	7.1	12
15:00-15:15	4	0	4	0.0	1.3	1	46	4	50	8.0	1.8	2
15:15-15:30	3	1	4	25.0	1.3	0	27	1	28	3.6	1.0	2
15:30-15:45	5	0	5	0.0	1.7	0	58	1	59	1.7	2.1	2
15:45-16:00	2	1	3	33.3	1.0	0	56	0	56	0.0	2.0	3
1時間計	14	2	16	12.5	5.4	1	187	6	193	3.1	6.8	9
16:00-16:15	7	0	7	0.0	2.3	0	52	2	54	3.7	1.9	4
16:15-16:30	5	0	5	0.0	1.7	1	45	2	47	4.3	1.7	2
16:30-16:45	6	0	6	0.0	2.0	1	70	0	70	0.0	2.5	8
16:45-17:00	9	0	9	0.0	3.0	2	53	1	54	1.9	1.9	5
1時間計	27	0	27	0.0	9.0	4	220	5	225	2.2	8.0	19
17:00-17:15	11	0	11	0.0	3.7	0	53	2	55	3.6	1.9	4
17:15-17:30	2	0	2	0.0	0.7	0	54	2	56	3.6	2.0	2
17:30-17:45	9	0	9	0.0	3.0	0	61	1	62	1.6	2.2	1
17:45-18:00	5	0	5	0.0	1.7	1	52	1	53	1.9	1.9	3
1時間計	27	0	27	0.0	9.0	1	220	6	226	2.7	8.0	10
18:00-18:15	4	0	4	0.0	1.3	1	38	1	39	2.6	1.4	1
18:15-18:30	6	0	6	0.0	2.0	0	37	0	37	0.0	1.3	2
18:30-18:45	11	1	12	8.3	4.0	1	31	1	32	3.1	1.1	2
18:45-19:00	0	0	0	0.0	0.0	0	36	0	36	0.0	1.3	1
1時間計	21	1	22	4.5	7.4	2	142	2	144	1.4	5.1	6
19:00-19:15	0	0	0	0.0	0.0	0	51	2	53	3.8	1.9	0
19:15-19:30	2	0	2	0.0	0.7	4	30	0	30	0.0	1.1	1
19:30-19:45	1	0	1	0.0	0.3	1	19	2	21	9.5	0.7	0
19:45-20:00	3	0	3	0.0	1.0	1	31	0	31	0.0	1.1	1
1時間計	6	0	6	0.0	2.0	6	131	4	135	3.0	4.8	2
20:00-20:15	1	0	1	0.0	0.3	1	26	1	27	3.7	1.0	2
20:15-20:30	3	0	3	0.0	1.0	0	25	2	27	7.4	1.0	0
20:30-20:45	2	0	2	0.0	0.7	0	18	0	18	0.0	0.6	2
20:45-21:00	2	0	2	0.0	0.7	0	16	1	17	5.9	0.6	1
1時間計	8	0	8	0.0	2.7	1	85	4	89	4.5	3.1	5
21:00-21:15	2	0	2	0.0	0.7	0	19	0	19	0.0	0.7	0
21:15-21:30	2	0	2	0.0	0.7	0	25	2	27	7.4	1.0	0
21:30-21:45	0	0	0	0.0	0.0	0	24	0	24	0.0	0.8	0
21:45-22:00	1	0	1	0.0	0.3	1	12	5	17	29.4	0.6	0
1時間計	5	0	5	0.0	1.7	1	80	7	87	8.0	3.1	0
昼12時間計	209	14	223	6.3	74.6	22	2178	89	2267	3.9	80.2	93
夜12時間計	68	8	76	10.5	25.4	12	508	51	559	9.1	19.8	15
全時間合計	277	22	299	7.4	100.0	34	2686	140	2826	5.0	100.0	108
昼夜率	1.33	1.57	1.34	-	-	1.55	1.23	1.57	1.25	-	-	1.16

方向別自動車交通量調査表

調査地点：地域社会4 瀬谷土橋公園入口

調査年月日：令和2年9月26日(土) 天候：晴れ一時雨



方向 種別 時間帯							C 合計 (5+6)					
	小型車 (台)	大型車 (台)	合計 (台)	大型車 混入率 (%)	時間 係数 (%)	二輪車 (台)	小型車 (台)	大型車 (台)	合計 (台)	大型車 混入率 (%)	時間 係数 (%)	二輪車 (台)
22:00-22:15							22	5	27	18.5	0.9	0
22:15-22:30							20	3	23	13.0	0.7	0
22:30-22:45							15	3	18	16.7	0.6	0
22:45-23:00							14	1	15	6.7	0.5	0
1時間計							71	12	83	14.5	2.7	0
23:00-23:15							13	1	14	7.1	0.4	1
23:15-23:30							9	1	10	10.0	0.3	0
23:30-23:45							8	0	8	0.0	0.3	0
23:45-24:00							13	4	17	23.5	0.5	1
1時間計							43	6	49	12.2	1.6	2
0:00-0:15							10	1	11	9.1	0.4	1
0:15-0:30							5	1	6	16.7	0.2	1
0:30-0:45							5	1	6	16.7	0.2	1
0:45-1:00							3	0	3	0.0	0.1	0
1時間計							23	3	26	11.5	0.8	3
1:00-1:15							9	3	12	25.0	0.4	0
1:15-1:30							6	3	9	33.3	0.3	0
1:30-1:45							5	1	6	16.7	0.2	0
1:45-2:00							7	0	7	0.0	0.2	0
1時間計							27	7	34	20.6	1.1	0
2:00-2:15							7	0	7	0.0	0.2	0
2:15-2:30							3	0	3	0.0	0.1	0
2:30-2:45							2	0	2	0.0	0.1	0
2:45-3:00							0	0	0	0.0	0.0	2
1時間計							12	0	12	0.0	0.4	2
3:00-3:15							3	0	3	0.0	0.1	0
3:15-3:30							7	1	8	12.5	0.3	0
3:30-3:45							4	1	5	20.0	0.2	0
3:45-4:00							3	1	4	25.0	0.1	2
1時間計							17	3	20	15.0	0.6	2
4:00-4:15							2	1	3	33.3	0.1	0
4:15-4:30							8	0	8	0.0	0.3	0
4:30-4:45							5	1	6	16.7	0.2	0
4:45-5:00							4	0	4	0.0	0.1	0
1時間計							19	2	21	9.5	0.7	0
5:00-5:15							5	0	5	0.0	0.2	1
5:15-5:30							4	2	6	33.3	0.2	1
5:30-5:45							3	0	3	0.0	0.1	0
5:45-6:00							6	0	6	0.0	0.2	0
1時間計							18	2	20	10.0	0.6	2

方向別自動車交通量調査表

調査地点：地域社会4 瀬谷土橋公園入口

調査年月日：令和2年9月26日(土) 天候：晴れ一時雨



方向 種別 時間帯							C 合計 (5+6)					
	小型車 (台)	大型車 (台)	合計 (台)	大型車 混入率 (%)	時間 係数 (%)	二輪車 (台)	小型車 (台)	大型車 (台)	合計 (台)	大型車 混入率 (%)	時間 係数 (%)	二輪車 (台)
6:00-6:15							8	2	10	20.0	0.3	0
6:15-6:30							10	3	13	23.1	0.4	0
6:30-6:45							7	4	11	36.4	0.4	0
6:45-7:00							6	0	6	0.0	0.2	1
1時間計							31	9	40	22.5	1.3	1
7:00-7:15							14	1	15	6.7	0.5	1
7:15-7:30							27	3	30	10.0	1.0	0
7:30-7:45							26	3	29	10.3	0.9	2
7:45-8:00							32	5	37	13.5	1.2	4
1時間計							99	12	111	10.8	3.6	7
8:00-8:15							42	3	45	6.7	1.4	2
8:15-8:30							36	2	38	5.3	1.2	0
8:30-8:45							52	6	58	10.3	1.9	2
8:45-9:00							37	0	37	0.0	1.2	0
1時間計							167	11	178	6.2	5.7	4
9:00-9:15							47	4	51	7.8	1.6	4
9:15-9:30							49	1	50	2.0	1.6	3
9:30-9:45							62	3	65	4.6	2.1	0
9:45-10:00							41	3	44	6.8	1.4	1
1時間計							199	11	210	5.2	6.7	8
10:00-10:15							52	0	52	0.0	1.7	2
10:15-10:30							59	1	60	1.7	1.9	3
10:30-10:45							50	7	57	12.3	1.8	2
10:45-11:00							38	0	38	0.0	1.2	1
1時間計							199	8	207	3.9	6.6	8
11:00-11:15							60	1	61	1.6	2.0	2
11:15-11:30							52	5	57	8.8	1.8	4
11:30-11:45							56	1	57	1.8	1.8	1
11:45-12:00							56	0	56	0.0	1.8	2
1時間計							224	7	231	3.0	7.4	9
12:00-12:15							61	6	67	9.0	2.1	1
12:15-12:30							47	2	49	4.1	1.6	0
12:30-12:45							62	4	66	6.1	2.1	4
12:45-13:00							40	2	42	4.8	1.3	2
1時間計							210	14	224	6.3	7.2	7
13:00-13:15							63	4	67	6.0	2.1	3
13:15-13:30							56	1	57	1.8	1.8	0
13:30-13:45							51	3	54	5.6	1.7	1
13:45-14:00							52	3	55	5.5	1.8	1
1時間計							222	11	233	4.7	7.5	5

方向別自動車交通量調査表

調査地点：地域社会4 瀬谷土橋公園入口

調査年月日：令和2年9月26日(土) 天候：晴れ一時雨



方向 種別 時間帯							C 合計 (5+6)					
	小型車 (台)	大型車 (台)	合計 (台)	大型車 混入率 (%)	時間 係数 (%)	二輪車 (台)	小型車 (台)	大型車 (台)	合計 (台)	大型車 混入率 (%)	時間 係数 (%)	二輪車 (台)
14:00-14:15							49	2	51	3.9	1.6	5
14:15-14:30							53	1	54	1.9	1.7	2
14:30-14:45							51	3	54	5.6	1.7	3
14:45-15:00							56	1	57	1.8	1.8	5
1時間計							209	7	216	3.2	6.9	15
15:00-15:15							50	4	54	7.4	1.7	3
15:15-15:30							30	2	32	6.3	1.0	2
15:30-15:45							63	1	64	1.6	2.0	2
15:45-16:00							58	1	59	1.7	1.9	3
1時間計							201	8	209	3.8	6.7	10
16:00-16:15							59	2	61	3.3	2.0	4
16:15-16:30							50	2	52	3.8	1.7	3
16:30-16:45							76	0	76	0.0	2.4	9
16:45-17:00							62	1	63	1.6	2.0	7
1時間計							247	5	252	2.0	8.1	23
17:00-17:15							64	2	66	3.0	2.1	4
17:15-17:30							56	2	58	3.4	1.9	2
17:30-17:45							70	1	71	1.4	2.3	1
17:45-18:00							57	1	58	1.7	1.9	4
1時間計							247	6	253	2.4	8.1	11
18:00-18:15							42	1	43	2.3	1.4	2
18:15-18:30							43	0	43	0.0	1.4	2
18:30-18:45							42	2	44	4.5	1.4	3
18:45-19:00							36	0	36	0.0	1.2	1
1時間計							163	3	166	1.8	5.3	8
19:00-19:15							51	2	53	3.8	1.7	0
19:15-19:30							32	0	32	0.0	1.0	5
19:30-19:45							20	2	22	9.1	0.7	1
19:45-20:00							34	0	34	0.0	1.1	2
1時間計							137	4	141	2.8	4.5	8
20:00-20:15							27	1	28	3.6	0.9	3
20:15-20:30							28	2	30	6.7	1.0	0
20:30-20:45							20	0	20	0.0	0.6	2
20:45-21:00							18	1	19	5.3	0.6	1
1時間計							93	4	97	4.1	3.1	6
21:00-21:15							21	0	21	0.0	0.7	0
21:15-21:30							27	2	29	6.9	0.9	0
21:30-21:45							24	0	24	0.0	0.8	0
21:45-22:00							13	5	18	27.8	0.6	1
1時間計							85	7	92	7.6	2.9	1
昼12時間計							2387	103	2490	4.1	79.7	115
夜12時間計							576	59	635	9.3	20.3	27
全時間合計							2963	162	3125	5.2	100.0	142
昼夜率							1.24	1.57	1.26	-	-	1.23

方向別自動車交通量調査表

調査地点 : 地域社会 4 瀬谷土橋公園前

調査年月日 : 令和 2年 9月26日(土) 天候:晴れ一時雨



方向 種別 時間帯	1						2					
	小型車 (台)	大型車 (台)	合計 (台)	大型車 混入率 (%)	時間 係数 (%)	二輪車 (台)	小型車 (台)	大型車 (台)	合計 (台)	大型車 混入率 (%)	時間 係数 (%)	二輪車 (台)
22:00-22:15	1	4	5	80.0	1.1	0	13	2	15	13.3	0.5	0
22:15-22:30	2	0	2	0.0	0.4	0	21	0	21	0.0	0.8	0
22:30-22:45	0	1	1	100.0	0.2	0	13	1	14	7.1	0.5	0
22:45-23:00	5	1	6	16.7	1.3	0	14	0	14	0.0	0.5	0
1時間計	8	6	14	42.9	3.0	0	61	3	64	4.7	2.3	0
23:00-23:15	0	0	0	0.0	0.0	0	12	0	12	0.0	0.4	1
23:15-23:30	2	0	2	0.0	0.4	0	9	0	9	0.0	0.3	0
23:30-23:45	2	1	3	33.3	0.6	0	7	0	7	0.0	0.3	0
23:45-24:00	1	0	1	0.0	0.2	0	12	1	13	7.7	0.5	0
1時間計	5	1	6	16.7	1.3	0	40	1	41	2.4	1.5	1
0:00-0:15	2	2	4	50.0	0.9	0	9	1	10	10.0	0.4	1
0:15-0:30	1	0	1	0.0	0.2	0	4	1	5	20.0	0.2	0
0:30-0:45	0	0	0	0.0	0.0	0	4	0	4	0.0	0.1	1
0:45-1:00	1	0	1	0.0	0.2	0	3	0	3	0.0	0.1	0
1時間計	4	2	6	33.3	1.3	0	20	2	22	9.1	0.8	2
1:00-1:15	1	1	2	50.0	0.4	2	6	2	8	25.0	0.3	0
1:15-1:30	2	2	4	50.0	0.9	0	3	3	6	50.0	0.2	0
1:30-1:45	0	8	8	100.0	1.7	0	3	0	3	0.0	0.1	0
1:45-2:00	0	6	6	100.0	1.3	0	4	2	6	33.3	0.2	1
1時間計	3	17	20	85.0	4.3	2	16	7	23	30.4	0.8	1
2:00-2:15	3	5	8	62.5	1.7	0	4	0	4	0.0	0.1	0
2:15-2:30	2	4	6	66.7	1.3	0	1	0	1	0.0	0.0	0
2:30-2:45	0	5	5	100.0	1.1	1	4	0	4	0.0	0.1	0
2:45-3:00	2	1	3	33.3	0.6	0	1	0	1	0.0	0.0	1
1時間計	7	15	22	68.2	4.7	1	10	0	10	0.0	0.4	1
3:00-3:15	3	0	3	0.0	0.6	0	2	0	2	0.0	0.1	0
3:15-3:30	0	1	1	100.0	0.2	0	4	1	5	20.0	0.2	0
3:30-3:45	2	0	2	0.0	0.4	0	2	0	2	0.0	0.1	0
3:45-4:00	0	0	0	0.0	0.0	1	2	1	3	33.3	0.1	0
1時間計	5	1	6	16.7	1.3	1	10	2	12	16.7	0.4	0
4:00-4:15	0	2	2	100.0	0.4	0	1	0	1	0.0	0.0	0
4:15-4:30	2	0	2	0.0	0.4	0	8	1	9	11.1	0.3	0
4:30-4:45	0	0	0	0.0	0.0	0	4	1	5	20.0	0.2	1
4:45-5:00	4	0	4	0.0	0.9	2	3	0	3	0.0	0.1	0
1時間計	6	2	8	25.0	1.7	2	16	2	18	11.1	0.6	1
5:00-5:15	1	2	3	66.7	0.6	1	6	2	8	25.0	0.3	2
5:15-5:30	2	1	3	33.3	0.6	0	4	2	6	33.3	0.2	1
5:30-5:45	4	1	5	20.0	1.1	0	3	0	3	0.0	0.1	0
5:45-6:00	0	1	1	100.0	0.2	1	7	1	8	12.5	0.3	0
1時間計	7	5	12	41.7	2.6	2	20	5	25	20.0	0.9	3

方向別自動車交通量調査表

調査地点 : 地域社会4 瀬谷土橋公園前

調査年月日 : 令和 2年 9月26日(土) 天候:晴れ一時雨



時間帯	1						2					
	小型車 (台)	大型車 (台)	合計 (台)	大型車 混入率 (%)	時係 数 (%)	二輪車 (台)	小型車 (台)	大型車 (台)	合計 (台)	大型車 混入率 (%)	時係 数 (%)	二輪車 (台)
6:00-6:15	2	6	8	75.0	1.7	0	11	1	12	8.3	0.4	0
6:15-6:30	2	0	2	0.0	0.4	0	7	3	10	30.0	0.4	0
6:30-6:45	3	5	8	62.5	1.7	0	6	0	6	0.0	0.2	0
6:45-7:00	3	3	6	50.0	1.3	0	10	0	10	0.0	0.4	1
1時間計	10	14	24	58.3	5.1	0	34	4	38	10.5	1.4	1
7:00-7:15	6	1	7	14.3	1.5	0	15	1	16	6.3	0.6	1
7:15-7:30	4	1	5	20.0	1.1	5	22	3	25	12.0	0.9	2
7:30-7:45	1	0	1	0.0	0.2	0	29	2	31	6.5	1.1	3
7:45-8:00	2	0	2	0.0	0.4	0	33	4	37	10.8	1.3	4
1時間計	13	2	15	13.3	3.2	5	99	10	109	9.2	3.9	10
8:00-8:15	6	0	6	0.0	1.3	0	35	1	36	2.8	1.3	1
8:15-8:30	4	0	4	0.0	0.9	0	36	1	37	2.7	1.3	0
8:30-8:45	5	2	7	28.6	1.5	0	46	2	48	4.2	1.7	2
8:45-9:00	3	0	3	0.0	0.6	0	37	0	37	0.0	1.3	0
1時間計	18	2	20	10.0	4.3	0	154	4	158	2.5	5.6	3
9:00-9:15	6	1	7	14.3	1.5	0	52	2	54	3.7	1.9	2
9:15-9:30	5	0	5	0.0	1.1	0	38	1	39	2.6	1.4	3
9:30-9:45	2	2	4	50.0	0.9	1	43	0	43	0.0	1.5	0
9:45-10:00	2	1	3	33.3	0.6	0	43	2	45	4.4	1.6	1
1時間計	15	4	19	21.1	4.1	1	176	5	181	2.8	6.5	6
10:00-10:15	2	6	8	75.0	1.7	0	48	0	48	0.0	1.7	3
10:15-10:30	9	8	17	47.1	3.6	1	39	1	40	2.5	1.4	2
10:30-10:45	6	8	14	57.1	3.0	0	52	4	56	7.1	2.0	2
10:45-11:00	5	2	7	28.6	1.5	1	45	2	47	4.3	1.7	1
1時間計	22	24	46	52.2	9.8	2	184	7	191	3.7	6.8	8
11:00-11:15	8	9	17	52.9	3.6	1	57	1	58	1.7	2.1	2
11:15-11:30	5	3	8	37.5	1.7	1	47	3	50	6.0	1.8	4
11:30-11:45	5	3	8	37.5	1.7	0	54	1	55	1.8	2.0	1
11:45-12:00	7	0	7	0.0	1.5	0	50	2	52	3.8	1.9	1
1時間計	25	15	40	37.5	8.5	2	208	7	215	3.3	7.7	8
12:00-12:15	3	4	7	57.1	1.5	2	55	6	61	9.8	2.2	1
12:15-12:30	1	4	5	80.0	1.1	0	43	2	45	4.4	1.6	1
12:30-12:45	2	5	7	71.4	1.5	0	54	3	57	5.3	2.0	3
12:45-13:00	3	3	6	50.0	1.3	0	43	1	44	2.3	1.6	2
1時間計	9	16	25	64.0	5.3	2	195	12	207	5.8	7.4	7
13:00-13:15	8	3	11	27.3	2.4	1	57	2	59	3.4	2.1	1
13:15-13:30	3	0	3	0.0	0.6	1	52	0	52	0.0	1.9	2
13:30-13:45	6	1	7	14.3	1.5	0	49	4	53	7.5	1.9	1
13:45-14:00	3	2	5	40.0	1.1	0	47	3	50	6.0	1.8	1
1時間計	20	6	26	23.1	5.6	2	205	9	214	4.2	7.6	5

方向別自動車交通量調査表

調査地点：地域社会4 瀬谷土橋公園前

調査年月日：令和2年9月26日(土) 天候：晴れ一時雨



方向 種別 時間帯	1						2					
	小型車 (台)	大型車 (台)	合計 (台)	大型車 混入率 (%)	時間 係数 (%)	二輪車 (台)	小型車 (台)	大型車 (台)	合計 (台)	大型車 混入率 (%)	時間 係数 (%)	二輪車 (台)
14:00-14:15	1	0	1	0.0	0.2	0	44	3	47	6.4	1.7	6
14:15-14:30	2	0	2	0.0	0.4	0	49	0	49	0.0	1.8	2
14:30-14:45	9	2	11	18.2	2.4	2	47	1	48	2.1	1.7	3
14:45-15:00	5	0	5	0.0	1.1	0	50	0	50	0.0	1.8	6
1時間計	17	2	19	10.5	4.1	2	190	4	194	2.1	6.9	17
15:00-15:15	6	2	8	25.0	1.7	1	44	0	44	0.0	1.6	3
15:15-15:30	3	1	4	25.0	0.9	0	26	1	27	3.7	1.0	2
15:30-15:45	7	2	9	22.2	1.9	2	59	1	60	1.7	2.1	3
15:45-16:00	3	0	3	0.0	0.6	0	57	1	58	1.7	2.1	4
1時間計	19	5	24	20.8	5.1	3	186	3	189	1.6	6.8	12
16:00-16:15	8	3	11	27.3	2.4	1	56	4	60	6.7	2.1	3
16:15-16:30	0	4	4	100.0	0.9	0	45	1	46	2.2	1.6	5
16:30-16:45	3	8	11	72.7	2.4	0	61	1	62	1.6	2.2	9
16:45-17:00	1	5	6	83.3	1.3	0	52	2	54	3.7	1.9	7
1時間計	12	20	32	62.5	6.8	1	214	8	222	3.6	7.9	24
17:00-17:15	7	4	11	36.4	2.4	2	62	0	62	0.0	2.2	4
17:15-17:30	5	5	10	50.0	2.1	0	58	1	59	1.7	2.1	1
17:30-17:45	5	4	9	44.4	1.9	0	56	2	58	3.4	2.1	1
17:45-18:00	4	1	5	20.0	1.1	1	56	0	56	0.0	2.0	3
1時間計	21	14	35	40.0	7.5	3	232	3	235	1.3	8.4	9
18:00-18:15	1	2	3	66.7	0.6	0	28	0	28	0.0	1.0	2
18:15-18:30	4	0	4	0.0	0.9	0	44	0	44	0.0	1.6	2
18:30-18:45	5	0	5	0.0	1.1	0	39	1	40	2.5	1.4	3
18:45-19:00	7	1	8	12.5	1.7	0	34	2	36	5.6	1.3	0
1時間計	17	3	20	15.0	4.3	0	145	3	148	2.0	5.3	7
19:00-19:15	2	0	2	0.0	0.4	1	37	0	37	0.0	1.3	0
19:15-19:30	1	2	3	66.7	0.6	0	29	2	31	6.5	1.1	2
19:30-19:45	4	1	5	20.0	1.1	0	15	1	16	6.3	0.6	1
19:45-20:00	2	1	3	33.3	0.6	2	35	0	35	0.0	1.3	2
1時間計	9	4	13	30.8	2.8	3	116	3	119	2.5	4.3	5
20:00-20:15	2	3	5	60.0	1.1	1	29	0	29	0.0	1.0	2
20:15-20:30	2	3	5	60.0	1.1	0	20	1	21	4.8	0.8	0
20:30-20:45	0	2	2	100.0	0.4	1	19	0	19	0.0	0.7	2
20:45-21:00	0	0	0	0.0	0.0	0	17	4	21	19.0	0.8	0
1時間計	4	8	12	66.7	2.6	2	85	5	90	5.6	3.2	4
21:00-21:15	0	0	0	0.0	0.0	3	19	0	19	0.0	0.7	0
21:15-21:30	0	1	1	100.0	0.2	2	19	0	19	0.0	0.7	0
21:30-21:45	2	0	2	0.0	0.4	0	23	0	23	0.0	0.8	0
21:45-22:00	1	0	1	0.0	0.2	0	11	2	13	15.4	0.5	1
1時間計	3	1	4	25.0	0.9	5	72	2	74	2.7	2.6	1
昼12時間計	208	113	321	35.2	68.6	23	2188	75	2263	3.3	80.9	116
夜12時間計	71	76	147	51.7	31.4	18	500	36	536	6.7	19.1	20
全時間合計	279	189	468	40.4	100.0	41	2688	111	2799	4.0	100.0	136
昼夜率	1.34	1.67	1.46	-	-	1.78	1.23	1.48	1.24	-	-	1.17

方向別自動車交通量調査表

調査地点 : 地域社会 4 瀬谷土橋公園前

調査年月日 : 令和 2年 9月26日(土) 天候:晴れ一時雨



方向 種別 時間帯							A 合計 (1+2)					
	小型車 (台)	大型車 (台)	合計 (台)	大型車 混入率 (%)	時間 係数 (%)	二輪車 (台)	小型車 (台)	大型車 (台)	合計 (台)	大型車 混入率 (%)	時間 係数 (%)	二輪車 (台)
22:00-22:15							14	6	20	30.0	0.6	0
22:15-22:30							23	0	23	0.0	0.7	0
22:30-22:45							13	2	15	13.3	0.5	0
22:45-23:00							19	1	20	5.0	0.6	0
1時間計							69	9	78	11.5	2.4	0
23:00-23:15							12	0	12	0.0	0.4	1
23:15-23:30							11	0	11	0.0	0.3	0
23:30-23:45							9	1	10	10.0	0.3	0
23:45-24:00							13	1	14	7.1	0.4	0
1時間計							45	2	47	4.3	1.4	1
0:00- 0:15							11	3	14	21.4	0.4	1
0:15- 0:30							5	1	6	16.7	0.2	0
0:30- 0:45							4	0	4	0.0	0.1	1
0:45- 1:00							4	0	4	0.0	0.1	0
1時間計							24	4	28	14.3	0.9	2
1:00- 1:15							7	3	10	30.0	0.3	2
1:15- 1:30							5	5	10	50.0	0.3	0
1:30- 1:45							3	8	11	72.7	0.3	0
1:45- 2:00							4	8	12	66.7	0.4	1
1時間計							19	24	43	55.8	1.3	3
2:00- 2:15							7	5	12	41.7	0.4	0
2:15- 2:30							3	4	7	57.1	0.2	0
2:30- 2:45							4	5	9	55.6	0.3	1
2:45- 3:00							3	1	4	25.0	0.1	1
1時間計							17	15	32	46.9	1.0	2
3:00- 3:15							5	0	5	0.0	0.2	0
3:15- 3:30							4	2	6	33.3	0.2	0
3:30- 3:45							4	0	4	0.0	0.1	0
3:45- 4:00							2	1	3	33.3	0.1	1
1時間計							15	3	18	16.7	0.6	1
4:00- 4:15							1	2	3	66.7	0.1	0
4:15- 4:30							10	1	11	9.1	0.3	0
4:30- 4:45							4	1	5	20.0	0.2	1
4:45- 5:00							7	0	7	0.0	0.2	2
1時間計							22	4	26	15.4	0.8	3
5:00- 5:15							7	4	11	36.4	0.3	3
5:15- 5:30							6	3	9	33.3	0.3	1
5:30- 5:45							7	1	8	12.5	0.2	0
5:45- 6:00							7	2	9	22.2	0.3	1
1時間計							27	10	37	27.0	1.1	5

方向別自動車交通量調査表

調査地点 : 地域社会 4 瀬谷土橋公園前

調査年月日 : 令和 2年 9月26日(土) 天候:晴れ一時雨



時間帯	方向 種別						A 合計 (1+2)					
		小型車 (台)	大型車 (台)	合計 (台)	大型車 混入率 (%)	時間 係数 (%)	二輪車 (台)	小型車 (台)	大型車 (台)	合計 (台)	大型車 混入率 (%)	時間 係数 (%)
6:00-6:15							13	7	20	35.0	0.6	0
6:15-6:30							9	3	12	25.0	0.4	0
6:30-6:45							9	5	14	35.7	0.4	0
6:45-7:00							13	3	16	18.8	0.5	1
1時間計							44	18	62	29.0	1.9	1
7:00-7:15							21	2	23	8.7	0.7	1
7:15-7:30							26	4	30	13.3	0.9	7
7:30-7:45							30	2	32	6.3	1.0	3
7:45-8:00							35	4	39	10.3	1.2	4
1時間計							112	12	124	9.7	3.8	15
8:00-8:15							41	1	42	2.4	1.3	1
8:15-8:30							40	1	41	2.4	1.3	0
8:30-8:45							51	4	55	7.3	1.7	2
8:45-9:00							40	0	40	0.0	1.2	0
1時間計							172	6	178	3.4	5.4	3
9:00-9:15							58	3	61	4.9	1.9	2
9:15-9:30							43	1	44	2.3	1.3	3
9:30-9:45							45	2	47	4.3	1.4	1
9:45-10:00							45	3	48	6.3	1.5	1
1時間計							191	9	200	4.5	6.1	7
10:00-10:15							50	6	56	10.7	1.7	3
10:15-10:30							48	9	57	15.8	1.7	3
10:30-10:45							58	12	70	17.1	2.1	2
10:45-11:00							50	4	54	7.4	1.7	2
1時間計							206	31	237	13.1	7.3	10
11:00-11:15							65	10	75	13.3	2.3	3
11:15-11:30							52	6	58	10.3	1.8	5
11:30-11:45							59	4	63	6.3	1.9	1
11:45-12:00							57	2	59	3.4	1.8	1
1時間計							233	22	255	8.6	7.8	10
12:00-12:15							58	10	68	14.7	2.1	3
12:15-12:30							44	6	50	12.0	1.5	1
12:30-12:45							56	8	64	12.5	2.0	3
12:45-13:00							46	4	50	8.0	1.5	2
1時間計							204	28	232	12.1	7.1	9
13:00-13:15							65	5	70	7.1	2.1	2
13:15-13:30							55	0	55	0.0	1.7	3
13:30-13:45							55	5	60	8.3	1.8	1
13:45-14:00							50	5	55	9.1	1.7	1
1時間計							225	15	240	6.3	7.3	7

方向別自動車交通量調査表

調査地点 : 地域社会 4 瀬谷土橋公園前

調査年月日 : 令和 2年 9月26日(土) 天候:晴れ一時雨



時間帯	方向 種別						A 合計 (1+2)					
		小型車 (台)	大型車 (台)	合計 (台)	大型車 混入率 (%)	時間 係数 (%)	二輪車 (台)	小型車 (台)	大型車 (台)	合計 (台)	大型車 混入率 (%)	時間 係数 (%)
14:00-14:15							45	3	48	6.3	1.5	6
14:15-14:30							51	0	51	0.0	1.6	2
14:30-14:45							56	3	59	5.1	1.8	5
14:45-15:00							55	0	55	0.0	1.7	6
1時間計							207	6	213	2.8	6.5	19
15:00-15:15							50	2	52	3.8	1.6	4
15:15-15:30							29	2	31	6.5	0.9	2
15:30-15:45							66	3	69	4.3	2.1	5
15:45-16:00							60	1	61	1.6	1.9	4
1時間計							205	8	213	3.8	6.5	15
16:00-16:15							64	7	71	9.9	2.2	4
16:15-16:30							45	5	50	10.0	1.5	5
16:30-16:45							64	9	73	12.3	2.2	9
16:45-17:00							53	7	60	11.7	1.8	7
1時間計							226	28	254	11.0	7.8	25
17:00-17:15							69	4	73	5.5	2.2	6
17:15-17:30							63	6	69	8.7	2.1	1
17:30-17:45							61	6	67	9.0	2.1	1
17:45-18:00							60	1	61	1.6	1.9	4
1時間計							253	17	270	6.3	8.3	12
18:00-18:15							29	2	31	6.5	0.9	2
18:15-18:30							48	0	48	0.0	1.5	2
18:30-18:45							44	1	45	2.2	1.4	3
18:45-19:00							41	3	44	6.8	1.3	0
1時間計							162	6	168	3.6	5.1	7
19:00-19:15							39	0	39	0.0	1.2	1
19:15-19:30							30	4	34	11.8	1.0	2
19:30-19:45							19	2	21	9.5	0.6	1
19:45-20:00							37	1	38	2.6	1.2	4
1時間計							125	7	132	5.3	4.0	8
20:00-20:15							31	3	34	8.8	1.0	3
20:15-20:30							22	4	26	15.4	0.8	0
20:30-20:45							19	2	21	9.5	0.6	3
20:45-21:00							17	4	21	19.0	0.6	0
1時間計							89	13	102	12.7	3.1	6
21:00-21:15							19	0	19	0.0	0.6	3
21:15-21:30							19	1	20	5.0	0.6	2
21:30-21:45							25	0	25	0.0	0.8	0
21:45-22:00							12	2	14	14.3	0.4	1
1時間計							75	3	78	3.8	2.4	6
昼12時間計							2396	188	2584	7.3	79.1	139
夜12時間計							571	112	683	16.4	20.9	38
全時間合計							2967	300	3267	9.2	100.0	177
昼夜率							1.24	1.60	1.26	-	-	1.27

方向別自動車交通量調査表

調査地点：地域社会4 瀬谷土橋公園前

調査年月日：令和2年9月26日(土) 天候：晴れ一時雨



方向 種別 時間帯	3						4					
	小型車 (台)	大型車 (台)	合計 (台)	大型車 混入率 (%)	時間 係数 (%)	二輪車 (台)	小型車 (台)	大型車 (台)	合計 (台)	大型車 混入率 (%)	時間 係数 (%)	二輪車 (台)
22:00-22:15	11	2	13	15.4	0.7	0	2	1	3	33.3	0.7	0
22:15-22:30	12	2	14	14.3	0.8	0	1	0	1	0.0	0.2	0
22:30-22:45	12	0	12	0.0	0.7	0	0	0	0	0.0	0.0	0
22:45-23:00	12	1	13	7.7	0.7	0	2	0	2	0.0	0.4	0
1時間計	47	5	52	9.6	2.9	0	5	1	6	16.7	1.3	0
23:00-23:15	8	3	11	27.3	0.6	0	1	2	3	66.7	0.7	0
23:15-23:30	5	2	7	28.6	0.4	0	0	1	1	100.0	0.2	2
23:30-23:45	9	2	11	18.2	0.6	0	2	2	4	50.0	0.9	0
23:45-24:00	7	2	9	22.2	0.5	0	1	0	1	0.0	0.2	0
1時間計	29	9	38	23.7	2.1	0	4	5	9	55.6	2.0	2
0:00-0:15	6	3	9	33.3	0.5	1	0	0	0	0.0	0.0	0
0:15-0:30	6	1	7	14.3	0.4	0	1	1	2	50.0	0.4	0
0:30-0:45	8	3	11	27.3	0.6	0	0	2	2	100.0	0.4	0
0:45-1:00	2	2	4	50.0	0.2	0	0	1	1	100.0	0.2	0
1時間計	22	9	31	29.0	1.7	1	1	4	5	80.0	1.1	0
1:00-1:15	1	1	2	50.0	0.1	0	0	1	1	100.0	0.2	0
1:15-1:30	2	1	3	33.3	0.2	0	0	2	2	100.0	0.4	0
1:30-1:45	6	0	6	0.0	0.3	0	0	1	1	100.0	0.2	0
1:45-2:00	3	0	3	0.0	0.2	0	0	5	5	100.0	1.1	0
1時間計	12	2	14	14.3	0.8	0	0	9	9	100.0	2.0	0
2:00-2:15	1	1	2	50.0	0.1	0	0	3	3	100.0	0.7	0
2:15-2:30	2	0	2	0.0	0.1	0	1	3	4	75.0	0.9	0
2:30-2:45	1	0	1	0.0	0.1	1	1	0	1	0.0	0.2	0
2:45-3:00	4	2	6	33.3	0.3	0	0	0	0	0.0	0.0	0
1時間計	8	3	11	27.3	0.6	1	2	6	8	75.0	1.8	0
3:00-3:15	1	0	1	0.0	0.1	0	0	0	0	0.0	0.0	0
3:15-3:30	0	0	0	0.0	0.0	0	0	0	0	0.0	0.0	0
3:30-3:45	1	3	4	75.0	0.2	0	0	0	0	0.0	0.0	0
3:45-4:00	4	3	7	42.9	0.4	0	0	1	1	100.0	0.2	0
1時間計	6	6	12	50.0	0.7	0	0	1	1	100.0	0.2	0
4:00-4:15	7	1	8	12.5	0.4	0	0	0	0	0.0	0.0	0
4:15-4:30	1	1	2	50.0	0.1	0	0	0	0	0.0	0.0	0
4:30-4:45	3	0	3	0.0	0.2	0	0	1	1	100.0	0.2	0
4:45-5:00	4	1	5	20.0	0.3	0	1	0	1	0.0	0.2	1
1時間計	15	3	18	16.7	1.0	0	1	1	2	50.0	0.4	1
5:00-5:15	5	3	8	37.5	0.4	0	2	1	3	33.3	0.7	0
5:15-5:30	11	1	12	8.3	0.7	0	4	1	5	20.0	1.1	1
5:30-5:45	9	2	11	18.2	0.6	0	2	0	2	0.0	0.4	0
5:45-6:00	10	2	12	16.7	0.7	0	3	2	5	40.0	1.1	0
1時間計	35	8	43	18.6	2.4	0	11	4	15	26.7	3.4	1

方向別自動車交通量調査表

調査地点 : 地域社会 4 瀬谷土橋公園前

調査年月日 : 令和 2年 9月26日(土) 天候:晴れ一時雨



方向 時間帯	3						4					
	種別 小型車 (台)	大型車 (台)	合計 (台)	大型車 混入率 (%)	時間 係数 (%)	二輪車 (台)	小型車 (台)	大型車 (台)	合計 (台)	大型車 混入率 (%)	時間 係数 (%)	二輪車 (台)
6:00-6:15	13	1	14	7.1	0.8	0	1	0	1	0.0	0.2	0
6:15-6:30	10	1	11	9.1	0.6	0	2	0	2	0.0	0.4	0
6:30-6:45	10	0	10	0.0	0.6	0	2	1	3	33.3	0.7	0
6:45-7:00	14	4	18	22.2	1.0	0	5	0	5	0.0	1.1	0
1時間計	47	6	53	11.3	3.0	0	10	1	11	9.1	2.5	0
7:00-7:15	10	5	15	33.3	0.8	0	1	5	6	83.3	1.3	0
7:15-7:30	18	5	23	21.7	1.3	0	5	0	5	0.0	1.1	0
7:30-7:45	15	8	23	34.8	1.3	1	3	1	4	25.0	0.9	1
7:45-8:00	29	4	33	12.1	1.8	2	3	1	4	25.0	0.9	2
1時間計	72	22	94	23.4	5.2	3	12	7	19	36.8	4.3	3
8:00-8:15	25	4	29	13.8	1.6	2	1	1	2	50.0	0.4	0
8:15-8:30	26	6	32	18.8	1.8	2	1	1	2	50.0	0.4	0
8:30-8:45	30	1	31	3.2	1.7	3	12	2	14	14.3	3.1	0
8:45-9:00	20	0	20	0.0	1.1	3	5	2	7	28.6	1.6	1
1時間計	101	11	112	9.8	6.2	10	19	6	25	24.0	5.6	1
9:00-9:15	18	11	29	37.9	1.6	0	0	0	0	0.0	0.0	0
9:15-9:30	24	3	27	11.1	1.5	2	4	2	6	33.3	1.3	6
9:30-9:45	28	1	29	3.4	1.6	0	11	5	16	31.3	3.6	0
9:45-10:00	32	2	34	5.9	1.9	0	3	1	4	25.0	0.9	0
1時間計	102	17	119	14.3	6.6	2	18	8	26	30.8	5.8	6
10:00-10:15	29	0	29	0.0	1.6	0	4	6	10	60.0	2.2	0
10:15-10:30	26	4	30	13.3	1.7	2	4	4	8	50.0	1.8	0
10:30-10:45	27	3	30	10.0	1.7	2	3	3	6	50.0	1.3	0
10:45-11:00	29	6	35	17.1	1.9	0	5	1	6	16.7	1.3	0
1時間計	111	13	124	10.5	6.9	4	16	14	30	46.7	6.7	0
11:00-11:15	28	3	31	9.7	1.7	0	3	3	6	50.0	1.3	0
11:15-11:30	38	1	39	2.6	2.2	0	3	1	4	25.0	0.9	1
11:30-11:45	32	2	34	5.9	1.9	1	8	1	9	11.1	2.0	0
11:45-12:00	31	1	32	3.1	1.8	2	2	1	3	33.3	0.7	1
1時間計	129	7	136	5.1	7.6	3	16	6	22	27.3	4.9	2
12:00-12:15	29	2	31	6.5	1.7	2	10	0	10	0.0	2.2	0
12:15-12:30	37	1	38	2.6	2.1	1	7	3	10	30.0	2.2	1
12:30-12:45	29	0	29	0.0	1.6	2	11	0	11	0.0	2.5	0
12:45-13:00	30	5	35	14.3	1.9	2	5	3	8	37.5	1.8	0
1時間計	125	8	133	6.0	7.4	7	33	6	39	15.4	8.7	1
13:00-13:15	30	2	32	6.3	1.8	1	5	1	6	16.7	1.3	0
13:15-13:30	26	3	29	10.3	1.6	1	2	4	6	66.7	1.3	1
13:30-13:45	26	3	29	10.3	1.6	0	3	4	7	57.1	1.6	1
13:45-14:00	25	3	28	10.7	1.6	0	4	6	10	60.0	2.2	1
1時間計	107	11	118	9.3	6.6	2	14	15	29	51.7	6.5	3

方向別自動車交通量調査表

調査地点 : 地域社会 4 瀬谷土橋公園前

調査年月日 : 令和 2年 9月26日(土) 天候:晴れ一時雨



方向	3						4						
	種別	小型車 (台)	大型車 (台)	合計 (台)	大型車 混入率 (%)	時間 係数 (%)	二輪車 (台)	小型車 (台)	大型車 (台)	合計 (台)	大型車 混入率 (%)	時間 係数 (%)	二輪車 (台)
14:00-14:15		28	3	31	9.7	1.7	3	9	3	12	25.0	2.7	1
14:15-14:30		42	1	43	2.3	2.4	1	17	6	23	26.1	5.1	1
14:30-14:45		27	1	28	3.6	1.6	1	2	3	5	60.0	1.1	0
14:45-15:00		35	2	37	5.4	2.1	1	7	1	8	12.5	1.8	1
1時間計		132	7	139	5.0	7.7	6	35	13	48	27.1	10.7	3
15:00-15:15		19	2	21	9.5	1.2	0	8	0	8	0.0	1.8	0
15:15-15:30		26	0	26	0.0	1.4	1	5	0	5	0.0	1.1	0
15:30-15:45		26	2	28	7.1	1.6	0	10	2	12	16.7	2.7	0
15:45-16:00		23	5	28	17.9	1.6	1	6	1	7	14.3	1.6	0
1時間計		94	9	103	8.7	5.7	2	29	3	32	9.4	7.2	0
16:00-16:15		24	2	26	7.7	1.4	3	1	5	6	83.3	1.3	0
16:15-16:30		29	0	29	0.0	1.6	3	7	3	10	30.0	2.2	0
16:30-16:45		19	0	19	0.0	1.1	0	4	2	6	33.3	1.3	0
16:45-17:00		25	0	25	0.0	1.4	2	5	1	6	16.7	1.3	1
1時間計		97	2	99	2.0	5.5	8	17	11	28	39.3	6.3	1
17:00-17:15		26	2	28	7.1	1.6	0	3	3	6	50.0	1.3	0
17:15-17:30		23	6	29	20.7	1.6	1	3	4	7	57.1	1.6	0
17:30-17:45		26	1	27	3.7	1.5	1	3	2	5	40.0	1.1	2
17:45-18:00		16	1	17	5.9	0.9	1	3	3	6	50.0	1.3	0
1時間計		91	10	101	9.9	5.6	3	12	12	24	50.0	5.4	2
18:00-18:15		13	4	17	23.5	0.9	1	5	4	9	44.4	2.0	0
18:15-18:30		20	4	24	16.7	1.3	1	2	0	2	0.0	0.4	0
18:30-18:45		13	1	14	7.1	0.8	0	3	1	4	25.0	0.9	0
18:45-19:00		13	0	13	0.0	0.7	0	4	0	4	0.0	0.9	1
1時間計		59	9	68	13.2	3.8	2	14	5	19	26.3	4.3	1
19:00-19:15		18	5	23	21.7	1.3	0	7	5	12	41.7	2.7	1
19:15-19:30		12	2	14	14.3	0.8	0	3	0	3	0.0	0.7	0
19:30-19:45		17	2	19	10.5	1.1	1	1	0	1	0.0	0.2	0
19:45-20:00		22	1	23	4.3	1.3	0	6	1	7	14.3	1.6	0
1時間計		69	10	79	12.7	4.4	1	17	6	23	26.1	5.1	1
20:00-20:15		15	0	15	0.0	0.8	2	2	0	2	0.0	0.4	0
20:15-20:30		11	1	12	8.3	0.7	0	2	1	3	33.3	0.7	0
20:30-20:45		10	2	12	16.7	0.7	0	0	0	0	0.0	0.0	0
20:45-21:00		8	1	9	11.1	0.5	2	0	0	0	0.0	0.0	0
1時間計		44	4	48	8.3	2.7	4	4	1	5	20.0	1.1	0
21:00-21:15		5	2	7	28.6	0.4	0	1	2	3	66.7	0.7	0
21:15-21:30		14	1	15	6.7	0.8	0	2	2	4	50.0	0.9	0
21:30-21:45		17	3	20	15.0	1.1	0	2	2	4	50.0	0.9	0
21:45-22:00		7	1	8	12.5	0.4	0	1	0	1	0.0	0.2	0
1時間計		43	7	50	14.0	2.8	0	6	6	12	50.0	2.7	0
昼12時間計		1220	126	1346	9.4	75.0	52	235	106	341	31.1	76.3	23
夜12時間計		377	72	449	16.0	25.0	7	61	45	106	42.5	23.7	5
全時間合計		1597	198	1795	11.0	100.0	59	296	151	447	33.8	100.0	28
昼夜率		1.31	1.57	1.33	-	-	1.13	1.26	1.42	1.31	-	-	1.22

方向別自動車交通量調査表

調査地点 : 地域社会 4 瀬谷土橋公園前

調査年月日 : 令和 2年 9月26日(土) 天候:晴れ一時雨



方向 種別 時間帯							B 合計 (3+ 4)					
	小型車 (台)	大型車 (台)	合計 (台)	大型車 混入率 (%)	時間 係数 (%)	二輪車 (台)	小型車 (台)	大型車 (台)	合計 (台)	大型車 混入率 (%)	時間 係数 (%)	二輪車 (台)
22:00-22:15							13	3	16	18.8	0.7	0
22:15-22:30							13	2	15	13.3	0.7	0
22:30-22:45							12	0	12	0.0	0.5	0
22:45-23:00							14	1	15	6.7	0.7	0
1時間計							52	6	58	10.3	2.6	0
23:00-23:15							9	5	14	35.7	0.6	0
23:15-23:30							5	3	8	37.5	0.4	2
23:30-23:45							11	4	15	26.7	0.7	0
23:45-24:00							8	2	10	20.0	0.4	0
1時間計							33	14	47	29.8	2.1	2
0:00- 0:15							6	3	9	33.3	0.4	1
0:15- 0:30							7	2	9	22.2	0.4	0
0:30- 0:45							8	5	13	38.5	0.6	0
0:45- 1:00							2	3	5	60.0	0.2	0
1時間計							23	13	36	36.1	1.6	1
1:00- 1:15							1	2	3	66.7	0.1	0
1:15- 1:30							2	3	5	60.0	0.2	0
1:30- 1:45							6	1	7	14.3	0.3	0
1:45- 2:00							3	5	8	62.5	0.4	0
1時間計							12	11	23	47.8	1.0	0
2:00- 2:15							1	4	5	80.0	0.2	0
2:15- 2:30							3	3	6	50.0	0.3	0
2:30- 2:45							2	0	2	0.0	0.1	1
2:45- 3:00							4	2	6	33.3	0.3	0
1時間計							10	9	19	47.4	0.8	1
3:00- 3:15							1	0	1	0.0	0.0	0
3:15- 3:30							0	0	0	0.0	0.0	0
3:30- 3:45							1	3	4	75.0	0.2	0
3:45- 4:00							4	4	8	50.0	0.4	0
1時間計							6	7	13	53.8	0.6	0
4:00- 4:15							7	1	8	12.5	0.4	0
4:15- 4:30							1	1	2	50.0	0.1	0
4:30- 4:45							3	1	4	25.0	0.2	0
4:45- 5:00							5	1	6	16.7	0.3	1
1時間計							16	4	20	20.0	0.9	1
5:00- 5:15							7	4	11	36.4	0.5	0
5:15- 5:30							15	2	17	11.8	0.8	1
5:30- 5:45							11	2	13	15.4	0.6	0
5:45- 6:00							13	4	17	23.5	0.8	0
1時間計							46	12	58	20.7	2.6	1

方向別自動車交通量調査表

調査地点：地域社会4 瀬谷土橋公園前

調査年月日：令和2年9月26日(土) 天候：晴れ一時雨



方向 種別 時間帯							B 合計 (3+4)					
	小型車 (台)	大型車 (台)	合計 (台)	大型車 混入率 (%)	時間 係数 (%)	二輪車 (台)	小型車 (台)	大型車 (台)	合計 (台)	大型車 混入率 (%)	時間 係数 (%)	二輪車 (台)
6:00-6:15							14	1	15	6.7	0.7	0
6:15-6:30							12	1	13	7.7	0.6	0
6:30-6:45							12	1	13	7.7	0.6	0
6:45-7:00							19	4	23	17.4	1.0	0
1時間計							57	7	64	10.9	2.9	0
7:00-7:15							11	10	21	47.6	0.9	0
7:15-7:30							23	5	28	17.9	1.2	0
7:30-7:45							18	9	27	33.3	1.2	2
7:45-8:00							32	5	37	13.5	1.7	4
1時間計							84	29	113	25.7	5.0	6
8:00-8:15							26	5	31	16.1	1.4	2
8:15-8:30							27	7	34	20.6	1.5	2
8:30-8:45							42	3	45	6.7	2.0	3
8:45-9:00							25	2	27	7.4	1.2	4
1時間計							120	17	137	12.4	6.1	11
9:00-9:15							18	11	29	37.9	1.3	0
9:15-9:30							28	5	33	15.2	1.5	8
9:30-9:45							39	6	45	13.3	2.0	0
9:45-10:00							35	3	38	7.9	1.7	0
1時間計							120	25	145	17.2	6.5	8
10:00-10:15							33	6	39	15.4	1.7	0
10:15-10:30							30	8	38	21.1	1.7	2
10:30-10:45							30	6	36	16.7	1.6	2
10:45-11:00							34	7	41	17.1	1.8	0
1時間計							127	27	154	17.5	6.9	4
11:00-11:15							31	6	37	16.2	1.7	0
11:15-11:30							41	2	43	4.7	1.9	1
11:30-11:45							40	3	43	7.0	1.9	1
11:45-12:00							33	2	35	5.7	1.6	3
1時間計							145	13	158	8.2	7.0	5
12:00-12:15							39	2	41	4.9	1.8	2
12:15-12:30							44	4	48	8.3	2.1	2
12:30-12:45							40	0	40	0.0	1.8	2
12:45-13:00							35	8	43	18.6	1.9	2
1時間計							158	14	172	8.1	7.7	8
13:00-13:15							35	3	38	7.9	1.7	1
13:15-13:30							28	7	35	20.0	1.6	2
13:30-13:45							29	7	36	19.4	1.6	1
13:45-14:00							29	9	38	23.7	1.7	1
1時間計							121	26	147	17.7	6.6	5

方向別自動車交通量調査表

調査地点：地域社会4 瀬谷土橋公園前

調査年月日：令和2年9月26日(土) 天候：晴れ一時雨



方向 種別 時間帯							B 合計 (3+4)					
	小型車 (台)	大型車 (台)	合計 (台)	大型車 混入率 (%)	時間 係数 (%)	二輪車 (台)	小型車 (台)	大型車 (台)	合計 (台)	大型車 混入率 (%)	時間 係数 (%)	二輪車 (台)
14:00-14:15							37	6	43	14.0	1.9	4
14:15-14:30							59	7	66	10.6	2.9	2
14:30-14:45							29	4	33	12.1	1.5	1
14:45-15:00							42	3	45	6.7	2.0	2
1時間計							167	20	187	10.7	8.3	9
15:00-15:15							27	2	29	6.9	1.3	0
15:15-15:30							31	0	31	0.0	1.4	1
15:30-15:45							36	4	40	10.0	1.8	0
15:45-16:00							29	6	35	17.1	1.6	1
1時間計							123	12	135	8.9	6.0	2
16:00-16:15							25	7	32	21.9	1.4	3
16:15-16:30							36	3	39	7.7	1.7	3
16:30-16:45							23	2	25	8.0	1.1	0
16:45-17:00							30	1	31	3.2	1.4	3
1時間計							114	13	127	10.2	5.7	9
17:00-17:15							29	5	34	14.7	1.5	0
17:15-17:30							26	10	36	27.8	1.6	1
17:30-17:45							29	3	32	9.4	1.4	3
17:45-18:00							19	4	23	17.4	1.0	1
1時間計							103	22	125	17.6	5.6	5
18:00-18:15							18	8	26	30.8	1.2	1
18:15-18:30							22	4	26	15.4	1.2	1
18:30-18:45							16	2	18	11.1	0.8	0
18:45-19:00							17	0	17	0.0	0.8	1
1時間計							73	14	87	16.1	3.9	3
19:00-19:15							25	10	35	28.6	1.6	1
19:15-19:30							15	2	17	11.8	0.8	0
19:30-19:45							18	2	20	10.0	0.9	1
19:45-20:00							28	2	30	6.7	1.3	0
1時間計							86	16	102	15.7	4.5	2
20:00-20:15							17	0	17	0.0	0.8	2
20:15-20:30							13	2	15	13.3	0.7	0
20:30-20:45							10	2	12	16.7	0.5	0
20:45-21:00							8	1	9	11.1	0.4	2
1時間計							48	5	53	9.4	2.4	4
21:00-21:15							6	4	10	40.0	0.4	0
21:15-21:30							16	3	19	15.8	0.8	0
21:30-21:45							19	5	24	20.8	1.1	0
21:45-22:00							8	1	9	11.1	0.4	0
1時間計							49	13	62	21.0	2.8	0
昼12時間計							1455	232	1687	13.8	75.2	75
夜12時間計							438	117	555	21.1	24.8	12
全時間合計							1893	349	2242	15.6	100.0	87
昼夜率							1.30	1.50	1.33	-	-	1.16

方向別自動車交通量調査表

調査地点 : 地域社会 4 瀬谷土橋公園前

調査年月日 : 令和 2年 9月26日(土) 天候:晴れ一時雨



方向 種別 時間帯	5						6					
	小型車 (台)	大型車 (台)	合計 (台)	大型車 混入率 (%)	時間 係数 (%)	二輪車 (台)	小型車 (台)	大型車 (台)	合計 (台)	大型車 混入率 (%)	時間 係数 (%)	二輪車 (台)
22:00-22:15	1	3	4	75.0	1.9	0	1	6	7	85.7	1.0	0
22:15-22:30	0	0	0	0.0	0.0	0	2	3	5	60.0	0.7	0
22:30-22:45	0	2	2	100.0	1.0	0	4	2	6	33.3	0.9	0
22:45-23:00	1	1	2	50.0	1.0	0	1	7	8	87.5	1.2	1
1時間計	2	6	8	75.0	3.9	0	8	18	26	69.2	3.8	1
23:00-23:15	0	0	0	0.0	0.0	0	4	2	6	33.3	0.9	1
23:15-23:30	1	0	1	0.0	0.5	0	1	0	1	0.0	0.1	0
23:30-23:45	0	0	0	0.0	0.0	0	4	6	10	60.0	1.5	0
23:45-24:00	1	1	2	50.0	1.0	0	0	5	5	100.0	0.7	2
1時間計	2	1	3	33.3	1.4	0	9	13	22	59.1	3.2	3
0:00-0:15	0	0	0	0.0	0.0	0	4	1	5	20.0	0.7	0
0:15-0:30	1	0	1	0.0	0.5	0	1	1	2	50.0	0.3	0
0:30-0:45	0	0	0	0.0	0.0	0	3	2	5	40.0	0.7	0
0:45-1:00	0	0	0	0.0	0.0	0	1	3	4	75.0	0.6	0
1時間計	1	0	1	0.0	0.5	0	9	7	16	43.8	2.4	0
1:00-1:15	0	1	1	100.0	0.5	0	10	0	10	0.0	1.5	0
1:15-1:30	1	2	3	66.7	1.4	0	6	2	8	25.0	1.2	0
1:30-1:45	0	4	4	100.0	1.9	0	3	3	6	50.0	0.9	0
1:45-2:00	0	0	0	0.0	0.0	0	1	6	7	85.7	1.0	0
1時間計	1	7	8	87.5	3.9	0	20	11	31	35.5	4.6	0
2:00-2:15	0	1	1	100.0	0.5	0	0	2	2	100.0	0.3	0
2:15-2:30	0	0	0	0.0	0.0	0	1	1	2	50.0	0.3	0
2:30-2:45	1	0	1	0.0	0.5	0	0	1	1	100.0	0.1	0
2:45-3:00	0	0	0	0.0	0.0	1	1	0	1	0.0	0.1	0
1時間計	1	1	2	50.0	1.0	1	2	4	6	66.7	0.9	0
3:00-3:15	0	0	0	0.0	0.0	0	1	2	3	66.7	0.4	0
3:15-3:30	0	0	0	0.0	0.0	0	2	1	3	33.3	0.4	0
3:30-3:45	0	0	0	0.0	0.0	0	1	3	4	75.0	0.6	0
3:45-4:00	0	0	0	0.0	0.0	0	0	2	2	100.0	0.3	0
1時間計	0	0	0	0.0	0.0	0	4	8	12	66.7	1.8	0
4:00-4:15	0	0	0	0.0	0.0	0	1	1	2	50.0	0.3	0
4:15-4:30	0	0	0	0.0	0.0	0	1	0	1	0.0	0.1	0
4:30-4:45	0	0	0	0.0	0.0	0	1	1	2	50.0	0.3	1
4:45-5:00	0	0	0	0.0	0.0	0	2	1	3	33.3	0.4	0
1時間計	0	0	0	0.0	0.0	0	5	3	8	37.5	1.2	1
5:00-5:15	1	0	1	0.0	0.5	0	4	2	6	33.3	0.9	0
5:15-5:30	0	0	0	0.0	0.0	0	3	0	3	0.0	0.4	1
5:30-5:45	0	0	0	0.0	0.0	0	5	5	10	50.0	1.5	0
5:45-6:00	0	1	1	100.0	0.5	0	2	2	4	50.0	0.6	1
1時間計	1	1	2	50.0	1.0	0	14	9	23	39.1	3.4	2

方向別自動車交通量調査表

調査地点 : 地域社会 4 瀬谷土橋公園前

調査年月日 : 令和 2年 9月26日(土) 天候:晴れ一時雨



方向 時間帯	5						6					
	種別 小型車 (台)	大型車 (台)	合計 (台)	大型車 混入率 (%)	時間 係数 (%)	二輪車 (台)	小型車 (台)	大型車 (台)	合計 (台)	大型車 混入率 (%)	時間 係数 (%)	二輪車 (台)
6:00-6:15	0	2	2	100.0	1.0	0	6	4	10	40.0	1.5	1
6:15-6:30	0	0	0	0.0	0.0	0	6	3	9	33.3	1.3	0
6:30-6:45	0	4	4	100.0	1.9	0	5	8	13	61.5	1.9	1
6:45-7:00	0	0	0	0.0	0.0	0	4	3	7	42.9	1.0	0
1時間計	0	6	6	100.0	2.9	0	21	18	39	46.2	5.7	2
7:00-7:15	1	1	2	50.0	1.0	0	2	7	9	77.8	1.3	0
7:15-7:30	0	3	3	100.0	1.4	0	5	2	7	28.6	1.0	0
7:30-7:45	1	1	2	50.0	1.0	0	6	4	10	40.0	1.5	0
7:45-8:00	0	3	3	100.0	1.4	0	4	2	6	33.3	0.9	0
1時間計	2	8	10	80.0	4.8	0	17	15	32	46.9	4.7	0
8:00-8:15	1	1	2	50.0	1.0	0	8	4	12	33.3	1.8	0
8:15-8:30	0	0	0	0.0	0.0	0	2	3	5	60.0	0.7	0
8:30-8:45	3	2	5	40.0	2.4	0	6	0	6	0.0	0.9	0
8:45-9:00	0	1	1	100.0	0.5	0	6	1	7	14.3	1.0	0
1時間計	4	4	8	50.0	3.9	0	22	8	30	26.7	4.4	0
9:00-9:15	0	0	0	0.0	0.0	0	9	3	12	25.0	1.8	0
9:15-9:30	3	0	3	0.0	1.4	0	6	5	11	45.5	1.6	1
9:30-9:45	2	1	3	33.3	1.4	0	6	3	9	33.3	1.3	0
9:45-10:00	3	0	3	0.0	1.4	0	5	3	8	37.5	1.2	0
1時間計	8	1	9	11.1	4.3	0	26	14	40	35.0	5.9	1
10:00-10:15	7	0	7	0.0	3.4	0	6	0	6	0.0	0.9	0
10:15-10:30	4	1	5	20.0	2.4	0	7	1	8	12.5	1.2	0
10:30-10:45	3	0	3	0.0	1.4	0	7	1	8	12.5	1.2	0
10:45-11:00	4	0	4	0.0	1.9	0	4	1	5	20.0	0.7	0
1時間計	18	1	19	5.3	9.2	0	24	3	27	11.1	4.0	0
11:00-11:15	1	0	1	0.0	0.5	0	9	2	11	18.2	1.6	0
11:15-11:30	1	0	1	0.0	0.5	0	4	0	4	0.0	0.6	1
11:30-11:45	1	0	1	0.0	0.5	0	9	1	10	10.0	1.5	0
11:45-12:00	1	0	1	0.0	0.5	0	8	4	12	33.3	1.8	0
1時間計	4	0	4	0.0	1.9	0	30	7	37	18.9	5.4	1
12:00-12:15	2	0	2	0.0	1.0	0	7	4	11	36.4	1.6	0
12:15-12:30	2	0	2	0.0	1.0	0	5	2	7	28.6	1.0	0
12:30-12:45	1	1	2	50.0	1.0	0	2	3	5	60.0	0.7	0
12:45-13:00	0	0	0	0.0	0.0	0	8	5	13	38.5	1.9	0
1時間計	5	1	6	16.7	2.9	0	22	14	36	38.9	5.3	0
13:00-13:15	6	1	7	14.3	3.4	2	4	3	7	42.9	1.0	0
13:15-13:30	6	0	6	0.0	2.9	0	11	5	16	31.3	2.4	0
13:30-13:45	2	0	2	0.0	1.0	0	15	3	18	16.7	2.6	0
13:45-14:00	5	0	5	0.0	2.4	0	2	2	4	50.0	0.6	0
1時間計	19	1	20	5.0	9.7	2	32	13	45	28.9	6.6	0

方向別自動車交通量調査表

調査地点 : 地域社会 4 瀬谷土橋公園前

調査年月日 : 令和 2年 9月26日(土) 天候:晴れ一時雨



方向 種別 時間帯	5						6					
	小型車 (台)	大型車 (台)	合計 (台)	大型車 混入率 (%)	時間 係数 (%)	二輪車 (台)	小型車 (台)	大型車 (台)	合計 (台)	大型車 混入率 (%)	時間 係数 (%)	二輪車 (台)
14:00-14:15	4	0	4	0.0	1.9	0	10	1	11	9.1	1.6	0
14:15-14:30	5	1	6	16.7	2.9	0	9	1	10	10.0	1.5	0
14:30-14:45	6	0	6	0.0	2.9	0	3	4	7	57.1	1.0	0
14:45-15:00	9	0	9	0.0	4.3	0	6	3	9	33.3	1.3	0
1時間計	24	1	25	4.0	12.1	0	28	9	37	24.3	5.4	0
15:00-15:15	7	0	7	0.0	3.4	0	13	3	16	18.8	2.4	1
15:15-15:30	2	0	2	0.0	1.0	1	11	2	13	15.4	1.9	1
15:30-15:45	0	0	0	0.0	0.0	0	6	2	8	25.0	1.2	0
15:45-16:00	5	0	5	0.0	2.4	0	6	4	10	40.0	1.5	0
1時間計	14	0	14	0.0	6.8	1	36	11	47	23.4	6.9	2
16:00-16:15	4	0	4	0.0	1.9	0	13	3	16	18.8	2.4	0
16:15-16:30	3	0	3	0.0	1.4	0	9	2	11	18.2	1.6	1
16:30-16:45	0	0	0	0.0	0.0	0	9	0	9	0.0	1.3	1
16:45-17:00	1	0	1	0.0	0.5	0	14	4	18	22.2	2.6	2
1時間計	8	0	8	0.0	3.9	0	45	9	54	16.7	7.9	4
17:00-17:15	3	1	4	25.0	1.9	1	2	1	3	33.3	0.4	0
17:15-17:30	1	0	1	0.0	0.5	0	5	1	6	16.7	0.9	0
17:30-17:45	5	1	6	16.7	2.9	0	7	2	9	22.2	1.3	1
17:45-18:00	0	0	0	0.0	0.0	0	5	0	5	0.0	0.7	0
1時間計	9	2	11	18.2	5.3	1	19	4	23	17.4	3.4	1
18:00-18:15	4	1	5	20.0	2.4	0	2	1	3	33.3	0.4	0
18:15-18:30	1	0	1	0.0	0.5	0	8	1	9	11.1	1.3	0
18:30-18:45	2	0	2	0.0	1.0	0	6	1	7	14.3	1.0	0
18:45-19:00	0	0	0	0.0	0.0	0	6	1	7	14.3	1.0	1
1時間計	7	1	8	12.5	3.9	0	22	4	26	15.4	3.8	1
19:00-19:15	7	0	7	0.0	3.4	0	7	1	8	12.5	1.2	0
19:15-19:30	3	0	3	0.0	1.4	0	6	0	6	0.0	0.9	0
19:30-19:45	3	1	4	25.0	1.9	0	2	2	4	50.0	0.6	0
19:45-20:00	3	0	3	0.0	1.4	0	6	1	7	14.3	1.0	0
1時間計	16	1	17	5.9	8.2	0	21	4	25	16.0	3.7	0
20:00-20:15	1	1	2	50.0	1.0	0	3	2	5	40.0	0.7	0
20:15-20:30	4	0	4	0.0	1.9	0	5	2	7	28.6	1.0	0
20:30-20:45	1	0	1	0.0	0.5	0	5	1	6	16.7	0.9	0
20:45-21:00	1	0	1	0.0	0.5	0	1	1	2	50.0	0.3	0
1時間計	7	1	8	12.5	3.9	0	14	6	20	30.0	2.9	0
21:00-21:15	4	0	4	0.0	1.9	0	2	0	2	0.0	0.3	0
21:15-21:30	0	1	1	100.0	0.5	0	3	5	8	62.5	1.2	0
21:30-21:45	3	0	3	0.0	1.4	0	1	4	5	80.0	0.7	0
21:45-22:00	1	1	2	50.0	1.0	0	0	3	3	100.0	0.4	0
1時間計	8	2	10	20.0	4.8	0	6	12	18	66.7	2.6	0
昼12時間計	122	20	142	14.1	68.6	4	323	111	434	25.6	63.8	10
夜12時間計	39	26	65	40.0	31.4	1	133	113	246	45.9	36.2	9
全時間合計	161	46	207	22.2	100.0	5	456	224	680	32.9	100.0	19
昼夜率	1.32	2.30	1.46	-	-	1.25	1.41	2.02	1.57	-	-	1.90

方向別自動車交通量調査表

調査地点：地域社会4 瀬谷土橋公園前

調査年月日：令和2年9月26日(土) 天候：晴れ一時雨



方向 種別 時間帯							C 合計 (5+6)					
	小型車 (台)	大型車 (台)	合計 (台)	大型車 混入率 (%)	時間 係数 (%)	二輪車 (台)	小型車 (台)	大型車 (台)	合計 (台)	大型車 混入率 (%)	時間 係数 (%)	二輪車 (台)
22:00-22:15							2	9	11	81.8	1.2	0
22:15-22:30							2	3	5	60.0	0.6	0
22:30-22:45							4	4	8	50.0	0.9	0
22:45-23:00							2	8	10	80.0	1.1	1
1時間計							10	24	34	70.6	3.8	1
23:00-23:15							4	2	6	33.3	0.7	1
23:15-23:30							2	0	2	0.0	0.2	0
23:30-23:45							4	6	10	60.0	1.1	0
23:45-24:00							1	6	7	85.7	0.8	2
1時間計							11	14	25	56.0	2.8	3
0:00-0:15							4	1	5	20.0	0.6	0
0:15-0:30							2	1	3	33.3	0.3	0
0:30-0:45							3	2	5	40.0	0.6	0
0:45-1:00							1	3	4	75.0	0.5	0
1時間計							10	7	17	41.2	1.9	0
1:00-1:15							10	1	11	9.1	1.2	0
1:15-1:30							7	4	11	36.4	1.2	0
1:30-1:45							3	7	10	70.0	1.1	0
1:45-2:00							1	6	7	85.7	0.8	0
1時間計							21	18	39	46.2	4.4	0
2:00-2:15							0	3	3	100.0	0.3	0
2:15-2:30							1	1	2	50.0	0.2	0
2:30-2:45							1	1	2	50.0	0.2	0
2:45-3:00							1	0	1	0.0	0.1	1
1時間計							3	5	8	62.5	0.9	1
3:00-3:15							1	2	3	66.7	0.3	0
3:15-3:30							2	1	3	33.3	0.3	0
3:30-3:45							1	3	4	75.0	0.5	0
3:45-4:00							0	2	2	100.0	0.2	0
1時間計							4	8	12	66.7	1.4	0
4:00-4:15							1	1	2	50.0	0.2	0
4:15-4:30							1	0	1	0.0	0.1	0
4:30-4:45							1	1	2	50.0	0.2	1
4:45-5:00							2	1	3	33.3	0.3	0
1時間計							5	3	8	37.5	0.9	1
5:00-5:15							5	2	7	28.6	0.8	0
5:15-5:30							3	0	3	0.0	0.3	1
5:30-5:45							5	5	10	50.0	1.1	0
5:45-6:00							2	3	5	60.0	0.6	1
1時間計							15	10	25	40.0	2.8	2

方向別自動車交通量調査表

調査地点：地域社会4 瀬谷土橋公園前

調査年月日：令和2年9月26日(土) 天候：晴れ一時雨



方向 時間帯	種別							C 合計 (5+6)					
		小型車 (台)	大型車 (台)	合計 (台)	大型車 混入率 (%)	時間 係数 (%)	二輪車 (台)	小型車 (台)	大型車 (台)	合計 (台)	大型車 混入率 (%)	時間 係数 (%)	二輪車 (台)
6:00-6:15							6	6	12	50.0	1.4	1	
6:15-6:30							6	3	9	33.3	1.0	0	
6:30-6:45							5	12	17	70.6	1.9	1	
6:45-7:00							4	3	7	42.9	0.8	0	
1時間計							21	24	45	53.3	5.1	2	
7:00-7:15							3	8	11	72.7	1.2	0	
7:15-7:30							5	5	10	50.0	1.1	0	
7:30-7:45							7	5	12	41.7	1.4	0	
7:45-8:00							4	5	9	55.6	1.0	0	
1時間計							19	23	42	54.8	4.7	0	
8:00-8:15							9	5	14	35.7	1.6	0	
8:15-8:30							2	3	5	60.0	0.6	0	
8:30-8:45							9	2	11	18.2	1.2	0	
8:45-9:00							6	2	8	25.0	0.9	0	
1時間計							26	12	38	31.6	4.3	0	
9:00-9:15							9	3	12	25.0	1.4	0	
9:15-9:30							9	5	14	35.7	1.6	1	
9:30-9:45							8	4	12	33.3	1.4	0	
9:45-10:00							8	3	11	27.3	1.2	0	
1時間計							34	15	49	30.6	5.5	1	
10:00-10:15							13	0	13	0.0	1.5	0	
10:15-10:30							11	2	13	15.4	1.5	0	
10:30-10:45							10	1	11	9.1	1.2	0	
10:45-11:00							8	1	9	11.1	1.0	0	
1時間計							42	4	46	8.7	5.2	0	
11:00-11:15							10	2	12	16.7	1.4	0	
11:15-11:30							5	0	5	0.0	0.6	1	
11:30-11:45							10	1	11	9.1	1.2	0	
11:45-12:00							9	4	13	30.8	1.5	0	
1時間計							34	7	41	17.1	4.6	1	
12:00-12:15							9	4	13	30.8	1.5	0	
12:15-12:30							7	2	9	22.2	1.0	0	
12:30-12:45							3	4	7	57.1	0.8	0	
12:45-13:00							8	5	13	38.5	1.5	0	
1時間計							27	15	42	35.7	4.7	0	
13:00-13:15							10	4	14	28.6	1.6	2	
13:15-13:30							17	5	22	22.7	2.5	0	
13:30-13:45							17	3	20	15.0	2.3	0	
13:45-14:00							7	2	9	22.2	1.0	0	
1時間計							51	14	65	21.5	7.3	2	

方向別自動車交通量調査表

調査地点 : 地域社会 4 瀬谷土橋公園前

調査年月日 : 令和 2年 9月26日(土) 天候:晴れ一時雨



方向 種別 時間帯							C 合計 (5+ 6)					
	小型車 (台)	大型車 (台)	合計 (台)	大型車 混入率 (%)	時間 係数 (%)	二輪車 (台)	小型車 (台)	大型車 (台)	合計 (台)	大型車 混入率 (%)	時間 係数 (%)	二輪車 (台)
14:00-14:15							14	1	15	6.7	1.7	0
14:15-14:30							14	2	16	12.5	1.8	0
14:30-14:45							9	4	13	30.8	1.5	0
14:45-15:00							15	3	18	16.7	2.0	0
1時間計							52	10	62	16.1	7.0	0
15:00-15:15							20	3	23	13.0	2.6	1
15:15-15:30							13	2	15	13.3	1.7	2
15:30-15:45							6	2	8	25.0	0.9	0
15:45-16:00							11	4	15	26.7	1.7	0
1時間計							50	11	61	18.0	6.9	3
16:00-16:15							17	3	20	15.0	2.3	0
16:15-16:30							12	2	14	14.3	1.6	1
16:30-16:45							9	0	9	0.0	1.0	1
16:45-17:00							15	4	19	21.1	2.1	2
1時間計							53	9	62	14.5	7.0	4
17:00-17:15							5	2	7	28.6	0.8	1
17:15-17:30							6	1	7	14.3	0.8	0
17:30-17:45							12	3	15	20.0	1.7	1
17:45-18:00							5	0	5	0.0	0.6	0
1時間計							28	6	34	17.6	3.8	2
18:00-18:15							6	2	8	25.0	0.9	0
18:15-18:30							9	1	10	10.0	1.1	0
18:30-18:45							8	1	9	11.1	1.0	0
18:45-19:00							6	1	7	14.3	0.8	1
1時間計							29	5	34	14.7	3.8	1
19:00-19:15							14	1	15	6.7	1.7	0
19:15-19:30							9	0	9	0.0	1.0	0
19:30-19:45							5	3	8	37.5	0.9	0
19:45-20:00							9	1	10	10.0	1.1	0
1時間計							37	5	42	11.9	4.7	0
20:00-20:15							4	3	7	42.9	0.8	0
20:15-20:30							9	2	11	18.2	1.2	0
20:30-20:45							6	1	7	14.3	0.8	0
20:45-21:00							2	1	3	33.3	0.3	0
1時間計							21	7	28	25.0	3.2	0
21:00-21:15							6	0	6	0.0	0.7	0
21:15-21:30							3	6	9	66.7	1.0	0
21:30-21:45							4	4	8	50.0	0.9	0
21:45-22:00							1	4	5	80.0	0.6	0
1時間計							14	14	28	50.0	3.2	0
昼12時間計							445	131	576	22.7	64.9	14
夜12時間計							172	139	311	44.7	35.1	10
全時間合計							617	270	887	30.4	100.0	24
昼夜率							1.39	2.06	1.54	-	-	1.71

方向別自動車交通量調査表

調査地点 : 地域社会5

調査年月日 : 令和元年 5月11日(土) 天候:晴れ時々曇り

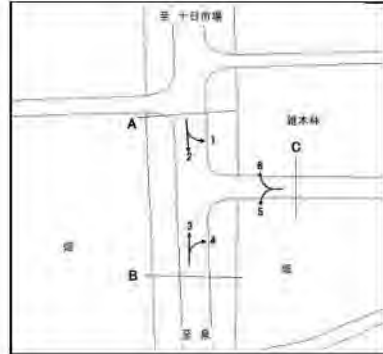

方向 種別 時間帯	1						2					
	小型車 (台)	大型車 (台)	合計 (台)	大型車 混入率 (%)	時間 係数 (%)	二輪車 (台)	小型車 (台)	大型車 (台)	合計 (台)	大型車 混入率 (%)	時間 係数 (%)	二輪車 (台)
22:00-22:15	12	0	12	0.0	0.7	0	67	5	72	6.9	1.2	8
22:15-22:30	16	0	16	0.0	0.9	0	64	9	73	12.3	1.3	2
22:30-22:45	15	0	15	0.0	0.9	0	53	6	59	10.2	1.0	3
22:45-23:00	18	1	19	5.3	1.1	0	44	4	48	8.3	0.8	8
1時間計	61	1	62	1.6	3.5	0	228	24	252	9.5	4.4	21
23:00-23:15	8	0	8	0.0	0.5	0	53	4	57	7.0	1.0	5
23:15-23:30	9	0	9	0.0	0.5	0	26	1	27	3.7	0.5	4
23:30-23:45	6	0	6	0.0	0.3	0	34	2	36	5.6	0.6	5
23:45-24:00	4	0	4	0.0	0.2	0	37	2	39	5.1	0.7	3
1時間計	27	0	27	0.0	1.5	0	150	9	159	5.7	2.7	17
0:00- 0:15	4	0	4	0.0	0.2	0	24	4	28	14.3	0.5	1
0:15- 0:30	3	0	3	0.0	0.2	0	24	7	31	22.6	0.5	2
0:30- 0:45	5	0	5	0.0	0.3	0	19	7	26	26.9	0.4	0
0:45- 1:00	3	0	3	0.0	0.2	0	21	5	26	19.2	0.4	2
1時間計	15	0	15	0.0	0.9	0	88	23	111	20.7	1.9	5
1:00- 1:15	6	1	7	14.3	0.4	0	16	3	19	15.8	0.3	1
1:15- 1:30	3	0	3	0.0	0.2	0	14	3	17	17.6	0.3	2
1:30- 1:45	4	0	4	0.0	0.2	0	8	5	13	38.5	0.2	1
1:45- 2:00	1	0	1	0.0	0.1	0	6	5	11	45.5	0.2	2
1時間計	14	1	15	6.7	0.9	0	44	16	60	26.7	1.0	6
2:00- 2:15	1	1	2	50.0	0.1	0	10	1	11	9.1	0.2	0
2:15- 2:30	1	0	1	0.0	0.1	0	14	1	15	6.7	0.3	2
2:30- 2:45	1	0	1	0.0	0.1	0	22	4	26	15.4	0.4	1
2:45- 3:00	0	0	0	0.0	0.0	0	16	2	18	11.1	0.3	0
1時間計	3	1	4	25.0	0.2	0	62	8	70	11.4	1.2	3
3:00- 3:15	0	0	0	0.0	0.0	0	11	0	11	0.0	0.2	3
3:15- 3:30	1	0	1	0.0	0.1	0	14	1	15	6.7	0.3	1
3:30- 3:45	2	0	2	0.0	0.1	0	9	3	12	25.0	0.2	2
3:45- 4:00	2	0	2	0.0	0.1	0	11	2	13	15.4	0.2	2
1時間計	5	0	5	0.0	0.3	0	45	6	51	11.8	0.9	8
4:00- 4:15	1	0	1	0.0	0.1	0	12	5	17	29.4	0.3	1
4:15- 4:30	0	0	0	0.0	0.0	0	13	8	21	38.1	0.4	1
4:30- 4:45	1	0	1	0.0	0.1	0	15	4	19	21.1	0.3	2
4:45- 5:00	1	0	1	0.0	0.1	0	10	5	15	33.3	0.3	0
1時間計	3	0	3	0.0	0.2	0	50	22	72	30.6	1.2	4
5:00- 5:15	2	0	2	0.0	0.1	0	16	3	19	15.8	0.3	5
5:15- 5:30	6	1	7	14.3	0.4	0	10	4	14	28.6	0.2	1
5:30- 5:45	13	0	13	0.0	0.7	1	16	7	23	30.4	0.4	1
5:45- 6:00	14	0	14	0.0	0.8	1	14	4	18	22.2	0.3	0
1時間計	35	1	36	2.8	2.1	2	56	18	74	24.3	1.3	7

方向別自動車交通量調査表

調査地点 : 地域社会5

調査年月日 : 令和元年 5月11日(土) 天候:晴れ時々曇り

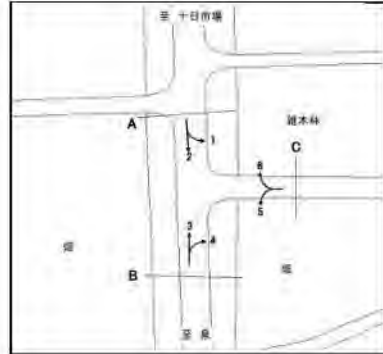

方向 時間帯	1						2					
	種別 小型車 (台)	大型車 (台)	合計 (台)	大型車 混入率 (%)	時間 係数 (%)	二輪車 (台)	小型車 (台)	大型車 (台)	合計 (台)	大型車 混入率 (%)	時間 係数 (%)	二輪車 (台)
6:00-6:15	8	0	8	0.0	0.5	0	23	5	28	17.9	0.5	2
6:15-6:30	8	0	8	0.0	0.5	2	33	8	41	19.5	0.7	3
6:30-6:45	5	0	5	0.0	0.3	0	26	5	31	16.1	0.5	4
6:45-7:00	9	0	9	0.0	0.5	0	36	4	40	10.0	0.7	4
1時間計	30	0	30	0.0	1.7	2	118	22	140	15.7	2.4	13
7:00-7:15	18	0	18	0.0	1.0	0	47	4	51	7.8	0.9	2
7:15-7:30	14	0	14	0.0	0.8	1	51	10	61	16.4	1.1	5
7:30-7:45	14	0	14	0.0	0.8	0	50	0	50	0.0	0.9	2
7:45-8:00	24	1	25	4.0	1.4	0	59	6	65	9.2	1.1	6
1時間計	70	1	71	1.4	4.1	1	207	20	227	8.8	3.9	15
8:00-8:15	25	0	25	0.0	1.4	0	59	10	69	14.5	1.2	3
8:15-8:30	13	2	15	13.3	0.9	2	69	2	71	2.8	1.2	6
8:30-8:45	15	1	16	6.3	0.9	2	61	5	66	7.6	1.1	3
8:45-9:00	23	3	26	11.5	1.5	1	78	9	87	10.3	1.5	11
1時間計	76	6	82	7.3	4.7	5	267	26	293	8.9	5.1	23
9:00-9:15	11	0	11	0.0	0.6	3	53	2	55	3.6	0.9	7
9:15-9:30	20	2	22	9.1	1.3	1	79	7	86	8.1	1.5	6
9:30-9:45	16	3	19	15.8	1.1	0	48	4	52	7.7	0.9	2
9:45-10:00	14	1	15	6.7	0.9	1	56	2	58	3.4	1.0	5
1時間計	61	6	67	9.0	3.8	5	236	15	251	6.0	4.3	20
10:00-10:15	20	3	23	13.0	1.3	0	76	8	84	9.5	1.5	3
10:15-10:30	14	0	14	0.0	0.8	2	61	4	65	6.2	1.1	8
10:30-10:45	32	0	32	0.0	1.8	0	83	6	89	6.7	1.5	3
10:45-11:00	31	1	32	3.1	1.8	1	70	4	74	5.4	1.3	8
1時間計	97	4	101	4.0	5.8	3	290	22	312	7.1	5.4	22
11:00-11:15	36	0	36	0.0	2.1	2	76	2	78	2.6	1.3	6
11:15-11:30	29	0	29	0.0	1.7	3	88	4	92	4.3	1.6	7
11:30-11:45	19	0	19	0.0	1.1	1	77	2	79	2.5	1.4	7
11:45-12:00	34	0	34	0.0	1.9	3	92	5	97	5.2	1.7	6
1時間計	118	0	118	0.0	6.7	9	333	13	346	3.8	6.0	26
12:00-12:15	21	0	21	0.0	1.2	5	76	3	79	3.8	1.4	7
12:15-12:30	24	0	24	0.0	1.4	0	100	5	105	4.8	1.8	2
12:30-12:45	26	0	26	0.0	1.5	1	70	2	72	2.8	1.2	4
12:45-13:00	32	0	32	0.0	1.8	1	94	4	98	4.1	1.7	4
1時間計	103	0	103	0.0	5.9	7	340	14	354	4.0	6.1	17
13:00-13:15	20	0	20	0.0	1.1	1	72	1	73	1.4	1.3	8
13:15-13:30	23	0	23	0.0	1.3	1	81	3	84	3.6	1.5	2
13:30-13:45	24	0	24	0.0	1.4	3	89	5	94	5.3	1.6	10
13:45-14:00	46	0	46	0.0	2.6	3	92	0	92	0.0	1.6	6
1時間計	113	0	113	0.0	6.4	8	334	9	343	2.6	5.9	26

方向別自動車交通量調査表

調査地点：地域社会5

調査年月日：令和元年 5月11日(土) 天候：晴れ時々曇り

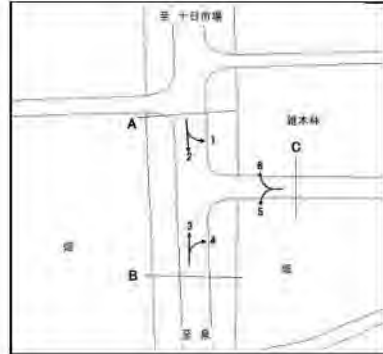

方向 種別 時間帯	1						2					
	小型車 (台)	大型車 (台)	合計 (台)	大型車 混入率 (%)	時間 係数 (%)	二輪車 (台)	小型車 (台)	大型車 (台)	合計 (台)	大型車 混入率 (%)	時間 係数 (%)	二輪車 (台)
14:00-14:15	35	0	35	0.0	2.0	3	97	6	103	5.8	1.8	7
14:15-14:30	38	0	38	0.0	2.2	3	94	4	98	4.1	1.7	10
14:30-14:45	27	1	28	3.6	1.6	2	80	1	81	1.2	1.4	5
14:45-15:00	51	1	52	1.9	3.0	5	85	3	88	3.4	1.5	10
1時間計	151	2	153	1.3	8.7	13	356	14	370	3.8	6.4	32
15:00-15:15	27	0	27	0.0	1.5	0	113	5	118	4.2	2.0	7
15:15-15:30	26	1	27	3.7	1.5	0	79	3	82	3.7	1.4	7
15:30-15:45	31	1	32	3.1	1.8	2	107	1	108	0.9	1.9	9
15:45-16:00	39	0	39	0.0	2.2	3	94	1	95	1.1	1.6	4
1時間計	123	2	125	1.6	7.1	5	393	10	403	2.5	7.0	27
16:00-16:15	30	0	30	0.0	1.7	3	94	2	96	2.1	1.7	6
16:15-16:30	34	1	35	2.9	2.0	1	71	5	76	6.6	1.3	9
16:30-16:45	40	0	40	0.0	2.3	3	94	4	98	4.1	1.7	3
16:45-17:00	35	0	35	0.0	2.0	1	75	2	77	2.6	1.3	11
1時間計	139	1	140	0.7	8.0	8	334	13	347	3.7	6.0	29
17:00-17:15	48	1	49	2.0	2.8	1	75	0	75	0.0	1.3	6
17:15-17:30	27	1	28	3.6	1.6	5	97	4	101	4.0	1.7	9
17:30-17:45	39	0	39	0.0	2.2	4	99	4	103	3.9	1.8	10
17:45-18:00	40	0	40	0.0	2.3	3	86	2	88	2.3	1.5	7
1時間計	154	2	156	1.3	8.9	13	357	10	367	2.7	6.3	32
18:00-18:15	19	1	20	5.0	1.1	2	91	2	93	2.2	1.6	9
18:15-18:30	24	0	24	0.0	1.4	0	77	4	81	4.9	1.4	9
18:30-18:45	39	0	39	0.0	2.2	4	85	6	91	6.6	1.6	5
18:45-19:00	22	1	23	4.3	1.3	1	85	0	85	0.0	1.5	5
1時間計	104	2	106	1.9	6.1	7	338	12	350	3.4	6.0	28
19:00-19:15	25	1	26	3.8	1.5	2	68	2	70	2.9	1.2	5
19:15-19:30	29	0	29	0.0	1.7	1	75	4	79	5.1	1.4	5
19:30-19:45	33	0	33	0.0	1.9	0	89	4	93	4.3	1.6	10
19:45-20:00	10	0	10	0.0	0.6	0	63	2	65	3.1	1.1	8
1時間計	97	1	98	1.0	5.6	3	295	12	307	3.9	5.3	28
20:00-20:15	25	1	26	3.8	1.5	1	82	2	84	2.4	1.5	10
20:15-20:30	14	0	14	0.0	0.8	1	57	1	58	1.7	1.0	5
20:30-20:45	15	0	15	0.0	0.9	1	81	2	83	2.4	1.4	5
20:45-21:00	13	0	13	0.0	0.7	1	53	2	55	3.6	0.9	5
1時間計	67	1	68	1.5	3.9	4	273	7	280	2.5	4.8	25
21:00-21:15	16	0	16	0.0	0.9	1	78	3	81	3.7	1.4	5
21:15-21:30	11	0	11	0.0	0.6	1	50	3	53	5.7	0.9	1
21:30-21:45	21	0	21	0.0	1.2	2	69	3	72	4.2	1.2	9
21:45-22:00	6	0	6	0.0	0.3	1	43	4	47	8.5	0.8	3
1時間計	54	0	54	0.0	3.1	5	240	13	253	5.1	4.4	18
昼12時間計	1309	26	1335	1.9	76.2	84	3785	178	3963	4.5	68.4	297
夜12時間計	411	6	417	1.4	23.8	16	1649	180	1829	9.8	31.6	155
全時間合計	1720	32	1752	1.8	100.0	100	5434	358	5792	6.2	100.0	452
昼夜率	1.31	1.23	1.31	-	-	1.19	1.44	2.01	1.46	-	-	1.52

方向別自動車交通量調査表

調査地点 : 地域社会5

調査年月日 : 令和元年 5月11日(土) 天候:晴れ時々曇り

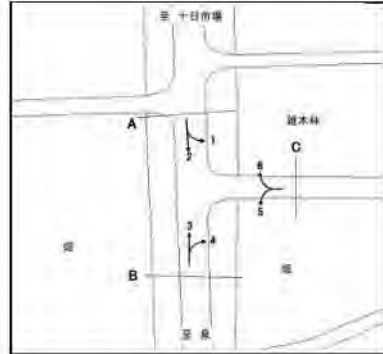

方向 種別 時間帯							A 合計 (1+2)					
	小型車 (台)	大型車 (台)	合計 (台)	大型車 混入率 (%)	時間 数 (%)	二輪車 (台)	小型車 (台)	大型車 (台)	合計 (台)	大型車 混入率 (%)	時間 数 (%)	二輪車 (台)
22:00-22:15							79	5	84	6.0	1.1	8
22:15-22:30							80	9	89	10.1	1.2	2
22:30-22:45							68	6	74	8.1	1.0	3
22:45-23:00							62	5	67	7.5	0.9	8
1時間計							289	25	314	8.0	4.2	21
23:00-23:15							61	4	65	6.2	0.9	5
23:15-23:30							35	1	36	2.8	0.5	4
23:30-23:45							40	2	42	4.8	0.6	5
23:45-24:00							41	2	43	4.7	0.6	3
1時間計							177	9	186	4.8	2.5	17
0:00-0:15							28	4	32	12.5	0.4	1
0:15-0:30							27	7	34	20.6	0.5	2
0:30-0:45							24	7	31	22.6	0.4	0
0:45-1:00							24	5	29	17.2	0.4	2
1時間計							103	23	126	18.3	1.7	5
1:00-1:15							22	4	26	15.4	0.3	1
1:15-1:30							17	3	20	15.0	0.3	2
1:30-1:45							12	5	17	29.4	0.2	1
1:45-2:00							7	5	12	41.7	0.2	2
1時間計							58	17	75	22.7	1.0	6
2:00-2:15							11	2	13	15.4	0.2	0
2:15-2:30							15	1	16	6.3	0.2	2
2:30-2:45							23	4	27	14.8	0.4	1
2:45-3:00							16	2	18	11.1	0.2	0
1時間計							65	9	74	12.2	1.0	3
3:00-3:15							11	0	11	0.0	0.1	3
3:15-3:30							15	1	16	6.3	0.2	1
3:30-3:45							11	3	14	21.4	0.2	2
3:45-4:00							13	2	15	13.3	0.2	2
1時間計							50	6	56	10.7	0.7	8
4:00-4:15							13	5	18	27.8	0.2	1
4:15-4:30							13	8	21	38.1	0.3	1
4:30-4:45							16	4	20	20.0	0.3	2
4:45-5:00							11	5	16	31.3	0.2	0
1時間計							53	22	75	29.3	1.0	4
5:00-5:15							18	3	21	14.3	0.3	5
5:15-5:30							16	5	21	23.8	0.3	1
5:30-5:45							29	7	36	19.4	0.5	2
5:45-6:00							28	4	32	12.5	0.4	1
1時間計							91	19	110	17.3	1.5	9

方向別自動車交通量調査表

調査地点 : 地域社会5

調査年月日 : 令和元年 5月11日(土) 天候:晴れ時々曇り

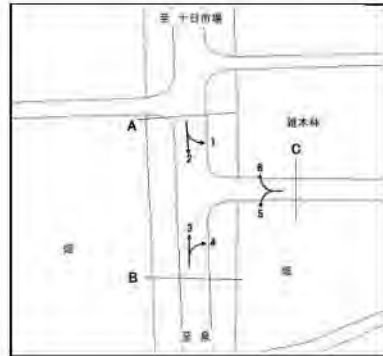

時間帯	方向 種別						A 合計 (1+2)					
		小型車 (台)	大型車 (台)	合計 (台)	大型車 混入率 (%)	時間 数 (%)	二輪車 (台)	小型車 (台)	大型車 (台)	合計 (台)	大型車 混入率 (%)	時間 数 (%)
6:00-6:15							31	5	36	13.9	0.5	2
6:15-6:30							41	8	49	16.3	0.6	5
6:30-6:45							31	5	36	13.9	0.5	4
6:45-7:00							45	4	49	8.2	0.6	4
1時間計							148	22	170	12.9	2.3	15
7:00-7:15							65	4	69	5.8	0.9	2
7:15-7:30							65	10	75	13.3	1.0	6
7:30-7:45							64	0	64	0.0	0.8	2
7:45-8:00							83	7	90	7.8	1.2	6
1時間計							277	21	298	7.0	4.0	16
8:00-8:15							84	10	94	10.6	1.2	3
8:15-8:30							82	4	86	4.7	1.1	8
8:30-8:45							76	6	82	7.3	1.1	5
8:45-9:00							101	12	113	10.6	1.5	12
1時間計							343	32	375	8.5	5.0	28
9:00-9:15							64	2	66	3.0	0.9	10
9:15-9:30							99	9	108	8.3	1.4	7
9:30-9:45							64	7	71	9.9	0.9	2
9:45-10:00							70	3	73	4.1	1.0	6
1時間計							297	21	318	6.6	4.2	25
10:00-10:15							96	11	107	10.3	1.4	3
10:15-10:30							75	4	79	5.1	1.0	10
10:30-10:45							115	6	121	5.0	1.6	3
10:45-11:00							101	5	106	4.7	1.4	9
1時間計							387	26	413	6.3	5.5	25
11:00-11:15							112	2	114	1.8	1.5	8
11:15-11:30							117	4	121	3.3	1.6	10
11:30-11:45							96	2	98	2.0	1.3	8
11:45-12:00							126	5	131	3.8	1.7	9
1時間計							451	13	464	2.8	6.2	35
12:00-12:15							97	3	100	3.0	1.3	12
12:15-12:30							124	5	129	3.9	1.7	2
12:30-12:45							96	2	98	2.0	1.3	5
12:45-13:00							126	4	130	3.1	1.7	5
1時間計							443	14	457	3.1	6.1	24
13:00-13:15							92	1	93	1.1	1.2	9
13:15-13:30							104	3	107	2.8	1.4	3
13:30-13:45							113	5	118	4.2	1.6	13
13:45-14:00							138	0	138	0.0	1.8	9
1時間計							447	9	456	2.0	6.0	34

方向別自動車交通量調査表

調査地点 : 地域社会5

調査年月日 : 令和元年 5月11日(土) 天候:晴れ時々曇り

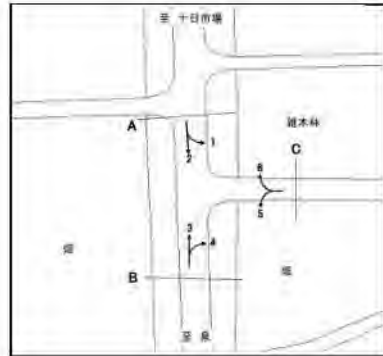

時間帯	方向 種別						A 合計 (1+2)					
		小型車 (台)	大型車 (台)	合計 (台)	大型車 混入率 (%)	時 間 係 数 (%)	二輪車 (台)	小型車 (台)	大型車 (台)	合計 (台)	大型車 混入率 (%)	時 間 係 数 (%)
14:00-14:15							132	6	138	4.3	1.8	10
14:15-14:30							132	4	136	2.9	1.8	13
14:30-14:45							107	2	109	1.8	1.4	7
14:45-15:00							136	4	140	2.9	1.9	15
1時間計							507	16	523	3.1	6.9	45
15:00-15:15							140	5	145	3.4	1.9	7
15:15-15:30							105	4	109	3.7	1.4	7
15:30-15:45							138	2	140	1.4	1.9	11
15:45-16:00							133	1	134	0.7	1.8	7
1時間計							516	12	528	2.3	7.0	32
16:00-16:15							124	2	126	1.6	1.7	9
16:15-16:30							105	6	111	5.4	1.5	10
16:30-16:45							134	4	138	2.9	1.8	6
16:45-17:00							110	2	112	1.8	1.5	12
1時間計							473	14	487	2.9	6.5	37
17:00-17:15							123	1	124	0.8	1.6	7
17:15-17:30							124	5	129	3.9	1.7	14
17:30-17:45							138	4	142	2.8	1.9	14
17:45-18:00							126	2	128	1.6	1.7	10
1時間計							511	12	523	2.3	6.9	45
18:00-18:15							110	3	113	2.7	1.5	11
18:15-18:30							101	4	105	3.8	1.4	9
18:30-18:45							124	6	130	4.6	1.7	9
18:45-19:00							107	1	108	0.9	1.4	6
1時間計							442	14	456	3.1	6.0	35
19:00-19:15							93	3	96	3.1	1.3	7
19:15-19:30							104	4	108	3.7	1.4	6
19:30-19:45							122	4	126	3.2	1.7	10
19:45-20:00							73	2	75	2.7	1.0	8
1時間計							392	13	405	3.2	5.4	31
20:00-20:15							107	3	110	2.7	1.5	11
20:15-20:30							71	1	72	1.4	1.0	6
20:30-20:45							96	2	98	2.0	1.3	6
20:45-21:00							66	2	68	2.9	0.9	6
1時間計							340	8	348	2.3	4.6	29
21:00-21:15							94	3	97	3.1	1.3	6
21:15-21:30							61	3	64	4.7	0.8	2
21:30-21:45							90	3	93	3.2	1.2	11
21:45-22:00							49	4	53	7.5	0.7	4
1時間計							294	13	307	4.2	4.1	23
昼12時間計							5094	204	5298	3.9	70.2	381
夜12時間計							2060	186	2246	8.3	29.8	171
全時間合計							7154	390	7544	5.2	100.0	552
昼 夜 率							1.40	1.91	1.42	-	-	1.45

方向別自動車交通量調査表

調査地点 : 地域社会5

調査年月日 : 令和元年 5月11日(土) 天候:晴れ時々曇り

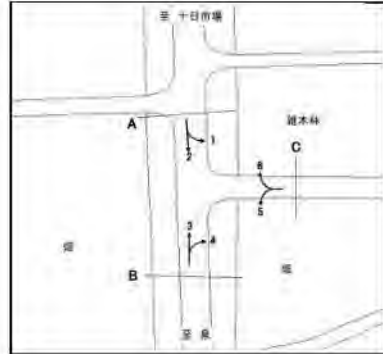

方向 種別 時間帯	3						4					
	小型車 (台)	大型車 (台)	合計 (台)	大型車 混入率 (%)	時間 係数 (%)	二輪車 (台)	小型車 (台)	大型車 (台)	合計 (台)	大型車 混入率 (%)	時間 係数 (%)	二輪車 (台)
22:00-22:15	43	1	44	2.3	0.7	5	4	0	4	0.0	0.5	0
22:15-22:30	29	4	33	12.1	0.5	2	2	0	2	0.0	0.3	1
22:30-22:45	41	4	45	8.9	0.7	2	6	0	6	0.0	0.8	1
22:45-23:00	31	3	34	8.8	0.6	0	3	0	3	0.0	0.4	2
1時間計	144	12	156	7.7	2.6	9	15	0	15	0.0	1.9	4
23:00-23:15	31	7	38	18.4	0.6	3	9	0	9	0.0	1.1	2
23:15-23:30	41	5	46	10.9	0.8	4	5	0	5	0.0	0.6	0
23:30-23:45	24	4	28	14.3	0.5	3	5	0	5	0.0	0.6	3
23:45-24:00	20	1	21	4.8	0.3	2	2	0	2	0.0	0.3	0
1時間計	116	17	133	12.8	2.2	12	21	0	21	0.0	2.7	5
0:00-0:15	16	2	18	11.1	0.3	2	0	0	0	0.0	0.0	0
0:15-0:30	10	0	10	0.0	0.2	0	1	0	1	0.0	0.1	0
0:30-0:45	20	0	20	0.0	0.3	2	0	0	0	0.0	0.0	0
0:45-1:00	16	4	20	20.0	0.3	4	0	0	0	0.0	0.0	0
1時間計	62	6	68	8.8	1.1	8	1	0	1	0.0	0.1	0
1:00-1:15	14	4	18	22.2	0.3	0	0	0	0	0.0	0.0	1
1:15-1:30	11	1	12	8.3	0.2	2	2	1	3	33.3	0.4	0
1:30-1:45	13	4	17	23.5	0.3	2	0	0	0	0.0	0.0	0
1:45-2:00	13	5	18	27.8	0.3	0	0	1	1	100.0	0.1	0
1時間計	51	14	65	21.5	1.1	4	2	2	4	50.0	0.5	1
2:00-2:15	8	2	10	20.0	0.2	1	2	0	2	0.0	0.3	0
2:15-2:30	6	2	8	25.0	0.1	2	1	0	1	0.0	0.1	1
2:30-2:45	10	5	15	33.3	0.2	0	1	0	1	0.0	0.1	0
2:45-3:00	9	7	16	43.8	0.3	0	0	0	0	0.0	0.0	0
1時間計	33	16	49	32.7	0.8	3	4	0	4	0.0	0.5	1
3:00-3:15	10	6	16	37.5	0.3	0	0	0	0	0.0	0.0	0
3:15-3:30	8	5	13	38.5	0.2	1	1	0	1	0.0	0.1	0
3:30-3:45	13	3	16	18.8	0.3	0	0	0	0	0.0	0.0	1
3:45-4:00	12	3	15	20.0	0.2	1	0	0	0	0.0	0.0	1
1時間計	43	17	60	28.3	1.0	2	1	0	1	0.0	0.1	2
4:00-4:15	9	2	11	18.2	0.2	0	0	0	0	0.0	0.0	0
4:15-4:30	11	1	12	8.3	0.2	0	2	0	2	0.0	0.3	0
4:30-4:45	13	1	14	7.1	0.2	2	1	0	1	0.0	0.1	0
4:45-5:00	16	3	19	15.8	0.3	2	1	0	1	0.0	0.1	0
1時間計	49	7	56	12.5	0.9	4	4	0	4	0.0	0.5	0
5:00-5:15	24	9	33	27.3	0.5	4	1	0	1	0.0	0.1	0
5:15-5:30	22	6	28	21.4	0.5	3	5	0	5	0.0	0.6	0
5:30-5:45	23	4	27	14.8	0.4	3	6	0	6	0.0	0.8	1
5:45-6:00	22	5	27	18.5	0.4	1	3	0	3	0.0	0.4	2
1時間計	91	24	115	20.9	1.9	11	15	0	15	0.0	1.9	3

方向別自動車交通量調査表

調査地点 : 地域社会5

調査年月日 : 令和元年 5月11日(土) 天候:晴れ時々曇り

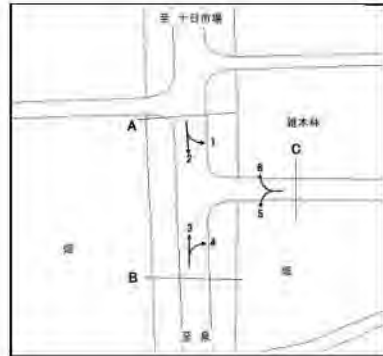

方向 時間帯	3						4					
	種別 小型車 (台)	大型車 (台)	合計 (台)	大型車 混入率 (%)	時間 係数 (%)	二輪車 (台)	小型車 (台)	大型車 (台)	合計 (台)	大型車 混入率 (%)	時間 係数 (%)	二輪車 (台)
6:00-6:15	35	4	39	10.3	0.6	4	7	0	7	0.0	0.9	0
6:15-6:30	36	2	38	5.3	0.6	0	11	1	12	8.3	1.5	0
6:30-6:45	50	3	53	5.7	0.9	6	11	0	11	0.0	1.4	0
6:45-7:00	53	7	60	11.7	1.0	4	5	0	5	0.0	0.6	3
1時間計	174	16	190	8.4	3.2	14	34	1	35	2.9	4.4	3
7:00-7:15	59	6	65	9.2	1.1	5	18	0	18	0.0	2.3	2
7:15-7:30	72	9	81	11.1	1.3	8	19	0	19	0.0	2.4	3
7:30-7:45	73	6	79	7.6	1.3	9	11	0	11	0.0	1.4	2
7:45-8:00	70	4	74	5.4	1.2	8	9	0	9	0.0	1.1	1
1時間計	274	25	299	8.4	5.0	30	57	0	57	0.0	7.2	8
8:00-8:15	75	3	78	3.8	1.3	16	9	0	9	0.0	1.1	1
8:15-8:30	102	7	109	6.4	1.8	12	2	0	2	0.0	0.3	1
8:30-8:45	105	6	111	5.4	1.8	10	9	1	10	10.0	1.3	0
8:45-9:00	79	3	82	3.7	1.4	8	12	0	12	0.0	1.5	2
1時間計	361	19	380	5.0	6.3	46	32	1	33	3.0	4.2	4
9:00-9:15	78	4	82	4.9	1.4	8	9	0	9	0.0	1.1	2
9:15-9:30	90	8	98	8.2	1.6	11	13	0	13	0.0	1.7	1
9:30-9:45	90	4	94	4.3	1.6	13	9	0	9	0.0	1.1	0
9:45-10:00	107	5	112	4.5	1.9	8	16	0	16	0.0	2.0	1
1時間計	365	21	386	5.4	6.4	40	47	0	47	0.0	6.0	4
10:00-10:15	85	1	86	1.2	1.4	3	27	0	27	0.0	3.4	3
10:15-10:30	91	1	92	1.1	1.5	4	12	0	12	0.0	1.5	1
10:30-10:45	87	5	92	5.4	1.5	6	13	0	13	0.0	1.7	1
10:45-11:00	70	3	73	4.1	1.2	8	19	1	20	5.0	2.5	0
1時間計	333	10	343	2.9	5.7	21	71	1	72	1.4	9.1	5
11:00-11:15	95	2	97	2.1	1.6	5	14	0	14	0.0	1.8	0
11:15-11:30	99	3	102	2.9	1.7	12	10	0	10	0.0	1.3	2
11:30-11:45	96	3	99	3.0	1.6	8	12	0	12	0.0	1.5	0
11:45-12:00	84	5	89	5.6	1.5	3	10	0	10	0.0	1.3	0
1時間計	374	13	387	3.4	6.4	28	46	0	46	0.0	5.8	2
12:00-12:15	74	5	79	6.3	1.3	4	17	1	18	5.6	2.3	1
12:15-12:30	97	0	97	0.0	1.6	6	19	1	20	5.0	2.5	1
12:30-12:45	102	3	105	2.9	1.7	9	7	1	8	12.5	1.0	0
12:45-13:00	110	3	113	2.7	1.9	4	14	0	14	0.0	1.8	0
1時間計	383	11	394	2.8	6.6	23	57	3	60	5.0	7.6	2
13:00-13:15	92	3	95	3.2	1.6	7	17	0	17	0.0	2.2	1
13:15-13:30	80	2	82	2.4	1.4	7	14	0	14	0.0	1.8	0
13:30-13:45	100	5	105	4.8	1.7	6	19	0	19	0.0	2.4	2
13:45-14:00	67	1	68	1.5	1.1	8	12	0	12	0.0	1.5	0
1時間計	339	11	350	3.1	5.8	28	62	0	62	0.0	7.9	3

方向別自動車交通量調査表

調査地点 : 地域社会5

調査年月日 : 令和元年 5月11日(土) 天候:晴れ時々曇り

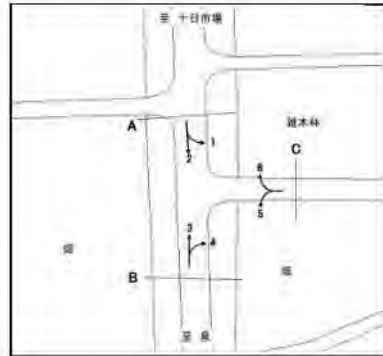

方向 種別 時間帯	3						4					
	小型車 (台)	大型車 (台)	合計 (台)	大型車 混入率 (%)	時 間 係 数 (%)	二輪車 (台)	小型車 (台)	大型車 (台)	合計 (台)	大型車 混入率 (%)	時 間 係 数 (%)	二輪車 (台)
14:00-14:15	93	3	96	3.1	1.6	4	15	0	15	0.0	1.9	0
14:15-14:30	101	5	106	4.7	1.8	6	12	0	12	0.0	1.5	0
14:30-14:45	98	1	99	1.0	1.6	6	14	0	14	0.0	1.8	1
14:45-15:00	85	3	88	3.4	1.5	5	11	0	11	0.0	1.4	0
1時間計	377	12	389	3.1	6.5	21	52	0	52	0.0	6.6	1
15:00-15:15	73	3	76	3.9	1.3	6	8	0	8	0.0	1.0	3
15:15-15:30	101	3	104	2.9	1.7	8	13	0	13	0.0	1.7	0
15:30-15:45	89	4	93	4.3	1.5	8	11	0	11	0.0	1.4	1
15:45-16:00	104	5	109	4.6	1.8	7	15	0	15	0.0	1.9	1
1時間計	367	15	382	3.9	6.4	29	47	0	47	0.0	6.0	5
16:00-16:15	78	1	79	1.3	1.3	7	23	0	23	0.0	2.9	2
16:15-16:30	108	2	110	1.8	1.8	7	13	0	13	0.0	1.7	0
16:30-16:45	103	3	106	2.8	1.8	11	16	0	16	0.0	2.0	0
16:45-17:00	88	5	93	5.4	1.5	10	10	0	10	0.0	1.3	1
1時間計	377	11	388	2.8	6.5	35	62	0	62	0.0	7.9	3
17:00-17:15	98	2	100	2.0	1.7	9	9	0	9	0.0	1.1	1
17:15-17:30	90	2	92	2.2	1.5	8	12	0	12	0.0	1.5	1
17:30-17:45	82	1	83	1.2	1.4	11	15	1	16	6.3	2.0	2
17:45-18:00	86	3	89	3.4	1.5	9	12	0	12	0.0	1.5	1
1時間計	356	8	364	2.2	6.1	37	48	1	49	2.0	6.2	5
18:00-18:15	76	2	78	2.6	1.3	5	7	0	7	0.0	0.9	0
18:15-18:30	86	6	92	6.5	1.5	8	12	0	12	0.0	1.5	0
18:30-18:45	81	3	84	3.6	1.4	7	6	0	6	0.0	0.8	0
18:45-19:00	70	3	73	4.1	1.2	9	8	0	8	0.0	1.0	1
1時間計	313	14	327	4.3	5.4	29	33	0	33	0.0	4.2	1
19:00-19:15	65	2	67	3.0	1.1	7	6	0	6	0.0	0.8	1
19:15-19:30	68	3	71	4.2	1.2	3	5	0	5	0.0	0.6	2
19:30-19:45	60	1	61	1.6	1.0	6	6	0	6	0.0	0.8	0
19:45-20:00	45	1	46	2.2	0.8	4	4	0	4	0.0	0.5	1
1時間計	238	7	245	2.9	4.1	20	21	0	21	0.0	2.7	4
20:00-20:15	74	7	81	8.6	1.3	6	6	0	6	0.0	0.8	0
20:15-20:30	57	2	59	3.4	1.0	5	2	0	2	0.0	0.3	1
20:30-20:45	56	0	56	0.0	0.9	2	10	0	10	0.0	1.3	0
20:45-21:00	57	1	58	1.7	1.0	2	6	0	6	0.0	0.8	1
1時間計	244	10	254	3.9	4.2	15	24	0	24	0.0	3.0	2
21:00-21:15	47	1	48	2.1	0.8	2	5	0	5	0.0	0.6	0
21:15-21:30	55	3	58	5.2	1.0	4	6	0	6	0.0	0.8	0
21:30-21:45	52	3	55	5.5	0.9	6	3	0	3	0.0	0.4	0
21:45-22:00	58	5	63	7.9	1.0	3	8	0	8	0.0	1.0	1
1時間計	212	12	224	5.4	3.7	15	22	0	22	0.0	2.8	1
昼12時間計	4219	170	4389	3.9	73.1	367	614	6	620	1.0	78.8	43
夜12時間計	1457	158	1615	9.8	26.9	117	164	3	167	1.8	21.2	26
全時間合計	5676	328	6004	5.5	100.0	484	778	9	787	1.1	100.0	69
昼 夜 率	1.35	1.93	1.37	-	-	1.32	1.27	1.50	1.27	-	-	1.60

方向別自動車交通量調査表

調査地点 : 地域社会5

調査年月日 : 令和元年 5月11日(土) 天候:晴れ時々曇り



方向 種別 時間帯							B 合計 (3+ 4)					
	小型車 (台)	大型車 (台)	合計 (台)	大型車 混入率 (%)	時間 係数 (%)	二輪車 (台)	小型車 (台)	大型車 (台)	合計 (台)	大型車 混入率 (%)	時間 係数 (%)	二輪車 (台)
22:00-22:15							47	1	48	2.1	0.7	5
22:15-22:30							31	4	35	11.4	0.5	3
22:30-22:45							47	4	51	7.8	0.8	3
22:45-23:00							34	3	37	8.1	0.5	2
1時間計							159	12	171	7.0	2.5	13
23:00-23:15							40	7	47	14.9	0.7	5
23:15-23:30							46	5	51	9.8	0.8	4
23:30-23:45							29	4	33	12.1	0.5	6
23:45-24:00							22	1	23	4.3	0.3	2
1時間計							137	17	154	11.0	2.3	17
0:00- 0:15							16	2	18	11.1	0.3	2
0:15- 0:30							11	0	11	0.0	0.2	0
0:30- 0:45							20	0	20	0.0	0.3	2
0:45- 1:00							16	4	20	20.0	0.3	4
1時間計							63	6	69	8.7	1.0	8
1:00- 1:15							14	4	18	22.2	0.3	1
1:15- 1:30							13	2	15	13.3	0.2	2
1:30- 1:45							13	4	17	23.5	0.3	2
1:45- 2:00							13	6	19	31.6	0.3	0
1時間計							53	16	69	23.2	1.0	5
2:00- 2:15							10	2	12	16.7	0.2	1
2:15- 2:30							7	2	9	22.2	0.1	3
2:30- 2:45							11	5	16	31.3	0.2	0
2:45- 3:00							9	7	16	43.8	0.2	0
1時間計							37	16	53	30.2	0.8	4
3:00- 3:15							10	6	16	37.5	0.2	0
3:15- 3:30							9	5	14	35.7	0.2	1
3:30- 3:45							13	3	16	18.8	0.2	1
3:45- 4:00							12	3	15	20.0	0.2	2
1時間計							44	17	61	27.9	0.9	4
4:00- 4:15							9	2	11	18.2	0.2	0
4:15- 4:30							13	1	14	7.1	0.2	0
4:30- 4:45							14	1	15	6.7	0.2	2
4:45- 5:00							17	3	20	15.0	0.3	2
1時間計							53	7	60	11.7	0.9	4
5:00- 5:15							25	9	34	26.5	0.5	4
5:15- 5:30							27	6	33	18.2	0.5	3
5:30- 5:45							29	4	33	12.1	0.5	4
5:45- 6:00							25	5	30	16.7	0.4	3
1時間計							106	24	130	18.5	1.9	14

方向別自動車交通量調査表

調査地点 : 地域社会5

調査年月日 : 令和元年 5月11日(土) 天候:晴れ時々曇り

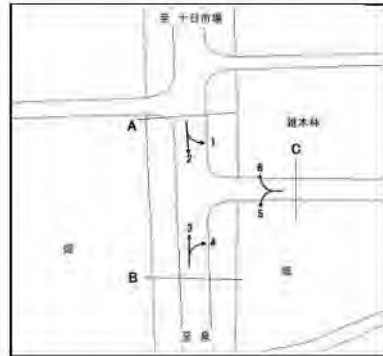

時間帯	方向 種別							B 合計 (3+4)					
		小型車 (台)	大型車 (台)	合計 (台)	大型車 混入率 (%)	時間 係数 (%)	二輪車 (台)	小型車 (台)	大型車 (台)	合計 (台)	大型車 混入率 (%)	時間 係数 (%)	二輪車 (台)
6:00-6:15							42	4	46	8.7	0.7	4	
6:15-6:30							47	3	50	6.0	0.7	0	
6:30-6:45							61	3	64	4.7	0.9	6	
6:45-7:00							58	7	65	10.8	1.0	7	
1時間計							208	17	225	7.6	3.3	17	
7:00-7:15							77	6	83	7.2	1.2	7	
7:15-7:30							91	9	100	9.0	1.5	11	
7:30-7:45							84	6	90	6.7	1.3	11	
7:45-8:00							79	4	83	4.8	1.2	9	
1時間計							331	25	356	7.0	5.2	38	
8:00-8:15							84	3	87	3.4	1.3	17	
8:15-8:30							104	7	111	6.3	1.6	13	
8:30-8:45							114	7	121	5.8	1.8	10	
8:45-9:00							91	3	94	3.2	1.4	10	
1時間計							393	20	413	4.8	6.1	50	
9:00-9:15							87	4	91	4.4	1.3	10	
9:15-9:30							103	8	111	7.2	1.6	12	
9:30-9:45							99	4	103	3.9	1.5	13	
9:45-10:00							123	5	128	3.9	1.9	9	
1時間計							412	21	433	4.8	6.4	44	
10:00-10:15							112	1	113	0.9	1.7	6	
10:15-10:30							103	1	104	1.0	1.5	5	
10:30-10:45							100	5	105	4.8	1.5	7	
10:45-11:00							89	4	93	4.3	1.4	8	
1時間計							404	11	415	2.7	6.1	26	
11:00-11:15							109	2	111	1.8	1.6	5	
11:15-11:30							109	3	112	2.7	1.6	14	
11:30-11:45							108	3	111	2.7	1.6	8	
11:45-12:00							94	5	99	5.1	1.5	3	
1時間計							420	13	433	3.0	6.4	30	
12:00-12:15							91	6	97	6.2	1.4	5	
12:15-12:30							116	1	117	0.9	1.7	7	
12:30-12:45							109	4	113	3.5	1.7	9	
12:45-13:00							124	3	127	2.4	1.9	4	
1時間計							440	14	454	3.1	6.7	25	
13:00-13:15							109	3	112	2.7	1.6	8	
13:15-13:30							94	2	96	2.1	1.4	7	
13:30-13:45							119	5	124	4.0	1.8	8	
13:45-14:00							79	1	80	1.3	1.2	8	
1時間計							401	11	412	2.7	6.1	31	

方向別自動車交通量調査表

調査地点 : 地域社会5

調査年月日 : 令和元年 5月11日(土) 天候:晴れ時々曇り

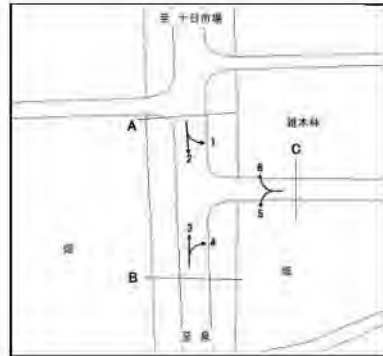

時間帯	方向 種別						B 合計 (3+4)					
		小型車 (台)	大型車 (台)	合計 (台)	大型車 混入率 (%)	時 間 係 数 (%)	二輪車 (台)	小型車 (台)	大型車 (台)	合計 (台)	大型車 混入率 (%)	時 間 係 数 (%)
14:00-14:15							108	3	111	2.7	1.6	4
14:15-14:30							113	5	118	4.2	1.7	6
14:30-14:45							112	1	113	0.9	1.7	7
14:45-15:00							96	3	99	3.0	1.5	5
1時間計							429	12	441	2.7	6.5	22
15:00-15:15							81	3	84	3.6	1.2	9
15:15-15:30							114	3	117	2.6	1.7	8
15:30-15:45							100	4	104	3.8	1.5	9
15:45-16:00							119	5	124	4.0	1.8	8
1時間計							414	15	429	3.5	6.3	34
16:00-16:15							101	1	102	1.0	1.5	9
16:15-16:30							121	2	123	1.6	1.8	7
16:30-16:45							119	3	122	2.5	1.8	11
16:45-17:00							98	5	103	4.9	1.5	11
1時間計							439	11	450	2.4	6.6	38
17:00-17:15							107	2	109	1.8	1.6	10
17:15-17:30							102	2	104	1.9	1.5	9
17:30-17:45							97	2	99	2.0	1.5	13
17:45-18:00							98	3	101	3.0	1.5	10
1時間計							404	9	413	2.2	6.1	42
18:00-18:15							83	2	85	2.4	1.3	5
18:15-18:30							98	6	104	5.8	1.5	8
18:30-18:45							87	3	90	3.3	1.3	7
18:45-19:00							78	3	81	3.7	1.2	10
1時間計							346	14	360	3.9	5.3	30
19:00-19:15							71	2	73	2.7	1.1	8
19:15-19:30							73	3	76	3.9	1.1	5
19:30-19:45							66	1	67	1.5	1.0	6
19:45-20:00							49	1	50	2.0	0.7	5
1時間計							259	7	266	2.6	3.9	24
20:00-20:15							80	7	87	8.0	1.3	6
20:15-20:30							59	2	61	3.3	0.9	6
20:30-20:45							66	0	66	0.0	1.0	2
20:45-21:00							63	1	64	1.6	0.9	3
1時間計							268	10	278	3.6	4.1	17
21:00-21:15							52	1	53	1.9	0.8	2
21:15-21:30							61	3	64	4.7	0.9	4
21:30-21:45							55	3	58	5.2	0.9	6
21:45-22:00							66	5	71	7.0	1.0	4
1時間計							234	12	246	4.9	3.6	16
昼12時間計							4833	176	5009	3.5	73.8	410
夜12時間計							1621	161	1782	9.0	26.2	143
全時間合計							6454	337	6791	5.0	100.0	553
昼 夜 率							1.34	1.91	1.36	-	-	1.35

方向別自動車交通量調査表

調査地点 : 地域社会5

調査年月日 : 令和元年 5月11日(土) 天候:晴れ時々曇り

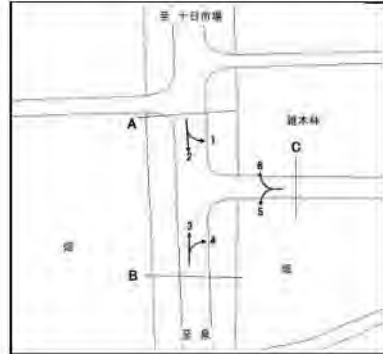

方向 種別 時間帯	5						6					
	小型車 (台)	大型車 (台)	合計 (台)	大型車 混入率 (%)	時間 係数 (%)	二輪車 (台)	小型車 (台)	大型車 (台)	合計 (台)	大型車 混入率 (%)	時間 係数 (%)	二輪車 (台)
22:00-22:15	5	0	5	0.0	0.6	0	7	0	7	0.0	0.3	0
22:15-22:30	6	0	6	0.0	0.7	0	5	1	6	16.7	0.3	0
22:30-22:45	0	0	0	0.0	0.0	1	7	1	8	12.5	0.4	1
22:45-23:00	0	0	0	0.0	0.0	0	11	1	12	8.3	0.6	2
1時間計	11	0	11	0.0	1.2	1	30	3	33	9.1	1.6	3
23:00-23:15	3	0	3	0.0	0.3	0	6	2	8	25.0	0.4	0
23:15-23:30	3	0	3	0.0	0.3	0	2	0	2	0.0	0.1	0
23:30-23:45	4	0	4	0.0	0.4	0	3	0	3	0.0	0.1	0
23:45-24:00	6	0	6	0.0	0.7	1	0	0	0	0.0	0.0	0
1時間計	16	0	16	0.0	1.8	1	11	2	13	15.4	0.6	0
0:00- 0:15	1	0	1	0.0	0.1	0	7	0	7	0.0	0.3	1
0:15- 0:30	0	0	0	0.0	0.0	0	3	0	3	0.0	0.1	1
0:30- 0:45	1	0	1	0.0	0.1	0	2	0	2	0.0	0.1	0
0:45- 1:00	1	0	1	0.0	0.1	0	3	0	3	0.0	0.1	0
1時間計	3	0	3	0.0	0.3	0	15	0	15	0.0	0.7	2
1:00- 1:15	0	0	0	0.0	0.0	0	2	0	2	0.0	0.1	0
1:15- 1:30	1	0	1	0.0	0.1	0	0	0	0	0.0	0.0	0
1:30- 1:45	0	0	0	0.0	0.0	0	2	1	3	33.3	0.1	1
1:45- 2:00	1	0	1	0.0	0.1	0	5	1	6	16.7	0.3	0
1時間計	2	0	2	0.0	0.2	0	9	2	11	18.2	0.5	1
2:00- 2:15	1	0	1	0.0	0.1	0	2	1	3	33.3	0.1	0
2:15- 2:30	0	0	0	0.0	0.0	0	1	0	1	0.0	0.0	0
2:30- 2:45	0	0	0	0.0	0.0	0	2	1	3	33.3	0.1	0
2:45- 3:00	0	0	0	0.0	0.0	0	0	0	0	0.0	0.0	0
1時間計	1	0	1	0.0	0.1	0	5	2	7	28.6	0.3	0
3:00- 3:15	1	0	1	0.0	0.1	0	2	0	2	0.0	0.1	0
3:15- 3:30	1	1	2	50.0	0.2	0	1	0	1	0.0	0.0	0
3:30- 3:45	0	0	0	0.0	0.0	1	2	1	3	33.3	0.1	0
3:45- 4:00	0	0	0	0.0	0.0	0	2	2	4	50.0	0.2	0
1時間計	2	1	3	33.3	0.3	1	7	3	10	30.0	0.5	0
4:00- 4:15	1	0	1	0.0	0.1	0	0	0	0	0.0	0.0	1
4:15- 4:30	1	0	1	0.0	0.1	0	1	0	1	0.0	0.0	0
4:30- 4:45	1	0	1	0.0	0.1	0	2	0	2	0.0	0.1	0
4:45- 5:00	0	0	0	0.0	0.0	0	5	0	5	0.0	0.2	1
1時間計	3	0	3	0.0	0.3	0	8	0	8	0.0	0.4	2
5:00- 5:15	2	0	2	0.0	0.2	0	7	0	7	0.0	0.3	0
5:15- 5:30	2	1	3	33.3	0.3	0	4	1	5	20.0	0.2	1
5:30- 5:45	2	0	2	0.0	0.2	1	5	1	6	16.7	0.3	1
5:45- 6:00	2	0	2	0.0	0.2	0	3	0	3	0.0	0.1	0
1時間計	8	1	9	11.1	1.0	1	19	2	21	9.5	1.0	2

方向別自動車交通量調査表

調査地点 : 地域社会5

調査年月日 : 令和元年 5月11日(土) 天候:晴れ時々曇り

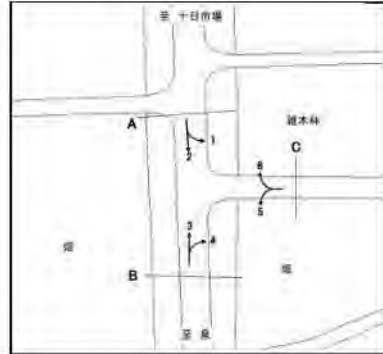

方向 種別 時間帯	5						6					
	小型車 (台)	大型車 (台)	合計 (台)	大型車 混入率 (%)	時間 係数 (%)	二輪車 (台)	小型車 (台)	大型車 (台)	合計 (台)	大型車 混入率 (%)	時間 係数 (%)	二輪車 (台)
6:00-6:15	1	0	1	0.0	0.1	0	11	0	11	0.0	0.5	2
6:15-6:30	2	0	2	0.0	0.2	0	8	0	8	0.0	0.4	1
6:30-6:45	5	0	5	0.0	0.6	0	15	1	16	6.3	0.8	2
6:45-7:00	5	0	5	0.0	0.6	2	9	0	9	0.0	0.4	0
1時間計	13	0	13	0.0	1.4	2	43	1	44	2.3	2.1	5
7:00-7:15	5	0	5	0.0	0.6	2	15	1	16	6.3	0.8	2
7:15-7:30	17	0	17	0.0	1.9	5	21	0	21	0.0	1.0	4
7:30-7:45	13	0	13	0.0	1.4	1	26	1	27	3.7	1.3	2
7:45-8:00	7	0	7	0.0	0.8	3	24	0	24	0.0	1.1	1
1時間計	42	0	42	0.0	4.7	11	86	2	88	2.3	4.2	9
8:00-8:15	11	0	11	0.0	1.2	1	31	0	31	0.0	1.5	1
8:15-8:30	11	0	11	0.0	1.2	0	19	0	19	0.0	0.9	0
8:30-8:45	9	0	9	0.0	1.0	1	21	0	21	0.0	1.0	2
8:45-9:00	11	0	11	0.0	1.2	3	36	3	39	7.7	1.9	0
1時間計	42	0	42	0.0	4.7	5	107	3	110	2.7	5.2	3
9:00-9:15	11	0	11	0.0	1.2	1	33	0	33	0.0	1.6	3
9:15-9:30	13	0	13	0.0	1.4	1	32	0	32	0.0	1.5	1
9:30-9:45	11	2	13	15.4	1.4	2	34	0	34	0.0	1.6	6
9:45-10:00	19	0	19	0.0	2.1	1	46	1	47	2.1	2.2	2
1時間計	54	2	56	3.6	6.2	5	145	1	146	0.7	6.9	12
10:00-10:15	26	1	27	3.7	3.0	5	46	0	46	0.0	2.2	1
10:15-10:30	11	0	11	0.0	1.2	1	47	0	47	0.0	2.2	5
10:30-10:45	22	0	22	0.0	2.4	0	61	0	61	0.0	2.9	4
10:45-11:00	17	0	17	0.0	1.9	0	35	1	36	2.8	1.7	2
1時間計	76	1	77	1.3	8.5	6	189	1	190	0.5	9.0	12
11:00-11:15	15	0	15	0.0	1.7	3	39	0	39	0.0	1.9	0
11:15-11:30	11	1	12	8.3	1.3	0	53	0	53	0.0	2.5	2
11:30-11:45	23	0	23	0.0	2.6	0	37	2	39	5.1	1.9	4
11:45-12:00	35	0	35	0.0	3.9	1	41	1	42	2.4	2.0	1
1時間計	84	1	85	1.2	9.4	4	170	3	173	1.7	8.2	7
12:00-12:15	23	0	23	0.0	2.6	1	39	1	40	2.5	1.9	0
12:15-12:30	22	2	24	8.3	2.7	2	35	0	35	0.0	1.7	5
12:30-12:45	16	0	16	0.0	1.8	0	41	2	43	4.7	2.0	0
12:45-13:00	6	0	6	0.0	0.7	1	73	3	76	3.9	3.6	0
1時間計	67	2	69	2.9	7.7	4	188	6	194	3.1	9.2	5
13:00-13:15	20	0	20	0.0	2.2	1	36	0	36	0.0	1.7	4
13:15-13:30	16	0	16	0.0	1.8	1	37	0	37	0.0	1.8	2
13:30-13:45	18	0	18	0.0	2.0	2	41	2	43	4.7	2.0	4
13:45-14:00	16	1	17	5.9	1.9	0	27	1	28	3.6	1.3	1
1時間計	70	1	71	1.4	7.9	4	141	3	144	2.1	6.8	11

方向別自動車交通量調査表

調査地点 : 地域社会5

調査年月日 : 令和元年 5月11日(土) 天候:晴れ時々曇り

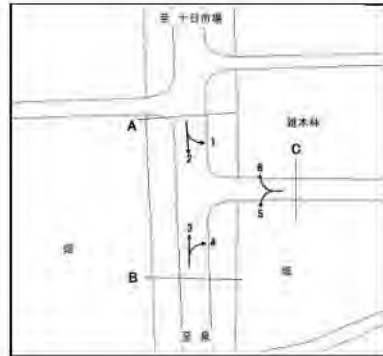

方向 種別 時間帯	5						6					
	小型車 (台)	大型車 (台)	合計 (台)	大型車 混入率 (%)	時間 係数 (%)	二輪車 (台)	小型車 (台)	大型車 (台)	合計 (台)	大型車 混入率 (%)	時間 係数 (%)	二輪車 (台)
14:00-14:15	12	0	12	0.0	1.3	1	42	2	44	4.5	2.1	0
14:15-14:30	19	0	19	0.0	2.1	2	40	0	40	0.0	1.9	3
14:30-14:45	8	0	8	0.0	0.9	0	36	0	36	0.0	1.7	3
14:45-15:00	16	0	16	0.0	1.8	0	29	0	29	0.0	1.4	1
1時間計	55	0	55	0.0	6.1	3	147	2	149	1.3	7.1	7
15:00-15:15	23	0	23	0.0	2.6	2	35	0	35	0.0	1.7	0
15:15-15:30	13	0	13	0.0	1.4	3	44	1	45	2.2	2.1	6
15:30-15:45	19	0	19	0.0	2.1	0	34	1	35	2.9	1.7	1
15:45-16:00	12	0	12	0.0	1.3	1	43	0	43	0.0	2.0	4
1時間計	67	0	67	0.0	7.4	6	156	2	158	1.3	7.5	11
16:00-16:15	18	0	18	0.0	2.0	1	33	0	33	0.0	1.6	2
16:15-16:30	12	0	12	0.0	1.3	1	28	2	30	6.7	1.4	4
16:30-16:45	14	1	15	6.7	1.7	0	52	0	52	0.0	2.5	2
16:45-17:00	24	0	24	0.0	2.7	2	50	0	50	0.0	2.4	2
1時間計	68	1	69	1.4	7.7	4	163	2	165	1.2	7.8	10
17:00-17:15	23	1	24	4.2	2.7	2	41	0	41	0.0	1.9	0
17:15-17:30	19	0	19	0.0	2.1	1	38	0	38	0.0	1.8	3
17:30-17:45	12	0	12	0.0	1.3	0	34	1	35	2.9	1.7	2
17:45-18:00	13	0	13	0.0	1.4	3	30	0	30	0.0	1.4	2
1時間計	67	1	68	1.5	7.5	6	143	1	144	0.7	6.8	7
18:00-18:15	23	0	23	0.0	2.6	1	50	0	50	0.0	2.4	4
18:15-18:30	8	0	8	0.0	0.9	4	19	0	19	0.0	0.9	1
18:30-18:45	16	0	16	0.0	1.8	2	27	0	27	0.0	1.3	2
18:45-19:00	16	0	16	0.0	1.8	1	19	0	19	0.0	0.9	1
1時間計	63	0	63	0.0	7.0	8	115	0	115	0.0	5.5	8
19:00-19:15	9	0	9	0.0	1.0	1	14	0	14	0.0	0.7	1
19:15-19:30	7	0	7	0.0	0.8	1	18	0	18	0.0	0.9	1
19:30-19:45	11	0	11	0.0	1.2	1	20	1	21	4.8	1.0	0
19:45-20:00	11	0	11	0.0	1.2	1	9	2	11	18.2	0.5	2
1時間計	38	0	38	0.0	4.2	4	61	3	64	4.7	3.0	4
20:00-20:15	7	0	7	0.0	0.8	0	15	0	15	0.0	0.7	1
20:15-20:30	2	0	2	0.0	0.2	1	9	1	10	10.0	0.5	0
20:30-20:45	3	0	3	0.0	0.3	2	7	1	8	12.5	0.4	0
20:45-21:00	8	0	8	0.0	0.9	0	15	0	15	0.0	0.7	0
1時間計	20	0	20	0.0	2.2	3	46	2	48	4.2	2.3	1
21:00-21:15	6	0	6	0.0	0.7	1	13	1	14	7.1	0.7	0
21:15-21:30	5	0	5	0.0	0.6	0	7	0	7	0.0	0.3	0
21:30-21:45	4	1	5	20.0	0.6	0	22	1	23	4.3	1.1	1
21:45-22:00	2	0	2	0.0	0.2	0	11	1	12	8.3	0.6	0
1時間計	17	1	18	5.6	2.0	1	53	3	56	5.4	2.7	1
昼12時間計	755	9	764	1.2	84.8	66	1750	26	1776	1.5	84.3	102
夜12時間計	134	3	137	2.2	15.2	14	307	23	330	7.0	15.7	21
全時間合計	889	12	901	1.3	100.0	80	2057	49	2106	2.3	100.0	123
昼夜率	1.18	1.33	1.18	-	-	1.21	1.18	1.88	1.19	-	-	1.21

方向別自動車交通量調査表

調査地点 : 地域社会5

調査年月日 : 令和元年 5月11日(土) 天候:晴れ時々曇り

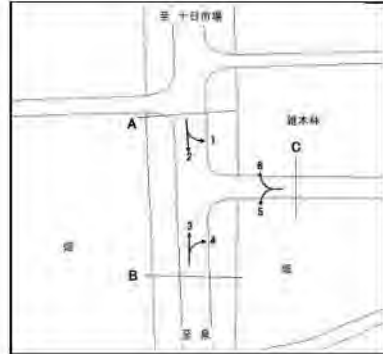

方向							C 合計 (5+ 6)					
	種別	小型車 (台)	大型車 (台)	合計 (台)	大型車 混入率 (%)	時 間 係 数 (%)	二輪車 (台)	小型車 (台)	大型車 (台)	合計 (台)	大型車 混入率 (%)	時 間 係 数 (%)
22:00-22:15							12	0	12	0.0	0.4	0
22:15-22:30							11	1	12	8.3	0.4	0
22:30-22:45							7	1	8	12.5	0.3	2
22:45-23:00							11	1	12	8.3	0.4	2
1 時間計							41	3	44	6.8	1.5	4
23:00-23:15							9	2	11	18.2	0.4	0
23:15-23:30							5	0	5	0.0	0.2	0
23:30-23:45							7	0	7	0.0	0.2	0
23:45-24:00							6	0	6	0.0	0.2	1
1 時間計							27	2	29	6.9	1.0	1
0:00- 0:15							8	0	8	0.0	0.3	1
0:15- 0:30							3	0	3	0.0	0.1	1
0:30- 0:45							3	0	3	0.0	0.1	0
0:45- 1:00							4	0	4	0.0	0.1	0
1 時間計							18	0	18	0.0	0.6	2
1:00- 1:15							2	0	2	0.0	0.1	0
1:15- 1:30							1	0	1	0.0	0.0	0
1:30- 1:45							2	1	3	33.3	0.1	1
1:45- 2:00							6	1	7	14.3	0.2	0
1 時間計							11	2	13	15.4	0.4	1
2:00- 2:15							3	1	4	25.0	0.1	0
2:15- 2:30							1	0	1	0.0	0.0	0
2:30- 2:45							2	1	3	33.3	0.1	0
2:45- 3:00							0	0	0	0.0	0.0	0
1 時間計							6	2	8	25.0	0.3	0
3:00- 3:15							3	0	3	0.0	0.1	0
3:15- 3:30							2	1	3	33.3	0.1	0
3:30- 3:45							2	1	3	33.3	0.1	1
3:45- 4:00							2	2	4	50.0	0.1	0
1 時間計							9	4	13	30.8	0.4	1
4:00- 4:15							1	0	1	0.0	0.0	1
4:15- 4:30							2	0	2	0.0	0.1	0
4:30- 4:45							3	0	3	0.0	0.1	0
4:45- 5:00							5	0	5	0.0	0.2	1
1 時間計							11	0	11	0.0	0.4	2
5:00- 5:15							9	0	9	0.0	0.3	0
5:15- 5:30							6	2	8	25.0	0.3	1
5:30- 5:45							7	1	8	12.5	0.3	2
5:45- 6:00							5	0	5	0.0	0.2	0
1 時間計							27	3	30	10.0	1.0	3

方向別自動車交通量調査表

調査地点：地域社会5

調査年月日：令和元年 5月11日(土) 天候：晴れ時々曇り

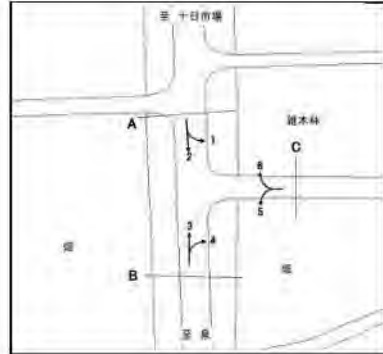

時間帯	方向 種別							C 合計 (5+6)					
		小型車 (台)	大型車 (台)	合計 (台)	大型車 混入率 (%)	時間 係数 (%)	二輪車 (台)	小型車 (台)	大型車 (台)	合計 (台)	大型車 混入率 (%)	時間 係数 (%)	二輪車 (台)
6:00-6:15							12	0	12	0.0	0.4	2	
6:15-6:30							10	0	10	0.0	0.3	1	
6:30-6:45							20	1	21	4.8	0.7	2	
6:45-7:00							14	0	14	0.0	0.5	2	
1時間計							56	1	57	1.8	1.9	7	
7:00-7:15							20	1	21	4.8	0.7	4	
7:15-7:30							38	0	38	0.0	1.3	9	
7:30-7:45							39	1	40	2.5	1.3	3	
7:45-8:00							31	0	31	0.0	1.0	4	
1時間計							128	2	130	1.5	4.3	20	
8:00-8:15							42	0	42	0.0	1.4	2	
8:15-8:30							30	0	30	0.0	1.0	0	
8:30-8:45							30	0	30	0.0	1.0	3	
8:45-9:00							47	3	50	6.0	1.7	3	
1時間計							149	3	152	2.0	5.1	8	
9:00-9:15							44	0	44	0.0	1.5	4	
9:15-9:30							45	0	45	0.0	1.5	2	
9:30-9:45							45	2	47	4.3	1.6	8	
9:45-10:00							65	1	66	1.5	2.2	3	
1時間計							199	3	202	1.5	6.7	17	
10:00-10:15							72	1	73	1.4	2.4	6	
10:15-10:30							58	0	58	0.0	1.9	6	
10:30-10:45							83	0	83	0.0	2.8	4	
10:45-11:00							52	1	53	1.9	1.8	2	
1時間計							265	2	267	0.7	8.9	18	
11:00-11:15							54	0	54	0.0	1.8	3	
11:15-11:30							64	1	65	1.5	2.2	2	
11:30-11:45							60	2	62	3.2	2.1	4	
11:45-12:00							76	1	77	1.3	2.6	2	
1時間計							254	4	258	1.6	8.6	11	
12:00-12:15							62	1	63	1.6	2.1	1	
12:15-12:30							57	2	59	3.4	2.0	7	
12:30-12:45							57	2	59	3.4	2.0	0	
12:45-13:00							79	3	82	3.7	2.7	1	
1時間計							255	8	263	3.0	8.7	9	
13:00-13:15							56	0	56	0.0	1.9	5	
13:15-13:30							53	0	53	0.0	1.8	3	
13:30-13:45							59	2	61	3.3	2.0	6	
13:45-14:00							43	2	45	4.4	1.5	1	
1時間計							211	4	215	1.9	7.1	15	

方向別自動車交通量調査表

調査地点：地域社会5

調査年月日：令和元年 5月11日(土) 天候：晴れ時々曇り

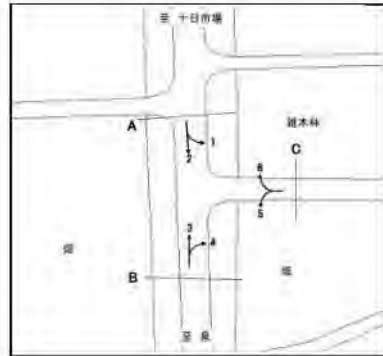

方向 種別 時間帯							C 合計 (5+ 6)					
	小型車 (台)	大型車 (台)	合計 (台)	大型車 混入率 (%)	時間 係数 (%)	二輪車 (台)	小型車 (台)	大型車 (台)	合計 (台)	大型車 混入率 (%)	時間 係数 (%)	二輪車 (台)
14:00-14:15							54	2	56	3.6	1.9	1
14:15-14:30							59	0	59	0.0	2.0	5
14:30-14:45							44	0	44	0.0	1.5	3
14:45-15:00							45	0	45	0.0	1.5	1
1時間計							202	2	204	1.0	6.8	10
15:00-15:15							58	0	58	0.0	1.9	2
15:15-15:30							57	1	58	1.7	1.9	9
15:30-15:45							53	1	54	1.9	1.8	1
15:45-16:00							55	0	55	0.0	1.8	5
1時間計							223	2	225	0.9	7.5	17
16:00-16:15							51	0	51	0.0	1.7	3
16:15-16:30							40	2	42	4.8	1.4	5
16:30-16:45							66	1	67	1.5	2.2	2
16:45-17:00							74	0	74	0.0	2.5	4
1時間計							231	3	234	1.3	7.8	14
17:00-17:15							64	1	65	1.5	2.2	2
17:15-17:30							57	0	57	0.0	1.9	4
17:30-17:45							46	1	47	2.1	1.6	2
17:45-18:00							43	0	43	0.0	1.4	5
1時間計							210	2	212	0.9	7.1	13
18:00-18:15							73	0	73	0.0	2.4	5
18:15-18:30							27	0	27	0.0	0.9	5
18:30-18:45							43	0	43	0.0	1.4	4
18:45-19:00							35	0	35	0.0	1.2	2
1時間計							178	0	178	0.0	5.9	16
19:00-19:15							23	0	23	0.0	0.8	2
19:15-19:30							25	0	25	0.0	0.8	2
19:30-19:45							31	1	32	3.1	1.1	1
19:45-20:00							20	2	22	9.1	0.7	3
1時間計							99	3	102	2.9	3.4	8
20:00-20:15							22	0	22	0.0	0.7	1
20:15-20:30							11	1	12	8.3	0.4	1
20:30-20:45							10	1	11	9.1	0.4	2
20:45-21:00							23	0	23	0.0	0.8	0
1時間計							66	2	68	2.9	2.3	4
21:00-21:15							19	1	20	5.0	0.7	1
21:15-21:30							12	0	12	0.0	0.4	0
21:30-21:45							26	2	28	7.1	0.9	1
21:45-22:00							13	1	14	7.1	0.5	0
1時間計							70	4	74	5.4	2.5	2
昼12時間計							2505	35	2540	1.4	84.5	168
夜12時間計							441	26	467	5.6	15.5	35
全時間合計							2946	61	3007	2.0	100.0	203
昼夜率							1.18	1.74	1.18	-	-	1.21

方向別自動車交通量調査表

調査地点 : 地域社会6 瀬谷中学校前

調査年月日 : 令和元年 5月11日(土) 天候:晴れ時々曇り



方向 種別 時間帯	1						2					
	小型車 (台)	大型車 (台)	合計 (台)	大型車 混入率 (%)	時間 係数 (%)	二輪車 (台)	小型車 (台)	大型車 (台)	合計 (台)	大型車 混入率 (%)	時間 係数 (%)	二輪車 (台)
22:00-22:15	23	2	25	8.0	1.8	0	39	4	43	9.3	0.9	2
22:15-22:30	20	0	20	0.0	1.5	1	45	7	52	13.5	1.1	4
22:30-22:45	11	0	11	0.0	0.8	1	36	3	39	7.7	0.8	6
22:45-23:00	7	0	7	0.0	0.5	1	30	4	34	11.8	0.7	2
1時間計	61	2	63	3.2	4.6	3	150	18	168	10.7	3.5	14
23:00-23:15	10	2	12	16.7	0.9	0	36	4	40	10.0	0.8	5
23:15-23:30	4	0	4	0.0	0.3	1	42	1	43	2.3	0.9	4
23:30-23:45	7	0	7	0.0	0.5	0	22	1	23	4.3	0.5	4
23:45-24:00	8	0	8	0.0	0.6	1	30	3	33	9.1	0.7	4
1時間計	29	2	31	6.5	2.3	2	130	9	139	6.5	2.9	17
0:00-0:15	12	0	12	0.0	0.9	1	14	1	15	6.7	0.3	0
0:15-0:30	5	1	6	16.7	0.4	0	13	5	18	27.8	0.4	1
0:30-0:45	3	1	4	25.0	0.3	1	16	2	18	11.1	0.4	1
0:45-1:00	9	3	12	25.0	0.9	1	15	2	17	11.8	0.4	0
1時間計	29	5	34	14.7	2.5	3	58	10	68	14.7	1.4	2
1:00-1:15	3	0	3	0.0	0.2	0	21	4	25	16.0	0.5	2
1:15-1:30	2	0	2	0.0	0.1	0	6	2	8	25.0	0.2	0
1:30-1:45	1	0	1	0.0	0.1	0	12	2	14	14.3	0.3	0
1:45-2:00	3	0	3	0.0	0.2	1	6	2	8	25.0	0.2	1
1時間計	9	0	9	0.0	0.7	1	45	10	55	18.2	1.1	3
2:00-2:15	1	0	1	0.0	0.1	0	9	1	10	10.0	0.2	0
2:15-2:30	1	0	1	0.0	0.1	0	7	2	9	22.2	0.2	4
2:30-2:45	1	1	2	50.0	0.1	0	14	4	18	22.2	0.4	1
2:45-3:00	2	0	2	0.0	0.1	0	12	0	12	0.0	0.2	0
1時間計	5	1	6	16.7	0.4	0	42	7	49	14.3	1.0	5
3:00-3:15	0	0	0	0.0	0.0	0	11	0	11	0.0	0.2	2
3:15-3:30	3	0	3	0.0	0.2	0	7	1	8	12.5	0.2	2
3:30-3:45	3	2	5	40.0	0.4	0	4	2	6	33.3	0.1	1
3:45-4:00	1	0	1	0.0	0.1	0	8	1	9	11.1	0.2	1
1時間計	7	2	9	22.2	0.7	0	30	4	34	11.8	0.7	6
4:00-4:15	1	2	3	66.7	0.2	0	10	3	13	23.1	0.3	0
4:15-4:30	2	0	2	0.0	0.1	0	12	8	20	40.0	0.4	0
4:30-4:45	2	0	2	0.0	0.1	0	9	4	13	30.8	0.3	2
4:45-5:00	2	1	3	33.3	0.2	0	7	3	10	30.0	0.2	1
1時間計	7	3	10	30.0	0.7	0	38	18	56	32.1	1.2	3
5:00-5:15	2	0	2	0.0	0.1	2	10	3	13	23.1	0.3	5
5:15-5:30	4	0	4	0.0	0.3	0	12	3	15	20.0	0.3	1
5:30-5:45	4	1	5	20.0	0.4	0	15	6	21	28.6	0.4	1
5:45-6:00	5	0	5	0.0	0.4	0	13	4	17	23.5	0.4	0
1時間計	15	1	16	6.3	1.2	2	50	16	66	24.2	1.4	7

方向別自動車交通量調査表

調査地点 : 地域社会6 瀬谷中学校前

調査年月日 : 令和元年 5月11日(土) 天候:晴れ時々曇り



方向 時間帯	1						2					
	種別 小型車 (台)	大型車 (台)	合計 (台)	大型車 混入率 (%)	時間 係数 (%)	二輪車 (台)	小型車 (台)	大型車 (台)	合計 (台)	大型車 混入率 (%)	時間 係数 (%)	二輪車 (台)
6:00-6:15	1	0	1	0.0	0.1	0	18	3	21	14.3	0.4	2
6:15-6:30	10	1	11	9.1	0.8	0	22	5	27	18.5	0.6	3
6:30-6:45	5	2	7	28.6	0.5	0	18	6	24	25.0	0.5	2
6:45-7:00	9	2	11	18.2	0.8	0	29	3	32	9.4	0.7	2
1時間計	25	5	30	16.7	2.2	0	87	17	104	16.3	2.2	9
7:00-7:15	8	0	8	0.0	0.6	0	35	3	38	7.9	0.8	3
7:15-7:30	9	1	10	10.0	0.7	1	59	4	63	6.3	1.3	5
7:30-7:45	5	0	5	0.0	0.4	0	45	2	47	4.3	1.0	7
7:45-8:00	14	0	14	0.0	1.0	1	50	1	51	2.0	1.1	3
1時間計	36	1	37	2.7	2.7	2	189	10	199	5.0	4.1	18
8:00-8:15	14	5	19	26.3	1.4	0	58	6	64	9.4	1.3	2
8:15-8:30	13	0	13	0.0	0.9	1	58	1	59	1.7	1.2	6
8:30-8:45	17	0	17	0.0	1.2	0	39	2	41	4.9	0.8	5
8:45-9:00	17	2	19	10.5	1.4	1	45	0	45	0.0	0.9	4
1時間計	61	7	68	10.3	4.9	2	200	9	209	4.3	4.3	17
9:00-9:15	13	2	15	13.3	1.1	1	63	2	65	3.1	1.3	10
9:15-9:30	12	1	13	7.7	0.9	0	66	4	70	5.7	1.4	10
9:30-9:45	23	1	24	4.2	1.7	0	56	3	59	5.1	1.2	8
9:45-10:00	18	2	20	10.0	1.5	2	65	1	66	1.5	1.4	4
1時間計	66	6	72	8.3	5.2	3	250	10	260	3.8	5.4	32
10:00-10:15	20	1	21	4.8	1.5	2	63	4	67	6.0	1.4	6
10:15-10:30	19	0	19	0.0	1.4	0	70	5	75	6.7	1.6	6
10:30-10:45	19	0	19	0.0	1.4	2	65	1	66	1.5	1.4	2
10:45-11:00	28	0	28	0.0	2.0	1	86	7	93	7.5	1.9	8
1時間計	86	1	87	1.1	6.3	5	284	17	301	5.6	6.2	22
11:00-11:15	18	1	19	5.3	1.4	2	63	2	65	3.1	1.3	4
11:15-11:30	32	0	32	0.0	2.3	1	91	1	92	1.1	1.9	14
11:30-11:45	25	1	26	3.8	1.9	1	78	2	80	2.5	1.7	8
11:45-12:00	26	0	26	0.0	1.9	1	86	2	88	2.3	1.8	5
1時間計	101	2	103	1.9	7.5	5	318	7	325	2.2	6.7	31
12:00-12:15	21	0	21	0.0	1.5	2	50	1	51	2.0	1.1	7
12:15-12:30	18	0	18	0.0	1.3	1	79	3	82	3.7	1.7	4
12:30-12:45	18	0	18	0.0	1.3	0	52	0	52	0.0	1.1	8
12:45-13:00	11	0	11	0.0	0.8	0	66	1	67	1.5	1.4	1
1時間計	68	0	68	0.0	4.9	3	247	5	252	2.0	5.2	20
13:00-13:15	21	0	21	0.0	1.5	1	68	2	70	2.9	1.4	5
13:15-13:30	19	0	19	0.0	1.4	2	55	2	57	3.5	1.2	5
13:30-13:45	25	1	26	3.8	1.9	1	91	4	95	4.2	2.0	7
13:45-14:00	23	0	23	0.0	1.7	1	78	4	82	4.9	1.7	5
1時間計	88	1	89	1.1	6.5	5	292	12	304	3.9	6.3	22

方向別自動車交通量調査表

調査地点 : 地域社会6 瀬谷中学校前

調査年月日 : 令和元年 5月11日(土) 天候:晴れ時々曇り



方向 種別 時間帯	1						2					
	小型車 (台)	大型車 (台)	合計 (台)	大型車 混入率 (%)	時間 係数 (%)	二輪車 (台)	小型車 (台)	大型車 (台)	合計 (台)	大型車 混入率 (%)	時間 係数 (%)	二輪車 (台)
14:00-14:15	27	0	27	0.0	2.0	1	67	5	72	6.9	1.5	5
14:15-14:30	16	1	17	5.9	1.2	1	67	3	70	4.3	1.4	4
14:30-14:45	18	0	18	0.0	1.3	1	84	2	86	2.3	1.8	10
14:45-15:00	29	0	29	0.0	2.1	0	72	2	74	2.7	1.5	2
1時間計	90	1	91	1.1	6.6	3	290	12	302	4.0	6.2	21
15:00-15:15	28	0	28	0.0	2.0	0	72	1	73	1.4	1.5	6
15:15-15:30	29	0	29	0.0	2.1	1	81	4	85	4.7	1.8	11
15:30-15:45	15	0	15	0.0	1.1	1	85	3	88	3.4	1.8	6
15:45-16:00	10	0	10	0.0	0.7	1	76	1	77	1.3	1.6	6
1時間計	82	0	82	0.0	6.0	3	314	9	323	2.8	6.7	29
16:00-16:15	24	0	24	0.0	1.7	0	70	1	71	1.4	1.5	6
16:15-16:30	32	1	33	3.0	2.4	0	64	3	67	4.5	1.4	11
16:30-16:45	19	0	19	0.0	1.4	1	73	3	76	3.9	1.6	2
16:45-17:00	31	0	31	0.0	2.3	2	82	3	85	3.5	1.8	8
1時間計	106	1	107	0.9	7.8	3	289	10	299	3.3	6.2	27
17:00-17:15	26	0	26	0.0	1.9	2	81	0	81	0.0	1.7	7
17:15-17:30	19	0	19	0.0	1.4	0	88	1	89	1.1	1.8	1
17:30-17:45	15	0	15	0.0	1.1	0	87	2	89	2.2	1.8	6
17:45-18:00	27	2	29	6.9	2.1	1	79	1	80	1.3	1.7	10
1時間計	87	2	89	2.2	6.5	3	335	4	339	1.2	7.0	24
18:00-18:15	38	0	38	0.0	2.8	2	80	1	81	1.2	1.7	4
18:15-18:30	21	1	22	4.5	1.6	3	78	2	80	2.5	1.7	11
18:30-18:45	18	2	20	10.0	1.5	0	59	1	60	1.7	1.2	4
18:45-19:00	21	0	21	0.0	1.5	0	94	0	94	0.0	1.9	8
1時間計	98	3	101	3.0	7.3	5	311	4	315	1.3	6.5	27
19:00-19:15	19	0	19	0.0	1.4	0	60	1	61	1.6	1.3	5
19:15-19:30	21	2	23	8.7	1.7	1	58	1	59	1.7	1.2	6
19:30-19:45	22	0	22	0.0	1.6	1	73	1	74	1.4	1.5	6
19:45-20:00	21	0	21	0.0	1.5	1	51	0	51	0.0	1.1	3
1時間計	83	2	85	2.4	6.2	3	242	3	245	1.2	5.1	20
20:00-20:15	17	0	17	0.0	1.2	1	55	4	59	6.8	1.2	8
20:15-20:30	10	0	10	0.0	0.7	1	58	1	59	1.7	1.2	5
20:30-20:45	9	0	9	0.0	0.7	0	55	0	55	0.0	1.1	3
20:45-21:00	15	0	15	0.0	1.1	0	52	1	53	1.9	1.1	2
1時間計	51	0	51	0.0	3.7	2	220	6	226	2.7	4.7	18
21:00-21:15	15	1	16	6.3	1.2	1	54	2	56	3.6	1.2	4
21:15-21:30	9	2	11	18.2	0.8	1	47	1	48	2.1	1.0	0
21:30-21:45	5	0	5	0.0	0.4	0	46	3	49	6.1	1.0	3
21:45-22:00	5	0	5	0.0	0.4	0	42	1	43	2.3	0.9	4
1時間計	34	3	37	8.1	2.7	2	189	7	196	3.6	4.1	11
昼12時間計	969	25	994	2.5	72.3	42	3319	109	3428	3.2	70.9	290
夜12時間計	355	26	381	6.8	27.7	18	1281	125	1406	8.9	29.1	115
全時間合計	1324	51	1375	3.7	100.0	60	4600	234	4834	4.8	100.0	405
昼夜率	1.37	2.04	1.38	-	-	1.43	1.39	2.15	1.41	-	-	1.40

方向別自動車交通量調査表

調査地点：地域社会6 瀬谷中学校前

調査年月日：令和元年 5月11日(土) 天候：晴れ時々曇り



方向 種別 時間帯	3						A 合計 (1+ 2+ 3)					
	小型車 (台)	大型車 (台)	合計 (台)	大型車 混入率 (%)	時間 係数 (%)	二輪車 (台)	小型車 (台)	大型車 (台)	合計 (台)	大型車 混入率 (%)	時間 係数 (%)	二輪車 (台)
22:00-22:15	6	0	6	0.0	1.4	0	68	6	74	8.1	1.1	2
22:15-22:30	3	0	3	0.0	0.7	0	68	7	75	9.3	1.1	5
22:30-22:45	2	0	2	0.0	0.5	0	49	3	52	5.8	0.8	7
22:45-23:00	2	0	2	0.0	0.5	0	39	4	43	9.3	0.6	3
1時間計	13	0	13	0.0	3.1	0	224	20	244	8.2	3.7	17
23:00-23:15	2	0	2	0.0	0.5	0	48	6	54	11.1	0.8	5
23:15-23:30	0	0	0	0.0	0.0	1	46	1	47	2.1	0.7	6
23:30-23:45	2	0	2	0.0	0.5	0	31	1	32	3.1	0.5	4
23:45-24:00	2	0	2	0.0	0.5	1	40	3	43	7.0	0.6	6
1時間計	6	0	6	0.0	1.4	2	165	11	176	6.3	2.7	21
0:00- 0:15	0	0	0	0.0	0.0	0	26	1	27	3.7	0.4	1
0:15- 0:30	0	0	0	0.0	0.0	0	18	6	24	25.0	0.4	1
0:30- 0:45	1	0	1	0.0	0.2	1	20	3	23	13.0	0.3	3
0:45- 1:00	5	0	5	0.0	1.2	0	29	5	34	14.7	0.5	1
1時間計	6	0	6	0.0	1.4	1	93	15	108	13.9	1.6	6
1:00- 1:15	1	0	1	0.0	0.2	0	25	4	29	13.8	0.4	2
1:15- 1:30	2	0	2	0.0	0.5	0	10	2	12	16.7	0.2	0
1:30- 1:45	2	0	2	0.0	0.5	0	15	2	17	11.8	0.3	0
1:45- 2:00	0	0	0	0.0	0.0	1	9	2	11	18.2	0.2	3
1時間計	5	0	5	0.0	1.2	1	59	10	69	14.5	1.0	5
2:00- 2:15	1	0	1	0.0	0.2	0	11	1	12	8.3	0.2	0
2:15- 2:30	0	0	0	0.0	0.0	0	8	2	10	20.0	0.2	4
2:30- 2:45	1	0	1	0.0	0.2	0	16	5	21	23.8	0.3	1
2:45- 3:00	1	0	1	0.0	0.2	0	15	0	15	0.0	0.2	0
1時間計	3	0	3	0.0	0.7	0	50	8	58	13.8	0.9	5
3:00- 3:15	1	0	1	0.0	0.2	0	12	0	12	0.0	0.2	2
3:15- 3:30	0	0	0	0.0	0.0	0	10	1	11	9.1	0.2	2
3:30- 3:45	0	0	0	0.0	0.0	0	7	4	11	36.4	0.2	1
3:45- 4:00	0	0	0	0.0	0.0	0	9	1	10	10.0	0.2	1
1時間計	1	0	1	0.0	0.2	0	38	6	44	13.6	0.7	6
4:00- 4:15	0	0	0	0.0	0.0	0	11	5	16	31.3	0.2	0
4:15- 4:30	1	0	1	0.0	0.2	1	15	8	23	34.8	0.3	1
4:30- 4:45	1	0	1	0.0	0.2	0	12	4	16	25.0	0.2	2
4:45- 5:00	1	0	1	0.0	0.2	0	10	4	14	28.6	0.2	1
1時間計	3	0	3	0.0	0.7	1	48	21	69	30.4	1.0	4
5:00- 5:15	1	0	1	0.0	0.2	0	13	3	16	18.8	0.2	7
5:15- 5:30	1	0	1	0.0	0.2	0	17	3	20	15.0	0.3	1
5:30- 5:45	0	0	0	0.0	0.0	0	19	7	26	26.9	0.4	1
5:45- 6:00	0	0	0	0.0	0.0	0	18	4	22	18.2	0.3	0
1時間計	2	0	2	0.0	0.5	0	67	17	84	20.2	1.3	9

方向別自動車交通量調査表

調査地点：地域社会6 瀬谷中学校前

調査年月日：令和元年 5月11日(土) 天候：晴れ時々曇り



方向	3						A 合計 (1+ 3)						
	種別	小型車 (台)	大型車 (台)	合計 (台)	大型車 混入率 (%)	時係 数 (%)	二輪車 (台)	小型車 (台)	大型車 (台)	合計 (台)	大型車 混入率 (%)	時係 数 (%)	二輪車 (台)
6:00-6:15		1	0	1	0.0	0.2	0	20	3	23	13.0	0.3	2
6:15-6:30		1	0	1	0.0	0.2	1	33	6	39	15.4	0.6	4
6:30-6:45		0	0	0	0.0	0.0	0	23	8	31	25.8	0.5	2
6:45-7:00		3	0	3	0.0	0.7	0	41	5	46	10.9	0.7	2
1時間計		5	0	5	0.0	1.2	1	117	22	139	15.8	2.1	10
7:00-7:15		1	0	1	0.0	0.2	0	44	3	47	6.4	0.7	3
7:15-7:30		0	0	0	0.0	0.0	0	68	5	73	6.8	1.1	6
7:30-7:45		3	0	3	0.0	0.7	0	53	2	55	3.6	0.8	7
7:45-8:00		0	0	0	0.0	0.0	0	64	1	65	1.5	1.0	4
1時間計		4	0	4	0.0	0.9	0	229	11	240	4.6	3.6	20
8:00-8:15		1	0	1	0.0	0.2	0	73	11	84	13.1	1.3	2
8:15-8:30		2	0	2	0.0	0.5	0	73	1	74	1.4	1.1	7
8:30-8:45		0	0	0	0.0	0.0	0	56	2	58	3.4	0.9	5
8:45-9:00		10	0	10	0.0	2.4	3	72	2	74	2.7	1.1	8
1時間計		13	0	13	0.0	3.1	3	274	16	290	5.5	4.4	22
9:00-9:15		6	0	6	0.0	1.4	0	82	4	86	4.7	1.3	11
9:15-9:30		3	0	3	0.0	0.7	0	81	5	86	5.8	1.3	10
9:30-9:45		5	0	5	0.0	1.2	0	84	4	88	4.5	1.3	8
9:45-10:00		3	0	3	0.0	0.7	1	86	3	89	3.4	1.3	7
1時間計		17	0	17	0.0	4.0	1	333	16	349	4.6	5.3	36
10:00-10:15		15	0	15	0.0	3.5	0	98	5	103	4.9	1.6	8
10:15-10:30		11	1	12	8.3	2.8	0	100	6	106	5.7	1.6	6
10:30-10:45		6	0	6	0.0	1.4	1	90	1	91	1.1	1.4	5
10:45-11:00		4	0	4	0.0	0.9	0	118	7	125	5.6	1.9	9
1時間計		36	1	37	2.7	8.7	1	406	19	425	4.5	6.4	28
11:00-11:15		8	0	8	0.0	1.9	2	89	3	92	3.3	1.4	8
11:15-11:30		6	0	6	0.0	1.4	1	129	1	130	0.8	2.0	16
11:30-11:45		8	0	8	0.0	1.9	0	111	3	114	2.6	1.7	9
11:45-12:00		12	0	12	0.0	2.8	0	124	2	126	1.6	1.9	6
1時間計		34	0	34	0.0	8.0	3	453	9	462	1.9	7.0	39
12:00-12:15		7	1	8	12.5	1.9	1	78	2	80	2.5	1.2	10
12:15-12:30		13	0	13	0.0	3.1	0	110	3	113	2.7	1.7	5
12:30-12:45		7	0	7	0.0	1.7	0	77	0	77	0.0	1.2	8
12:45-13:00		9	1	10	10.0	2.4	0	86	2	88	2.3	1.3	1
1時間計		36	2	38	5.3	9.0	1	351	7	358	2.0	5.4	24
13:00-13:15		6	0	6	0.0	1.4	0	95	2	97	2.1	1.5	6
13:15-13:30		8	0	8	0.0	1.9	0	82	2	84	2.4	1.3	7
13:30-13:45		6	1	7	14.3	1.7	1	122	6	128	4.7	1.9	9
13:45-14:00		3	0	3	0.0	0.7	2	104	4	108	3.7	1.6	8
1時間計		23	1	24	4.2	5.7	3	403	14	417	3.4	6.3	30

方向別自動車交通量調査表

調査地点：地域社会6 瀬谷中学校前

調査年月日：令和元年 5月11日(土) 天候：晴れ時々曇り



方向 種別 時間帯	3						A 合計 (1+ 2+ 3)					
	小型車 (台)	大型車 (台)	合計 (台)	大型車 混入率 (%)	時係 数 (%)	二輪車 (台)	小型車 (台)	大型車 (台)	合計 (台)	大型車 混入率 (%)	時係 数 (%)	二輪車 (台)
14:00-14:15	6	0	6	0.0	1.4	1	100	5	105	4.8	1.6	7
14:15-14:30	4	0	4	0.0	0.9	0	87	4	91	4.4	1.4	5
14:30-14:45	10	0	10	0.0	2.4	3	112	2	114	1.8	1.7	14
14:45-15:00	6	0	6	0.0	1.4	0	107	2	109	1.8	1.6	2
1時間計	26	0	26	0.0	6.1	4	406	13	419	3.1	6.3	28
15:00-15:15	7	0	7	0.0	1.7	0	107	1	108	0.9	1.6	6
15:15-15:30	4	0	4	0.0	0.9	0	114	4	118	3.4	1.8	12
15:30-15:45	1	2	3	66.7	0.7	0	101	5	106	4.7	1.6	7
15:45-16:00	2	0	2	0.0	0.5	0	88	1	89	1.1	1.3	7
1時間計	14	2	16	12.5	3.8	0	410	11	421	2.6	6.3	32
16:00-16:15	8	0	8	0.0	1.9	0	102	1	103	1.0	1.6	6
16:15-16:30	14	0	14	0.0	3.3	2	110	4	114	3.5	1.7	13
16:30-16:45	6	0	6	0.0	1.4	0	98	3	101	3.0	1.5	3
16:45-17:00	10	0	10	0.0	2.4	0	123	3	126	2.4	1.9	10
1時間計	38	0	38	0.0	9.0	2	433	11	444	2.5	6.7	32
17:00-17:15	10	0	10	0.0	2.4	1	117	0	117	0.0	1.8	10
17:15-17:30	6	0	6	0.0	1.4	0	113	1	114	0.9	1.7	1
17:30-17:45	8	0	8	0.0	1.9	1	110	2	112	1.8	1.7	7
17:45-18:00	8	0	8	0.0	1.9	0	114	3	117	2.6	1.8	11
1時間計	32	0	32	0.0	7.6	2	454	6	460	1.3	6.9	29
18:00-18:15	10	0	10	0.0	2.4	0	128	1	129	0.8	1.9	6
18:15-18:30	10	0	10	0.0	2.4	0	109	3	112	2.7	1.7	14
18:30-18:45	4	0	4	0.0	0.9	0	81	3	84	3.6	1.3	4
18:45-19:00	11	0	11	0.0	2.6	0	126	0	126	0.0	1.9	8
1時間計	35	0	35	0.0	8.3	0	444	7	451	1.6	6.8	32
19:00-19:15	3	0	3	0.0	0.7	0	82	1	83	1.2	1.3	5
19:15-19:30	5	0	5	0.0	1.2	0	84	3	87	3.4	1.3	7
19:30-19:45	10	1	11	9.1	2.6	0	105	2	107	1.9	1.6	7
19:45-20:00	4	0	4	0.0	0.9	0	76	0	76	0.0	1.1	4
1時間計	22	1	23	4.3	5.4	0	347	6	353	1.7	5.3	23
20:00-20:15	4	0	4	0.0	0.9	0	76	4	80	5.0	1.2	9
20:15-20:30	1	0	1	0.0	0.2	0	69	1	70	1.4	1.1	6
20:30-20:45	9	0	9	0.0	2.1	0	73	0	73	0.0	1.1	3
20:45-21:00	1	0	1	0.0	0.2	2	68	1	69	1.4	1.0	4
1時間計	15	0	15	0.0	3.5	2	286	6	292	2.1	4.4	22
21:00-21:15	5	0	5	0.0	1.2	0	74	3	77	3.9	1.2	5
21:15-21:30	5	0	5	0.0	1.2	0	61	3	64	4.7	1.0	1
21:30-21:45	12	1	13	7.7	3.1	1	63	4	67	6.0	1.0	4
21:45-22:00	4	0	4	0.0	0.9	0	51	1	52	1.9	0.8	4
1時間計	26	1	27	3.7	6.4	1	249	11	260	4.2	3.9	14
昼12時間計	308	6	314	1.9	74.2	20	4596	140	4736	3.0	71.4	352
夜12時間計	107	2	109	1.8	25.8	9	1743	153	1896	8.1	28.6	142
全時間合計	415	8	423	1.9	100.0	29	6339	293	6632	4.4	100.0	494
昼夜率	1.35	1.33	1.35	-	-	1.45	1.38	2.09	1.40	-	-	1.40

方向別自動車交通量調査表

調査地点：地域社会6 瀬谷中学校前

調査年月日：令和元年 5月11日(土) 天候：晴れ時々曇り



方向 種別 時間帯	4						5					
	小型車 (台)	大型車 (台)	合計 (台)	大型車 混入率 (%)	時間 係数 (%)	二輪車 (台)	小型車 (台)	大型車 (台)	合計 (台)	大型車 混入率 (%)	時間 係数 (%)	二輪車 (台)
22:00-22:15	1	0	1	0.0	0.3	0	35	1	36	2.8	1.2	3
22:15-22:30	1	0	1	0.0	0.3	0	30	0	30	0.0	1.0	2
22:30-22:45	3	0	3	0.0	0.9	0	22	0	22	0.0	0.7	2
22:45-23:00	1	0	1	0.0	0.3	0	31	0	31	0.0	1.0	1
1時間計	6	0	6	0.0	1.8	0	118	1	119	0.8	4.0	8
23:00-23:15	1	0	1	0.0	0.3	0	15	0	15	0.0	0.5	0
23:15-23:30	2	0	2	0.0	0.6	0	16	0	16	0.0	0.5	0
23:30-23:45	0	0	0	0.0	0.0	0	10	0	10	0.0	0.3	2
23:45-24:00	0	0	0	0.0	0.0	0	14	0	14	0.0	0.5	1
1時間計	3	0	3	0.0	0.9	0	55	0	55	0.0	1.8	3
0:00-0:15	0	0	0	0.0	0.0	0	10	0	10	0.0	0.3	1
0:15-0:30	0	0	0	0.0	0.0	0	10	0	10	0.0	0.3	0
0:30-0:45	0	0	0	0.0	0.0	0	17	0	17	0.0	0.6	0
0:45-1:00	1	0	1	0.0	0.3	0	12	0	12	0.0	0.4	1
1時間計	1	0	1	0.0	0.3	0	49	0	49	0.0	1.6	2
1:00-1:15	1	0	1	0.0	0.3	0	6	0	6	0.0	0.2	1
1:15-1:30	0	0	0	0.0	0.0	1	3	0	3	0.0	0.1	0
1:30-1:45	2	0	2	0.0	0.6	0	6	0	6	0.0	0.2	2
1:45-2:00	0	0	0	0.0	0.0	0	4	2	6	33.3	0.2	0
1時間計	3	0	3	0.0	0.9	1	19	2	21	9.5	0.7	3
2:00-2:15	0	0	0	0.0	0.0	0	7	0	7	0.0	0.2	0
2:15-2:30	0	0	0	0.0	0.0	0	6	0	6	0.0	0.2	2
2:30-2:45	1	0	1	0.0	0.3	0	2	0	2	0.0	0.1	0
2:45-3:00	1	0	1	0.0	0.3	0	5	0	5	0.0	0.2	0
1時間計	2	0	2	0.0	0.6	0	20	0	20	0.0	0.7	2
3:00-3:15	0	0	0	0.0	0.0	0	3	0	3	0.0	0.1	1
3:15-3:30	0	0	0	0.0	0.0	0	1	0	1	0.0	0.0	1
3:30-3:45	0	0	0	0.0	0.0	0	2	0	2	0.0	0.1	0
3:45-4:00	0	0	0	0.0	0.0	0	2	0	2	0.0	0.1	0
1時間計	0	0	0	0.0	0.0	0	8	0	8	0.0	0.3	2
4:00-4:15	0	0	0	0.0	0.0	0	4	0	4	0.0	0.1	0
4:15-4:30	2	0	2	0.0	0.6	0	5	0	5	0.0	0.2	0
4:30-4:45	1	0	1	0.0	0.3	0	8	0	8	0.0	0.3	1
4:45-5:00	2	0	2	0.0	0.6	0	3	0	3	0.0	0.1	0
1時間計	5	0	5	0.0	1.5	0	20	0	20	0.0	0.7	1
5:00-5:15	2	0	2	0.0	0.6	1	5	1	6	16.7	0.2	0
5:15-5:30	1	0	1	0.0	0.3	0	11	0	11	0.0	0.4	0
5:30-5:45	0	0	0	0.0	0.0	0	5	0	5	0.0	0.2	1
5:45-6:00	1	0	1	0.0	0.3	0	4	0	4	0.0	0.1	1
1時間計	4	0	4	0.0	1.2	1	25	1	26	3.8	0.9	2

方向別自動車交通量調査表

調査地点：地域社会6 瀬谷中学校前

調査年月日：令和元年 5月11日(土) 天候：晴れ時々曇り



方向 時間帯	4						5					
	小型車 (台)	大型車 (台)	合計 (台)	大型車 混入率 (%)	時間 係数 (%)	二輪車 (台)	小型車 (台)	大型車 (台)	合計 (台)	大型車 混入率 (%)	時間 係数 (%)	二輪車 (台)
6:00-6:15	1	0	1	0.0	0.3	0	11	1	12	8.3	0.4	1
6:15-6:30	0	0	0	0.0	0.0	0	15	0	15	0.0	0.5	3
6:30-6:45	1	0	1	0.0	0.3	0	17	2	19	10.5	0.6	1
6:45-7:00	0	0	0	0.0	0.0	0	20	1	21	4.8	0.7	1
1時間計	2	0	2	0.0	0.6	0	63	4	67	6.0	2.2	6
7:00-7:15	3	0	3	0.0	0.9	0	20	3	23	13.0	0.8	4
7:15-7:30	2	0	2	0.0	0.6	0	30	0	30	0.0	1.0	3
7:30-7:45	3	0	3	0.0	0.9	0	26	1	27	3.7	0.9	0
7:45-8:00	3	0	3	0.0	0.9	0	27	1	28	3.6	0.9	1
1時間計	11	0	11	0.0	3.3	0	103	5	108	4.6	3.6	8
8:00-8:15	5	0	5	0.0	1.5	0	36	3	39	7.7	1.3	3
8:15-8:30	2	0	2	0.0	0.6	0	25	2	27	7.4	0.9	2
8:30-8:45	6	0	6	0.0	1.8	1	43	2	45	4.4	1.5	1
8:45-9:00	9	0	9	0.0	2.7	1	34	1	35	2.9	1.2	1
1時間計	22	0	22	0.0	6.5	2	138	8	146	5.5	4.9	7
9:00-9:15	2	0	2	0.0	0.6	0	37	1	38	2.6	1.3	5
9:15-9:30	2	0	2	0.0	0.6	1	39	2	41	4.9	1.4	4
9:30-9:45	2	0	2	0.0	0.6	0	46	0	46	0.0	1.5	4
9:45-10:00	3	0	3	0.0	0.9	0	49	3	52	5.8	1.7	2
1時間計	9	0	9	0.0	2.7	1	171	6	177	3.4	5.9	15
10:00-10:15	10	0	10	0.0	3.0	0	40	2	42	4.8	1.4	5
10:15-10:30	3	0	3	0.0	0.9	1	49	4	53	7.5	1.8	1
10:30-10:45	4	0	4	0.0	1.2	2	45	0	45	0.0	1.5	4
10:45-11:00	10	0	10	0.0	3.0	0	41	2	43	4.7	1.4	1
1時間計	27	0	27	0.0	8.0	3	175	8	183	4.4	6.1	11
11:00-11:15	7	0	7	0.0	2.1	0	64	2	66	3.0	2.2	4
11:15-11:30	5	0	5	0.0	1.5	0	43	0	43	0.0	1.4	1
11:30-11:45	6	0	6	0.0	1.8	1	40	0	40	0.0	1.3	7
11:45-12:00	9	0	9	0.0	2.7	0	43	2	45	4.4	1.5	8
1時間計	27	0	27	0.0	8.0	1	190	4	194	2.1	6.5	20
12:00-12:15	9	0	9	0.0	2.7	0	52	0	52	0.0	1.7	4
12:15-12:30	4	0	4	0.0	1.2	0	53	3	56	5.4	1.9	6
12:30-12:45	5	0	5	0.0	1.5	0	38	1	39	2.6	1.3	4
12:45-13:00	4	0	4	0.0	1.2	0	45	2	47	4.3	1.6	2
1時間計	22	0	22	0.0	6.5	0	188	6	194	3.1	6.5	16
13:00-13:15	2	0	2	0.0	0.6	0	50	0	50	0.0	1.7	5
13:15-13:30	11	0	11	0.0	3.3	0	60	1	61	1.6	2.0	3
13:30-13:45	7	0	7	0.0	2.1	0	45	0	45	0.0	1.5	3
13:45-14:00	10	0	10	0.0	3.0	0	50	3	53	5.7	1.8	1
1時間計	30	0	30	0.0	8.9	0	205	4	209	1.9	7.0	12

方向別自動車交通量調査表

調査地点 : 地域社会6 瀬谷中学校前

調査年月日 : 令和元年 5月11日(土) 天候:晴れ時々曇り



方向 種別 時間帯	4						5					
	小型車 (台)	大型車 (台)	合計 (台)	大型車 混入率 (%)	時間 係数 (%)	二輪車 (台)	小型車 (台)	大型車 (台)	合計 (台)	大型車 混入率 (%)	時間 係数 (%)	二輪車 (台)
14:00-14:15	5	0	5	0.0	1.5	1	43	0	43	0.0	1.4	1
14:15-14:30	2	0	2	0.0	0.6	0	34	1	35	2.9	1.2	7
14:30-14:45	8	0	8	0.0	2.4	0	46	0	46	0.0	1.5	4
14:45-15:00	3	0	3	0.0	0.9	0	43	1	44	2.3	1.5	2
1時間計	18	0	18	0.0	5.3	1	166	2	168	1.2	5.6	14
15:00-15:15	3	0	3	0.0	0.9	0	49	1	50	2.0	1.7	2
15:15-15:30	10	0	10	0.0	3.0	0	65	0	65	0.0	2.2	4
15:30-15:45	9	0	9	0.0	2.7	0	51	0	51	0.0	1.7	3
15:45-16:00	9	0	9	0.0	2.7	0	59	4	63	6.3	2.1	2
1時間計	31	0	31	0.0	9.2	0	224	5	229	2.2	7.7	11
16:00-16:15	10	0	10	0.0	3.0	0	47	2	49	4.1	1.6	2
16:15-16:30	7	0	7	0.0	2.1	0	58	0	58	0.0	1.9	2
16:30-16:45	5	0	5	0.0	1.5	0	63	1	64	1.6	2.1	4
16:45-17:00	2	0	2	0.0	0.6	0	40	1	41	2.4	1.4	11
1時間計	24	0	24	0.0	7.1	0	208	4	212	1.9	7.1	19
17:00-17:15	11	0	11	0.0	3.3	0	54	2	56	3.6	1.9	6
17:15-17:30	6	0	6	0.0	1.8	0	53	2	55	3.6	1.8	4
17:30-17:45	11	0	11	0.0	3.3	0	42	0	42	0.0	1.4	4
17:45-18:00	8	0	8	0.0	2.4	0	57	2	59	3.4	2.0	6
1時間計	36	0	36	0.0	10.7	0	206	6	212	2.8	7.1	20
18:00-18:15	4	0	4	0.0	1.2	0	46	1	47	2.1	1.6	6
18:15-18:30	5	0	5	0.0	1.5	0	48	0	48	0.0	1.6	2
18:30-18:45	7	0	7	0.0	2.1	0	49	3	52	5.8	1.7	1
18:45-19:00	4	0	4	0.0	1.2	0	37	0	37	0.0	1.2	0
1時間計	20	0	20	0.0	5.9	0	180	4	184	2.2	6.2	9
19:00-19:15	5	0	5	0.0	1.5	0	43	1	44	2.3	1.5	5
19:15-19:30	2	0	2	0.0	0.6	0	28	1	29	3.4	1.0	2
19:30-19:45	4	0	4	0.0	1.2	0	32	1	33	3.0	1.1	3
19:45-20:00	3	0	3	0.0	0.9	0	38	1	39	2.6	1.3	4
1時間計	14	0	14	0.0	4.1	0	141	4	145	2.8	4.9	14
20:00-20:15	2	0	2	0.0	0.6	0	32	1	33	3.0	1.1	3
20:15-20:30	5	0	5	0.0	1.5	0	34	1	35	2.9	1.2	0
20:30-20:45	2	0	2	0.0	0.6	0	27	1	28	3.6	0.9	1
20:45-21:00	5	0	5	0.0	1.5	0	31	1	32	3.1	1.1	2
1時間計	14	0	14	0.0	4.1	0	124	4	128	3.1	4.3	6
21:00-21:15	2	0	2	0.0	0.6	0	36	1	37	2.7	1.2	4
21:15-21:30	3	0	3	0.0	0.9	0	27	0	27	0.0	0.9	0
21:30-21:45	1	0	1	0.0	0.3	0	22	1	23	4.3	0.8	0
21:45-22:00	1	0	1	0.0	0.3	0	20	0	20	0.0	0.7	1
1時間計	7	0	7	0.0	2.1	0	105	2	107	1.9	3.6	5
昼12時間計	277	0	277	0.0	82.0	8	2154	62	2216	2.8	74.3	162
夜12時間計	61	0	61	0.0	18.0	2	747	18	765	2.4	25.7	54
全時間合計	338	0	338	0.0	100.0	10	2901	80	2981	2.7	100.0	216
昼夜率	1.22	0.00	1.22	-	-	1.25	1.35	1.29	1.35	-	-	1.33

方向別自動車交通量調査表

調査地点：地域社会6 瀬谷中学校前

調査年月日：令和元年 5月11日(土) 天候：晴れ時々曇り



方向	6						B 合計 (4+ 5⇔ 6)						
	種別	小型車 (台)	大型車 (台)	合計 (台)	大型車 混入率 (%)	時間 係数 (%)	二輪車 (台)	小型車 (台)	大型車 (台)	合計 (台)	大型車 混入率 (%)	時間 係数 (%)	二輪車 (台)
22:00-22:15		24	1	25	4.0	1.0	2	60	2	62	3.2	1.0	5
22:15-22:30		23	0	23	0.0	0.9	2	54	0	54	0.0	0.9	4
22:30-22:45		20	0	20	0.0	0.8	1	45	0	45	0.0	0.8	3
22:45-23:00		27	0	27	0.0	1.0	1	59	0	59	0.0	1.0	2
1時間計		94	1	95	1.1	3.6	6	218	2	220	0.9	3.7	14
23:00-23:15		17	0	17	0.0	0.6	1	33	0	33	0.0	0.6	1
23:15-23:30		14	0	14	0.0	0.5	2	32	0	32	0.0	0.5	2
23:30-23:45		13	0	13	0.0	0.5	1	23	0	23	0.0	0.4	3
23:45-24:00		11	0	11	0.0	0.4	1	25	0	25	0.0	0.4	2
1時間計		55	0	55	0.0	2.1	5	113	0	113	0.0	1.9	8
0:00- 0:15		8	4	12	33.3	0.5	1	18	4	22	18.2	0.4	2
0:15- 0:30		6	1	7	14.3	0.3	0	16	1	17	5.9	0.3	0
0:30- 0:45		10	0	10	0.0	0.4	0	27	0	27	0.0	0.5	0
0:45- 1:00		6	0	6	0.0	0.2	2	19	0	19	0.0	0.3	3
1時間計		30	5	35	14.3	1.3	3	80	5	85	5.9	1.4	5
1:00- 1:15		6	0	6	0.0	0.2	0	13	0	13	0.0	0.2	1
1:15- 1:30		9	0	9	0.0	0.3	0	12	0	12	0.0	0.2	1
1:30- 1:45		2	0	2	0.0	0.1	0	10	0	10	0.0	0.2	2
1:45- 2:00		6	0	6	0.0	0.2	0	10	2	12	16.7	0.2	0
1時間計		23	0	23	0.0	0.9	0	45	2	47	4.3	0.8	4
2:00- 2:15		3	0	3	0.0	0.1	0	10	0	10	0.0	0.2	0
2:15- 2:30		4	1	5	20.0	0.2	1	10	1	11	9.1	0.2	3
2:30- 2:45		2	0	2	0.0	0.1	0	5	0	5	0.0	0.1	0
2:45- 3:00		4	0	4	0.0	0.2	0	10	0	10	0.0	0.2	0
1時間計		13	1	14	7.1	0.5	1	35	1	36	2.8	0.6	3
3:00- 3:15		1	0	1	0.0	0.0	0	4	0	4	0.0	0.1	1
3:15- 3:30		3	0	3	0.0	0.1	0	4	0	4	0.0	0.1	1
3:30- 3:45		2	0	2	0.0	0.1	1	4	0	4	0.0	0.1	1
3:45- 4:00		1	1	2	50.0	0.1	1	3	1	4	25.0	0.1	1
1時間計		7	1	8	12.5	0.3	2	15	1	16	6.3	0.3	4
4:00- 4:15		4	1	5	20.0	0.2	0	8	1	9	11.1	0.2	0
4:15- 4:30		4	0	4	0.0	0.2	2	11	0	11	0.0	0.2	2
4:30- 4:45		7	0	7	0.0	0.3	0	16	0	16	0.0	0.3	1
4:45- 5:00		4	0	4	0.0	0.2	0	9	0	9	0.0	0.2	0
1時間計		19	1	20	5.0	0.8	2	44	1	45	2.2	0.8	3
5:00- 5:15		4	0	4	0.0	0.2	0	11	1	12	8.3	0.2	1
5:15- 5:30		3	0	3	0.0	0.1	2	15	0	15	0.0	0.3	2
5:30- 5:45		11	0	11	0.0	0.4	0	16	0	16	0.0	0.3	1
5:45- 6:00		3	0	3	0.0	0.1	0	8	0	8	0.0	0.1	1
1時間計		21	0	21	0.0	0.8	2	50	1	51	2.0	0.9	5

方向別自動車交通量調査表

調査地点 : 地域社会6 瀬谷中学校前

調査年月日 : 令和元年 5月11日(土) 天候:晴れ時々曇り



方向 時間帯	6						B 合計 (4+ 5+ 6)					
	種別 小型車 (台)	大型車 (台)	合計 (台)	大型車 混入率 (%)	時間 係数 (%)	二輪車 (台)	小型車 (台)	大型車 (台)	合計 (台)	大型車 混入率 (%)	時間 係数 (%)	二輪車 (台)
6:00-6:15	13	1	14	7.1	0.5	0	25	2	27	7.4	0.5	1
6:15-6:30	9	1	10	10.0	0.4	1	24	1	25	4.0	0.4	4
6:30-6:45	13	1	14	7.1	0.5	1	31	3	34	8.8	0.6	2
6:45-7:00	13	0	13	0.0	0.5	1	33	1	34	2.9	0.6	2
1時間計	48	3	51	5.9	1.9	3	113	7	120	5.8	2.0	9
7:00-7:15	16	0	16	0.0	0.6	0	39	3	42	7.1	0.7	4
7:15-7:30	16	1	17	5.9	0.6	1	48	1	49	2.0	0.8	4
7:30-7:45	28	2	30	6.7	1.1	4	57	3	60	5.0	1.0	4
7:45-8:00	22	0	22	0.0	0.8	3	52	1	53	1.9	0.9	4
1時間計	82	3	85	3.5	3.2	8	196	8	204	3.9	3.4	16
8:00-8:15	25	0	25	0.0	1.0	4	66	3	69	4.3	1.2	7
8:15-8:30	33	0	33	0.0	1.3	4	60	2	62	3.2	1.0	6
8:30-8:45	31	1	32	3.1	1.2	2	80	3	83	3.6	1.4	4
8:45-9:00	39	2	41	4.9	1.6	3	82	3	85	3.5	1.4	5
1時間計	128	3	131	2.3	5.0	13	288	11	299	3.7	5.0	22
9:00-9:15	26	1	27	3.7	1.0	4	65	2	67	3.0	1.1	9
9:15-9:30	32	1	33	3.0	1.3	3	73	3	76	3.9	1.3	8
9:30-9:45	23	0	23	0.0	0.9	1	71	0	71	0.0	1.2	5
9:45-10:00	34	0	34	0.0	1.3	1	86	3	89	3.4	1.5	3
1時間計	115	2	117	1.7	4.5	9	295	8	303	2.6	5.1	25
10:00-10:15	32	1	33	3.0	1.3	3	82	3	85	3.5	1.4	8
10:15-10:30	36	0	36	0.0	1.4	0	88	4	92	4.3	1.6	2
10:30-10:45	40	0	40	0.0	1.5	1	89	0	89	0.0	1.5	7
10:45-11:00	36	1	37	2.7	1.4	1	87	3	90	3.3	1.5	2
1時間計	144	2	146	1.4	5.6	5	346	10	356	2.8	6.0	19
11:00-11:15	42	2	44	4.5	1.7	4	113	4	117	3.4	2.0	8
11:15-11:30	51	0	51	0.0	1.9	2	99	0	99	0.0	1.7	3
11:30-11:45	40	2	42	4.8	1.6	4	86	2	88	2.3	1.5	12
11:45-12:00	56	0	56	0.0	2.1	2	108	2	110	1.8	1.9	10
1時間計	189	4	193	2.1	7.4	12	406	8	414	1.9	7.0	33
12:00-12:15	36	1	37	2.7	1.4	2	97	1	98	1.0	1.7	6
12:15-12:30	50	1	51	2.0	1.9	3	107	4	111	3.6	1.9	9
12:30-12:45	42	0	42	0.0	1.6	4	85	1	86	1.2	1.4	8
12:45-13:00	29	0	29	0.0	1.1	3	78	2	80	2.5	1.3	5
1時間計	157	2	159	1.3	6.1	12	367	8	375	2.1	6.3	28
13:00-13:15	48	0	48	0.0	1.8	0	100	0	100	0.0	1.7	5
13:15-13:30	36	0	36	0.0	1.4	5	107	1	108	0.9	1.8	8
13:30-13:45	33	0	33	0.0	1.3	3	85	0	85	0.0	1.4	6
13:45-14:00	43	2	45	4.4	1.7	1	103	5	108	4.6	1.8	2
1時間計	160	2	162	1.2	6.2	9	395	6	401	1.5	6.8	21

方向別自動車交通量調査表

調査地点 : 地域社会6 瀬谷中学校前

調査年月日 : 令和元年 5月11日(土) 天候:晴れ時々曇り



方向 種別 時間帯	6						B 合計 (4+ 5+ 6)					
	小型車 (台)	大型車 (台)	合計 (台)	大型車 混入率 (%)	時 間 係 数 (%)	二輪車 (台)	小型車 (台)	大型車 (台)	合計 (台)	大型車 混入率 (%)	時 間 係 数 (%)	二輪車 (台)
14:00-14:15	44	0	44	0.0	1.7	1	92	0	92	0.0	1.6	3
14:15-14:30	47	0	47	0.0	1.8	3	83	1	84	1.2	1.4	10
14:30-14:45	54	1	55	1.8	2.1	4	108	1	109	0.9	1.8	8
14:45-15:00	40	0	40	0.0	1.5	3	86	1	87	1.1	1.5	5
1時間計	185	1	186	0.5	7.1	11	369	3	372	0.8	6.3	26
15:00-15:15	57	0	57	0.0	2.2	1	109	1	110	0.9	1.9	3
15:15-15:30	47	1	48	2.1	1.8	3	122	1	123	0.8	2.1	7
15:30-15:45	50	0	50	0.0	1.9	4	110	0	110	0.0	1.9	7
15:45-16:00	46	0	46	0.0	1.8	2	114	4	118	3.4	2.0	4
1時間計	200	1	201	0.5	7.7	10	455	6	461	1.3	7.8	21
16:00-16:15	38	0	38	0.0	1.5	1	95	2	97	2.1	1.6	3
16:15-16:30	50	0	50	0.0	1.9	1	115	0	115	0.0	1.9	3
16:30-16:45	67	1	68	1.5	2.6	1	135	2	137	1.5	2.3	5
16:45-17:00	51	0	51	0.0	1.9	3	93	1	94	1.1	1.6	14
1時間計	206	1	207	0.5	7.9	6	438	5	443	1.1	7.5	25
17:00-17:15	61	1	62	1.6	2.4	6	126	3	129	2.3	2.2	12
17:15-17:30	46	1	47	2.1	1.8	2	105	3	108	2.8	1.8	6
17:30-17:45	44	0	44	0.0	1.7	4	97	0	97	0.0	1.6	8
17:45-18:00	52	0	52	0.0	2.0	2	117	2	119	1.7	2.0	8
1時間計	203	2	205	1.0	7.8	14	445	8	453	1.8	7.6	34
18:00-18:15	43	1	44	2.3	1.7	3	93	2	95	2.1	1.6	9
18:15-18:30	37	0	37	0.0	1.4	3	90	0	90	0.0	1.5	5
18:30-18:45	47	2	49	4.1	1.9	2	103	5	108	4.6	1.8	3
18:45-19:00	38	0	38	0.0	1.5	4	79	0	79	0.0	1.3	4
1時間計	165	3	168	1.8	6.4	12	365	7	372	1.9	6.3	21
19:00-19:15	21	0	21	0.0	0.8	2	69	1	70	1.4	1.2	7
19:15-19:30	31	0	31	0.0	1.2	1	61	1	62	1.6	1.0	3
19:30-19:45	42	1	43	2.3	1.6	1	78	2	80	2.5	1.3	4
19:45-20:00	29	0	29	0.0	1.1	0	70	1	71	1.4	1.2	4
1時間計	123	1	124	0.8	4.7	4	278	5	283	1.8	4.8	18
20:00-20:15	34	0	34	0.0	1.3	1	68	1	69	1.4	1.2	4
20:15-20:30	32	1	33	3.0	1.3	3	71	2	73	2.7	1.2	3
20:30-20:45	25	1	26	3.8	1.0	0	54	2	56	3.6	0.9	1
20:45-21:00	34	1	35	2.9	1.3	3	70	2	72	2.8	1.2	5
1時間計	125	3	128	2.3	4.9	7	263	7	270	2.6	4.5	13
21:00-21:15	23	1	24	4.2	0.9	0	61	2	63	3.2	1.1	4
21:15-21:30	24	1	25	4.0	1.0	1	54	1	55	1.8	0.9	1
21:30-21:45	19	1	20	5.0	0.8	1	42	2	44	4.5	0.7	1
21:45-22:00	13	0	13	0.0	0.5	1	34	0	34	0.0	0.6	2
1時間計	79	3	82	3.7	3.1	3	191	5	196	2.6	3.3	8
昼12時間計	1934	26	1960	1.3	74.9	121	4365	88	4453	2.0	75.0	291
夜12時間計	637	19	656	2.9	25.1	38	1445	37	1482	2.5	25.0	94
全時間合計	2571	45	2616	1.7	100.0	159	5810	125	5935	2.1	100.0	385
昼 夜 率	1.33	1.73	1.33	-	-	1.31	1.33	1.42	1.33	-	-	1.32

方向別自動車交通量調査表

調査地点 : 地域社会6 瀬谷中学校前

調査年月日 : 令和元年 5月11日(土) 天候:晴れ時々曇り



方向 種別 時間帯	7						8					
	小型車 (台)	大型車 (台)	合計 (台)	大型車 混入率 (%)	時間 係数 (%)	二輪車 (台)	小型車 (台)	大型車 (台)	合計 (台)	大型車 混入率 (%)	時間 係数 (%)	二輪車 (台)
22:00-22:15	24	0	24	0.0	0.9	0	29	0	29	0.0	0.5	6
22:15-22:30	14	1	15	6.7	0.6	2	40	3	43	7.0	0.8	5
22:30-22:45	15	0	15	0.0	0.6	0	23	2	25	8.0	0.4	1
22:45-23:00	9	0	9	0.0	0.4	1	35	0	35	0.0	0.6	2
1時間計	62	1	63	1.6	2.5	3	127	5	132	3.8	2.3	14
23:00-23:15	15	0	15	0.0	0.6	0	25	1	26	3.8	0.5	4
23:15-23:30	10	0	10	0.0	0.4	0	20	3	23	13.0	0.4	2
23:30-23:45	9	0	9	0.0	0.4	2	23	1	24	4.2	0.4	2
23:45-24:00	7	1	8	12.5	0.3	0	17	2	19	10.5	0.3	3
1時間計	41	1	42	2.4	1.6	2	85	7	92	7.6	1.6	11
0:00-0:15	13	0	13	0.0	0.5	1	13	1	14	7.1	0.2	1
0:15-0:30	9	0	9	0.0	0.4	1	9	1	10	10.0	0.2	0
0:30-0:45	4	1	5	20.0	0.2	0	16	0	16	0.0	0.3	3
0:45-1:00	8	1	9	11.1	0.4	1	18	2	20	10.0	0.4	3
1時間計	34	2	36	5.6	1.4	3	56	4	60	6.7	1.1	7
1:00-1:15	5	0	5	0.0	0.2	0	11	1	12	8.3	0.2	1
1:15-1:30	0	1	1	100.0	0.0	0	6	2	8	25.0	0.1	2
1:30-1:45	6	0	6	0.0	0.2	0	9	7	16	43.8	0.3	0
1:45-2:00	4	1	5	20.0	0.2	2	7	5	12	41.7	0.2	1
1時間計	15	2	17	11.8	0.7	2	33	15	48	31.3	0.8	4
2:00-2:15	5	1	6	16.7	0.2	0	10	2	12	16.7	0.2	1
2:15-2:30	1	0	1	0.0	0.0	0	7	1	8	12.5	0.1	0
2:30-2:45	1	0	1	0.0	0.0	0	9	1	10	10.0	0.2	0
2:45-3:00	1	0	1	0.0	0.0	0	7	4	11	36.4	0.2	0
1時間計	8	1	9	11.1	0.4	0	33	8	41	19.5	0.7	1
3:00-3:15	4	0	4	0.0	0.2	0	4	0	4	0.0	0.1	0
3:15-3:30	4	1	5	20.0	0.2	2	11	5	16	31.3	0.3	0
3:30-3:45	6	0	6	0.0	0.2	0	10	3	13	23.1	0.2	0
3:45-4:00	4	0	4	0.0	0.2	0	8	1	9	11.1	0.2	0
1時間計	18	1	19	5.3	0.7	2	33	9	42	21.4	0.7	0
4:00-4:15	4	1	5	20.0	0.2	1	12	3	15	20.0	0.3	0
4:15-4:30	5	1	6	16.7	0.2	1	8	2	10	20.0	0.2	2
4:30-4:45	4	0	4	0.0	0.2	0	9	2	11	18.2	0.2	2
4:45-5:00	5	0	5	0.0	0.2	0	12	3	15	20.0	0.3	2
1時間計	18	2	20	10.0	0.8	2	41	10	51	19.6	0.9	6
5:00-5:15	5	2	7	28.6	0.3	0	14	8	22	36.4	0.4	0
5:15-5:30	4	0	4	0.0	0.2	2	15	3	18	16.7	0.3	4
5:30-5:45	3	0	3	0.0	0.1	0	17	3	20	15.0	0.4	4
5:45-6:00	7	0	7	0.0	0.3	1	24	4	28	14.3	0.5	1
1時間計	19	2	21	9.5	0.8	3	70	18	88	20.5	1.5	9

方向別自動車交通量調査表

調査地点 : 地域社会6 瀬谷中学校前

調査年月日 : 令和元年 5月11日(土) 天候:晴れ時々曇り



方向	7						8						
	種別	小型車 (台)	大型車 (台)	合計 (台)	大型車 混入率 (%)	時間 係数 (%)	二輪車 (台)	小型車 (台)	大型車 (台)	合計 (台)	大型車 混入率 (%)	時間 係数 (%)	二輪車 (台)
6:00-6:15		10	0	10	0.0	0.4	1	26	2	28	7.1	0.5	1
6:15-6:30		14	2	16	12.5	0.6	1	38	0	38	0.0	0.7	2
6:30-6:45		28	3	31	9.7	1.2	0	47	3	50	6.0	0.9	6
6:45-7:00		10	2	12	16.7	0.5	2	40	3	43	7.0	0.8	2
1時間計		62	7	69	10.1	2.7	4	151	8	159	5.0	2.8	11
7:00-7:15		15	3	18	16.7	0.7	2	73	3	76	3.9	1.3	6
7:15-7:30		15	0	15	0.0	0.6	0	65	1	66	1.5	1.2	11
7:30-7:45		14	0	14	0.0	0.5	3	65	3	68	4.4	1.2	13
7:45-8:00		22	0	22	0.0	0.9	0	81	2	83	2.4	1.5	8
1時間計		66	3	69	4.3	2.7	5	284	9	293	3.1	5.2	38
8:00-8:15		35	2	37	5.4	1.5	4	71	2	73	2.7	1.3	12
8:15-8:30		35	1	36	2.8	1.4	1	79	4	83	4.8	1.5	13
8:30-8:45		27	3	30	10.0	1.2	6	81	3	84	3.6	1.5	10
8:45-9:00		39	0	39	0.0	1.5	4	63	3	66	4.5	1.2	6
1時間計		136	6	142	4.2	5.6	15	294	12	306	3.9	5.4	41
9:00-9:15		38	1	39	2.6	1.5	3	85	3	88	3.4	1.5	15
9:15-9:30		43	0	43	0.0	1.7	7	123	8	131	6.1	2.3	10
9:30-9:45		35	1	36	2.8	1.4	3	67	5	72	6.9	1.3	13
9:45-10:00		30	0	30	0.0	1.2	2	88	3	91	3.3	1.6	4
1時間計		146	2	148	1.4	5.8	15	363	19	382	5.0	6.7	42
10:00-10:15		35	0	35	0.0	1.4	4	81	2	83	2.4	1.5	4
10:15-10:30		32	3	35	8.6	1.4	1	95	2	97	2.1	1.7	3
10:30-10:45		46	0	46	0.0	1.8	2	59	5	64	7.8	1.1	8
10:45-11:00		47	1	48	2.1	1.9	3	81	2	83	2.4	1.5	10
1時間計		160	4	164	2.4	6.4	10	316	11	327	3.4	5.8	25
11:00-11:15		38	0	38	0.0	1.5	1	87	5	92	5.4	1.6	5
11:15-11:30		43	1	44	2.3	1.7	2	75	1	76	1.3	1.3	12
11:30-11:45		34	0	34	0.0	1.3	1	61	3	64	4.7	1.1	6
11:45-12:00		53	2	55	3.6	2.2	2	91	3	94	3.2	1.7	5
1時間計		168	3	171	1.8	6.7	6	314	12	326	3.7	5.7	28
12:00-12:15		42	0	42	0.0	1.6	1	103	6	109	5.5	1.9	6
12:15-12:30		42	0	42	0.0	1.6	2	91	2	93	2.2	1.6	7
12:30-12:45		47	1	48	2.1	1.9	2	88	3	91	3.3	1.6	10
12:45-13:00		25	0	25	0.0	1.0	3	73	2	75	2.7	1.3	5
1時間計		156	1	157	0.6	6.2	8	355	13	368	3.5	6.5	28
13:00-13:15		30	1	31	3.2	1.2	4	96	5	101	5.0	1.8	5
13:15-13:30		38	1	39	2.6	1.5	1	83	2	85	2.4	1.5	6
13:30-13:45		36	0	36	0.0	1.4	3	96	6	102	5.9	1.8	7
13:45-14:00		79	0	79	0.0	3.1	2	127	2	129	1.6	2.3	5
1時間計		183	2	185	1.1	7.3	10	402	15	417	3.6	7.3	23

方向別自動車交通量調査表

調査地点：地域社会6 瀬谷中学校前

調査年月日：令和元年 5月11日(土) 天候：晴れ時々曇り



方向 種別 時間帯	7						8					
	小型車 (台)	大型車 (台)	合計 (台)	大型車 混入率 (%)	時 間 係 数 (%)	二輪車 (台)	小型車 (台)	大型車 (台)	合計 (台)	大型車 混入率 (%)	時 間 係 数 (%)	二輪車 (台)
14:00-14:15	54	0	54	0.0	2.1	2	110	1	111	0.9	2.0	3
14:15-14:30	43	0	43	0.0	1.7	4	92	1	93	1.1	1.6	10
14:30-14:45	68	1	69	1.4	2.7	5	120	1	121	0.8	2.1	7
14:45-15:00	86	2	88	2.3	3.5	1	97	2	99	2.0	1.7	6
1時間計	251	3	254	1.2	10.0	12	419	5	424	1.2	7.5	26
15:00-15:15	62	3	65	4.6	2.5	3	84	1	85	1.2	1.5	6
15:15-15:30	36	2	38	5.3	1.5	3	122	3	125	2.4	2.2	5
15:30-15:45	37	1	38	2.6	1.5	3	84	5	89	5.6	1.6	6
15:45-16:00	34	0	34	0.0	1.3	3	124	5	129	3.9	2.3	7
1時間計	169	6	175	3.4	6.9	12	414	14	428	3.3	7.5	24
16:00-16:15	46	1	47	2.1	1.8	2	84	4	88	4.5	1.5	0
16:15-16:30	34	1	35	2.9	1.4	3	89	5	94	5.3	1.7	7
16:30-16:45	64	1	65	1.5	2.5	3	73	8	81	9.9	1.4	17
16:45-17:00	40	1	41	2.4	1.6	1	87	5	92	5.4	1.6	12
1時間計	184	4	188	2.1	7.4	9	333	22	355	6.2	6.3	36
17:00-17:15	29	0	29	0.0	1.1	3	85	2	87	2.3	1.5	10
17:15-17:30	33	0	33	0.0	1.3	10	70	5	75	6.7	1.3	5
17:30-17:45	47	0	47	0.0	1.8	3	77	2	79	2.5	1.4	5
17:45-18:00	52	0	52	0.0	2.0	0	88	0	88	0.0	1.5	2
1時間計	161	0	161	0.0	6.3	16	320	9	329	2.7	5.8	22
18:00-18:15	37	0	37	0.0	1.5	4	79	0	79	0.0	1.4	6
18:15-18:30	44	1	45	2.2	1.8	1	86	9	95	9.5	1.7	3
18:30-18:45	21	0	21	0.0	0.8	0	84	3	87	3.4	1.5	3
18:45-19:00	22	0	22	0.0	0.9	3	63	1	64	1.6	1.1	6
1時間計	124	1	125	0.8	4.9	8	312	13	325	4.0	5.7	18
19:00-19:15	33	0	33	0.0	1.3	2	73	2	75	2.7	1.3	3
19:15-19:30	45	1	46	2.2	1.8	2	85	1	86	1.2	1.5	3
19:30-19:45	33	0	33	0.0	1.3	1	59	1	60	1.7	1.1	4
19:45-20:00	25	0	25	0.0	1.0	1	57	2	59	3.4	1.0	5
1時間計	136	1	137	0.7	5.4	6	274	6	280	2.1	4.9	15
20:00-20:15	24	0	24	0.0	0.9	2	58	4	62	6.5	1.1	6
20:15-20:30	28	1	29	3.4	1.1	0	55	1	56	1.8	1.0	3
20:30-20:45	29	0	29	0.0	1.1	2	59	0	59	0.0	1.0	2
20:45-21:00	23	0	23	0.0	0.9	0	43	0	43	0.0	0.8	3
1時間計	104	1	105	1.0	4.1	4	215	5	220	2.3	3.9	14
21:00-21:15	21	0	21	0.0	0.8	0	54	0	54	0.0	1.0	5
21:15-21:30	19	1	20	5.0	0.8	0	36	1	37	2.7	0.7	5
21:30-21:45	19	0	19	0.0	0.7	1	52	2	54	3.7	1.0	3
21:45-22:00	13	0	13	0.0	0.5	3	41	0	41	0.0	0.7	3
1時間計	72	1	73	1.4	2.9	4	183	3	186	1.6	3.3	16
昼12時間計	1904	35	1939	1.8	76.0	126	4126	154	4280	3.6	75.4	351
夜12時間計	589	22	611	3.6	24.0	35	1301	98	1399	7.0	24.6	108
全時間合計	2493	57	2550	2.2	100.0	161	5427	252	5679	4.4	100.0	459
昼 夜 率	1.31	1.63	1.32	-	-	1.28	1.32	1.64	1.33	-	-	1.31

方向別自動車交通量調査表

調査地点 : 地域社会6 瀬谷中学校前

調査年月日 : 令和元年 5月11日(土) 天候:晴れ時々曇り



方向 種別 時間帯	9						C 合計 (7+ 8+ 9)					
	小型車 (台)	大型車 (台)	合計 (台)	大型車 混入率 (%)	時間 係数 (%)	二輪車 (台)	小型車 (台)	大型車 (台)	合計 (台)	大型車 混入率 (%)	時間 係数 (%)	二輪車 (台)
22:00-22:15	15	0	15	0.0	0.7	0	68	0	68	0.0	0.7	6
22:15-22:30	16	0	16	0.0	0.7	1	70	4	74	5.4	0.7	8
22:30-22:45	10	1	11	9.1	0.5	0	48	3	51	5.9	0.5	1
22:45-23:00	15	0	15	0.0	0.7	0	59	0	59	0.0	0.6	3
1時間計	56	1	57	1.8	2.6	1	245	7	252	2.8	2.4	18
23:00-23:15	13	0	13	0.0	0.6	0	53	1	54	1.9	0.5	4
23:15-23:30	9	1	10	10.0	0.5	0	39	4	43	9.3	0.4	2
23:30-23:45	8	0	8	0.0	0.4	0	40	1	41	2.4	0.4	4
23:45-24:00	3	0	3	0.0	0.1	0	27	3	30	10.0	0.3	3
1時間計	33	1	34	2.9	1.5	0	159	9	168	5.4	1.6	13
0:00- 0:15	9	0	9	0.0	0.4	0	35	1	36	2.8	0.3	2
0:15- 0:30	6	0	6	0.0	0.3	0	24	1	25	4.0	0.2	1
0:30- 0:45	5	0	5	0.0	0.2	0	25	1	26	3.8	0.2	3
0:45- 1:00	5	1	6	16.7	0.3	0	31	4	35	11.4	0.3	4
1時間計	25	1	26	3.8	1.2	0	115	7	122	5.7	1.2	10
1:00- 1:15	2	0	2	0.0	0.1	1	18	1	19	5.3	0.2	2
1:15- 1:30	6	0	6	0.0	0.3	0	12	3	15	20.0	0.1	2
1:30- 1:45	3	0	3	0.0	0.1	1	18	7	25	28.0	0.2	1
1:45- 2:00	2	1	3	33.3	0.1	0	13	7	20	35.0	0.2	3
1時間計	13	1	14	7.1	0.6	2	61	18	79	22.8	0.8	8
2:00- 2:15	1	0	1	0.0	0.0	0	16	3	19	15.8	0.2	1
2:15- 2:30	5	0	5	0.0	0.2	0	13	1	14	7.1	0.1	0
2:30- 2:45	1	0	1	0.0	0.0	0	11	1	12	8.3	0.1	0
2:45- 3:00	2	1	3	33.3	0.1	0	10	5	15	33.3	0.1	0
1時間計	9	1	10	10.0	0.5	0	50	10	60	16.7	0.6	1
3:00- 3:15	2	1	3	33.3	0.1	2	10	1	11	9.1	0.1	2
3:15- 3:30	0	0	0	0.0	0.0	0	15	6	21	28.6	0.2	2
3:30- 3:45	0	0	0	0.0	0.0	1	16	3	19	15.8	0.2	1
3:45- 4:00	1	1	2	50.0	0.1	0	13	2	15	13.3	0.1	0
1時間計	3	2	5	40.0	0.2	3	54	12	66	18.2	0.6	5
4:00- 4:15	2	1	3	33.3	0.1	0	18	5	23	21.7	0.2	1
4:15- 4:30	2	0	2	0.0	0.1	0	15	3	18	16.7	0.2	3
4:30- 4:45	2	0	2	0.0	0.1	0	15	2	17	11.8	0.2	2
4:45- 5:00	1	0	1	0.0	0.0	0	18	3	21	14.3	0.2	2
1時間計	7	1	8	12.5	0.4	0	66	13	79	16.5	0.8	8
5:00- 5:15	2	1	3	33.3	0.1	0	21	11	32	34.4	0.3	0
5:15- 5:30	5	0	5	0.0	0.2	0	24	3	27	11.1	0.3	6
5:30- 5:45	1	1	2	50.0	0.1	0	21	4	25	16.0	0.2	4
5:45- 6:00	8	0	8	0.0	0.4	0	39	4	43	9.3	0.4	2
1時間計	16	2	18	11.1	0.8	0	105	22	127	17.3	1.2	12

方向別自動車交通量調査表

調査地点 : 地域社会6 瀬谷中学校前

調査年月日 : 令和元年 5月11日(土) 天候:晴れ時々曇り



方向 時間帯	9						C 合計 (7+ 8+ 9)					
	種別 小型車 (台)	大型車 (台)	合計 (台)	大型車 混入率 (%)	時間 係数 (%)	二輪車 (台)	小型車 (台)	大型車 (台)	合計 (台)	大型車 混入率 (%)	時間 係数 (%)	二輪車 (台)
6:00-6:15	2	0	2	0.0	0.1	1	38	2	40	5.0	0.4	3
6:15-6:30	6	1	7	14.3	0.3	0	58	3	61	4.9	0.6	3
6:30-6:45	7	1	8	12.5	0.4	0	82	7	89	7.9	0.9	6
6:45-7:00	1	3	4	75.0	0.2	1	51	8	59	13.6	0.6	5
1時間計	16	5	21	23.8	1.0	2	229	20	249	8.0	2.4	17
7:00-7:15	7	1	8	12.5	0.4	0	95	7	102	6.9	1.0	8
7:15-7:30	6	1	7	14.3	0.3	0	86	2	88	2.3	0.8	11
7:30-7:45	12	1	13	7.7	0.6	0	91	4	95	4.2	0.9	16
7:45-8:00	10	1	11	9.1	0.5	0	113	3	116	2.6	1.1	8
1時間計	35	4	39	10.3	1.8	0	385	16	401	4.0	3.8	43
8:00-8:15	14	3	17	17.6	0.8	1	120	7	127	5.5	1.2	17
8:15-8:30	18	1	19	5.3	0.9	0	132	6	138	4.3	1.3	14
8:30-8:45	22	1	23	4.3	1.0	1	130	7	137	5.1	1.3	17
8:45-9:00	23	1	24	4.2	1.1	4	125	4	129	3.1	1.2	14
1時間計	77	6	83	7.2	3.8	6	507	24	531	4.5	5.1	62
9:00-9:15	23	1	24	4.2	1.1	3	146	5	151	3.3	1.4	21
9:15-9:30	29	0	29	0.0	1.3	0	195	8	203	3.9	1.9	17
9:30-9:45	25	2	27	7.4	1.2	1	127	8	135	5.9	1.3	17
9:45-10:00	30	0	30	0.0	1.4	0	148	3	151	2.0	1.4	6
1時間計	107	3	110	2.7	5.0	4	616	24	640	3.8	6.1	61
10:00-10:15	32	1	33	3.0	1.5	3	148	3	151	2.0	1.4	11
10:15-10:30	32	2	34	5.9	1.5	0	159	7	166	4.2	1.6	4
10:30-10:45	35	1	36	2.8	1.6	0	140	6	146	4.1	1.4	10
10:45-11:00	35	2	37	5.4	1.7	3	163	5	168	3.0	1.6	16
1時間計	134	6	140	4.3	6.3	6	610	21	631	3.3	6.0	41
11:00-11:15	29	3	32	9.4	1.4	0	154	8	162	4.9	1.6	6
11:15-11:30	31	2	33	6.1	1.5	4	149	4	153	2.6	1.5	18
11:30-11:45	47	2	49	4.1	2.2	1	142	5	147	3.4	1.4	8
11:45-12:00	47	7	54	13.0	2.4	0	191	12	203	5.9	1.9	7
1時間計	154	14	168	8.3	7.6	5	636	29	665	4.4	6.4	39
12:00-12:15	45	2	47	4.3	2.1	0	190	8	198	4.0	1.9	7
12:15-12:30	48	0	48	0.0	2.2	2	181	2	183	1.1	1.8	11
12:30-12:45	28	2	30	6.7	1.4	1	163	6	169	3.6	1.6	13
12:45-13:00	57	0	57	0.0	2.6	1	155	2	157	1.3	1.5	9
1時間計	178	4	182	2.2	8.2	4	689	18	707	2.5	6.8	40
13:00-13:15	54	2	56	3.6	2.5	0	180	8	188	4.3	1.8	9
13:15-13:30	49	1	50	2.0	2.3	3	170	4	174	2.3	1.7	10
13:30-13:45	38	0	38	0.0	1.7	1	170	6	176	3.4	1.7	11
13:45-14:00	49	1	50	2.0	2.3	0	255	3	258	1.2	2.5	7
1時間計	190	4	194	2.1	8.8	4	775	21	796	2.6	7.6	37

方向別自動車交通量調査表

調査地点：地域社会6 瀬谷中学校前

調査年月日：令和元年 5月11日(土) 天候：晴れ時々曇り



方向 種別 時間帯	9						C 合計 (7+ 8+ 9)					
	小型車 (台)	大型車 (台)	合計 (台)	大型車 混入率 (%)	時係 数 (%)	二輪車 (台)	小型車 (台)	大型車 (台)	合計 (台)	大型車 混入率 (%)	時係 数 (%)	二輪車 (台)
14:00-14:15	45	1	46	2.2	2.1	1	209	2	211	0.9	2.0	6
14:15-14:30	33	1	34	2.9	1.5	1	168	2	170	1.2	1.6	15
14:30-14:45	42	1	43	2.3	1.9	2	230	3	233	1.3	2.2	14
14:45-15:00	46	1	47	2.1	2.1	0	229	5	234	2.1	2.2	7
1時間計	166	4	170	2.4	7.7	4	836	12	848	1.4	8.1	42
15:00-15:15	61	1	62	1.6	2.8	1	207	5	212	2.4	2.0	10
15:15-15:30	43	2	45	4.4	2.0	1	201	7	208	3.4	2.0	9
15:30-15:45	29	0	29	0.0	1.3	2	150	6	156	3.8	1.5	11
15:45-16:00	36	1	37	2.7	1.7	3	194	6	200	3.0	1.9	13
1時間計	169	4	173	2.3	7.8	7	752	24	776	3.1	7.4	43
16:00-16:15	40	0	40	0.0	1.8	0	170	5	175	2.9	1.7	2
16:15-16:30	51	1	52	1.9	2.4	2	174	7	181	3.9	1.7	12
16:30-16:45	63	1	64	1.6	2.9	0	200	10	210	4.8	2.0	20
16:45-17:00	44	1	45	2.2	2.0	2	171	7	178	3.9	1.7	15
1時間計	198	3	201	1.5	9.1	4	715	29	744	3.9	7.1	49
17:00-17:15	34	1	35	2.9	1.6	1	148	3	151	2.0	1.4	14
17:15-17:30	38	0	38	0.0	1.7	0	141	5	146	3.4	1.4	15
17:30-17:45	37	1	38	2.6	1.7	0	161	3	164	1.8	1.6	8
17:45-18:00	38	0	38	0.0	1.7	0	178	0	178	0.0	1.7	2
1時間計	147	2	149	1.3	6.7	1	628	11	639	1.7	6.1	39
18:00-18:15	29	1	30	3.3	1.4	0	145	1	146	0.7	1.4	10
18:15-18:30	46	1	47	2.1	2.1	2	176	11	187	5.9	1.8	6
18:30-18:45	18	1	19	5.3	0.9	0	123	4	127	3.1	1.2	3
18:45-19:00	34	1	35	2.9	1.6	1	119	2	121	1.7	1.2	10
1時間計	127	4	131	3.1	5.9	3	563	18	581	3.1	5.6	29
19:00-19:15	35	1	36	2.8	1.6	2	141	3	144	2.1	1.4	7
19:15-19:30	32	0	32	0.0	1.4	4	162	2	164	1.2	1.6	9
19:30-19:45	24	1	25	4.0	1.1	0	116	2	118	1.7	1.1	5
19:45-20:00	21	1	22	4.5	1.0	2	103	3	106	2.8	1.0	8
1時間計	112	3	115	2.6	5.2	8	522	10	532	1.9	5.1	29
20:00-20:15	25	1	26	3.8	1.2	1	107	5	112	4.5	1.1	9
20:15-20:30	22	1	23	4.3	1.0	1	105	3	108	2.8	1.0	4
20:30-20:45	18	1	19	5.3	0.9	1	106	1	107	0.9	1.0	5
20:45-21:00	11	2	13	15.4	0.6	0	77	2	79	2.5	0.8	3
1時間計	76	5	81	6.2	3.7	3	395	11	406	2.7	3.9	21
21:00-21:15	17	0	17	0.0	0.8	0	92	0	92	0.0	0.9	5
21:15-21:30	18	1	19	5.3	0.9	0	73	3	76	3.9	0.7	5
21:30-21:45	31	1	32	3.1	1.4	1	102	3	105	2.9	1.0	5
21:45-22:00	12	0	12	0.0	0.5	0	66	0	66	0.0	0.6	6
1時間計	78	2	80	2.5	3.6	1	333	6	339	1.8	3.2	21
昼12時間計	1682	58	1740	3.3	78.8	48	7712	247	7959	3.1	76.3	525
夜12時間計	444	25	469	5.3	21.2	20	2334	145	2479	5.8	23.7	163
全時間合計	2126	83	2209	3.8	100.0	68	10046	392	10438	3.8	100.0	688
昼 夜 率	1.26	1.43	1.27	-	-	1.42	1.30	1.59	1.31	-	-	1.31

方向別自動車交通量調査表

調査地点：地域社会6 瀬谷中学校前

調査年月日：令和元年 5月11日(土) 天候：晴れ時々曇り



方向	10						11						
	種別	小型車 (台)	大型車 (台)	合計 (台)	大型車 混入率 (%)	時間 係数 (%)	二輪車 (台)	小型車 (台)	大型車 (台)	合計 (台)	大型車 混入率 (%)	時間 係数 (%)	二輪車 (台)
22:00-22:15		16	1	17	5.9	1.0	1	28	1	29	3.4	0.9	1
22:15-22:30		9	0	9	0.0	0.5	1	42	0	42	0.0	1.3	2
22:30-22:45		10	0	10	0.0	0.6	0	15	0	15	0.0	0.5	0
22:45-23:00		13	0	13	0.0	0.8	0	13	0	13	0.0	0.4	1
1時間計		48	1	49	2.0	2.9	2	98	1	99	1.0	3.1	4
23:00-23:15		16	0	16	0.0	0.9	0	30	1	31	3.2	1.0	3
23:15-23:30		7	0	7	0.0	0.4	1	10	1	11	9.1	0.3	2
23:30-23:45		8	1	9	11.1	0.5	0	12	0	12	0.0	0.4	2
23:45-24:00		2	0	2	0.0	0.1	0	12	0	12	0.0	0.4	1
1時間計		33	1	34	2.9	2.0	1	64	2	66	3.0	2.1	8
0:00- 0:15		2	0	2	0.0	0.1	0	10	1	11	9.1	0.3	0
0:15- 0:30		6	0	6	0.0	0.4	0	11	0	11	0.0	0.3	0
0:30- 0:45		3	0	3	0.0	0.2	0	7	0	7	0.0	0.2	1
0:45- 1:00		5	0	5	0.0	0.3	0	7	0	7	0.0	0.2	1
1時間計		16	0	16	0.0	0.9	0	35	1	36	2.8	1.1	2
1:00- 1:15		3	1	4	25.0	0.2	0	13	0	13	0.0	0.4	0
1:15- 1:30		9	0	9	0.0	0.5	0	9	0	9	0.0	0.3	2
1:30- 1:45		2	2	4	50.0	0.2	1	8	0	8	0.0	0.3	3
1:45- 2:00		5	0	5	0.0	0.3	2	5	0	5	0.0	0.2	0
1時間計		19	3	22	13.6	1.3	3	35	0	35	0.0	1.1	5
2:00- 2:15		2	1	3	33.3	0.2	0	4	1	5	20.0	0.2	0
2:15- 2:30		0	1	1	100.0	0.1	0	4	0	4	0.0	0.1	1
2:30- 2:45		1	2	3	66.7	0.2	1	5	0	5	0.0	0.2	1
2:45- 3:00		1	1	2	50.0	0.1	0	7	1	8	12.5	0.3	1
1時間計		4	5	9	55.6	0.5	1	20	2	22	9.1	0.7	3
3:00- 3:15		2	0	2	0.0	0.1	0	4	1	5	20.0	0.2	1
3:15- 3:30		5	0	5	0.0	0.3	0	4	0	4	0.0	0.1	0
3:30- 3:45		0	0	0	0.0	0.0	0	2	0	2	0.0	0.1	1
3:45- 4:00		0	0	0	0.0	0.0	1	4	0	4	0.0	0.1	2
1時間計		7	0	7	0.0	0.4	1	14	1	15	6.7	0.5	4
4:00- 4:15		1	1	2	50.0	0.1	0	7	2	9	22.2	0.3	0
4:15- 4:30		1	2	3	66.7	0.2	0	5	0	5	0.0	0.2	0
4:30- 4:45		1	0	1	0.0	0.1	0	5	0	5	0.0	0.2	1
4:45- 5:00		0	3	3	100.0	0.2	0	2	1	3	33.3	0.1	2
1時間計		3	6	9	66.7	0.5	0	19	3	22	13.6	0.7	3
5:00- 5:15		1	0	1	0.0	0.1	0	5	0	5	0.0	0.2	0
5:15- 5:30		2	0	2	0.0	0.1	0	2	0	2	0.0	0.1	0
5:30- 5:45		7	0	7	0.0	0.4	0	8	0	8	0.0	0.3	1
5:45- 6:00		0	0	0	0.0	0.0	0	10	0	10	0.0	0.3	1
1時間計		10	0	10	0.0	0.6	0	25	0	25	0.0	0.8	2

方向別自動車交通量調査表

調査地点：地域社会6 瀬谷中学校前

調査年月日：令和元年 5月11日(土) 天候：晴れ時々曇り



方向 時間帯	10						11					
	種別 小型車 (台)	大型車 (台)	合計 (台)	大型車 混入率 (%)	時間 係数 (%)	二輪車 (台)	小型車 (台)	大型車 (台)	合計 (台)	大型車 混入率 (%)	時間 係数 (%)	二輪車 (台)
6:00-6:15	8	1	9	11.1	0.5	0	6	1	7	14.3	0.2	2
6:15-6:30	7	0	7	0.0	0.4	0	13	0	13	0.0	0.4	1
6:30-6:45	4	1	5	20.0	0.3	0	11	2	13	15.4	0.4	0
6:45-7:00	6	0	6	0.0	0.4	0	10	0	10	0.0	0.3	3
1時間計	25	2	27	7.4	1.6	0	40	3	43	7.0	1.3	6
7:00-7:15	16	3	19	15.8	1.1	0	14	1	15	6.7	0.5	0
7:15-7:30	8	1	9	11.1	0.5	0	24	2	26	7.7	0.8	1
7:30-7:45	11	2	13	15.4	0.8	0	26	1	27	3.7	0.8	2
7:45-8:00	13	1	14	7.1	0.8	0	26	0	26	0.0	0.8	3
1時間計	48	7	55	12.7	3.3	0	90	4	94	4.3	2.9	6
8:00-8:15	6	0	6	0.0	0.4	0	24	3	27	11.1	0.8	4
8:15-8:30	21	1	22	4.5	1.3	0	29	2	31	6.5	1.0	4
8:30-8:45	17	0	17	0.0	1.0	0	42	5	47	10.6	1.5	3
8:45-9:00	14	2	16	12.5	0.9	0	34	1	35	2.9	1.1	3
1時間計	58	3	61	4.9	3.6	0	129	11	140	7.9	4.4	14
9:00-9:15	26	1	27	3.7	1.6	0	39	3	42	7.1	1.3	2
9:15-9:30	23	0	23	0.0	1.4	1	36	1	37	2.7	1.2	3
9:30-9:45	23	1	24	4.2	1.4	4	48	1	49	2.0	1.5	0
9:45-10:00	36	0	36	0.0	2.1	3	49	1	50	2.0	1.6	3
1時間計	108	2	110	1.8	6.5	8	172	6	178	3.4	5.6	8
10:00-10:15	57	1	58	1.7	3.4	1	68	1	69	1.4	2.2	2
10:15-10:30	25	2	27	7.4	1.6	0	43	3	46	6.5	1.4	5
10:30-10:45	38	0	38	0.0	2.2	1	57	0	57	0.0	1.8	8
10:45-11:00	32	2	34	5.9	2.0	2	53	1	54	1.9	1.7	4
1時間計	152	5	157	3.2	9.3	4	221	5	226	2.2	7.1	19
11:00-11:15	35	2	37	5.4	2.2	1	70	1	71	1.4	2.2	4
11:15-11:30	30	2	32	6.3	1.9	0	36	0	36	0.0	1.1	2
11:30-11:45	34	1	35	2.9	2.1	2	73	2	75	2.7	2.4	4
11:45-12:00	27	2	29	6.9	1.7	1	45	1	46	2.2	1.4	3
1時間計	126	7	133	5.3	7.9	4	224	4	228	1.8	7.1	13
12:00-12:15	24	1	25	4.0	1.5	1	76	2	78	2.6	2.4	2
12:15-12:30	29	3	32	9.4	1.9	2	44	2	46	4.3	1.4	1
12:30-12:45	30	0	30	0.0	1.8	0	42	1	43	2.3	1.3	4
12:45-13:00	26	1	27	3.7	1.6	0	35	3	38	7.9	1.2	3
1時間計	109	5	114	4.4	6.7	3	197	8	205	3.9	6.4	10
13:00-13:15	36	0	36	0.0	2.1	2	67	1	68	1.5	2.1	4
13:15-13:30	27	1	28	3.6	1.7	1	55	2	57	3.5	1.8	4
13:30-13:45	22	2	24	8.3	1.4	0	40	2	42	4.8	1.3	5
13:45-14:00	28	1	29	3.4	1.7	2	57	2	59	3.4	1.8	2
1時間計	113	4	117	3.4	6.9	5	219	7	226	3.1	7.1	15

方向別自動車交通量調査表

調査地点：地域社会6 瀬谷中学校前

調査年月日：令和元年 5月11日(土) 天候：晴れ時々曇り



方向 種別 時間帯	10						11					
	小型車 (台)	大型車 (台)	合計 (台)	大型車 混入率 (%)	時間 係数 (%)	二輪車 (台)	小型車 (台)	大型車 (台)	合計 (台)	大型車 混入率 (%)	時間 係数 (%)	二輪車 (台)
14:00-14:15	31	1	32	3.1	1.9	0	57	0	57	0.0	1.8	6
14:15-14:30	20	0	20	0.0	1.2	0	56	1	57	1.8	1.8	4
14:30-14:45	47	1	48	2.1	2.8	1	40	3	43	7.0	1.3	6
14:45-15:00	27	2	29	6.9	1.7	0	43	3	46	6.5	1.4	1
1時間計	125	4	129	3.1	7.6	1	196	7	203	3.4	6.4	17
15:00-15:15	24	0	24	0.0	1.4	0	55	0	55	0.0	1.7	4
15:15-15:30	20	1	21	4.8	1.2	1	50	1	51	2.0	1.6	2
15:30-15:45	26	0	26	0.0	1.5	0	48	1	49	2.0	1.5	1
15:45-16:00	27	1	28	3.6	1.7	0	61	1	62	1.6	1.9	3
1時間計	97	2	99	2.0	5.9	1	214	3	217	1.4	6.8	10
16:00-16:15	36	1	37	2.7	2.2	0	83	0	83	0.0	2.6	1
16:15-16:30	18	0	18	0.0	1.1	3	53	0	53	0.0	1.7	0
16:30-16:45	20	1	21	4.8	1.2	0	61	3	64	4.7	2.0	3
16:45-17:00	37	0	37	0.0	2.2	2	78	2	80	2.5	2.5	4
1時間計	111	2	113	1.8	6.7	5	275	5	280	1.8	8.8	8
17:00-17:15	32	2	34	5.9	2.0	1	46	0	46	0.0	1.4	2
17:15-17:30	26	1	27	3.7	1.6	0	45	1	46	2.2	1.4	3
17:30-17:45	30	0	30	0.0	1.8	1	44	1	45	2.2	1.4	1
17:45-18:00	17	1	18	5.6	1.1	1	60	1	61	1.6	1.9	6
1時間計	105	4	109	3.7	6.4	3	195	3	198	1.5	6.2	12
18:00-18:15	35	0	35	0.0	2.1	0	67	1	68	1.5	2.1	4
18:15-18:30	30	1	31	3.2	1.8	1	57	1	58	1.7	1.8	3
18:30-18:45	24	1	25	4.0	1.5	3	48	3	51	5.9	1.6	1
18:45-19:00	29	0	29	0.0	1.7	0	48	2	50	4.0	1.6	3
1時間計	118	2	120	1.7	7.1	4	220	7	227	3.1	7.1	11
19:00-19:15	18	1	19	5.3	1.1	0	23	0	23	0.0	0.7	0
19:15-19:30	11	0	11	0.0	0.7	2	26	1	27	3.7	0.8	5
19:30-19:45	29	1	30	3.3	1.8	0	41	2	43	4.7	1.3	6
19:45-20:00	24	1	25	4.0	1.5	0	33	1	34	2.9	1.1	1
1時間計	82	3	85	3.5	5.0	2	123	4	127	3.1	4.0	12
20:00-20:15	13	0	13	0.0	0.8	1	41	0	41	0.0	1.3	1
20:15-20:30	10	2	12	16.7	0.7	0	37	2	39	5.1	1.2	0
20:30-20:45	19	0	19	0.0	1.1	2	43	3	46	6.5	1.4	3
20:45-21:00	12	2	14	14.3	0.8	0	37	2	39	5.1	1.2	4
1時間計	54	4	58	6.9	3.4	3	158	7	165	4.2	5.2	8
21:00-21:15	14	2	16	12.5	0.9	0	26	2	28	7.1	0.9	6
21:15-21:30	19	1	20	5.0	1.2	1	29	1	30	3.3	0.9	4
21:30-21:45	6	1	7	14.3	0.4	0	27	1	28	3.6	0.9	3
21:45-22:00	6	0	6	0.0	0.4	0	27	0	27	0.0	0.8	2
1時間計	45	4	49	8.2	2.9	1	109	4	113	3.5	3.5	15
昼12時間計	1270	47	1317	3.6	77.8	38	2352	70	2422	2.9	75.9	143
夜12時間計	346	29	375	7.7	22.2	14	740	28	768	3.6	24.1	72
全時間合計	1616	76	1692	4.5	100.0	52	3092	98	3190	3.1	100.0	215
昼 夜 率	1.27	1.62	1.28	-	-	1.37	1.31	1.40	1.32	-	-	1.50

方向別自動車交通量調査表

調査地点：地域社会6 瀬谷中学校前

調査年月日：令和元年 5月11日(土) 天候：晴れ時々曇り



方向	12						D 合計 (10+11+12)					
	小型車 (台)	大型車 (台)	合計 (台)	大型車 混入率 (%)	時間 係数 (%)	二輪車 (台)	小型車 (台)	大型車 (台)	合計 (台)	大型車 混入率 (%)	時間 係数 (%)	二輪車 (台)
22:00-22:15	17	0	17	0.0	1.1	1	61	2	63	3.2	1.0	3
22:15-22:30	13	2	15	13.3	1.0	2	64	2	66	3.0	1.0	5
22:30-22:45	16	0	16	0.0	1.1	0	41	0	41	0.0	0.6	0
22:45-23:00	8	0	8	0.0	0.5	1	34	0	34	0.0	0.5	2
1時間計	54	2	56	3.6	3.7	4	200	4	204	2.0	3.2	10
23:00-23:15	4	0	4	0.0	0.3	3	50	1	51	2.0	0.8	6
23:15-23:30	7	1	8	12.5	0.5	1	24	2	26	7.7	0.4	4
23:30-23:45	6	1	7	14.3	0.5	0	26	2	28	7.1	0.4	2
23:45-24:00	2	0	2	0.0	0.1	1	16	0	16	0.0	0.3	2
1時間計	19	2	21	9.5	1.4	5	116	5	121	4.1	1.9	14
0:00-0:15	5	0	5	0.0	0.3	1	17	1	18	5.6	0.3	1
0:15-0:30	3	0	3	0.0	0.2	0	20	0	20	0.0	0.3	0
0:30-0:45	6	0	6	0.0	0.4	1	16	0	16	0.0	0.3	2
0:45-1:00	4	0	4	0.0	0.3	1	16	0	16	0.0	0.3	2
1時間計	18	0	18	0.0	1.2	3	69	1	70	1.4	1.1	5
1:00-1:15	1	1	2	50.0	0.1	1	17	2	19	10.5	0.3	1
1:15-1:30	0	0	0	0.0	0.0	0	18	0	18	0.0	0.3	2
1:30-1:45	3	0	3	0.0	0.2	0	13	2	15	13.3	0.2	4
1:45-2:00	2	0	2	0.0	0.1	0	12	0	12	0.0	0.2	2
1時間計	6	1	7	14.3	0.5	1	60	4	64	6.3	1.0	9
2:00-2:15	0	0	0	0.0	0.0	0	6	2	8	25.0	0.1	0
2:15-2:30	1	1	2	50.0	0.1	1	5	2	7	28.6	0.1	2
2:30-2:45	1	0	1	0.0	0.1	0	7	2	9	22.2	0.1	2
2:45-3:00	1	0	1	0.0	0.1	0	9	2	11	18.2	0.2	1
1時間計	3	1	4	25.0	0.3	1	27	8	35	22.9	0.5	5
3:00-3:15	1	0	1	0.0	0.1	0	7	1	8	12.5	0.1	1
3:15-3:30	0	1	1	100.0	0.1	1	9	1	10	10.0	0.2	1
3:30-3:45	1	0	1	0.0	0.1	0	3	0	3	0.0	0.0	1
3:45-4:00	1	0	1	0.0	0.1	1	5	0	5	0.0	0.1	4
1時間計	3	1	4	25.0	0.3	2	24	2	26	7.7	0.4	7
4:00-4:15	0	0	0	0.0	0.0	0	8	3	11	27.3	0.2	0
4:15-4:30	2	0	2	0.0	0.1	1	8	2	10	20.0	0.2	1
4:30-4:45	1	0	1	0.0	0.1	0	7	0	7	0.0	0.1	1
4:45-5:00	3	0	3	0.0	0.2	0	5	4	9	44.4	0.1	2
1時間計	6	0	6	0.0	0.4	1	28	9	37	24.3	0.6	4
5:00-5:15	1	0	1	0.0	0.1	1	7	0	7	0.0	0.1	1
5:15-5:30	4	0	4	0.0	0.3	0	8	0	8	0.0	0.1	0
5:30-5:45	6	0	6	0.0	0.4	0	21	0	21	0.0	0.3	1
5:45-6:00	5	0	5	0.0	0.3	0	15	0	15	0.0	0.2	1
1時間計	16	0	16	0.0	1.1	1	51	0	51	0.0	0.8	3

方向別自動車交通量調査表

調査地点 : 地域社会6 瀬谷中学校前

調査年月日 : 令和元年 5月11日(土) 天候:晴れ時々曇り



方向 時間帯	12						D 合計 (10+11+12)					
	種別 小型車 (台)	大型車 (台)	合計 (台)	大型車 混入率 (%)	時間 係数 (%)	二輪車 (台)	小型車 (台)	大型車 (台)	合計 (台)	大型車 混入率 (%)	時間 係数 (%)	二輪車 (台)
6:00-6:15	13	1	14	7.1	0.9	0	27	3	30	10.0	0.5	2
6:15-6:30	8	0	8	0.0	0.5	0	28	0	28	0.0	0.4	1
6:30-6:45	10	1	11	9.1	0.7	1	25	4	29	13.8	0.5	1
6:45-7:00	13	1	14	7.1	0.9	0	29	1	30	3.3	0.5	3
1時間計	44	3	47	6.4	3.1	1	109	8	117	6.8	1.8	7
7:00-7:15	8	1	9	11.1	0.6	0	38	5	43	11.6	0.7	0
7:15-7:30	20	1	21	4.8	1.4	1	52	4	56	7.1	0.9	2
7:30-7:45	12	1	13	7.7	0.9	0	49	4	53	7.5	0.8	2
7:45-8:00	10	1	11	9.1	0.7	1	49	2	51	3.9	0.8	4
1時間計	50	4	54	7.4	3.6	2	188	15	203	7.4	3.2	8
8:00-8:15	23	0	23	0.0	1.5	1	53	3	56	5.4	0.9	5
8:15-8:30	15	5	20	25.0	1.3	2	65	8	73	11.0	1.1	6
8:30-8:45	14	0	14	0.0	0.9	2	73	5	78	6.4	1.2	5
8:45-9:00	18	1	19	5.3	1.3	1	66	4	70	5.7	1.1	4
1時間計	70	6	76	7.9	5.0	6	257	20	277	7.2	4.3	20
9:00-9:15	16	2	18	11.1	1.2	2	81	6	87	6.9	1.4	4
9:15-9:30	12	0	12	0.0	0.8	1	71	1	72	1.4	1.1	5
9:30-9:45	22	1	23	4.3	1.5	1	93	3	96	3.1	1.5	5
9:45-10:00	35	1	36	2.8	2.4	0	120	2	122	1.6	1.9	6
1時間計	85	4	89	4.5	5.9	4	365	12	377	3.2	5.9	20
10:00-10:15	36	0	36	0.0	2.4	0	161	2	163	1.2	2.5	3
10:15-10:30	18	0	18	0.0	1.2	0	86	5	91	5.5	1.4	5
10:30-10:45	25	0	25	0.0	1.7	1	120	0	120	0.0	1.9	10
10:45-11:00	22	0	22	0.0	1.5	1	107	3	110	2.7	1.7	7
1時間計	101	0	101	0.0	6.7	2	474	10	484	2.1	7.6	25
11:00-11:15	26	0	26	0.0	1.7	5	131	3	134	2.2	2.1	10
11:15-11:30	15	1	16	6.3	1.1	2	81	3	84	3.6	1.3	4
11:30-11:45	34	2	36	5.6	2.4	3	141	5	146	3.4	2.3	9
11:45-12:00	18	0	18	0.0	1.2	0	90	3	93	3.2	1.5	4
1時間計	93	3	96	3.1	6.4	10	443	14	457	3.1	7.1	27
12:00-12:15	31	0	31	0.0	2.1	2	131	3	134	2.2	2.1	5
12:15-12:30	20	0	20	0.0	1.3	1	93	5	98	5.1	1.5	4
12:30-12:45	33	0	33	0.0	2.2	1	105	1	106	0.9	1.7	5
12:45-13:00	27	1	28	3.6	1.9	1	88	5	93	5.4	1.5	4
1時間計	111	1	112	0.9	7.4	5	417	14	431	3.2	6.7	18
13:00-13:15	39	1	40	2.5	2.6	0	142	2	144	1.4	2.3	6
13:15-13:30	23	0	23	0.0	1.5	0	105	3	108	2.8	1.7	5
13:30-13:45	22	0	22	0.0	1.5	0	84	4	88	4.5	1.4	5
13:45-14:00	19	0	19	0.0	1.3	5	104	3	107	2.8	1.7	9
1時間計	103	1	104	1.0	6.9	5	435	12	447	2.7	7.0	25

方向別自動車交通量調査表

調査地点：地域社会6 瀬谷中学校前

調査年月日：令和元年 5月11日(土) 天候：晴れ時々曇り



方向 種別 時間帯	12						D 合計 (10+11+12)					
	小型車 (台)	大型車 (台)	合計 (台)	大型車 混入率 (%)	時係 数 (%)	二輪車 (台)	小型車 (台)	大型車 (台)	合計 (台)	大型車 混入率 (%)	時係 数 (%)	二輪車 (台)
14:00-14:15	32	0	32	0.0	2.1	0	120	1	121	0.8	1.9	6
14:15-14:30	24	1	25	4.0	1.7	0	100	2	102	2.0	1.6	4
14:30-14:45	24	0	24	0.0	1.6	0	111	4	115	3.5	1.8	7
14:45-15:00	21	0	21	0.0	1.4	0	91	5	96	5.2	1.5	1
1時間計	101	1	102	1.0	6.8	0	422	12	434	2.8	6.8	18
15:00-15:15	11	2	13	15.4	0.9	1	90	2	92	2.2	1.4	5
15:15-15:30	17	0	17	0.0	1.1	2	87	2	89	2.2	1.4	5
15:30-15:45	19	1	20	5.0	1.3	0	93	2	95	2.1	1.5	1
15:45-16:00	30	0	30	0.0	2.0	1	118	2	120	1.7	1.9	4
1時間計	77	3	80	3.8	5.3	4	388	8	396	2.0	6.2	15
16:00-16:15	26	0	26	0.0	1.7	2	145	1	146	0.7	2.3	3
16:15-16:30	30	0	30	0.0	2.0	3	101	0	101	0.0	1.6	6
16:30-16:45	25	1	26	3.8	1.7	0	106	5	111	4.5	1.7	3
16:45-17:00	15	0	15	0.0	1.0	4	130	2	132	1.5	2.1	10
1時間計	96	1	97	1.0	6.4	9	482	8	490	1.6	7.7	22
17:00-17:15	21	0	21	0.0	1.4	2	99	2	101	2.0	1.6	5
17:15-17:30	25	1	26	3.8	1.7	2	96	3	99	3.0	1.5	5
17:30-17:45	31	0	31	0.0	2.1	1	105	1	106	0.9	1.7	3
17:45-18:00	23	0	23	0.0	1.5	0	100	2	102	2.0	1.6	7
1時間計	100	1	101	1.0	6.7	5	400	8	408	2.0	6.4	20
18:00-18:15	45	3	48	6.3	3.2	2	147	4	151	2.6	2.4	6
18:15-18:30	26	1	27	3.7	1.8	4	113	3	116	2.6	1.8	8
18:30-18:45	24	2	26	7.7	1.7	1	96	6	102	5.9	1.6	5
18:45-19:00	34	0	34	0.0	2.3	1	111	2	113	1.8	1.8	4
1時間計	129	6	135	4.4	8.9	8	467	15	482	3.1	7.5	23
19:00-19:15	19	0	19	0.0	1.3	0	60	1	61	1.6	1.0	0
19:15-19:30	14	1	15	6.7	1.0	2	51	2	53	3.8	0.8	9
19:30-19:45	17	0	17	0.0	1.1	3	87	3	90	3.3	1.4	9
19:45-20:00	19	0	19	0.0	1.3	1	76	2	78	2.6	1.2	2
1時間計	69	1	70	1.4	4.6	6	274	8	282	2.8	4.4	20
20:00-20:15	17	0	17	0.0	1.1	0	71	0	71	0.0	1.1	2
20:15-20:30	14	2	16	12.5	1.1	2	61	6	67	9.0	1.0	2
20:30-20:45	24	0	24	0.0	1.6	1	86	3	89	3.4	1.4	6
20:45-21:00	14	1	15	6.7	1.0	2	63	5	68	7.4	1.1	6
1時間計	69	3	72	4.2	4.8	5	281	14	295	4.7	4.6	16
21:00-21:15	13	0	13	0.0	0.9	0	53	4	57	7.0	0.9	6
21:15-21:30	11	1	12	8.3	0.8	1	59	3	62	4.8	1.0	6
21:30-21:45	11	0	11	0.0	0.7	1	44	2	46	4.3	0.7	4
21:45-22:00	6	1	7	14.3	0.5	2	39	1	40	2.5	0.6	4
1時間計	41	2	43	4.7	2.8	4	195	10	205	4.9	3.2	20
昼12時間計	1116	31	1147	2.7	75.9	60	4738	148	4886	3.0	76.4	241
夜12時間計	348	16	364	4.4	24.1	34	1434	73	1507	4.8	23.6	120
全時間合計	1464	47	1511	3.1	100.0	94	6172	221	6393	3.5	100.0	361
昼夜率	1.31	1.52	1.32	-	-	1.57	1.30	1.49	1.31	-	-	1.50

交差点合計自動車交通量調査表

調査地点 : 地域社会1 目黒

調査年月日 : 令和元年 5月11日(土) 天候:晴れ時々曇り

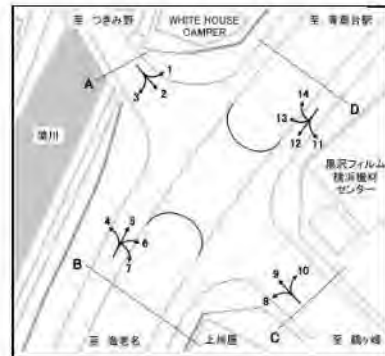

方向 時間帯	交差点合計(1+2+3+4+5+6+7+8+9+10+11+12+13+14)											
	種別 小型車 (台)	大型車 (台)	合計 (台)	大型車 混入率 (%)	時間 係数 (%)	二輪車 (台)	小型車 (台)	大型車 (台)	合計 (台)	大型車 混入率 (%)	時間 係数 (%)	二輪車 (台)
22:00-22:15	386	52	438	11.9	1.3	21						
22:15-22:30	288	31	319	9.7	1.0	19						
22:30-22:45	234	37	271	13.7	0.8	17						
22:45-23:00	237	49	286	17.1	0.9	17						
23:00-23:15	233	48	281	17.1	0.9	16						
23:15-23:30	139	32	171	18.7	0.5	12						
23:30-23:45	141	33	174	19.0	0.5	7						
23:45-24:00	125	48	173	27.7	0.5	15						
0:00-0:15	123	40	163	24.5	0.5	8						
0:15-0:30	116	39	155	25.2	0.5	7						
0:30-0:45	106	31	137	22.6	0.4	6						
0:45-1:00	93	44	137	32.1	0.4	5						
1:00-1:15	126	65	191	34.0	0.6	15						
1:15-1:30	73	34	107	31.8	0.3	3						
1:30-1:45	80	36	116	31.0	0.4	2						
1:45-2:00	58	25	83	30.1	0.3	2						
2:00-2:15	72	44	116	37.9	0.4	3						
2:15-2:30	67	47	114	41.2	0.3	6						
2:30-2:45	68	41	109	37.6	0.3	5						
2:45-3:00	66	45	111	40.5	0.3	4						
3:00-3:15	58	43	101	42.6	0.3	4						
3:15-3:30	45	44	89	49.4	0.3	2						
3:30-3:45	60	43	103	41.7	0.3	1						
3:45-4:00	50	36	86	41.9	0.3	3						
4:00-4:15	51	43	94	45.7	0.3	5						
4:15-4:30	55	34	89	38.2	0.3	4						
4:30-4:45	41	38	79	48.1	0.2	9						
4:45-5:00	57	26	83	31.3	0.3	6						
5:00-5:15	88	44	132	33.3	0.4	5						
5:15-5:30	104	44	148	29.7	0.4	13						
5:30-5:45	99	53	152	34.9	0.5	10						
5:45-6:00	108	33	141	23.4	0.4	5						
6:00-6:15	131	37	168	22.0	0.5	10						
6:15-6:30	145	42	187	22.5	0.6	17						
6:30-6:45	163	41	204	20.1	0.6	17						
6:45-7:00	187	33	220	15.0	0.7	16						
7:00-7:15	200	46	246	18.7	0.7	20						
7:15-7:30	227	44	271	16.2	0.8	23						
7:30-7:45	281	51	332	15.4	1.0	29						
7:45-8:00	254	40	294	13.6	0.9	21						
8:00-8:15	351	42	393	10.7	1.2	35						
8:15-8:30	350	34	384	8.9	1.2	30						
8:30-8:45	371	51	422	12.1	1.3	18						
8:45-9:00	373	36	409	8.8	1.2	32						
9:00-9:15	357	30	387	7.8	1.2	21						
9:15-9:30	384	45	429	10.5	1.3	32						
9:30-9:45	417	43	460	9.3	1.4	20						
9:45-10:00	429	47	476	9.9	1.4	19						

交差点合計自動車交通量調査表

調査地点 : 地域社会1 目黒

調査年月日 : 令和元年 5月11日(土) 天候:晴れ時々曇り

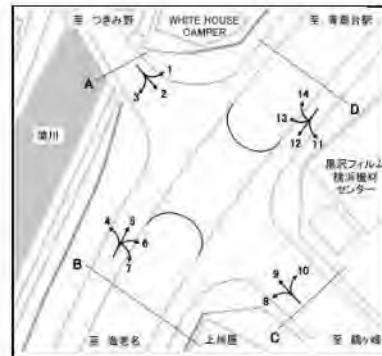

方向 時間帯	交差点合計(1+2+3+4+5+6+7+8+9+10+11+12+13+14)											
	種別 小型車 (台)	大型車 (台)	合計 (台)	大型車 混入率 (%)	時間 係数 (%)	二輪車 (台)	小型車 (台)	大型車 (台)	合計 (台)	大型車 混入率 (%)	時間 係数 (%)	二輪車 (台)
10:00-10:15	525	53	578	9.2	1.7	26						
10:15-10:30	461	32	493	6.5	1.5	25						
10:30-10:45	474	41	515	8.0	1.6	26						
10:45-11:00	473	38	511	7.4	1.5	16						
11:00-11:15	467	36	503	7.2	1.5	29						
11:15-11:30	442	45	487	9.2	1.5	26						
11:30-11:45	542	41	583	7.0	1.8	38						
11:45-12:00	418	39	457	8.5	1.4	25						
12:00-12:15	448	36	484	7.4	1.5	18						
12:15-12:30	485	39	524	7.4	1.6	27						
12:30-12:45	446	44	490	9.0	1.5	18						
12:45-13:00	399	51	450	11.3	1.4	22						
13:00-13:15	498	35	533	6.6	1.6	26						
13:15-13:30	488	40	528	7.6	1.6	23						
13:30-13:45	417	32	449	7.1	1.4	24						
13:45-14:00	458	40	498	8.0	1.5	33						
14:00-14:15	489	60	549	10.9	1.7	35						
14:15-14:30	441	23	464	5.0	1.4	23						
14:30-14:45	471	32	503	6.4	1.5	32						
14:45-15:00	457	20	477	4.2	1.4	29						
15:00-15:15	466	32	498	6.4	1.5	24						
15:15-15:30	487	43	530	8.1	1.6	33						
15:30-15:45	479	26	505	5.1	1.5	23						
15:45-16:00	448	29	477	6.1	1.4	28						
16:00-16:15	494	35	529	6.6	1.6	27						
16:15-16:30	511	31	542	5.7	1.6	15						
16:30-16:45	436	38	474	8.0	1.4	25						
16:45-17:00	511	31	542	5.7	1.6	24						
17:00-17:15	474	44	518	8.5	1.6	21						
17:15-17:30	498	41	539	7.6	1.6	16						
17:30-17:45	533	27	560	4.8	1.7	44						
17:45-18:00	447	31	478	6.5	1.4	27						
18:00-18:15	424	36	460	7.8	1.4	22						
18:15-18:30	467	47	514	9.1	1.6	21						
18:30-18:45	458	51	509	10.0	1.5	18						
18:45-19:00	443	39	482	8.1	1.5	20						
19:00-19:15	439	45	484	9.3	1.5	20						
19:15-19:30	458	41	499	8.2	1.5	33						
19:30-19:45	387	31	418	7.4	1.3	18						
19:45-20:00	410	41	451	9.1	1.4	25						
20:00-20:15	397	39	436	8.9	1.3	16						
20:15-20:30	316	46	362	12.7	1.1	14						
20:30-20:45	301	37	338	10.9	1.0	13						
20:45-21:00	297	40	337	11.9	1.0	12						
21:00-21:15	293	49	342	14.3	1.0	12						
21:15-21:30	283	41	324	12.7	1.0	14						
21:30-21:45	261	41	302	13.6	0.9	21						
21:45-22:00	240	42	282	14.9	0.9	12						
全時間合計	29224	3815	33039	11.5	100.0	1736						

交差点合計自動車交通量調査表

調査地点：地域社会2 目黒交番前

調査年月日：令和元年 5月11日(土) 天候：晴れ時々曇り



方向 時間帯	交差点合計(1+2+3+4+5+6+7+8+9+10+11+12+13+14)											
	種別 小型車 (台)	大型車 (台)	合計 (台)	大型車 混入率 (%)	時間 係数 (%)	二輪車 (台)	小型車 (台)	大型車 (台)	合計 (台)	大型車 混入率 (%)	時間 係数 (%)	二輪車 (台)
22:00-22:15	286	36	322	11.2	1.0	26						
22:15-22:30	247	29	276	10.5	0.8	18						
22:30-22:45	261	28	289	9.7	0.9	17						
22:45-23:00	246	47	293	16.0	0.9	12						
23:00-23:15	185	38	223	17.0	0.7	17						
23:15-23:30	148	32	180	17.8	0.5	9						
23:30-23:45	145	33	178	18.5	0.5	11						
23:45-24:00	132	24	156	15.4	0.5	10						
0:00-0:15	119	30	149	20.1	0.4	6						
0:15-0:30	103	27	130	20.8	0.4	7						
0:30-0:45	107	27	134	20.1	0.4	8						
0:45-1:00	80	39	119	32.8	0.4	2						
1:00-1:15	85	36	121	29.8	0.4	4						
1:15-1:30	59	33	92	35.9	0.3	4						
1:30-1:45	69	30	99	30.3	0.3	1						
1:45-2:00	53	20	73	27.4	0.2	6						
2:00-2:15	61	28	89	31.5	0.3	4						
2:15-2:30	48	33	81	40.7	0.2	3						
2:30-2:45	69	30	99	30.3	0.3	7						
2:45-3:00	56	24	80	30.0	0.2	1						
3:00-3:15	44	28	72	38.9	0.2	4						
3:15-3:30	52	41	93	44.1	0.3	4						
3:30-3:45	58	27	85	31.8	0.3	3						
3:45-4:00	57	22	79	27.8	0.2	2						
4:00-4:15	46	25	71	35.2	0.2	7						
4:15-4:30	65	33	98	33.7	0.3	5						
4:30-4:45	70	32	102	31.4	0.3	5						
4:45-5:00	65	31	96	32.3	0.3	14						
5:00-5:15	104	36	140	25.7	0.4	8						
5:15-5:30	103	26	129	20.2	0.4	7						
5:30-5:45	111	53	164	32.3	0.5	13						
5:45-6:00	132	36	168	21.4	0.5	13						
6:00-6:15	159	33	192	17.2	0.6	8						
6:15-6:30	189	31	220	14.1	0.7	12						
6:30-6:45	214	40	254	15.7	0.8	21						
6:45-7:00	214	34	248	13.7	0.7	16						
7:00-7:15	275	48	323	14.9	1.0	26						
7:15-7:30	298	44	342	12.9	1.0	23						
7:30-7:45	294	51	345	14.8	1.0	26						
7:45-8:00	319	37	356	10.4	1.1	22						
8:00-8:15	410	40	450	8.9	1.3	35						
8:15-8:30	369	57	426	13.4	1.3	43						
8:30-8:45	420	57	477	11.9	1.4	38						
8:45-9:00	444	44	488	9.0	1.5	26						
9:00-9:15	405	45	450	10.0	1.3	28						
9:15-9:30	411	50	461	10.8	1.4	31						
9:30-9:45	431	46	477	9.6	1.4	35						
9:45-10:00	448	47	495	9.5	1.5	20						

交差点合計自動車交通量調査表

調査地点：地域社会2 目黒交番前

調査年月日：令和元年 5月11日(土) 天候：晴れ時々曇り



方向 時間帯	交差点合計(1+2+3+4+5+6+7+8+9+10+11+12+13+14)											
	種別 小型車 (台)	大型車 (台)	合計 (台)	大型車 混入率 (%)	時間 係数 (%)	二輪車 (台)	小型車 (台)	大型車 (台)	合計 (台)	大型車 混入率 (%)	時間 係数 (%)	二輪車 (台)
10:00-10:15	454	48	502	9.6	1.5	19						
10:15-10:30	455	36	491	7.3	1.5	30						
10:30-10:45	510	35	545	6.4	1.6	24						
10:45-11:00	468	37	505	7.3	1.5	31						
11:00-11:15	495	36	531	6.8	1.6	32						
11:15-11:30	452	37	489	7.6	1.5	37						
11:30-11:45	459	38	497	7.6	1.5	35						
11:45-12:00	466	32	498	6.4	1.5	21						
12:00-12:15	469	38	507	7.5	1.5	30						
12:15-12:30	414	35	449	7.8	1.3	15						
12:30-12:45	449	47	496	9.5	1.5	25						
12:45-13:00	475	33	508	6.5	1.5	26						
13:00-13:15	463	24	487	4.9	1.5	27						
13:15-13:30	466	28	494	5.7	1.5	20						
13:30-13:45	516	40	556	7.2	1.7	34						
13:45-14:00	490	30	520	5.8	1.6	38						
14:00-14:15	505	46	551	8.3	1.6	22						
14:15-14:30	444	21	465	4.5	1.4	26						
14:30-14:45	498	31	529	5.9	1.6	27						
14:45-15:00	510	35	545	6.4	1.6	20						
15:00-15:15	441	25	466	5.4	1.4	23						
15:15-15:30	541	40	581	6.9	1.7	37						
15:30-15:45	494	31	525	5.9	1.6	33						
15:45-16:00	558	31	589	5.3	1.8	32						
16:00-16:15	482	29	511	5.7	1.5	30						
16:15-16:30	486	35	521	6.7	1.6	29						
16:30-16:45	524	32	556	5.8	1.7	35						
16:45-17:00	526	32	558	5.7	1.7	35						
17:00-17:15	510	38	548	6.9	1.6	34						
17:15-17:30	498	53	551	9.6	1.6	28						
17:30-17:45	530	31	561	5.5	1.7	31						
17:45-18:00	475	28	503	5.6	1.5	28						
18:00-18:15	496	29	525	5.5	1.6	32						
18:15-18:30	414	46	460	10.0	1.4	16						
18:30-18:45	496	43	539	8.0	1.6	26						
18:45-19:00	428	38	466	8.2	1.4	15						
19:00-19:15	375	48	423	11.3	1.3	25						
19:15-19:30	403	41	444	9.2	1.3	24						
19:30-19:45	378	33	411	8.0	1.2	18						
19:45-20:00	369	30	399	7.5	1.2	21						
20:00-20:15	316	32	348	9.2	1.0	17						
20:15-20:30	300	35	335	10.4	1.0	14						
20:30-20:45	330	38	368	10.3	1.1	19						
20:45-21:00	279	32	311	10.3	0.9	17						
21:00-21:15	327	43	370	11.6	1.1	18						
21:15-21:30	299	36	335	10.7	1.0	20						
21:30-21:45	275	43	318	13.5	1.0	18						
21:45-22:00	227	42	269	15.6	0.8	8						
全時間合計	30001	3439	33440	10.3	100.0	1890						

交差点合計自動車交通量調査表

調査地点 : 地域社会3 上川井IC

調査年月日 : 令和元年 5月11日(土) 天候:晴れ時々曇り

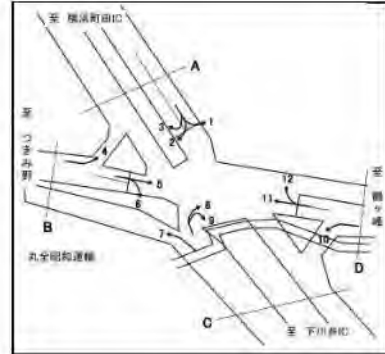

方向 時間帯	交差点合計(1+2+3+4+5+6+7+8+9+10+11+12)											
	種別 小型車 (台)	大型車 (台)	合計 (台)	大型車 混入率 (%)	時間 係数 (%)	二輪車 (台)	小型車 (台)	大型車 (台)	合計 (台)	大型車 混入率 (%)	時間 係数 (%)	二輪車 (台)
22:00-22:15	181	25	206	12.1	0.8	15						
22:15-22:30	157	16	173	9.2	0.7	15						
22:30-22:45	177	22	199	11.1	0.8	13						
22:45-23:00	190	36	226	15.9	0.9	15						
23:00-23:15	140	24	164	14.6	0.6	13						
23:15-23:30	110	24	134	17.9	0.5	7						
23:30-23:45	124	25	149	16.8	0.6	5						
23:45-24:00	86	24	110	21.8	0.4	10						
0:00-0:15	100	26	126	20.6	0.5	8						
0:15-0:30	87	19	106	17.9	0.4	6						
0:30-0:45	84	22	106	20.8	0.4	7						
0:45-1:00	62	35	97	36.1	0.4	2						
1:00-1:15	69	37	106	34.9	0.4	6						
1:15-1:30	48	27	75	36.0	0.3	1						
1:30-1:45	43	24	67	35.8	0.3	1						
1:45-2:00	55	21	76	27.6	0.3	3						
2:00-2:15	52	27	79	34.2	0.3	2						
2:15-2:30	42	28	70	40.0	0.3	3						
2:30-2:45	59	29	88	33.0	0.3	6						
2:45-3:00	57	24	81	29.6	0.3	2						
3:00-3:15	33	27	60	45.0	0.2	4						
3:15-3:30	44	28	72	38.9	0.3	1						
3:30-3:45	49	27	76	35.5	0.3	2						
3:45-4:00	30	25	55	45.5	0.2	6						
4:00-4:15	42	23	65	35.4	0.3	9						
4:15-4:30	52	31	83	37.3	0.3	5						
4:30-4:45	57	32	89	36.0	0.3	4						
4:45-5:00	62	20	82	24.4	0.3	8						
5:00-5:15	99	36	135	26.7	0.5	9						
5:15-5:30	84	29	113	25.7	0.4	9						
5:30-5:45	86	41	127	32.3	0.5	20						
5:45-6:00	102	30	132	22.7	0.5	8						
6:00-6:15	123	31	154	20.1	0.6	5						
6:15-6:30	170	33	203	16.3	0.8	8						
6:30-6:45	166	30	196	15.3	0.8	25						
6:45-7:00	173	37	210	17.6	0.8	14						
7:00-7:15	196	39	235	16.6	0.9	15						
7:15-7:30	208	33	241	13.7	0.9	19						
7:30-7:45	249	39	288	13.5	1.1	21						
7:45-8:00	256	34	290	11.7	1.1	16						
8:00-8:15	322	28	350	8.0	1.4	26						
8:15-8:30	305	41	346	11.8	1.4	27						
8:30-8:45	325	39	364	10.7	1.4	17						
8:45-9:00	320	36	356	10.1	1.4	21						
9:00-9:15	370	31	401	7.7	1.6	22						
9:15-9:30	334	33	367	9.0	1.4	35						
9:30-9:45	351	36	387	9.3	1.5	22						
9:45-10:00	334	40	374	10.7	1.5	16						

交差点合計自動車交通量調査表

調査地点 : 地域社会3 上川井1C

調査年月日 : 令和元年 5月11日(土) 天候:晴れ時々曇り

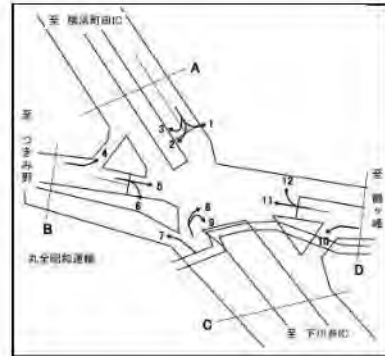

方向 時間帯	交差点合計(1+2+3+4+5+6+7+8+9+10+11+12)											
	種別 小型車 (台)	大型車 (台)	合計 (台)	大型車 混入率 (%)	時間 係数 (%)	二輪車 (台)	小型車 (台)	大型車 (台)	合計 (台)	大型車 混入率 (%)	時間 係数 (%)	二輪車 (台)
10:00-10:15	344	38	382	9.9	1.5	20						
10:15-10:30	421	33	454	7.3	1.8	23						
10:30-10:45	373	33	406	8.1	1.6	22						
10:45-11:00	347	47	394	11.9	1.5	22						
11:00-11:15	343	37	380	9.7	1.5	24						
11:15-11:30	365	34	399	8.5	1.6	24						
11:30-11:45	365	35	400	8.8	1.6	34						
11:45-12:00	318	32	350	9.1	1.4	17						
12:00-12:15	333	40	373	10.7	1.5	20						
12:15-12:30	360	40	400	10.0	1.6	17						
12:30-12:45	361	49	410	12.0	1.6	20						
12:45-13:00	351	31	382	8.1	1.5	23						
13:00-13:15	362	37	399	9.3	1.6	23						
13:15-13:30	340	37	377	9.8	1.5	20						
13:30-13:45	360	35	395	8.9	1.5	27						
13:45-14:00	317	32	349	9.2	1.4	24						
14:00-14:15	389	34	423	8.0	1.7	12						
14:15-14:30	349	34	383	8.9	1.5	23						
14:30-14:45	411	37	448	8.3	1.8	26						
14:45-15:00	366	33	399	8.3	1.6	19						
15:00-15:15	346	25	371	6.7	1.5	17						
15:15-15:30	372	40	412	9.7	1.6	31						
15:30-15:45	367	30	397	7.6	1.6	23						
15:45-16:00	380	35	415	8.4	1.6	31						
16:00-16:15	376	31	407	7.6	1.6	16						
16:15-16:30	334	28	362	7.7	1.4	21						
16:30-16:45	387	31	418	7.4	1.6	30						
16:45-17:00	386	31	417	7.4	1.6	35						
17:00-17:15	403	33	436	7.6	1.7	27						
17:15-17:30	393	36	429	8.4	1.7	20						
17:30-17:45	402	30	432	6.9	1.7	21						
17:45-18:00	360	26	386	6.7	1.5	20						
18:00-18:15	315	20	335	6.0	1.3	14						
18:15-18:30	322	32	354	9.0	1.4	8						
18:30-18:45	299	25	324	7.7	1.3	14						
18:45-19:00	290	35	325	10.8	1.3	9						
19:00-19:15	271	45	316	14.2	1.2	13						
19:15-19:30	257	32	289	11.1	1.1	13						
19:30-19:45	242	29	271	10.7	1.1	14						
19:45-20:00	253	38	291	13.1	1.1	20						
20:00-20:15	280	26	306	8.5	1.2	19						
20:15-20:30	231	39	270	14.4	1.1	12						
20:30-20:45	215	39	254	15.4	1.0	12						
20:45-21:00	204	32	236	13.6	0.9	10						
21:00-21:15	221	27	248	10.9	1.0	8						
21:15-21:30	187	34	221	15.4	0.9	10						
21:30-21:45	199	46	245	18.8	1.0	8						
21:45-22:00	174	29	203	14.3	0.8	5						
全時間合計	22506	3056	25562	12.0	100.0	1455						

交差点合計自動車交通量調査表

調査地点 : 地域社会4 滝沢

調査年月日 : 令和 2年 9月26日(土) 天候:晴れ一時雨



方向 時間帯	交差点合計(1+2+3+4+5+6)					
	種別 小型車 (台)	大型車 (台)	合計 (台)	大型車 混入率 (%)	時間 係数 (%)	二輪車 (台)
22:00-22:15	127	12	139	8.6	0.7	6
22:15-22:30	114	12	126	9.5	0.6	0
22:30-22:45	105	8	113	7.1	0.6	5
22:45-23:00	89	7	96	7.3	0.5	3
1時間計	435	39	474	8.2	2.4	14
23:00-23:15	81	15	96	15.6	0.5	7
23:15-23:30	60	10	70	14.3	0.4	2
23:30-23:45	50	13	63	20.6	0.3	5
23:45-24:00	68	9	77	11.7	0.4	6
1時間計	259	47	306	15.4	1.6	20
0:00- 0:15	66	8	74	10.8	0.4	5
0:15- 0:30	44	7	51	13.7	0.3	3
0:30- 0:45	38	12	50	24.0	0.3	2
0:45- 1:00	40	13	53	24.5	0.3	1
1時間計	188	40	228	17.5	1.2	11
1:00- 1:15	33	13	46	28.3	0.2	1
1:15- 1:30	34	13	47	27.7	0.2	2
1:30- 1:45	26	10	36	27.8	0.2	1
1:45- 2:00	27	10	37	27.0	0.2	4
1時間計	120	46	166	27.7	0.9	8
2:00- 2:15	29	6	35	17.1	0.2	1
2:15- 2:30	25	9	34	26.5	0.2	1
2:30- 2:45	28	6	34	17.6	0.2	0
2:45- 3:00	20	4	24	16.7	0.1	2
1時間計	102	25	127	19.7	0.7	4
3:00- 3:15	22	6	28	21.4	0.1	1
3:15- 3:30	17	4	21	19.0	0.1	1
3:30- 3:45	17	3	20	15.0	0.1	3
3:45- 4:00	23	14	37	37.8	0.2	3
1時間計	79	27	106	25.5	0.5	8
4:00- 4:15	18	5	23	21.7	0.1	0
4:15- 4:30	28	6	34	17.6	0.2	0
4:30- 4:45	25	7	32	21.9	0.2	1
4:45- 5:00	20	7	27	25.9	0.1	8
1時間計	91	25	116	21.6	0.6	9
5:00- 5:15	42	9	51	17.6	0.3	2
5:15- 5:30	43	8	51	15.7	0.3	6
5:30- 5:45	41	10	51	19.6	0.3	3
5:45- 6:00	58	9	67	13.4	0.3	3
1時間計	184	36	220	16.4	1.1	14

交差点合計自動車交通量調査表

調査地点 : 地域社会4 滝沢

調査年月日 : 令和 2年 9月26日(土) 天候:晴れ一時雨



時間帯	方向 種別	交差点合計(1+2+3+4+5+6)					
		小型車 (台)	大型車 (台)	合計 (台)	大型車 混入率 (%)	時間 係数 (%)	二輪車 (台)
6:00-6:15		78	10	88	11.4	0.5	6
6:15-6:30		79	14	93	15.1	0.5	3
6:30-6:45		112	14	126	11.1	0.6	6
6:45-7:00		105	14	119	11.8	0.6	3
1時間計		374	52	426	12.2	2.2	18
7:00-7:15		127	19	146	13.0	0.8	8
7:15-7:30		131	24	155	15.5	0.8	11
7:30-7:45		192	20	212	9.4	1.1	17
7:45-8:00		198	17	215	7.9	1.1	25
1時間計		648	80	728	11.0	3.7	61
8:00-8:15		234	27	261	10.3	1.3	26
8:15-8:30		227	16	243	6.6	1.3	12
8:30-8:45		259	23	282	8.2	1.5	23
8:45-9:00		252	13	265	4.9	1.4	14
1時間計		972	79	1051	7.5	5.4	75
9:00-9:15		253	20	273	7.3	1.4	13
9:15-9:30		229	22	251	8.8	1.3	11
9:30-9:45		253	21	274	7.7	1.4	13
9:45-10:00		283	15	298	5.0	1.5	13
1時間計		1018	78	1096	7.1	5.6	50
10:00-10:15		297	23	320	7.2	1.6	8
10:15-10:30		271	32	303	10.6	1.6	16
10:30-10:45		277	18	295	6.1	1.5	13
10:45-11:00		298	22	320	6.9	1.6	19
1時間計		1143	95	1238	7.7	6.4	56
11:00-11:15		304	16	320	5.0	1.6	15
11:15-11:30		307	17	324	5.2	1.7	18
11:30-11:45		327	15	342	4.4	1.8	14
11:45-12:00		297	14	311	4.5	1.6	15
1時間計		1235	62	1297	4.8	6.7	62
12:00-12:15		334	14	348	4.0	1.8	18
12:15-12:30		311	18	329	5.5	1.7	17
12:30-12:45		342	21	363	5.8	1.9	18
12:45-13:00		315	15	330	4.5	1.7	15
1時間計		1302	68	1370	5.0	7.1	68
13:00-13:15		284	11	295	3.7	1.5	16
13:15-13:30		331	14	345	4.1	1.8	19
13:30-13:45		315	19	334	5.7	1.7	16
13:45-14:00		343	18	361	5.0	1.9	20
1時間計		1273	62	1335	4.6	6.9	71

交差点合計自動車交通量調査表

調査地点 : 地域社会4 滝沢

調査年月日 : 令和 2年 9月26日(土) 天候:晴れ一時雨



時間帯	種別	交差点合計(1+2+3+4+5+6)					
		小型車 (台)	大型車 (台)	合計 (台)	大型車 混入率 (%)	時間 係数 (%)	二輪車 (台)
14:00-14:15		351	28	379	7.4	2.0	23
14:15-14:30		299	14	313	4.5	1.6	18
14:30-14:45		334	13	347	3.7	1.8	24
14:45-15:00		314	9	323	2.8	1.7	21
1時間計		1298	64	1362	4.7	7.0	86
15:00-15:15		360	11	371	3.0	1.9	25
15:15-15:30		307	18	325	5.5	1.7	30
15:30-15:45		325	9	334	2.7	1.7	26
15:45-16:00		334	16	350	4.6	1.8	24
1時間計		1326	54	1380	3.9	7.1	105
16:00-16:15		362	17	379	4.5	2.0	19
16:15-16:30		340	15	355	4.2	1.8	32
16:30-16:45		380	16	396	4.0	2.0	24
16:45-17:00		324	11	335	3.3	1.7	34
1時間計		1406	59	1465	4.0	7.5	109
17:00-17:15		320	24	344	7.0	1.8	17
17:15-17:30		329	12	341	3.5	1.8	13
17:30-17:45		393	18	411	4.4	2.1	21
17:45-18:00		318	6	324	1.9	1.7	23
1時間計		1360	60	1420	4.2	7.3	74
18:00-18:15		332	17	349	4.9	1.8	17
18:15-18:30		309	6	315	1.9	1.6	12
18:30-18:45		297	12	309	3.9	1.6	12
18:45-19:00		280	7	287	2.4	1.5	12
1時間計		1218	42	1260	3.3	6.5	53
19:00-19:15		262	19	281	6.8	1.4	10
19:15-19:30		238	4	242	1.7	1.2	15
19:30-19:45		219	7	226	3.1	1.2	13
19:45-20:00		224	8	232	3.4	1.2	7
1時間計		943	38	981	3.9	5.1	45
20:00-20:15		196	7	203	3.4	1.0	8
20:15-20:30		179	7	186	3.8	1.0	9
20:30-20:45		157	8	165	4.8	0.8	8
20:45-21:00		133	2	135	1.5	0.7	11
1時間計		665	24	689	3.5	3.5	36
21:00-21:15		135	8	143	5.6	0.7	7
21:15-21:30		146	17	163	10.4	0.8	5
21:30-21:45		138	9	147	6.1	0.8	3
21:45-22:00		113	9	122	7.4	0.6	6
1時間計		532	43	575	7.5	3.0	21
昼12時間計		14199	803	15002	5.4	77.3	870
夜12時間計		3972	442	4414	10.0	22.7	208
18時間計		17407	1046	18453	5.7	95.0	1024
全時間合計		18171	1245	19416	6.4	100.0	1078
昼夜率		1.28	1.55	1.29	-	-	1.24

交差点合計自動車交通量調査表

調査地点 : 地域社会4 瀬谷土橋公園入口

調査年月日 : 令和 2年 9月26日(土) 天候:晴れ一時雨



方向 種別 時間帯	交差点合計(1+2+3+4+5+6)					
	小型車 (台)	大型車 (台)	合計 (台)	大型車 混入率 (%)	時間 係数 (%)	二輪車 (台)
22:00-22:15	98	13	111	11.7	0.7	3
22:15-22:30	101	9	110	8.2	0.7	1
22:30-22:45	87	7	94	7.4	0.6	3
22:45-23:00	75	3	78	3.8	0.5	2
1時間計	361	32	393	8.1	2.5	9
23:00-23:15	65	13	78	16.7	0.5	5
23:15-23:30	43	7	50	14.0	0.3	1
23:30-23:45	45	6	51	11.8	0.3	3
23:45-24:00	51	10	61	16.4	0.4	4
1時間計	204	36	240	15.0	1.6	13
0:00- 0:15	58	7	65	10.8	0.4	4
0:15- 0:30	32	6	38	15.8	0.2	2
0:30- 0:45	41	15	56	26.8	0.4	2
0:45- 1:00	19	6	25	24.0	0.2	1
1時間計	150	34	184	18.5	1.2	9
1:00- 1:15	26	13	39	33.3	0.3	1
1:15- 1:30	26	11	37	29.7	0.2	1
1:30- 1:45	24	9	33	27.3	0.2	0
1:45- 2:00	25	6	31	19.4	0.2	1
1時間計	101	39	140	27.9	0.9	3
2:00- 2:15	16	8	24	33.3	0.2	0
2:15- 2:30	18	6	24	25.0	0.2	0
2:30- 2:45	21	6	27	22.2	0.2	0
2:45- 3:00	12	3	15	20.0	0.1	4
1時間計	67	23	90	25.6	0.6	4
3:00- 3:15	15	2	17	11.8	0.1	1
3:15- 3:30	13	4	17	23.5	0.1	1
3:30- 3:45	17	6	23	26.1	0.1	3
3:45- 4:00	17	9	26	34.6	0.2	3
1時間計	62	21	83	25.3	0.5	8
4:00- 4:15	28	4	32	12.5	0.2	0
4:15- 4:30	27	3	30	10.0	0.2	0
4:30- 4:45	16	3	19	15.8	0.1	1
4:45- 5:00	23	6	29	20.7	0.2	3
1時間計	94	16	110	14.5	0.7	4
5:00- 5:15	36	9	45	20.0	0.3	1
5:15- 5:30	36	6	42	14.3	0.3	3
5:30- 5:45	35	9	44	20.5	0.3	2
5:45- 6:00	53	6	59	10.2	0.4	0
1時間計	160	30	190	15.8	1.2	6

交差点合計自動車交通量調査表

調査地点：地域社会4 瀬谷土橋公園入口

調査年月日：令和 2年 9月26日(土) 天候：晴れ一時雨



時間帯	方向 種別	交差点合計(1+2+3+4+5+6)					
		小型車 (台)	大型車 (台)	合計 (台)	大型車 混入率 (%)	時間 係数 (%)	二輪車 (台)
6:00-6:15		71	8	79	10.1	0.5	6
6:15-6:30		66	12	78	15.4	0.5	3
6:30-6:45		93	13	106	12.3	0.7	4
6:45-7:00		86	11	97	11.3	0.6	4
1時間計		316	44	360	12.2	2.3	17
7:00-7:15		102	13	115	11.3	0.7	5
7:15-7:30		123	17	140	12.1	0.9	7
7:30-7:45		163	22	185	11.9	1.2	16
7:45-8:00		172	17	189	9.0	1.2	20
1時間計		560	69	629	11.0	4.1	48
8:00-8:15		202	21	223	9.4	1.4	23
8:15-8:30		196	16	212	7.5	1.4	8
8:30-8:45		220	19	239	7.9	1.5	19
8:45-9:00		182	8	190	4.2	1.2	14
1時間計		800	64	864	7.4	5.6	64
9:00-9:15		205	26	231	11.3	1.5	13
9:15-9:30		202	15	217	6.9	1.4	12
9:30-9:45		217	18	235	7.7	1.5	11
9:45-10:00		229	16	245	6.5	1.6	10
1時間計		853	75	928	8.1	6.0	46
10:00-10:15		237	11	248	4.4	1.6	13
10:15-10:30		204	21	225	9.3	1.5	16
10:30-10:45		225	20	245	8.2	1.6	11
10:45-11:00		222	12	234	5.1	1.5	16
1時間計		888	64	952	6.7	6.2	56
11:00-11:15		245	13	258	5.0	1.7	16
11:15-11:30		238	14	252	5.6	1.6	16
11:30-11:45		252	8	260	3.1	1.7	10
11:45-12:00		210	8	218	3.7	1.4	17
1時間計		945	43	988	4.4	6.4	59
12:00-12:15		280	16	296	5.4	1.9	13
12:15-12:30		243	16	259	6.2	1.7	14
12:30-12:45		262	16	278	5.8	1.8	16
12:45-13:00		247	19	266	7.1	1.7	10
1時間計		1032	67	1099	6.1	7.1	53
13:00-13:15		274	17	291	5.8	1.9	20
13:15-13:30		267	9	276	3.3	1.8	11
13:30-13:45		235	17	252	6.7	1.6	12
13:45-14:00		237	15	252	6.0	1.6	14
1時間計		1013	58	1071	5.4	6.9	57

交差点合計自動車交通量調査表

調査地点 : 地域社会4 瀬谷土橋公園入口

調査年月日 : 令和 2年 9月26日(土) 天候:晴れ一時雨



方向 種別 時間帯	交差点合計(1+2+3+4+5+6)					
	小型車 (台)	大型車 (台)	合計 (台)	大型車 混入率 (%)	時間 係数 (%)	二輪車 (台)
14:00-14:15	302	19	321	5.9	2.1	25
14:15-14:30	237	8	245	3.3	1.6	17
14:30-14:45	240	12	252	4.8	1.6	21
14:45-15:00	277	7	284	2.5	1.8	20
1時間計	1056	46	1102	4.2	7.1	83
15:00-15:15	271	9	280	3.2	1.8	15
15:15-15:30	252	12	264	4.5	1.7	23
15:30-15:45	267	7	274	2.6	1.8	15
15:45-16:00	275	15	290	5.2	1.9	16
1時間計	1065	43	1108	3.9	7.2	69
16:00-16:15	288	12	300	4.0	1.9	18
16:15-16:30	270	10	280	3.6	1.8	29
16:30-16:45	293	12	305	3.9	2.0	26
16:45-17:00	244	5	249	2.0	1.6	28
1時間計	1095	39	1134	3.4	7.3	101
17:00-17:15	288	21	309	6.8	2.0	16
17:15-17:30	250	12	262	4.6	1.7	10
17:30-17:45	285	12	297	4.0	1.9	15
17:45-18:00	242	8	250	3.2	1.6	18
1時間計	1065	53	1118	4.7	7.2	59
18:00-18:15	254	15	269	5.6	1.7	13
18:15-18:30	236	6	242	2.5	1.6	10
18:30-18:45	209	12	221	5.4	1.4	11
18:45-19:00	208	5	213	2.3	1.4	5
1時間計	907	38	945	4.0	6.1	39
19:00-19:15	214	17	231	7.4	1.5	10
19:15-19:30	181	4	185	2.2	1.2	12
19:30-19:45	151	9	160	5.6	1.0	10
19:45-20:00	171	7	178	3.9	1.2	7
1時間計	717	37	754	4.9	4.9	39
20:00-20:15	139	3	142	2.1	0.9	10
20:15-20:30	137	8	145	5.5	0.9	8
20:30-20:45	121	5	126	4.0	0.8	7
20:45-21:00	100	4	104	3.8	0.7	11
1時間計	497	20	517	3.9	3.3	36
21:00-21:15	107	8	115	7.0	0.7	4
21:15-21:30	112	7	119	5.9	0.8	2
21:30-21:45	102	7	109	6.4	0.7	2
21:45-22:00	91	10	101	9.9	0.7	5
1時間計	412	32	444	7.2	2.9	13
昼12時間計	11279	659	11938	5.5	77.3	734
夜12時間計	3141	364	3505	10.4	22.7	161
18時間計	13786	860	14646	5.9	94.8	861
全時間合計	14420	1023	15443	6.6	100.0	895
昼夜率	1.28	1.55	1.29	-	-	1.22

交差点合計自動車交通量調査表

調査地点：地域社会4 瀬谷土橋公園前

調査年月日：令和 2年 9月26日(土) 天候：晴れ一時雨



方向 種別 時間帯	交差点合計(1+2+3+4+5+6)					
	小型車 (台)	大型車 (台)	合計 (台)	大型車 混入率 (%)	時間 係数 (%)	二輪車 (台)
22:00-22:15	29	18	47	38.3	0.7	0
22:15-22:30	38	5	43	11.6	0.7	0
22:30-22:45	29	6	35	17.1	0.5	0
22:45-23:00	35	10	45	22.2	0.7	1
1時間計	131	39	170	22.9	2.7	1
23:00-23:15	25	7	32	21.9	0.5	2
23:15-23:30	18	3	21	14.3	0.3	2
23:30-23:45	24	11	35	31.4	0.5	0
23:45-24:00	22	9	31	29.0	0.5	2
1時間計	89	30	119	25.2	1.9	6
0:00- 0:15	21	7	28	25.0	0.4	2
0:15- 0:30	14	4	18	22.2	0.3	0
0:30- 0:45	15	7	22	31.8	0.3	1
0:45- 1:00	7	6	13	46.2	0.2	0
1時間計	57	24	81	29.6	1.3	3
1:00- 1:15	18	6	24	25.0	0.4	2
1:15- 1:30	14	12	26	46.2	0.4	0
1:30- 1:45	12	16	28	57.1	0.4	0
1:45- 2:00	8	19	27	70.4	0.4	1
1時間計	52	53	105	50.5	1.6	3
2:00- 2:15	8	12	20	60.0	0.3	0
2:15- 2:30	7	8	15	53.3	0.2	0
2:30- 2:45	7	6	13	46.2	0.2	2
2:45- 3:00	8	3	11	27.3	0.2	2
1時間計	30	29	59	49.2	0.9	4
3:00- 3:15	7	2	9	22.2	0.1	0
3:15- 3:30	6	3	9	33.3	0.1	0
3:30- 3:45	6	6	12	50.0	0.2	0
3:45- 4:00	6	7	13	53.8	0.2	1
1時間計	25	18	43	41.9	0.7	1
4:00- 4:15	9	4	13	30.8	0.2	0
4:15- 4:30	12	2	14	14.3	0.2	0
4:30- 4:45	8	3	11	27.3	0.2	2
4:45- 5:00	14	2	16	12.5	0.3	3
1時間計	43	11	54	20.4	0.8	5
5:00- 5:15	19	10	29	34.5	0.5	3
5:15- 5:30	24	5	29	17.2	0.5	3
5:30- 5:45	23	8	31	25.8	0.5	0
5:45- 6:00	22	9	31	29.0	0.5	2
1時間計	88	32	120	26.7	1.9	8

交差点合計自動車交通量調査表

調査地点：地域社会4 瀬谷土橋公園前

調査年月日：令和 2年 9月26日(土) 天候：晴れ一時雨



時間帯	方向 種別	交差点合計(1+2+3+4+5+6)					
		小型車 (台)	大型車 (台)	合計 (台)	大型車 混入率 (%)	時間 係数 (%)	二輪車 (台)
6:00-6:15		33	14	47	29.8	0.7	1
6:15-6:30		27	7	34	20.6	0.5	0
6:30-6:45		26	18	44	40.9	0.7	1
6:45-7:00		36	10	46	21.7	0.7	1
1時間計		122	49	171	28.7	2.7	3
7:00-7:15		35	20	55	36.4	0.9	1
7:15-7:30		54	14	68	20.6	1.1	7
7:30-7:45		55	16	71	22.5	1.1	5
7:45-8:00		71	14	85	16.5	1.3	8
1時間計		215	64	279	22.9	4.4	21
8:00-8:15		76	11	87	12.6	1.4	3
8:15-8:30		69	11	80	13.8	1.3	2
8:30-8:45		102	9	111	8.1	1.7	5
8:45-9:00		71	4	75	5.3	1.2	4
1時間計		318	35	353	9.9	5.5	14
9:00-9:15		85	17	102	16.7	1.6	2
9:15-9:30		80	11	91	12.1	1.4	12
9:30-9:45		92	12	104	11.5	1.6	1
9:45-10:00		88	9	97	9.3	1.5	1
1時間計		345	49	394	12.4	6.2	16
10:00-10:15		96	12	108	11.1	1.7	3
10:15-10:30		89	19	108	17.6	1.7	5
10:30-10:45		98	19	117	16.2	1.8	4
10:45-11:00		92	12	104	11.5	1.6	2
1時間計		375	62	437	14.2	6.8	14
11:00-11:15		106	18	124	14.5	1.9	3
11:15-11:30		98	8	106	7.5	1.7	7
11:30-11:45		109	8	117	6.8	1.8	2
11:45-12:00		99	8	107	7.5	1.7	4
1時間計		412	42	454	9.3	7.1	16
12:00-12:15		106	16	122	13.1	1.9	5
12:15-12:30		95	12	107	11.2	1.7	3
12:30-12:45		99	12	111	10.8	1.7	5
12:45-13:00		89	17	106	16.0	1.7	4
1時間計		389	57	446	12.8	7.0	17
13:00-13:15		110	12	122	9.8	1.9	5
13:15-13:30		100	12	112	10.7	1.8	5
13:30-13:45		101	15	116	12.9	1.8	2
13:45-14:00		86	16	102	15.7	1.6	2
1時間計		397	55	452	12.2	7.1	14

交差点合計自動車交通量調査表

調査地点：地域社会4 瀬谷土橋公園前

調査年月日：令和 2年 9月26日(土) 天候：晴れ一時雨



方向 種別 時間帯	交差点合計(1+2+3+4+5+6)					
	小型車 (台)	大型車 (台)	合計 (台)	大型車 混入率 (%)	時間 係数 (%)	二輪車 (台)
14:00-14:15	96	10	106	9.4	1.7	10
14:15-14:30	124	9	133	6.8	2.1	4
14:30-14:45	94	11	105	10.5	1.6	6
14:45-15:00	112	6	118	5.1	1.8	8
1時間計	426	36	462	7.8	7.2	28
15:00-15:15	97	7	104	6.7	1.6	5
15:15-15:30	73	4	77	5.2	1.2	5
15:30-15:45	108	9	117	7.7	1.8	5
15:45-16:00	100	11	111	9.9	1.7	5
1時間計	378	31	409	7.6	6.4	20
16:00-16:15	106	17	123	13.8	1.9	7
16:15-16:30	93	10	103	9.7	1.6	9
16:30-16:45	96	11	107	10.3	1.7	10
16:45-17:00	98	12	110	10.9	1.7	12
1時間計	393	50	443	11.3	6.9	38
17:00-17:15	103	11	114	9.6	1.8	7
17:15-17:30	95	17	112	15.2	1.8	2
17:30-17:45	102	12	114	10.5	1.8	5
17:45-18:00	84	5	89	5.6	1.4	5
1時間計	384	45	429	10.5	6.7	19
18:00-18:15	53	12	65	18.5	1.0	3
18:15-18:30	79	5	84	6.0	1.3	3
18:30-18:45	68	4	72	5.6	1.1	3
18:45-19:00	64	4	68	5.9	1.1	2
1時間計	264	25	289	8.7	4.5	11
19:00-19:15	78	11	89	12.4	1.4	2
19:15-19:30	54	6	60	10.0	0.9	2
19:30-19:45	42	7	49	14.3	0.8	2
19:45-20:00	74	4	78	5.1	1.2	4
1時間計	248	28	276	10.1	4.3	10
20:00-20:15	52	6	58	10.3	0.9	5
20:15-20:30	44	8	52	15.4	0.8	0
20:30-20:45	35	5	40	12.5	0.6	3
20:45-21:00	27	6	33	18.2	0.5	2
1時間計	158	25	183	13.7	2.9	10
21:00-21:15	31	4	35	11.4	0.5	3
21:15-21:30	38	10	48	20.8	0.8	2
21:30-21:45	48	9	57	15.8	0.9	0
21:45-22:00	21	7	28	25.0	0.4	1
1時間計	138	30	168	17.9	2.6	6
昼12時間計	4296	551	4847	11.4	75.8	228
夜12時間計	1181	368	1549	23.8	24.2	60
18時間計	5182	752	5934	12.7	92.8	264
全時間合計	5477	919	6396	14.4	100.0	288
昼夜率	1.27	1.67	1.32	-	-	1.26

交差点合計自動車交通量調査表

調査地点 : 地域社会5

調査年月日 : 令和元年 5月11日(土) 天候:晴れ時々曇り

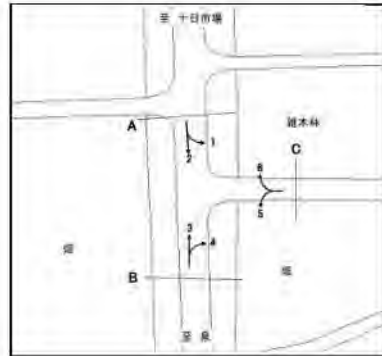

方向 時間帯	交差点合計(1+2+3+4+5+6)											
	種別 小型車 (台)	大型車 (台)	合計 (台)	大型車 混入率 (%)	時間 係数 (%)	二輪車 (台)	小型車 (台)	大型車 (台)	合計 (台)	大型車 混入率 (%)	時間 係数 (%)	二輪車 (台)
22:00-22:15	138	6	144	4.2	0.8	13						
22:15-22:30	122	14	136	10.3	0.8	5						
22:30-22:45	122	11	133	8.3	0.8	8						
22:45-23:00	107	9	116	7.8	0.7	12						
23:00-23:15	110	13	123	10.6	0.7	10						
23:15-23:30	86	6	92	6.5	0.5	8						
23:30-23:45	76	6	82	7.3	0.5	11						
23:45-24:00	69	3	72	4.2	0.4	6						
0:00-0:15	52	6	58	10.3	0.3	4						
0:15-0:30	41	7	48	14.6	0.3	3						
0:30-0:45	47	7	54	13.0	0.3	2						
0:45-1:00	44	9	53	17.0	0.3	6						
1:00-1:15	38	8	46	17.4	0.3	2						
1:15-1:30	31	5	36	13.9	0.2	4						
1:30-1:45	27	10	37	27.0	0.2	4						
1:45-2:00	26	12	38	31.6	0.2	2						
2:00-2:15	24	5	29	17.2	0.2	1						
2:15-2:30	23	3	26	11.5	0.1	5						
2:30-2:45	36	10	46	21.7	0.3	1						
2:45-3:00	25	9	34	26.5	0.2	0						
3:00-3:15	24	6	30	20.0	0.2	3						
3:15-3:30	26	7	33	21.2	0.2	2						
3:30-3:45	26	7	33	21.2	0.2	4						
3:45-4:00	27	7	34	20.6	0.2	4						
4:00-4:15	23	7	30	23.3	0.2	2						
4:15-4:30	28	9	37	24.3	0.2	1						
4:30-4:45	33	5	38	13.2	0.2	4						
4:45-5:00	33	8	41	19.5	0.2	3						
5:00-5:15	52	12	64	18.8	0.4	9						
5:15-5:30	49	13	62	21.0	0.4	5						
5:30-5:45	65	12	77	15.6	0.4	8						
5:45-6:00	58	9	67	13.4	0.4	4						
6:00-6:15	85	9	94	9.6	0.5	8						
6:15-6:30	98	11	109	10.1	0.6	6						
6:30-6:45	112	9	121	7.4	0.7	12						
6:45-7:00	117	11	128	8.6	0.7	13						
7:00-7:15	162	11	173	6.4	1.0	13						
7:15-7:30	194	19	213	8.9	1.2	26						
7:30-7:45	187	7	194	3.6	1.1	16						
7:45-8:00	193	11	204	5.4	1.2	19						
8:00-8:15	210	13	223	5.8	1.3	22						
8:15-8:30	216	11	227	4.8	1.3	21						
8:30-8:45	220	13	233	5.6	1.3	18						
8:45-9:00	239	18	257	7.0	1.5	25						
9:00-9:15	195	6	201	3.0	1.2	24						
9:15-9:30	247	17	264	6.4	1.5	21						
9:30-9:45	208	13	221	5.9	1.3	23						
9:45-10:00	258	9	267	3.4	1.5	18						

交差点合計自動車交通量調査表

調査地点 : 地域社会5

調査年月日 : 令和元年 5月11日(土) 天候:晴れ時々曇り

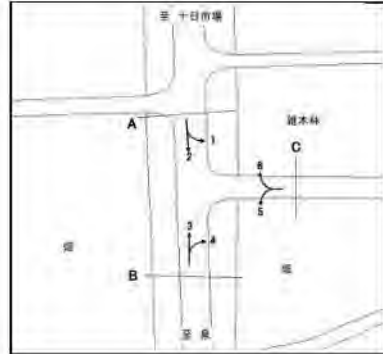

時間帯	交差点合計(1+2+3+4+5+6)												
	種別	小型車 (台)	大型車 (台)	合計 (台)	大型車 混入率 (%)	時間 係数 (%)	二輪車 (台)	小型車 (台)	大型車 (台)	合計 (台)	大型車 混入率 (%)	時間 係数 (%)	二輪車 (台)
10:00-10:15		280	13	293	4.4	1.7	15						
10:15-10:30		236	5	241	2.1	1.4	21						
10:30-10:45		298	11	309	3.6	1.8	14						
10:45-11:00		242	10	252	4.0	1.5	19						
11:00-11:15		275	4	279	1.4	1.6	16						
11:15-11:30		290	8	298	2.7	1.7	26						
11:30-11:45		264	7	271	2.6	1.6	20						
11:45-12:00		296	11	307	3.6	1.8	14						
12:00-12:15		250	10	260	3.8	1.5	18						
12:15-12:30		297	8	305	2.6	1.8	16						
12:30-12:45		262	8	270	3.0	1.6	14						
12:45-13:00		329	10	339	2.9	2.0	10						
13:00-13:15		257	4	261	1.5	1.5	22						
13:15-13:30		251	5	256	2.0	1.5	13						
13:30-13:45		291	12	303	4.0	1.7	27						
13:45-14:00		260	3	263	1.1	1.5	18						
14:00-14:15		294	11	305	3.6	1.8	15						
14:15-14:30		304	9	313	2.9	1.8	24						
14:30-14:45		263	3	266	1.1	1.5	17						
14:45-15:00		277	7	284	2.5	1.6	21						
15:00-15:15		279	8	287	2.8	1.7	18						
15:15-15:30		276	8	284	2.8	1.6	24						
15:30-15:45		291	7	298	2.3	1.7	21						
15:45-16:00		307	6	313	1.9	1.8	20						
16:00-16:15		276	3	279	1.1	1.6	21						
16:15-16:30		266	10	276	3.6	1.6	22						
16:30-16:45		319	8	327	2.4	1.9	19						
16:45-17:00		282	7	289	2.4	1.7	27						
17:00-17:15		294	4	298	1.3	1.7	19						
17:15-17:30		283	7	290	2.4	1.7	27						
17:30-17:45		281	7	288	2.4	1.7	29						
17:45-18:00		267	5	272	1.8	1.6	25						
18:00-18:15		266	5	271	1.8	1.6	21						
18:15-18:30		226	10	236	4.2	1.4	22						
18:30-18:45		254	9	263	3.4	1.5	20						
18:45-19:00		220	4	224	1.8	1.3	18						
19:00-19:15		187	5	192	2.6	1.1	17						
19:15-19:30		202	7	209	3.3	1.2	13						
19:30-19:45		219	6	225	2.7	1.3	17						
19:45-20:00		142	5	147	3.4	0.8	16						
20:00-20:15		209	10	219	4.6	1.3	18						
20:15-20:30		141	4	145	2.8	0.8	13						
20:30-20:45		172	3	175	1.7	1.0	10						
20:45-21:00		152	3	155	1.9	0.9	9						
21:00-21:15		165	5	170	2.9	1.0	9						
21:15-21:30		134	6	140	4.3	0.8	6						
21:30-21:45		171	8	179	4.5	1.0	18						
21:45-22:00		128	10	138	7.2	0.8	8						
全時間合計		16554	788	17342	4.5	100.0	1308						

交差点合計自動車交通量調査表

調査地点 : 地域社会6 瀬谷中学校前

調査年月日 : 令和元年 5月11日(土) 天候:晴れ時々曇り



方向 時間帯	交差点合計(1+2+3+4+5+6+7+8+9+10+11+12)											
	種別 小型車 (台)	大型車 (台)	合計 (台)	大型車 混入率 (%)	時間 係数 (%)	二輪車 (台)	小型車 (台)	大型車 (台)	合計 (台)	大型車 混入率 (%)	時間 係数 (%)	二輪車 (台)
22:00-22:15	257	10	267	3.7	0.9	16						
22:15-22:30	256	13	269	4.8	0.9	22						
22:30-22:45	183	6	189	3.2	0.6	11						
22:45-23:00	191	4	195	2.1	0.7	10						
23:00-23:15	184	8	192	4.2	0.7	16						
23:15-23:30	141	7	148	4.7	0.5	14						
23:30-23:45	120	4	124	3.2	0.4	13						
23:45-24:00	108	6	114	5.3	0.4	13						
0:00-0:15	96	7	103	6.8	0.4	6						
0:15-0:30	78	8	86	9.3	0.3	2						
0:30-0:45	88	4	92	4.3	0.3	8						
0:45-1:00	95	9	104	8.7	0.4	10						
1:00-1:15	73	7	80	8.8	0.3	6						
1:15-1:30	52	5	57	8.8	0.2	5						
1:30-1:45	56	11	67	16.4	0.2	7						
1:45-2:00	44	11	55	20.0	0.2	8						
2:00-2:15	43	6	49	12.2	0.2	1						
2:15-2:30	36	6	42	14.3	0.1	9						
2:30-2:45	39	8	47	17.0	0.2	3						
2:45-3:00	44	7	51	13.7	0.2	1						
3:00-3:15	33	2	35	5.7	0.1	6						
3:15-3:30	38	8	46	17.4	0.2	6						
3:30-3:45	30	7	37	18.9	0.1	4						
3:45-4:00	30	4	34	11.8	0.1	6						
4:00-4:15	45	14	59	23.7	0.2	1						
4:15-4:30	49	13	62	21.0	0.2	7						
4:30-4:45	50	6	56	10.7	0.2	6						
4:45-5:00	42	11	53	20.8	0.2	5						
5:00-5:15	52	15	67	22.4	0.2	9						
5:15-5:30	64	6	70	8.6	0.2	9						
5:30-5:45	77	11	88	12.5	0.3	7						
5:45-6:00	80	8	88	9.1	0.3	4						
6:00-6:15	110	10	120	8.3	0.4	8						
6:15-6:30	143	10	153	6.5	0.5	12						
6:30-6:45	161	22	183	12.0	0.6	11						
6:45-7:00	154	15	169	8.9	0.6	12						
7:00-7:15	216	18	234	7.7	0.8	15						
7:15-7:30	254	12	266	4.5	0.9	23						
7:30-7:45	250	13	263	4.9	0.9	29						
7:45-8:00	278	7	285	2.5	1.0	20						
8:00-8:15	312	24	336	7.1	1.1	31						
8:15-8:30	330	17	347	4.9	1.2	33						
8:30-8:45	339	17	356	4.8	1.2	31						
8:45-9:00	345	13	358	3.6	1.2	31						
9:00-9:15	374	17	391	4.3	1.3	45						
9:15-9:30	420	17	437	3.9	1.5	40						
9:30-9:45	375	15	390	3.8	1.3	35						
9:45-10:00	440	11	451	2.4	1.5	22						

交差点合計自動車交通量調査表

調査地点 : 地域社会6 瀬谷中学校前

調査年月日 : 令和元年 5月11日(土) 天候:晴れ時々曇り



方向 時間帯	交差点合計(1+2+3+4+5+6+7+8+9+10+11+12)											
	種別 小型車 (台)	大型車 (台)	合計 (台)	大型車 混入率 (%)	時間 係数 (%)	二輪車 (台)	小型車 (台)	大型車 (台)	合計 (台)	大型車 混入率 (%)	時間 係数 (%)	二輪車 (台)
10:00-10:15	489	13	502	2.6	1.7	30						
10:15-10:30	433	22	455	4.8	1.5	17						
10:30-10:45	439	7	446	1.6	1.5	32						
10:45-11:00	475	18	493	3.7	1.7	34						
11:00-11:15	487	18	505	3.6	1.7	32						
11:15-11:30	458	8	466	1.7	1.6	41						
11:30-11:45	480	15	495	3.0	1.7	38						
11:45-12:00	513	19	532	3.6	1.8	27						
12:00-12:15	496	14	510	2.7	1.7	28						
12:15-12:30	491	14	505	2.8	1.7	29						
12:30-12:45	430	8	438	1.8	1.5	34						
12:45-13:00	407	11	418	2.6	1.4	19						
13:00-13:15	517	12	529	2.3	1.8	26						
13:15-13:30	464	10	474	2.1	1.6	30						
13:30-13:45	461	16	477	3.4	1.6	31						
13:45-14:00	566	15	581	2.6	2.0	26						
14:00-14:15	521	8	529	1.5	1.8	22						
14:15-14:30	438	9	447	2.0	1.5	34						
14:30-14:45	561	10	571	1.8	1.9	43						
14:45-15:00	513	13	526	2.5	1.8	15						
15:00-15:15	513	9	522	1.7	1.8	24						
15:15-15:30	524	14	538	2.6	1.8	33						
15:30-15:45	454	13	467	2.8	1.6	26						
15:45-16:00	514	13	527	2.5	1.8	28						
16:00-16:15	512	9	521	1.7	1.8	14						
16:15-16:30	500	11	511	2.2	1.7	34						
16:30-16:45	539	20	559	3.6	1.9	31						
16:45-17:00	517	13	530	2.5	1.8	49						
17:00-17:15	490	8	498	1.6	1.7	41						
17:15-17:30	455	12	467	2.6	1.6	27						
17:30-17:45	473	6	479	1.3	1.6	26						
17:45-18:00	509	7	516	1.4	1.8	28						
18:00-18:15	513	8	521	1.5	1.8	31						
18:15-18:30	488	17	505	3.4	1.7	33						
18:30-18:45	403	18	421	4.3	1.4	15						
18:45-19:00	435	4	439	0.9	1.5	26						
19:00-19:15	352	6	358	1.7	1.2	19						
19:15-19:30	358	8	366	2.2	1.2	28						
19:30-19:45	386	9	395	2.3	1.3	25						
19:45-20:00	325	6	331	1.8	1.1	18						
20:00-20:15	322	10	332	3.0	1.1	24						
20:15-20:30	306	12	318	3.8	1.1	15						
20:30-20:45	319	6	325	1.8	1.1	15						
20:45-21:00	278	10	288	3.5	1.0	18						
21:00-21:15	280	9	289	3.1	1.0	20						
21:15-21:30	247	10	257	3.9	0.9	13						
21:30-21:45	251	11	262	4.2	0.9	14						
21:45-22:00	190	2	192	1.0	0.7	16						
全時間合計	28367	1031	29398	3.5	100.0	1928						

方向別自動車交通量調査表

調査地点：地域社会1 目黒

調査年月日：令和元年10月13日(日) 天候：曇りのち雨

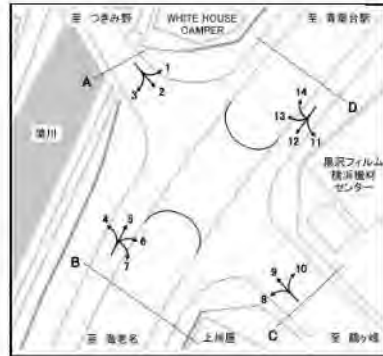

方向 種別 時間帯	1						2					
	小型車 (台)	大型車 (台)	合計 (台)	大型車 混入率 (%)	時間 係数 (%)	二輪車 (台)	小型車 (台)	大型車 (台)	合計 (台)	大型車 混入率 (%)	時間 係数 (%)	二輪車 (台)
22:00-22:15	10	1	11	9.1	0.6	0	35	6	41	14.6	0.7	2
22:15-22:30	12	0	12	0.0	0.6	0	44	3	47	6.4	0.8	3
22:30-22:45	12	1	13	7.7	0.7	1	26	3	29	10.3	0.5	0
22:45-23:00	21	1	22	4.5	1.2	0	31	4	35	11.4	0.6	5
1時間計	55	3	58	5.2	3.0	1	136	16	152	10.5	2.6	10
23:00-23:15	8	5	13	38.5	0.7	0	36	4	40	10.0	0.7	0
23:15-23:30	9	0	9	0.0	0.5	1	21	4	25	16.0	0.4	3
23:30-23:45	6	1	7	14.3	0.4	1	22	5	27	18.5	0.5	2
23:45-24:00	5	1	6	16.7	0.3	0	26	5	31	16.1	0.5	0
1時間計	28	7	35	20.0	1.8	2	105	18	123	14.6	2.1	5
0:00-0:15	6	0	6	0.0	0.3	0	18	2	20	10.0	0.3	3
0:15-0:30	4	0	4	0.0	0.2	0	15	3	18	16.7	0.3	1
0:30-0:45	5	2	7	28.6	0.4	0	8	5	13	38.5	0.2	2
0:45-1:00	6	0	6	0.0	0.3	2	19	4	23	17.4	0.4	2
1時間計	21	2	23	8.7	1.2	2	60	14	74	18.9	1.3	8
1:00-1:15	6	1	7	14.3	0.4	1	12	6	18	33.3	0.3	1
1:15-1:30	3	4	7	57.1	0.4	0	3	9	12	75.0	0.2	1
1:30-1:45	3	0	3	0.0	0.2	0	13	2	15	13.3	0.3	1
1:45-2:00	1	1	2	50.0	0.1	0	12	1	13	7.7	0.2	0
1時間計	13	6	19	31.6	1.0	1	40	18	58	31.0	1.0	3
2:00-2:15	4	3	7	42.9	0.4	0	12	2	14	14.3	0.2	2
2:15-2:30	3	3	6	50.0	0.3	0	8	8	16	50.0	0.3	1
2:30-2:45	4	0	4	0.0	0.2	0	10	7	17	41.2	0.3	1
2:45-3:00	1	3	4	75.0	0.2	4	10	6	16	37.5	0.3	2
1時間計	12	9	21	42.9	1.1	4	40	23	63	36.5	1.1	6
3:00-3:15	1	2	3	66.7	0.2	0	4	13	17	76.5	0.3	1
3:15-3:30	3	1	4	25.0	0.2	0	8	6	14	42.9	0.2	0
3:30-3:45	5	1	6	16.7	0.3	0	15	7	22	31.8	0.4	2
3:45-4:00	6	2	8	25.0	0.4	0	10	6	16	37.5	0.3	1
1時間計	15	6	21	28.6	1.1	0	37	32	69	46.4	1.2	4
4:00-4:15	3	3	6	50.0	0.3	0	12	10	22	45.5	0.4	3
4:15-4:30	4	3	7	42.9	0.4	0	14	8	22	36.4	0.4	4
4:30-4:45	4	0	4	0.0	0.2	0	20	6	26	23.1	0.4	0
4:45-5:00	3	1	4	25.0	0.2	0	16	8	24	33.3	0.4	1
1時間計	14	7	21	33.3	1.1	0	62	32	94	34.0	1.6	8
5:00-5:15	11	1	12	8.3	0.6	1	13	10	23	43.5	0.4	3
5:15-5:30	13	4	17	23.5	0.9	0	32	9	41	22.0	0.7	5
5:30-5:45	11	2	13	15.4	0.7	1	46	9	55	16.4	0.9	1
5:45-6:00	19	4	23	17.4	1.2	0	54	12	66	18.2	1.1	2
1時間計	54	11	65	16.9	3.4	2	145	40	185	21.6	3.2	11

方向別自動車交通量調査表

調査地点：地域社会1 目黒

調査年月日：令和元年10月13日(日) 天候：曇りのち雨

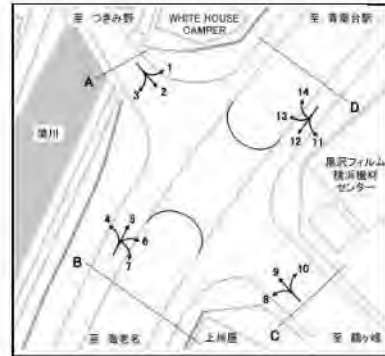

方向 時間帯	1						2					
	種別 小型車 (台)	大型車 (台)	合計 (台)	大型車 混入率 (%)	時間 係数 (%)	二輪車 (台)	小型車 (台)	大型車 (台)	合計 (台)	大型車 混入率 (%)	時間 係数 (%)	二輪車 (台)
6:00-6:15	24	6	30	20.0	1.6	0	55	14	69	20.3	1.2	2
6:15-6:30	15	3	18	16.7	0.9	0	52	13	65	20.0	1.1	4
6:30-6:45	14	3	17	17.6	0.9	2	51	13	64	20.3	1.1	4
6:45-7:00	10	4	14	28.6	0.7	1	62	13	75	17.3	1.3	5
1時間計	63	16	79	20.3	4.1	3	220	53	273	19.4	4.7	15
7:00-7:15	12	6	18	33.3	0.9	1	53	14	67	20.9	1.2	6
7:15-7:30	16	7	23	30.4	1.2	0	66	15	81	18.5	1.4	7
7:30-7:45	15	3	18	16.7	0.9	0	58	11	69	15.9	1.2	4
7:45-8:00	10	6	16	37.5	0.8	0	59	15	74	20.3	1.3	6
1時間計	53	22	75	29.3	3.9	1	236	55	291	18.9	5.0	23
8:00-8:15	23	4	27	14.8	1.4	1	68	7	75	9.3	1.3	8
8:15-8:30	18	3	21	14.3	1.1	2	72	15	87	17.2	1.5	3
8:30-8:45	15	5	20	25.0	1.0	0	85	11	96	11.5	1.7	5
8:45-9:00	12	3	15	20.0	0.8	2	46	11	57	19.3	1.0	7
1時間計	68	15	83	18.1	4.3	5	271	44	315	14.0	5.4	23
9:00-9:15	17	4	21	19.0	1.1	1	73	12	85	14.1	1.5	3
9:15-9:30	13	2	15	13.3	0.8	0	58	14	72	19.4	1.2	3
9:30-9:45	19	4	23	17.4	1.2	0	57	9	66	13.6	1.1	2
9:45-10:00	19	5	24	20.8	1.3	0	54	4	58	6.9	1.0	3
1時間計	68	15	83	18.1	4.3	1	242	39	281	13.9	4.8	11
10:00-10:15	17	4	21	19.0	1.1	0	53	17	70	24.3	1.2	0
10:15-10:30	15	4	19	21.1	1.0	2	66	5	71	7.0	1.2	2
10:30-10:45	24	1	25	4.0	1.3	0	53	14	67	20.9	1.2	0
10:45-11:00	21	4	25	16.0	1.3	0	56	8	64	12.5	1.1	1
1時間計	77	13	90	14.4	4.7	2	228	44	272	16.2	4.7	3
11:00-11:15	21	0	21	0.0	1.1	0	65	10	75	13.3	1.3	1
11:15-11:30	17	2	19	10.5	1.0	0	54	7	61	11.5	1.1	1
11:30-11:45	30	3	33	9.1	1.7	0	74	13	87	14.9	1.5	0
11:45-12:00	29	1	30	3.3	1.6	0	83	9	92	9.8	1.6	5
1時間計	97	6	103	5.8	5.4	0	276	39	315	12.4	5.4	7
12:00-12:15	33	4	37	10.8	1.9	2	93	6	99	6.1	1.7	0
12:15-12:30	34	1	35	2.9	1.8	1	83	7	90	7.8	1.6	1
12:30-12:45	32	3	35	8.6	1.8	0	84	9	93	9.7	1.6	3
12:45-13:00	32	2	34	5.9	1.8	0	78	9	87	10.3	1.5	2
1時間計	131	10	141	7.1	7.4	3	338	31	369	8.4	6.4	6
13:00-13:15	26	1	27	3.7	1.4	0	73	10	83	12.0	1.4	1
13:15-13:30	31	1	32	3.1	1.7	0	80	8	88	9.1	1.5	1
13:30-13:45	20	2	22	9.1	1.2	0	77	8	85	9.4	1.5	2
13:45-14:00	24	1	25	4.0	1.3	0	70	11	81	13.6	1.4	0
1時間計	101	5	106	4.7	5.5	0	300	37	337	11.0	5.8	4

方向別自動車交通量調査表

調査地点：地域社会1 目黒

調査年月日：令和元年10月13日(日) 天候：曇りのち雨

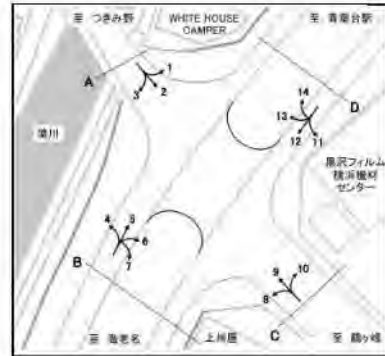

方向 時間帯	1						2					
	種別 小型車 (台)	大型車 (台)	合計 (台)	大型車 混入率 (%)	時間 係数 (%)	二輪車 (台)	小型車 (台)	大型車 (台)	合計 (台)	大型車 混入率 (%)	時間 係数 (%)	二輪車 (台)
14:00-14:15	37	1	38	2.6	2.0	0	89	8	97	8.2	1.7	1
14:15-14:30	25	2	27	7.4	1.4	0	68	5	73	6.8	1.3	2
14:30-14:45	29	1	30	3.3	1.6	0	89	4	93	4.3	1.6	2
14:45-15:00	31	1	32	3.1	1.7	0	85	6	91	6.6	1.6	2
1時間計	122	5	127	3.9	6.6	0	331	23	354	6.5	6.1	7
15:00-15:15	28	3	31	9.7	1.6	0	79	11	90	12.2	1.6	1
15:15-15:30	29	3	32	9.4	1.7	0	67	10	77	13.0	1.3	1
15:30-15:45	34	3	37	8.1	1.9	0	73	4	77	5.2	1.3	0
15:45-16:00	20	1	21	4.8	1.1	0	85	11	96	11.5	1.7	4
1時間計	111	10	121	8.3	6.3	0	304	36	340	10.6	5.9	6
16:00-16:15	29	2	31	6.5	1.6	1	87	10	97	10.3	1.7	3
16:15-16:30	40	0	40	0.0	2.1	1	73	3	76	3.9	1.3	2
16:30-16:45	29	0	29	0.0	1.5	0	86	3	89	3.4	1.5	3
16:45-17:00	38	2	40	5.0	2.1	0	77	4	81	4.9	1.4	3
1時間計	136	4	140	2.9	7.3	2	323	20	343	5.8	5.9	11
17:00-17:15	31	2	33	6.1	1.7	1	80	7	87	8.0	1.5	2
17:15-17:30	26	2	28	7.1	1.5	0	91	10	101	9.9	1.7	2
17:30-17:45	25	0	25	0.0	1.3	0	92	8	100	8.0	1.7	4
17:45-18:00	32	2	34	5.9	1.8	1	92	2	94	2.1	1.6	3
1時間計	114	6	120	5.0	6.3	2	355	27	382	7.1	6.6	11
18:00-18:15	32	4	36	11.1	1.9	0	90	5	95	5.3	1.6	3
18:15-18:30	25	2	27	7.4	1.4	0	78	11	89	12.4	1.5	2
18:30-18:45	24	2	26	7.7	1.4	0	80	4	84	4.8	1.4	1
18:45-19:00	25	3	28	10.7	1.5	0	86	9	95	9.5	1.6	7
1時間計	106	11	117	9.4	6.1	0	334	29	363	8.0	6.3	13
19:00-19:15	21	1	22	4.5	1.2	0	72	5	77	6.5	1.3	1
19:15-19:30	27	0	27	0.0	1.4	0	86	7	93	7.5	1.6	1
19:30-19:45	25	3	28	10.7	1.5	0	55	13	68	19.1	1.2	1
19:45-20:00	22	1	23	4.3	1.2	0	77	5	82	6.1	1.4	2
1時間計	95	5	100	5.0	5.2	0	290	30	320	9.4	5.5	5
20:00-20:15	23	2	25	8.0	1.3	0	66	6	72	8.3	1.2	3
20:15-20:30	21	1	22	4.5	1.2	0	36	3	39	7.7	0.7	1
20:30-20:45	19	1	20	5.0	1.0	0	56	7	63	11.1	1.1	1
20:45-21:00	16	2	18	11.1	0.9	0	54	8	62	12.9	1.1	3
1時間計	79	6	85	7.1	4.4	0	212	24	236	10.2	4.1	8
21:00-21:15	18	2	20	10.0	1.0	0	51	10	61	16.4	1.1	0
21:15-21:30	18	5	23	21.7	1.2	0	39	1	40	2.5	0.7	8
21:30-21:45	17	3	20	15.0	1.0	0	46	4	50	8.0	0.9	1
21:45-22:00	14	2	16	12.5	0.8	0	32	9	41	22.0	0.7	2
1時間計	67	12	79	15.2	4.1	0	168	24	192	12.5	3.3	11
昼12時間計	1184	122	1306	9.3	68.3	16	3538	424	3962	10.7	68.3	125
夜12時間計	516	90	606	14.9	31.7	15	1515	324	1839	17.6	31.7	94
全時間合計	1700	212	1912	11.1	100.0	31	5053	748	5801	12.9	100.0	219
昼夜率	1.44	1.74	1.46	-	-	1.94	1.43	1.76	1.46	-	-	1.75

方向別自動車交通量調査表

調査地点：地域社会1 目黒

調査年月日：令和元年10月13日(日) 天候：曇りのち雨

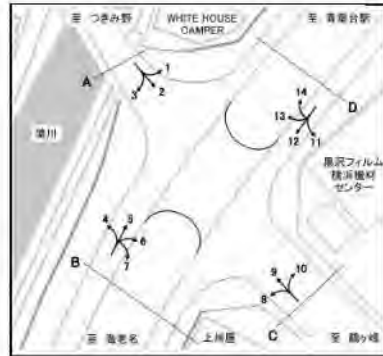

方向	3						A 合計 (1+ 3)						
	種別	小型車 (台)	大型車 (台)	合計 (台)	大型車 混入率 (%)	時係 数 (%)	二輪車 (台)	小型車 (台)	大型車 (台)	合計 (台)	大型車 混入率 (%)	時係 数 (%)	二輪車 (台)
22:00-22:15		13	0	13	0.0	1.0	0	58	7	65	10.8	0.7	2
22:15-22:30		25	1	26	3.8	1.9	4	81	4	85	4.7	0.9	7
22:30-22:45		17	0	17	0.0	1.3	0	55	4	59	6.8	0.7	1
22:45-23:00		17	3	20	15.0	1.5	2	69	8	77	10.4	0.9	7
1時間計		72	4	76	5.3	5.7	6	263	23	286	8.0	3.2	17
23:00-23:15		12	0	12	0.0	0.9	4	56	9	65	13.8	0.7	4
23:15-23:30		13	0	13	0.0	1.0	2	43	4	47	8.5	0.5	6
23:30-23:45		8	1	9	11.1	0.7	1	36	7	43	16.3	0.5	4
23:45-24:00		11	0	11	0.0	0.8	1	42	6	48	12.5	0.5	1
1時間計		44	1	45	2.2	3.4	8	177	26	203	12.8	2.2	15
0:00- 0:15		4	1	5	20.0	0.4	3	28	3	31	9.7	0.3	6
0:15- 0:30		12	2	14	14.3	1.0	0	31	5	36	13.9	0.4	1
0:30- 0:45		2	2	4	50.0	0.3	0	15	9	24	37.5	0.3	2
0:45- 1:00		0	1	1	100.0	0.1	0	25	5	30	16.7	0.3	4
1時間計		18	6	24	25.0	1.8	3	99	22	121	18.2	1.3	13
1:00- 1:15		9	1	10	10.0	0.7	0	27	8	35	22.9	0.4	2
1:15- 1:30		5	3	8	37.5	0.6	0	11	16	27	59.3	0.3	1
1:30- 1:45		3	1	4	25.0	0.3	0	19	3	22	13.6	0.2	1
1:45- 2:00		3	2	5	40.0	0.4	0	16	4	20	20.0	0.2	0
1時間計		20	7	27	25.9	2.0	0	73	31	104	29.8	1.1	4
2:00- 2:15		6	0	6	0.0	0.4	0	22	5	27	18.5	0.3	2
2:15- 2:30		7	0	7	0.0	0.5	0	18	11	29	37.9	0.3	1
2:30- 2:45		5	2	7	28.6	0.5	0	19	9	28	32.1	0.3	1
2:45- 3:00		3	2	5	40.0	0.4	0	14	11	25	44.0	0.3	6
1時間計		21	4	25	16.0	1.9	0	73	36	109	33.0	1.2	10
3:00- 3:15		3	0	3	0.0	0.2	1	8	15	23	65.2	0.3	2
3:15- 3:30		4	4	8	50.0	0.6	0	15	11	26	42.3	0.3	0
3:30- 3:45		2	1	3	33.3	0.2	0	22	9	31	29.0	0.3	2
3:45- 4:00		8	7	15	46.7	1.1	0	24	15	39	38.5	0.4	1
1時間計		17	12	29	41.4	2.2	1	69	50	119	42.0	1.3	5
4:00- 4:15		5	2	7	28.6	0.5	1	20	15	35	42.9	0.4	4
4:15- 4:30		4	4	8	50.0	0.6	1	22	15	37	40.5	0.4	5
4:30- 4:45		8	0	8	0.0	0.6	0	32	6	38	15.8	0.4	0
4:45- 5:00		2	2	4	50.0	0.3	1	21	11	32	34.4	0.4	2
1時間計		19	8	27	29.6	2.0	3	95	47	142	33.1	1.6	11
5:00- 5:15		8	1	9	11.1	0.7	0	32	12	44	27.3	0.5	4
5:15- 5:30		1	0	1	0.0	0.1	0	46	13	59	22.0	0.7	5
5:30- 5:45		6	7	13	53.8	1.0	0	63	18	81	22.2	0.9	2
5:45- 6:00		9	0	9	0.0	0.7	0	82	16	98	16.3	1.1	2
1時間計		24	8	32	25.0	2.4	0	223	59	282	20.9	3.1	13

方向別自動車交通量調査表

調査地点：地域社会1 目黒

調査年月日：令和元年10月13日(日) 天候：曇りのち雨

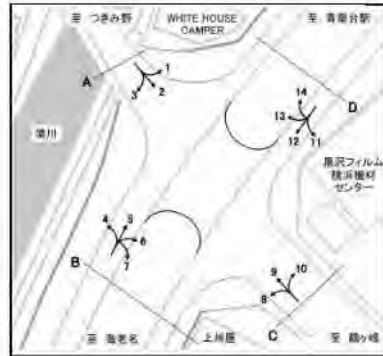

時間帯	種別	3					A 合計 (1+ 3)						
		小型車 (台)	大型車 (台)	合計 (台)	大型車 混入率 (%)	時 間 係 数 (%)	二輪車 (台)	小型車 (台)	大型車 (台)	合計 (台)	大型車 混入率 (%)	時 間 係 数 (%)	二輪車 (台)
6:00-6:15		10	1	11	9.1	0.8	1	89	21	110	19.1	1.2	3
6:15-6:30		5	0	5	0.0	0.4	0	72	16	88	18.2	1.0	4
6:30-6:45		12	3	15	20.0	1.1	0	77	19	96	19.8	1.1	6
6:45-7:00		23	6	29	20.7	2.2	0	95	23	118	19.5	1.3	6
1時間計		50	10	60	16.7	4.5	1	333	79	412	19.2	4.6	19
7:00-7:15		17	3	20	15.0	1.5	2	82	23	105	21.9	1.2	9
7:15-7:30		7	3	10	30.0	0.7	0	89	25	114	21.9	1.3	7
7:30-7:45		16	4	20	20.0	1.5	1	89	18	107	16.8	1.2	5
7:45-8:00		7	2	9	22.2	0.7	1	76	23	99	23.2	1.1	7
1時間計		47	12	59	20.3	4.4	4	336	89	425	20.9	4.7	28
8:00-8:15		13	4	17	23.5	1.3	2	104	15	119	12.6	1.3	11
8:15-8:30		9	2	11	18.2	0.8	0	99	20	119	16.8	1.3	5
8:30-8:45		16	2	18	11.1	1.3	2	116	18	134	13.4	1.5	7
8:45-9:00		14	0	14	0.0	1.0	0	72	14	86	16.3	0.9	9
1時間計		52	8	60	13.3	4.5	4	391	67	458	14.6	5.1	32
9:00-9:15		11	3	14	21.4	1.0	1	101	19	120	15.8	1.3	5
9:15-9:30		16	4	20	20.0	1.5	0	87	20	107	18.7	1.2	3
9:30-9:45		17	1	18	5.6	1.3	1	93	14	107	13.1	1.2	3
9:45-10:00		21	4	25	16.0	1.9	1	94	13	107	12.1	1.2	4
1時間計		65	12	77	15.6	5.7	3	375	66	441	15.0	4.9	15
10:00-10:15		22	4	26	15.4	1.9	0	92	25	117	21.4	1.3	0
10:15-10:30		12	2	14	14.3	1.0	0	93	11	104	10.6	1.1	4
10:30-10:45		14	5	19	26.3	1.4	0	91	20	111	18.0	1.2	0
10:45-11:00		13	1	14	7.1	1.0	1	90	13	103	12.6	1.1	2
1時間計		61	12	73	16.4	5.4	1	366	69	435	15.9	4.8	6
11:00-11:15		20	0	20	0.0	1.5	0	106	10	116	8.6	1.3	1
11:15-11:30		23	2	25	8.0	1.9	1	94	11	105	10.5	1.2	2
11:30-11:45		20	0	20	0.0	1.5	0	124	16	140	11.4	1.5	0
11:45-12:00		18	4	22	18.2	1.6	0	130	14	144	9.7	1.6	5
1時間計		81	6	87	6.9	6.5	1	454	51	505	10.1	5.6	8
12:00-12:15		30	3	33	9.1	2.5	0	156	13	169	7.7	1.9	2
12:15-12:30		25	2	27	7.4	2.0	0	142	10	152	6.6	1.7	2
12:30-12:45		17	1	18	5.6	1.3	0	133	13	146	8.9	1.6	3
12:45-13:00		23	0	23	0.0	1.7	1	133	11	144	7.6	1.6	3
1時間計		95	6	101	5.9	7.5	1	564	47	611	7.7	6.7	10
13:00-13:15		16	1	17	5.9	1.3	0	115	12	127	9.4	1.4	1
13:15-13:30		19	0	19	0.0	1.4	0	130	9	139	6.5	1.5	1
13:30-13:45		22	2	24	8.3	1.8	0	119	12	131	9.2	1.4	2
13:45-14:00		15	3	18	16.7	1.3	0	109	15	124	12.1	1.4	0
1時間計		72	6	78	7.7	5.8	0	473	48	521	9.2	5.8	4

方向別自動車交通量調査表

調査地点：地域社会1 目黒

調査年月日：令和元年10月13日(日) 天候：曇りのち雨

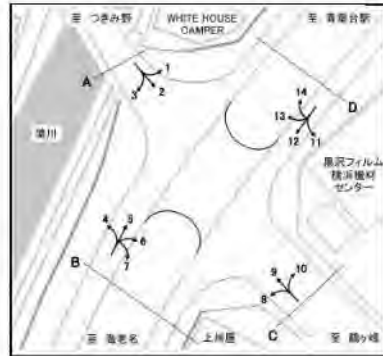

方向	3						A 合計 (1+ 2+ 3)						
	種別	小型車 (台)	大型車 (台)	合計 (台)	大型車 混入率 (%)	時係 数 (%)	二輪車 (台)	小型車 (台)	大型車 (台)	合計 (台)	大型車 混入率 (%)	時係 数 (%)	二輪車 (台)
14:00-14:15		27	2	29	6.9	2.2	1	153	11	164	6.7	1.8	2
14:15-14:30		12	3	15	20.0	1.1	0	105	10	115	8.7	1.3	2
14:30-14:45		18	0	18	0.0	1.3	0	136	5	141	3.5	1.6	2
14:45-15:00		15	1	16	6.3	1.2	1	131	8	139	5.8	1.5	3
1時間計		72	6	78	7.7	5.8	2	525	34	559	6.1	6.2	9
15:00-15:15		15	0	15	0.0	1.1	0	122	14	136	10.3	1.5	1
15:15-15:30		17	2	19	10.5	1.4	1	113	15	128	11.7	1.4	2
15:30-15:45		13	1	14	7.1	1.0	1	120	8	128	6.3	1.4	1
15:45-16:00		16	0	16	0.0	1.2	1	121	12	133	9.0	1.5	5
1時間計		61	3	64	4.7	4.8	3	476	49	525	9.3	5.8	9
16:00-16:15		15	0	15	0.0	1.1	0	131	12	143	8.4	1.6	4
16:15-16:30		21	1	22	4.5	1.6	1	134	4	138	2.9	1.5	4
16:30-16:45		7	1	8	12.5	0.6	0	122	4	126	3.2	1.4	3
16:45-17:00		11	1	12	8.3	0.9	1	126	7	133	5.3	1.5	4
1時間計		54	3	57	5.3	4.3	2	513	27	540	5.0	6.0	15
17:00-17:15		13	0	13	0.0	1.0	0	124	9	133	6.8	1.5	3
17:15-17:30		6	0	6	0.0	0.4	0	123	12	135	8.9	1.5	2
17:30-17:45		10	2	12	16.7	0.9	0	127	10	137	7.3	1.5	4
17:45-18:00		13	1	14	7.1	1.0	1	137	5	142	3.5	1.6	5
1時間計		42	3	45	6.7	3.4	1	511	36	547	6.6	6.0	14
18:00-18:15		6	1	7	14.3	0.5	2	128	10	138	7.2	1.5	5
18:15-18:30		16	0	16	0.0	1.2	0	119	13	132	9.8	1.5	2
18:30-18:45		9	2	11	18.2	0.8	0	113	8	121	6.6	1.3	1
18:45-19:00		15	2	17	11.8	1.3	1	126	14	140	10.0	1.5	8
1時間計		46	5	51	9.8	3.8	3	486	45	531	8.5	5.9	16
19:00-19:15		10	1	11	9.1	0.8	1	103	7	110	6.4	1.2	2
19:15-19:30		20	1	21	4.8	1.6	1	133	8	141	5.7	1.6	2
19:30-19:45		11	0	11	0.0	0.8	3	91	16	107	15.0	1.2	4
19:45-20:00		21	1	22	4.5	1.6	0	120	7	127	5.5	1.4	2
1時間計		62	3	65	4.6	4.9	5	447	38	485	7.8	5.4	10
20:00-20:15		11	1	12	8.3	0.9	0	100	9	109	8.3	1.2	3
20:15-20:30		11	1	12	8.3	0.9	0	68	5	73	6.8	0.8	1
20:30-20:45		11	1	12	8.3	0.9	0	86	9	95	9.5	1.0	1
20:45-21:00		12	1	13	7.7	1.0	0	82	11	93	11.8	1.0	3
1時間計		45	4	49	8.2	3.7	0	336	34	370	9.2	4.1	8
21:00-21:15		10	2	12	16.7	0.9	0	79	14	93	15.1	1.0	0
21:15-21:30		11	1	12	8.3	0.9	1	68	7	75	9.3	0.8	9
21:30-21:45		16	0	16	0.0	1.2	0	79	7	86	8.1	0.9	1
21:45-22:00		9	2	11	18.2	0.8	0	55	13	68	19.1	0.8	2
1時間計		46	5	51	9.8	3.8	1	281	41	322	12.7	3.6	12
昼12時間計		748	82	830	9.9	61.9	25	5470	628	6098	10.3	67.4	166
夜12時間計		438	72	510	14.1	38.1	28	2469	486	2955	16.4	32.6	137
全時間合計		1186	154	1340	11.5	100.0	53	7939	1114	9053	12.3	100.0	303
昼夜率		1.59	1.88	1.61	-	-	2.12	1.45	1.77	1.48	-	-	1.83

方向別自動車交通量調査表

調査地点：地域社会1 目黒

調査年月日：令和元年10月13日(日) 天候：曇りのち雨

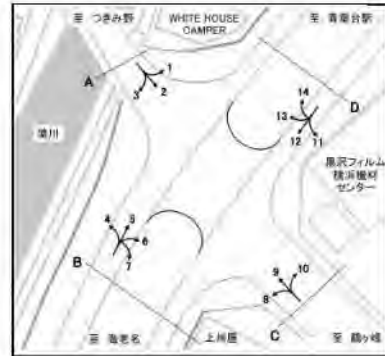

方向	4						5						
	種別	小型車 (台)	大型車 (台)	合計 (台)	大型車 混入率 (%)	時係 数 (%)	二輪車 (台)	小型車 (台)	大型車 (台)	合計 (台)	大型車 混入率 (%)	時係 数 (%)	二輪車 (台)
22:00-22:15		1	0	1	0.0	0.1	0	4	1	5	20.0	0.6	0
22:15-22:30		15	0	15	0.0	1.1	0	5	0	5	0.0	0.6	0
22:30-22:45		10	2	12	16.7	0.8	0	9	3	12	25.0	1.4	1
22:45-23:00		8	0	8	0.0	0.6	0	4	0	4	0.0	0.5	0
1時間計		34	2	36	5.6	2.5	0	22	4	26	15.4	3.0	1
23:00-23:15		14	0	14	0.0	1.0	0	1	0	1	0.0	0.1	0
23:15-23:30		8	0	8	0.0	0.6	0	6	0	6	0.0	0.7	0
23:30-23:45		3	1	4	25.0	0.3	0	1	0	1	0.0	0.1	0
23:45-24:00		13	0	13	0.0	0.9	0	0	0	0	0.0	0.0	0
1時間計		38	1	39	2.6	2.7	0	8	0	8	0.0	0.9	0
0:00-0:15		13	1	14	7.1	1.0	0	4	1	5	20.0	0.6	2
0:15-0:30		7	1	8	12.5	0.6	0	1	1	2	50.0	0.2	0
0:30-0:45		3	1	4	25.0	0.3	0	1	2	3	66.7	0.3	0
0:45-1:00		3	3	6	50.0	0.4	0	3	1	4	25.0	0.5	0
1時間計		26	6	32	18.8	2.2	0	9	5	14	35.7	1.6	2
1:00-1:15		3	1	4	25.0	0.3	1	2	0	2	0.0	0.2	0
1:15-1:30		2	0	2	0.0	0.1	0	0	1	1	100.0	0.1	0
1:30-1:45		6	2	8	25.0	0.6	0	1	0	1	0.0	0.1	0
1:45-2:00		4	1	5	20.0	0.4	0	2	1	3	33.3	0.3	0
1時間計		15	4	19	21.1	1.3	1	5	2	7	28.6	0.8	0
2:00-2:15		0	3	3	100.0	0.2	0	0	0	0	0.0	0.0	0
2:15-2:30		4	2	6	33.3	0.4	1	2	0	2	0.0	0.2	0
2:30-2:45		1	1	2	50.0	0.1	0	2	0	2	0.0	0.2	0
2:45-3:00		2	0	2	0.0	0.1	0	1	0	1	0.0	0.1	0
1時間計		7	6	13	46.2	0.9	1	5	0	5	0.0	0.6	0
3:00-3:15		4	0	4	0.0	0.3	0	1	0	1	0.0	0.1	0
3:15-3:30		3	1	4	25.0	0.3	0	0	0	0	0.0	0.0	0
3:30-3:45		3	2	5	40.0	0.4	0	0	0	0	0.0	0.0	0
3:45-4:00		1	2	3	66.7	0.2	0	4	0	4	0.0	0.5	0
1時間計		11	5	16	31.3	1.1	0	5	0	5	0.0	0.6	0
4:00-4:15		0	0	0	0.0	0.0	0	0	1	1	100.0	0.1	1
4:15-4:30		0	1	1	100.0	0.1	0	3	1	4	25.0	0.5	0
4:30-4:45		2	2	4	50.0	0.3	0	3	1	4	25.0	0.5	0
4:45-5:00		3	2	5	40.0	0.4	0	2	0	2	0.0	0.2	1
1時間計		5	5	10	50.0	0.7	0	8	3	11	27.3	1.3	2
5:00-5:15		1	2	3	66.7	0.2	0	7	1	8	12.5	0.9	1
5:15-5:30		1	0	1	0.0	0.1	1	6	2	8	25.0	0.9	0
5:30-5:45		5	4	9	44.4	0.6	0	14	0	14	0.0	1.6	0
5:45-6:00		7	1	8	12.5	0.6	0	22	2	24	8.3	2.7	0
1時間計		14	7	21	33.3	1.5	1	49	5	54	9.3	6.1	1

方向別自動車交通量調査表

調査地点 : 地域社会1 目黒

調査年月日 : 令和元年10月13日(日) 天候:曇りのち雨

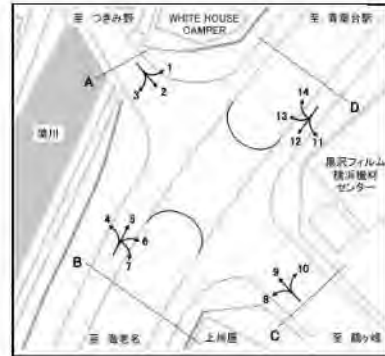

方向 時間帯	4						5					
	種別 小型車 (台)	大型車 (台)	合計 (台)	大型車 混入率 (%)	時間 係数 (%)	二輪車 (台)	小型車 (台)	大型車 (台)	合計 (台)	大型車 混入率 (%)	時間 係数 (%)	二輪車 (台)
6:00-6:15	5	1	6	16.7	0.4	1	19	2	21	9.5	2.4	0
6:15-6:30	7	0	7	0.0	0.5	1	9	1	10	10.0	1.1	2
6:30-6:45	7	1	8	12.5	0.6	0	14	3	17	17.6	1.9	1
6:45-7:00	12	0	12	0.0	0.8	0	12	1	13	7.7	1.5	2
1時間計	31	2	33	6.1	2.3	2	54	7	61	11.5	6.9	5
7:00-7:15	12	2	14	14.3	1.0	0	10	1	11	9.1	1.3	2
7:15-7:30	15	5	20	25.0	1.4	0	13	2	15	13.3	1.7	0
7:30-7:45	8	2	10	20.0	0.7	1	14	0	14	0.0	1.6	1
7:45-8:00	10	3	13	23.1	0.9	1	9	2	11	18.2	1.3	0
1時間計	45	12	57	21.1	4.0	2	46	5	51	9.8	5.8	3
8:00-8:15	12	1	13	7.7	0.9	1	11	1	12	8.3	1.4	0
8:15-8:30	19	7	26	26.9	1.8	1	11	0	11	0.0	1.3	1
8:30-8:45	14	2	16	12.5	1.1	0	11	2	13	15.4	1.5	0
8:45-9:00	15	3	18	16.7	1.3	0	7	0	7	0.0	0.8	1
1時間計	60	13	73	17.8	5.1	2	40	3	43	7.0	4.9	2
9:00-9:15	15	2	17	11.8	1.2	0	13	1	14	7.1	1.6	0
9:15-9:30	16	1	17	5.9	1.2	1	6	2	8	25.0	0.9	0
9:30-9:45	27	2	29	6.9	2.0	0	9	0	9	0.0	1.0	0
9:45-10:00	16	5	21	23.8	1.5	0	6	2	8	25.0	0.9	0
1時間計	74	10	84	11.9	5.9	1	34	5	39	12.8	4.4	0
10:00-10:15	15	2	17	11.8	1.2	0	12	1	13	7.7	1.5	0
10:15-10:30	24	2	26	7.7	1.8	0	6	2	8	25.0	0.9	0
10:30-10:45	17	1	18	5.6	1.3	0	8	3	11	27.3	1.3	2
10:45-11:00	20	2	22	9.1	1.5	2	16	0	16	0.0	1.8	0
1時間計	76	7	83	8.4	5.8	2	42	6	48	12.5	5.5	2
11:00-11:15	18	3	21	14.3	1.5	0	13	2	15	13.3	1.7	2
11:15-11:30	16	1	17	5.9	1.2	0	12	0	12	0.0	1.4	1
11:30-11:45	19	3	22	13.6	1.5	1	23	3	26	11.5	3.0	0
11:45-12:00	29	0	29	0.0	2.0	0	11	2	13	15.4	1.5	0
1時間計	82	7	89	7.9	6.3	1	59	7	66	10.6	7.5	3
12:00-12:15	22	2	24	8.3	1.7	0	13	0	13	0.0	1.5	0
12:15-12:30	21	0	21	0.0	1.5	2	23	3	26	11.5	3.0	0
12:30-12:45	38	12	50	24.0	3.5	0	9	1	10	10.0	1.1	1
12:45-13:00	29	4	33	12.1	2.3	0	8	0	8	0.0	0.9	0
1時間計	110	18	128	14.1	9.0	2	53	4	57	7.0	6.5	1
13:00-13:15	28	2	30	6.7	2.1	0	12	1	13	7.7	1.5	0
13:15-13:30	24	0	24	0.0	1.7	0	10	0	10	0.0	1.1	0
13:30-13:45	18	1	19	5.3	1.3	0	9	1	10	10.0	1.1	0
13:45-14:00	13	3	16	18.8	1.1	0	5	2	7	28.6	0.8	0
1時間計	83	6	89	6.7	6.3	0	36	4	40	10.0	4.6	0

方向別自動車交通量調査表

調査地点：地域社会1 目黒

調査年月日：令和元年10月13日(日) 天候：曇りのち雨

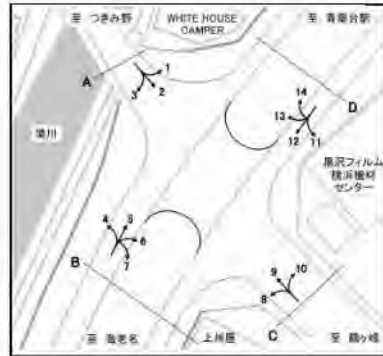

方向 種別 時間帯	4						5					
	小型車 (台)	大型車 (台)	合計 (台)	大型車 混入率 (%)	時間 係数 (%)	二輪車 (台)	小型車 (台)	大型車 (台)	合計 (台)	大型車 混入率 (%)	時間 係数 (%)	二輪車 (台)
14:00-14:15	21	2	23	8.7	1.6	0	11	0	11	0.0	1.3	0
14:15-14:30	14	2	16	12.5	1.1	0	19	0	19	0.0	2.2	2
14:30-14:45	20	4	24	16.7	1.7	0	7	0	7	0.0	0.8	0
14:45-15:00	22	3	25	12.0	1.8	0	20	1	21	4.8	2.4	0
1時間計	77	11	88	12.5	6.2	0	57	1	58	1.7	6.6	2
15:00-15:15	30	0	30	0.0	2.1	0	15	2	17	11.8	1.9	0
15:15-15:30	21	3	24	12.5	1.7	0	10	0	10	0.0	1.1	0
15:30-15:45	21	0	21	0.0	1.5	1	16	1	17	5.9	1.9	1
15:45-16:00	16	1	17	5.9	1.2	0	14	1	15	6.7	1.7	2
1時間計	88	4	92	4.3	6.5	1	55	4	59	6.8	6.7	3
16:00-16:15	18	0	18	0.0	1.3	0	11	0	11	0.0	1.3	0
16:15-16:30	15	1	16	6.3	1.1	1	11	0	11	0.0	1.3	1
16:30-16:45	15	0	15	0.0	1.1	0	10	0	10	0.0	1.1	0
16:45-17:00	13	1	14	7.1	1.0	0	5	2	7	28.6	0.8	0
1時間計	61	2	63	3.2	4.4	1	37	2	39	5.1	4.4	1
17:00-17:15	14	0	14	0.0	1.0	0	8	0	8	0.0	0.9	0
17:15-17:30	22	0	22	0.0	1.5	1	14	0	14	0.0	1.6	0
17:30-17:45	20	1	21	4.8	1.5	0	8	0	8	0.0	0.9	0
17:45-18:00	21	0	21	0.0	1.5	2	13	1	14	7.1	1.6	0
1時間計	77	1	78	1.3	5.5	3	43	1	44	2.3	5.0	0
18:00-18:15	34	1	35	2.9	2.5	0	17	1	18	5.6	2.0	0
18:15-18:30	18	2	20	10.0	1.4	0	9	2	11	18.2	1.3	0
18:30-18:45	13	0	13	0.0	0.9	0	6	2	8	25.0	0.9	1
18:45-19:00	17	0	17	0.0	1.2	0	10	0	10	0.0	1.1	0
1時間計	82	3	85	3.5	6.0	0	42	5	47	10.6	5.3	1
19:00-19:15	10	1	11	9.1	0.8	0	7	0	7	0.0	0.8	0
19:15-19:30	13	2	15	13.3	1.1	2	9	0	9	0.0	1.0	0
19:30-19:45	15	0	15	0.0	1.1	0	12	1	13	7.7	1.5	1
19:45-20:00	10	1	11	9.1	0.8	1	12	0	12	0.0	1.4	0
1時間計	48	4	52	7.7	3.7	3	40	1	41	2.4	4.7	1
20:00-20:15	20	0	20	0.0	1.4	0	10	0	10	0.0	1.1	0
20:15-20:30	19	1	20	5.0	1.4	2	10	1	11	9.1	1.3	0
20:30-20:45	23	2	25	8.0	1.8	0	8	0	8	0.0	0.9	0
20:45-21:00	19	0	19	0.0	1.3	0	8	0	8	0.0	0.9	0
1時間計	81	3	84	3.6	5.9	2	36	1	37	2.7	4.2	0
21:00-21:15	17	1	18	5.6	1.3	0	8	0	8	0.0	0.9	0
21:15-21:30	21	1	22	4.5	1.5	1	4	0	4	0.0	0.5	0
21:30-21:45	9	1	10	10.0	0.7	1	1	0	1	0.0	0.1	0
21:45-22:00	9	1	10	10.0	0.7	0	5	1	6	16.7	0.7	1
1時間計	56	4	60	6.7	4.2	2	18	1	19	5.3	2.2	1
昼12時間計	915	94	1009	9.3	70.9	15	544	47	591	8.0	67.2	18
夜12時間計	366	49	415	11.8	29.1	12	259	29	288	10.1	32.8	13
全時間合計	1281	143	1424	10.0	100.0	27	803	76	879	8.6	100.0	31
昼夜率	1.40	1.52	1.41	-	-	1.80	1.48	1.62	1.49	-	-	1.72

方向別自動車交通量調査表

調査地点：地域社会1 目黒

調査年月日：令和元年10月13日(日) 天候：曇りのち雨

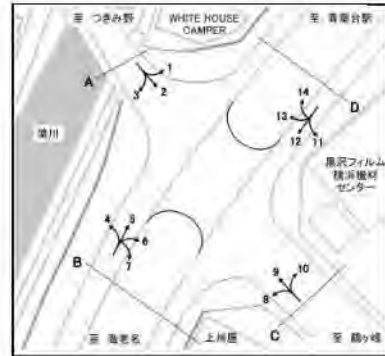

方向 種別 時間帯	6						7					
	小型車 (台)	大型車 (台)	合計 (台)	大型車 混入率 (%)	時間 係数 (%)	二輪車 (台)	小型車 (台)	大型車 (台)	合計 (台)	大型車 混入率 (%)	時間 係数 (%)	二輪車 (台)
22:00-22:15	29	5	34	14.7	0.9	1	1	0	1	0.0	4.2	0
22:15-22:30	18	6	24	25.0	0.7	2	1	0	1	0.0	4.2	0
22:30-22:45	18	4	22	18.2	0.6	0	0	0	0	0.0	0.0	0
22:45-23:00	17	7	24	29.2	0.7	2	0	0	0	0.0	0.0	0
1時間計	82	22	104	21.2	2.9	5	2	0	2	0.0	8.3	0
23:00-23:15	16	9	25	36.0	0.7	1	0	0	0	0.0	0.0	0
23:15-23:30	16	6	22	27.3	0.6	3	1	0	1	0.0	4.2	0
23:30-23:45	14	4	18	22.2	0.5	2	0	0	0	0.0	0.0	0
23:45-24:00	15	3	18	16.7	0.5	2	2	0	2	0.0	8.3	0
1時間計	61	22	83	26.5	2.3	8	3	0	3	0.0	12.5	0
0:00-0:15	13	4	17	23.5	0.5	2	0	0	0	0.0	0.0	0
0:15-0:30	11	7	18	38.9	0.5	1	0	0	0	0.0	0.0	0
0:30-0:45	9	5	14	35.7	0.4	0	0	0	0	0.0	0.0	0
0:45-1:00	13	3	16	18.8	0.4	1	0	0	0	0.0	0.0	0
1時間計	46	19	65	29.2	1.8	4	0	0	0	0.0	0.0	0
1:00-1:15	7	7	14	50.0	0.4	2	0	0	0	0.0	0.0	0
1:15-1:30	8	7	15	46.7	0.4	0	0	0	0	0.0	0.0	0
1:30-1:45	11	4	15	26.7	0.4	0	0	0	0	0.0	0.0	0
1:45-2:00	10	5	15	33.3	0.4	0	0	0	0	0.0	0.0	0
1時間計	36	23	59	39.0	1.6	2	0	0	0	0.0	0.0	0
2:00-2:15	7	2	9	22.2	0.2	0	0	0	0	0.0	0.0	0
2:15-2:30	10	5	15	33.3	0.4	0	0	0	0	0.0	0.0	0
2:30-2:45	5	3	8	37.5	0.2	0	1	0	1	0.0	4.2	0
2:45-3:00	4	4	8	50.0	0.2	0	0	0	0	0.0	0.0	0
1時間計	26	14	40	35.0	1.1	0	1	0	1	0.0	4.2	0
3:00-3:15	5	13	18	72.2	0.5	0	0	0	0	0.0	0.0	0
3:15-3:30	5	12	17	70.6	0.5	1	0	0	0	0.0	0.0	0
3:30-3:45	7	11	18	61.1	0.5	1	0	0	0	0.0	0.0	0
3:45-4:00	3	10	13	76.9	0.4	0	0	0	0	0.0	0.0	0
1時間計	20	46	66	69.7	1.8	2	0	0	0	0.0	0.0	0
4:00-4:15	6	8	14	57.1	0.4	0	1	0	1	0.0	4.2	0
4:15-4:30	17	16	33	48.5	0.9	1	0	0	0	0.0	0.0	0
4:30-4:45	9	9	18	50.0	0.5	1	0	0	0	0.0	0.0	0
4:45-5:00	20	9	29	31.0	0.8	0	0	0	0	0.0	0.0	0
1時間計	52	42	94	44.7	2.6	2	1	0	1	0.0	4.2	0
5:00-5:15	16	12	28	42.9	0.8	1	0	0	0	0.0	0.0	0
5:15-5:30	20	14	34	41.2	0.9	1	0	0	0	0.0	0.0	0
5:30-5:45	31	18	49	36.7	1.4	1	0	0	0	0.0	0.0	0
5:45-6:00	26	13	39	33.3	1.1	2	0	0	0	0.0	0.0	0
1時間計	93	57	150	38.0	4.1	5	0	0	0	0.0	0.0	0

方向別自動車交通量調査表

調査地点：地域社会1 目黒

調査年月日：令和元年10月13日(日) 天候：曇りのち雨

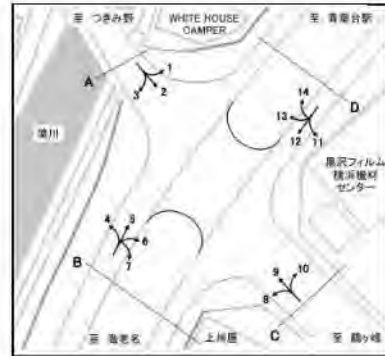

方向 時間帯	6						7					
	種別 小型車 (台)	大型車 (台)	合計 (台)	大型車 混入率 (%)	時間 係数 (%)	二輪車 (台)	小型車 (台)	大型車 (台)	合計 (台)	大型車 混入率 (%)	時間 係数 (%)	二輪車 (台)
6:00-6:15	31	8	39	20.5	1.1	0	0	0	0	0.0	0.0	0
6:15-6:30	30	14	44	31.8	1.2	4	1	0	1	0.0	4.2	0
6:30-6:45	29	23	52	44.2	1.4	2	0	0	0	0.0	0.0	0
6:45-7:00	46	20	66	30.3	1.8	4	0	0	0	0.0	0.0	0
1時間計	136	65	201	32.3	5.5	10	1	0	1	0.0	4.2	0
7:00-7:15	29	14	43	32.6	1.2	3	0	0	0	0.0	0.0	0
7:15-7:30	29	10	39	25.6	1.1	4	0	0	0	0.0	0.0	0
7:30-7:45	31	8	39	20.5	1.1	1	0	0	0	0.0	0.0	0
7:45-8:00	37	19	56	33.9	1.5	1	0	0	0	0.0	0.0	0
1時間計	126	51	177	28.8	4.9	9	0	0	0	0.0	0.0	0
8:00-8:15	33	12	45	26.7	1.2	2	0	0	0	0.0	0.0	0
8:15-8:30	26	22	48	45.8	1.3	2	0	0	0	0.0	0.0	0
8:30-8:45	38	17	55	30.9	1.5	1	0	0	0	0.0	0.0	0
8:45-9:00	31	8	39	20.5	1.1	1	0	0	0	0.0	0.0	0
1時間計	128	59	187	31.6	5.2	6	0	0	0	0.0	0.0	0
9:00-9:15	39	17	56	30.4	1.5	0	0	0	0	0.0	0.0	0
9:15-9:30	35	18	53	34.0	1.5	0	0	0	0	0.0	0.0	0
9:30-9:45	37	12	49	24.5	1.4	0	0	0	0	0.0	0.0	0
9:45-10:00	32	20	52	38.5	1.4	0	1	0	1	0.0	4.2	0
1時間計	143	67	210	31.9	5.8	0	1	0	1	0.0	4.2	0
10:00-10:15	33	24	57	42.1	1.6	2	0	0	0	0.0	0.0	0
10:15-10:30	29	15	44	34.1	1.2	2	0	0	0	0.0	0.0	0
10:30-10:45	41	8	49	16.3	1.4	0	1	0	1	0.0	4.2	0
10:45-11:00	31	16	47	34.0	1.3	0	1	0	1	0.0	4.2	0
1時間計	134	63	197	32.0	5.4	4	2	0	2	0.0	8.3	0
11:00-11:15	43	10	53	18.9	1.5	0	1	0	1	0.0	4.2	0
11:15-11:30	36	13	49	26.5	1.4	0	2	0	2	0.0	8.3	0
11:30-11:45	35	19	54	35.2	1.5	0	1	0	1	0.0	4.2	0
11:45-12:00	30	15	45	33.3	1.2	0	0	0	0	0.0	0.0	0
1時間計	144	57	201	28.4	5.5	0	4	0	4	0.0	16.7	0
12:00-12:15	34	10	44	22.7	1.2	0	0	0	0	0.0	0.0	0
12:15-12:30	34	7	41	17.1	1.1	1	0	0	0	0.0	0.0	0
12:30-12:45	20	9	29	31.0	0.8	0	0	0	0	0.0	0.0	0
12:45-13:00	23	1	24	4.2	0.7	0	0	0	0	0.0	0.0	0
1時間計	111	27	138	19.6	3.8	1	0	0	0	0.0	0.0	0
13:00-13:15	34	15	49	30.6	1.4	1	0	0	0	0.0	0.0	0
13:15-13:30	37	7	44	15.9	1.2	0	0	0	0	0.0	0.0	0
13:30-13:45	29	10	39	25.6	1.1	1	1	0	1	0.0	4.2	0
13:45-14:00	27	8	35	22.9	1.0	0	0	0	0	0.0	0.0	0
1時間計	127	40	167	24.0	4.6	2	1	0	1	0.0	4.2	0

方向別自動車交通量調査表

調査地点：地域社会1 目黒

調査年月日：令和元年10月13日(日) 天候：曇りのち雨

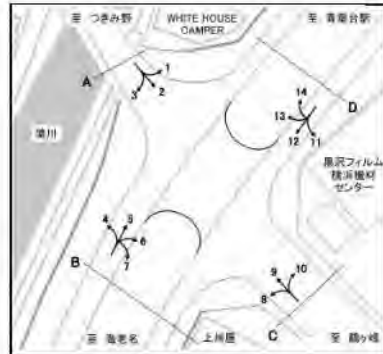

方向 種別 時間帯	6						7					
	小型車 (台)	大型車 (台)	合計 (台)	大型車 混入率 (%)	時間 係数 (%)	二輪車 (台)	小型車 (台)	大型車 (台)	合計 (台)	大型車 混入率 (%)	時間 係数 (%)	二輪車 (台)
14:00-14:15	38	12	50	24.0	1.4	1	0	0	0	0.0	0.0	0
14:15-14:30	21	8	29	27.6	0.8	1	0	0	0	0.0	0.0	0
14:30-14:45	42	5	47	10.6	1.3	0	0	0	0	0.0	0.0	0
14:45-15:00	39	13	52	25.0	1.4	1	0	0	0	0.0	0.0	0
1時間計	140	38	178	21.3	4.9	3	0	0	0	0.0	0.0	0
15:00-15:15	50	11	61	18.0	1.7	1	0	0	0	0.0	0.0	0
15:15-15:30	43	6	49	12.2	1.4	1	0	0	0	0.0	0.0	0
15:30-15:45	43	16	59	27.1	1.6	0	0	0	0	0.0	0.0	0
15:45-16:00	36	13	49	26.5	1.4	1	0	0	0	0.0	0.0	0
1時間計	172	46	218	21.1	6.0	3	0	0	0	0.0	0.0	0
16:00-16:15	44	17	61	27.9	1.7	0	0	0	0	0.0	0.0	0
16:15-16:30	27	10	37	27.0	1.0	0	0	0	0	0.0	0.0	0
16:30-16:45	30	14	44	31.8	1.2	1	1	0	1	0.0	4.2	0
16:45-17:00	39	10	49	20.4	1.4	0	2	1	3	33.3	12.5	0
1時間計	140	51	191	26.7	5.3	1	3	1	4	25.0	16.7	0
17:00-17:15	39	12	51	23.5	1.4	1	0	0	0	0.0	0.0	0
17:15-17:30	39	10	49	20.4	1.4	3	0	0	0	0.0	0.0	0
17:30-17:45	27	6	33	18.2	0.9	1	0	0	0	0.0	0.0	0
17:45-18:00	44	7	51	13.7	1.4	1	1	0	1	0.0	4.2	0
1時間計	149	35	184	19.0	5.1	6	1	0	1	0.0	4.2	0
18:00-18:15	49	12	61	19.7	1.7	3	1	0	1	0.0	4.2	0
18:15-18:30	42	7	49	14.3	1.4	2	0	0	0	0.0	0.0	0
18:30-18:45	39	12	51	23.5	1.4	0	2	0	2	0.0	8.3	0
18:45-19:00	36	11	47	23.4	1.3	0	0	0	0	0.0	0.0	0
1時間計	166	42	208	20.2	5.7	5	3	0	3	0.0	12.5	0
19:00-19:15	43	10	53	18.9	1.5	0	0	0	0	0.0	0.0	0
19:15-19:30	46	9	55	16.4	1.5	1	0	0	0	0.0	0.0	0
19:30-19:45	24	11	35	31.4	1.0	1	0	0	0	0.0	0.0	0
19:45-20:00	33	4	37	10.8	1.0	2	0	0	0	0.0	0.0	0
1時間計	146	34	180	18.9	5.0	4	0	0	0	0.0	0.0	0
20:00-20:15	28	11	39	28.2	1.1	0	0	0	0	0.0	0.0	0
20:15-20:30	32	16	48	33.3	1.3	0	0	0	0	0.0	0.0	0
20:30-20:45	37	13	50	26.0	1.4	0	0	0	0	0.0	0.0	0
20:45-21:00	39	12	51	23.5	1.4	0	0	0	0	0.0	0.0	0
1時間計	136	52	188	27.7	5.2	0	0	0	0	0.0	0.0	0
21:00-21:15	37	10	47	21.3	1.3	1	0	0	0	0.0	0.0	0
21:15-21:30	31	9	40	22.5	1.1	3	0	0	0	0.0	0.0	0
21:30-21:45	23	7	30	23.3	0.8	0	0	0	0	0.0	0.0	0
21:45-22:00	17	4	21	19.0	0.6	2	0	0	0	0.0	0.0	0
1時間計	108	30	138	21.7	3.8	6	0	0	0	0.0	0.0	0
昼12時間計	1680	576	2256	25.5	62.3	40	15	1	16	6.3	66.7	0
夜12時間計	942	426	1368	31.1	37.7	48	8	0	8	0.0	33.3	0
全時間合計	2622	1002	3624	27.6	100.0	88	23	1	24	4.2	100.0	0
昼夜率	1.56	1.74	1.61	-	-	2.20	1.53	1.00	1.50	-	-	0.00

方向別自動車交通量調査表

調査地点：地域社会1 目黒

調査年月日：令和元年10月13日(日) 天候：曇りのち雨

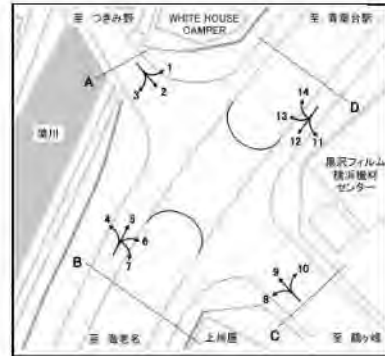

方向 種別 時間帯							B 合計 (4+ 5+ 6+ 7)					
	小型車 (台)	大型車 (台)	合計 (台)	大型車 混入率 (%)	時間 係数 (%)	二輪車 (台)	小型車 (台)	大型車 (台)	合計 (台)	大型車 混入率 (%)	時間 係数 (%)	二輪車 (台)
22:00-22:15							35	6	41	14.6	0.7	1
22:15-22:30							39	6	45	13.3	0.8	2
22:30-22:45							37	9	46	19.6	0.8	1
22:45-23:00							29	7	36	19.4	0.6	2
1時間計							140	28	168	16.7	2.8	6
23:00-23:15							31	9	40	22.5	0.7	1
23:15-23:30							31	6	37	16.2	0.6	3
23:30-23:45							18	5	23	21.7	0.4	2
23:45-24:00							30	3	33	9.1	0.6	2
1時間計							110	23	133	17.3	2.2	8
0:00- 0:15							30	6	36	16.7	0.6	4
0:15- 0:30							19	9	28	32.1	0.5	1
0:30- 0:45							13	8	21	38.1	0.4	0
0:45- 1:00							19	7	26	26.9	0.4	1
1時間計							81	30	111	27.0	1.9	6
1:00- 1:15							12	8	20	40.0	0.3	3
1:15- 1:30							10	8	18	44.4	0.3	0
1:30- 1:45							18	6	24	25.0	0.4	0
1:45- 2:00							16	7	23	30.4	0.4	0
1時間計							56	29	85	34.1	1.4	3
2:00- 2:15							7	5	12	41.7	0.2	0
2:15- 2:30							16	7	23	30.4	0.4	1
2:30- 2:45							9	4	13	30.8	0.2	0
2:45- 3:00							7	4	11	36.4	0.2	0
1時間計							39	20	59	33.9	1.0	1
3:00- 3:15							10	13	23	56.5	0.4	0
3:15- 3:30							8	13	21	61.9	0.4	1
3:30- 3:45							10	13	23	56.5	0.4	1
3:45- 4:00							8	12	20	60.0	0.3	0
1時間計							36	51	87	58.6	1.5	2
4:00- 4:15							7	9	16	56.3	0.3	1
4:15- 4:30							20	18	38	47.4	0.6	1
4:30- 4:45							14	12	26	46.2	0.4	1
4:45- 5:00							25	11	36	30.6	0.6	1
1時間計							66	50	116	43.1	1.9	4
5:00- 5:15							24	15	39	38.5	0.7	2
5:15- 5:30							27	16	43	37.2	0.7	2
5:30- 5:45							50	22	72	30.6	1.2	1
5:45- 6:00							55	16	71	22.5	1.2	2
1時間計							156	69	225	30.7	3.8	7

方向別自動車交通量調査表

調査地点：地域社会1 目黒

調査年月日：令和元年10月13日(日) 天候：曇りのち雨

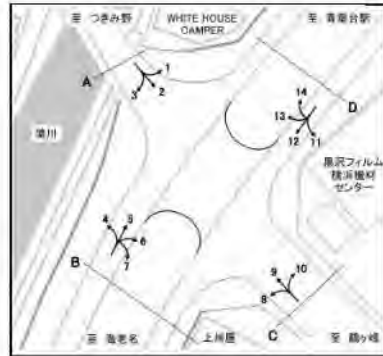

時間帯	方向 種別						B 合計 (4+ 5+ 6+ 7)					
		小型車 (台)	大型車 (台)	合計 (台)	大型車 混入率 (%)	時間 係数 (%)	二輪車 (台)	小型車 (台)	大型車 (台)	合計 (台)	大型車 混入率 (%)	時間 係数 (%)
6:00-6:15							55	11	66	16.7	1.1	1
6:15-6:30							47	15	62	24.2	1.0	7
6:30-6:45							50	27	77	35.1	1.3	3
6:45-7:00							70	21	91	23.1	1.5	6
1時間計							222	74	296	25.0	5.0	17
7:00-7:15							51	17	68	25.0	1.1	5
7:15-7:30							57	17	74	23.0	1.2	4
7:30-7:45							53	10	63	15.9	1.1	3
7:45-8:00							56	24	80	30.0	1.3	2
1時間計							217	68	285	23.9	4.8	14
8:00-8:15							56	14	70	20.0	1.2	3
8:15-8:30							56	29	85	34.1	1.4	4
8:30-8:45							63	21	84	25.0	1.4	1
8:45-9:00							53	11	64	17.2	1.1	2
1時間計							228	75	303	24.8	5.1	10
9:00-9:15							67	20	87	23.0	1.5	0
9:15-9:30							57	21	78	26.9	1.3	1
9:30-9:45							73	14	87	16.1	1.5	0
9:45-10:00							55	27	82	32.9	1.4	0
1時間計							252	82	334	24.6	5.6	1
10:00-10:15							60	27	87	31.0	1.5	2
10:15-10:30							59	19	78	24.4	1.3	2
10:30-10:45							67	12	79	15.2	1.3	2
10:45-11:00							68	18	86	20.9	1.4	2
1時間計							254	76	330	23.0	5.5	8
11:00-11:15							75	15	90	16.7	1.5	2
11:15-11:30							66	14	80	17.5	1.3	1
11:30-11:45							78	25	103	24.3	1.7	1
11:45-12:00							70	17	87	19.5	1.5	0
1時間計							289	71	360	19.7	6.0	4
12:00-12:15							69	12	81	14.8	1.4	0
12:15-12:30							78	10	88	11.4	1.5	3
12:30-12:45							67	22	89	24.7	1.5	1
12:45-13:00							60	5	65	7.7	1.1	0
1時間計							274	49	323	15.2	5.4	4
13:00-13:15							74	18	92	19.6	1.5	1
13:15-13:30							71	7	78	9.0	1.3	0
13:30-13:45							57	12	69	17.4	1.2	1
13:45-14:00							45	13	58	22.4	1.0	0
1時間計							247	50	297	16.8	5.0	2

方向別自動車交通量調査表

調査地点：地域社会1 目黒

調査年月日：令和元年10月13日(日) 天候：曇りのち雨

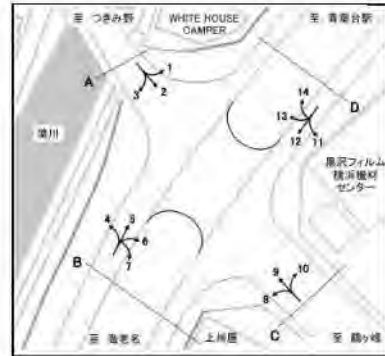

方向							B 合計 (4+ 5+ 6+ 7)					
	種別	小型車 (台)	大型車 (台)	合計 (台)	大型車 混入率 (%)	時係 数 (%)	二輪車 (台)	小型車 (台)	大型車 (台)	合計 (台)	大型車 混入率 (%)	時係 数 (%)
14:00-14:15							70	14	84	16.7	1.4	1
14:15-14:30							54	10	64	15.6	1.1	3
14:30-14:45							69	9	78	11.5	1.3	0
14:45-15:00							81	17	98	17.3	1.6	1
1時間計							274	50	324	15.4	5.4	5
15:00-15:15							95	13	108	12.0	1.8	1
15:15-15:30							74	9	83	10.8	1.4	1
15:30-15:45							80	17	97	17.5	1.6	2
15:45-16:00							66	15	81	18.5	1.4	3
1時間計							315	54	369	14.6	6.2	7
16:00-16:15							73	17	90	18.9	1.5	0
16:15-16:30							53	11	64	17.2	1.1	2
16:30-16:45							56	14	70	20.0	1.2	1
16:45-17:00							59	14	73	19.2	1.2	0
1時間計							241	56	297	18.9	5.0	3
17:00-17:15							61	12	73	16.4	1.2	1
17:15-17:30							75	10	85	11.8	1.4	4
17:30-17:45							55	7	62	11.3	1.0	1
17:45-18:00							79	8	87	9.2	1.5	3
1時間計							270	37	307	12.1	5.2	9
18:00-18:15							101	14	115	12.2	1.9	3
18:15-18:30							69	11	80	13.8	1.3	2
18:30-18:45							60	14	74	18.9	1.2	1
18:45-19:00							63	11	74	14.9	1.2	0
1時間計							293	50	343	14.6	5.8	6
19:00-19:15							60	11	71	15.5	1.2	0
19:15-19:30							68	11	79	13.9	1.3	3
19:30-19:45							51	12	63	19.0	1.1	2
19:45-20:00							55	5	60	8.3	1.0	3
1時間計							234	39	273	14.3	4.6	8
20:00-20:15							58	11	69	15.9	1.2	0
20:15-20:30							61	18	79	22.8	1.3	2
20:30-20:45							68	15	83	18.1	1.4	0
20:45-21:00							66	12	78	15.4	1.3	0
1時間計							253	56	309	18.1	5.2	2
21:00-21:15							62	11	73	15.1	1.2	1
21:15-21:30							56	10	66	15.2	1.1	4
21:30-21:45							33	8	41	19.5	0.7	1
21:45-22:00							31	6	37	16.2	0.6	3
1時間計							182	35	217	16.1	3.6	9
昼12時間計							3154	718	3872	18.5	65.1	73
夜12時間計							1575	504	2079	24.2	34.9	73
全時間合計							4729	1222	5951	20.5	100.0	146
昼夜率							1.50	1.70	1.54	-	-	2.00

方向別自動車交通量調査表

調査地点：地域社会1 目黒

調査年月日：令和元年10月13日(日) 天候：曇りのち雨

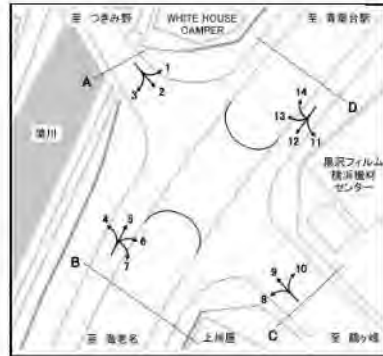

方向	8						9					
	小型車 (台)	大型車 (台)	合計 (台)	大型車 混入率 (%)	時間 係数 (%)	二輪車 (台)	小型車 (台)	大型車 (台)	合計 (台)	大型車 混入率 (%)	時間 係数 (%)	二輪車 (台)
22:00-22:15	37	3	40	7.5	0.7	2	49	3	52	5.8	0.7	0
22:15-22:30	51	5	56	8.9	1.0	2	56	1	57	1.8	0.8	3
22:30-22:45	33	2	35	5.7	0.6	3	36	5	41	12.2	0.6	3
22:45-23:00	15	10	25	40.0	0.5	3	25	2	27	7.4	0.4	1
1時間計	136	20	156	12.8	2.8	10	166	11	177	6.2	2.4	7
23:00-23:15	32	7	39	17.9	0.7	0	60	7	67	10.4	0.9	3
23:15-23:30	21	8	29	27.6	0.5	1	27	8	35	22.9	0.5	3
23:30-23:45	25	10	35	28.6	0.6	0	31	10	41	24.4	0.6	1
23:45-24:00	25	6	31	19.4	0.6	0	23	3	26	11.5	0.4	2
1時間計	103	31	134	23.1	2.4	1	141	28	169	16.6	2.3	9
0:00-0:15	22	4	26	15.4	0.5	0	23	5	28	17.9	0.4	3
0:15-0:30	14	8	22	36.4	0.4	0	20	10	30	33.3	0.4	1
0:30-0:45	10	9	19	47.4	0.3	0	25	4	29	13.8	0.4	2
0:45-1:00	19	13	32	40.6	0.6	0	10	8	18	44.4	0.2	2
1時間計	65	34	99	34.3	1.8	0	78	27	105	25.7	1.4	8
1:00-1:15	16	8	24	33.3	0.4	0	18	9	27	33.3	0.4	2
1:15-1:30	12	11	23	47.8	0.4	1	10	4	14	28.6	0.2	3
1:30-1:45	12	5	17	29.4	0.3	1	8	12	20	60.0	0.3	1
1:45-2:00	15	7	22	31.8	0.4	1	20	11	31	35.5	0.4	0
1時間計	55	31	86	36.0	1.6	3	56	36	92	39.1	1.3	6
2:00-2:15	11	19	30	63.3	0.5	0	16	9	25	36.0	0.3	0
2:15-2:30	15	7	22	31.8	0.4	0	12	10	22	45.5	0.3	0
2:30-2:45	5	13	18	72.2	0.3	1	11	11	22	50.0	0.3	1
2:45-3:00	16	10	26	38.5	0.5	0	20	8	28	28.6	0.4	1
1時間計	47	49	96	51.0	1.8	1	59	38	97	39.2	1.3	2
3:00-3:15	5	13	18	72.2	0.3	0	4	4	8	50.0	0.1	0
3:15-3:30	5	3	8	37.5	0.1	1	4	7	11	63.6	0.1	2
3:30-3:45	7	11	18	61.1	0.3	0	4	14	18	77.8	0.2	2
3:45-4:00	11	6	17	35.3	0.3	0	14	12	26	46.2	0.4	1
1時間計	28	33	61	54.1	1.1	1	26	37	63	58.7	0.9	5
4:00-4:15	7	16	23	69.6	0.4	0	3	15	18	83.3	0.2	0
4:15-4:30	9	16	25	64.0	0.5	0	5	6	11	54.5	0.1	2
4:30-4:45	10	12	22	54.5	0.4	0	12	6	18	33.3	0.2	1
4:45-5:00	11	6	17	35.3	0.3	0	6	6	12	50.0	0.2	0
1時間計	37	50	87	57.5	1.6	0	26	33	59	55.9	0.8	3
5:00-5:15	18	25	43	58.1	0.8	2	18	13	31	41.9	0.4	5
5:15-5:30	16	15	31	48.4	0.6	1	20	7	27	25.9	0.4	3
5:30-5:45	15	11	26	42.3	0.5	3	20	8	28	28.6	0.4	2
5:45-6:00	25	12	37	32.4	0.7	0	28	9	37	24.3	0.5	0
1時間計	74	63	137	46.0	2.5	6	86	37	123	30.1	1.7	10

方向別自動車交通量調査表

調査地点：地域社会1 目黒

調査年月日：令和元年10月13日(日) 天候：曇りのち雨

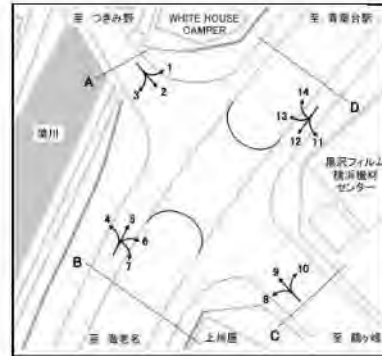

方向 時間帯	8						9					
	種別 小型車 (台)	大型車 (台)	合計 (台)	大型車 混入率 (%)	時間 係数 (%)	二輪車 (台)	小型車 (台)	大型車 (台)	合計 (台)	大型車 混入率 (%)	時間 係数 (%)	二輪車 (台)
6:00-6:15	54	26	80	32.5	1.5	1	54	3	57	5.3	0.8	3
6:15-6:30	41	16	57	28.1	1.0	0	44	9	53	17.0	0.7	3
6:30-6:45	37	17	54	31.5	1.0	1	60	14	74	18.9	1.0	4
6:45-7:00	62	13	75	17.3	1.4	8	57	27	84	32.1	1.1	7
1時間計	194	72	266	27.1	4.9	10	215	53	268	19.8	3.6	17
7:00-7:15	35	20	55	36.4	1.0	1	68	9	77	11.7	1.0	7
7:15-7:30	79	18	97	18.6	1.8	2	68	20	88	22.7	1.2	5
7:30-7:45	69	16	85	18.8	1.6	3	87	13	100	13.0	1.4	8
7:45-8:00	56	23	79	29.1	1.4	4	64	17	81	21.0	1.1	3
1時間計	239	77	316	24.4	5.8	10	287	59	346	17.1	4.7	23
8:00-8:15	89	15	104	14.4	1.9	1	80	12	92	13.0	1.3	5
8:15-8:30	56	19	75	25.3	1.4	2	70	11	81	13.6	1.1	8
8:30-8:45	36	19	55	34.5	1.0	1	67	13	80	16.3	1.1	5
8:45-9:00	75	16	91	17.6	1.7	1	79	7	86	8.1	1.2	4
1時間計	256	69	325	21.2	5.9	5	296	43	339	12.7	4.6	22
9:00-9:15	49	15	64	23.4	1.2	0	62	14	76	18.4	1.0	2
9:15-9:30	43	22	65	33.8	1.2	1	81	22	103	21.4	1.4	6
9:30-9:45	39	15	54	27.8	1.0	2	103	13	116	11.2	1.6	5
9:45-10:00	70	14	84	16.7	1.5	0	114	11	125	8.8	1.7	4
1時間計	201	66	267	24.7	4.9	3	360	60	420	14.3	5.7	17
10:00-10:15	60	21	81	25.9	1.5	2	90	13	103	12.6	1.4	2
10:15-10:30	59	23	82	28.0	1.5	0	106	10	116	8.6	1.6	1
10:30-10:45	69	21	90	23.3	1.6	2	117	13	130	10.0	1.8	1
10:45-11:00	50	16	66	24.2	1.2	0	109	11	120	9.2	1.6	0
1時間計	238	81	319	25.4	5.8	4	422	47	469	10.0	6.4	4
11:00-11:15	71	17	88	19.3	1.6	1	109	14	123	11.4	1.7	1
11:15-11:30	77	15	92	16.3	1.7	0	113	14	127	11.0	1.7	1
11:30-11:45	60	24	84	28.6	1.5	1	104	19	123	15.4	1.7	2
11:45-12:00	53	23	76	30.3	1.4	0	109	10	119	8.4	1.6	3
1時間計	261	79	340	23.2	6.2	2	435	57	492	11.6	6.7	7
12:00-12:15	48	25	73	34.2	1.3	0	117	10	127	7.9	1.7	0
12:15-12:30	62	11	73	15.1	1.3	0	85	12	97	12.4	1.3	3
12:30-12:45	59	20	79	25.3	1.4	1	98	14	112	12.5	1.5	1
12:45-13:00	53	18	71	25.4	1.3	1	95	15	110	13.6	1.5	1
1時間計	222	74	296	25.0	5.4	2	395	51	446	11.4	6.1	5
13:00-13:15	43	23	66	34.8	1.2	0	93	3	96	3.1	1.3	0
13:15-13:30	26	20	46	43.5	0.8	0	58	8	66	12.1	0.9	1
13:30-13:45	64	14	78	17.9	1.4	1	100	17	117	14.5	1.6	1
13:45-14:00	62	12	74	16.2	1.4	0	71	9	80	11.3	1.1	2
1時間計	195	69	264	26.1	4.8	1	322	37	359	10.3	4.9	4

方向別自動車交通量調査表

調査地点：地域社会1 目黒

調査年月日：令和元年10月13日(日) 天候：曇りのち雨

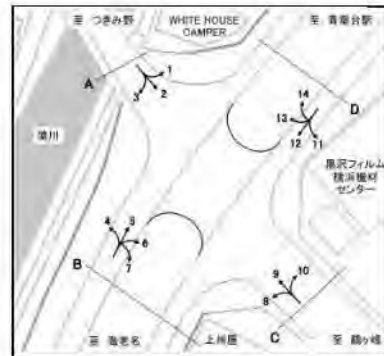

時間帯	8						9					
	小型車 (台)	大型車 (台)	合計 (台)	大型車 混入率 (%)	時 間 係 数 (%)	二輪車 (台)	小型車 (台)	大型車 (台)	合計 (台)	大型車 混入率 (%)	時 間 係 数 (%)	二輪車 (台)
14:00-14:15	48	14	62	22.6	1.1	1	100	14	114	12.3	1.5	0
14:15-14:30	58	13	71	18.3	1.3	1	111	18	129	14.0	1.8	4
14:30-14:45	69	15	84	17.9	1.5	1	123	10	133	7.5	1.8	2
14:45-15:00	45	11	56	19.6	1.0	0	101	4	105	3.8	1.4	2
1時間計	220	53	273	19.4	5.0	3	435	46	481	9.6	6.5	8
15:00-15:15	65	20	85	23.5	1.6	2	116	12	128	9.4	1.7	4
15:15-15:30	58	7	65	10.8	1.2	1	92	5	97	5.2	1.3	2
15:30-15:45	38	24	62	38.7	1.1	0	72	10	82	12.2	1.1	2
15:45-16:00	72	16	88	18.2	1.6	0	108	11	119	9.2	1.6	4
1時間計	233	67	300	22.3	5.5	3	388	38	426	8.9	5.8	12
16:00-16:15	58	16	74	21.6	1.4	0	93	9	102	8.8	1.4	4
16:15-16:30	62	14	76	18.4	1.4	1	120	7	127	5.5	1.7	2
16:30-16:45	60	9	69	13.0	1.3	1	118	2	120	1.7	1.6	6
16:45-17:00	68	10	78	12.8	1.4	1	102	7	109	6.4	1.5	1
1時間計	248	49	297	16.5	5.4	3	433	25	458	5.5	6.2	13
17:00-17:15	52	9	61	14.8	1.1	3	129	8	137	5.8	1.9	1
17:15-17:30	76	10	86	11.6	1.6	5	110	11	121	9.1	1.6	7
17:30-17:45	69	9	78	11.5	1.4	2	128	7	135	5.2	1.8	11
17:45-18:00	58	8	66	12.1	1.2	0	103	5	108	4.6	1.5	5
1時間計	255	36	291	12.4	5.3	10	470	31	501	6.2	6.8	24
18:00-18:15	94	11	105	10.5	1.9	3	131	7	138	5.1	1.9	7
18:15-18:30	60	13	73	17.8	1.3	0	101	5	106	4.7	1.4	8
18:30-18:45	102	13	115	11.3	2.1	0	146	13	159	8.2	2.2	5
18:45-19:00	63	13	76	17.1	1.4	0	97	5	102	4.9	1.4	8
1時間計	319	50	369	13.6	6.7	3	475	30	505	5.9	6.9	28
19:00-19:15	71	8	79	10.1	1.4	0	151	8	159	5.0	2.2	4
19:15-19:30	32	7	39	17.9	0.7	0	45	4	49	8.2	0.7	0
19:30-19:45	54	11	65	16.9	1.2	2	95	7	102	6.9	1.4	2
19:45-20:00	38	5	43	11.6	0.8	0	50	9	59	15.3	0.8	3
1時間計	195	31	226	13.7	4.1	2	341	28	369	7.6	5.0	9
20:00-20:15	53	11	64	17.2	1.2	1	76	6	82	7.3	1.1	2
20:15-20:30	57	9	66	13.6	1.2	1	98	8	106	7.5	1.4	7
20:30-20:45	23	12	35	34.3	0.6	0	52	9	61	14.8	0.8	2
20:45-21:00	51	13	64	20.3	1.2	1	52	3	55	5.5	0.7	1
1時間計	184	45	229	19.7	4.2	3	278	26	304	8.6	4.1	12
21:00-21:15	92	16	108	14.8	2.0	2	118	7	125	5.6	1.7	4
21:15-21:30	47	7	54	13.0	1.0	4	63	8	71	11.3	1.0	3
21:30-21:45	33	10	43	23.3	0.8	1	43	5	48	10.4	0.7	2
21:45-22:00	30	7	37	18.9	0.7	0	43	4	47	8.5	0.6	0
1時間計	202	40	242	16.5	4.4	7	267	24	291	8.2	4.0	9
昼12時間計	2887	770	3657	21.1	66.8	49	4718	524	5242	10.0	71.2	167
夜12時間計	1320	499	1819	27.4	33.2	44	1739	378	2117	17.9	28.8	97
全時間合計	4207	1269	5476	23.2	100.0	93	6457	902	7359	12.3	100.0	264
昼 夜 率	1.46	1.65	1.50	-	-	1.90	1.37	1.72	1.40	-	-	1.58

方向別自動車交通量調査表

調査地点：地域社会1 目黒

調査年月日：令和元年10月13日(日) 天候：曇りのち雨

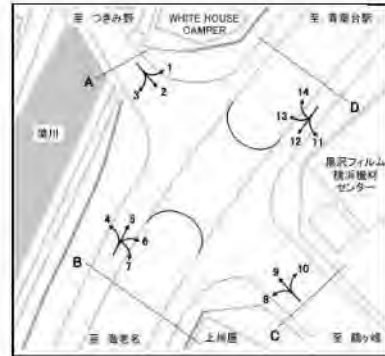

方向 種別 時間帯	10						C 合計 (8+9+10)					
	小型車 (台)	大型車 (台)	合計 (台)	大型車 混入率 (%)	時間 係数 (%)	二輪車 (台)	小型車 (台)	大型車 (台)	合計 (台)	大型車 混入率 (%)	時間 係数 (%)	二輪車 (台)
22:00-22:15	17	0	17	0.0	1.0	0	103	6	109	5.5	0.7	2
22:15-22:30	16	4	20	20.0	1.2	0	123	10	133	7.5	0.9	5
22:30-22:45	16	0	16	0.0	0.9	2	85	7	92	7.6	0.6	8
22:45-23:00	20	5	25	20.0	1.5	0	60	17	77	22.1	0.5	4
1時間計	69	9	78	11.5	4.5	2	371	40	411	9.7	2.8	19
23:00-23:15	15	1	16	6.3	0.9	0	107	15	122	12.3	0.8	3
23:15-23:30	3	1	4	25.0	0.2	0	51	17	68	25.0	0.5	4
23:30-23:45	7	3	10	30.0	0.6	0	63	23	86	26.7	0.6	1
23:45-24:00	8	2	10	20.0	0.6	0	56	11	67	16.4	0.5	2
1時間計	33	7	40	17.5	2.3	0	277	66	343	19.2	2.4	10
0:00-0:15	5	3	8	37.5	0.5	0	50	12	62	19.4	0.4	3
0:15-0:30	2	1	3	33.3	0.2	0	36	19	55	34.5	0.4	1
0:30-0:45	2	3	5	60.0	0.3	1	37	16	53	30.2	0.4	3
0:45-1:00	1	2	3	66.7	0.2	0	30	23	53	43.4	0.4	2
1時間計	10	9	19	47.4	1.1	1	153	70	223	31.4	1.5	9
1:00-1:15	0	0	0	0.0	0.0	0	34	17	51	33.3	0.4	2
1:15-1:30	1	2	3	66.7	0.2	0	23	17	40	42.5	0.3	4
1:30-1:45	0	3	3	100.0	0.2	0	20	20	40	50.0	0.3	2
1:45-2:00	2	1	3	33.3	0.2	0	37	19	56	33.9	0.4	1
1時間計	3	6	9	66.7	0.5	0	114	73	187	39.0	1.3	9
2:00-2:15	4	3	7	42.9	0.4	0	31	31	62	50.0	0.4	0
2:15-2:30	2	3	5	60.0	0.3	0	29	20	49	40.8	0.3	0
2:30-2:45	3	2	5	40.0	0.3	0	19	26	45	57.8	0.3	2
2:45-3:00	3	3	6	50.0	0.3	0	39	21	60	35.0	0.4	1
1時間計	12	11	23	47.8	1.3	0	118	98	216	45.4	1.5	3
3:00-3:15	0	0	0	0.0	0.0	0	9	17	26	65.4	0.2	0
3:15-3:30	1	0	1	0.0	0.1	0	10	10	20	50.0	0.1	3
3:30-3:45	3	3	6	50.0	0.3	0	14	28	42	66.7	0.3	2
3:45-4:00	0	3	3	100.0	0.2	0	25	21	46	45.7	0.3	1
1時間計	4	6	10	60.0	0.6	0	58	76	134	56.7	0.9	6
4:00-4:15	3	1	4	25.0	0.2	0	13	32	45	71.1	0.3	0
4:15-4:30	1	3	4	75.0	0.2	0	15	25	40	62.5	0.3	2
4:30-4:45	0	2	2	100.0	0.1	0	22	20	42	47.6	0.3	1
4:45-5:00	3	4	7	57.1	0.4	0	20	16	36	44.4	0.2	0
1時間計	7	10	17	58.8	1.0	0	70	93	163	57.1	1.1	3
5:00-5:15	3	2	5	40.0	0.3	0	39	40	79	50.6	0.5	7
5:15-5:30	2	4	6	66.7	0.3	0	38	26	64	40.6	0.4	4
5:30-5:45	4	5	9	55.6	0.5	0	39	24	63	38.1	0.4	5
5:45-6:00	5	4	9	44.4	0.5	0	58	25	83	30.1	0.6	0
1時間計	14	15	29	51.7	1.7	0	174	115	289	39.8	2.0	16

方向別自動車交通量調査表

調査地点：地域社会1 目黒

調査年月日：令和元年10月13日(日) 天候：曇りのち雨

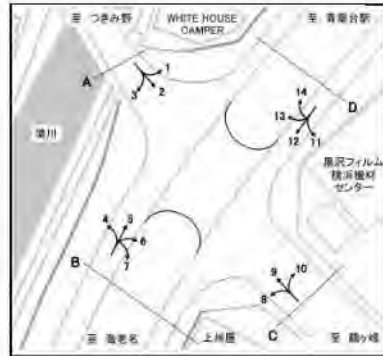

時間帯	10						C 合計 (8+9+10)					
	小型車 (台)	大型車 (台)	合計 (台)	大型車 混入率 (%)	時間 係数 (%)	二輪車 (台)	小型車 (台)	大型車 (台)	合計 (台)	大型車 混入率 (%)	時間 係数 (%)	二輪車 (台)
6:00-6:15	7	2	9	22.2	0.5	1	115	31	146	21.2	1.0	5
6:15-6:30	5	5	10	50.0	0.6	0	90	30	120	25.0	0.8	3
6:30-6:45	5	5	10	50.0	0.6	0	102	36	138	26.1	0.9	5
6:45-7:00	9	7	16	43.8	0.9	0	128	47	175	26.9	1.2	15
1時間計	26	19	45	42.2	2.6	1	435	144	579	24.9	4.0	28
7:00-7:15	17	9	26	34.6	1.5	0	120	38	158	24.1	1.1	8
7:15-7:30	24	8	32	25.0	1.9	3	171	46	217	21.2	1.5	10
7:30-7:45	14	11	25	44.0	1.5	0	170	40	210	19.0	1.4	11
7:45-8:00	26	5	31	16.1	1.8	2	146	45	191	23.6	1.3	9
1時間計	81	33	114	28.9	6.6	5	607	169	776	21.8	5.3	38
8:00-8:15	27	4	31	12.9	1.8	1	196	31	227	13.7	1.6	7
8:15-8:30	15	8	23	34.8	1.3	0	141	38	179	21.2	1.2	10
8:30-8:45	31	11	42	26.2	2.4	3	134	43	177	24.3	1.2	9
8:45-9:00	10	5	15	33.3	0.9	1	164	28	192	14.6	1.3	6
1時間計	83	28	111	25.2	6.5	5	635	140	775	18.1	5.3	32
9:00-9:15	22	6	28	21.4	1.6	1	133	35	168	20.8	1.2	3
9:15-9:30	9	5	14	35.7	0.8	0	133	49	182	26.9	1.3	7
9:30-9:45	14	12	26	46.2	1.5	1	156	40	196	20.4	1.3	8
9:45-10:00	19	4	23	17.4	1.3	0	203	29	232	12.5	1.6	4
1時間計	64	27	91	29.7	5.3	2	625	153	778	19.7	5.3	22
10:00-10:15	20	7	27	25.9	1.6	0	170	41	211	19.4	1.4	4
10:15-10:30	18	8	26	30.8	1.5	0	183	41	224	18.3	1.5	1
10:30-10:45	15	9	24	37.5	1.4	0	201	43	244	17.6	1.7	3
10:45-11:00	19	8	27	29.6	1.6	0	178	35	213	16.4	1.5	0
1時間計	72	32	104	30.8	6.1	0	732	160	892	17.9	6.1	8
11:00-11:15	10	10	20	50.0	1.2	0	190	41	231	17.7	1.6	2
11:15-11:30	17	4	21	19.0	1.2	0	207	33	240	13.8	1.6	1
11:30-11:45	14	2	16	12.5	0.9	0	178	45	223	20.2	1.5	3
11:45-12:00	14	3	17	17.6	1.0	0	176	36	212	17.0	1.5	3
1時間計	55	19	74	25.7	4.3	0	751	155	906	17.1	6.2	9
12:00-12:15	14	6	20	30.0	1.2	0	179	41	220	18.6	1.5	0
12:15-12:30	15	4	19	21.1	1.1	0	162	27	189	14.3	1.3	3
12:30-12:45	18	3	21	14.3	1.2	3	175	37	212	17.5	1.5	5
12:45-13:00	20	7	27	25.9	1.6	0	168	40	208	19.2	1.4	2
1時間計	67	20	87	23.0	5.1	3	684	145	829	17.5	5.7	10
13:00-13:15	46	18	64	28.1	3.7	0	182	44	226	19.5	1.6	0
13:15-13:30	10	4	14	28.6	0.8	0	94	32	126	25.4	0.9	1
13:30-13:45	22	10	32	31.3	1.9	0	186	41	227	18.1	1.6	2
13:45-14:00	12	5	17	29.4	1.0	0	145	26	171	15.2	1.2	2
1時間計	90	37	127	29.1	7.4	0	607	143	750	19.1	5.2	5

方向別自動車交通量調査表

調査地点：地域社会1 目黒

調査年月日：令和元年10月13日(日) 天候：曇りのち雨

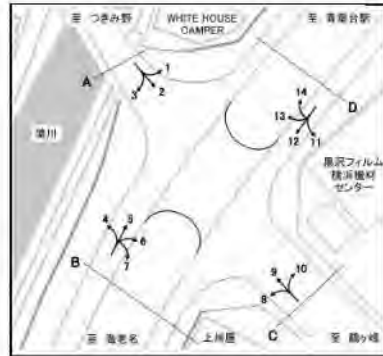

方向	10						C 合計 (8+9+10)					
	種別 小型車 (台)	大型車 (台)	合計 (台)	大型車 混入率 (%)	時間 係数 (%)	二輪車 (台)	小型車 (台)	大型車 (台)	合計 (台)	大型車 混入率 (%)	時間 係数 (%)	二輪車 (台)
14:00-14:15	12	7	19	36.8	1.1	1	160	35	195	17.9	1.3	2
14:15-14:30	22	10	32	31.3	1.9	0	191	41	232	17.7	1.6	5
14:30-14:45	28	9	37	24.3	2.2	1	220	34	254	13.4	1.7	4
14:45-15:00	8	4	12	33.3	0.7	0	154	19	173	11.0	1.2	2
1時間計	70	30	100	30.0	5.8	2	725	129	854	15.1	5.9	13
15:00-15:15	23	7	30	23.3	1.7	0	204	39	243	16.0	1.7	6
15:15-15:30	28	2	30	6.7	1.7	0	178	14	192	7.3	1.3	3
15:30-15:45	12	0	12	0.0	0.7	0	122	34	156	21.8	1.1	2
15:45-16:00	21	11	32	34.4	1.9	0	201	38	239	15.9	1.6	4
1時間計	84	20	104	19.2	6.1	0	705	125	830	15.1	5.7	15
16:00-16:15	29	3	32	9.4	1.9	1	180	28	208	13.5	1.4	5
16:15-16:30	14	3	17	17.6	1.0	2	196	24	220	10.9	1.5	5
16:30-16:45	26	0	26	0.0	1.5	2	204	11	215	5.1	1.5	9
16:45-17:00	24	2	26	7.7	1.5	1	194	19	213	8.9	1.5	3
1時間計	93	8	101	7.9	5.9	6	774	82	856	9.6	5.9	22
17:00-17:15	27	2	29	6.9	1.7	0	208	19	227	8.4	1.6	4
17:15-17:30	26	3	29	10.3	1.7	0	212	24	236	10.2	1.6	12
17:30-17:45	20	2	22	9.1	1.3	4	217	18	235	7.7	1.6	17
17:45-18:00	18	0	18	0.0	1.0	1	179	13	192	6.8	1.3	6
1時間計	91	7	98	7.1	5.7	5	816	74	890	8.3	6.1	39
18:00-18:15	26	0	26	0.0	1.5	0	251	18	269	6.7	1.8	10
18:15-18:30	14	1	15	6.7	0.9	1	175	19	194	9.8	1.3	9
18:30-18:45	27	4	31	12.9	1.8	1	275	30	305	9.8	2.1	6
18:45-19:00	18	1	19	5.3	1.1	0	178	19	197	9.6	1.4	8
1時間計	85	6	91	6.6	5.3	2	879	86	965	8.9	6.6	33
19:00-19:15	17	0	17	0.0	1.0	0	239	16	255	6.3	1.8	4
19:15-19:30	16	2	18	11.1	1.0	0	93	13	106	12.3	0.7	0
19:30-19:45	16	3	19	15.8	1.1	0	165	21	186	11.3	1.3	4
19:45-20:00	29	1	30	3.3	1.7	0	117	15	132	11.4	0.9	3
1時間計	78	6	84	7.1	4.9	0	614	65	679	9.6	4.7	11
20:00-20:15	24	0	24	0.0	1.4	1	153	17	170	10.0	1.2	4
20:15-20:30	29	1	30	3.3	1.7	1	184	18	202	8.9	1.4	9
20:30-20:45	15	2	17	11.8	1.0	1	90	23	113	20.4	0.8	3
20:45-21:00	19	4	23	17.4	1.3	0	122	20	142	14.1	1.0	2
1時間計	87	7	94	7.4	5.5	3	549	78	627	12.4	4.3	18
21:00-21:15	27	3	30	10.0	1.7	0	237	26	263	9.9	1.8	6
21:15-21:30	14	2	16	12.5	0.9	1	124	17	141	12.1	1.0	8
21:30-21:45	8	1	9	11.1	0.5	0	84	16	100	16.0	0.7	3
21:45-22:00	11	1	12	8.3	0.7	1	84	12	96	12.5	0.7	1
1時間計	60	7	67	10.4	3.9	2	529	71	600	11.8	4.1	18
昼12時間計	935	267	1202	22.2	70.0	30	8540	1561	10101	15.5	69.4	246
夜12時間計	403	112	515	21.7	30.0	9	3462	989	4451	22.2	30.6	150
全時間合計	1338	379	1717	22.1	100.0	39	12002	2550	14552	17.5	100.0	396
昼夜率	1.43	1.42	1.43	-	-	1.30	1.41	1.63	1.44	-	-	1.61

方向別自動車交通量調査表

調査地点：地域社会1 目黒

調査年月日：令和元年10月13日(日) 天候：曇りのち雨

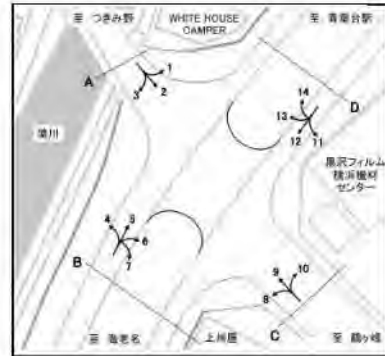

方向 種別 時間帯	11						12					
	小型車 (台)	大型車 (台)	合計 (台)	大型車 混入率 (%)	時間 係数 (%)	二輪車 (台)	小型車 (台)	大型車 (台)	合計 (台)	大型車 混入率 (%)	時間 係数 (%)	二輪車 (台)
22:00-22:15	5	0	5	0.0	0.4	0	4	0	4	0.0	0.5	0
22:15-22:30	3	3	6	50.0	0.5	2	5	0	5	0.0	0.6	0
22:30-22:45	3	3	6	50.0	0.5	0	7	0	7	0.0	0.9	1
22:45-23:00	6	0	6	0.0	0.5	0	6	0	6	0.0	0.7	0
1時間計	17	6	23	26.1	1.8	2	22	0	22	0.0	2.7	1
23:00-23:15	7	1	8	12.5	0.6	0	7	0	7	0.0	0.9	1
23:15-23:30	6	1	7	14.3	0.6	0	4	0	4	0.0	0.5	0
23:30-23:45	3	0	3	0.0	0.2	0	4	0	4	0.0	0.5	0
23:45-24:00	1	0	1	0.0	0.1	2	5	0	5	0.0	0.6	0
1時間計	17	2	19	10.5	1.5	2	20	0	20	0.0	2.4	1
0:00-0:15	3	1	4	25.0	0.3	0	2	1	3	33.3	0.4	0
0:15-0:30	2	0	2	0.0	0.2	0	2	0	2	0.0	0.2	0
0:30-0:45	2	0	2	0.0	0.2	0	1	1	2	50.0	0.2	0
0:45-1:00	3	1	4	25.0	0.3	0	2	1	3	33.3	0.4	0
1時間計	10	2	12	16.7	1.0	0	7	3	10	30.0	1.2	0
1:00-1:15	2	1	3	33.3	0.2	0	0	0	0	0.0	0.0	1
1:15-1:30	0	2	2	100.0	0.2	0	2	0	2	0.0	0.2	0
1:30-1:45	5	2	7	28.6	0.6	0	1	1	2	50.0	0.2	0
1:45-2:00	5	3	8	37.5	0.6	0	1	0	1	0.0	0.1	0
1時間計	12	8	20	40.0	1.6	0	4	1	5	20.0	0.6	1
2:00-2:15	7	2	9	22.2	0.7	0	3	0	3	0.0	0.4	0
2:15-2:30	0	2	2	100.0	0.2	0	0	0	0	0.0	0.0	0
2:30-2:45	1	1	2	50.0	0.2	0	1	0	1	0.0	0.1	0
2:45-3:00	5	2	7	28.6	0.6	0	0	1	1	100.0	0.1	0
1時間計	13	7	20	35.0	1.6	0	4	1	5	20.0	0.6	0
3:00-3:15	0	2	2	100.0	0.2	0	2	1	3	33.3	0.4	0
3:15-3:30	2	1	3	33.3	0.2	0	0	0	0	0.0	0.0	0
3:30-3:45	1	3	4	75.0	0.3	0	0	0	0	0.0	0.0	0
3:45-4:00	1	3	4	75.0	0.3	0	1	0	1	0.0	0.1	0
1時間計	4	9	13	69.2	1.0	0	3	1	4	25.0	0.5	0
4:00-4:15	1	1	2	50.0	0.2	0	2	0	2	0.0	0.2	0
4:15-4:30	1	2	3	66.7	0.2	0	5	0	5	0.0	0.6	0
4:30-4:45	1	0	1	0.0	0.1	0	2	0	2	0.0	0.2	0
4:45-5:00	5	3	8	37.5	0.6	1	1	0	1	0.0	0.1	0
1時間計	8	6	14	42.9	1.1	1	10	0	10	0.0	1.2	0
5:00-5:15	5	2	7	28.6	0.6	0	2	0	2	0.0	0.2	0
5:15-5:30	1	5	6	83.3	0.5	0	1	0	1	0.0	0.1	1
5:30-5:45	3	3	6	50.0	0.5	0	3	0	3	0.0	0.4	0
5:45-6:00	5	0	5	0.0	0.4	0	3	0	3	0.0	0.4	0
1時間計	14	10	24	41.7	1.9	0	9	0	9	0.0	1.1	1

方向別自動車交通量調査表

調査地点：地域社会1 目黒

調査年月日：令和元年10月13日(日) 天候：曇りのち雨

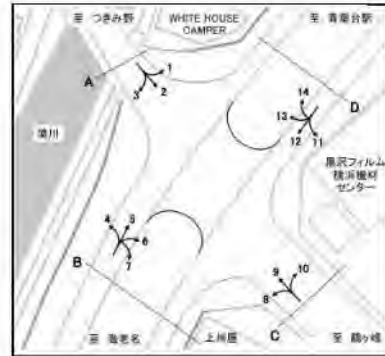

方向 時間帯	11						12					
	種別 小型車 (台)	大型車 (台)	合計 (台)	大型車 混入率 (%)	時間 係数 (%)	二輪車 (台)	小型車 (台)	大型車 (台)	合計 (台)	大型車 混入率 (%)	時間 係数 (%)	二輪車 (台)
6:00-6:15	1	2	3	66.7	0.2	0	4	0	4	0.0	0.5	0
6:15-6:30	5	0	5	0.0	0.4	0	4	0	4	0.0	0.5	1
6:30-6:45	7	2	9	22.2	0.7	1	6	2	8	25.0	1.0	0
6:45-7:00	3	3	6	50.0	0.5	0	8	1	9	11.1	1.1	1
1時間計	16	7	23	30.4	1.8	1	22	3	25	12.0	3.0	2
7:00-7:15	4	6	10	60.0	0.8	1	7	1	8	12.5	1.0	1
7:15-7:30	3	4	7	57.1	0.6	0	2	0	2	0.0	0.2	0
7:30-7:45	6	1	7	14.3	0.6	0	10	0	10	0.0	1.2	0
7:45-8:00	10	5	15	33.3	1.2	0	7	0	7	0.0	0.9	1
1時間計	23	16	39	41.0	3.1	1	26	1	27	3.7	3.3	2
8:00-8:15	12	3	15	20.0	1.2	1	7	1	8	12.5	1.0	1
8:15-8:30	12	2	14	14.3	1.1	0	3	0	3	0.0	0.4	0
8:30-8:45	15	4	19	21.1	1.5	0	11	0	11	0.0	1.3	0
8:45-9:00	22	2	24	8.3	1.9	1	8	0	8	0.0	1.0	0
1時間計	61	11	72	15.3	5.8	2	29	1	30	3.3	3.6	1
9:00-9:15	22	9	31	29.0	2.5	0	8	0	8	0.0	1.0	0
9:15-9:30	16	8	24	33.3	1.9	0	6	1	7	14.3	0.9	0
9:30-9:45	10	5	15	33.3	1.2	0	11	0	11	0.0	1.3	0
9:45-10:00	10	5	15	33.3	1.2	0	8	0	8	0.0	1.0	0
1時間計	58	27	85	31.8	6.8	0	33	1	34	2.9	4.1	0
10:00-10:15	15	8	23	34.8	1.8	0	10	0	10	0.0	1.2	0
10:15-10:30	22	4	26	15.4	2.1	0	19	1	20	5.0	2.4	0
10:30-10:45	22	6	28	21.4	2.2	2	15	1	16	6.3	1.9	0
10:45-11:00	10	3	13	23.1	1.0	0	8	0	8	0.0	1.0	0
1時間計	69	21	90	23.3	7.2	2	52	2	54	3.7	6.6	0
11:00-11:15	15	4	19	21.1	1.5	0	9	0	9	0.0	1.1	0
11:15-11:30	12	6	18	33.3	1.4	0	9	0	9	0.0	1.1	0
11:30-11:45	9	2	11	18.2	0.9	1	17	1	18	5.6	2.2	0
11:45-12:00	17	4	21	19.0	1.7	0	8	0	8	0.0	1.0	0
1時間計	53	16	69	23.2	5.5	1	43	1	44	2.3	5.3	0
12:00-12:15	22	5	27	18.5	2.2	1	16	1	17	5.9	2.1	0
12:15-12:30	28	0	28	0.0	2.2	0	11	0	11	0.0	1.3	0
12:30-12:45	25	7	32	21.9	2.6	2	15	0	15	0.0	1.8	0
12:45-13:00	23	1	24	4.2	1.9	0	14	9	23	39.1	2.8	0
1時間計	98	13	111	11.7	8.9	3	56	10	66	15.2	8.0	0
13:00-13:15	22	3	25	12.0	2.0	0	15	2	17	11.8	2.1	0
13:15-13:30	15	6	21	28.6	1.7	0	14	0	14	0.0	1.7	0
13:30-13:45	21	4	25	16.0	2.0	0	13	3	16	18.8	1.9	0
13:45-14:00	10	7	17	41.2	1.4	1	9	0	9	0.0	1.1	0
1時間計	68	20	88	22.7	7.0	1	51	5	56	8.9	6.8	0

方向別自動車交通量調査表

調査地点：地域社会1 目黒

調査年月日：令和元年10月13日(日) 天候：曇りのち雨

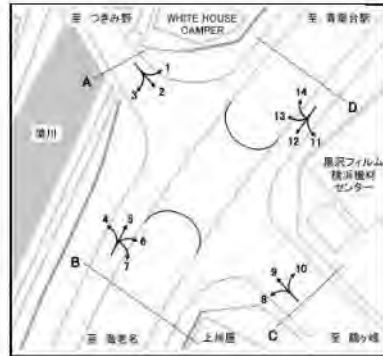

方向	11						12							
	種別	小型車 (台)	大型車 (台)	合計 (台)	大型車 混入率 (%)	時 間 係 数 (%)	二輪車 (台)	種別	小型車 (台)	大型車 (台)	合計 (台)	大型車 混入率 (%)	時 間 係 数 (%)	二輪車 (台)
14:00-14:15		23	5	28	17.9	2.2	0		14	0	14	0.0	1.7	1
14:15-14:30		17	7	24	29.2	1.9	0		16	0	16	0.0	1.9	0
14:30-14:45		11	6	17	35.3	1.4	0		21	2	23	8.7	2.8	0
14:45-15:00		14	7	21	33.3	1.7	0		24	1	25	4.0	3.0	1
1時間計		65	25	90	27.8	7.2	0		75	3	78	3.8	9.5	2
15:00-15:15		16	4	20	20.0	1.6	1		18	4	22	18.2	2.7	0
15:15-15:30		11	3	14	21.4	1.1	0		15	0	15	0.0	1.8	1
15:30-15:45		20	2	22	9.1	1.8	1		14	0	14	0.0	1.7	0
15:45-16:00		10	1	11	9.1	0.9	0		11	0	11	0.0	1.3	0
1時間計		57	10	67	14.9	5.4	2		58	4	62	6.5	7.5	1
16:00-16:15		21	4	25	16.0	2.0	1		15	0	15	0.0	1.8	1
16:15-16:30		14	6	20	30.0	1.6	0		4	1	5	20.0	0.6	0
16:30-16:45		9	3	12	25.0	1.0	0		16	0	16	0.0	1.9	0
16:45-17:00		13	2	15	13.3	1.2	0		8	0	8	0.0	1.0	0
1時間計		57	15	72	20.8	5.8	1		43	1	44	2.3	5.3	1
17:00-17:15		12	4	16	25.0	1.3	0		16	0	16	0.0	1.9	0
17:15-17:30		17	3	20	15.0	1.6	2		9	0	9	0.0	1.1	1
17:30-17:45		9	3	12	25.0	1.0	0		19	0	19	0.0	2.3	1
17:45-18:00		15	2	17	11.8	1.4	0		15	0	15	0.0	1.8	0
1時間計		53	12	65	18.5	5.2	2		59	0	59	0.0	7.2	2
18:00-18:15		14	5	19	26.3	1.5	0		16	0	16	0.0	1.9	2
18:15-18:30		17	2	19	10.5	1.5	0		11	1	12	8.3	1.5	2
18:30-18:45		12	2	14	14.3	1.1	1		20	1	21	4.8	2.6	0
18:45-19:00		11	4	15	26.7	1.2	0		12	1	13	7.7	1.6	0
1時間計		54	13	67	19.4	5.4	1		59	3	62	4.8	7.5	4
19:00-19:15		14	2	16	12.5	1.3	1		13	2	15	13.3	1.8	0
19:15-19:30		9	2	11	18.2	0.9	0		11	0	11	0.0	1.3	0
19:30-19:45		12	2	14	14.3	1.1	0		13	0	13	0.0	1.6	0
19:45-20:00		13	3	16	18.8	1.3	0		9	0	9	0.0	1.1	0
1時間計		48	9	57	15.8	4.6	1		46	2	48	4.2	5.8	0
20:00-20:15		14	9	23	39.1	1.8	0		9	0	9	0.0	1.1	0
20:15-20:30		20	4	24	16.7	1.9	0		12	1	13	7.7	1.6	1
20:30-20:45		10	4	14	28.6	1.1	0		8	0	8	0.0	1.0	0
20:45-21:00		4	7	11	63.6	0.9	0		5	1	6	16.7	0.7	0
1時間計		48	24	72	33.3	5.8	0		34	2	36	5.6	4.4	1
21:00-21:15		9	5	14	35.7	1.1	0		1	0	1	0.0	0.1	1
21:15-21:30		8	0	8	0.0	0.6	1		3	0	3	0.0	0.4	0
21:30-21:45		3	2	5	40.0	0.4	0		3	0	3	0.0	0.4	1
21:45-22:00		8	3	11	27.3	0.9	0		6	0	6	0.0	0.7	1
1時間計		28	10	38	26.3	3.0	1		13	0	13	0.0	1.6	3
昼12時間計		716	199	915	21.7	73.2	16		584	32	616	5.2	74.8	13
夜12時間計		235	100	335	29.9	26.8	8		194	13	207	6.3	25.2	10
全時間合計		951	299	1250	23.9	100.0	24		778	45	823	5.5	100.0	23
昼 夜 率		1.33	1.50	1.37	-	-	1.50		1.33	1.41	1.34	-	-	1.77

方向別自動車交通量調査表

調査地点：地域社会1 目黒

調査年月日：令和元年10月13日(日) 天候：曇りのち雨

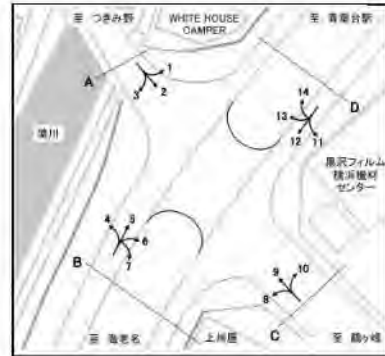

方向	13						14						
	種別	小型車 (台)	大型車 (台)	合計 (台)	大型車 混入率 (%)	時間 係数 (%)	二輪車 (台)	小型車 (台)	大型車 (台)	合計 (台)	大型車 混入率 (%)	時間 係数 (%)	二輪車 (台)
22:00-22:15		37	7	44	15.9	1.4	2	2	0	2	0.0	2.9	0
22:15-22:30		17	5	22	22.7	0.7	1	2	0	2	0.0	2.9	0
22:30-22:45		16	2	18	11.1	0.6	1	2	0	2	0.0	2.9	0
22:45-23:00		27	1	28	3.6	0.9	1	2	0	2	0.0	2.9	0
1時間計		97	15	112	13.4	3.5	5	8	0	8	0.0	11.8	0
23:00-23:15		21	4	25	16.0	0.8	0	1	0	1	0.0	1.5	0
23:15-23:30		11	5	16	31.3	0.5	0	0	0	0	0.0	0.0	0
23:30-23:45		10	3	13	23.1	0.4	0	0	0	0	0.0	0.0	0
23:45-24:00		15	6	21	28.6	0.7	2	0	0	0	0.0	0.0	0
1時間計		57	18	75	24.0	2.3	2	1	0	1	0.0	1.5	0
0:00-0:15		25	9	34	26.5	1.1	2	0	0	0	0.0	0.0	0
0:15-0:30		10	1	11	9.1	0.3	0	0	1	1	100.0	1.5	0
0:30-0:45		16	0	16	0.0	0.5	0	0	0	0	0.0	0.0	0
0:45-1:00		10	1	11	9.1	0.3	0	0	1	1	100.0	1.5	0
1時間計		61	11	72	15.3	2.2	2	0	2	2	100.0	2.9	0
1:00-1:15		10	0	10	0.0	0.3	0	0	0	0	0.0	0.0	0
1:15-1:30		15	4	19	21.1	0.6	0	1	1	2	50.0	2.9	0
1:30-1:45		2	1	3	33.3	0.1	0	0	0	0	0.0	0.0	0
1:45-2:00		9	0	9	0.0	0.3	0	0	0	0	0.0	0.0	0
1時間計		36	5	41	12.2	1.3	0	1	1	2	50.0	2.9	0
2:00-2:15		5	6	11	54.5	0.3	1	0	0	0	0.0	0.0	0
2:15-2:30		4	3	7	42.9	0.2	0	0	0	0	0.0	0.0	0
2:30-2:45		3	2	5	40.0	0.2	0	0	0	0	0.0	0.0	0
2:45-3:00		7	4	11	36.4	0.3	0	0	0	0	0.0	0.0	0
1時間計		19	15	34	44.1	1.1	1	0	0	0	0.0	0.0	0
3:00-3:15		6	3	9	33.3	0.3	0	0	0	0	0.0	0.0	0
3:15-3:30		5	1	6	16.7	0.2	1	0	0	0	0.0	0.0	0
3:30-3:45		3	4	7	57.1	0.2	0	0	0	0	0.0	0.0	0
3:45-4:00		3	4	7	57.1	0.2	0	0	0	0	0.0	0.0	0
1時間計		17	12	29	41.4	0.9	1	0	0	0	0.0	0.0	0
4:00-4:15		1	5	6	83.3	0.2	0	0	0	0	0.0	0.0	0
4:15-4:30		6	6	12	50.0	0.4	0	0	0	0	0.0	0.0	0
4:30-4:45		4	1	5	20.0	0.2	1	0	0	0	0.0	0.0	0
4:45-5:00		3	3	6	50.0	0.2	1	0	0	0	0.0	0.0	0
1時間計		14	15	29	51.7	0.9	2	0	0	0	0.0	0.0	0
5:00-5:15		10	7	17	41.2	0.5	0	0	0	0	0.0	0.0	0
5:15-5:30		3	2	5	40.0	0.2	0	1	1	2	50.0	2.9	0
5:30-5:45		6	6	12	50.0	0.4	1	0	0	0	0.0	0.0	0
5:45-6:00		14	3	17	17.6	0.5	1	0	0	0	0.0	0.0	0
1時間計		33	18	51	35.3	1.6	2	1	1	2	50.0	2.9	0

方向別自動車交通量調査表

調査地点：地域社会1 目黒

調査年月日：令和元年10月13日(日) 天候：曇りのち雨

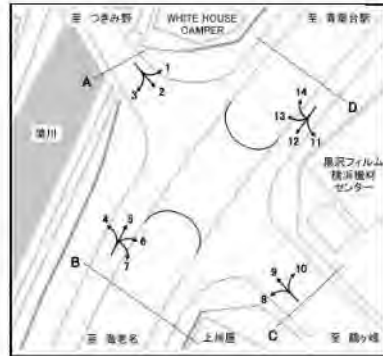

方向	13						14						
	種別	小型車 (台)	大型車 (台)	合計 (台)	大型車 混入率 (%)	時間 係数 (%)	二輪車 (台)	小型車 (台)	大型車 (台)	合計 (台)	大型車 混入率 (%)	時間 係数 (%)	二輪車 (台)
6:00-6:15		6	3	9	33.3	0.3	0	0	0	0	0.0	0.0	0
6:15-6:30		23	9	32	28.1	1.0	1	0	0	0	0.0	0.0	0
6:30-6:45		16	5	21	23.8	0.7	1	0	1	1	100.0	1.5	0
6:45-7:00		14	6	20	30.0	0.6	0	0	0	0	0.0	0.0	0
1時間計		59	23	82	28.0	2.5	2	0	1	1	100.0	1.5	0
7:00-7:15		21	3	24	12.5	0.7	0	0	1	1	100.0	1.5	0
7:15-7:30		29	6	35	17.1	1.1	1	0	0	0	0.0	0.0	0
7:30-7:45		39	9	48	18.8	1.5	1	1	0	1	0.0	1.5	0
7:45-8:00		26	2	28	7.1	0.9	1	1	0	1	0.0	1.5	0
1時間計		115	20	135	14.8	4.2	3	2	1	3	33.3	4.4	0
8:00-8:15		38	12	50	24.0	1.6	1	0	0	0	0.0	0.0	0
8:15-8:30		17	5	22	22.7	0.7	2	0	0	0	0.0	0.0	0
8:30-8:45		29	8	37	21.6	1.1	0	0	1	1	100.0	1.5	0
8:45-9:00		25	6	31	19.4	1.0	1	1	0	1	0.0	1.5	0
1時間計		109	31	140	22.1	4.3	4	1	1	2	50.0	2.9	0
9:00-9:15		48	10	58	17.2	1.8	3	0	0	0	0.0	0.0	1
9:15-9:30		27	0	27	0.0	0.8	1	0	0	0	0.0	0.0	0
9:30-9:45		40	3	43	7.0	1.3	0	2	0	2	0.0	2.9	0
9:45-10:00		32	3	35	8.6	1.1	1	0	1	1	100.0	1.5	0
1時間計		147	16	163	9.8	5.1	5	2	1	3	33.3	4.4	1
10:00-10:15		71	5	76	6.6	2.4	0	1	0	1	0.0	1.5	0
10:15-10:30		36	3	39	7.7	1.2	1	1	0	1	0.0	1.5	0
10:30-10:45		50	3	53	5.7	1.6	1	2	0	2	0.0	2.9	0
10:45-11:00		41	3	44	6.8	1.4	0	2	0	2	0.0	2.9	0
1時間計		198	14	212	6.6	6.6	2	6	0	6	0.0	8.8	0
11:00-11:15		42	7	49	14.3	1.5	1	1	0	1	0.0	1.5	0
11:15-11:30		53	9	62	14.5	1.9	1	3	0	3	0.0	4.4	1
11:30-11:45		51	4	55	7.3	1.7	0	1	0	1	0.0	1.5	0
11:45-12:00		58	3	61	4.9	1.9	2	1	0	1	0.0	1.5	0
1時間計		204	23	227	10.1	7.0	4	6	0	6	0.0	8.8	1
12:00-12:15		65	7	72	9.7	2.2	0	2	4	6	66.7	8.8	0
12:15-12:30		28	3	31	9.7	1.0	0	0	0	0	0.0	0.0	0
12:30-12:45		58	5	63	7.9	2.0	4	0	0	0	0.0	0.0	0
12:45-13:00		49	2	51	3.9	1.6	0	0	0	0	0.0	0.0	0
1時間計		200	17	217	7.8	6.7	4	2	4	6	66.7	8.8	0
13:00-13:15		43	5	48	10.4	1.5	2	0	0	0	0.0	0.0	0
13:15-13:30		36	3	39	7.7	1.2	1	2	0	2	0.0	2.9	0
13:30-13:45		57	9	66	13.6	2.0	1	0	1	1	100.0	1.5	0
13:45-14:00		37	2	39	5.1	1.2	0	0	1	1	100.0	1.5	0
1時間計		173	19	192	9.9	6.0	4	2	2	4	50.0	5.9	0

方向別自動車交通量調査表

調査地点：地域社会1 目黒

調査年月日：令和元年10月13日(日) 天候：曇りのち雨

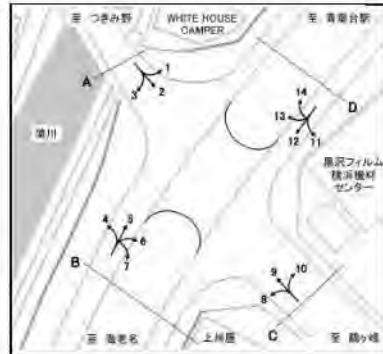

方向	13						14						
	種別	小型車 (台)	大型車 (台)	合計 (台)	大型車 混入率 (%)	時間 係数 (%)	二輪車 (台)	小型車 (台)	大型車 (台)	合計 (台)	大型車 混入率 (%)	時間 係数 (%)	二輪車 (台)
14:00-14:15		39	3	42	7.1	1.3	1	0	0	0	0.0	0.0	1
14:15-14:30		48	6	54	11.1	1.7	0	1	0	1	0.0	1.5	0
14:30-14:45		44	2	46	4.3	1.4	1	1	0	1	0.0	1.5	0
14:45-15:00		44	4	48	8.3	1.5	0	2	1	3	33.3	4.4	0
1時間計		175	15	190	7.9	5.9	2	4	1	5	20.0	7.4	1
15:00-15:15		48	4	52	7.7	1.6	1	1	0	1	0.0	1.5	0
15:15-15:30		44	7	51	13.7	1.6	0	2	0	2	0.0	2.9	0
15:30-15:45		46	0	46	0.0	1.4	1	0	1	1	100.0	1.5	0
15:45-16:00		41	1	42	2.4	1.3	1	1	1	2	50.0	2.9	0
1時間計		179	12	191	6.3	5.9	3	4	2	6	33.3	8.8	0
16:00-16:15		42	4	46	8.7	1.4	0	1	0	1	0.0	1.5	0
16:15-16:30		56	7	63	11.1	2.0	0	1	0	1	0.0	1.5	0
16:30-16:45		46	1	47	2.1	1.5	0	0	0	0	0.0	0.0	0
16:45-17:00		32	0	32	0.0	1.0	1	0	0	0	0.0	0.0	0
1時間計		176	12	188	6.4	5.8	1	2	0	2	0.0	2.9	0
17:00-17:15		46	3	49	6.1	1.5	0	1	0	1	0.0	1.5	0
17:15-17:30		47	3	50	6.0	1.6	2	0	0	0	0.0	0.0	0
17:30-17:45		40	2	42	4.8	1.3	0	0	0	0	0.0	0.0	0
17:45-18:00		24	2	26	7.7	0.8	1	0	0	0	0.0	0.0	0
1時間計		157	10	167	6.0	5.2	3	1	0	1	0.0	1.5	0
18:00-18:15		38	0	38	0.0	1.2	2	0	0	0	0.0	0.0	0
18:15-18:30		45	7	52	13.5	1.6	1	0	0	0	0.0	0.0	0
18:30-18:45		58	2	60	3.3	1.9	1	0	0	0	0.0	0.0	0
18:45-19:00		53	2	55	3.6	1.7	2	0	0	0	0.0	0.0	0
1時間計		194	11	205	5.4	6.4	6	0	0	0	0.0	0.0	0
19:00-19:15		61	2	63	3.2	2.0	1	0	1	1	100.0	1.5	0
19:15-19:30		39	2	41	4.9	1.3	1	0	0	0	0.0	0.0	0
19:30-19:45		51	7	58	12.1	1.8	6	0	0	0	0.0	0.0	0
19:45-20:00		33	1	34	2.9	1.1	2	0	0	0	0.0	0.0	0
1時間計		184	12	196	6.1	6.1	10	0	1	1	100.0	1.5	0
20:00-20:15		42	4	46	8.7	1.4	2	1	0	1	0.0	1.5	0
20:15-20:30		35	5	40	12.5	1.2	1	1	0	1	0.0	1.5	0
20:30-20:45		28	2	30	6.7	0.9	1	0	0	0	0.0	0.0	0
20:45-21:00		31	2	33	6.1	1.0	1	1	0	1	0.0	1.5	0
1時間計		136	13	149	8.7	4.6	5	3	0	3	0.0	4.4	0
21:00-21:15		32	1	33	3.0	1.0	0	0	0	0	0.0	0.0	0
21:15-21:30		30	1	31	3.2	1.0	1	2	0	2	0.0	2.9	0
21:30-21:45		35	0	35	0.0	1.1	1	1	0	1	0.0	1.5	0
21:45-22:00		17	7	24	29.2	0.7	1	1	0	1	0.0	1.5	0
1時間計		114	9	123	7.3	3.8	3	4	0	4	0.0	5.9	0
昼12時間計		2027	200	2227	9.0	69.2	41	32	12	44	27.3	64.7	3
夜12時間計		827	166	993	16.7	30.8	35	18	6	24	25.0	35.3	0
全時間合計		2854	366	3220	11.4	100.0	76	50	18	68	26.5	100.0	3
昼夜率		1.41	1.83	1.45	-	-	1.85	1.56	1.50	1.55	-	-	1.00

方向別自動車交通量調査表

調査地点：地域社会1 目黒

調査年月日：令和元年10月13日(日) 天候：曇りのち雨

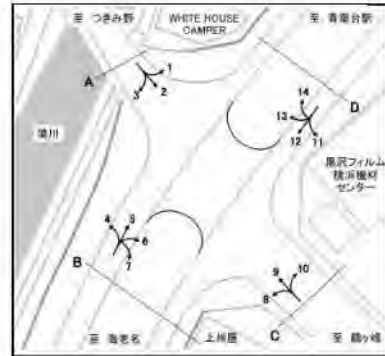

時間帯	方向 種別						D 合計 (11+12+13+14)					
		小型車 (台)	大型車 (台)	合計 (台)	大型車 混入率 (%)	時係 数 (%)	二輪車 (台)	小型車 (台)	大型車 (台)	合計 (台)	大型車 混入率 (%)	時係 数 (%)
22:00-22:15							48	7	55	12.7	1.0	2
22:15-22:30							27	8	35	22.9	0.7	3
22:30-22:45							28	5	33	15.2	0.6	2
22:45-23:00							41	1	42	2.4	0.8	1
1時間計							144	21	165	12.7	3.1	8
23:00-23:15							36	5	41	12.2	0.8	1
23:15-23:30							21	6	27	22.2	0.5	0
23:30-23:45							17	3	20	15.0	0.4	0
23:45-24:00							21	6	27	22.2	0.5	4
1時間計							95	20	115	17.4	2.1	5
0:00- 0:15							30	11	41	26.8	0.8	2
0:15- 0:30							14	2	16	12.5	0.3	0
0:30- 0:45							19	1	20	5.0	0.4	0
0:45- 1:00							15	4	19	21.1	0.4	0
1時間計							78	18	96	18.8	1.8	2
1:00- 1:15							12	1	13	7.7	0.2	1
1:15- 1:30							18	7	25	28.0	0.5	0
1:30- 1:45							8	4	12	33.3	0.2	0
1:45- 2:00							15	3	18	16.7	0.3	0
1時間計							53	15	68	22.1	1.3	1
2:00- 2:15							15	8	23	34.8	0.4	1
2:15- 2:30							4	5	9	55.6	0.2	0
2:30- 2:45							5	3	8	37.5	0.1	0
2:45- 3:00							12	7	19	36.8	0.4	0
1時間計							36	23	59	39.0	1.1	1
3:00- 3:15							8	6	14	42.9	0.3	0
3:15- 3:30							7	2	9	22.2	0.2	1
3:30- 3:45							4	7	11	63.6	0.2	0
3:45- 4:00							5	7	12	58.3	0.2	0
1時間計							24	22	46	47.8	0.9	1
4:00- 4:15							4	6	10	60.0	0.2	0
4:15- 4:30							12	8	20	40.0	0.4	0
4:30- 4:45							7	1	8	12.5	0.1	1
4:45- 5:00							9	6	15	40.0	0.3	2
1時間計							32	21	53	39.6	1.0	3
5:00- 5:15							17	9	26	34.6	0.5	0
5:15- 5:30							6	8	14	57.1	0.3	1
5:30- 5:45							12	9	21	42.9	0.4	1
5:45- 6:00							22	3	25	12.0	0.5	1
1時間計							57	29	86	33.7	1.6	3

方向別自動車交通量調査表

調査地点：地域社会1 目黒

調査年月日：令和元年10月13日(日) 天候：曇りのち雨

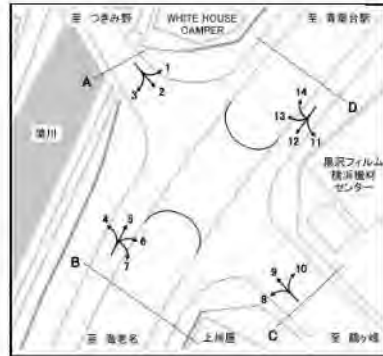

時間帯	方向 種別							D 合計 (11+12+13+14)					
		小型車 (台)	大型車 (台)	合計 (台)	大型車 混入率 (%)	時間 係数 (%)	二輪車 (台)	小型車 (台)	大型車 (台)	合計 (台)	大型車 混入率 (%)	時間 係数 (%)	二輪車 (台)
6:00-6:15							11	5	16	31.3	0.3	0	
6:15-6:30							32	9	41	22.0	0.8	2	
6:30-6:45							29	10	39	25.6	0.7	2	
6:45-7:00							25	10	35	28.6	0.7	1	
1時間計							97	34	131	26.0	2.4	5	
7:00-7:15							32	11	43	25.6	0.8	2	
7:15-7:30							34	10	44	22.7	0.8	1	
7:30-7:45							56	10	66	15.2	1.2	1	
7:45-8:00							44	7	51	13.7	1.0	2	
1時間計							166	38	204	18.6	3.8	6	
8:00-8:15							57	16	73	21.9	1.4	3	
8:15-8:30							32	7	39	17.9	0.7	2	
8:30-8:45							55	13	68	19.1	1.3	0	
8:45-9:00							56	8	64	12.5	1.2	2	
1時間計							200	44	244	18.0	4.6	7	
9:00-9:15							78	19	97	19.6	1.8	4	
9:15-9:30							49	9	58	15.5	1.1	1	
9:30-9:45							63	8	71	11.3	1.3	0	
9:45-10:00							50	9	59	15.3	1.1	1	
1時間計							240	45	285	15.8	5.3	6	
10:00-10:15							97	13	110	11.8	2.1	0	
10:15-10:30							78	8	86	9.3	1.6	1	
10:30-10:45							89	10	99	10.1	1.8	3	
10:45-11:00							61	6	67	9.0	1.2	0	
1時間計							325	37	362	10.2	6.8	4	
11:00-11:15							67	11	78	14.1	1.5	1	
11:15-11:30							77	15	92	16.3	1.7	2	
11:30-11:45							78	7	85	8.2	1.6	1	
11:45-12:00							84	7	91	7.7	1.7	2	
1時間計							306	40	346	11.6	6.5	6	
12:00-12:15							105	17	122	13.9	2.3	1	
12:15-12:30							67	3	70	4.3	1.3	0	
12:30-12:45							98	12	110	10.9	2.1	6	
12:45-13:00							86	12	98	12.2	1.8	0	
1時間計							356	44	400	11.0	7.5	7	
13:00-13:15							80	10	90	11.1	1.7	2	
13:15-13:30							67	9	76	11.8	1.4	1	
13:30-13:45							91	17	108	15.7	2.0	1	
13:45-14:00							56	10	66	15.2	1.2	1	
1時間計							294	46	340	13.5	6.3	5	

方向別自動車交通量調査表

調査地点：地域社会1 目黒

調査年月日：令和元年10月13日(日) 天候：曇りのち雨

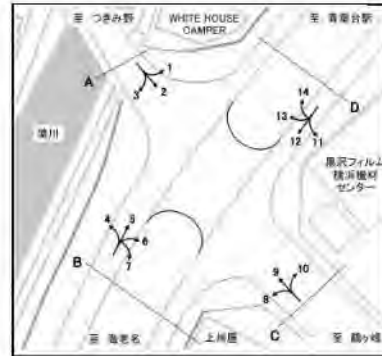

方向							D 合計 (11+12+13+14)						
	種別	小型車 (台)	大型車 (台)	合計 (台)	大型車 混入率 (%)	時間 係数 (%)	二輪車 (台)	小型車 (台)	大型車 (台)	合計 (台)	大型車 混入率 (%)	時間 係数 (%)	二輪車 (台)
14:00-14:15								76	8	84	9.5	1.6	3
14:15-14:30								82	13	95	13.7	1.8	0
14:30-14:45								77	10	87	11.5	1.6	1
14:45-15:00								84	13	97	13.4	1.8	1
1時間計								319	44	363	12.1	6.8	5
15:00-15:15								83	12	95	12.6	1.8	2
15:15-15:30								72	10	82	12.2	1.5	1
15:30-15:45								80	3	83	3.6	1.5	2
15:45-16:00								63	3	66	4.5	1.2	1
1時間計								298	28	326	8.6	6.1	6
16:00-16:15								79	8	87	9.2	1.6	2
16:15-16:30								75	14	89	15.7	1.7	0
16:30-16:45								71	4	75	5.3	1.4	0
16:45-17:00								53	2	55	3.6	1.0	1
1時間計								278	28	306	9.2	5.7	3
17:00-17:15								75	7	82	8.5	1.5	0
17:15-17:30								73	6	79	7.6	1.5	5
17:30-17:45								68	5	73	6.8	1.4	1
17:45-18:00								54	4	58	6.9	1.1	1
1時間計								270	22	292	7.5	5.4	7
18:00-18:15								68	5	73	6.8	1.4	4
18:15-18:30								73	10	83	12.0	1.5	3
18:30-18:45								90	5	95	5.3	1.8	2
18:45-19:00								76	7	83	8.4	1.5	2
1時間計								307	27	334	8.1	6.2	11
19:00-19:15								88	7	95	7.4	1.8	2
19:15-19:30								59	4	63	6.3	1.2	1
19:30-19:45								76	9	85	10.6	1.6	6
19:45-20:00								55	4	59	6.8	1.1	2
1時間計								278	24	302	7.9	5.6	11
20:00-20:15								66	13	79	16.5	1.5	2
20:15-20:30								68	10	78	12.8	1.5	2
20:30-20:45								46	6	52	11.5	1.0	1
20:45-21:00								41	10	51	19.6	1.0	1
1時間計								221	39	260	15.0	4.8	6
21:00-21:15								42	6	48	12.5	0.9	1
21:15-21:30								43	1	44	2.3	0.8	2
21:30-21:45								42	2	44	4.5	0.8	2
21:45-22:00								32	10	42	23.8	0.8	2
1時間計								159	19	178	10.7	3.3	7
昼12時間計								3359	443	3802	11.7	70.9	73
夜12時間計								1274	285	1559	18.3	29.1	53
全時間合計								4633	728	5361	13.6	100.0	126
昼夜率								1.38	1.64	1.41	-	-	1.73

方向別自動車交通量調査表

調査地点：地域社会2 目黒交番前

調査年月日：令和元年10月13日(日) 天候：曇りのち雨

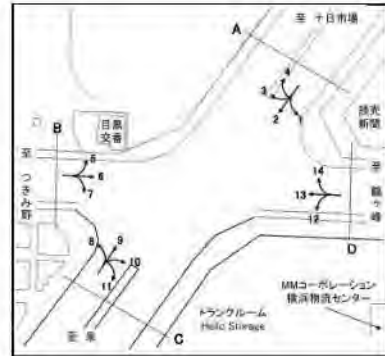

方向 種別 時間帯	1						2					
	小型車 (台)	大型車 (台)	合計 (台)	大型車 混入率 (%)	時間 係数 (%)	二輪車 (台)	小型車 (台)	大型車 (台)	合計 (台)	大型車 混入率 (%)	時間 係数 (%)	二輪車 (台)
22:00-22:15	2	0	2	0.0	1.1	0	35	1	36	2.8	0.9	3
22:15-22:30	0	0	0	0.0	0.0	0	23	1	24	4.2	0.6	8
22:30-22:45	0	2	2	100.0	1.1	0	15	2	17	11.8	0.4	1
22:45-23:00	1	0	1	0.0	0.6	0	21	1	22	4.5	0.6	1
1時間計	3	2	5	40.0	2.8	0	94	5	99	5.1	2.5	13
23:00-23:15	1	0	1	0.0	0.6	0	22	0	22	0.0	0.6	3
23:15-23:30	1	1	2	50.0	1.1	0	19	0	19	0.0	0.5	1
23:30-23:45	3	5	8	62.5	4.5	0	17	0	17	0.0	0.4	3
23:45-24:00	2	5	7	71.4	3.9	0	14	3	17	17.6	0.4	1
1時間計	7	11	18	61.1	10.1	0	72	3	75	4.0	1.9	8
0:00-0:15	3	2	5	40.0	2.8	0	19	3	22	13.6	0.6	0
0:15-0:30	5	1	6	16.7	3.4	0	10	3	13	23.1	0.3	2
0:30-0:45	4	2	6	33.3	3.4	0	10	6	16	37.5	0.4	2
0:45-1:00	5	1	6	16.7	3.4	0	14	2	16	12.5	0.4	1
1時間計	17	6	23	26.1	12.9	0	53	14	67	20.9	1.7	5
1:00-1:15	7	3	10	30.0	5.6	0	7	1	8	12.5	0.2	2
1:15-1:30	5	4	9	44.4	5.1	0	9	1	10	10.0	0.3	0
1:30-1:45	7	4	11	36.4	6.2	0	6	1	7	14.3	0.2	0
1:45-2:00	1	0	1	0.0	0.6	0	6	1	7	14.3	0.2	0
1時間計	20	11	31	35.5	17.4	0	28	4	32	12.5	0.8	2
2:00-2:15	0	1	1	100.0	0.6	1	6	0	6	0.0	0.2	0
2:15-2:30	0	0	0	0.0	0.0	4	5	1	6	16.7	0.2	1
2:30-2:45	0	0	0	0.0	0.0	0	7	1	8	12.5	0.2	0
2:45-3:00	0	3	3	100.0	1.7	0	5	2	7	28.6	0.2	1
1時間計	0	4	4	100.0	2.2	5	23	4	27	14.8	0.7	2
3:00-3:15	2	1	3	33.3	1.7	0	2	1	3	33.3	0.1	1
3:15-3:30	0	2	2	100.0	1.1	0	1	2	3	66.7	0.1	0
3:30-3:45	0	0	0	0.0	0.0	0	2	0	2	0.0	0.1	1
3:45-4:00	0	0	0	0.0	0.0	0	7	1	8	12.5	0.2	1
1時間計	2	3	5	60.0	2.8	0	12	4	16	25.0	0.4	3
4:00-4:15	0	0	0	0.0	0.0	0	10	0	10	0.0	0.3	0
4:15-4:30	0	0	0	0.0	0.0	0	5	1	6	16.7	0.2	0
4:30-4:45	0	0	0	0.0	0.0	0	8	4	12	33.3	0.3	0
4:45-5:00	0	0	0	0.0	0.0	1	7	4	11	36.4	0.3	0
1時間計	0	0	0	0.0	0.0	1	30	9	39	23.1	1.0	0
5:00-5:15	0	0	0	0.0	0.0	0	7	3	10	30.0	0.3	3
5:15-5:30	1	0	1	0.0	0.6	0	12	0	12	0.0	0.3	3
5:30-5:45	1	1	2	50.0	1.1	0	15	2	17	11.8	0.4	0
5:45-6:00	0	0	0	0.0	0.0	0	19	2	21	9.5	0.5	0
1時間計	2	1	3	33.3	1.7	0	53	7	60	11.7	1.5	6

方向別自動車交通量調査表

調査地点：地域社会2 目黒交番前

調査年月日：令和元年10月13日(日) 天候：曇りのち雨



方向 時間帯	1						2					
	種別 小型車 (台)	大型車 (台)	合計 (台)	大型車 混入率 (%)	時間 係数 (%)	二輪車 (台)	小型車 (台)	大型車 (台)	合計 (台)	大型車 混入率 (%)	時間 係数 (%)	二輪車 (台)
6:00-6:15	0	1	1	100.0	0.6	0	23	6	29	20.7	0.7	0
6:15-6:30	0	0	0	0.0	0.0	0	38	1	39	2.6	1.0	1
6:30-6:45	0	0	0	0.0	0.0	0	36	4	40	10.0	1.0	3
6:45-7:00	1	0	1	0.0	0.6	0	32	5	37	13.5	1.0	3
1時間計	1	1	2	50.0	1.1	0	129	16	145	11.0	3.7	7
7:00-7:15	1	0	1	0.0	0.6	0	35	3	38	7.9	1.0	3
7:15-7:30	1	1	2	50.0	1.1	0	46	3	49	6.1	1.3	3
7:30-7:45	0	0	0	0.0	0.0	0	47	3	50	6.0	1.3	3
7:45-8:00	1	0	1	0.0	0.6	0	43	6	49	12.2	1.3	2
1時間計	3	1	4	25.0	2.2	0	171	15	186	8.1	4.8	11
8:00-8:15	1	0	1	0.0	0.6	0	63	8	71	11.3	1.8	1
8:15-8:30	0	1	1	100.0	0.6	0	33	7	40	17.5	1.0	2
8:30-8:45	1	0	1	0.0	0.6	0	43	3	46	6.5	1.2	1
8:45-9:00	3	0	3	0.0	1.7	0	41	3	44	6.8	1.1	1
1時間計	5	1	6	16.7	3.4	0	180	21	201	10.4	5.2	5
9:00-9:15	1	1	2	50.0	1.1	0	56	3	59	5.1	1.5	3
9:15-9:30	0	2	2	100.0	1.1	0	49	4	53	7.5	1.4	4
9:30-9:45	0	0	0	0.0	0.0	0	46	4	50	8.0	1.3	1
9:45-10:00	2	0	2	0.0	1.1	0	52	4	56	7.1	1.4	3
1時間計	3	3	6	50.0	3.4	0	203	15	218	6.9	5.6	11
10:00-10:15	1	0	1	0.0	0.6	0	51	5	56	8.9	1.4	2
10:15-10:30	0	2	2	100.0	1.1	0	37	7	44	15.9	1.1	1
10:30-10:45	1	0	1	0.0	0.6	1	50	2	52	3.8	1.3	2
10:45-11:00	2	0	2	0.0	1.1	0	60	6	66	9.1	1.7	3
1時間計	4	2	6	33.3	3.4	1	198	20	218	9.2	5.6	8
11:00-11:15	1	3	4	75.0	2.2	0	80	9	89	10.1	2.3	1
11:15-11:30	0	0	0	0.0	0.0	0	45	2	47	4.3	1.2	2
11:30-11:45	0	0	0	0.0	0.0	0	68	5	73	6.8	1.9	2
11:45-12:00	3	0	3	0.0	1.7	0	67	5	72	6.9	1.9	1
1時間計	4	3	7	42.9	3.9	0	260	21	281	7.5	7.2	6
12:00-12:15	3	1	4	25.0	2.2	0	58	5	63	7.9	1.6	0
12:15-12:30	0	0	0	0.0	0.0	0	50	6	56	10.7	1.4	2
12:30-12:45	1	0	1	0.0	0.6	0	50	3	53	5.7	1.4	2
12:45-13:00	0	0	0	0.0	0.0	0	42	5	47	10.6	1.2	2
1時間計	4	1	5	20.0	2.8	0	200	19	219	8.7	5.6	6
13:00-13:15	2	0	2	0.0	1.1	0	57	5	62	8.1	1.6	0
13:15-13:30	2	0	2	0.0	1.1	0	64	6	70	8.6	1.8	0
13:30-13:45	2	0	2	0.0	1.1	0	70	7	77	9.1	2.0	0
13:45-14:00	1	1	2	50.0	1.1	0	57	3	60	5.0	1.5	0
1時間計	7	1	8	12.5	4.5	0	248	21	269	7.8	6.9	0

方向別自動車交通量調査表

調査地点 : 地域社会2 目黒交番前

調査年月日 : 令和元年10月13日(日) 天候:曇りのち雨

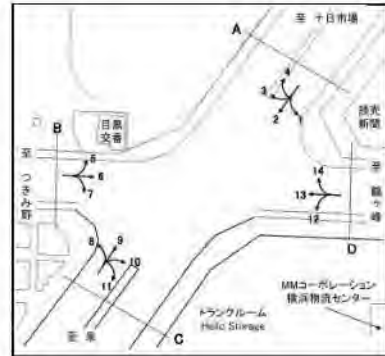

方向 種別 時間帯	1						2					
	小型車 (台)	大型車 (台)	合計 (台)	大型車 混入率 (%)	時間 係数 (%)	二輪車 (台)	小型車 (台)	大型車 (台)	合計 (台)	大型車 混入率 (%)	時間 係数 (%)	二輪車 (台)
14:00-14:15	3	0	3	0.0	1.7	0	63	2	65	3.1	1.7	3
14:15-14:30	0	1	1	100.0	0.6	0	47	2	49	4.1	1.3	1
14:30-14:45	0	0	0	0.0	0.0	0	48	0	48	0.0	1.2	1
14:45-15:00	1	0	1	0.0	0.6	0	44	3	47	6.4	1.2	0
1時間計	4	1	5	20.0	2.8	0	202	7	209	3.3	5.4	5
15:00-15:15	0	0	0	0.0	0.0	0	61	1	62	1.6	1.6	4
15:15-15:30	1	0	1	0.0	0.6	0	41	4	45	8.9	1.2	0
15:30-15:45	2	1	3	33.3	1.7	0	69	6	75	8.0	1.9	1
15:45-16:00	1	1	2	50.0	1.1	0	63	6	69	8.7	1.8	0
1時間計	4	2	6	33.3	3.4	0	234	17	251	6.8	6.5	5
16:00-16:15	2	0	2	0.0	1.1	0	75	7	82	8.5	2.1	2
16:15-16:30	1	0	1	0.0	0.6	0	63	4	67	6.0	1.7	2
16:30-16:45	0	1	1	100.0	0.6	0	65	2	67	3.0	1.7	1
16:45-17:00	3	0	3	0.0	1.7	0	61	1	62	1.6	1.6	2
1時間計	6	1	7	14.3	3.9	0	264	14	278	5.0	7.2	7
17:00-17:15	2	0	2	0.0	1.1	0	43	2	45	4.4	1.2	3
17:15-17:30	2	1	3	33.3	1.7	0	69	9	78	11.5	2.0	4
17:30-17:45	1	0	1	0.0	0.6	0	70	3	73	4.1	1.9	3
17:45-18:00	3	0	3	0.0	1.7	0	63	2	65	3.1	1.7	3
1時間計	8	1	9	11.1	5.1	0	245	16	261	6.1	6.7	13
18:00-18:15	1	0	1	0.0	0.6	0	54	1	55	1.8	1.4	2
18:15-18:30	1	0	1	0.0	0.6	0	67	1	68	1.5	1.8	2
18:30-18:45	1	0	1	0.0	0.6	0	58	0	58	0.0	1.5	5
18:45-19:00	0	0	0	0.0	0.0	0	49	1	50	2.0	1.3	4
1時間計	3	0	3	0.0	1.7	0	228	3	231	1.3	5.9	13
19:00-19:15	0	0	0	0.0	0.0	0	52	3	55	5.5	1.4	0
19:15-19:30	0	0	0	0.0	0.0	0	54	0	54	0.0	1.4	1
19:30-19:45	0	0	0	0.0	0.0	0	50	4	54	7.4	1.4	1
19:45-20:00	1	0	1	0.0	0.6	0	32	2	34	5.9	0.9	3
1時間計	1	0	1	0.0	0.6	0	188	9	197	4.6	5.1	5
20:00-20:15	2	0	2	0.0	1.1	0	55	0	55	0.0	1.4	2
20:15-20:30	0	1	1	100.0	0.6	0	38	1	39	2.6	1.0	2
20:30-20:45	0	0	0	0.0	0.0	0	44	0	44	0.0	1.1	1
20:45-21:00	3	0	3	0.0	1.7	0	33	4	37	10.8	1.0	2
1時間計	5	1	6	16.7	3.4	0	170	5	175	2.9	4.5	7
21:00-21:15	2	0	2	0.0	1.1	0	33	2	35	5.7	0.9	0
21:15-21:30	2	0	2	0.0	1.1	0	38	1	39	2.6	1.0	2
21:30-21:45	2	0	2	0.0	1.1	0	28	2	30	6.7	0.8	5
21:45-22:00	2	0	2	0.0	1.1	0	25	0	25	0.0	0.6	1
1時間計	8	0	8	0.0	4.5	0	124	5	129	3.9	3.3	8
昼12時間計	55	17	72	23.6	40.4	1	2633	189	2822	6.7	72.7	90
夜12時間計	66	40	106	37.7	59.6	6	976	85	1061	8.0	27.3	66
全時間合計	121	57	178	32.0	100.0	7	3609	274	3883	7.1	100.0	156
昼夜率	2.20	3.35	2.47	-	-	7.00	1.37	1.45	1.38	-	-	1.73

方向別自動車交通量調査表

調査地点 : 地域社会2 目黒交番前

調査年月日 : 令和元年10月13日(日) 天候:曇りのち雨



方向 種別 時間帯	3						4					
	小型車 (台)	大型車 (台)	合計 (台)	大型車 混入率 (%)	時間 係数 (%)	二輪車 (台)	小型車 (台)	大型車 (台)	合計 (台)	大型車 混入率 (%)	時間 係数 (%)	二輪車 (台)
22:00-22:15	7	1	8	12.5	0.3	1	0	0	0	0.0	0.0	0
22:15-22:30	11	1	12	8.3	0.5	0	0	0	0	0.0	0.0	0
22:30-22:45	6	1	7	14.3	0.3	0	0	0	0	0.0	0.0	0
22:45-23:00	9	1	10	10.0	0.4	0	0	0	0	0.0	0.0	0
1時間計	33	4	37	10.8	1.6	1	0	0	0	0.0	0.0	0
23:00-23:15	4	1	5	20.0	0.2	1	0	0	0	0.0	0.0	0
23:15-23:30	7	2	9	22.2	0.4	0	0	0	0	0.0	0.0	0
23:30-23:45	11	1	12	8.3	0.5	0	0	0	0	0.0	0.0	0
23:45-24:00	12	0	12	0.0	0.5	1	0	0	0	0.0	0.0	0
1時間計	34	4	38	10.5	1.6	2	0	0	0	0.0	0.0	0
0:00-0:15	5	1	6	16.7	0.3	0	1	0	1	0.0	25.0	0
0:15-0:30	6	0	6	0.0	0.3	0	0	0	0	0.0	0.0	0
0:30-0:45	5	1	6	16.7	0.3	0	1	0	1	0.0	25.0	0
0:45-1:00	4	1	5	20.0	0.2	0	0	0	0	0.0	0.0	0
1時間計	20	3	23	13.0	1.0	0	2	0	2	0.0	50.0	0
1:00-1:15	6	1	7	14.3	0.3	0	0	0	0	0.0	0.0	0
1:15-1:30	2	1	3	33.3	0.1	0	0	0	0	0.0	0.0	0
1:30-1:45	3	2	5	40.0	0.2	0	0	0	0	0.0	0.0	0
1:45-2:00	3	0	3	0.0	0.1	0	0	0	0	0.0	0.0	0
1時間計	14	4	18	22.2	0.8	0	0	0	0	0.0	0.0	0
2:00-2:15	1	0	1	0.0	0.0	0	0	0	0	0.0	0.0	0
2:15-2:30	0	1	1	100.0	0.0	0	0	0	0	0.0	0.0	0
2:30-2:45	1	1	2	50.0	0.1	0	0	0	0	0.0	0.0	0
2:45-3:00	7	2	9	22.2	0.4	0	0	0	0	0.0	0.0	0
1時間計	9	4	13	30.8	0.6	0	0	0	0	0.0	0.0	0
3:00-3:15	2	1	3	33.3	0.1	1	0	0	0	0.0	0.0	0
3:15-3:30	5	1	6	16.7	0.3	3	0	0	0	0.0	0.0	0
3:30-3:45	2	0	2	0.0	0.1	1	0	0	0	0.0	0.0	0
3:45-4:00	5	1	6	16.7	0.3	1	0	0	0	0.0	0.0	0
1時間計	14	3	17	17.6	0.7	6	0	0	0	0.0	0.0	0
4:00-4:15	2	1	3	33.3	0.1	0	0	0	0	0.0	0.0	0
4:15-4:30	2	0	2	0.0	0.1	1	0	0	0	0.0	0.0	0
4:30-4:45	3	0	3	0.0	0.1	0	0	0	0	0.0	0.0	0
4:45-5:00	4	2	6	33.3	0.3	1	1	0	1	0.0	25.0	0
1時間計	11	3	14	21.4	0.6	2	1	0	1	0.0	25.0	0
5:00-5:15	3	0	3	0.0	0.1	2	0	0	0	0.0	0.0	0
5:15-5:30	4	2	6	33.3	0.3	1	0	0	0	0.0	0.0	0
5:30-5:45	4	1	5	20.0	0.2	1	0	0	0	0.0	0.0	0
5:45-6:00	11	3	14	21.4	0.6	1	0	0	0	0.0	0.0	0
1時間計	22	6	28	21.4	1.2	5	0	0	0	0.0	0.0	0

方向別自動車交通量調査表

調査地点：地域社会2 目黒交番前

調査年月日：令和元年10月13日(日) 天候：曇りのち雨



方向	3						4						
	種別	小型車 (台)	大型車 (台)	合計 (台)	大型車 混入率 (%)	時間 係数 (%)	二輪車 (台)	小型車 (台)	大型車 (台)	合計 (台)	大型車 混入率 (%)	時間 係数 (%)	二輪車 (台)
6:00-6:15		15	1	16	6.3	0.7	0	0	0	0	0.0	0.0	0
6:15-6:30		12	1	13	7.7	0.6	0	0	0	0	0.0	0.0	0
6:30-6:45		18	0	18	0.0	0.8	2	0	0	0	0.0	0.0	0
6:45-7:00		8	0	8	0.0	0.3	2	0	0	0	0.0	0.0	0
1時間計		53	2	55	3.6	2.4	4	0	0	0	0.0	0.0	0
7:00-7:15		15	1	16	6.3	0.7	2	0	0	0	0.0	0.0	0
7:15-7:30		20	0	20	0.0	0.9	2	0	0	0	0.0	0.0	0
7:30-7:45		26	3	29	10.3	1.2	0	0	0	0	0.0	0.0	0
7:45-8:00		18	1	19	5.3	0.8	1	0	0	0	0.0	0.0	0
1時間計		79	5	84	6.0	3.6	5	0	0	0	0.0	0.0	0
8:00-8:15		38	2	40	5.0	1.7	5	0	0	0	0.0	0.0	0
8:15-8:30		30	6	36	16.7	1.5	2	0	0	0	0.0	0.0	0
8:30-8:45		30	4	34	11.8	1.5	4	0	0	0	0.0	0.0	0
8:45-9:00		25	0	25	0.0	1.1	2	0	0	0	0.0	0.0	0
1時間計		123	12	135	8.9	5.8	13	0	0	0	0.0	0.0	0
9:00-9:15		36	5	41	12.2	1.8	0	0	0	0	0.0	0.0	0
9:15-9:30		40	1	41	2.4	1.8	1	0	0	0	0.0	0.0	0
9:30-9:45		30	3	33	9.1	1.4	2	0	0	0	0.0	0.0	0
9:45-10:00		41	1	42	2.4	1.8	0	0	0	0	0.0	0.0	0
1時間計		147	10	157	6.4	6.7	3	0	0	0	0.0	0.0	0
10:00-10:15		33	7	40	17.5	1.7	1	0	0	0	0.0	0.0	0
10:15-10:30		28	5	33	15.2	1.4	2	0	0	0	0.0	0.0	0
10:30-10:45		43	4	47	8.5	2.0	0	0	0	0	0.0	0.0	0
10:45-11:00		32	7	39	17.9	1.7	0	0	0	0	0.0	0.0	0
1時間計		136	23	159	14.5	6.8	3	0	0	0	0.0	0.0	0
11:00-11:15		45	4	49	8.2	2.1	0	0	0	0	0.0	0.0	0
11:15-11:30		35	5	40	12.5	1.7	1	0	0	0	0.0	0.0	0
11:30-11:45		46	2	48	4.2	2.1	1	0	0	0	0.0	0.0	0
11:45-12:00		41	2	43	4.7	1.8	0	0	0	0	0.0	0.0	0
1時間計		167	13	180	7.2	7.7	2	0	0	0	0.0	0.0	0
12:00-12:15		41	3	44	6.8	1.9	0	0	0	0	0.0	0.0	0
12:15-12:30		41	3	44	6.8	1.9	1	0	0	0	0.0	0.0	0
12:30-12:45		38	2	40	5.0	1.7	0	0	0	0	0.0	0.0	0
12:45-13:00		32	1	33	3.0	1.4	0	0	0	0	0.0	0.0	0
1時間計		152	9	161	5.6	6.9	1	0	0	0	0.0	0.0	0
13:00-13:15		38	3	41	7.3	1.8	0	0	0	0	0.0	0.0	0
13:15-13:30		39	4	43	9.3	1.8	0	0	0	0	0.0	0.0	0
13:30-13:45		36	4	40	10.0	1.7	1	0	0	0	0.0	0.0	0
13:45-14:00		33	4	37	10.8	1.6	0	0	0	0	0.0	0.0	0
1時間計		146	15	161	9.3	6.9	1	0	0	0	0.0	0.0	0

方向別自動車交通量調査表

調査地点：地域社会2 目黒交番前

調査年月日：令和元年10月13日(日) 天候：曇りのち雨



方向 種別 時間帯	3						4					
	小型車 (台)	大型車 (台)	合計 (台)	大型車 混入率 (%)	時間 係数 (%)	二輪車 (台)	小型車 (台)	大型車 (台)	合計 (台)	大型車 混入率 (%)	時間 係数 (%)	二輪車 (台)
14:00-14:15	39	4	43	9.3	1.8	1	0	0	0	0.0	0.0	0
14:15-14:30	36	6	42	14.3	1.8	0	0	0	0	0.0	0.0	0
14:30-14:45	42	5	47	10.6	2.0	0	0	0	0	0.0	0.0	0
14:45-15:00	21	5	26	19.2	1.1	0	0	0	0	0.0	0.0	0
1時間計	138	20	158	12.7	6.8	1	0	0	0	0.0	0.0	0
15:00-15:15	39	1	40	2.5	1.7	0	0	0	0	0.0	0.0	0
15:15-15:30	33	1	34	2.9	1.5	0	0	0	0	0.0	0.0	0
15:30-15:45	39	8	47	17.0	2.0	0	0	0	0	0.0	0.0	0
15:45-16:00	25	6	31	19.4	1.3	1	0	0	0	0.0	0.0	0
1時間計	136	16	152	10.5	6.5	1	0	0	0	0.0	0.0	0
16:00-16:15	38	8	46	17.4	2.0	2	0	0	0	0.0	0.0	0
16:15-16:30	37	3	40	7.5	1.7	0	0	0	0	0.0	0.0	0
16:30-16:45	25	7	32	21.9	1.4	0	0	0	0	0.0	0.0	0
16:45-17:00	46	5	51	9.8	2.2	1	0	0	0	0.0	0.0	0
1時間計	146	23	169	13.6	7.2	3	0	0	0	0.0	0.0	0
17:00-17:15	38	1	39	2.6	1.7	2	0	0	0	0.0	0.0	0
17:15-17:30	38	1	39	2.6	1.7	1	0	0	0	0.0	0.0	0
17:30-17:45	41	5	46	10.9	2.0	1	0	0	0	0.0	0.0	0
17:45-18:00	40	1	41	2.4	1.8	0	0	0	0	0.0	0.0	0
1時間計	157	8	165	4.8	7.1	4	0	0	0	0.0	0.0	0
18:00-18:15	38	3	41	7.3	1.8	1	0	0	0	0.0	0.0	0
18:15-18:30	37	2	39	5.1	1.7	2	0	0	0	0.0	0.0	0
18:30-18:45	31	2	33	6.1	1.4	2	0	0	0	0.0	0.0	0
18:45-19:00	21	5	26	19.2	1.1	3	0	0	0	0.0	0.0	0
1時間計	127	12	139	8.6	6.0	8	0	0	0	0.0	0.0	0
19:00-19:15	34	3	37	8.1	1.6	0	0	0	0	0.0	0.0	0
19:15-19:30	24	4	28	14.3	1.2	0	0	0	0	0.0	0.0	0
19:30-19:45	23	2	25	8.0	1.1	2	0	0	0	0.0	0.0	0
19:45-20:00	26	3	29	10.3	1.2	1	0	0	0	0.0	0.0	0
1時間計	107	12	119	10.1	5.1	3	0	0	0	0.0	0.0	0
20:00-20:15	35	2	37	5.4	1.6	1	0	0	0	0.0	0.0	0
20:15-20:30	17	1	18	5.6	0.8	1	0	0	0	0.0	0.0	0
20:30-20:45	24	0	24	0.0	1.0	0	0	0	0	0.0	0.0	0
20:45-21:00	17	2	19	10.5	0.8	0	0	0	0	0.0	0.0	0
1時間計	93	5	98	5.1	4.2	2	0	0	0	0.0	0.0	0
21:00-21:15	15	1	16	6.3	0.7	1	0	0	0	0.0	0.0	0
21:15-21:30	13	1	14	7.1	0.6	2	1	0	1	0.0	25.0	0
21:30-21:45	15	0	15	0.0	0.6	0	0	0	0	0.0	0.0	0
21:45-22:00	9	0	9	0.0	0.4	0	0	0	0	0.0	0.0	0
1時間計	52	2	54	3.7	2.3	3	1	0	1	0.0	25.0	0
昼12時間計	1654	166	1820	9.1	78.0	45	0	0	0	0.0	0.0	0
夜12時間計	462	52	514	10.1	22.0	28	4	0	4	0.0	100.0	0
全時間合計	2116	218	2334	9.3	100.0	73	4	0	4	0.0	100.0	0
昼夜率	1.28	1.31	1.28	-	-	1.62	0.00	0.00	0.00	-	-	0.00

方向別自動車交通量調査表

調査地点：地域社会2 目黒交番前

調査年月日：令和元年10月13日(日) 天候：曇りのち雨

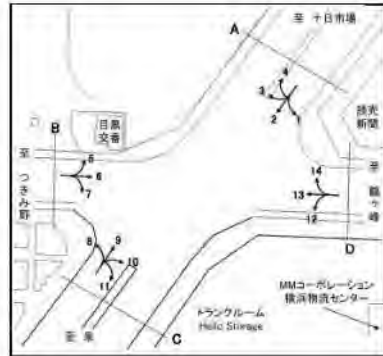

方向 種別 時間帯							A 合計 (1+ 2+ 3+ 4)					
	小型車 (台)	大型車 (台)	合計 (台)	大型車 混入率 (%)	時 間 係 数 (%)	二輪車 (台)	小型車 (台)	大型車 (台)	合計 (台)	大型車 混入率 (%)	時 間 係 数 (%)	二輪車 (台)
22:00-22:15							44	2	46	4.3	0.7	4
22:15-22:30							34	2	36	5.6	0.6	8
22:30-22:45							21	5	26	19.2	0.4	1
22:45-23:00							31	2	33	6.1	0.5	1
1 時間計							130	11	141	7.8	2.2	14
23:00-23:15							27	1	28	3.6	0.4	4
23:15-23:30							27	3	30	10.0	0.5	1
23:30-23:45							31	6	37	16.2	0.6	3
23:45-24:00							28	8	36	22.2	0.6	2
1 時間計							113	18	131	13.7	2.0	10
0:00- 0:15							28	6	34	17.6	0.5	0
0:15- 0:30							21	4	25	16.0	0.4	2
0:30- 0:45							20	9	29	31.0	0.5	2
0:45- 1:00							23	4	27	14.8	0.4	1
1 時間計							92	23	115	20.0	1.8	5
1:00- 1:15							20	5	25	20.0	0.4	2
1:15- 1:30							16	6	22	27.3	0.3	0
1:30- 1:45							16	7	23	30.4	0.4	0
1:45- 2:00							10	1	11	9.1	0.2	0
1 時間計							62	19	81	23.5	1.3	2
2:00- 2:15							7	1	8	12.5	0.1	1
2:15- 2:30							5	2	7	28.6	0.1	5
2:30- 2:45							8	2	10	20.0	0.2	0
2:45- 3:00							12	7	19	36.8	0.3	1
1 時間計							32	12	44	27.3	0.7	7
3:00- 3:15							6	3	9	33.3	0.1	2
3:15- 3:30							6	5	11	45.5	0.2	3
3:30- 3:45							4	0	4	0.0	0.1	2
3:45- 4:00							12	2	14	14.3	0.2	2
1 時間計							28	10	38	26.3	0.6	9
4:00- 4:15							12	1	13	7.7	0.2	0
4:15- 4:30							7	1	8	12.5	0.1	1
4:30- 4:45							11	4	15	26.7	0.2	0
4:45- 5:00							12	6	18	33.3	0.3	2
1 時間計							42	12	54	22.2	0.8	3
5:00- 5:15							10	3	13	23.1	0.2	5
5:15- 5:30							17	2	19	10.5	0.3	4
5:30- 5:45							20	4	24	16.7	0.4	1
5:45- 6:00							30	5	35	14.3	0.5	1
1 時間計							77	14	91	15.4	1.4	11

方向別自動車交通量調査表

調査地点：地域社会2 目黒交番前

調査年月日：令和元年10月13日(日) 天候：曇りのち雨



時間帯	方向 種別						A 合計 (1+ 2+ 3+ 4)					
		小型車 (台)	大型車 (台)	合計 (台)	大型車 混入率 (%)	時 間 係 数 (%)	二輪車 (台)	小型車 (台)	大型車 (台)	合計 (台)	大型車 混入率 (%)	時 間 係 数 (%)
6:00-6:15							38	8	46	17.4	0.7	0
6:15-6:30							50	2	52	3.8	0.8	1
6:30-6:45							54	4	58	6.9	0.9	5
6:45-7:00							41	5	46	10.9	0.7	5
1 時間計							183	19	202	9.4	3.2	11
7:00-7:15							51	4	55	7.3	0.9	5
7:15-7:30							67	4	71	5.6	1.1	5
7:30-7:45							73	6	79	7.6	1.2	3
7:45-8:00							62	7	69	10.1	1.1	3
1 時間計							253	21	274	7.7	4.3	16
8:00-8:15							102	10	112	8.9	1.8	6
8:15-8:30							63	14	77	18.2	1.2	4
8:30-8:45							74	7	81	8.6	1.3	5
8:45-9:00							69	3	72	4.2	1.1	3
1 時間計							308	34	342	9.9	5.3	18
9:00-9:15							93	9	102	8.8	1.6	3
9:15-9:30							89	7	96	7.3	1.5	5
9:30-9:45							76	7	83	8.4	1.3	3
9:45-10:00							95	5	100	5.0	1.6	3
1 時間計							353	28	381	7.3	6.0	14
10:00-10:15							85	12	97	12.4	1.5	3
10:15-10:30							65	14	79	17.7	1.2	3
10:30-10:45							94	6	100	6.0	1.6	3
10:45-11:00							94	13	107	12.1	1.7	3
1 時間計							338	45	383	11.7	6.0	12
11:00-11:15							126	16	142	11.3	2.2	1
11:15-11:30							80	7	87	8.0	1.4	3
11:30-11:45							114	7	121	5.8	1.9	3
11:45-12:00							111	7	118	5.9	1.8	1
1 時間計							431	37	468	7.9	7.3	8
12:00-12:15							102	9	111	8.1	1.7	0
12:15-12:30							91	9	100	9.0	1.6	3
12:30-12:45							89	5	94	5.3	1.5	2
12:45-13:00							74	6	80	7.5	1.3	2
1 時間計							356	29	385	7.5	6.0	7
13:00-13:15							97	8	105	7.6	1.6	0
13:15-13:30							105	10	115	8.7	1.8	0
13:30-13:45							108	11	119	9.2	1.9	1
13:45-14:00							91	8	99	8.1	1.5	0
1 時間計							401	37	438	8.4	6.8	1

方向別自動車交通量調査表

調査地点：地域社会2 目黒交番前

調査年月日：令和元年10月13日(日) 天候：曇りのち雨

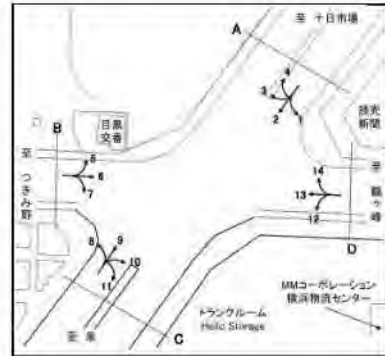

方向 種別 時間帯							A 合計 (1+ 2+ 3+ 4)					
	小型車 (台)	大型車 (台)	合計 (台)	大型車 混入率 (%)	時 間 係 数 (%)	二輪車 (台)	小型車 (台)	大型車 (台)	合計 (台)	大型車 混入率 (%)	時 間 係 数 (%)	二輪車 (台)
14:00-14:15							105	6	111	5.4	1.7	4
14:15-14:30							83	9	92	9.8	1.4	1
14:30-14:45							90	5	95	5.3	1.5	1
14:45-15:00							66	8	74	10.8	1.2	0
1時間計							344	28	372	7.5	5.8	6
15:00-15:15							100	2	102	2.0	1.6	4
15:15-15:30							75	5	80	6.3	1.3	0
15:30-15:45							110	15	125	12.0	2.0	1
15:45-16:00							89	13	102	12.7	1.6	1
1時間計							374	35	409	8.6	6.4	6
16:00-16:15							115	15	130	11.5	2.0	4
16:15-16:30							101	7	108	6.5	1.7	2
16:30-16:45							90	10	100	10.0	1.6	1
16:45-17:00							110	6	116	5.2	1.8	3
1時間計							416	38	454	8.4	7.1	10
17:00-17:15							83	3	86	3.5	1.3	5
17:15-17:30							109	11	120	9.2	1.9	5
17:30-17:45							112	8	120	6.7	1.9	4
17:45-18:00							106	3	109	2.8	1.7	3
1時間計							410	25	435	5.7	6.8	17
18:00-18:15							93	4	97	4.1	1.5	3
18:15-18:30							105	3	108	2.8	1.7	4
18:30-18:45							90	2	92	2.2	1.4	7
18:45-19:00							70	6	76	7.9	1.2	7
1時間計							358	15	373	4.0	5.8	21
19:00-19:15							86	6	92	6.5	1.4	0
19:15-19:30							78	4	82	4.9	1.3	1
19:30-19:45							73	6	79	7.6	1.2	3
19:45-20:00							59	5	64	7.8	1.0	4
1時間計							296	21	317	6.6	5.0	8
20:00-20:15							92	2	94	2.1	1.5	3
20:15-20:30							55	3	58	5.2	0.9	3
20:30-20:45							68	0	68	0.0	1.1	1
20:45-21:00							53	6	59	10.2	0.9	2
1時間計							268	11	279	3.9	4.4	9
21:00-21:15							50	3	53	5.7	0.8	1
21:15-21:30							54	2	56	3.6	0.9	4
21:30-21:45							45	2	47	4.3	0.7	5
21:45-22:00							36	0	36	0.0	0.6	1
1時間計							185	7	192	3.6	3.0	11
昼12時間計							4342	372	4714	7.9	73.7	136
夜12時間計							1508	177	1685	10.5	26.3	100
全時間合計							5850	549	6399	8.6	100.0	236
昼 夜 率							1.35	1.48	1.36	-	-	1.74

方向別自動車交通量調査表

調査地点：地域社会2 目黒交番前

調査年月日：令和元年10月13日(日) 天候：曇りのち雨

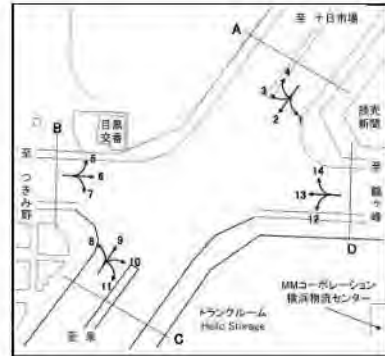

方向 種別 時間帯	5						6					
	小型車 (台)	大型車 (台)	合計 (台)	大型車 混入率 (%)	時間 係数 (%)	二輪車 (台)	小型車 (台)	大型車 (台)	合計 (台)	大型車 混入率 (%)	時間 係数 (%)	二輪車 (台)
22:00-22:15	21	1	22	4.5	0.9	3	88	11	99	11.1	1.1	3
22:15-22:30	19	3	22	13.6	0.9	2	87	4	91	4.4	1.0	3
22:30-22:45	17	4	21	19.0	0.9	0	77	9	86	10.5	1.0	3
22:45-23:00	9	2	11	18.2	0.5	2	62	12	74	16.2	0.8	11
1時間計	66	10	76	13.2	3.2	7	314	36	350	10.3	3.9	20
23:00-23:15	17	2	19	10.5	0.8	2	48	15	63	23.8	0.7	4
23:15-23:30	5	0	5	0.0	0.2	0	33	14	47	29.8	0.5	3
23:30-23:45	7	0	7	0.0	0.3	1	38	7	45	15.6	0.5	3
23:45-24:00	5	0	5	0.0	0.2	1	35	10	45	22.2	0.5	3
1時間計	34	2	36	5.6	1.5	4	154	46	200	23.0	2.3	13
0:00-0:15	7	1	8	12.5	0.3	0	38	5	43	11.6	0.5	2
0:15-0:30	2	0	2	0.0	0.1	2	26	7	33	21.2	0.4	0
0:30-0:45	3	1	4	25.0	0.2	0	19	3	22	13.6	0.2	3
0:45-1:00	9	0	9	0.0	0.4	1	23	5	28	17.9	0.3	1
1時間計	21	2	23	8.7	1.0	3	106	20	126	15.9	1.4	6
1:00-1:15	5	3	8	37.5	0.3	0	16	9	25	36.0	0.3	2
1:15-1:30	4	0	4	0.0	0.2	0	11	14	25	56.0	0.3	0
1:30-1:45	3	4	7	57.1	0.3	0	19	13	32	40.6	0.4	1
1:45-2:00	2	1	3	33.3	0.1	0	13	10	23	43.5	0.3	0
1時間計	14	8	22	36.4	0.9	0	59	46	105	43.8	1.2	3
2:00-2:15	2	0	2	0.0	0.1	2	20	10	30	33.3	0.3	1
2:15-2:30	5	0	5	0.0	0.2	0	13	8	21	38.1	0.2	0
2:30-2:45	2	2	4	50.0	0.2	0	9	16	25	64.0	0.3	1
2:45-3:00	4	0	4	0.0	0.2	0	17	11	28	39.3	0.3	1
1時間計	13	2	15	13.3	0.6	2	59	45	104	43.3	1.2	3
3:00-3:15	3	1	4	25.0	0.2	1	13	20	33	60.6	0.4	0
3:15-3:30	3	0	3	0.0	0.1	0	11	20	31	64.5	0.3	2
3:30-3:45	3	3	6	50.0	0.3	1	15	20	35	57.1	0.4	4
3:45-4:00	0	3	3	100.0	0.1	0	15	18	33	54.5	0.4	3
1時間計	9	7	16	43.8	0.7	2	54	78	132	59.1	1.5	9
4:00-4:15	2	2	4	50.0	0.2	0	15	24	39	61.5	0.4	0
4:15-4:30	5	1	6	16.7	0.3	0	26	22	48	45.8	0.5	3
4:30-4:45	2	1	3	33.3	0.1	1	29	14	43	32.6	0.5	2
4:45-5:00	3	3	6	50.0	0.3	0	33	19	52	36.5	0.6	1
1時間計	12	7	19	36.8	0.8	1	103	79	182	43.4	2.1	6
5:00-5:15	3	0	3	0.0	0.1	1	29	28	57	49.1	0.6	4
5:15-5:30	1	3	4	75.0	0.2	1	64	34	98	34.7	1.1	5
5:30-5:45	5	4	9	44.4	0.4	0	70	39	109	35.8	1.2	3
5:45-6:00	8	3	11	27.3	0.5	0	91	23	114	20.2	1.3	8
1時間計	17	10	27	37.0	1.1	2	254	124	378	32.8	4.3	20

方向別自動車交通量調査表

調査地点：地域社会2 目黒交番前

調査年月日：令和元年10月13日(日) 天候：曇りのち雨

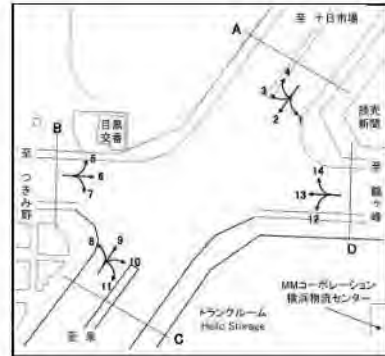

方向 時間帯	5						6					
	種別 小型車 (台)	大型車 (台)	合計 (台)	大型車 混入率 (%)	時間 係数 (%)	二輪車 (台)	小型車 (台)	大型車 (台)	合計 (台)	大型車 混入率 (%)	時間 係数 (%)	二輪車 (台)
6:00-6:15	11	1	12	8.3	0.5	0	83	25	108	23.1	1.2	2
6:15-6:30	11	3	14	21.4	0.6	0	93	29	122	23.8	1.4	8
6:30-6:45	19	6	25	24.0	1.1	2	71	42	113	37.2	1.3	5
6:45-7:00	18	4	22	18.2	0.9	0	110	26	136	19.1	1.5	6
1時間計	59	14	73	19.2	3.1	2	357	122	479	25.5	5.4	21
7:00-7:15	20	2	22	9.1	0.9	2	72	29	101	28.7	1.1	8
7:15-7:30	17	3	20	15.0	0.8	4	95	33	128	25.8	1.4	9
7:30-7:45	18	7	25	28.0	1.1	1	71	20	91	22.0	1.0	5
7:45-8:00	17	3	20	15.0	0.8	3	84	32	116	27.6	1.3	3
1時間計	72	15	87	17.2	3.7	10	322	114	436	26.1	4.9	25
8:00-8:15	18	10	28	35.7	1.2	3	87	25	112	22.3	1.3	9
8:15-8:30	36	4	40	10.0	1.7	1	85	34	119	28.6	1.3	4
8:30-8:45	25	14	39	35.9	1.7	0	101	32	133	24.1	1.5	3
8:45-9:00	20	15	35	42.9	1.5	1	78	18	96	18.8	1.1	2
1時間計	99	43	142	30.3	6.0	5	351	109	460	23.7	5.2	18
9:00-9:15	26	12	38	31.6	1.6	2	73	32	105	30.5	1.2	2
9:15-9:30	26	9	35	25.7	1.5	1	80	30	110	27.3	1.2	1
9:30-9:45	25	5	30	16.7	1.3	0	82	35	117	29.9	1.3	3
9:45-10:00	19	6	25	24.0	1.1	0	70	31	101	30.7	1.1	1
1時間計	96	32	128	25.0	5.4	3	305	128	433	29.6	4.9	7
10:00-10:15	22	2	24	8.3	1.0	0	66	28	94	29.8	1.1	1
10:15-10:30	23	2	25	8.0	1.1	1	69	27	96	28.1	1.1	3
10:30-10:45	22	3	25	12.0	1.1	0	79	29	108	26.9	1.2	1
10:45-11:00	26	4	30	13.3	1.3	0	73	34	107	31.8	1.2	0
1時間計	93	11	104	10.6	4.4	1	287	118	405	29.1	4.6	5
11:00-11:15	32	3	35	8.6	1.5	1	104	22	126	17.5	1.4	0
11:15-11:30	31	3	34	8.8	1.4	2	92	27	119	22.7	1.3	2
11:30-11:45	26	2	28	7.1	1.2	0	87	27	114	23.7	1.3	5
11:45-12:00	19	2	21	9.5	0.9	1	73	14	87	16.1	1.0	1
1時間計	108	10	118	8.5	5.0	4	356	90	446	20.2	5.0	8
12:00-12:15	36	5	41	12.2	1.7	1	96	21	117	17.9	1.3	1
12:15-12:30	20	5	25	20.0	1.1	0	78	18	96	18.8	1.1	1
12:30-12:45	33	5	38	13.2	1.6	0	86	20	106	18.9	1.2	1
12:45-13:00	26	6	32	18.8	1.4	0	79	24	103	23.3	1.2	0
1時間計	115	21	136	15.4	5.8	1	339	83	422	19.7	4.8	3
13:00-13:15	32	6	38	15.8	1.6	1	80	24	104	23.1	1.2	1
13:15-13:30	47	4	51	7.8	2.2	0	88	16	104	15.4	1.2	0
13:30-13:45	35	2	37	5.4	1.6	1	96	18	114	15.8	1.3	2
13:45-14:00	27	1	28	3.6	1.2	0	99	19	118	16.1	1.3	2
1時間計	141	13	154	8.4	6.5	2	363	77	440	17.5	5.0	5

方向別自動車交通量調査表

調査地点：地域社会2 目黒交番前

調査年月日：令和元年10月13日(日) 天候：曇りのち雨



方向 種別 時間帯	5						6					
	小型車 (台)	大型車 (台)	合計 (台)	大型車 混入率 (%)	時間 係数 (%)	二輪車 (台)	小型車 (台)	大型車 (台)	合計 (台)	大型車 混入率 (%)	時間 係数 (%)	二輪車 (台)
14:00-14:15	36	4	40	10.0	1.7	2	95	21	116	18.1	1.3	2
14:15-14:30	32	5	37	13.5	1.6	1	120	18	138	13.0	1.6	3
14:30-14:45	47	5	52	9.6	2.2	2	89	14	103	13.6	1.2	2
14:45-15:00	42	2	44	4.5	1.9	0	122	20	142	14.1	1.6	4
1時間計	157	16	173	9.2	7.3	5	426	73	499	14.6	5.6	11
15:00-15:15	39	2	41	4.9	1.7	0	85	16	101	15.8	1.1	2
15:15-15:30	39	5	44	11.4	1.9	1	121	22	143	15.4	1.6	4
15:30-15:45	28	1	29	3.4	1.2	2	75	15	90	16.7	1.0	0
15:45-16:00	32	6	38	15.8	1.6	1	97	21	118	17.8	1.3	3
1時間計	138	14	152	9.2	6.4	4	378	74	452	16.4	5.1	9
16:00-16:15	29	3	32	9.4	1.4	1	116	33	149	22.1	1.7	6
16:15-16:30	42	3	45	6.7	1.9	0	135	20	155	12.9	1.7	3
16:30-16:45	44	1	45	2.2	1.9	4	106	23	129	17.8	1.5	2
16:45-17:00	51	3	54	5.6	2.3	2	99	21	120	17.5	1.4	4
1時間計	166	10	176	5.7	7.4	7	456	97	553	17.5	6.2	15
17:00-17:15	48	3	51	5.9	2.2	1	118	15	133	11.3	1.5	12
17:15-17:30	43	5	48	10.4	2.0	1	95	11	106	10.4	1.2	4
17:30-17:45	64	6	70	8.6	3.0	4	144	19	163	11.7	1.8	5
17:45-18:00	33	3	36	8.3	1.5	1	106	10	116	8.6	1.3	4
1時間計	188	17	205	8.3	8.7	7	463	55	518	10.6	5.8	25
18:00-18:15	37	2	39	5.1	1.7	2	124	15	139	10.8	1.6	6
18:15-18:30	32	2	34	5.9	1.4	3	104	14	118	11.9	1.3	10
18:30-18:45	50	2	52	3.8	2.2	1	132	21	153	13.7	1.7	4
18:45-19:00	43	1	44	2.3	1.9	3	101	19	120	15.8	1.4	7
1時間計	162	7	169	4.1	7.2	9	461	69	530	13.0	6.0	27
19:00-19:15	39	0	39	0.0	1.7	0	127	18	145	12.4	1.6	7
19:15-19:30	36	1	37	2.7	1.6	2	78	20	98	20.4	1.1	3
19:30-19:45	38	3	41	7.3	1.7	1	107	15	122	12.3	1.4	4
19:45-20:00	22	2	24	8.3	1.0	1	78	13	91	14.3	1.0	7
1時間計	135	6	141	4.3	6.0	4	390	66	456	14.5	5.1	21
20:00-20:15	26	0	26	0.0	1.1	3	95	14	109	12.8	1.2	1
20:15-20:30	22	1	23	4.3	1.0	2	88	15	103	14.6	1.2	1
20:30-20:45	31	0	31	0.0	1.3	1	87	18	105	17.1	1.2	2
20:45-21:00	20	1	21	4.8	0.9	1	81	20	101	19.8	1.1	4
1時間計	99	2	101	2.0	4.3	7	351	67	418	16.0	4.7	8
21:00-21:15	28	2	30	6.7	1.3	2	101	25	126	19.8	1.4	2
21:15-21:30	15	0	15	0.0	0.6	0	58	10	68	14.7	0.8	5
21:30-21:45	13	1	14	7.1	0.6	2	61	13	74	17.6	0.8	3
21:45-22:00	11	0	11	0.0	0.5	0	59	14	73	19.2	0.8	1
1時間計	67	3	70	4.3	3.0	4	279	62	341	18.2	3.8	11
昼12時間計	1535	209	1744	12.0	73.8	58	4507	1087	5594	19.4	63.1	158
夜12時間計	546	73	619	11.8	26.2	38	2480	791	3271	24.2	36.9	141
全時間合計	2081	282	2363	11.9	100.0	96	6987	1878	8865	21.2	100.0	299
昼夜率	1.36	1.35	1.35	-	-	1.66	1.55	1.73	1.58	-	-	1.89

方向別自動車交通量調査表

調査地点：地域社会2 目黒交番前

調査年月日：令和元年10月13日(日) 天候：曇りのち雨

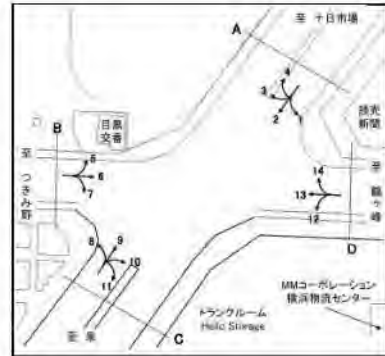

方向 種別 時間帯	7						B 合計 (5+ 6+ 7)					
	小型車 (台)	大型車 (台)	合計 (台)	大型車 混入率 (%)	時間 係数 (%)	二輪車 (台)	小型車 (台)	大型車 (台)	合計 (台)	大型車 混入率 (%)	時間 係数 (%)	二輪車 (台)
22:00-22:15	19	2	21	9.5	1.6	1	128	14	142	9.9	1.1	7
22:15-22:30	18	0	18	0.0	1.4	1	124	7	131	5.3	1.0	6
22:30-22:45	20	1	21	4.8	1.6	1	114	14	128	10.9	1.0	4
22:45-23:00	8	1	9	11.1	0.7	2	79	15	94	16.0	0.7	15
1時間計	65	4	69	5.8	5.2	5	445	50	495	10.1	3.9	32
23:00-23:15	13	2	15	13.3	1.1	1	78	19	97	19.6	0.8	7
23:15-23:30	9	2	11	18.2	0.8	0	47	16	63	25.4	0.5	3
23:30-23:45	5	1	6	16.7	0.5	0	50	8	58	13.8	0.5	4
23:45-24:00	8	0	8	0.0	0.6	1	48	10	58	17.2	0.5	5
1時間計	35	5	40	12.5	3.0	2	223	53	276	19.2	2.2	19
0:00- 0:15	11	1	12	8.3	0.9	2	56	7	63	11.1	0.5	4
0:15- 0:30	5	0	5	0.0	0.4	0	33	7	40	17.5	0.3	2
0:30- 0:45	2	2	4	50.0	0.3	0	24	6	30	20.0	0.2	3
0:45- 1:00	4	0	4	0.0	0.3	1	36	5	41	12.2	0.3	3
1時間計	22	3	25	12.0	1.9	3	149	25	174	14.4	1.4	12
1:00- 1:15	2	0	2	0.0	0.2	1	23	12	35	34.3	0.3	3
1:15- 1:30	2	2	4	50.0	0.3	1	17	16	33	48.5	0.3	1
1:30- 1:45	3	2	5	40.0	0.4	0	25	19	44	43.2	0.4	1
1:45- 2:00	8	0	8	0.0	0.6	0	23	11	34	32.4	0.3	0
1時間計	15	4	19	21.1	1.4	2	88	58	146	39.7	1.2	5
2:00- 2:15	4	0	4	0.0	0.3	0	26	10	36	27.8	0.3	3
2:15- 2:30	5	1	6	16.7	0.5	0	23	9	32	28.1	0.3	0
2:30- 2:45	3	0	3	0.0	0.2	0	14	18	32	56.3	0.3	1
2:45- 3:00	1	1	2	50.0	0.2	0	22	12	34	35.3	0.3	1
1時間計	13	2	15	13.3	1.1	0	85	49	134	36.6	1.1	5
3:00- 3:15	3	0	3	0.0	0.2	0	19	21	40	52.5	0.3	1
3:15- 3:30	2	2	4	50.0	0.3	0	16	22	38	57.9	0.3	2
3:30- 3:45	4	1	5	20.0	0.4	0	22	24	46	52.2	0.4	5
3:45- 4:00	1	1	2	50.0	0.2	0	16	22	38	57.9	0.3	3
1時間計	10	4	14	28.6	1.1	0	73	89	162	54.9	1.3	11
4:00- 4:15	1	1	2	50.0	0.2	0	18	27	45	60.0	0.4	0
4:15- 4:30	4	3	7	42.9	0.5	0	35	26	61	42.6	0.5	3
4:30- 4:45	2	0	2	0.0	0.2	1	33	15	48	31.3	0.4	4
4:45- 5:00	2	2	4	50.0	0.3	0	38	24	62	38.7	0.5	1
1時間計	9	6	15	40.0	1.1	1	124	92	216	42.6	1.7	8
5:00- 5:15	4	5	9	55.6	0.7	1	36	33	69	47.8	0.6	6
5:15- 5:30	4	2	6	33.3	0.5	1	69	39	108	36.1	0.9	7
5:30- 5:45	5	2	7	28.6	0.5	0	80	45	125	36.0	1.0	3
5:45- 6:00	7	0	7	0.0	0.5	1	106	26	132	19.7	1.1	9
1時間計	20	9	29	31.0	2.2	3	291	143	434	32.9	3.5	25

方向別自動車交通量調査表

調査地点：地域社会2 目黒交番前

調査年月日：令和元年10月13日(日) 天候：曇りのち雨



時間帯	7						B 合計 (5+ 6+ 7)					
	小型車 (台)	大型車 (台)	合計 (台)	大型車 混入率 (%)	時間 係数 (%)	二輪車 (台)	小型車 (台)	大型車 (台)	合計 (台)	大型車 混入率 (%)	時間 係数 (%)	二輪車 (台)
6:00-6:15	4	2	6	33.3	0.5	0	98	28	126	22.2	1.0	2
6:15-6:30	8	2	10	20.0	0.8	2	112	34	146	23.3	1.2	10
6:30-6:45	7	4	11	36.4	0.8	4	97	52	149	34.9	1.2	11
6:45-7:00	12	4	16	25.0	1.2	0	140	34	174	19.5	1.4	6
1時間計	31	12	43	27.9	3.3	6	447	148	595	24.9	4.7	29
7:00-7:15	12	2	14	14.3	1.1	1	104	33	137	24.1	1.1	11
7:15-7:30	9	3	12	25.0	0.9	0	121	39	160	24.4	1.3	13
7:30-7:45	12	3	15	20.0	1.1	1	101	30	131	22.9	1.0	7
7:45-8:00	8	2	10	20.0	0.8	0	109	37	146	25.3	1.2	6
1時間計	41	10	51	19.6	3.9	2	435	139	574	24.2	4.6	37
8:00-8:15	13	6	19	31.6	1.4	0	118	41	159	25.8	1.3	12
8:15-8:30	13	4	17	23.5	1.3	0	134	42	176	23.9	1.4	5
8:30-8:45	9	2	11	18.2	0.8	1	135	48	183	26.2	1.5	4
8:45-9:00	14	3	17	17.6	1.3	1	112	36	148	24.3	1.2	4
1時間計	49	15	64	23.4	4.9	2	499	167	666	25.1	5.3	25
9:00-9:15	8	0	8	0.0	0.6	1	107	44	151	29.1	1.2	5
9:15-9:30	13	1	14	7.1	1.1	1	119	40	159	25.2	1.3	3
9:30-9:45	19	4	23	17.4	1.7	1	126	44	170	25.9	1.4	4
9:45-10:00	17	3	20	15.0	1.5	1	106	40	146	27.4	1.2	2
1時間計	57	8	65	12.3	4.9	4	458	168	626	26.8	5.0	14
10:00-10:15	11	2	13	15.4	1.0	0	99	32	131	24.4	1.0	1
10:15-10:30	16	3	19	15.8	1.4	0	108	32	140	22.9	1.1	4
10:30-10:45	14	4	18	22.2	1.4	0	115	36	151	23.8	1.2	1
10:45-11:00	15	4	19	21.1	1.4	0	114	42	156	26.9	1.2	0
1時間計	56	13	69	18.8	5.2	0	436	142	578	24.6	4.6	6
11:00-11:15	15	3	18	16.7	1.4	0	151	28	179	15.6	1.4	1
11:15-11:30	7	3	10	30.0	0.8	0	130	33	163	20.2	1.3	4
11:30-11:45	12	1	13	7.7	1.0	0	125	30	155	19.4	1.2	5
11:45-12:00	9	2	11	18.2	0.8	1	101	18	119	15.1	0.9	3
1時間計	43	9	52	17.3	4.0	1	507	109	616	17.7	4.9	13
12:00-12:15	22	7	29	24.1	2.2	2	154	33	187	17.6	1.5	4
12:15-12:30	10	3	13	23.1	1.0	1	108	26	134	19.4	1.1	2
12:30-12:45	19	2	21	9.5	1.6	0	138	27	165	16.4	1.3	1
12:45-13:00	16	5	21	23.8	1.6	0	121	35	156	22.4	1.2	0
1時間計	67	17	84	20.2	6.4	3	521	121	642	18.8	5.1	7
13:00-13:15	9	3	12	25.0	0.9	1	121	33	154	21.4	1.2	3
13:15-13:30	27	1	28	3.6	2.1	0	162	21	183	11.5	1.5	0
13:30-13:45	13	3	16	18.8	1.2	0	144	23	167	13.8	1.3	3
13:45-14:00	17	3	20	15.0	1.5	0	143	23	166	13.9	1.3	2
1時間計	66	10	76	13.2	5.8	1	570	100	670	14.9	5.3	8

方向別自動車交通量調査表

調査地点 : 地域社会2 日黒交番前

調査年月日 : 令和元年10月13日(日) 天候:曇りのち雨



方向 種別	7						B 合計 (5+ 6+ 7)					
	小型車 (台)	大型車 (台)	合計 (台)	大型車 混入率 (%)	時 間 係 数 (%)	二輪車 (台)	小型車 (台)	大型車 (台)	合計 (台)	大型車 混入率 (%)	時 間 係 数 (%)	二輪車 (台)
14:00-14:15	16	1	17	5.9	1.3	0	147	26	173	15.0	1.4	4
14:15-14:30	20	1	21	4.8	1.6	0	172	24	196	12.2	1.6	4
14:30-14:45	13	0	13	0.0	1.0	0	149	19	168	11.3	1.3	4
14:45-15:00	20	3	23	13.0	1.7	0	184	25	209	12.0	1.7	4
1時間計	69	5	74	6.8	5.6	0	652	94	746	12.6	5.9	16
15:00-15:15	13	4	17	23.5	1.3	0	137	22	159	13.8	1.3	2
15:15-15:30	26	2	28	7.1	2.1	0	186	29	215	13.5	1.7	5
15:30-15:45	14	2	16	12.5	1.2	1	117	18	135	13.3	1.1	3
15:45-16:00	18	1	19	5.3	1.4	1	147	28	175	16.0	1.4	5
1時間計	71	9	80	11.3	6.1	2	587	97	684	14.2	5.5	15
16:00-16:15	22	0	22	0.0	1.7	0	167	36	203	17.7	1.6	7
16:15-16:30	16	4	20	20.0	1.5	1	193	27	220	12.3	1.8	4
16:30-16:45	16	3	19	15.8	1.4	1	166	27	193	14.0	1.5	7
16:45-17:00	16	2	18	11.1	1.4	0	166	26	192	13.5	1.5	6
1時間計	70	9	79	11.4	6.0	2	692	116	808	14.4	6.4	24
17:00-17:15	21	2	23	8.7	1.7	1	187	20	207	9.7	1.7	14
17:15-17:30	19	2	21	9.5	1.6	0	157	18	175	10.3	1.4	5
17:30-17:45	21	3	24	12.5	1.8	1	229	28	257	10.9	2.0	10
17:45-18:00	12	2	14	14.3	1.1	1	151	15	166	9.0	1.3	6
1時間計	73	9	82	11.0	6.2	3	724	81	805	10.1	6.4	35
18:00-18:15	14	1	15	6.7	1.1	4	175	18	193	9.3	1.5	12
18:15-18:30	22	0	22	0.0	1.7	0	158	16	174	9.2	1.4	13
18:30-18:45	23	3	26	11.5	2.0	0	205	26	231	11.3	1.8	5
18:45-19:00	12	3	15	20.0	1.1	0	156	23	179	12.8	1.4	10
1時間計	71	7	78	9.0	5.9	4	694	83	777	10.7	6.2	40
19:00-19:15	13	1	14	7.1	1.1	1	179	19	198	9.6	1.6	8
19:15-19:30	15	1	16	6.3	1.2	0	129	22	151	14.6	1.2	5
19:30-19:45	13	3	16	18.8	1.2	1	158	21	179	11.7	1.4	6
19:45-20:00	10	1	11	9.1	0.8	0	110	16	126	12.7	1.0	8
1時間計	51	6	57	10.5	4.3	2	576	78	654	11.9	5.2	27
20:00-20:15	12	3	15	20.0	1.1	1	133	17	150	11.3	1.2	5
20:15-20:30	13	0	13	0.0	1.0	0	123	16	139	11.5	1.1	3
20:30-20:45	14	2	16	12.5	1.2	0	132	20	152	13.2	1.2	3
20:45-21:00	11	4	15	26.7	1.1	2	112	25	137	18.2	1.1	7
1時間計	50	9	59	15.3	4.5	3	500	78	578	13.5	4.6	18
21:00-21:15	23	2	25	8.0	1.9	1	152	29	181	16.0	1.4	5
21:15-21:30	17	0	17	0.0	1.3	3	90	10	100	10.0	0.8	8
21:30-21:45	15	1	16	6.3	1.2	2	89	15	104	14.4	0.8	7
21:45-22:00	19	0	19	0.0	1.4	0	89	14	103	13.6	0.8	1
1時間計	74	3	77	3.9	5.9	6	420	68	488	13.9	3.9	21
昼12時間計	733	121	854	14.2	64.9	24	6775	1417	8192	17.3	65.3	240
夜12時間計	395	67	462	14.5	35.1	33	3421	931	4352	21.4	34.7	212
全時間合計	1128	188	1316	14.3	100.0	57	10196	2348	12544	18.7	100.0	452
昼 夜 率	1.54	1.55	1.54	-	-	2.38	1.50	1.66	1.53	-	-	1.88

方向別自動車交通量調査表

調査地点：地域社会2 目黒交番前

調査年月日：令和元年10月13日(日) 天候：曇りのち雨

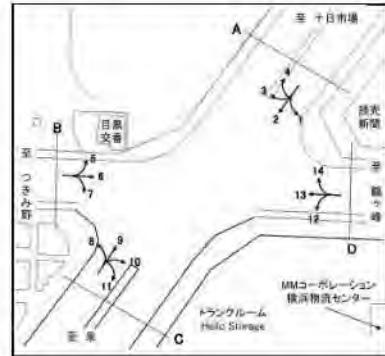

方向 種別 時間帯	8						9					
	小型車 (台)	大型車 (台)	合計 (台)	大型車 混入率 (%)	時間 係数 (%)	二輪車 (台)	小型車 (台)	大型車 (台)	合計 (台)	大型車 混入率 (%)	時間 係数 (%)	二輪車 (台)
22:00-22:15	3	0	3	0.0	0.4	0	23	0	23	0.0	0.6	1
22:15-22:30	7	0	7	0.0	0.9	2	13	0	13	0.0	0.3	1
22:30-22:45	4	0	4	0.0	0.5	0	19	0	19	0.0	0.5	0
22:45-23:00	10	0	10	0.0	1.2	0	14	7	21	33.3	0.5	1
1時間計	24	0	24	0.0	2.9	2	69	7	76	9.2	2.0	3
23:00-23:15	3	1	4	25.0	0.5	0	13	4	17	23.5	0.4	3
23:15-23:30	0	2	2	100.0	0.2	0	6	1	7	14.3	0.2	1
23:30-23:45	5	1	6	16.7	0.7	0	19	1	20	5.0	0.5	2
23:45-24:00	0	2	2	100.0	0.2	0	11	0	11	0.0	0.3	1
1時間計	8	6	14	42.9	1.7	0	49	6	55	10.9	1.4	7
0:00-0:15	1	0	1	0.0	0.1	0	9	0	9	0.0	0.2	3
0:15-0:30	2	0	2	0.0	0.2	0	5	0	5	0.0	0.1	1
0:30-0:45	1	1	2	50.0	0.2	1	7	0	7	0.0	0.2	0
0:45-1:00	1	0	1	0.0	0.1	0	7	0	7	0.0	0.2	0
1時間計	5	1	6	16.7	0.7	1	28	0	28	0.0	0.7	4
1:00-1:15	0	0	0	0.0	0.0	0	9	1	10	10.0	0.3	1
1:15-1:30	2	0	2	0.0	0.2	0	3	0	3	0.0	0.1	0
1:30-1:45	3	0	3	0.0	0.4	0	7	0	7	0.0	0.2	0
1:45-2:00	1	0	1	0.0	0.1	0	5	4	9	44.4	0.2	2
1時間計	6	0	6	0.0	0.7	0	24	5	29	17.2	0.8	3
2:00-2:15	1	2	3	66.7	0.4	0	4	1	5	20.0	0.1	0
2:15-2:30	1	0	1	0.0	0.1	0	2	4	6	66.7	0.2	0
2:30-2:45	1	0	1	0.0	0.1	0	5	2	7	28.6	0.2	0
2:45-3:00	1	2	3	66.7	0.4	0	3	3	6	50.0	0.2	0
1時間計	4	4	8	50.0	1.0	0	14	10	24	41.7	0.6	0
3:00-3:15	1	0	1	0.0	0.1	0	2	0	2	0.0	0.1	0
3:15-3:30	1	0	1	0.0	0.1	0	6	2	8	25.0	0.2	0
3:30-3:45	1	1	2	50.0	0.2	0	2	3	5	60.0	0.1	0
3:45-4:00	1	0	1	0.0	0.1	0	5	0	5	0.0	0.1	1
1時間計	4	1	5	20.0	0.6	0	15	5	20	25.0	0.5	1
4:00-4:15	1	2	3	66.7	0.4	0	9	2	11	18.2	0.3	1
4:15-4:30	0	3	3	100.0	0.4	0	8	2	10	20.0	0.3	1
4:30-4:45	3	0	3	0.0	0.4	0	5	2	7	28.6	0.2	0
4:45-5:00	0	0	0	0.0	0.0	0	7	4	11	36.4	0.3	1
1時間計	4	5	9	55.6	1.1	0	29	10	39	25.6	1.0	3
5:00-5:15	0	0	0	0.0	0.0	0	8	9	17	52.9	0.4	1
5:15-5:30	2	4	6	66.7	0.7	0	17	1	18	5.6	0.5	0
5:30-5:45	2	0	2	0.0	0.2	0	23	6	29	20.7	0.8	2
5:45-6:00	1	1	2	50.0	0.2	0	31	5	36	13.9	0.9	2
1時間計	5	5	10	50.0	1.2	0	79	21	100	21.0	2.6	5

方向別自動車交通量調査表

調査地点：地域社会2 目黒交番前

調査年月日：令和元年10月13日(日) 天候：曇りのち雨

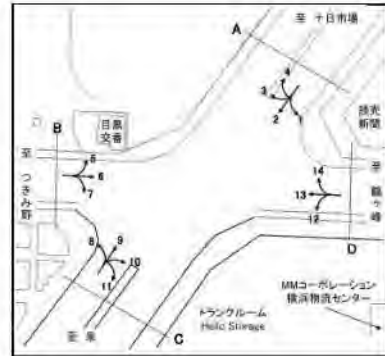

方向 時間帯	8						9					
	種別 小型車 (台)	大型車 (台)	合計 (台)	大型車 混入率 (%)	時間 係数 (%)	二輪車 (台)	小型車 (台)	大型車 (台)	合計 (台)	大型車 混入率 (%)	時間 係数 (%)	二輪車 (台)
6:00-6:15	2	0	2	0.0	0.2	0	35	4	39	10.3	1.0	3
6:15-6:30	2	2	4	50.0	0.5	0	51	5	56	8.9	1.5	5
6:30-6:45	6	4	10	40.0	1.2	0	59	10	69	14.5	1.8	9
6:45-7:00	9	1	10	10.0	1.2	0	50	3	53	5.7	1.4	4
1時間計	19	7	26	26.9	3.2	0	195	22	217	10.1	5.7	21
7:00-7:15	7	4	11	36.4	1.3	1	53	6	59	10.2	1.5	3
7:15-7:30	6	2	8	25.0	1.0	0	65	6	71	8.5	1.9	4
7:30-7:45	12	0	12	0.0	1.5	1	45	7	52	13.5	1.4	6
7:45-8:00	2	6	8	75.0	1.0	0	41	3	44	6.8	1.2	7
1時間計	27	12	39	30.8	4.8	2	204	22	226	9.7	5.9	20
8:00-8:15	10	3	13	23.1	1.6	1	81	4	85	4.7	2.2	7
8:15-8:30	9	2	11	18.2	1.3	1	65	3	68	4.4	1.8	7
8:30-8:45	20	6	26	23.1	3.2	0	70	6	76	7.9	2.0	3
8:45-9:00	10	3	13	23.1	1.6	0	54	3	57	5.3	1.5	2
1時間計	49	14	63	22.2	7.7	2	270	16	286	5.6	7.5	19
9:00-9:15	15	6	21	28.6	2.6	2	43	2	45	4.4	1.2	2
9:15-9:30	9	5	14	35.7	1.7	0	62	3	65	4.6	1.7	3
9:30-9:45	10	5	15	33.3	1.8	0	53	3	56	5.4	1.5	0
9:45-10:00	8	2	10	20.0	1.2	0	51	3	54	5.6	1.4	1
1時間計	42	18	60	30.0	7.3	2	209	11	220	5.0	5.8	6
10:00-10:15	2	1	3	33.3	0.4	0	50	6	56	10.7	1.5	1
10:15-10:30	9	1	10	10.0	1.2	0	49	2	51	3.9	1.3	1
10:30-10:45	10	4	14	28.6	1.7	0	46	4	50	8.0	1.3	0
10:45-11:00	16	2	18	11.1	2.2	0	65	7	72	9.7	1.9	1
1時間計	37	8	45	17.8	5.5	0	210	19	229	8.3	6.0	3
11:00-11:15	18	3	21	14.3	2.6	0	51	2	53	3.8	1.4	1
11:15-11:30	10	3	13	23.1	1.6	1	63	6	69	8.7	1.8	1
11:30-11:45	14	6	20	30.0	2.4	0	57	11	68	16.2	1.8	1
11:45-12:00	13	4	17	23.5	2.1	1	46	4	50	8.0	1.3	0
1時間計	55	16	71	22.5	8.7	2	217	23	240	9.6	6.3	3
12:00-12:15	3	1	4	25.0	0.5	0	38	4	42	9.5	1.1	2
12:15-12:30	12	0	12	0.0	1.5	0	53	3	56	5.4	1.5	1
12:30-12:45	7	2	9	22.2	1.1	0	57	2	59	3.4	1.5	2
12:45-13:00	10	1	11	9.1	1.3	0	57	3	60	5.0	1.6	1
1時間計	32	4	36	11.1	4.4	0	205	12	217	5.5	5.7	6
13:00-13:15	9	2	11	18.2	1.3	0	55	2	57	3.5	1.5	2
13:15-13:30	9	1	10	10.0	1.2	0	51	2	53	3.8	1.4	5
13:30-13:45	10	0	10	0.0	1.2	0	53	3	56	5.4	1.5	2
13:45-14:00	8	2	10	20.0	1.2	0	42	0	42	0.0	1.1	0
1時間計	36	5	41	12.2	5.0	0	201	7	208	3.4	5.4	9

方向別自動車交通量調査表

調査地点：地域社会2 目黒交番前

調査年月日：令和元年10月13日(日) 天候：曇りのち雨

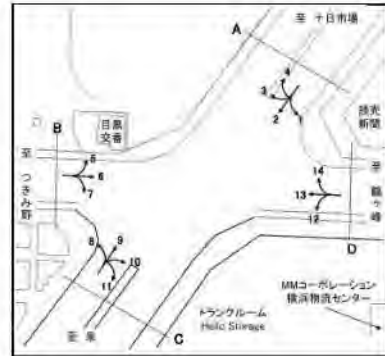

方向 種別 時間帯	8						9					
	小型車 (台)	大型車 (台)	合計 (台)	大型車 混入率 (%)	時間 係数 (%)	二輪車 (台)	小型車 (台)	大型車 (台)	合計 (台)	大型車 混入率 (%)	時間 係数 (%)	二輪車 (台)
14:00-14:15	8	0	8	0.0	1.0	0	40	4	44	9.1	1.2	1
14:15-14:30	3	2	5	40.0	0.6	1	41	0	41	0.0	1.1	4
14:30-14:45	14	3	17	17.6	2.1	0	64	2	66	3.0	1.7	3
14:45-15:00	16	3	19	15.8	2.3	0	48	1	49	2.0	1.3	1
1時間計	41	8	49	16.3	6.0	1	193	7	200	3.5	5.2	9
15:00-15:15	18	4	22	18.2	2.7	0	60	2	62	3.2	1.6	0
15:15-15:30	12	0	12	0.0	1.5	1	48	4	52	7.7	1.4	3
15:30-15:45	5	3	8	37.5	1.0	0	44	3	47	6.4	1.2	2
15:45-16:00	10	1	11	9.1	1.3	0	50	0	50	0.0	1.3	1
1時間計	45	8	53	15.1	6.5	1	202	9	211	4.3	5.5	6
16:00-16:15	20	2	22	9.1	2.7	0	56	2	58	3.4	1.5	2
16:15-16:30	7	0	7	0.0	0.9	0	64	6	70	8.6	1.8	1
16:30-16:45	6	3	9	33.3	1.1	0	65	4	69	5.8	1.8	1
16:45-17:00	9	4	13	30.8	1.6	0	57	3	60	5.0	1.6	1
1時間計	42	9	51	17.6	6.2	0	242	15	257	5.8	6.7	5
17:00-17:15	22	3	25	12.0	3.1	0	83	5	88	5.7	2.3	1
17:15-17:30	18	0	18	0.0	2.2	0	87	3	90	3.3	2.4	1
17:30-17:45	4	2	6	33.3	0.7	0	77	0	77	0.0	2.0	0
17:45-18:00	13	0	13	0.0	1.6	0	91	1	92	1.1	2.4	0
1時間計	57	5	62	8.1	7.6	0	338	9	347	2.6	9.1	2
18:00-18:15	15	3	18	16.7	2.2	1	78	1	79	1.3	2.1	4
18:15-18:30	16	0	16	0.0	2.0	0	43	3	46	6.5	1.2	2
18:30-18:45	11	4	15	26.7	1.8	0	60	0	60	0.0	1.6	1
18:45-19:00	8	2	10	20.0	1.2	0	31	1	32	3.1	0.8	1
1時間計	50	9	59	15.3	7.2	1	212	5	217	2.3	5.7	8
19:00-19:15	11	1	12	8.3	1.5	0	53	0	53	0.0	1.4	2
19:15-19:30	10	0	10	0.0	1.2	0	35	0	35	0.0	0.9	1
19:30-19:45	7	0	7	0.0	0.9	0	46	2	48	4.2	1.3	1
19:45-20:00	3	0	3	0.0	0.4	0	34	1	35	2.9	0.9	1
1時間計	31	1	32	3.1	3.9	0	168	3	171	1.8	4.5	5
20:00-20:15	5	0	5	0.0	0.6	0	35	5	40	12.5	1.0	2
20:15-20:30	5	0	5	0.0	0.6	0	28	1	29	3.4	0.8	1
20:30-20:45	4	0	4	0.0	0.5	1	32	0	32	0.0	0.8	1
20:45-21:00	7	2	9	22.2	1.1	0	23	0	23	0.0	0.6	1
1時間計	21	2	23	8.7	2.8	1	118	6	124	4.8	3.2	5
21:00-21:15	4	1	5	20.0	0.6	0	22	2	24	8.3	0.6	1
21:15-21:30	7	2	9	22.2	1.1	0	21	2	23	8.7	0.6	1
21:30-21:45	5	1	6	16.7	0.7	0	16	0	16	0.0	0.4	2
21:45-22:00	4	1	5	20.0	0.6	1	22	0	22	0.0	0.6	1
1時間計	20	5	25	20.0	3.1	1	81	4	85	4.7	2.2	5
昼12時間計	513	116	629	18.4	77.0	11	2703	155	2858	5.4	74.7	96
夜12時間計	151	37	188	19.7	23.0	5	869	99	968	10.2	25.3	62
全時間合計	664	153	817	18.7	100.0	16	3572	254	3826	6.6	100.0	158
昼夜率	1.29	1.32	1.30	-	-	1.45	1.32	1.64	1.34	-	-	1.65

方向別自動車交通量調査表

調査地点：地域社会2 目黒交番前

調査年月日：令和元年10月13日(日) 天候：曇りのち雨

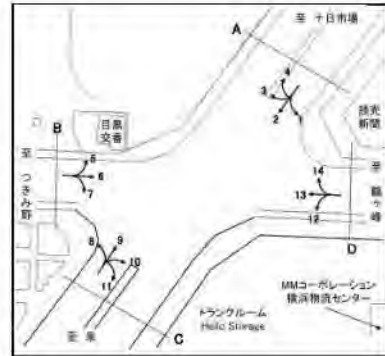

方向 種別 時間帯	10						11					
	小型車 (台)	大型車 (台)	合計 (台)	大型車 混入率 (%)	時間 係数 (%)	二輪車 (台)	小型車 (台)	大型車 (台)	合計 (台)	大型車 混入率 (%)	時間 係数 (%)	二輪車 (台)
22:00-22:15	0	0	0	0.0	0.0	0	0	0	0	0.0	0.0	0
22:15-22:30	8	1	9	11.1	0.8	0	0	0	0	0.0	0.0	0
22:30-22:45	7	4	11	36.4	0.9	1	0	0	0	0.0	0.0	0
22:45-23:00	9	2	11	18.2	0.9	2	0	0	0	0.0	0.0	0
1時間計	24	7	31	22.6	2.6	3	0	0	0	0.0	0.0	0
23:00-23:15	9	2	11	18.2	0.9	1	0	0	0	0.0	0.0	0
23:15-23:30	3	1	4	25.0	0.3	0	0	0	0	0.0	0.0	0
23:30-23:45	4	0	4	0.0	0.3	0	0	0	0	0.0	0.0	0
23:45-24:00	2	0	2	0.0	0.2	0	0	0	0	0.0	0.0	0
1時間計	18	3	21	14.3	1.8	1	0	0	0	0.0	0.0	0
0:00-0:15	5	1	6	16.7	0.5	0	0	0	0	0.0	0.0	0
0:15-0:30	2	0	2	0.0	0.2	0	0	0	0	0.0	0.0	0
0:30-0:45	3	1	4	25.0	0.3	1	0	0	0	0.0	0.0	0
0:45-1:00	3	0	3	0.0	0.3	1	0	0	0	0.0	0.0	0
1時間計	13	2	15	13.3	1.3	2	0	0	0	0.0	0.0	0
1:00-1:15	5	0	5	0.0	0.4	1	0	0	0	0.0	0.0	0
1:15-1:30	4	0	4	0.0	0.3	1	0	0	0	0.0	0.0	0
1:30-1:45	2	1	3	33.3	0.3	0	0	0	0	0.0	0.0	0
1:45-2:00	4	0	4	0.0	0.3	0	0	0	0	0.0	0.0	0
1時間計	15	1	16	6.3	1.3	2	0	0	0	0.0	0.0	0
2:00-2:15	2	0	2	0.0	0.2	0	0	0	0	0.0	0.0	0
2:15-2:30	2	0	2	0.0	0.2	2	0	0	0	0.0	0.0	0
2:30-2:45	3	0	3	0.0	0.3	1	0	0	0	0.0	0.0	0
2:45-3:00	1	0	1	0.0	0.1	0	0	0	0	0.0	0.0	0
1時間計	8	0	8	0.0	0.7	3	0	0	0	0.0	0.0	0
3:00-3:15	2	0	2	0.0	0.2	0	0	0	0	0.0	0.0	0
3:15-3:30	2	1	3	33.3	0.3	0	0	0	0	0.0	0.0	0
3:30-3:45	3	0	3	0.0	0.3	0	0	0	0	0.0	0.0	0
3:45-4:00	1	0	1	0.0	0.1	1	0	0	0	0.0	0.0	0
1時間計	8	1	9	11.1	0.8	1	0	0	0	0.0	0.0	0
4:00-4:15	1	2	3	66.7	0.3	0	0	0	0	0.0	0.0	0
4:15-4:30	5	1	6	16.7	0.5	0	0	0	0	0.0	0.0	0
4:30-4:45	4	0	4	0.0	0.3	1	0	0	0	0.0	0.0	0
4:45-5:00	8	3	11	27.3	0.9	0	0	0	0	0.0	0.0	0
1時間計	18	6	24	25.0	2.0	1	0	0	0	0.0	0.0	0
5:00-5:15	10	0	10	0.0	0.8	1	0	0	0	0.0	0.0	0
5:15-5:30	8	2	10	20.0	0.8	1	0	0	0	0.0	0.0	0
5:30-5:45	12	0	12	0.0	1.0	2	0	0	0	0.0	0.0	0
5:45-6:00	16	2	18	11.1	1.5	0	0	0	0	0.0	0.0	0
1時間計	46	4	50	8.0	4.2	4	0	0	0	0.0	0.0	0

方向別自動車交通量調査表

調査地点：地域社会2 目黒交番前

調査年月日：令和元年10月13日(日) 天候：曇りのち雨



方向 時間帯	10						11					
	種別 小型車 (台)	大型車 (台)	合計 (台)	大型車 混入率 (%)	時間 係数 (%)	二輪車 (台)	小型車 (台)	大型車 (台)	合計 (台)	大型車 混入率 (%)	時間 係数 (%)	二輪車 (台)
6:00-6:15	29	2	31	6.5	2.6	4	0	0	0	0.0	0.0	0
6:15-6:30	19	0	19	0.0	1.6	0	0	0	0	0.0	0.0	0
6:30-6:45	21	1	22	4.5	1.9	1	0	0	0	0.0	0.0	0
6:45-7:00	26	2	28	7.1	2.4	1	0	0	0	0.0	0.0	0
1時間計	95	5	100	5.0	8.4	6	0	0	0	0.0	0.0	0
7:00-7:15	17	1	18	5.6	1.5	1	0	0	0	0.0	0.0	0
7:15-7:30	25	0	25	0.0	2.1	1	0	0	0	0.0	0.0	0
7:30-7:45	21	1	22	4.5	1.9	3	0	0	0	0.0	0.0	0
7:45-8:00	12	1	13	7.7	1.1	1	0	0	0	0.0	0.0	0
1時間計	75	3	78	3.8	6.6	6	0	0	0	0.0	0.0	0
8:00-8:15	20	0	20	0.0	1.7	0	0	0	0	0.0	0.0	0
8:15-8:30	27	2	29	6.9	2.4	6	0	0	0	0.0	0.0	0
8:30-8:45	26	1	27	3.7	2.3	2	0	0	0	0.0	0.0	0
8:45-9:00	19	1	20	5.0	1.7	0	0	0	0	0.0	0.0	0
1時間計	92	4	96	4.2	8.1	8	0	0	0	0.0	0.0	0
9:00-9:15	13	3	16	18.8	1.3	0	0	0	0	0.0	0.0	0
9:15-9:30	22	0	22	0.0	1.9	1	0	0	0	0.0	0.0	0
9:30-9:45	15	2	17	11.8	1.4	3	0	0	0	0.0	0.0	0
9:45-10:00	16	1	17	5.9	1.4	1	0	0	0	0.0	0.0	0
1時間計	66	6	72	8.3	6.1	5	0	0	0	0.0	0.0	0
10:00-10:15	13	1	14	7.1	1.2	1	0	0	0	0.0	0.0	0
10:15-10:30	21	3	24	12.5	2.0	1	0	0	0	0.0	0.0	0
10:30-10:45	11	4	15	26.7	1.3	0	0	0	0	0.0	0.0	0
10:45-11:00	22	3	25	12.0	2.1	2	0	0	0	0.0	0.0	0
1時間計	67	11	78	14.1	6.6	4	0	0	0	0.0	0.0	0
11:00-11:15	13	5	18	27.8	1.5	0	0	0	0	0.0	0.0	0
11:15-11:30	20	1	21	4.8	1.8	0	0	0	0	0.0	0.0	0
11:30-11:45	19	3	22	13.6	1.9	1	0	0	0	0.0	0.0	0
11:45-12:00	10	0	10	0.0	0.8	0	0	0	0	0.0	0.0	0
1時間計	62	9	71	12.7	6.0	1	0	0	0	0.0	0.0	0
12:00-12:15	21	0	21	0.0	1.8	0	0	0	0	0.0	0.0	0
12:15-12:30	16	0	16	0.0	1.3	0	1	0	1	0.0	50.0	0
12:30-12:45	20	2	22	9.1	1.9	0	1	0	1	0.0	50.0	0
12:45-13:00	13	2	15	13.3	1.3	1	0	0	0	0.0	0.0	0
1時間計	70	4	74	5.4	6.2	1	2	0	2	0.0	100.0	0
13:00-13:15	9	0	9	0.0	0.8	0	0	0	0	0.0	0.0	0
13:15-13:30	15	4	19	21.1	1.6	0	0	0	0	0.0	0.0	0
13:30-13:45	12	4	16	25.0	1.3	0	0	0	0	0.0	0.0	0
13:45-14:00	8	0	8	0.0	0.7	0	0	0	0	0.0	0.0	0
1時間計	44	8	52	15.4	4.4	0	0	0	0	0.0	0.0	0

方向別自動車交通量調査表

調査地点：地域社会2 目黒交番前

調査年月日：令和元年10月13日(日) 天候：曇りのち雨

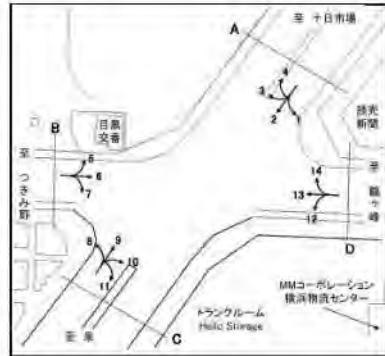

方向 種別 時間帯	10						11					
	小型車 (台)	大型車 (台)	合計 (台)	大型車 混入率 (%)	時間 係数 (%)	二輪車 (台)	小型車 (台)	大型車 (台)	合計 (台)	大型車 混入率 (%)	時間 係数 (%)	二輪車 (台)
14:00-14:15	12	1	13	7.7	1.1	0	0	0	0	0.0	0.0	0
14:15-14:30	4	0	4	0.0	0.3	1	0	0	0	0.0	0.0	0
14:30-14:45	14	1	15	6.7	1.3	1	0	0	0	0.0	0.0	0
14:45-15:00	14	1	15	6.7	1.3	0	0	0	0	0.0	0.0	0
1時間計	44	3	47	6.4	4.0	2	0	0	0	0.0	0.0	0
15:00-15:15	15	4	19	21.1	1.6	0	0	0	0	0.0	0.0	0
15:15-15:30	16	0	16	0.0	1.3	0	0	0	0	0.0	0.0	0
15:30-15:45	14	0	14	0.0	1.2	0	0	0	0	0.0	0.0	0
15:45-16:00	18	0	18	0.0	1.5	0	0	0	0	0.0	0.0	0
1時間計	63	4	67	6.0	5.6	0	0	0	0	0.0	0.0	0
16:00-16:15	19	4	23	17.4	1.9	0	0	0	0	0.0	0.0	0
16:15-16:30	20	2	22	9.1	1.9	0	0	0	0	0.0	0.0	0
16:30-16:45	13	0	13	0.0	1.1	0	0	0	0	0.0	0.0	0
16:45-17:00	7	5	12	41.7	1.0	0	0	0	0	0.0	0.0	0
1時間計	59	11	70	15.7	5.9	0	0	0	0	0.0	0.0	0
17:00-17:15	21	5	26	19.2	2.2	0	0	0	0	0.0	0.0	0
17:15-17:30	6	0	6	0.0	0.5	0	0	0	0	0.0	0.0	0
17:30-17:45	11	1	12	8.3	1.0	0	0	0	0	0.0	0.0	0
17:45-18:00	12	0	12	0.0	1.0	0	0	0	0	0.0	0.0	0
1時間計	50	6	56	10.7	4.7	0	0	0	0	0.0	0.0	0
18:00-18:15	22	0	22	0.0	1.9	0	0	0	0	0.0	0.0	0
18:15-18:30	9	0	9	0.0	0.8	0	0	0	0	0.0	0.0	0
18:30-18:45	14	3	17	17.6	1.4	1	0	0	0	0.0	0.0	0
18:45-19:00	9	0	9	0.0	0.8	0	0	0	0	0.0	0.0	0
1時間計	54	3	57	5.3	4.8	1	0	0	0	0.0	0.0	0
19:00-19:15	6	0	6	0.0	0.5	0	0	0	0	0.0	0.0	0
19:15-19:30	14	0	14	0.0	1.2	0	0	0	0	0.0	0.0	0
19:30-19:45	11	2	13	15.4	1.1	2	0	0	0	0.0	0.0	0
19:45-20:00	10	1	11	9.1	0.9	0	0	0	0	0.0	0.0	0
1時間計	41	3	44	6.8	3.7	2	0	0	0	0.0	0.0	0
20:00-20:15	10	0	10	0.0	0.8	2	0	0	0	0.0	0.0	0
20:15-20:30	9	1	10	10.0	0.8	1	0	0	0	0.0	0.0	0
20:30-20:45	7	1	8	12.5	0.7	0	0	0	0	0.0	0.0	0
20:45-21:00	3	0	3	0.0	0.3	0	0	0	0	0.0	0.0	0
1時間計	29	2	31	6.5	2.6	3	0	0	0	0.0	0.0	0
21:00-21:15	2	0	2	0.0	0.2	0	0	0	0	0.0	0.0	0
21:15-21:30	6	1	7	14.3	0.6	0	0	0	0	0.0	0.0	0
21:30-21:45	4	0	4	0.0	0.3	0	0	0	0	0.0	0.0	0
21:45-22:00	9	0	9	0.0	0.8	0	0	0	0	0.0	0.0	0
1時間計	21	1	22	4.5	1.9	0	0	0	0	0.0	0.0	0
昼12時間計	746	72	818	8.8	68.8	28	2	0	2	0.0	100.0	0
夜12時間計	336	35	371	9.4	31.2	28	0	0	0	0.0	0.0	0
全時間合計	1082	107	1189	9.0	100.0	56	2	0	2	0.0	100.0	0
昼夜率	1.45	1.49	1.45	-	-	2.00	1.00	0.00	1.00	-	-	0.00

方向別自動車交通量調査表

調査地点：地域社会2 目黒交番前

調査年月日：令和元年10月13日(日) 天候：曇りのち雨

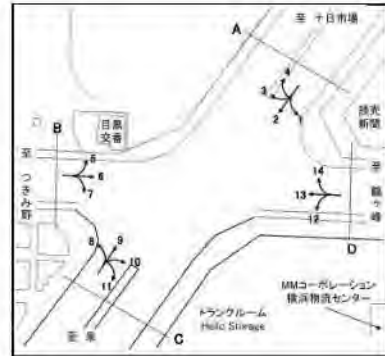

方向							C 合計 (8+ 9+10+11)					
	種別	小型車 (台)	大型車 (台)	合計 (台)	大型車 混入率 (%)	時係 数 (%)	二輪車 (台)	小型車 (台)	大型車 (台)	合計 (台)	大型車 混入率 (%)	時係 数 (%)
22:00-22:15							26	0	26	0.0	0.4	1
22:15-22:30							28	1	29	3.4	0.5	3
22:30-22:45							30	4	34	11.8	0.6	1
22:45-23:00							33	9	42	21.4	0.7	3
1 時間計							117	14	131	10.7	2.2	8
23:00-23:15							25	7	32	21.9	0.5	4
23:15-23:30							9	4	13	30.8	0.2	1
23:30-23:45							28	2	30	6.7	0.5	2
23:45-24:00							13	2	15	13.3	0.3	1
1 時間計							75	15	90	16.7	1.5	8
0:00- 0:15							15	1	16	6.3	0.3	3
0:15- 0:30							9	0	9	0.0	0.2	1
0:30- 0:45							11	2	13	15.4	0.2	2
0:45- 1:00							11	0	11	0.0	0.2	1
1 時間計							46	3	49	6.1	0.8	7
1:00- 1:15							14	1	15	6.7	0.3	2
1:15- 1:30							9	0	9	0.0	0.2	1
1:30- 1:45							12	1	13	7.7	0.2	0
1:45- 2:00							10	4	14	28.6	0.2	2
1 時間計							45	6	51	11.8	0.9	5
2:00- 2:15							7	3	10	30.0	0.2	0
2:15- 2:30							5	4	9	44.4	0.2	2
2:30- 2:45							9	2	11	18.2	0.2	1
2:45- 3:00							5	5	10	50.0	0.2	0
1 時間計							26	14	40	35.0	0.7	3
3:00- 3:15							5	0	5	0.0	0.1	0
3:15- 3:30							9	3	12	25.0	0.2	0
3:30- 3:45							6	4	10	40.0	0.2	0
3:45- 4:00							7	0	7	0.0	0.1	2
1 時間計							27	7	34	20.6	0.6	2
4:00- 4:15							11	6	17	35.3	0.3	1
4:15- 4:30							13	6	19	31.6	0.3	1
4:30- 4:45							12	2	14	14.3	0.2	1
4:45- 5:00							15	7	22	31.8	0.4	1
1 時間計							51	21	72	29.2	1.2	4
5:00- 5:15							18	9	27	33.3	0.5	2
5:15- 5:30							27	7	34	20.6	0.6	1
5:30- 5:45							37	6	43	14.0	0.7	4
5:45- 6:00							48	8	56	14.3	1.0	2
1 時間計							130	30	160	18.8	2.7	9

方向別自動車交通量調査表

調査地点：地域社会2 目黒交番前

調査年月日：令和元年10月13日(日) 天候：曇りのち雨

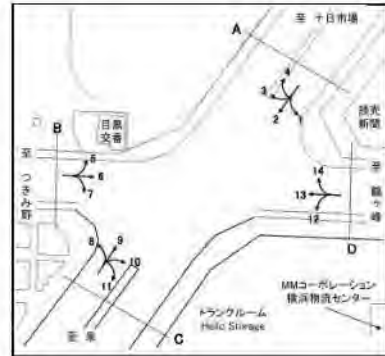

方向	種別	C 合計 (8+ 9+10+11)					C 合計 (8+ 9+10+11)					
		小型車 (台)	大型車 (台)	合計 (台)	大型車 混入率 (%)	時 間 係 数 (%)	二輪車 (台)	小型車 (台)	大型車 (台)	合計 (台)	大型車 混入率 (%)	時 間 係 数 (%)
6:00-6:15							66	6	72	8.3	1.2	7
6:15-6:30							72	7	79	8.9	1.4	5
6:30-6:45							86	15	101	14.9	1.7	10
6:45-7:00							85	6	91	6.6	1.6	5
1時間計							309	34	343	9.9	5.9	27
7:00-7:15							77	11	88	12.5	1.5	5
7:15-7:30							96	8	104	7.7	1.8	5
7:30-7:45							78	8	86	9.3	1.5	10
7:45-8:00							55	10	65	15.4	1.1	8
1時間計							306	37	343	10.8	5.9	28
8:00-8:15							111	7	118	5.9	2.0	8
8:15-8:30							101	7	108	6.5	1.9	14
8:30-8:45							116	13	129	10.1	2.2	5
8:45-9:00							83	7	90	7.8	1.5	2
1時間計							411	34	445	7.6	7.6	29
9:00-9:15							71	11	82	13.4	1.4	4
9:15-9:30							93	8	101	7.9	1.7	4
9:30-9:45							78	10	88	11.4	1.5	3
9:45-10:00							75	6	81	7.4	1.4	2
1時間計							317	35	352	9.9	6.0	13
10:00-10:15							65	8	73	11.0	1.3	2
10:15-10:30							79	6	85	7.1	1.5	2
10:30-10:45							67	12	79	15.2	1.4	0
10:45-11:00							103	12	115	10.4	2.0	3
1時間計							314	38	352	10.8	6.0	7
11:00-11:15							82	10	92	10.9	1.6	1
11:15-11:30							93	10	103	9.7	1.8	2
11:30-11:45							90	20	110	18.2	1.9	2
11:45-12:00							69	8	77	10.4	1.3	1
1時間計							334	48	382	12.6	6.5	6
12:00-12:15							62	5	67	7.5	1.1	2
12:15-12:30							82	3	85	3.5	1.5	1
12:30-12:45							85	6	91	6.6	1.6	2
12:45-13:00							80	6	86	7.0	1.5	2
1時間計							309	20	329	6.1	5.6	7
13:00-13:15							73	4	77	5.2	1.3	2
13:15-13:30							75	7	82	8.5	1.4	5
13:30-13:45							75	7	82	8.5	1.4	2
13:45-14:00							58	2	60	3.3	1.0	0
1時間計							281	20	301	6.6	5.2	9

方向別自動車交通量調査表

調査地点：地域社会2 目黒交番前

調査年月日：令和元年10月13日(日) 天候：曇りのち雨



方向 種別 時間帯							C 合計 (8+ 9+10+11)					
	小型車 (台)	大型車 (台)	合計 (台)	大型車 混入率 (%)	時間 係数 (%)	二輪車 (台)	小型車 (台)	大型車 (台)	合計 (台)	大型車 混入率 (%)	時間 係数 (%)	二輪車 (台)
14:00-14:15							60	5	65	7.7	1.1	1
14:15-14:30							48	2	50	4.0	0.9	6
14:30-14:45							92	6	98	6.1	1.7	4
14:45-15:00							78	5	83	6.0	1.4	1
1時間計							278	18	296	6.1	5.1	12
15:00-15:15							93	10	103	9.7	1.8	0
15:15-15:30							76	4	80	5.0	1.4	4
15:30-15:45							63	6	69	8.7	1.2	2
15:45-16:00							78	1	79	1.3	1.4	1
1時間計							310	21	331	6.3	5.7	7
16:00-16:15							95	8	103	7.8	1.8	2
16:15-16:30							91	8	99	8.1	1.7	1
16:30-16:45							84	7	91	7.7	1.6	1
16:45-17:00							73	12	85	14.1	1.5	1
1時間計							343	35	378	9.3	6.5	5
17:00-17:15							126	13	139	9.4	2.4	1
17:15-17:30							111	3	114	2.6	2.0	1
17:30-17:45							92	3	95	3.2	1.6	0
17:45-18:00							116	1	117	0.9	2.0	0
1時間計							445	20	465	4.3	8.0	2
18:00-18:15							115	4	119	3.4	2.0	5
18:15-18:30							68	3	71	4.2	1.2	2
18:30-18:45							85	7	92	7.6	1.6	2
18:45-19:00							48	3	51	5.9	0.9	1
1時間計							316	17	333	5.1	5.7	10
19:00-19:15							70	1	71	1.4	1.2	2
19:15-19:30							59	0	59	0.0	1.0	1
19:30-19:45							64	4	68	5.9	1.2	3
19:45-20:00							47	2	49	4.1	0.8	1
1時間計							240	7	247	2.8	4.2	7
20:00-20:15							50	5	55	9.1	0.9	4
20:15-20:30							42	2	44	4.5	0.8	2
20:30-20:45							43	1	44	2.3	0.8	2
20:45-21:00							33	2	35	5.7	0.6	1
1時間計							168	10	178	5.6	3.1	9
昼12時間計							3964	343	4307	8.0	73.8	135
夜12時間計							1356	171	1527	11.2	26.2	95
全時間合計							5320	514	5834	8.8	100.0	230
昼夜率							1.34	1.50	1.35	-	-	1.70

方向別自動車交通量調査表

調査地点：地域社会2 目黒交番前

調査年月日：令和元年10月13日(日) 天候：曇りのち雨

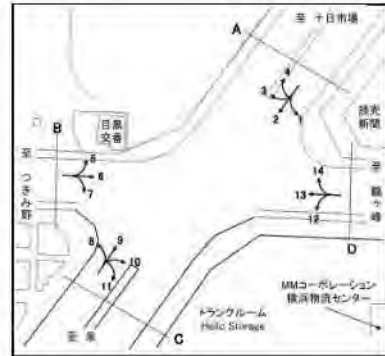

方向 種別 時間帯	12						13					
	小型車 (台)	大型車 (台)	合計 (台)	大型車 混入率 (%)	時間 係数 (%)	二輪車 (台)	小型車 (台)	大型車 (台)	合計 (台)	大型車 混入率 (%)	時間 係数 (%)	二輪車 (台)
22:00-22:15	7	3	10	30.0	1.0	1	48	6	54	11.1	0.6	5
22:15-22:30	15	2	17	11.8	1.7	1	58	5	63	7.9	0.7	0
22:30-22:45	13	0	13	0.0	1.3	0	44	12	56	21.4	0.6	1
22:45-23:00	10	0	10	0.0	1.0	3	38	9	47	19.1	0.5	2
1時間計	45	5	50	10.0	4.9	5	188	32	220	14.5	2.3	8
23:00-23:15	4	4	8	50.0	0.8	0	47	11	58	19.0	0.6	3
23:15-23:30	5	1	6	16.7	0.6	0	45	14	59	23.7	0.6	4
23:30-23:45	3	1	4	25.0	0.4	0	31	13	44	29.5	0.5	1
23:45-24:00	3	0	3	0.0	0.3	2	24	8	32	25.0	0.3	1
1時間計	15	6	21	28.6	2.1	2	147	46	193	23.8	2.0	9
0:00-0:15	4	0	4	0.0	0.4	2	32	9	41	22.0	0.4	3
0:15-0:30	2	1	3	33.3	0.3	0	23	11	34	32.4	0.4	1
0:30-0:45	5	1	6	16.7	0.6	1	25	20	45	44.4	0.5	1
0:45-1:00	1	0	1	0.0	0.1	0	23	20	43	46.5	0.5	3
1時間計	12	2	14	14.3	1.4	3	103	60	163	36.8	1.7	8
1:00-1:15	4	0	4	0.0	0.4	0	18	14	32	43.8	0.3	2
1:15-1:30	3	0	3	0.0	0.3	2	12	9	21	42.9	0.2	13
1:30-1:45	6	2	8	25.0	0.8	3	24	17	41	41.5	0.4	2
1:45-2:00	1	1	2	50.0	0.2	1	14	8	22	36.4	0.2	1
1時間計	14	3	17	17.6	1.7	6	68	48	116	41.4	1.2	18
2:00-2:15	3	0	3	0.0	0.3	1	21	14	35	40.0	0.4	0
2:15-2:30	3	0	3	0.0	0.3	0	14	14	28	50.0	0.3	1
2:30-2:45	1	0	1	0.0	0.1	0	12	17	29	58.6	0.3	0
2:45-3:00	3	1	4	25.0	0.4	0	11	8	19	42.1	0.2	4
1時間計	10	1	11	9.1	1.1	1	58	53	111	47.7	1.2	5
3:00-3:15	2	0	2	0.0	0.2	1	11	12	23	52.2	0.2	1
3:15-3:30	5	0	5	0.0	0.5	0	8	17	25	68.0	0.3	0
3:30-3:45	4	0	4	0.0	0.4	0	19	19	38	50.0	0.4	1
3:45-4:00	3	2	5	40.0	0.5	0	13	14	27	51.9	0.3	1
1時間計	14	2	16	12.5	1.6	1	51	62	113	54.9	1.2	3
4:00-4:15	2	1	3	33.3	0.3	0	22	18	40	45.0	0.4	0
4:15-4:30	4	0	4	0.0	0.4	0	7	19	26	73.1	0.3	2
4:30-4:45	2	1	3	33.3	0.3	1	20	21	41	51.2	0.4	1
4:45-5:00	3	0	3	0.0	0.3	0	18	20	38	52.6	0.4	2
1時間計	11	2	13	15.4	1.3	1	67	78	145	53.8	1.5	5
5:00-5:15	3	0	3	0.0	0.3	1	29	18	47	38.3	0.5	0
5:15-5:30	3	1	4	25.0	0.4	0	28	16	44	36.4	0.5	3
5:30-5:45	2	1	3	33.3	0.3	0	26	16	42	38.1	0.4	5
5:45-6:00	7	1	8	12.5	0.8	0	61	23	84	27.4	0.9	1
1時間計	15	3	18	16.7	1.8	1	144	73	217	33.6	2.3	9

方向別自動車交通量調査表

調査地点：地域社会2 目黒交番前

調査年月日：令和元年10月13日(日) 天候：曇りのち雨



方向 時間帯	12						13					
	小型車 (台)	大型車 (台)	合計 (台)	大型車 混入率 (%)	時間 係数 (%)	二輪車 (台)	小型車 (台)	大型車 (台)	合計 (台)	大型車 混入率 (%)	時間 係数 (%)	二輪車 (台)
6:00-6:15	6	0	6	0.0	0.6	0	90	12	102	11.8	1.1	2
6:15-6:30	4	4	8	50.0	0.8	0	73	17	90	18.9	1.0	1
6:30-6:45	7	6	13	46.2	1.3	0	157	43	200	21.5	2.1	5
6:45-7:00	6	1	7	14.3	0.7	0	93	17	110	15.5	1.2	14
1時間計	23	11	34	32.4	3.4	0	413	89	502	17.7	5.3	22
7:00-7:15	8	2	10	20.0	1.0	1	83	13	96	13.5	1.0	1
7:15-7:30	15	0	15	0.0	1.5	0	98	30	128	23.4	1.4	6
7:30-7:45	14	2	16	12.5	1.6	1	102	36	138	26.1	1.5	15
7:45-8:00	17	2	19	10.5	1.9	0	99	35	134	26.1	1.4	4
1時間計	54	6	60	10.0	5.9	2	382	114	496	23.0	5.2	26
8:00-8:15	6	3	9	33.3	0.9	1	110	34	144	23.6	1.5	5
8:15-8:30	17	1	18	5.6	1.8	1	122	29	151	19.2	1.6	5
8:30-8:45	5	1	6	16.7	0.6	1	80	29	109	26.6	1.2	7
8:45-9:00	12	2	14	14.3	1.4	0	134	33	167	19.8	1.8	4
1時間計	40	7	47	14.9	4.6	3	446	125	571	21.9	6.0	21
9:00-9:15	14	2	16	12.5	1.6	2	90	22	112	19.6	1.2	5
9:15-9:30	17	2	19	10.5	1.9	0	106	41	147	27.9	1.6	6
9:30-9:45	17	0	17	0.0	1.7	2	108	26	134	19.4	1.4	3
9:45-10:00	12	0	12	0.0	1.2	1	97	24	121	19.8	1.3	1
1時間計	60	4	64	6.3	6.3	5	401	113	514	22.0	5.4	15
10:00-10:15	17	2	19	10.5	1.9	0	127	33	160	20.6	1.7	4
10:15-10:30	8	0	8	0.0	0.8	0	102	28	130	21.5	1.4	2
10:30-10:45	14	3	17	17.6	1.7	1	105	43	148	29.1	1.6	5
10:45-11:00	14	0	14	0.0	1.4	0	108	18	126	14.3	1.3	1
1時間計	53	5	58	8.6	5.7	1	442	122	564	21.6	6.0	12
11:00-11:15	15	2	17	11.8	1.7	1	112	24	136	17.6	1.4	2
11:15-11:30	17	2	19	10.5	1.9	0	108	29	137	21.2	1.4	0
11:30-11:45	10	1	11	9.1	1.1	0	98	32	130	24.6	1.4	5
11:45-12:00	11	3	14	21.4	1.4	1	107	28	135	20.7	1.4	3
1時間計	53	8	61	13.1	6.0	2	425	113	538	21.0	5.7	10
12:00-12:15	19	2	21	9.5	2.1	3	91	25	116	21.6	1.2	1
12:15-12:30	14	2	16	12.5	1.6	0	110	24	134	17.9	1.4	3
12:30-12:45	19	2	21	9.5	2.1	2	95	29	124	23.4	1.3	1
12:45-13:00	29	1	30	3.3	3.0	0	97	24	121	19.8	1.3	2
1時間計	81	7	88	8.0	8.7	5	393	102	495	20.6	5.2	7
13:00-13:15	9	0	9	0.0	0.9	0	96	34	130	26.2	1.4	0
13:15-13:30	12	1	13	7.7	1.3	2	121	30	151	19.9	1.6	0
13:30-13:45	15	5	20	25.0	2.0	1	125	26	151	17.2	1.6	0
13:45-14:00	16	0	16	0.0	1.6	0	83	17	100	17.0	1.1	2
1時間計	52	6	58	10.3	5.7	3	425	107	532	20.1	5.6	2

方向別自動車交通量調査表

調査地点：地域社会2 目黒交番前

調査年月日：令和元年10月13日(日) 天候：曇りのち雨

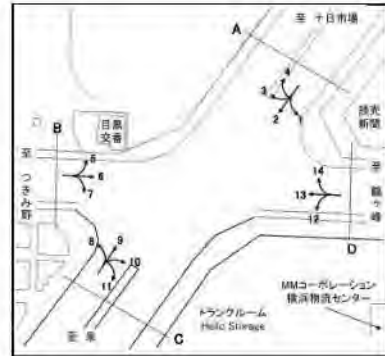

方向 種別 時間帯	12						13					
	小型車 (台)	大型車 (台)	合計 (台)	大型車 混入率 (%)	時間 係数 (%)	二輪車 (台)	小型車 (台)	大型車 (台)	合計 (台)	大型車 混入率 (%)	時間 係数 (%)	二輪車 (台)
14:00-14:15	11	1	12	8.3	1.2	2	107	30	137	21.9	1.4	2
14:15-14:30	4	0	4	0.0	0.4	0	101	33	134	24.6	1.4	2
14:30-14:45	14	3	17	17.6	1.7	0	114	30	144	20.8	1.5	0
14:45-15:00	23	5	28	17.9	2.8	0	87	29	116	25.0	1.2	1
1時間計	52	9	61	14.8	6.0	2	409	122	531	23.0	5.6	5
15:00-15:15	16	0	16	0.0	1.6	1	90	22	112	19.6	1.2	4
15:15-15:30	12	1	13	7.7	1.3	0	115	31	146	21.2	1.5	2
15:30-15:45	13	1	14	7.1	1.4	0	98	30	128	23.4	1.4	1
15:45-16:00	9	2	11	18.2	1.1	0	96	26	122	21.3	1.3	2
1時間計	50	4	54	7.4	5.3	1	399	109	508	21.5	5.4	9
16:00-16:15	16	1	17	5.9	1.7	0	117	28	145	19.3	1.5	5
16:15-16:30	13	1	14	7.1	1.4	1	111	30	141	21.3	1.5	3
16:30-16:45	11	0	11	0.0	1.1	0	139	21	160	13.1	1.7	4
16:45-17:00	15	1	16	6.3	1.6	0	119	16	135	11.9	1.4	3
1時間計	55	3	58	5.2	5.7	1	486	95	581	16.4	6.1	15
17:00-17:15	17	0	17	0.0	1.7	1	126	19	145	13.1	1.5	3
17:15-17:30	13	0	13	0.0	1.3	4	121	25	146	17.1	1.5	7
17:30-17:45	15	0	15	0.0	1.5	1	124	24	148	16.2	1.6	11
17:45-18:00	13	1	14	7.1	1.4	2	130	18	148	12.2	1.6	4
1時間計	58	1	59	1.7	5.8	8	501	86	587	14.7	6.2	25
18:00-18:15	11	1	12	8.3	1.2	0	143	12	155	7.7	1.6	9
18:15-18:30	14	0	14	0.0	1.4	2	155	22	177	12.4	1.9	5
18:30-18:45	8	0	8	0.0	0.8	2	127	16	143	11.2	1.5	2
18:45-19:00	18	0	18	0.0	1.8	3	122	11	133	8.3	1.4	4
1時間計	51	1	52	1.9	5.1	7	547	61	608	10.0	6.4	20
19:00-19:15	10	2	12	16.7	1.2	0	94	13	107	12.1	1.1	7
19:15-19:30	3	0	3	0.0	0.3	0	57	22	79	27.8	0.8	2
19:30-19:45	7	2	9	22.2	0.9	1	101	14	115	12.2	1.2	1
19:45-20:00	0	0	0	0.0	0.0	0	70	19	89	21.3	0.9	2
1時間計	20	4	24	16.7	2.4	1	322	68	390	17.4	4.1	12
20:00-20:15	7	0	7	0.0	0.7	0	88	14	102	13.7	1.1	2
20:15-20:30	4	1	5	20.0	0.5	0	94	16	110	14.5	1.2	4
20:30-20:45	8	4	12	33.3	1.2	0	123	13	136	9.6	1.4	3
20:45-21:00	6	3	9	33.3	0.9	0	109	11	120	9.2	1.3	3
1時間計	25	8	33	24.2	3.3	0	414	54	468	11.5	4.9	12
21:00-21:15	15	0	15	0.0	1.5	3	62	18	80	22.5	0.8	3
21:15-21:30	8	0	8	0.0	0.8	0	74	10	84	11.9	0.9	6
21:30-21:45	5	1	6	16.7	0.6	0	61	15	76	19.7	0.8	3
21:45-22:00	10	1	11	9.1	1.1	0	51	12	63	19.0	0.7	3
1時間計	38	2	40	5.0	4.0	3	248	55	303	18.2	3.2	15
昼12時間計	659	61	720	8.5	71.2	40	5256	1269	6525	19.4	68.9	167
夜12時間計	242	49	291	16.8	28.8	24	2223	718	2941	24.4	31.1	126
全時間合計	901	110	1011	10.9	100.0	64	7479	1987	9466	21.0	100.0	293
昼夜率	1.37	1.80	1.40	-	-	1.60	1.42	1.57	1.45	-	-	1.75

方向別自動車交通量調査表

調査地点：地域社会2 目黒交番前

調査年月日：令和元年10月13日(日) 天候：曇りのち雨

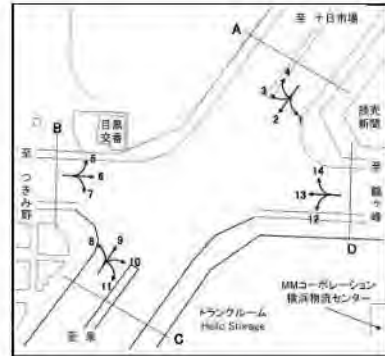

方向	14						D 合計 (12+13+14)					
	小型車 (台)	大型車 (台)	合計 (台)	大型車 混入率 (%)	時間 係数 (%)	二輪車 (台)	小型車 (台)	大型車 (台)	合計 (台)	大型車 混入率 (%)	時間 係数 (%)	二輪車 (台)
22:00-22:15	0	0	0	0.0	0.0	0	55	9	64	14.1	0.6	6
22:15-22:30	0	0	0	0.0	0.0	0	73	7	80	8.8	0.8	1
22:30-22:45	3	0	3	0.0	1.6	0	60	12	72	16.7	0.7	1
22:45-23:00	4	0	4	0.0	2.2	0	52	9	61	14.8	0.6	5
1時間計	7	0	7	0.0	3.8	0	240	37	277	13.4	2.6	13
23:00-23:15	2	3	5	60.0	2.7	0	53	18	71	25.4	0.7	3
23:15-23:30	0	2	2	100.0	1.1	0	50	17	67	25.4	0.6	4
23:30-23:45	0	0	0	0.0	0.0	0	34	14	48	29.2	0.5	1
23:45-24:00	0	0	0	0.0	0.0	0	27	8	35	22.9	0.3	3
1時間計	2	5	7	71.4	3.8	0	164	57	221	25.8	2.1	11
0:00-0:15	1	1	2	50.0	1.1	0	37	10	47	21.3	0.4	5
0:15-0:30	1	4	5	80.0	2.7	0	26	16	42	38.1	0.4	1
0:30-0:45	2	1	3	33.3	1.6	0	32	22	54	40.7	0.5	2
0:45-1:00	1	0	1	0.0	0.5	0	25	20	45	44.4	0.4	3
1時間計	5	6	11	54.5	5.9	0	120	68	188	36.2	1.8	11
1:00-1:15	1	0	1	0.0	0.5	0	23	14	37	37.8	0.3	2
1:15-1:30	0	0	0	0.0	0.0	0	15	9	24	37.5	0.2	15
1:30-1:45	0	1	1	100.0	0.5	0	30	20	50	40.0	0.5	5
1:45-2:00	1	0	1	0.0	0.5	0	16	9	25	36.0	0.2	2
1時間計	2	1	3	33.3	1.6	0	84	52	136	38.2	1.3	24
2:00-2:15	0	0	0	0.0	0.0	0	24	14	38	36.8	0.4	1
2:15-2:30	0	1	1	100.0	0.5	0	17	15	32	46.9	0.3	1
2:30-2:45	0	0	0	0.0	0.0	0	13	17	30	56.7	0.3	0
2:45-3:00	0	0	0	0.0	0.0	0	14	9	23	39.1	0.2	4
1時間計	0	1	1	100.0	0.5	0	68	55	123	44.7	1.2	6
3:00-3:15	2	0	2	0.0	1.1	0	15	12	27	44.4	0.3	2
3:15-3:30	0	0	0	0.0	0.0	0	13	17	30	56.7	0.3	0
3:30-3:45	1	1	2	50.0	1.1	0	24	20	44	45.5	0.4	1
3:45-4:00	0	0	0	0.0	0.0	0	16	16	32	50.0	0.3	1
1時間計	3	1	4	25.0	2.2	0	68	65	133	48.9	1.2	4
4:00-4:15	0	0	0	0.0	0.0	0	24	19	43	44.2	0.4	0
4:15-4:30	1	1	2	50.0	1.1	0	12	20	32	62.5	0.3	2
4:30-4:45	0	0	0	0.0	0.0	0	22	22	44	50.0	0.4	2
4:45-5:00	0	0	0	0.0	0.0	0	21	20	41	48.8	0.4	2
1時間計	1	1	2	50.0	1.1	0	79	81	160	50.6	1.5	6
5:00-5:15	0	0	0	0.0	0.0	0	32	18	50	36.0	0.5	1
5:15-5:30	0	0	0	0.0	0.0	0	31	17	48	35.4	0.5	3
5:30-5:45	0	0	0	0.0	0.0	0	28	17	45	37.8	0.4	5
5:45-6:00	1	0	1	0.0	0.5	0	69	24	93	25.8	0.9	1
1時間計	1	0	1	0.0	0.5	0	160	76	236	32.2	2.2	10

方向別自動車交通量調査表

調査地点：地域社会2 目黒交番前

調査年月日：令和元年10月13日(日) 天候：曇りのち雨

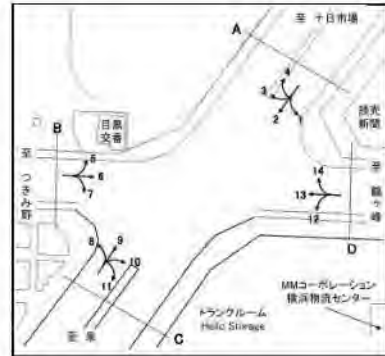

時間帯	方向	14						D 合計 (12+13+14)						
		種別	小型車 (台)	大型車 (台)	合計 (台)	大型車 混入率 (%)	時間 係数 (%)	二輪車 (台)	種別	小型車 (台)	大型車 (台)	合計 (台)	大型車 混入率 (%)	時間 係数 (%)
6:00-6:15			0	1	1	100.0	0.5	0	96	13	109	11.9	1.0	2
6:15-6:30			2	0	2	0.0	1.1	0	79	21	100	21.0	0.9	1
6:30-6:45			3	0	3	0.0	1.6	0	167	49	216	22.7	2.0	5
6:45-7:00			1	2	3	66.7	1.6	0	100	20	120	16.7	1.1	14
1時間計			6	3	9	33.3	4.9	0	442	103	545	18.9	5.1	22
7:00-7:15			1	0	1	0.0	0.5	0	92	15	107	14.0	1.0	2
7:15-7:30			2	0	2	0.0	1.1	0	115	30	145	20.7	1.4	6
7:30-7:45			2	0	2	0.0	1.1	0	118	38	156	24.4	1.5	16
7:45-8:00			2	0	2	0.0	1.1	0	118	37	155	23.9	1.5	4
1時間計			7	0	7	0.0	3.8	0	443	120	563	21.3	5.3	28
8:00-8:15			3	1	4	25.0	2.2	0	119	38	157	24.2	1.5	6
8:15-8:30			1	1	2	50.0	1.1	0	140	31	171	18.1	1.6	6
8:30-8:45			2	0	2	0.0	1.1	0	87	30	117	25.6	1.1	8
8:45-9:00			3	3	6	50.0	3.2	0	149	38	187	20.3	1.8	4
1時間計			9	5	14	35.7	7.6	0	495	137	632	21.7	5.9	24
9:00-9:15			0	1	1	100.0	0.5	1	104	25	129	19.4	1.2	8
9:15-9:30			2	0	2	0.0	1.1	0	125	43	168	25.6	1.6	6
9:30-9:45			2	0	2	0.0	1.1	0	127	26	153	17.0	1.4	5
9:45-10:00			5	1	6	16.7	3.2	0	114	25	139	18.0	1.3	2
1時間計			9	2	11	18.2	5.9	1	470	119	589	20.2	5.5	21
10:00-10:15			2	1	3	33.3	1.6	0	146	36	182	19.8	1.7	4
10:15-10:30			3	0	3	0.0	1.6	0	113	28	141	19.9	1.3	2
10:30-10:45			0	1	1	100.0	0.5	0	119	47	166	28.3	1.6	6
10:45-11:00			0	0	0	0.0	0.0	0	122	18	140	12.9	1.3	1
1時間計			5	2	7	28.6	3.8	0	500	129	629	20.5	5.9	13
11:00-11:15			2	1	3	33.3	1.6	0	129	27	156	17.3	1.5	3
11:15-11:30			1	0	1	0.0	0.5	0	126	31	157	19.7	1.5	0
11:30-11:45			1	0	1	0.0	0.5	0	109	33	142	23.2	1.3	5
11:45-12:00			4	0	4	0.0	2.2	0	122	31	153	20.3	1.4	4
1時間計			8	1	9	11.1	4.9	0	486	122	608	20.1	5.7	12
12:00-12:15			4	1	5	20.0	2.7	0	114	28	142	19.7	1.3	4
12:15-12:30			0	1	1	100.0	0.5	0	124	27	151	17.9	1.4	3
12:30-12:45			1	0	1	0.0	0.5	0	115	31	146	21.2	1.4	3
12:45-13:00			0	1	1	100.0	0.5	0	126	26	152	17.1	1.4	2
1時間計			5	3	8	37.5	4.3	0	479	112	591	19.0	5.5	12
13:00-13:15			0	0	0	0.0	0.0	0	105	34	139	24.5	1.3	0
13:15-13:30			0	0	0	0.0	0.0	0	133	31	164	18.9	1.5	2
13:30-13:45			1	0	1	0.0	0.5	0	141	31	172	18.0	1.6	1
13:45-14:00			3	0	3	0.0	1.6	1	102	17	119	14.3	1.1	3
1時間計			4	0	4	0.0	2.2	1	481	113	594	19.0	5.6	6

方向別自動車交通量調査表

調査地点：地域社会2 目黒交番前

調査年月日：令和元年10月13日(日) 天候：曇りのち雨

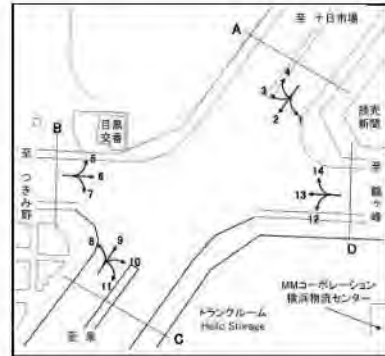

方向	14						D 合計 (12+13+14)					
	小型車 (台)	大型車 (台)	合計 (台)	大型車 混入率 (%)	時間 係数 (%)	二輪車 (台)	小型車 (台)	大型車 (台)	合計 (台)	大型車 混入率 (%)	時間 係数 (%)	二輪車 (台)
14:00-14:15	5	0	5	0.0	2.7	0	123	31	154	20.1	1.4	4
14:15-14:30	8	3	11	27.3	5.9	0	113	36	149	24.2	1.4	2
14:30-14:45	2	0	2	0.0	1.1	0	130	33	163	20.2	1.5	0
14:45-15:00	4	0	4	0.0	2.2	0	114	34	148	23.0	1.4	1
1時間計	19	3	22	13.6	11.9	0	480	134	614	21.8	5.8	7
15:00-15:15	0	0	0	0.0	0.0	0	106	22	128	17.2	1.2	5
15:15-15:30	4	1	5	20.0	2.7	0	131	33	164	20.1	1.5	2
15:30-15:45	1	0	1	0.0	0.5	0	112	31	143	21.7	1.3	1
15:45-16:00	1	0	1	0.0	0.5	0	106	28	134	20.9	1.3	2
1時間計	6	1	7	14.3	3.8	0	455	114	569	20.0	5.3	10
16:00-16:15	1	0	1	0.0	0.5	0	134	29	163	17.8	1.5	5
16:15-16:30	1	0	1	0.0	0.5	0	125	31	156	19.9	1.5	4
16:30-16:45	0	0	0	0.0	0.0	0	150	21	171	12.3	1.6	4
16:45-17:00	0	0	0	0.0	0.0	0	134	17	151	11.3	1.4	3
1時間計	2	0	2	0.0	1.1	0	543	98	641	15.3	6.0	16
17:00-17:15	2	0	2	0.0	1.1	0	145	19	164	11.6	1.5	4
17:15-17:30	3	0	3	0.0	1.6	1	137	25	162	15.4	1.5	12
17:30-17:45	0	0	0	0.0	0.0	0	139	24	163	14.7	1.5	12
17:45-18:00	1	0	1	0.0	0.5	0	144	19	163	11.7	1.5	6
1時間計	6	0	6	0.0	3.2	1	565	87	652	13.3	6.1	34
18:00-18:15	0	2	2	100.0	1.1	0	154	15	169	8.9	1.6	9
18:15-18:30	4	0	4	0.0	2.2	0	173	22	195	11.3	1.8	7
18:30-18:45	3	0	3	0.0	1.6	0	138	16	154	10.4	1.4	4
18:45-19:00	3	0	3	0.0	1.6	0	143	11	154	7.1	1.4	7
1時間計	10	2	12	16.7	6.5	0	608	64	672	9.5	6.3	27
19:00-19:15	3	0	3	0.0	1.6	0	107	15	122	12.3	1.1	7
19:15-19:30	0	0	0	0.0	0.0	0	60	22	82	26.8	0.8	2
19:30-19:45	0	0	0	0.0	0.0	0	108	16	124	12.9	1.2	2
19:45-20:00	8	4	12	33.3	6.5	2	78	23	101	22.8	0.9	4
1時間計	11	4	15	26.7	8.1	2	353	76	429	17.7	4.0	15
20:00-20:15	5	0	5	0.0	2.7	0	100	14	114	12.3	1.1	2
20:15-20:30	0	0	0	0.0	0.0	0	98	17	115	14.8	1.1	4
20:30-20:45	4	0	4	0.0	2.2	0	135	17	152	11.2	1.4	3
20:45-21:00	1	0	1	0.0	0.5	0	116	14	130	10.8	1.2	3
1時間計	10	0	10	0.0	5.4	0	449	62	511	12.1	4.8	12
21:00-21:15	3	0	3	0.0	1.6	0	80	18	98	18.4	0.9	6
21:15-21:30	2	0	2	0.0	1.1	0	84	10	94	10.6	0.9	6
21:30-21:45	1	0	1	0.0	0.5	0	67	16	83	19.3	0.8	3
21:45-22:00	0	0	0	0.0	0.0	0	61	13	74	17.6	0.7	3
1時間計	6	0	6	0.0	3.2	0	292	57	349	16.3	3.3	18
昼12時間計	90	19	109	17.4	58.9	3	6005	1349	7354	18.3	69.0	210
夜12時間計	54	22	76	28.9	41.1	2	2519	789	3308	23.9	31.0	152
全時間合計	144	41	185	22.2	100.0	5	8524	2138	10662	20.1	100.0	362
昼夜率	1.60	2.16	1.70	-	-	1.67	1.42	1.58	1.45	-	-	1.72

方向別自動車交通量調査表

調査地点 : 地域社会3 上川井IC

調査年月日 : 令和元年10月13日(日) 天候:曇りのち雨

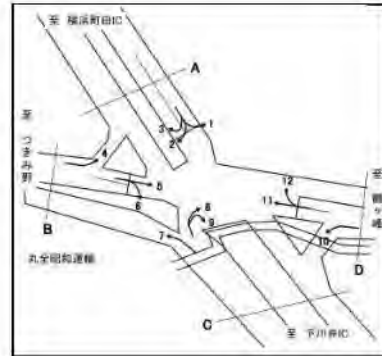

方向 種別 時間帯	1						2					
	小型車 (台)	大型車 (台)	合計 (台)	大型車 混入率 (%)	時間 係数 (%)	二輪車 (台)	小型車 (台)	大型車 (台)	合計 (台)	大型車 混入率 (%)	時間 係数 (%)	二輪車 (台)
22:00-22:15	7	0	7	0.0	0.4	0	4	0	4	0.0	1.9	0
22:15-22:30	14	0	14	0.0	0.8	4	0	0	0	0.0	0.0	0
22:30-22:45	14	0	14	0.0	0.8	2	0	0	0	0.0	0.0	0
22:45-23:00	9	0	9	0.0	0.5	2	2	0	2	0.0	1.0	0
1時間計	44	0	44	0.0	2.6	8	6	0	6	0.0	2.9	0
23:00-23:15	13	0	13	0.0	0.8	2	3	0	3	0.0	1.4	0
23:15-23:30	1	1	2	50.0	0.1	0	0	0	0	0.0	0.0	0
23:30-23:45	5	0	5	0.0	0.3	0	1	0	1	0.0	0.5	0
23:45-24:00	3	0	3	0.0	0.2	0	1	0	1	0.0	0.5	0
1時間計	22	1	23	4.3	1.4	2	5	0	5	0.0	2.4	0
0:00-0:15	6	0	6	0.0	0.4	0	1	0	1	0.0	0.5	0
0:15-0:30	3	1	4	25.0	0.2	0	0	2	2	100.0	1.0	0
0:30-0:45	6	0	6	0.0	0.4	0	0	1	1	100.0	0.5	0
0:45-1:00	5	0	5	0.0	0.3	0	1	1	2	50.0	1.0	0
1時間計	20	1	21	4.8	1.3	0	2	4	6	66.7	2.9	0
1:00-1:15	8	1	9	11.1	0.5	0	1	0	1	0.0	0.5	0
1:15-1:30	4	0	4	0.0	0.2	0	0	2	2	100.0	1.0	0
1:30-1:45	1	0	1	0.0	0.1	0	2	1	3	33.3	1.4	0
1:45-2:00	4	0	4	0.0	0.2	0	0	1	1	100.0	0.5	0
1時間計	17	1	18	5.6	1.1	0	3	4	7	57.1	3.3	0
2:00-2:15	4	0	4	0.0	0.2	0	1	0	1	0.0	0.5	0
2:15-2:30	0	0	0	0.0	0.0	1	4	0	4	0.0	1.9	0
2:30-2:45	3	2	5	40.0	0.3	0	0	2	2	100.0	1.0	0
2:45-3:00	2	1	3	33.3	0.2	0	3	0	3	0.0	1.4	0
1時間計	9	3	12	25.0	0.7	1	8	2	10	20.0	4.8	0
3:00-3:15	3	2	5	40.0	0.3	0	1	1	2	50.0	1.0	0
3:15-3:30	2	0	2	0.0	0.1	0	0	1	1	100.0	0.5	0
3:30-3:45	0	1	1	100.0	0.1	0	1	0	1	0.0	0.5	0
3:45-4:00	3	1	4	25.0	0.2	1	0	0	0	0.0	0.0	0
1時間計	8	4	12	33.3	0.7	1	2	2	4	50.0	1.9	0
4:00-4:15	2	3	5	60.0	0.3	0	0	0	0	0.0	0.0	0
4:15-4:30	2	0	2	0.0	0.1	0	0	0	0	0.0	0.0	0
4:30-4:45	4	0	4	0.0	0.2	1	0	1	1	100.0	0.5	0
4:45-5:00	4	1	5	20.0	0.3	0	0	1	1	100.0	0.5	0
1時間計	12	4	16	25.0	1.0	1	0	2	2	100.0	1.0	0
5:00-5:15	5	4	9	44.4	0.5	0	1	2	3	66.7	1.4	0
5:15-5:30	12	1	13	7.7	0.8	2	0	0	0	0.0	0.0	0
5:30-5:45	10	1	11	9.1	0.7	0	1	1	2	50.0	1.0	0
5:45-6:00	18	0	18	0.0	1.1	3	0	0	0	0.0	0.0	0
1時間計	45	6	51	11.8	3.0	5	2	3	5	60.0	2.4	0

方向別自動車交通量調査表

調査地点 : 地域社会3 上川井IC

調査年月日 : 令和元年10月13日(日) 天候:曇りのち雨

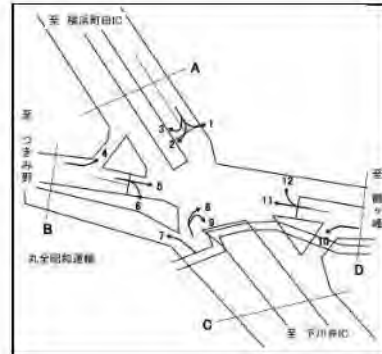

方向	1						2						
	種別	小型車 (台)	大型車 (台)	合計 (台)	大型車 混入率 (%)	時間 係数 (%)	二輪車 (台)	小型車 (台)	大型車 (台)	合計 (台)	大型車 混入率 (%)	時間 係数 (%)	二輪車 (台)
6:00-6:15		15	1	16	6.3	1.0	1	1	0	1	0.0	0.5	0
6:15-6:30		17	1	18	5.6	1.1	3	2	0	2	0.0	1.0	0
6:30-6:45		10	3	13	23.1	0.8	1	1	0	1	0.0	0.5	0
6:45-7:00		26	5	31	16.1	1.8	4	1	2	3	66.7	1.4	0
1時間計		68	10	78	12.8	4.6	9	5	2	7	28.6	3.3	0
7:00-7:15		29	1	30	3.3	1.8	2	1	0	1	0.0	0.5	0
7:15-7:30		27	6	33	18.2	2.0	4	1	1	2	50.0	1.0	0
7:30-7:45		34	0	34	0.0	2.0	5	2	0	2	0.0	1.0	0
7:45-8:00		18	3	21	14.3	1.3	3	0	2	2	100.0	1.0	2
1時間計		108	10	118	8.5	7.0	14	4	3	7	42.9	3.3	2
8:00-8:15		23	7	30	23.3	1.8	2	3	0	3	0.0	1.4	0
8:15-8:30		26	4	30	13.3	1.8	5	5	0	5	0.0	2.4	1
8:30-8:45		30	2	32	6.3	1.9	1	3	0	3	0.0	1.4	0
8:45-9:00		18	4	22	18.2	1.3	2	1	1	2	50.0	1.0	0
1時間計		97	17	114	14.9	6.8	10	12	1	13	7.7	6.2	1
9:00-9:15		14	4	18	22.2	1.1	1	1	1	2	50.0	1.0	0
9:15-9:30		17	2	19	10.5	1.1	2	2	0	2	0.0	1.0	0
9:30-9:45		16	3	19	15.8	1.1	4	2	1	3	33.3	1.4	0
9:45-10:00		21	2	23	8.7	1.4	1	3	0	3	0.0	1.4	0
1時間計		68	11	79	13.9	4.7	8	8	2	10	20.0	4.8	0
10:00-10:15		19	4	23	17.4	1.4	1	2	3	5	60.0	2.4	0
10:15-10:30		20	6	26	23.1	1.5	4	2	0	2	0.0	1.0	0
10:30-10:45		16	1	17	5.9	1.0	1	0	2	2	100.0	1.0	0
10:45-11:00		14	8	22	36.4	1.3	0	6	1	7	14.3	3.3	0
1時間計		69	19	88	21.6	5.2	6	10	6	16	37.5	7.7	0
11:00-11:15		17	5	22	22.7	1.3	2	8	0	8	0.0	3.8	0
11:15-11:30		29	1	30	3.3	1.8	0	3	1	4	25.0	1.9	0
11:30-11:45		19	7	26	26.9	1.5	1	1	1	2	50.0	1.0	0
11:45-12:00		28	3	31	9.7	1.8	0	1	0	1	0.0	0.5	0
1時間計		93	16	109	14.7	6.5	3	13	2	15	13.3	7.2	0
12:00-12:15		23	2	25	8.0	1.5	0	4	0	4	0.0	1.9	0
12:15-12:30		27	7	34	20.6	2.0	0	3	2	5	40.0	2.4	0
12:30-12:45		21	3	24	12.5	1.4	0	1	1	2	50.0	1.0	0
12:45-13:00		24	3	27	11.1	1.6	2	6	1	7	14.3	3.3	0
1時間計		95	15	110	13.6	6.6	2	14	4	18	22.2	8.6	0
13:00-13:15		22	1	23	4.3	1.4	0	4	1	5	20.0	2.4	0
13:15-13:30		18	4	22	18.2	1.3	1	4	0	4	0.0	1.9	0
13:30-13:45		23	4	27	14.8	1.6	0	2	1	3	33.3	1.4	0
13:45-14:00		21	2	23	8.7	1.4	0	2	1	3	33.3	1.4	1
1時間計		84	11	95	11.6	5.7	1	12	3	15	20.0	7.2	1

方向別自動車交通量調査表

調査地点 : 地域社会3 上川井IC

調査年月日 : 令和元年10月13日(日) 天候:曇りのち雨

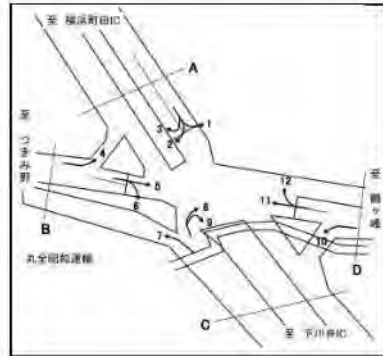

方向	1						2						
	種別	小型車 (台)	大型車 (台)	合計 (台)	大型車 混入率 (%)	時間 係数 (%)	二輪車 (台)	小型車 (台)	大型車 (台)	合計 (台)	大型車 混入率 (%)	時間 係数 (%)	二輪車 (台)
14:00-14:15		12	3	15	20.0	0.9	0	3	0	3	0.0	1.4	1
14:15-14:30		11	3	14	21.4	0.8	2	1	1	2	50.0	1.0	0
14:30-14:45		20	3	23	13.0	1.4	0	2	1	3	33.3	1.4	0
14:45-15:00		16	3	19	15.8	1.1	2	0	0	0	0.0	0.0	0
1時間計		59	12	71	16.9	4.2	4	6	2	8	25.0	3.8	1
15:00-15:15		29	1	30	3.3	1.8	1	3	1	4	25.0	1.9	0
15:15-15:30		15	5	20	25.0	1.2	2	4	0	4	0.0	1.9	0
15:30-15:45		31	2	33	6.1	2.0	2	1	2	3	66.7	1.4	0
15:45-16:00		22	3	25	12.0	1.5	4	0	0	0	0.0	0.0	0
1時間計		97	11	108	10.2	6.4	9	8	3	11	27.3	5.3	0
16:00-16:15		19	7	26	26.9	1.5	1	4	0	4	0.0	1.9	0
16:15-16:30		19	3	22	13.6	1.3	0	2	1	3	33.3	1.4	1
16:30-16:45		22	4	26	15.4	1.5	1	1	1	2	50.0	1.0	0
16:45-17:00		29	6	35	17.1	2.1	1	1	0	1	0.0	0.5	0
1時間計		89	20	109	18.3	6.5	3	8	2	10	20.0	4.8	1
17:00-17:15		25	2	27	7.4	1.6	0	0	0	0	0.0	0.0	0
17:15-17:30		23	6	29	20.7	1.7	0	3	2	5	40.0	2.4	0
17:30-17:45		27	8	35	22.9	2.1	3	1	0	1	0.0	0.5	1
17:45-18:00		28	2	30	6.7	1.8	3	0	0	0	0.0	0.0	0
1時間計		103	18	121	14.9	7.2	6	4	2	6	33.3	2.9	1
18:00-18:15		17	3	20	15.0	1.2	2	0	0	0	0.0	0.0	0
18:15-18:30		23	5	28	17.9	1.7	1	2	2	4	50.0	1.9	0
18:30-18:45		20	1	21	4.8	1.3	3	1	0	1	0.0	0.5	0
18:45-19:00		17	3	20	15.0	1.2	3	2	0	2	0.0	1.0	0
1時間計		77	12	89	13.5	5.3	9	5	2	7	28.6	3.3	0
19:00-19:15		24	3	27	11.1	1.6	3	2	1	3	33.3	1.4	0
19:15-19:30		22	2	24	8.3	1.4	2	0	0	0	0.0	0.0	0
19:30-19:45		20	2	22	9.1	1.3	3	3	0	3	0.0	1.4	0
19:45-20:00		16	1	17	5.9	1.0	1	1	1	2	50.0	1.0	0
1時間計		82	8	90	8.9	5.4	9	6	2	8	25.0	3.8	0
20:00-20:15		16	3	19	15.8	1.1	2	1	2	3	66.7	1.4	0
20:15-20:30		9	1	10	10.0	0.6	2	0	2	2	100.0	1.0	0
20:30-20:45		14	2	16	12.5	1.0	4	1	1	2	50.0	1.0	0
20:45-21:00		13	0	13	0.0	0.8	1	1	0	1	0.0	0.5	0
1時間計		52	6	58	10.3	3.5	9	3	5	8	62.5	3.8	0
21:00-21:15		14	1	15	6.7	0.9	3	1	0	1	0.0	0.5	0
21:15-21:30		8	1	9	11.1	0.5	1	2	0	2	0.0	1.0	0
21:30-21:45		9	0	9	0.0	0.5	0	1	1	2	50.0	1.0	0
21:45-22:00		11	1	12	8.3	0.7	0	0	0	0	0.0	0.0	0
1時間計		42	3	45	6.7	2.7	4	4	1	5	20.0	2.4	0
昼12時間計		1039	172	1211	14.2	72.1	75	104	32	136	23.5	65.1	7
夜12時間計		421	47	468	10.0	27.9	49	46	27	73	37.0	34.9	0
全時間合計		1460	219	1679	13.0	100.0	124	150	59	209	28.2	100.0	7
昼夜率		1.41	1.27	1.39	-	-	1.65	1.44	1.84	1.54	-	-	1.00

方向別自動車交通量調査表

調査地点 : 地域社会3 上川井IC

調査年月日 : 令和元年10月13日(日) 天候:曇りのち雨

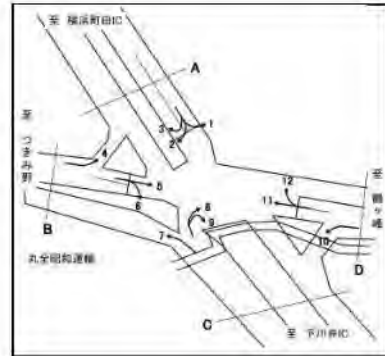

方向 種別 時間帯	3						A 合計 (1+ 2+ 3)					
	小型車 (台)	大型車 (台)	合計 (台)	大型車 混入率 (%)	時間 係数 (%)	二輪車 (台)	小型車 (台)	大型車 (台)	合計 (台)	大型車 混入率 (%)	時間 係数 (%)	二輪車 (台)
22:00-22:15	0	0	0	0.0	0.0	0	11	0	11	0.0	0.5	0
22:15-22:30	1	1	2	50.0	0.9	0	15	1	16	6.3	0.8	4
22:30-22:45	1	0	1	0.0	0.5	0	15	0	15	0.0	0.7	2
22:45-23:00	1	0	1	0.0	0.5	0	12	0	12	0.0	0.6	2
1時間計	3	1	4	25.0	1.8	0	53	1	54	1.9	2.6	8
23:00-23:15	2	0	2	0.0	0.9	0	18	0	18	0.0	0.9	2
23:15-23:30	1	1	2	50.0	0.9	0	2	2	4	50.0	0.2	0
23:30-23:45	0	0	0	0.0	0.0	0	6	0	6	0.0	0.3	0
23:45-24:00	0	0	0	0.0	0.0	0	4	0	4	0.0	0.2	0
1時間計	3	1	4	25.0	1.8	0	30	2	32	6.3	1.5	2
0:00- 0:15	1	0	1	0.0	0.5	0	8	0	8	0.0	0.4	0
0:15- 0:30	0	0	0	0.0	0.0	0	3	3	6	50.0	0.3	0
0:30- 0:45	0	0	0	0.0	0.0	0	6	1	7	14.3	0.3	0
0:45- 1:00	2	0	2	0.0	0.9	0	8	1	9	11.1	0.4	0
1時間計	3	0	3	0.0	1.4	0	25	5	30	16.7	1.4	0
1:00- 1:15	1	0	1	0.0	0.5	0	10	1	11	9.1	0.5	0
1:15- 1:30	0	1	1	100.0	0.5	0	4	3	7	42.9	0.3	0
1:30- 1:45	1	0	1	0.0	0.5	0	4	1	5	20.0	0.2	0
1:45- 2:00	2	1	3	33.3	1.4	0	6	2	8	25.0	0.4	0
1時間計	4	2	6	33.3	2.8	0	24	7	31	22.6	1.5	0
2:00- 2:15	3	0	3	0.0	1.4	0	8	0	8	0.0	0.4	0
2:15- 2:30	3	0	3	0.0	1.4	0	7	0	7	0.0	0.3	1
2:30- 2:45	1	3	4	75.0	1.8	0	4	7	11	63.6	0.5	0
2:45- 3:00	1	0	1	0.0	0.5	0	6	1	7	14.3	0.3	0
1時間計	8	3	11	27.3	5.0	0	25	8	33	24.2	1.6	1
3:00- 3:15	2	1	3	33.3	1.4	0	6	4	10	40.0	0.5	0
3:15- 3:30	0	0	0	0.0	0.0	0	2	1	3	33.3	0.1	0
3:30- 3:45	0	0	0	0.0	0.0	0	1	1	2	50.0	0.1	0
3:45- 4:00	1	0	1	0.0	0.5	0	4	1	5	20.0	0.2	1
1時間計	3	1	4	25.0	1.8	0	13	7	20	35.0	0.9	1
4:00- 4:15	0	0	0	0.0	0.0	0	2	3	5	60.0	0.2	0
4:15- 4:30	0	0	0	0.0	0.0	0	2	0	2	0.0	0.1	0
4:30- 4:45	0	3	3	100.0	1.4	0	4	4	8	50.0	0.4	1
4:45- 5:00	5	3	8	37.5	3.7	0	9	5	14	35.7	0.7	0
1時間計	5	6	11	54.5	5.0	0	17	12	29	41.4	1.4	1
5:00- 5:15	1	1	2	50.0	0.9	0	7	7	14	50.0	0.7	0
5:15- 5:30	0	1	1	100.0	0.5	0	12	2	14	14.3	0.7	2
5:30- 5:45	0	0	0	0.0	0.0	0	11	2	13	15.4	0.6	0
5:45- 6:00	0	0	0	0.0	0.0	0	18	0	18	0.0	0.9	3
1時間計	1	2	3	66.7	1.4	0	48	11	59	18.6	2.8	5

方向別自動車交通量調査表

調査地点 : 地域社会3 上川井IC

調査年月日 : 令和元年10月13日(日) 天候:曇りのち雨

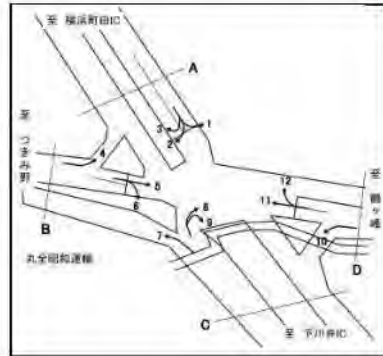

方向 時間帯	3						A 合計 (1+2+3)					
	種別 小型車 (台)	大型車 (台)	合計 (台)	大型車 混入率 (%)	時間 係数 (%)	二輪車 (台)	小型車 (台)	大型車 (台)	合計 (台)	大型車 混入率 (%)	時間 係数 (%)	二輪車 (台)
6:00-6:15	2	2	4	50.0	1.8	0	18	3	21	14.3	1.0	1
6:15-6:30	0	0	0	0.0	0.0	0	19	1	20	5.0	0.9	3
6:30-6:45	0	0	0	0.0	0.0	0	11	3	14	21.4	0.7	1
6:45-7:00	3	0	3	0.0	1.4	0	30	7	37	18.9	1.8	4
1時間計	5	2	7	28.6	3.2	0	78	14	92	15.2	4.4	9
7:00-7:15	0	1	1	100.0	0.5	0	30	2	32	6.3	1.5	2
7:15-7:30	0	0	0	0.0	0.0	0	28	7	35	20.0	1.7	4
7:30-7:45	2	0	2	0.0	0.9	0	38	0	38	0.0	1.8	5
7:45-8:00	4	0	4	0.0	1.8	0	22	5	27	18.5	1.3	5
1時間計	6	1	7	14.3	3.2	0	118	14	132	10.6	6.3	16
8:00-8:15	0	2	2	100.0	0.9	0	26	9	35	25.7	1.7	2
8:15-8:30	3	0	3	0.0	1.4	0	34	4	38	10.5	1.8	6
8:30-8:45	0	0	0	0.0	0.0	0	33	2	35	5.7	1.7	1
8:45-9:00	1	0	1	0.0	0.5	0	20	5	25	20.0	1.2	2
1時間計	4	2	6	33.3	2.8	0	113	20	133	15.0	6.3	11
9:00-9:15	0	0	0	0.0	0.0	0	15	5	20	25.0	0.9	1
9:15-9:30	3	0	3	0.0	1.4	0	22	2	24	8.3	1.1	2
9:30-9:45	4	1	5	20.0	2.3	0	22	5	27	18.5	1.3	4
9:45-10:00	2	1	3	33.3	1.4	0	26	3	29	10.3	1.4	1
1時間計	9	2	11	18.2	5.0	0	85	15	100	15.0	4.7	8
10:00-10:15	2	1	3	33.3	1.4	0	23	8	31	25.8	1.5	1
10:15-10:30	2	2	4	50.0	1.8	0	24	8	32	25.0	1.5	4
10:30-10:45	5	3	8	37.5	3.7	0	21	6	27	22.2	1.3	1
10:45-11:00	5	1	6	16.7	2.8	0	25	10	35	28.6	1.7	0
1時間計	14	7	21	33.3	9.6	0	93	32	125	25.6	5.9	6
11:00-11:15	4	6	10	60.0	4.6	0	29	11	40	27.5	1.9	2
11:15-11:30	6	1	7	14.3	3.2	0	38	3	41	7.3	1.9	0
11:30-11:45	4	0	4	0.0	1.8	0	24	8	32	25.0	1.5	1
11:45-12:00	6	5	11	45.5	5.0	0	35	8	43	18.6	2.0	0
1時間計	20	12	32	37.5	14.7	0	126	30	156	19.2	7.4	3
12:00-12:15	0	0	0	0.0	0.0	0	27	2	29	6.9	1.4	0
12:15-12:30	2	0	2	0.0	0.9	0	32	9	41	22.0	1.9	0
12:30-12:45	2	2	4	50.0	1.8	0	24	6	30	20.0	1.4	0
12:45-13:00	0	0	0	0.0	0.0	0	30	4	34	11.8	1.6	2
1時間計	4	2	6	33.3	2.8	0	113	21	134	15.7	6.4	2
13:00-13:15	0	2	2	100.0	0.9	0	26	4	30	13.3	1.4	0
13:15-13:30	2	1	3	33.3	1.4	0	24	5	29	17.2	1.4	1
13:30-13:45	2	2	4	50.0	1.8	0	27	7	34	20.6	1.6	0
13:45-14:00	2	2	4	50.0	1.8	0	25	5	30	16.7	1.4	1
1時間計	6	7	13	53.8	6.0	0	102	21	123	17.1	5.8	2

方向別自動車交通量調査表

調査地点 : 地域社会3 上川井IC

調査年月日 : 令和元年10月13日(日) 天候:曇りのち雨

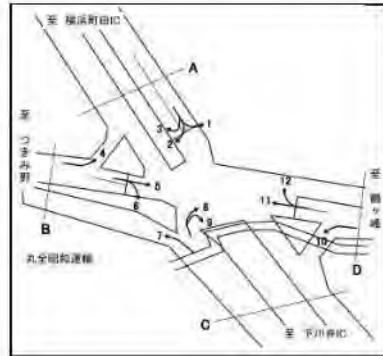

方向 種別 時間帯	3						A 合計 (1+2+3)					
	小型車 (台)	大型車 (台)	合計 (台)	大型車 混入率 (%)	時間 係数 (%)	二輪車 (台)	小型車 (台)	大型車 (台)	合計 (台)	大型車 混入率 (%)	時間 係数 (%)	二輪車 (台)
14:00-14:15	2	0	2	0.0	0.9	0	17	3	20	15.0	0.9	1
14:15-14:30	3	1	4	25.0	1.8	1	15	5	20	25.0	0.9	3
14:30-14:45	1	1	2	50.0	0.9	0	23	5	28	17.9	1.3	0
14:45-15:00	2	0	2	0.0	0.9	0	18	3	21	14.3	1.0	2
1時間計	8	2	10	20.0	4.6	1	73	16	89	18.0	4.2	6
15:00-15:15	3	1	4	25.0	1.8	0	35	3	38	7.9	1.8	1
15:15-15:30	1	2	3	66.7	1.4	0	20	7	27	25.9	1.3	2
15:30-15:45	1	0	1	0.0	0.5	0	33	4	37	10.8	1.8	2
15:45-16:00	2	1	3	33.3	1.4	0	24	4	28	14.3	1.3	4
1時間計	7	4	11	36.4	5.0	0	112	18	130	13.8	6.2	9
16:00-16:15	0	1	1	100.0	0.5	0	23	8	31	25.8	1.5	1
16:15-16:30	1	2	3	66.7	1.4	0	22	6	28	21.4	1.3	1
16:30-16:45	0	1	1	100.0	0.5	0	23	6	29	20.7	1.4	1
16:45-17:00	1	1	2	50.0	0.9	0	31	7	38	18.4	1.8	1
1時間計	2	5	7	71.4	3.2	0	99	27	126	21.4	6.0	4
17:00-17:15	2	1	3	33.3	1.4	0	27	3	30	10.0	1.4	0
17:15-17:30	1	1	2	50.0	0.9	0	27	9	36	25.0	1.7	0
17:30-17:45	2	0	2	0.0	0.9	0	30	8	38	21.1	1.8	4
17:45-18:00	1	0	1	0.0	0.5	0	29	2	31	6.5	1.5	3
1時間計	6	2	8	25.0	3.7	0	113	22	135	16.3	6.4	7
18:00-18:15	1	0	1	0.0	0.5	0	18	3	21	14.3	1.0	2
18:15-18:30	0	0	0	0.0	0.0	0	25	7	32	21.9	1.5	1
18:30-18:45	0	0	0	0.0	0.0	0	21	1	22	4.5	1.0	3
18:45-19:00	2	1	3	33.3	1.4	0	21	4	25	16.0	1.2	3
1時間計	3	1	4	25.0	1.8	0	85	15	100	15.0	4.7	9
19:00-19:15	3	1	4	25.0	1.8	0	29	5	34	14.7	1.6	3
19:15-19:30	1	2	3	66.7	1.4	0	23	4	27	14.8	1.3	2
19:30-19:45	0	0	0	0.0	0.0	0	23	2	25	8.0	1.2	3
19:45-20:00	3	0	3	0.0	1.4	0	20	2	22	9.1	1.0	1
1時間計	7	3	10	30.0	4.6	0	95	13	108	12.0	5.1	9
20:00-20:15	2	0	2	0.0	0.9	0	19	5	24	20.8	1.1	2
20:15-20:30	4	1	5	20.0	2.3	0	13	4	17	23.5	0.8	2
20:30-20:45	2	0	2	0.0	0.9	0	17	3	20	15.0	0.9	4
20:45-21:00	2	0	2	0.0	0.9	0	16	0	16	0.0	0.8	1
1時間計	10	1	11	9.1	5.0	0	65	12	77	15.6	3.7	9
21:00-21:15	3	1	4	25.0	1.8	0	18	2	20	10.0	0.9	3
21:15-21:30	1	0	1	0.0	0.5	0	11	1	12	8.3	0.6	1
21:30-21:45	2	0	2	0.0	0.9	0	12	1	13	7.7	0.6	0
21:45-22:00	1	0	1	0.0	0.5	0	12	1	13	7.7	0.6	0
1時間計	7	1	8	12.5	3.7	0	53	5	58	8.6	2.8	4
昼12時間計	89	47	136	34.6	62.4	1	1232	251	1483	16.9	70.4	83
夜12時間計	59	23	82	28.0	37.6	0	526	97	623	15.6	29.6	49
全時間合計	148	70	218	32.1	100.0	1	1758	348	2106	16.5	100.0	132
昼夜率	1.66	1.49	1.60	-	-	1.00	1.43	1.39	1.42	-	-	1.59

方向別自動車交通量調査表

調査地点 : 地域社会3 上川井IC

調査年月日 : 令和元年10月13日(日) 天候:曇りのち雨

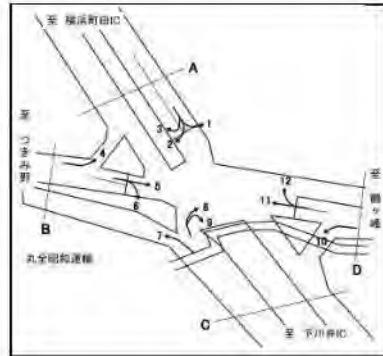

方向 種別 時間帯	4						5					
	小型車 (台)	大型車 (台)	合計 (台)	大型車 混入率 (%)	時間 係数 (%)	二輪車 (台)	小型車 (台)	大型車 (台)	合計 (台)	大型車 混入率 (%)	時間 係数 (%)	二輪車 (台)
22:00-22:15	1	0	1	0.0	0.6	0	30	5	35	14.3	1.0	1
22:15-22:30	1	0	1	0.0	0.6	0	44	1	45	2.2	1.3	1
22:30-22:45	1	4	5	80.0	2.8	0	33	1	34	2.9	1.0	4
22:45-23:00	2	0	2	0.0	1.1	0	32	1	33	3.0	0.9	4
1時間計	5	4	9	44.4	5.1	0	139	8	147	5.4	4.2	10
23:00-23:15	1	0	1	0.0	0.6	0	22	1	23	4.3	0.7	5
23:15-23:30	0	0	0	0.0	0.0	0	13	3	16	18.8	0.5	2
23:30-23:45	1	1	2	50.0	1.1	0	19	1	20	5.0	0.6	2
23:45-24:00	1	0	1	0.0	0.6	0	21	0	21	0.0	0.6	2
1時間計	3	1	4	25.0	2.2	0	75	5	80	6.3	2.3	11
0:00-0:15	3	0	3	0.0	1.7	0	16	2	18	11.1	0.5	4
0:15-0:30	0	0	0	0.0	0.0	0	10	2	12	16.7	0.3	0
0:30-0:45	2	0	2	0.0	1.1	0	6	2	8	25.0	0.2	4
0:45-1:00	1	0	1	0.0	0.6	1	7	1	8	12.5	0.2	1
1時間計	6	0	6	0.0	3.4	1	39	7	46	15.2	1.3	9
1:00-1:15	0	0	0	0.0	0.0	0	7	4	11	36.4	0.3	1
1:15-1:30	0	0	0	0.0	0.0	0	2	1	3	33.3	0.1	1
1:30-1:45	0	0	0	0.0	0.0	0	10	3	13	23.1	0.4	0
1:45-2:00	0	0	0	0.0	0.0	0	6	0	6	0.0	0.2	0
1時間計	0	0	0	0.0	0.0	0	25	8	33	24.2	0.9	2
2:00-2:15	0	0	0	0.0	0.0	0	9	1	10	10.0	0.3	0
2:15-2:30	0	0	0	0.0	0.0	1	7	2	9	22.2	0.3	0
2:30-2:45	0	0	0	0.0	0.0	0	4	0	4	0.0	0.1	1
2:45-3:00	0	0	0	0.0	0.0	0	10	0	10	0.0	0.3	0
1時間計	0	0	0	0.0	0.0	1	30	3	33	9.1	0.9	1
3:00-3:15	0	0	0	0.0	0.0	0	5	2	7	28.6	0.2	0
3:15-3:30	1	1	2	50.0	1.1	0	5	3	8	37.5	0.2	4
3:30-3:45	1	0	1	0.0	0.6	0	5	3	8	37.5	0.2	2
3:45-4:00	1	0	1	0.0	0.6	0	3	3	6	50.0	0.2	3
1時間計	3	1	4	25.0	2.2	0	18	11	29	37.9	0.8	9
4:00-4:15	0	0	0	0.0	0.0	0	3	3	6	50.0	0.2	1
4:15-4:30	1	0	1	0.0	0.6	0	2	8	10	80.0	0.3	1
4:30-4:45	2	0	2	0.0	1.1	0	11	1	12	8.3	0.3	2
4:45-5:00	1	0	1	0.0	0.6	0	11	1	12	8.3	0.3	0
1時間計	4	0	4	0.0	2.2	0	27	13	40	32.5	1.1	4
5:00-5:15	2	0	2	0.0	1.1	0	12	1	13	7.7	0.4	4
5:15-5:30	1	0	1	0.0	0.6	0	13	2	15	13.3	0.4	5
5:30-5:45	0	1	1	100.0	0.6	0	21	3	24	12.5	0.7	1
5:45-6:00	2	0	2	0.0	1.1	0	27	5	32	15.6	0.9	2
1時間計	5	1	6	16.7	3.4	0	73	11	84	13.1	2.4	12

方向別自動車交通量調査表

調査地点 : 地域社会3 上川井IC

調査年月日 : 令和元年10月13日(日) 天候:曇りのち雨



方向 時間帯	4						5					
	種別 小型車 (台)	大型車 (台)	合計 (台)	大型車 混入率 (%)	時間 係数 (%)	二輪車 (台)	小型車 (台)	大型車 (台)	合計 (台)	大型車 混入率 (%)	時間 係数 (%)	二輪車 (台)
6:00-6:15	1	0	1	0.0	0.6	0	34	6	40	15.0	1.1	5
6:15-6:30	6	0	6	0.0	3.4	0	26	9	35	25.7	1.0	3
6:30-6:45	0	2	2	100.0	1.1	0	21	2	23	8.7	0.7	6
6:45-7:00	3	0	3	0.0	1.7	0	41	6	47	12.8	1.3	4
1時間計	10	2	12	16.7	6.7	0	122	23	145	15.9	4.2	18
7:00-7:15	0	1	1	100.0	0.6	0	32	1	33	3.0	0.9	5
7:15-7:30	0	0	0	0.0	0.0	0	30	9	39	23.1	1.1	5
7:30-7:45	0	0	0	0.0	0.0	0	37	4	41	9.8	1.2	4
7:45-8:00	0	0	0	0.0	0.0	0	35	8	43	18.6	1.2	3
1時間計	0	1	1	100.0	0.6	0	134	22	156	14.1	4.5	17
8:00-8:15	1	0	1	0.0	0.6	0	22	10	32	31.3	0.9	7
8:15-8:30	1	0	1	0.0	0.6	0	39	5	44	11.4	1.3	2
8:30-8:45	3	0	3	0.0	1.7	0	30	7	37	18.9	1.1	4
8:45-9:00	4	0	4	0.0	2.2	1	51	16	67	23.9	1.9	2
1時間計	9	0	9	0.0	5.1	1	142	38	180	21.1	5.2	15
9:00-9:15	0	0	0	0.0	0.0	0	21	7	28	25.0	0.8	1
9:15-9:30	0	2	2	100.0	1.1	0	32	11	43	25.6	1.2	2
9:30-9:45	0	0	0	0.0	0.0	0	36	7	43	16.3	1.2	3
9:45-10:00	1	1	2	50.0	1.1	0	34	5	39	12.8	1.1	0
1時間計	1	3	4	75.0	2.2	0	123	30	153	19.6	4.4	6
10:00-10:15	1	1	2	50.0	1.1	0	46	6	52	11.5	1.5	1
10:15-10:30	2	1	3	33.3	1.7	0	22	8	30	26.7	0.9	2
10:30-10:45	2	0	2	0.0	1.1	0	38	3	41	7.3	1.2	1
10:45-11:00	5	1	6	16.7	3.4	0	38	7	45	15.6	1.3	1
1時間計	10	3	13	23.1	7.3	0	144	24	168	14.3	4.8	5
11:00-11:15	3	1	4	25.0	2.2	0	30	6	36	16.7	1.0	2
11:15-11:30	4	0	4	0.0	2.2	0	46	8	54	14.8	1.5	1
11:30-11:45	3	0	3	0.0	1.7	0	37	8	45	17.8	1.3	3
11:45-12:00	3	0	3	0.0	1.7	0	33	3	36	8.3	1.0	1
1時間計	13	1	14	7.1	7.9	0	146	25	171	14.6	4.9	7
12:00-12:15	2	0	2	0.0	1.1	0	44	0	44	0.0	1.3	1
12:15-12:30	5	0	5	0.0	2.8	0	63	9	72	12.5	2.1	1
12:30-12:45	4	0	4	0.0	2.2	0	51	2	53	3.8	1.5	0
12:45-13:00	0	0	0	0.0	0.0	1	40	4	44	9.1	1.3	1
1時間計	11	0	11	0.0	6.2	1	198	15	213	7.0	6.1	3
13:00-13:15	0	1	1	100.0	0.6	0	37	5	42	11.9	1.2	0
13:15-13:30	0	1	1	100.0	0.6	0	33	8	41	19.5	1.2	1
13:30-13:45	1	1	2	50.0	1.1	0	40	7	47	14.9	1.3	1
13:45-14:00	1	1	2	50.0	1.1	0	37	3	40	7.5	1.1	2
1時間計	2	4	6	66.7	3.4	0	147	23	170	13.5	4.9	4

方向別自動車交通量調査表

調査地点 : 地域社会3 上川井IC

調査年月日 : 令和元年10月13日(日) 天候:曇りのち雨

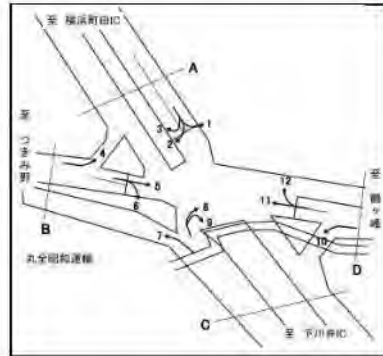

方向	4						5						
	種別	小型車 (台)	大型車 (台)	合計 (台)	大型車 混入率 (%)	時 間 係 数 (%)	二輪車 (台)	小型車 (台)	大型車 (台)	合計 (台)	大型車 混入率 (%)	時 間 係 数 (%)	二輪車 (台)
14:00-14:15		2	0	2	0.0	1.1	0	47	13	60	21.7	1.7	0
14:15-14:30		1	1	2	50.0	1.1	0	51	3	54	5.6	1.5	0
14:30-14:45		2	1	3	33.3	1.7	0	58	9	67	13.4	1.9	3
14:45-15:00		2	0	2	0.0	1.1	0	48	8	56	14.3	1.6	2
1時間計		7	2	9	22.2	5.1	0	204	33	237	13.9	6.8	5
15:00-15:15		2	1	3	33.3	1.7	0	42	2	44	4.5	1.3	1
15:15-15:30		1	0	1	0.0	0.6	0	48	3	51	5.9	1.5	3
15:30-15:45		2	0	2	0.0	1.1	0	46	2	48	4.2	1.4	0
15:45-16:00		2	0	2	0.0	1.1	0	48	6	54	11.1	1.5	2
1時間計		7	1	8	12.5	4.5	0	184	13	197	6.6	5.6	6
16:00-16:15		3	3	6	50.0	3.4	0	63	5	68	7.4	1.9	4
16:15-16:30		3	2	5	40.0	2.8	0	64	6	70	8.6	2.0	3
16:30-16:45		1	1	2	50.0	1.1	0	72	4	76	5.3	2.2	1
16:45-17:00		2	4	6	66.7	3.4	0	45	2	47	4.3	1.3	6
1時間計		9	10	19	52.6	10.7	0	244	17	261	6.5	7.5	14
17:00-17:15		2	1	3	33.3	1.7	1	50	1	51	2.0	1.5	11
17:15-17:30		2	1	3	33.3	1.7	0	58	1	59	1.7	1.7	6
17:30-17:45		3	1	4	25.0	2.2	0	44	1	45	2.2	1.3	5
17:45-18:00		0	1	1	100.0	0.6	0	56	1	57	1.8	1.6	3
1時間計		7	4	11	36.4	6.2	1	208	4	212	1.9	6.1	25
18:00-18:15		3	0	3	0.0	1.7	0	65	3	68	4.4	1.9	11
18:15-18:30		1	2	3	66.7	1.7	0	58	1	59	1.7	1.7	8
18:30-18:45		1	1	2	50.0	1.1	0	46	4	50	8.0	1.4	5
18:45-19:00		0	0	0	0.0	0.0	0	63	3	66	4.5	1.9	8
1時間計		5	3	8	37.5	4.5	0	232	11	243	4.5	7.0	32
19:00-19:15		2	0	2	0.0	1.1	0	66	1	67	1.5	1.9	8
19:15-19:30		0	0	0	0.0	0.0	0	37	3	40	7.5	1.1	2
19:30-19:45		2	0	2	0.0	1.1	0	44	2	46	4.3	1.3	1
19:45-20:00		0	1	1	100.0	0.6	0	47	5	52	9.6	1.5	3
1時間計		4	1	5	20.0	2.8	0	194	11	205	5.4	5.9	14
20:00-20:15		2	1	3	33.3	1.7	0	44	0	44	0.0	1.3	1
20:15-20:30		0	0	0	0.0	0.0	0	37	4	41	9.8	1.2	1
20:30-20:45		4	1	5	20.0	2.8	0	40	4	44	9.1	1.3	1
20:45-21:00		1	0	1	0.0	0.6	0	31	5	36	13.9	1.0	3
1時間計		7	2	9	22.2	5.1	0	152	13	165	7.9	4.7	6
21:00-21:15		0	0	0	0.0	0.0	0	33	2	35	5.7	1.0	2
21:15-21:30		2	0	2	0.0	1.1	0	37	2	39	5.1	1.1	3
21:30-21:45		2	0	2	0.0	1.1	0	19	2	21	9.5	0.6	2
21:45-22:00		2	0	2	0.0	1.1	0	25	2	27	7.4	0.8	1
1時間計		6	0	6	0.0	3.4	0	114	8	122	6.6	3.5	8
昼12時間計		81	32	113	28.3	63.5	3	2106	255	2361	10.8	67.7	139
夜12時間計		53	12	65	18.5	36.5	2	1008	121	1129	10.7	32.3	104
全時間合計		134	44	178	24.7	100.0	5	3114	376	3490	10.8	100.0	243
昼 夜 率		1.65	1.38	1.58	-	-	1.67	1.48	1.47	1.48	-	-	1.75

方向別自動車交通量調査表

調査地点 : 地域社会3 上川井IC

調査年月日 : 令和元年10月13日(日) 天候:曇りのち雨

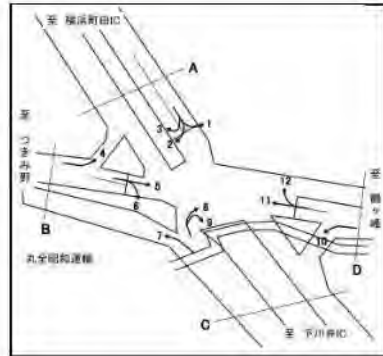

方向 種別 時間帯	6						B 合計 (4+ 5+ 6)					
	小型車 (台)	大型車 (台)	合計 (台)	大型車 混入率 (%)	時間 係数 (%)	二輪車 (台)	小型車 (台)	大型車 (台)	合計 (台)	大型車 混入率 (%)	時間 係数 (%)	二輪車 (台)
22:00-22:15	49	11	60	18.3	0.9	2	80	16	96	16.7	1.0	3
22:15-22:30	48	5	53	9.4	0.8	2	93	6	99	6.1	1.0	3
22:30-22:45	41	9	50	18.0	0.8	0	75	14	89	15.7	0.9	4
22:45-23:00	39	9	48	18.8	0.7	2	73	10	83	12.0	0.8	6
1時間計	177	34	211	16.1	3.3	6	321	46	367	12.5	3.6	16
23:00-23:15	31	18	49	36.7	0.8	0	54	19	73	26.0	0.7	5
23:15-23:30	21	17	38	44.7	0.6	0	34	20	54	37.0	0.5	2
23:30-23:45	15	16	31	51.6	0.5	2	35	18	53	34.0	0.5	4
23:45-24:00	14	15	29	51.7	0.5	1	36	15	51	29.4	0.5	3
1時間計	81	66	147	44.9	2.3	3	159	72	231	31.2	2.3	14
0:00- 0:15	17	17	34	50.0	0.5	0	36	19	55	34.5	0.5	4
0:15- 0:30	19	13	32	40.6	0.5	0	29	15	44	34.1	0.4	0
0:30- 0:45	11	4	15	26.7	0.2	0	19	6	25	24.0	0.2	4
0:45- 1:00	14	9	23	39.1	0.4	0	22	10	32	31.3	0.3	2
1時間計	61	43	104	41.3	1.6	0	106	50	156	32.1	1.5	10
1:00- 1:15	12	7	19	36.8	0.3	2	19	11	30	36.7	0.3	3
1:15- 1:30	12	9	21	42.9	0.3	0	14	10	24	41.7	0.2	1
1:30- 1:45	14	15	29	51.7	0.5	0	24	18	42	42.9	0.4	0
1:45- 2:00	4	14	18	77.8	0.3	0	10	14	24	58.3	0.2	0
1時間計	42	45	87	51.7	1.4	2	67	53	120	44.2	1.2	4
2:00- 2:15	10	8	18	44.4	0.3	0	19	9	28	32.1	0.3	0
2:15- 2:30	8	11	19	57.9	0.3	0	15	13	28	46.4	0.3	1
2:30- 2:45	2	12	14	85.7	0.2	0	6	12	18	66.7	0.2	1
2:45- 3:00	15	10	25	40.0	0.4	0	25	10	35	28.6	0.3	0
1時間計	35	41	76	53.9	1.2	0	65	44	109	40.4	1.1	2
3:00- 3:15	16	11	27	40.7	0.4	0	21	13	34	38.2	0.3	0
3:15- 3:30	6	19	25	76.0	0.4	0	12	23	35	65.7	0.3	4
3:30- 3:45	8	15	23	65.2	0.4	2	14	18	32	56.3	0.3	4
3:45- 4:00	8	21	29	72.4	0.5	1	12	24	36	66.7	0.4	4
1時間計	38	66	104	63.5	1.6	3	59	78	137	56.9	1.4	12
4:00- 4:15	13	17	30	56.7	0.5	0	16	20	36	55.6	0.4	1
4:15- 4:30	18	16	34	47.1	0.5	0	21	24	45	53.3	0.4	1
4:30- 4:45	15	14	29	48.3	0.5	2	28	15	43	34.9	0.4	4
4:45- 5:00	26	24	50	48.0	0.8	0	38	25	63	39.7	0.6	0
1時間計	72	71	143	49.7	2.2	2	103	84	187	44.9	1.9	6
5:00- 5:15	20	23	43	53.5	0.7	1	34	24	58	41.4	0.6	5
5:15- 5:30	40	32	72	44.4	1.1	1	54	34	88	38.6	0.9	6
5:30- 5:45	49	36	85	42.4	1.3	2	70	40	110	36.4	1.1	3
5:45- 6:00	53	19	72	26.4	1.1	2	82	24	106	22.6	1.1	4
1時間計	162	110	272	40.4	4.2	6	240	122	362	33.7	3.6	18

方向別自動車交通量調査表

調査地点 : 地域社会3 上川井IC

調査年月日 : 令和元年10月13日(日) 天候:曇りのち雨

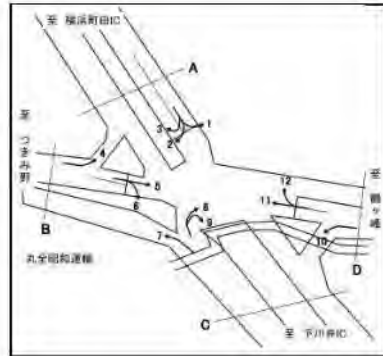

方向 時間帯	6						B 合計 (4+ 5+ 6)					
	種別 小型車 (台)	大型車 (台)	合計 (台)	大型車 混入率 (%)	時間 係数 (%)	二輪車 (台)	小型車 (台)	大型車 (台)	合計 (台)	大型車 混入率 (%)	時間 係数 (%)	二輪車 (台)
6:00-6:15	73	35	108	32.4	1.7	3	108	41	149	27.5	1.5	8
6:15-6:30	84	24	108	22.2	1.7	2	116	33	149	22.1	1.5	5
6:30-6:45	60	31	91	34.1	1.4	3	81	35	116	30.2	1.1	9
6:45-7:00	55	31	86	36.0	1.3	2	99	37	136	27.2	1.3	6
1時間計	272	121	393	30.8	6.1	10	404	146	550	26.5	5.5	28
7:00-7:15	62	31	93	33.3	1.4	3	94	33	127	26.0	1.3	8
7:15-7:30	49	23	72	31.9	1.1	3	79	32	111	28.8	1.1	8
7:30-7:45	53	19	72	26.4	1.1	0	90	23	113	20.4	1.1	4
7:45-8:00	50	23	73	31.5	1.1	1	85	31	116	26.7	1.1	4
1時間計	214	96	310	31.0	4.8	7	348	119	467	25.5	4.6	24
8:00-8:15	60	23	83	27.7	1.3	0	83	33	116	28.4	1.1	7
8:15-8:30	41	29	70	41.4	1.1	2	81	34	115	29.6	1.1	4
8:30-8:45	74	32	106	30.2	1.7	0	107	39	146	26.7	1.4	4
8:45-9:00	77	20	97	20.6	1.5	0	132	36	168	21.4	1.7	3
1時間計	252	104	356	29.2	5.5	2	403	142	545	26.1	5.4	18
9:00-9:15	49	28	77	36.4	1.2	0	70	35	105	33.3	1.0	1
9:15-9:30	66	21	87	24.1	1.4	0	98	34	132	25.8	1.3	2
9:30-9:45	61	27	88	30.7	1.4	0	97	34	131	26.0	1.3	3
9:45-10:00	56	28	84	33.3	1.3	1	91	34	125	27.2	1.2	1
1時間計	232	104	336	31.0	5.2	1	356	137	493	27.8	4.9	7
10:00-10:15	50	27	77	35.1	1.2	0	97	34	131	26.0	1.3	1
10:15-10:30	60	26	86	30.2	1.3	2	84	35	119	29.4	1.2	4
10:30-10:45	43	17	60	28.3	0.9	0	83	20	103	19.4	1.0	1
10:45-11:00	104	40	144	27.8	2.2	1	147	48	195	24.6	1.9	2
1時間計	257	110	367	30.0	5.7	3	411	137	548	25.0	5.4	8
11:00-11:15	76	12	88	13.6	1.4	0	109	19	128	14.8	1.3	2
11:15-11:30	63	16	79	20.3	1.2	0	113	24	137	17.5	1.4	1
11:30-11:45	54	16	70	22.9	1.1	0	94	24	118	20.3	1.2	3
11:45-12:00	60	19	79	24.1	1.2	2	96	22	118	18.6	1.2	3
1時間計	253	63	316	19.9	4.9	2	412	89	501	17.8	5.0	9
12:00-12:15	47	20	67	29.9	1.0	0	93	20	113	17.7	1.1	1
12:15-12:30	65	19	84	22.6	1.3	0	133	28	161	17.4	1.6	1
12:30-12:45	41	17	58	29.3	0.9	0	96	19	115	16.5	1.1	0
12:45-13:00	61	16	77	20.8	1.2	0	101	20	121	16.5	1.2	2
1時間計	214	72	286	25.2	4.5	0	423	87	510	17.1	5.1	4
13:00-13:15	49	20	69	29.0	1.1	0	86	26	112	23.2	1.1	0
13:15-13:30	49	12	61	19.7	1.0	0	82	21	103	20.4	1.0	1
13:30-13:45	65	24	89	27.0	1.4	1	106	32	138	23.2	1.4	2
13:45-14:00	57	14	71	19.7	1.1	0	95	18	113	15.9	1.1	2
1時間計	220	70	290	24.1	4.5	1	369	97	466	20.8	4.6	5

方向別自動車交通量調査表

調査地点 : 地域社会3 上川井IC

調査年月日 : 令和元年10月13日(日) 天候:曇りのち雨



方向	6						B 合計 (4+ 5+ 6)						
	種別	小型車 (台)	大型車 (台)	合計 (台)	大型車 混入率 (%)	時 間 係 数 (%)	二輪車 (台)	小型車 (台)	大型車 (台)	合計 (台)	大型車 混入率 (%)	時 間 係 数 (%)	二輪車 (台)
14:00-14:15		47	18	65	27.7	1.0	0	96	31	127	24.4	1.3	0
14:15-14:30		64	15	79	19.0	1.2	0	116	19	135	14.1	1.3	0
14:30-14:45		49	17	66	25.8	1.0	0	109	27	136	19.9	1.3	3
14:45-15:00		75	14	89	15.7	1.4	1	125	22	147	15.0	1.5	3
1時間計		235	64	299	21.4	4.7	1	446	99	545	18.2	5.4	6
15:00-15:15		62	22	84	26.2	1.3	2	106	25	131	19.1	1.3	3
15:15-15:30		73	15	88	17.0	1.4	1	122	18	140	12.9	1.4	4
15:30-15:45		66	17	83	20.5	1.3	0	114	19	133	14.3	1.3	0
15:45-16:00		65	14	79	17.7	1.2	0	115	20	135	14.8	1.3	2
1時間計		266	68	334	20.4	5.2	3	457	82	539	15.2	5.3	9
16:00-16:15		93	19	112	17.0	1.7	2	159	27	186	14.5	1.8	6
16:15-16:30		71	23	94	24.5	1.5	1	138	31	169	18.3	1.7	4
16:30-16:45		66	15	81	18.5	1.3	1	139	20	159	12.6	1.6	2
16:45-17:00		72	20	92	21.7	1.4	0	119	26	145	17.9	1.4	6
1時間計		302	77	379	20.3	5.9	4	555	104	659	15.8	6.5	18
17:00-17:15		81	17	98	17.3	1.5	1	133	19	152	12.5	1.5	13
17:15-17:30		72	11	83	13.3	1.3	0	132	13	145	9.0	1.4	6
17:30-17:45		70	9	79	11.4	1.2	2	117	11	128	8.6	1.3	7
17:45-18:00		97	11	108	10.2	1.7	2	153	13	166	7.8	1.6	5
1時間計		320	48	368	13.0	5.7	5	535	56	591	9.5	5.9	31
18:00-18:15		102	14	116	12.1	1.8	0	170	17	187	9.1	1.9	11
18:15-18:30		81	13	94	13.8	1.5	3	140	16	156	10.3	1.5	11
18:30-18:45		89	13	102	12.7	1.6	0	136	18	154	11.7	1.5	5
18:45-19:00		63	14	77	18.2	1.2	1	126	17	143	11.9	1.4	9
1時間計		335	54	389	13.9	6.1	4	572	68	640	10.6	6.3	36
19:00-19:15		70	13	83	15.7	1.3	1	138	14	152	9.2	1.5	9
19:15-19:30		64	19	83	22.9	1.3	0	101	22	123	17.9	1.2	2
19:30-19:45		57	10	67	14.9	1.0	1	103	12	115	10.4	1.1	2
19:45-20:00		53	11	64	17.2	1.0	0	100	17	117	14.5	1.2	3
1時間計		244	53	297	17.8	4.6	2	442	65	507	12.8	5.0	16
20:00-20:15		58	18	76	23.7	1.2	0	104	19	123	15.4	1.2	1
20:15-20:30		67	15	82	18.3	1.3	0	104	19	123	15.4	1.2	1
20:30-20:45		48	14	62	22.6	1.0	0	92	19	111	17.1	1.1	1
20:45-21:00		64	13	77	16.9	1.2	0	96	18	114	15.8	1.1	3
1時間計		237	60	297	20.2	4.6	0	396	75	471	15.9	4.7	6
21:00-21:15		62	17	79	21.5	1.2	1	95	19	114	16.7	1.1	3
21:15-21:30		52	18	70	25.7	1.1	2	91	20	111	18.0	1.1	5
21:30-21:45		47	10	57	17.5	0.9	0	68	12	80	15.0	0.8	2
21:45-22:00		39	15	54	27.8	0.8	1	66	17	83	20.5	0.8	2
1時間計		200	60	260	23.1	4.0	4	320	68	388	17.5	3.8	12
昼12時間計		3100	930	4030	23.1	62.8	33	5287	1217	6504	18.7	64.5	175
夜12時間計		1621	770	2391	32.2	37.2	38	2682	903	3585	25.2	35.5	144
全時間合計		4721	1700	6421	26.5	100.0	71	7969	2120	10089	21.0	100.0	319
昼 夜 率		1.52	1.83	1.59	-	-	2.15	1.51	1.74	1.55	-	-	1.82

方向別自動車交通量調査表

調査地点 : 地域社会3 上川井IC

調査年月日 : 令和元年10月13日(日) 天候:曇りのち雨

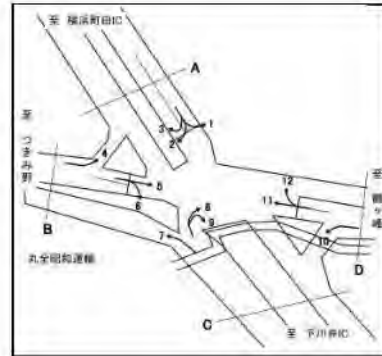

方向	7						8						
	種別	小型車 (台)	大型車 (台)	合計 (台)	大型車 混入率 (%)	時間 係数 (%)	二輪車 (台)	小型車 (台)	大型車 (台)	合計 (台)	大型車 混入率 (%)	時間 係数 (%)	二輪車 (台)
22:00-22:15		26	2	28	7.1	0.4	1	3	0	3	0.0	0.2	0
22:15-22:30		46	8	54	14.8	0.8	0	5	0	5	0.0	0.3	1
22:30-22:45		25	11	36	30.6	0.6	0	8	0	8	0.0	0.5	0
22:45-23:00		29	7	36	19.4	0.6	2	3	0	3	0.0	0.2	1
1時間計		126	28	154	18.2	2.4	3	19	0	19	0.0	1.1	2
23:00-23:15		41	8	49	16.3	0.8	0	13	0	13	0.0	0.7	1
23:15-23:30		25	7	32	21.9	0.5	0	6	0	6	0.0	0.3	0
23:30-23:45		24	10	34	29.4	0.5	0	4	0	4	0.0	0.2	0
23:45-24:00		25	8	33	24.2	0.5	2	5	0	5	0.0	0.3	0
1時間計		115	33	148	22.3	2.3	2	28	0	28	0.0	1.6	1
0:00-0:15		26	7	33	21.2	0.5	3	6	0	6	0.0	0.3	0
0:15-0:30		16	11	27	40.7	0.4	0	8	0	8	0.0	0.5	0
0:30-0:45		21	15	36	41.7	0.6	0	9	0	9	0.0	0.5	0
0:45-1:00		19	13	32	40.6	0.5	2	0	0	0	0.0	0.0	0
1時間計		82	46	128	35.9	2.0	5	23	0	23	0.0	1.3	0
1:00-1:15		15	14	29	48.3	0.5	0	6	0	6	0.0	0.3	0
1:15-1:30		11	11	22	50.0	0.3	2	2	0	2	0.0	0.1	0
1:30-1:45		16	10	26	38.5	0.4	0	4	0	4	0.0	0.2	0
1:45-2:00		15	10	25	40.0	0.4	1	0	0	0	0.0	0.0	1
1時間計		57	45	102	44.1	1.6	3	12	0	12	0.0	0.7	1
2:00-2:15		18	15	33	45.5	0.5	0	2	0	2	0.0	0.1	0
2:15-2:30		14	14	28	50.0	0.4	0	3	0	3	0.0	0.2	0
2:30-2:45		9	15	24	62.5	0.4	0	2	0	2	0.0	0.1	0
2:45-3:00		9	5	14	35.7	0.2	1	0	2	2	100.0	0.1	0
1時間計		50	49	99	49.5	1.5	1	7	2	9	22.2	0.5	0
3:00-3:15		4	10	14	71.4	0.2	0	0	1	1	100.0	0.1	0
3:15-3:30		9	11	20	55.0	0.3	0	5	1	6	16.7	0.3	0
3:30-3:45		8	8	16	50.0	0.2	0	3	0	3	0.0	0.2	0
3:45-4:00		15	13	28	46.4	0.4	0	3	0	3	0.0	0.2	0
1時間計		36	42	78	53.8	1.2	0	11	2	13	15.4	0.7	0
4:00-4:15		7	11	18	61.1	0.3	0	3	0	3	0.0	0.2	0
4:15-4:30		10	14	24	58.3	0.4	0	2	0	2	0.0	0.1	0
4:30-4:45		10	15	25	60.0	0.4	2	4	0	4	0.0	0.2	0
4:45-5:00		17	21	38	55.3	0.6	1	7	0	7	0.0	0.4	0
1時間計		44	61	105	58.1	1.6	3	16	0	16	0.0	0.9	0
5:00-5:15		19	7	26	26.9	0.4	0	3	0	3	0.0	0.2	0
5:15-5:30		20	19	39	48.7	0.6	0	9	0	9	0.0	0.5	0
5:30-5:45		23	18	41	43.9	0.6	0	3	0	3	0.0	0.2	0
5:45-6:00		49	24	73	32.9	1.1	1	3	2	5	40.0	0.3	0
1時間計		111	68	179	38.0	2.8	1	18	2	20	10.0	1.2	0

方向別自動車交通量調査表

調査地点 : 地域社会3 上川井IC

調査年月日 : 令和元年10月13日(日) 天候:曇りのち雨

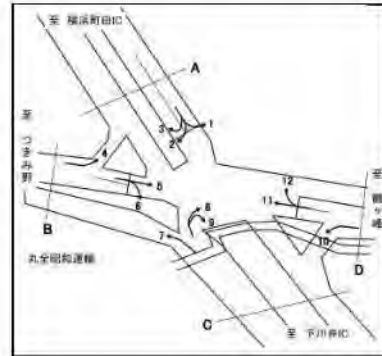

方向	7						8						
	種別	小型車 (台)	大型車 (台)	合計 (台)	大型車 混入率 (%)	時間 係数 (%)	二輪車 (台)	小型車 (台)	大型車 (台)	合計 (台)	大型車 混入率 (%)	時間 係数 (%)	二輪車 (台)
6:00-6:15		56	14	70	20.0	1.1	2	6	0	6	0.0	0.3	1
6:15-6:30		57	21	78	26.9	1.2	0	15	1	16	6.3	0.9	0
6:30-6:45		69	16	85	18.8	1.3	2	16	3	19	15.8	1.1	0
6:45-7:00		61	13	74	17.6	1.1	2	18	2	20	10.0	1.2	1
1時間計		243	64	307	20.8	4.8	6	55	6	61	9.8	3.5	2
7:00-7:15		70	10	80	12.5	1.2	2	18	0	18	0.0	1.0	0
7:15-7:30		77	25	102	24.5	1.6	1	31	2	33	6.1	1.9	1
7:30-7:45		72	19	91	20.9	1.4	2	23	0	23	0.0	1.3	0
7:45-8:00		68	24	92	26.1	1.4	0	34	2	36	5.6	2.1	1
1時間計		287	78	365	21.4	5.7	5	106	4	110	3.6	6.3	2
8:00-8:15		89	24	113	21.2	1.8	1	36	3	39	7.7	2.2	0
8:15-8:30		66	22	88	25.0	1.4	3	25	2	27	7.4	1.6	0
8:30-8:45		47	18	65	27.7	1.0	0	26	1	27	3.7	1.6	1
8:45-9:00		67	10	77	13.0	1.2	1	39	0	39	0.0	2.2	0
1時間計		269	74	343	21.6	5.3	5	126	6	132	4.5	7.6	1
9:00-9:15		55	19	74	25.7	1.1	0	22	5	27	18.5	1.6	0
9:15-9:30		59	31	90	34.4	1.4	0	33	0	33	0.0	1.9	0
9:30-9:45		59	27	86	31.4	1.3	0	25	0	25	0.0	1.4	0
9:45-10:00		80	24	104	23.1	1.6	0	24	3	27	11.1	1.6	0
1時間計		253	101	354	28.5	5.5	0	104	8	112	7.1	6.4	0
10:00-10:15		66	35	101	34.7	1.6	1	26	4	30	13.3	1.7	0
10:15-10:30		76	28	104	26.9	1.6	0	31	2	33	6.1	1.9	0
10:30-10:45		78	29	107	27.1	1.7	0	28	2	30	6.7	1.7	0
10:45-11:00		68	24	92	26.1	1.4	0	26	0	26	0.0	1.5	0
1時間計		288	116	404	28.7	6.3	1	111	8	119	6.7	6.8	0
11:00-11:15		55	13	68	19.1	1.1	0	36	1	37	2.7	2.1	0
11:15-11:30		62	28	90	31.1	1.4	0	23	1	24	4.2	1.4	1
11:30-11:45		50	20	70	28.6	1.1	0	26	1	27	3.7	1.6	0
11:45-12:00		55	31	86	36.0	1.3	1	12	0	12	0.0	0.7	1
1時間計		222	92	314	29.3	4.9	1	97	3	100	3.0	5.8	2
12:00-12:15		58	12	70	17.1	1.1	0	29	2	31	6.5	1.8	0
12:15-12:30		56	35	91	38.5	1.4	1	22	1	23	4.3	1.3	0
12:30-12:45		64	21	85	24.7	1.3	0	24	0	24	0.0	1.4	0
12:45-13:00		71	24	95	25.3	1.5	0	19	3	22	13.6	1.3	0
1時間計		249	92	341	27.0	5.3	1	94	6	100	6.0	5.8	0
13:00-13:15		66	21	87	24.1	1.4	0	31	0	31	0.0	1.8	0
13:15-13:30		65	16	81	19.8	1.3	0	42	2	44	4.5	2.5	0
13:30-13:45		79	14	93	15.1	1.4	0	28	3	31	9.7	1.8	0
13:45-14:00		70	20	90	22.2	1.4	1	32	4	36	11.1	2.1	0
1時間計		280	71	351	20.2	5.5	1	133	9	142	6.3	8.2	0

方向別自動車交通量調査表

調査地点 : 地域社会3 上川井IC

調査年月日 : 令和元年10月13日(日) 天候:曇りのち雨

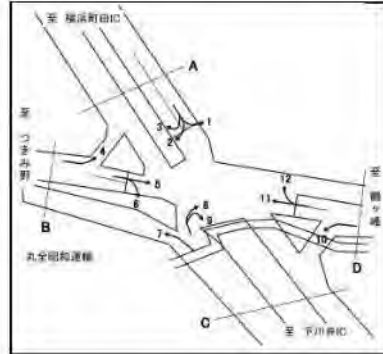

方向 種別 時間帯	7						8					
	小型車 (台)	大型車 (台)	合計 (台)	大型車 混入率 (%)	時間 係数 (%)	二輪車 (台)	小型車 (台)	大型車 (台)	合計 (台)	大型車 混入率 (%)	時間 係数 (%)	二輪車 (台)
14:00-14:15	90	17	107	15.9	1.7	1	29	6	35	17.1	2.0	0
14:15-14:30	73	21	94	22.3	1.5	2	35	1	36	2.8	2.1	0
14:30-14:45	53	13	66	19.7	1.0	0	30	6	36	16.7	2.1	0
14:45-15:00	54	23	77	29.9	1.2	0	35	2	37	5.4	2.1	1
1時間計	270	74	344	21.5	5.3	3	129	15	144	10.4	8.3	1
15:00-15:15	63	17	80	21.3	1.2	0	19	3	22	13.6	1.3	0
15:15-15:30	76	20	96	20.8	1.5	2	25	2	27	7.4	1.6	0
15:30-15:45	81	33	114	28.9	1.8	0	25	3	28	10.7	1.6	0
15:45-16:00	79	23	102	22.5	1.6	0	23	3	26	11.5	1.5	0
1時間計	299	93	392	23.7	6.1	2	92	11	103	10.7	5.9	0
16:00-16:15	82	21	103	20.4	1.6	3	24	2	26	7.7	1.5	0
16:15-16:30	74	31	105	29.5	1.6	0	30	3	33	9.1	1.9	0
16:30-16:45	96	17	113	15.0	1.8	1	17	4	21	19.0	1.2	0
16:45-17:00	69	17	86	19.8	1.3	0	29	2	31	6.5	1.8	0
1時間計	321	86	407	21.1	6.3	4	100	11	111	9.9	6.4	0
17:00-17:15	67	16	83	19.3	1.3	0	35	1	36	2.8	2.1	0
17:15-17:30	70	23	93	24.7	1.4	3	23	0	23	0.0	1.3	1
17:30-17:45	70	22	92	23.9	1.4	2	23	0	23	0.0	1.3	0
17:45-18:00	92	19	111	17.1	1.7	2	27	0	27	0.0	1.6	0
1時間計	299	80	379	21.1	5.9	7	108	1	109	0.9	6.3	1
18:00-18:15	94	16	110	14.5	1.7	1	20	2	22	9.1	1.3	0
18:15-18:30	88	13	101	12.9	1.6	1	26	3	29	10.3	1.7	0
18:30-18:45	85	18	103	17.5	1.6	0	25	1	26	3.8	1.5	0
18:45-19:00	73	5	78	6.4	1.2	0	17	1	18	5.6	1.0	0
1時間計	340	52	392	13.3	6.1	2	88	7	95	7.4	5.5	0
19:00-19:15	73	10	83	12.0	1.3	0	19	3	22	13.6	1.3	0
19:15-19:30	56	12	68	17.6	1.1	0	16	0	16	0.0	0.9	0
19:30-19:45	64	10	74	13.5	1.1	0	11	0	11	0.0	0.6	0
19:45-20:00	49	19	68	27.9	1.1	0	11	1	12	8.3	0.7	0
1時間計	242	51	293	17.4	4.6	0	57	4	61	6.6	3.5	0
20:00-20:15	60	9	69	13.0	1.1	0	11	0	11	0.0	0.6	1
20:15-20:30	47	12	59	20.3	0.9	0	14	2	16	12.5	0.9	0
20:30-20:45	52	12	64	18.8	1.0	0	22	1	23	4.3	1.3	0
20:45-21:00	43	15	58	25.9	0.9	1	8	0	8	0.0	0.5	0
1時間計	202	48	250	19.2	3.9	1	55	3	58	5.2	3.3	1
21:00-21:15	38	13	51	25.5	0.8	1	13	4	17	23.5	1.0	0
21:15-21:30	40	11	51	21.6	0.8	3	10	0	10	0.0	0.6	1
21:30-21:45	47	15	62	24.2	1.0	0	5	1	6	16.7	0.3	0
21:45-22:00	35	8	43	18.6	0.7	1	8	0	8	0.0	0.5	0
1時間計	160	47	207	22.7	3.2	5	36	5	41	12.2	2.4	1
昼12時間計	3377	1009	4386	23.0	68.1	32	1288	89	1377	6.5	79.2	7
夜12時間計	1468	582	2050	28.4	31.9	30	337	24	361	6.6	20.8	8
全時間合計	4845	1591	6436	24.7	100.0	62	1625	113	1738	6.5	100.0	15
昼夜率	1.43	1.58	1.47	-	-	1.94	1.26	1.27	1.26	-	-	2.14

方向別自動車交通量調査表

調査地点 : 地域社会3 上川井IC

調査年月日 : 令和元年10月13日(日) 天候:曇りのち雨

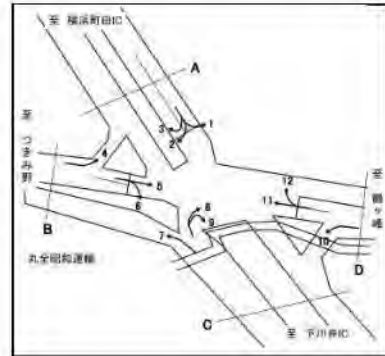

方向 種別 時間帯	9						C 合計 (7+ 8+ 9)					
	小型車 (台)	大型車 (台)	合計 (台)	大型車 混入率 (%)	時間 係数 (%)	二輪車 (台)	小型車 (台)	大型車 (台)	合計 (台)	大型車 混入率 (%)	時間 係数 (%)	二輪車 (台)
22:00-22:15	0	0	0	0.0	0.0	0	29	2	31	6.5	0.4	1
22:15-22:30	0	0	0	0.0	0.0	0	51	8	59	13.6	0.7	1
22:30-22:45	0	0	0	0.0	0.0	0	33	11	44	25.0	0.5	0
22:45-23:00	0	0	0	0.0	0.0	0	32	7	39	17.9	0.5	3
1時間計	0	0	0	0.0	0.0	0	145	28	173	16.2	2.1	5
23:00-23:15	0	0	0	0.0	0.0	0	54	8	62	12.9	0.8	1
23:15-23:30	0	0	0	0.0	0.0	0	31	7	38	18.4	0.5	0
23:30-23:45	0	0	0	0.0	0.0	0	28	10	38	26.3	0.5	0
23:45-24:00	0	0	0	0.0	0.0	0	30	8	38	21.1	0.5	2
1時間計	0	0	0	0.0	0.0	0	143	33	176	18.8	2.2	3
0:00- 0:15	0	0	0	0.0	0.0	0	32	7	39	17.9	0.5	3
0:15- 0:30	1	0	1	0.0	14.3	0	25	11	36	30.6	0.4	0
0:30- 0:45	0	0	0	0.0	0.0	0	30	15	45	33.3	0.6	0
0:45- 1:00	0	0	0	0.0	0.0	0	19	13	32	40.6	0.4	2
1時間計	1	0	1	0.0	14.3	0	106	46	152	30.3	1.9	5
1:00- 1:15	0	0	0	0.0	0.0	0	21	14	35	40.0	0.4	0
1:15- 1:30	0	0	0	0.0	0.0	0	13	11	24	45.8	0.3	2
1:30- 1:45	0	0	0	0.0	0.0	0	20	10	30	33.3	0.4	0
1:45- 2:00	0	0	0	0.0	0.0	0	15	10	25	40.0	0.3	2
1時間計	0	0	0	0.0	0.0	0	69	45	114	39.5	1.4	4
2:00- 2:15	0	0	0	0.0	0.0	0	20	15	35	42.9	0.4	0
2:15- 2:30	0	0	0	0.0	0.0	0	17	14	31	45.2	0.4	0
2:30- 2:45	0	0	0	0.0	0.0	0	11	15	26	57.7	0.3	0
2:45- 3:00	0	0	0	0.0	0.0	0	9	7	16	43.8	0.2	1
1時間計	0	0	0	0.0	0.0	0	57	51	108	47.2	1.3	1
3:00- 3:15	0	0	0	0.0	0.0	0	4	11	15	73.3	0.2	0
3:15- 3:30	0	0	0	0.0	0.0	0	14	12	26	46.2	0.3	0
3:30- 3:45	0	0	0	0.0	0.0	0	11	8	19	42.1	0.2	0
3:45- 4:00	0	0	0	0.0	0.0	0	18	13	31	41.9	0.4	0
1時間計	0	0	0	0.0	0.0	0	47	44	91	48.4	1.1	0
4:00- 4:15	0	0	0	0.0	0.0	0	10	11	21	52.4	0.3	0
4:15- 4:30	0	0	0	0.0	0.0	0	12	14	26	53.8	0.3	0
4:30- 4:45	0	0	0	0.0	0.0	0	14	15	29	51.7	0.4	2
4:45- 5:00	0	0	0	0.0	0.0	0	24	21	45	46.7	0.6	1
1時間計	0	0	0	0.0	0.0	0	60	61	121	50.4	1.5	3
5:00- 5:15	0	0	0	0.0	0.0	0	22	7	29	24.1	0.4	0
5:15- 5:30	0	0	0	0.0	0.0	0	29	19	48	39.6	0.6	0
5:30- 5:45	1	0	1	0.0	14.3	0	27	18	45	40.0	0.6	0
5:45- 6:00	1	0	1	0.0	14.3	0	53	26	79	32.9	1.0	1
1時間計	2	0	2	0.0	28.6	0	131	70	201	34.8	2.5	1

方向別自動車交通量調査表

調査地点 : 地域社会3 上川井IC

調査年月日 : 令和元年10月13日(日) 天候:曇りのち雨

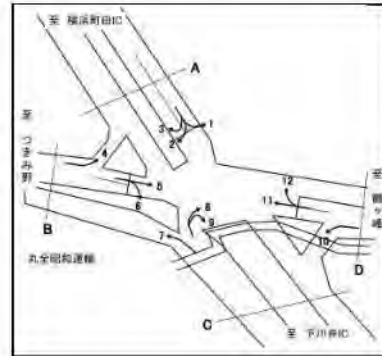

方向	9						C 合計 (7+ 8+ 9)						
	種別	小型車 (台)	大型車 (台)	合計 (台)	大型車 混入率 (%)	時間 係数 (%)	二輪車 (台)	小型車 (台)	大型車 (台)	合計 (台)	大型車 混入率 (%)	時間 係数 (%)	二輪車 (台)
6:00-6:15		0	0	0	0.0	0.0	0	62	14	76	18.4	0.9	3
6:15-6:30		0	0	0	0.0	0.0	0	72	22	94	23.4	1.1	0
6:30-6:45		0	0	0	0.0	0.0	0	85	19	104	18.3	1.3	2
6:45-7:00		0	0	0	0.0	0.0	0	79	15	94	16.0	1.1	3
1時間計		0	0	0	0.0	0.0	0	298	70	368	19.0	4.5	8
7:00-7:15		0	0	0	0.0	0.0	0	88	10	98	10.2	1.2	2
7:15-7:30		0	0	0	0.0	0.0	0	108	27	135	20.0	1.7	2
7:30-7:45		0	0	0	0.0	0.0	0	95	19	114	16.7	1.4	2
7:45-8:00		0	0	0	0.0	0.0	0	102	26	128	20.3	1.6	1
1時間計		0	0	0	0.0	0.0	0	393	82	475	17.3	5.8	7
8:00-8:15		0	0	0	0.0	0.0	0	125	27	152	17.8	1.9	1
8:15-8:30		0	0	0	0.0	0.0	0	91	24	115	20.9	1.4	3
8:30-8:45		0	0	0	0.0	0.0	0	73	19	92	20.7	1.1	1
8:45-9:00		0	0	0	0.0	0.0	0	106	10	116	8.6	1.4	1
1時間計		0	0	0	0.0	0.0	0	395	80	475	16.8	5.8	6
9:00-9:15		0	0	0	0.0	0.0	0	77	24	101	23.8	1.2	0
9:15-9:30		0	0	0	0.0	0.0	0	92	31	123	25.2	1.5	0
9:30-9:45		0	0	0	0.0	0.0	0	84	27	111	24.3	1.4	0
9:45-10:00		0	0	0	0.0	0.0	0	104	27	131	20.6	1.6	0
1時間計		0	0	0	0.0	0.0	0	357	109	466	23.4	5.7	0
10:00-10:15		0	0	0	0.0	0.0	0	92	39	131	29.8	1.6	1
10:15-10:30		0	0	0	0.0	0.0	0	107	30	137	21.9	1.7	0
10:30-10:45		0	0	0	0.0	0.0	0	106	31	137	22.6	1.7	0
10:45-11:00		0	0	0	0.0	0.0	0	94	24	118	20.3	1.4	0
1時間計		0	0	0	0.0	0.0	0	399	124	523	23.7	6.4	1
11:00-11:15		0	0	0	0.0	0.0	0	91	14	105	13.3	1.3	0
11:15-11:30		0	0	0	0.0	0.0	0	85	29	114	25.4	1.4	1
11:30-11:45		1	0	1	0.0	14.3	0	77	21	98	21.4	1.2	0
11:45-12:00		0	0	0	0.0	0.0	0	67	31	98	31.6	1.2	2
1時間計		1	0	1	0.0	14.3	0	320	95	415	22.9	5.1	3
12:00-12:15		0	0	0	0.0	0.0	0	87	14	101	13.9	1.2	0
12:15-12:30		0	0	0	0.0	0.0	0	78	36	114	31.6	1.4	1
12:30-12:45		0	0	0	0.0	0.0	0	88	21	109	19.3	1.3	0
12:45-13:00		0	0	0	0.0	0.0	0	90	27	117	23.1	1.4	0
1時間計		0	0	0	0.0	0.0	0	343	98	441	22.2	5.4	1
13:00-13:15		0	0	0	0.0	0.0	0	97	21	118	17.8	1.4	0
13:15-13:30		0	0	0	0.0	0.0	0	107	18	125	14.4	1.5	0
13:30-13:45		0	0	0	0.0	0.0	0	107	17	124	13.7	1.5	0
13:45-14:00		0	0	0	0.0	0.0	0	102	24	126	19.0	1.5	1
1時間計		0	0	0	0.0	0.0	0	413	80	493	16.2	6.0	1

方向別自動車交通量調査表

調査地点 : 地域社会3 上川井IC

調査年月日 : 令和元年10月13日(日) 天候:曇りのち雨

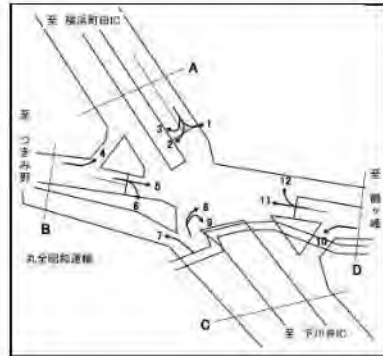

方向 種別 時間帯	9						C 合計 (7+ 8+ 9)					
	小型車 (台)	大型車 (台)	合計 (台)	大型車 混入率 (%)	時間 係数 (%)	二輪車 (台)	小型車 (台)	大型車 (台)	合計 (台)	大型車 混入率 (%)	時間 係数 (%)	二輪車 (台)
14:00-14:15	0	0	0	0.0	0.0	0	119	23	142	16.2	1.7	1
14:15-14:30	0	0	0	0.0	0.0	0	108	22	130	16.9	1.6	2
14:30-14:45	0	1	1	100.0	14.3	0	83	20	103	19.4	1.3	0
14:45-15:00	0	0	0	0.0	0.0	0	89	25	114	21.9	1.4	1
1時間計	0	1	1	100.0	14.3	0	399	90	489	18.4	6.0	4
15:00-15:15	0	0	0	0.0	0.0	0	82	20	102	19.6	1.2	0
15:15-15:30	0	0	0	0.0	0.0	0	101	22	123	17.9	1.5	2
15:30-15:45	0	0	0	0.0	0.0	0	106	36	142	25.4	1.7	0
15:45-16:00	0	0	0	0.0	0.0	0	102	26	128	20.3	1.6	0
1時間計	0	0	0	0.0	0.0	0	391	104	495	21.0	6.1	2
16:00-16:15	0	0	0	0.0	0.0	0	106	23	129	17.8	1.6	3
16:15-16:30	0	0	0	0.0	0.0	0	104	34	138	24.6	1.7	0
16:30-16:45	0	0	0	0.0	0.0	0	113	21	134	15.7	1.6	1
16:45-17:00	0	0	0	0.0	0.0	0	98	19	117	16.2	1.4	0
1時間計	0	0	0	0.0	0.0	0	421	97	518	18.7	6.3	4
17:00-17:15	0	0	0	0.0	0.0	0	102	17	119	14.3	1.5	0
17:15-17:30	0	0	0	0.0	0.0	0	93	23	116	19.8	1.4	4
17:30-17:45	0	0	0	0.0	0.0	0	93	22	115	19.1	1.4	2
17:45-18:00	0	0	0	0.0	0.0	0	119	19	138	13.8	1.7	2
1時間計	0	0	0	0.0	0.0	0	407	81	488	16.6	6.0	8
18:00-18:15	0	0	0	0.0	0.0	0	114	18	132	13.6	1.6	1
18:15-18:30	0	0	0	0.0	0.0	0	114	16	130	12.3	1.6	1
18:30-18:45	0	0	0	0.0	0.0	0	110	19	129	14.7	1.6	0
18:45-19:00	0	0	0	0.0	0.0	0	90	6	96	6.3	1.2	0
1時間計	0	0	0	0.0	0.0	0	428	59	487	12.1	6.0	2
19:00-19:15	0	0	0	0.0	0.0	0	92	13	105	12.4	1.3	0
19:15-19:30	0	0	0	0.0	0.0	0	72	12	84	14.3	1.0	0
19:30-19:45	0	0	0	0.0	0.0	0	75	10	85	11.8	1.0	0
19:45-20:00	0	0	0	0.0	0.0	0	60	20	80	25.0	1.0	0
1時間計	0	0	0	0.0	0.0	0	299	55	354	15.5	4.3	0
20:00-20:15	0	0	0	0.0	0.0	0	71	9	80	11.3	1.0	1
20:15-20:30	2	0	2	0.0	28.6	0	63	14	77	18.2	0.9	0
20:30-20:45	0	0	0	0.0	0.0	0	74	13	87	14.9	1.1	0
20:45-21:00	0	0	0	0.0	0.0	0	51	15	66	22.7	0.8	1
1時間計	2	0	2	0.0	28.6	0	259	51	310	16.5	3.8	2
21:00-21:15	0	0	0	0.0	0.0	0	51	17	68	25.0	0.8	1
21:15-21:30	0	0	0	0.0	0.0	0	50	11	61	18.0	0.7	4
21:30-21:45	0	0	0	0.0	0.0	0	52	16	68	23.5	0.8	0
21:45-22:00	0	0	0	0.0	0.0	0	43	8	51	15.7	0.6	1
1時間計	0	0	0	0.0	0.0	0	196	52	248	21.0	3.0	6
昼12時間計	1	1	2	50.0	28.6	0	4666	1099	5765	19.1	70.5	39
夜12時間計	5	0	5	0.0	71.4	0	1810	606	2416	25.1	29.5	38
全時間合計	6	1	7	14.3	100.0	0	6476	1705	8181	20.8	100.0	77
昼夜率	6.00	1.00	3.50	-	-	0.00	1.39	1.55	1.42	-	-	1.97

方向別自動車交通量調査表

調査地点 : 地域社会3 上川井IC

調査年月日 : 令和元年10月13日(日) 天候:曇りのち雨



方向 種別 時間帯	10						11					
	小型車 (台)	大型車 (台)	合計 (台)	大型車 混入率 (%)	時間 係数 (%)	二輪車 (台)	小型車 (台)	大型車 (台)	合計 (台)	大型車 混入率 (%)	時間 係数 (%)	二輪車 (台)
22:00-22:15	2	0	2	0.0	0.1	0	25	2	27	7.4	0.8	3
22:15-22:30	4	0	4	0.0	0.3	0	24	1	25	4.0	0.7	2
22:30-22:45	5	0	5	0.0	0.4	0	16	2	18	11.1	0.5	2
22:45-23:00	5	0	5	0.0	0.4	0	22	4	26	15.4	0.8	2
1時間計	16	0	16	0.0	1.2	0	87	9	96	9.4	2.8	9
23:00-23:15	1	0	1	0.0	0.1	0	11	6	17	35.3	0.5	2
23:15-23:30	2	0	2	0.0	0.1	0	11	2	13	15.4	0.4	4
23:30-23:45	2	0	2	0.0	0.1	0	10	4	14	28.6	0.4	1
23:45-24:00	2	0	2	0.0	0.1	0	7	3	10	30.0	0.3	1
1時間計	7	0	7	0.0	0.5	0	39	15	54	27.8	1.6	8
0:00-0:15	3	0	3	0.0	0.2	0	13	6	19	31.6	0.5	2
0:15-0:30	5	0	5	0.0	0.4	0	14	5	19	26.3	0.5	1
0:30-0:45	3	1	4	25.0	0.3	0	12	4	16	25.0	0.5	2
0:45-1:00	3	1	4	25.0	0.3	0	8	3	11	27.3	0.3	1
1時間計	14	2	16	12.5	1.2	0	47	18	65	27.7	1.9	6
1:00-1:15	4	0	4	0.0	0.3	0	11	1	12	8.3	0.3	3
1:15-1:30	1	0	1	0.0	0.1	0	8	2	10	20.0	0.3	3
1:30-1:45	0	0	0	0.0	0.0	0	5	3	8	37.5	0.2	2
1:45-2:00	2	0	2	0.0	0.1	1	1	4	5	80.0	0.1	2
1時間計	7	0	7	0.0	0.5	1	25	10	35	28.6	1.0	10
2:00-2:15	0	0	0	0.0	0.0	0	5	2	7	28.6	0.2	0
2:15-2:30	3	0	3	0.0	0.2	0	3	0	3	0.0	0.1	0
2:30-2:45	2	0	2	0.0	0.1	0	1	1	2	50.0	0.1	1
2:45-3:00	0	0	0	0.0	0.0	0	3	1	4	25.0	0.1	3
1時間計	5	0	5	0.0	0.4	0	12	4	16	25.0	0.5	4
3:00-3:15	1	0	1	0.0	0.1	0	5	1	6	16.7	0.2	2
3:15-3:30	1	1	2	50.0	0.1	0	4	7	11	63.6	0.3	0
3:30-3:45	1	0	1	0.0	0.1	0	5	12	17	70.6	0.5	0
3:45-4:00	0	0	0	0.0	0.0	0	4	0	4	0.0	0.1	1
1時間計	3	1	4	25.0	0.3	0	18	20	38	52.6	1.1	3
4:00-4:15	2	0	2	0.0	0.1	0	3	5	8	62.5	0.2	0
4:15-4:30	2	0	2	0.0	0.1	0	6	5	11	45.5	0.3	1
4:30-4:45	1	1	2	50.0	0.1	0	2	3	5	60.0	0.1	0
4:45-5:00	2	0	2	0.0	0.1	0	9	5	14	35.7	0.4	1
1時間計	7	1	8	12.5	0.6	0	20	18	38	47.4	1.1	2
5:00-5:15	2	1	3	33.3	0.2	0	8	5	13	38.5	0.4	0
5:15-5:30	5	0	5	0.0	0.4	0	11	4	15	26.7	0.4	4
5:30-5:45	4	2	6	33.3	0.4	1	12	4	16	25.0	0.5	3
5:45-6:00	8	2	10	20.0	0.7	0	22	2	24	8.3	0.7	1
1時間計	19	5	24	20.8	1.8	1	53	15	68	22.1	2.0	8

方向別自動車交通量調査表

調査地点 : 地域社会3 上川井IC

調査年月日 : 令和元年10月13日(日) 天候:曇りのち雨

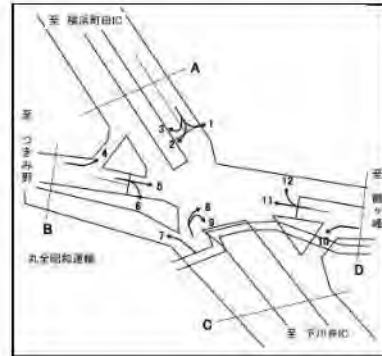

方向 時間帯	10						11					
	種別 小型車 (台)	大型車 (台)	合計 (台)	大型車 混入率 (%)	時間 係数 (%)	二輪車 (台)	小型車 (台)	大型車 (台)	合計 (台)	大型車 混入率 (%)	時間 係数 (%)	二輪車 (台)
6:00-6:15	15	1	16	6.3	1.2	0	34	3	37	8.1	1.1	1
6:15-6:30	9	4	13	30.8	1.0	0	31	3	34	8.8	1.0	0
6:30-6:45	18	1	19	5.3	1.4	1	27	8	35	22.9	1.0	8
6:45-7:00	22	4	26	15.4	1.9	0	25	5	30	16.7	0.9	5
1時間計	64	10	74	13.5	5.5	1	117	19	136	14.0	3.9	14
7:00-7:15	16	1	17	5.9	1.3	1	35	7	42	16.7	1.2	1
7:15-7:30	20	0	20	0.0	1.5	1	44	8	52	15.4	1.5	4
7:30-7:45	22	0	22	0.0	1.6	2	40	7	47	14.9	1.4	11
7:45-8:00	15	1	16	6.3	1.2	0	57	5	62	8.1	1.8	2
1時間計	73	2	75	2.7	5.6	4	176	27	203	13.3	5.9	18
8:00-8:15	23	3	26	11.5	1.9	1	46	5	51	9.8	1.5	3
8:15-8:30	19	3	22	13.6	1.6	0	53	9	62	14.5	1.8	4
8:30-8:45	21	1	22	4.5	1.6	2	47	4	51	7.8	1.5	10
8:45-9:00	17	4	21	19.0	1.6	0	54	7	61	11.5	1.8	2
1時間計	80	11	91	12.1	6.8	3	200	25	225	11.1	6.5	19
9:00-9:15	13	5	18	27.8	1.3	0	50	5	55	9.1	1.6	6
9:15-9:30	28	1	29	3.4	2.2	0	49	9	58	15.5	1.7	2
9:30-9:45	24	3	27	11.1	2.0	0	62	2	64	3.1	1.9	5
9:45-10:00	17	1	18	5.6	1.3	1	61	6	67	9.0	1.9	1
1時間計	82	10	92	10.9	6.9	1	222	22	244	9.0	7.1	14
10:00-10:15	19	1	20	5.0	1.5	0	60	5	65	7.7	1.9	3
10:15-10:30	21	1	22	4.5	1.6	0	49	5	54	9.3	1.6	4
10:30-10:45	16	1	17	5.9	1.3	0	34	5	39	12.8	1.1	4
10:45-11:00	26	2	28	7.1	2.1	0	58	7	65	10.8	1.9	1
1時間計	82	5	87	5.7	6.5	0	201	22	223	9.9	6.5	12
11:00-11:15	16	1	17	5.9	1.3	0	54	7	61	11.5	1.8	1
11:15-11:30	21	0	21	0.0	1.6	0	41	5	46	10.9	1.3	0
11:30-11:45	23	0	23	0.0	1.7	0	63	8	71	11.3	2.1	5
11:45-12:00	13	1	14	7.1	1.0	0	41	6	47	12.8	1.4	3
1時間計	73	2	75	2.7	5.6	0	199	26	225	11.6	6.5	9
12:00-12:15	21	3	24	12.5	1.8	0	44	6	50	12.0	1.4	0
12:15-12:30	11	3	14	21.4	1.0	0	57	7	64	10.9	1.9	2
12:30-12:45	19	2	21	9.5	1.6	0	45	4	49	8.2	1.4	3
12:45-13:00	19	2	21	9.5	1.6	0	31	6	37	16.2	1.1	1
1時間計	70	10	80	12.5	6.0	0	177	23	200	11.5	5.8	6
13:00-13:15	30	1	31	3.2	2.3	0	50	10	60	16.7	1.7	1
13:15-13:30	11	2	13	15.4	1.0	0	41	4	45	8.9	1.3	0
13:30-13:45	24	1	25	4.0	1.9	1	43	1	44	2.3	1.3	4
13:45-14:00	20	2	22	9.1	1.6	0	45	2	47	4.3	1.4	2
1時間計	85	6	91	6.6	6.8	1	179	17	196	8.7	5.7	7

方向別自動車交通量調査表

調査地点 : 地域社会3 上川井IC

調査年月日 : 令和元年10月13日(日) 天候:曇りのち雨

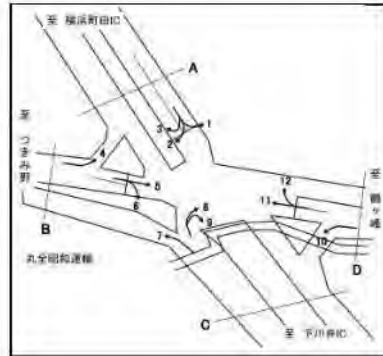

方向 種別 時間帯	10						11					
	小型車 (台)	大型車 (台)	合計 (台)	大型車 混入率 (%)	時間 係数 (%)	二輪車 (台)	小型車 (台)	大型車 (台)	合計 (台)	大型車 混入率 (%)	時間 係数 (%)	二輪車 (台)
14:00-14:15	27	2	29	6.9	2.2	0	43	6	49	12.2	1.4	0
14:15-14:30	15	2	17	11.8	1.3	0	36	6	42	14.3	1.2	0
14:30-14:45	17	0	17	0.0	1.3	0	41	3	44	6.8	1.3	1
14:45-15:00	16	2	18	11.1	1.3	0	42	4	46	8.7	1.3	2
1時間計	75	6	81	7.4	6.0	0	162	19	181	10.5	5.2	3
15:00-15:15	33	1	34	2.9	2.5	0	54	5	59	8.5	1.7	2
15:15-15:30	37	1	38	2.6	2.8	0	42	5	47	10.6	1.4	1
15:30-15:45	16	1	17	5.9	1.3	0	49	6	55	10.9	1.6	2
15:45-16:00	20	1	21	4.8	1.6	0	36	5	41	12.2	1.2	1
1時間計	106	4	110	3.6	8.2	0	181	21	202	10.4	5.8	6
16:00-16:15	20	2	22	9.1	1.6	0	34	2	36	5.6	1.0	3
16:15-16:30	15	2	17	11.8	1.3	0	46	6	52	11.5	1.5	3
16:30-16:45	33	1	34	2.9	2.5	1	45	6	51	11.8	1.5	3
16:45-17:00	17	0	17	0.0	1.3	0	49	2	51	3.9	1.5	2
1時間計	85	5	90	5.6	6.7	1	174	16	190	8.4	5.5	11
17:00-17:15	30	0	30	0.0	2.2	0	50	5	55	9.1	1.6	2
17:15-17:30	22	2	24	8.3	1.8	1	55	6	61	9.8	1.8	5
17:30-17:45	27	0	27	0.0	2.0	0	47	6	53	11.3	1.5	5
17:45-18:00	21	0	21	0.0	1.6	0	48	1	49	2.0	1.4	3
1時間計	100	2	102	2.0	7.6	1	200	18	218	8.3	6.3	15
18:00-18:15	22	1	23	4.3	1.7	0	58	4	62	6.5	1.8	8
18:15-18:30	19	1	20	5.0	1.5	0	58	4	62	6.5	1.8	3
18:30-18:45	14	0	14	0.0	1.0	1	65	3	68	4.4	2.0	3
18:45-19:00	11	0	11	0.0	0.8	0	28	4	32	12.5	0.9	2
1時間計	66	2	68	2.9	5.1	1	209	15	224	6.7	6.5	16
19:00-19:15	18	0	18	0.0	1.3	0	30	2	32	6.3	0.9	6
19:15-19:30	17	1	18	5.6	1.3	0	35	5	40	12.5	1.2	4
19:30-19:45	12	0	12	0.0	0.9	0	30	2	32	6.3	0.9	2
19:45-20:00	14	2	16	12.5	1.2	0	37	2	39	5.1	1.1	2
1時間計	61	3	64	4.7	4.8	0	132	11	143	7.7	4.1	14
20:00-20:15	9	0	9	0.0	0.7	1	28	5	33	15.2	1.0	3
20:15-20:30	7	0	7	0.0	0.5	0	28	3	31	9.7	0.9	1
20:30-20:45	10	0	10	0.0	0.7	0	36	4	40	10.0	1.2	1
20:45-21:00	13	0	13	0.0	1.0	0	23	2	25	8.0	0.7	1
1時間計	39	0	39	0.0	2.9	1	115	14	129	10.9	3.7	6
21:00-21:15	20	0	20	0.0	1.5	0	28	2	30	6.7	0.9	3
21:15-21:30	5	0	5	0.0	0.4	0	38	1	39	2.6	1.1	3
21:30-21:45	5	0	5	0.0	0.4	0	16	2	18	11.1	0.5	3
21:45-22:00	5	0	5	0.0	0.4	0	17	4	21	19.0	0.6	3
1時間計	35	0	35	0.0	2.6	0	99	9	108	8.3	3.1	12
昼12時間計	977	65	1042	6.2	77.7	12	2280	251	2531	9.9	73.2	136
夜12時間計	277	22	299	7.4	22.3	4	764	162	926	17.5	26.8	96
全時間合計	1254	87	1341	6.5	100.0	16	3044	413	3457	11.9	100.0	232
昼 夜 率	1.28	1.34	1.29	-	-	1.33	1.34	1.65	1.37	-	-	1.71

方向別自動車交通量調査表

調査地点 : 地域社会3 上川井IC

調査年月日 : 令和元年10月13日(日) 天候:曇りのち雨

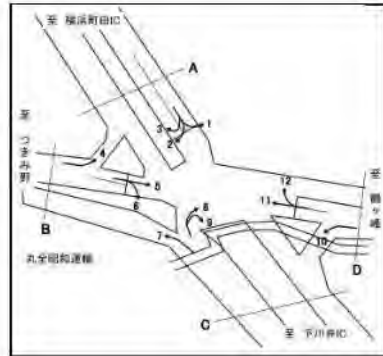

方向	12						D 合計 (10+11+12)					
	種別 時間帯	小型車 (台)	大型車 (台)	合計 (台)	大型車 混入率 (%)	時間 係数 (%)	二輪車 (台)	小型車 (台)	大型車 (台)	合計 (台)	大型車 混入率 (%)	時間 係数 (%)
22:00-22:15	11	1	12	8.3	0.6	1	38	3	41	7.3	0.6	4
22:15-22:30	19	1	20	5.0	0.9	1	47	2	49	4.1	0.7	3
22:30-22:45	9	0	9	0.0	0.4	1	30	2	32	6.3	0.5	3
22:45-23:00	10	0	10	0.0	0.5	0	37	4	41	9.8	0.6	2
1時間計	49	2	51	3.9	2.4	3	152	11	163	6.7	2.3	12
23:00-23:15	8	1	9	11.1	0.4	2	20	7	27	25.9	0.4	4
23:15-23:30	7	0	7	0.0	0.3	3	20	2	22	9.1	0.3	7
23:30-23:45	10	2	12	16.7	0.6	1	22	6	28	21.4	0.4	2
23:45-24:00	5	1	6	16.7	0.3	2	14	4	18	22.2	0.3	3
1時間計	30	4	34	11.8	1.6	8	76	19	95	20.0	1.4	16
0:00-0:15	13	1	14	7.1	0.6	1	29	7	36	19.4	0.5	3
0:15-0:30	3	0	3	0.0	0.1	2	22	5	27	18.5	0.4	3
0:30-0:45	3	1	4	25.0	0.2	0	18	6	24	25.0	0.3	2
0:45-1:00	4	0	4	0.0	0.2	1	15	4	19	21.1	0.3	2
1時間計	23	2	25	8.0	1.2	4	84	22	106	20.8	1.5	10
1:00-1:15	4	0	4	0.0	0.2	2	19	1	20	5.0	0.3	5
1:15-1:30	5	0	5	0.0	0.2	0	14	2	16	12.5	0.2	3
1:30-1:45	4	0	4	0.0	0.2	0	9	3	12	25.0	0.2	2
1:45-2:00	4	0	4	0.0	0.2	0	7	4	11	36.4	0.2	3
1時間計	17	0	17	0.0	0.8	2	49	10	59	16.9	0.8	13
2:00-2:15	3	1	4	25.0	0.2	1	8	3	11	27.3	0.2	1
2:15-2:30	2	0	2	0.0	0.1	0	8	0	8	0.0	0.1	0
2:30-2:45	0	0	0	0.0	0.0	0	3	1	4	25.0	0.1	1
2:45-3:00	2	1	3	33.3	0.1	0	5	2	7	28.6	0.1	3
1時間計	7	2	9	22.2	0.4	1	24	6	30	20.0	0.4	5
3:00-3:15	1	1	2	50.0	0.1	0	7	2	9	22.2	0.1	2
3:15-3:30	4	1	5	20.0	0.2	1	9	9	18	50.0	0.3	1
3:30-3:45	2	0	2	0.0	0.1	0	8	12	20	60.0	0.3	0
3:45-4:00	4	1	5	20.0	0.2	2	8	1	9	11.1	0.1	3
1時間計	11	3	14	21.4	0.6	3	32	24	56	42.9	0.8	6
4:00-4:15	3	3	6	50.0	0.3	0	8	8	16	50.0	0.2	0
4:15-4:30	3	0	3	0.0	0.1	0	11	5	16	31.3	0.2	1
4:30-4:45	4	2	6	33.3	0.3	0	7	6	13	46.2	0.2	0
4:45-5:00	4	1	5	20.0	0.2	1	15	6	21	28.6	0.3	2
1時間計	14	6	20	30.0	0.9	1	41	25	66	37.9	0.9	3
5:00-5:15	9	3	12	25.0	0.6	1	19	9	28	32.1	0.4	1
5:15-5:30	6	4	10	40.0	0.5	0	22	8	30	26.7	0.4	4
5:30-5:45	11	5	16	31.3	0.7	2	27	11	38	28.9	0.5	6
5:45-6:00	18	4	22	18.2	1.0	1	48	8	56	14.3	0.8	2
1時間計	44	16	60	26.7	2.8	4	116	36	152	23.7	2.2	13

方向別自動車交通量調査表

調査地点 : 地域社会3 上川井IC

調査年月日 : 令和元年10月13日(日) 天候:曇りのち雨

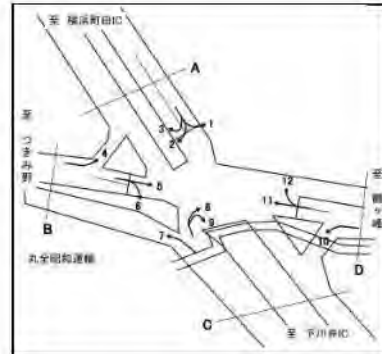

方向 時間帯	12						D 合計 (10+11+12)					
	種別 小型車 (台)	大型車 (台)	合計 (台)	大型車 混入率 (%)	時間 係数 (%)	二輪車 (台)	小型車 (台)	大型車 (台)	合計 (台)	大型車 混入率 (%)	時間 係数 (%)	二輪車 (台)
6:00-6:15	17	14	31	45.2	1.4	3	66	18	84	21.4	1.2	4
6:15-6:30	25	1	26	3.8	1.2	1	65	8	73	11.0	1.0	1
6:30-6:45	26	6	32	18.8	1.5	3	71	15	86	17.4	1.2	12
6:45-7:00	21	7	28	25.0	1.3	7	68	16	84	19.0	1.2	12
1時間計	89	28	117	23.9	5.4	14	270	57	327	17.4	4.7	29
7:00-7:15	28	13	41	31.7	1.9	9	79	21	100	21.0	1.4	11
7:15-7:30	35	11	46	23.9	2.1	1	99	19	118	16.1	1.7	6
7:30-7:45	35	5	40	12.5	1.9	7	97	12	109	11.0	1.6	20
7:45-8:00	27	5	32	15.6	1.5	5	99	11	110	10.0	1.6	7
1時間計	125	34	159	21.4	7.4	22	374	63	437	14.4	6.3	44
8:00-8:15	27	1	28	3.6	1.3	1	96	9	105	8.6	1.5	5
8:15-8:30	29	5	34	14.7	1.6	3	101	17	118	14.4	1.7	7
8:30-8:45	41	5	46	10.9	2.1	2	109	10	119	8.4	1.7	14
8:45-9:00	30	4	34	11.8	1.6	2	101	15	116	12.9	1.7	4
1時間計	127	15	142	10.6	6.6	8	407	51	458	11.1	6.6	30
9:00-9:15	31	4	35	11.4	1.6	4	94	14	108	13.0	1.6	10
9:15-9:30	24	4	28	14.3	1.3	5	101	14	115	12.2	1.7	7
9:30-9:45	24	4	28	14.3	1.3	4	110	9	119	7.6	1.7	9
9:45-10:00	27	11	38	28.9	1.8	2	105	18	123	14.6	1.8	4
1時間計	106	23	129	17.8	6.0	15	410	55	465	11.8	6.7	30
10:00-10:15	25	7	32	21.9	1.5	3	104	13	117	11.1	1.7	6
10:15-10:30	25	2	27	7.4	1.3	2	95	8	103	7.8	1.5	6
10:30-10:45	31	2	33	6.1	1.5	1	81	8	89	9.0	1.3	5
10:45-11:00	35	4	39	10.3	1.8	1	119	13	132	9.8	1.9	2
1時間計	116	15	131	11.5	6.1	7	399	42	441	9.5	6.3	19
11:00-11:15	20	6	26	23.1	1.2	0	90	14	104	13.5	1.5	1
11:15-11:30	18	2	20	10.0	0.9	1	80	7	87	8.0	1.3	1
11:30-11:45	29	6	35	17.1	1.6	0	115	14	129	10.9	1.9	5
11:45-12:00	29	3	32	9.4	1.5	3	83	10	93	10.8	1.3	6
1時間計	96	17	113	15.0	5.2	4	368	45	413	10.9	5.9	13
12:00-12:15	20	4	24	16.7	1.1	0	85	13	98	13.3	1.4	0
12:15-12:30	31	4	35	11.4	1.6	1	99	14	113	12.4	1.6	3
12:30-12:45	30	1	31	3.2	1.4	0	94	7	101	6.9	1.5	3
12:45-13:00	23	7	30	23.3	1.4	3	73	15	88	17.0	1.3	4
1時間計	104	16	120	13.3	5.6	4	351	49	400	12.3	5.7	10
13:00-13:15	23	1	24	4.2	1.1	1	103	12	115	10.4	1.7	2
13:15-13:30	28	5	33	15.2	1.5	0	80	11	91	12.1	1.3	0
13:30-13:45	30	7	37	18.9	1.7	0	97	9	106	8.5	1.5	5
13:45-14:00	24	3	27	11.1	1.3	0	89	7	96	7.3	1.4	2
1時間計	105	16	121	13.2	5.6	1	369	39	408	9.6	5.9	9

方向別自動車交通量調査表

調査地点 : 地域社会3 上川井IC

調査年月日 : 令和元年10月13日(日) 天候:曇りのち雨

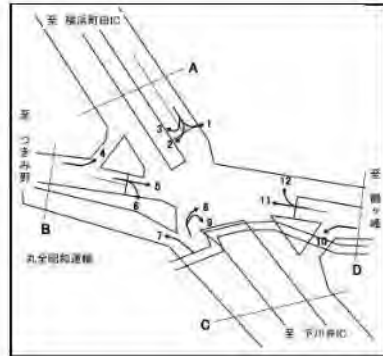

方向 種別 時間帯	12						D 合計 (10+11+12)					
	小型車 (台)	大型車 (台)	合計 (台)	大型車 混入率 (%)	時間 係数 (%)	二輪車 (台)	小型車 (台)	大型車 (台)	合計 (台)	大型車 混入率 (%)	時間 係数 (%)	二輪車 (台)
14:00-14:15	39	2	41	4.9	1.9	0	109	10	119	8.4	1.7	0
14:15-14:30	30	8	38	21.1	1.8	0	81	16	97	16.5	1.4	0
14:30-14:45	31	1	32	3.1	1.5	2	89	4	93	4.3	1.3	3
14:45-15:00	29	3	32	9.4	1.5	1	87	9	96	9.4	1.4	3
1時間計	129	14	143	9.8	6.6	3	366	39	405	9.6	5.8	6
15:00-15:15	32	5	37	13.5	1.7	4	119	11	130	8.5	1.9	6
15:15-15:30	29	3	32	9.4	1.5	0	108	9	117	7.7	1.7	1
15:30-15:45	30	1	31	3.2	1.4	3	95	8	103	7.8	1.5	5
15:45-16:00	33	1	34	2.9	1.6	2	89	7	96	7.3	1.4	3
1時間計	124	10	134	7.5	6.2	9	411	35	446	7.8	6.4	15
16:00-16:15	36	4	40	10.0	1.9	2	90	8	98	8.2	1.4	5
16:15-16:30	28	4	32	12.5	1.5	2	89	12	101	11.9	1.5	5
16:30-16:45	37	5	42	11.9	1.9	1	115	12	127	9.4	1.8	5
16:45-17:00	35	1	36	2.8	1.7	4	101	3	104	2.9	1.5	6
1時間計	136	14	150	9.3	6.9	9	395	35	430	8.1	6.2	21
17:00-17:15	24	5	29	17.2	1.3	5	104	10	114	8.8	1.6	7
17:15-17:30	39	2	41	4.9	1.9	6	116	10	126	7.9	1.8	12
17:30-17:45	34	2	36	5.6	1.7	1	108	8	116	6.9	1.7	6
17:45-18:00	28	1	29	3.4	1.3	3	97	2	99	2.0	1.4	6
1時間計	125	10	135	7.4	6.3	15	425	30	455	6.6	6.5	31
18:00-18:15	35	2	37	5.4	1.7	2	115	7	122	5.7	1.8	10
18:15-18:30	34	4	38	10.5	1.8	2	111	9	120	7.5	1.7	5
18:30-18:45	30	2	32	6.3	1.5	2	109	5	114	4.4	1.6	6
18:45-19:00	21	3	24	12.5	1.1	4	60	7	67	10.4	1.0	6
1時間計	120	11	131	8.4	6.1	10	395	28	423	6.6	6.1	27
19:00-19:15	22	1	23	4.3	1.1	1	70	3	73	4.1	1.0	7
19:15-19:30	19	3	22	13.6	1.0	1	71	9	80	11.3	1.1	5
19:30-19:45	14	3	17	17.6	0.8	2	56	5	61	8.2	0.9	4
19:45-20:00	26	1	27	3.7	1.3	4	77	5	82	6.1	1.2	6
1時間計	81	8	89	9.0	4.1	8	274	22	296	7.4	4.3	22
20:00-20:15	15	0	15	0.0	0.7	1	52	5	57	8.8	0.8	5
20:15-20:30	13	3	16	18.8	0.7	0	48	6	54	11.1	0.8	1
20:30-20:45	15	4	19	21.1	0.9	2	61	8	69	11.6	1.0	3
20:45-21:00	12	0	12	0.0	0.6	3	48	2	50	4.0	0.7	4
1時間計	55	7	62	11.3	2.9	6	209	21	230	9.1	3.3	13
21:00-21:15	12	0	12	0.0	0.6	1	60	2	62	3.2	0.9	4
21:15-21:30	15	0	15	0.0	0.7	0	58	1	59	1.7	0.8	3
21:30-21:45	13	5	18	27.8	0.8	2	34	7	41	17.1	0.6	5
21:45-22:00	9	0	9	0.0	0.4	2	31	4	35	11.4	0.5	5
1時間計	49	5	54	9.3	2.5	5	183	14	197	7.1	2.8	17
昼12時間計	1413	195	1608	12.1	74.4	107	4670	511	5181	9.9	74.5	255
夜12時間計	469	83	552	15.0	25.6	59	1510	267	1777	15.0	25.5	159
全時間合計	1882	278	2160	12.9	100.0	166	6180	778	6958	11.2	100.0	414
昼 夜 率	1.33	1.43	1.34	-	-	1.55	1.32	1.52	1.34	-	-	1.62

方向別自動車交通量調査表

調査地点：地域社会4 滝沢

調査年月日：令和2年9月21日(月・祝) 天候：曇りのち晴れ



方向 時間帯	1						2					
	種別 小型車 (台)	大型車 (台)	合計 (台)	大型車 混入率 (%)	時間 係数 (%)	二輪車 (台)	小型車 (台)	大型車 (台)	合計 (台)	大型車 混入率 (%)	時間 係数 (%)	二輪車 (台)
7:00-7:15	21	4	25	16.0	1.0	0	69	15	84	17.9	1.0	9
7:15-7:30	28	4	32	12.5	1.3	3	84	13	97	13.4	1.1	9
7:30-7:45	33	2	35	5.7	1.4	2	97	14	111	12.6	1.3	5
7:45-8:00	30	1	31	3.2	1.2	0	117	10	127	7.9	1.5	5
1時間計	112	11	123	8.9	4.9	5	367	52	419	12.4	4.9	28
8:00-8:15	33	2	35	5.7	1.4	2	147	15	162	9.3	1.9	14
8:15-8:30	39	3	42	7.1	1.7	1	128	18	146	12.3	1.7	9
8:30-8:45	42	6	48	12.5	1.9	0	151	10	161	6.2	1.9	5
8:45-9:00	51	3	54	5.6	2.1	1	163	17	180	9.4	2.1	12
1時間計	165	14	179	7.8	7.1	4	589	60	649	9.2	7.7	40
9:00-9:15	43	2	45	4.4	1.8	1	131	18	149	12.1	1.8	11
9:15-9:30	60	0	60	0.0	2.4	0	140	19	159	11.9	1.9	20
9:30-9:45	48	4	52	7.7	2.1	3	153	13	166	7.8	2.0	9
9:45-10:00	35	2	37	5.4	1.5	1	110	10	120	8.3	1.4	5
1時間計	186	8	194	4.1	7.7	5	534	60	594	10.1	7.0	45
10:00-10:15	30	3	33	9.1	1.3	4	105	6	111	5.4	1.3	3
10:15-10:30	31	1	32	3.1	1.3	0	125	12	137	8.8	1.6	9
10:30-10:45	43	1	44	2.3	1.7	3	135	18	153	11.8	1.8	8
10:45-11:00	21	0	21	0.0	0.8	1	128	15	143	10.5	1.7	7
1時間計	125	5	130	3.8	5.2	8	493	51	544	9.4	6.4	27
11:00-11:15	27	2	29	6.9	1.2	0	117	19	136	14.0	1.6	7
11:15-11:30	17	0	17	0.0	0.7	2	94	15	109	13.8	1.3	4
11:30-11:45	32	2	34	5.9	1.3	1	115	25	140	17.9	1.7	3
11:45-12:00	32	5	37	13.5	1.5	4	180	22	202	10.9	2.4	13
1時間計	108	9	117	7.7	4.6	7	506	81	587	13.8	6.9	27
12:00-12:15	33	2	35	5.7	1.4	1	127	21	148	14.2	1.7	7
12:15-12:30	37	1	38	2.6	1.5	1	158	24	182	13.2	2.1	13
12:30-12:45	53	4	57	7.0	2.3	2	173	20	193	10.4	2.3	4
12:45-13:00	38	1	39	2.6	1.5	1	153	18	171	10.5	2.0	8
1時間計	161	8	169	4.7	6.7	5	611	83	694	12.0	8.2	32
13:00-13:15	46	4	50	8.0	2.0	1	181	17	198	8.6	2.3	7
13:15-13:30	49	2	51	3.9	2.0	0	172	18	190	9.5	2.2	7
13:30-13:45	39	0	39	0.0	1.5	3	140	16	156	10.3	1.8	9
13:45-14:00	37	0	37	0.0	1.5	1	140	19	159	11.9	1.9	4
1時間計	171	6	177	3.4	7.0	5	633	70	703	10.0	8.3	27
14:00-14:15	45	3	48	6.3	1.9	1	147	20	167	12.0	2.0	11
14:15-14:30	44	3	47	6.4	1.9	3	150	21	171	12.3	2.0	6
14:30-14:45	33	2	35	5.7	1.4	0	124	15	139	10.8	1.6	9
14:45-15:00	34	1	35	2.9	1.4	2	111	15	126	11.9	1.5	10
1時間計	156	9	165	5.5	6.6	6	532	71	603	11.8	7.1	36

方向別自動車交通量調査表

調査地点：地域社会4 滝沢

調査年月日：令和2年9月21日(月・祝) 天候：曇りのち晴れ



時間帯	1						2					
	小型車 (台)	大型車 (台)	合計 (台)	大型車 混入率 (%)	時係 数 (%)	二輪車 (台)	小型車 (台)	大型車 (台)	合計 (台)	大型車 混入率 (%)	時係 数 (%)	二輪車 (台)
15:00-15:15	40	4	44	9.1	1.7	2	152	15	167	9.0	2.0	8
15:15-15:30	31	3	34	8.8	1.3	0	141	13	154	8.4	1.8	5
15:30-15:45	41	2	43	4.7	1.7	3	168	14	182	7.7	2.1	13
15:45-16:00	39	3	42	7.1	1.7	2	136	16	152	10.5	1.8	3
1時間計	151	12	163	7.4	6.5	7	597	58	655	8.9	7.7	29
16:00-16:15	38	4	42	9.5	1.7	0	136	14	150	9.3	1.8	5
16:15-16:30	37	2	39	5.1	1.5	2	106	15	121	12.4	1.4	8
16:30-16:45	59	4	63	6.3	2.5	1	135	12	147	8.2	1.7	3
16:45-17:00	45	0	45	0.0	1.8	3	138	9	147	6.1	1.7	9
1時間計	179	10	189	5.3	7.5	6	515	50	565	8.8	6.7	25
17:00-17:15	54	2	56	3.6	2.2	0	145	9	154	5.8	1.8	7
17:15-17:30	49	0	49	0.0	1.9	2	103	3	106	2.8	1.3	6
17:30-17:45	38	1	39	2.6	1.5	0	105	13	118	11.0	1.4	10
17:45-18:00	38	1	39	2.6	1.5	0	107	9	116	7.8	1.4	7
1時間計	179	4	183	2.2	7.3	2	460	34	494	6.9	5.8	30
18:00-18:15	50	3	53	5.7	2.1	1	118	8	126	6.3	1.5	6
18:15-18:30	31	2	33	6.1	1.3	2	107	4	111	3.6	1.3	9
18:30-18:45	27	2	29	6.9	1.2	3	89	5	94	5.3	1.1	3
18:45-19:00	35	2	37	5.4	1.5	2	124	4	128	3.1	1.5	1
1時間計	143	9	152	5.9	6.0	8	438	21	459	4.6	5.4	19
昼12時間計	1836	105	1941	5.4	77.1	68	6275	691	6966	9.9	82.1	365
19:00-19:15	30	0	30	0.0	1.2	0	90	3	93	3.2	1.1	1
19:15-19:30	28	0	28	0.0	1.1	0	69	2	71	2.8	0.8	9
19:30-19:45	27	1	28	3.6	1.1	1	75	2	77	2.6	0.9	4
19:45-20:00	12	0	12	0.0	0.5	1	68	1	69	1.4	0.8	4
1時間計	97	1	98	1.0	3.9	2	302	8	310	2.6	3.7	18
20:00-20:15	27	0	27	0.0	1.1	1	66	2	68	2.9	0.8	4
20:15-20:30	25	1	26	3.8	1.0	0	61	0	61	0.0	0.7	2
20:30-20:45	19	0	19	0.0	0.8	1	66	1	67	1.5	0.8	2
20:45-21:00	18	0	18	0.0	0.7	0	46	1	47	2.1	0.6	2
1時間計	89	1	90	1.1	3.6	2	239	4	243	1.6	2.9	10
21:00-21:15	24	0	24	0.0	1.0	2	46	2	48	4.2	0.6	1
21:15-21:30	13	1	14	7.1	0.6	1	36	0	36	0.0	0.4	2
21:30-21:45	19	1	20	5.0	0.8	0	35	1	36	2.8	0.4	7
21:45-22:00	15	0	15	0.0	0.6	2	39	2	41	4.9	0.5	7
1時間計	71	2	73	2.7	2.9	5	156	5	161	3.1	1.9	17
22:00-22:15	14	1	15	6.7	0.6	1	33	1	34	2.9	0.4	6
22:15-22:30	10	1	11	9.1	0.4	2	23	1	24	4.2	0.3	0
22:30-22:45	9	3	12	25.0	0.5	1	25	0	25	0.0	0.3	1
22:45-23:00	9	0	9	0.0	0.4	0	20	1	21	4.8	0.2	1
1時間計	42	5	47	10.6	1.9	4	101	3	104	2.9	1.2	8

方向別自動車交通量調査表

調査地点 : 地域社会 4 滝沢

調査年月日 : 令和 2年 9月21日(月・祝) 天候:曇りのち晴れ



方向 種別 時間帯	1						2					
	小型車 (台)	大型車 (台)	合計 (台)	大型車 混入率 (%)	時間 係数 (%)	二輪車 (台)	小型車 (台)	大型車 (台)	合計 (台)	大型車 混入率 (%)	時間 係数 (%)	二輪車 (台)
23:00-23:15	8	0	8	0.0	0.3	0	22	2	24	8.3	0.3	0
23:15-23:30	9	1	10	10.0	0.4	0	24	1	25	4.0	0.3	2
23:30-23:45	9	0	9	0.0	0.4	1	17	1	18	5.6	0.2	2
23:45-24:00	6	1	7	14.3	0.3	1	19	1	20	5.0	0.2	1
1時間計	32	2	34	5.9	1.3	2	82	5	87	5.7	1.0	5
0:00-0:15	11	1	12	8.3	0.5	0	15	2	17	11.8	0.2	2
0:15-0:30	6	2	8	25.0	0.3	0	12	3	15	20.0	0.2	2
0:30-0:45	8	0	8	0.0	0.3	1	19	5	24	20.8	0.3	0
0:45-1:00	10	0	10	0.0	0.4	0	8	3	11	27.3	0.1	1
1時間計	35	3	38	7.9	1.5	1	54	13	67	19.4	0.8	5
1:00-1:15	8	0	8	0.0	0.3	0	8	6	14	42.9	0.2	0
1:15-1:30	6	2	8	25.0	0.3	0	6	3	9	33.3	0.1	2
1:30-1:45	5	0	5	0.0	0.2	0	7	3	10	30.0	0.1	2
1:45-2:00	6	0	6	0.0	0.2	0	10	1	11	9.1	0.1	0
1時間計	25	2	27	7.4	1.1	0	31	13	44	29.5	0.5	4
2:00-2:15	1	0	1	0.0	0.0	0	11	2	13	15.4	0.2	0
2:15-2:30	1	1	2	50.0	0.1	0	6	2	8	25.0	0.1	0
2:30-2:45	5	0	5	0.0	0.2	0	10	2	12	16.7	0.1	1
2:45-3:00	3	0	3	0.0	0.1	0	0	0	0	0.0	0.0	1
1時間計	10	1	11	9.1	0.4	0	27	6	33	18.2	0.4	2
3:00-3:15	11	1	12	8.3	0.5	0	11	3	14	21.4	0.2	1
3:15-3:30	5	0	5	0.0	0.2	0	11	2	13	15.4	0.2	1
3:30-3:45	1	0	1	0.0	0.0	0	11	2	13	15.4	0.2	0
3:45-4:00	7	0	7	0.0	0.3	0	9	2	11	18.2	0.1	0
1時間計	24	1	25	4.0	1.0	0	42	9	51	17.6	0.6	2
4:00-4:15	2	1	3	33.3	0.1	0	6	1	7	14.3	0.1	0
4:15-4:30	5	0	5	0.0	0.2	0	10	1	11	9.1	0.1	0
4:30-4:45	7	0	7	0.0	0.3	1	8	3	11	27.3	0.1	0
4:45-5:00	8	0	8	0.0	0.3	0	9	3	12	25.0	0.1	3
1時間計	22	1	23	4.3	0.9	1	33	8	41	19.5	0.5	3
5:00-5:15	14	3	17	17.6	0.7	1	25	1	26	3.8	0.3	1
5:15-5:30	8	2	10	20.0	0.4	0	18	3	21	14.3	0.2	1
5:30-5:45	17	1	18	5.6	0.7	1	33	5	38	13.2	0.4	3
5:45-6:00	9	0	9	0.0	0.4	1	22	0	22	0.0	0.3	1
1時間計	48	6	54	11.1	2.1	3	98	9	107	8.4	1.3	6
6:00-6:15	9	0	9	0.0	0.4	0	48	4	52	7.7	0.6	5
6:15-6:30	7	0	7	0.0	0.3	0	50	6	56	10.7	0.7	6
6:30-6:45	12	3	15	20.0	0.6	0	62	8	70	11.4	0.8	5
6:45-7:00	25	2	27	7.4	1.1	2	81	7	88	8.0	1.0	4
1時間計	53	5	58	8.6	2.3	2	241	25	266	9.4	3.1	20
夜12時間計	548	30	578	5.2	22.9	22	1406	108	1514	7.1	17.9	100
全時間合計	2384	135	2519	5.4	100.0	90	7681	799	8480	9.4	100.0	465
昼夜率	1.30	1.29	1.30	-	-	1.32	1.22	1.16	1.22	-	-	1.27

方向別自動車交通量調査表

調査地点：地域社会4 滝沢

調査年月日：令和2年9月21日(月・祝) 天候：曇りのち晴れ



方向 種別 時間帯							A 合計 (1+2)					
	小型車 (台)	大型車 (台)	合計 (台)	大型車 混入率 (%)	時間 係数 (%)	二輪車 (台)	小型車 (台)	大型車 (台)	合計 (台)	大型車 混入率 (%)	時間 係数 (%)	二輪車 (台)
7:00-7:15							90	19	109	17.4	1.0	9
7:15-7:30							112	17	129	13.2	1.2	12
7:30-7:45							130	16	146	11.0	1.3	7
7:45-8:00							147	11	158	7.0	1.4	5
1時間計							479	63	542	11.6	4.9	33
8:00-8:15							180	17	197	8.6	1.8	16
8:15-8:30							167	21	188	11.2	1.7	10
8:30-8:45							193	16	209	7.7	1.9	5
8:45-9:00							214	20	234	8.5	2.1	13
1時間計							754	74	828	8.9	7.5	44
9:00-9:15							174	20	194	10.3	1.8	12
9:15-9:30							200	19	219	8.7	2.0	20
9:30-9:45							201	17	218	7.8	2.0	12
9:45-10:00							145	12	157	7.6	1.4	6
1時間計							720	68	788	8.6	7.2	50
10:00-10:15							135	9	144	6.3	1.3	7
10:15-10:30							156	13	169	7.7	1.5	9
10:30-10:45							178	19	197	9.6	1.8	11
10:45-11:00							149	15	164	9.1	1.5	8
1時間計							618	56	674	8.3	6.1	35
11:00-11:15							144	21	165	12.7	1.5	7
11:15-11:30							111	15	126	11.9	1.1	6
11:30-11:45							147	27	174	15.5	1.6	4
11:45-12:00							212	27	239	11.3	2.2	17
1時間計							614	90	704	12.8	6.4	34
12:00-12:15							160	23	183	12.6	1.7	8
12:15-12:30							195	25	220	11.4	2.0	14
12:30-12:45							226	24	250	9.6	2.3	6
12:45-13:00							191	19	210	9.0	1.9	9
1時間計							772	91	863	10.5	7.8	37
13:00-13:15							227	21	248	8.5	2.3	8
13:15-13:30							221	20	241	8.3	2.2	7
13:30-13:45							179	16	195	8.2	1.8	12
13:45-14:00							177	19	196	9.7	1.8	5
1時間計							804	76	880	8.6	8.0	32
14:00-14:15							192	23	215	10.7	2.0	12
14:15-14:30							194	24	218	11.0	2.0	9
14:30-14:45							157	17	174	9.8	1.6	9
14:45-15:00							145	16	161	9.9	1.5	12
1時間計							688	80	768	10.4	7.0	42

方向別自動車交通量調査表

調査地点 : 地域社会 4 滝沢

調査年月日 : 令和 2年 9月21日(月・祝) 天候:曇りのち晴れ



方向 種別 時間帯							A 合計 (1+2)					
	小型車 (台)	大型車 (台)	合計 (台)	大型車 混入率 (%)	時間 係数 (%)	二輪車 (台)	小型車 (台)	大型車 (台)	合計 (台)	大型車 混入率 (%)	時間 係数 (%)	二輪車 (台)
15:00-15:15							192	19	211	9.0	1.9	10
15:15-15:30							172	16	188	8.5	1.7	5
15:30-15:45							209	16	225	7.1	2.0	16
15:45-16:00							175	19	194	9.8	1.8	5
1時間計							748	70	818	8.6	7.4	36
16:00-16:15							174	18	192	9.4	1.7	5
16:15-16:30							143	17	160	10.6	1.5	10
16:30-16:45							194	16	210	7.6	1.9	4
16:45-17:00							183	9	192	4.7	1.7	12
1時間計							694	60	754	8.0	6.9	31
17:00-17:15							199	11	210	5.2	1.9	7
17:15-17:30							152	3	155	1.9	1.4	8
17:30-17:45							143	14	157	8.9	1.4	10
17:45-18:00							145	10	155	6.5	1.4	7
1時間計							639	38	677	5.6	6.2	32
18:00-18:15							168	11	179	6.1	1.6	7
18:15-18:30							138	6	144	4.2	1.3	11
18:30-18:45							116	7	123	5.7	1.1	6
18:45-19:00							159	6	165	3.6	1.5	3
1時間計							581	30	611	4.9	5.6	27
昼12時間計							8111	796	8907	8.9	81.0	433
19:00-19:15							120	3	123	2.4	1.1	1
19:15-19:30							97	2	99	2.0	0.9	9
19:30-19:45							102	3	105	2.9	1.0	5
19:45-20:00							80	1	81	1.2	0.7	5
1時間計							399	9	408	2.2	3.7	20
20:00-20:15							93	2	95	2.1	0.9	5
20:15-20:30							86	1	87	1.1	0.8	2
20:30-20:45							85	1	86	1.2	0.8	3
20:45-21:00							64	1	65	1.5	0.6	2
1時間計							328	5	333	1.5	3.0	12
21:00-21:15							70	2	72	2.8	0.7	3
21:15-21:30							49	1	50	2.0	0.5	3
21:30-21:45							54	2	56	3.6	0.5	7
21:45-22:00							54	2	56	3.6	0.5	9
1時間計							227	7	234	3.0	2.1	22
22:00-22:15							47	2	49	4.1	0.4	7
22:15-22:30							33	2	35	5.7	0.3	2
22:30-22:45							34	3	37	8.1	0.3	2
22:45-23:00							29	1	30	3.3	0.3	1
1時間計							143	8	151	5.3	1.4	12

方向別自動車交通量調査表

調査地点：地域社会4 滝沢

調査年月日：令和2年9月21日(月・祝) 天候：曇りのち晴れ



方向 種別 時間帯							A 合計 (1+2)					
	小型車 (台)	大型車 (台)	合計 (台)	大型車 混入率 (%)	時間 係数 (%)	二輪車 (台)	小型車 (台)	大型車 (台)	合計 (台)	大型車 混入率 (%)	時間 係数 (%)	二輪車 (台)
23:00-23:15							30	2	32	6.3	0.3	0
23:15-23:30							33	2	35	5.7	0.3	2
23:30-23:45							26	1	27	3.7	0.2	3
23:45-24:00							25	2	27	7.4	0.2	2
1時間計							114	7	121	5.8	1.1	7
0:00-0:15							26	3	29	10.3	0.3	2
0:15-0:30							18	5	23	21.7	0.2	2
0:30-0:45							27	5	32	15.6	0.3	1
0:45-1:00							18	3	21	14.3	0.2	1
1時間計							89	16	105	15.2	1.0	6
1:00-1:15							16	6	22	27.3	0.2	0
1:15-1:30							12	5	17	29.4	0.2	2
1:30-1:45							12	3	15	20.0	0.1	2
1:45-2:00							16	1	17	5.9	0.2	0
1時間計							56	15	71	21.1	0.6	4
2:00-2:15							12	2	14	14.3	0.1	0
2:15-2:30							7	3	10	30.0	0.1	0
2:30-2:45							15	2	17	11.8	0.2	1
2:45-3:00							3	0	3	0.0	0.0	1
1時間計							37	7	44	15.9	0.4	2
3:00-3:15							22	4	26	15.4	0.2	1
3:15-3:30							16	2	18	11.1	0.2	1
3:30-3:45							12	2	14	14.3	0.1	0
3:45-4:00							16	2	18	11.1	0.2	0
1時間計							66	10	76	13.2	0.7	2
4:00-4:15							8	2	10	20.0	0.1	0
4:15-4:30							15	1	16	6.3	0.1	0
4:30-4:45							15	3	18	16.7	0.2	1
4:45-5:00							17	3	20	15.0	0.2	3
1時間計							55	9	64	14.1	0.6	4
5:00-5:15							39	4	43	9.3	0.4	2
5:15-5:30							26	5	31	16.1	0.3	1
5:30-5:45							50	6	56	10.7	0.5	4
5:45-6:00							31	0	31	0.0	0.3	2
1時間計							146	15	161	9.3	1.5	9
6:00-6:15							57	4	61	6.6	0.6	5
6:15-6:30							57	6	63	9.5	0.6	6
6:30-6:45							74	11	85	12.9	0.8	5
6:45-7:00							106	9	115	7.8	1.0	6
1時間計							294	30	324	9.3	2.9	22
夜12時間計							1954	138	2092	6.6	19.0	122
全時間合計							10065	934	10999	8.5	100.0	555
昼夜率							1.24	1.17	1.23	-	-	1.28

方向別自動車交通量調査表

調査地点：地域社会4 滝沢

調査年月日：令和2年9月21日(月・祝) 天候：曇りのち晴れ



方向 時間帯	3						4					
	種別 小型車 (台)	大型車 (台)	合計 (台)	大型車 混入率 (%)	時間 係数 (%)	二輪車 (台)	小型車 (台)	大型車 (台)	合計 (台)	大型車 混入率 (%)	時間 係数 (%)	二輪車 (台)
7:00-7:15	85	12	97	12.4	1.1	9	0	0	0	0.0	0.0	0
7:15-7:30	104	15	119	12.6	1.4	3	2	1	3	33.3	1.0	0
7:30-7:45	100	17	117	14.5	1.3	7	6	2	8	25.0	2.8	0
7:45-8:00	72	12	84	14.3	1.0	6	7	2	9	22.2	3.1	1
1時間計	361	56	417	13.4	4.8	25	15	5	20	25.0	6.9	1
8:00-8:15	93	9	102	8.8	1.2	9	0	0	0	0.0	0.0	0
8:15-8:30	111	17	128	13.3	1.5	3	1	0	1	0.0	0.3	0
8:30-8:45	94	18	112	16.1	1.3	1	6	1	7	14.3	2.4	0
8:45-9:00	85	25	110	22.7	1.3	4	2	0	2	0.0	0.7	0
1時間計	383	69	452	15.3	5.2	17	9	1	10	10.0	3.5	0
9:00-9:15	66	22	88	25.0	1.0	5	2	1	3	33.3	1.0	0
9:15-9:30	94	18	112	16.1	1.3	13	5	0	5	0.0	1.7	0
9:30-9:45	85	21	106	19.8	1.2	3	4	1	5	20.0	1.7	0
9:45-10:00	108	14	122	11.5	1.4	2	4	4	8	50.0	2.8	1
1時間計	353	75	428	17.5	4.9	23	15	6	21	28.6	7.3	1
10:00-10:15	116	14	130	10.8	1.5	3	4	2	6	33.3	2.1	0
10:15-10:30	86	8	94	8.5	1.1	5	0	0	0	0.0	0.0	0
10:30-10:45	82	15	97	15.5	1.1	3	2	2	4	50.0	1.4	0
10:45-11:00	89	8	97	8.2	1.1	3	4	0	4	0.0	1.4	0
1時間計	373	45	418	10.8	4.8	14	10	4	14	28.6	4.9	0
11:00-11:15	89	10	99	10.1	1.1	4	2	2	4	50.0	1.4	0
11:15-11:30	75	9	84	10.7	1.0	8	4	0	4	0.0	1.4	0
11:30-11:45	97	3	100	3.0	1.1	3	3	1	4	25.0	1.4	0
11:45-12:00	85	10	95	10.5	1.1	7	2	1	3	33.3	1.0	0
1時間計	346	32	378	8.5	4.3	22	11	4	15	26.7	5.2	0
12:00-12:15	98	6	104	5.8	1.2	5	3	1	4	25.0	1.4	1
12:15-12:30	86	8	94	8.5	1.1	5	0	0	0	0.0	0.0	1
12:30-12:45	104	9	113	8.0	1.3	8	2	3	5	60.0	1.7	0
12:45-13:00	114	9	123	7.3	1.4	4	2	1	3	33.3	1.0	2
1時間計	402	32	434	7.4	5.0	22	7	5	12	41.7	4.2	4
13:00-13:15	95	5	100	5.0	1.1	5	3	3	6	50.0	2.1	0
13:15-13:30	104	12	116	10.3	1.3	6	3	1	4	25.0	1.4	1
13:30-13:45	127	10	137	7.3	1.6	8	5	3	8	37.5	2.8	0
13:45-14:00	126	9	135	6.7	1.5	5	0	1	1	100.0	0.3	0
1時間計	452	36	488	7.4	5.6	24	11	8	19	42.1	6.6	1
14:00-14:15	147	16	163	9.8	1.9	6	0	0	0	0.0	0.0	0
14:15-14:30	148	5	153	3.3	1.8	9	5	1	6	16.7	2.1	0
14:30-14:45	128	9	137	6.6	1.6	11	6	1	7	14.3	2.4	1
14:45-15:00	129	11	140	7.9	1.6	8	3	0	3	0.0	1.0	0
1時間計	552	41	593	6.9	6.8	34	14	2	16	12.5	5.6	1

方向別自動車交通量調査表

調査地点 : 地域社会 4 滝沢

調査年月日 : 令和 2年 9月21日(月・祝) 天候:曇りのち晴れ



方向	3						4						
	種別	小型車 (台)	大型車 (台)	合計 (台)	大型車 混入率 (%)	時 間 係 数 (%)	二輪車 (台)	小型車 (台)	大型車 (台)	合計 (台)	大型車 混入率 (%)	時 間 係 数 (%)	二輪車 (台)
15:00-15:15		165	10	175	5.7	2.0	6	7	0	7	0.0	2.4	0
15:15-15:30		126	9	135	6.7	1.5	5	2	1	3	33.3	1.0	1
15:30-15:45		135	8	143	5.6	1.6	8	1	3	4	75.0	1.4	0
15:45-16:00		138	10	148	6.8	1.7	10	6	0	6	0.0	2.1	0
1時間計		564	37	601	6.2	6.9	29	16	4	20	20.0	6.9	1
16:00-16:15		148	6	154	3.9	1.8	5	1	0	1	0.0	0.3	0
16:15-16:30		166	9	175	5.1	2.0	4	0	2	2	100.0	0.7	0
16:30-16:45		182	10	192	5.2	2.2	6	2	0	2	0.0	0.7	0
16:45-17:00		143	5	148	3.4	1.7	10	6	3	9	33.3	3.1	0
1時間計		639	30	669	4.5	7.7	25	9	5	14	35.7	4.9	0
17:00-17:15		138	10	148	6.8	1.7	15	3	0	3	0.0	1.0	0
17:15-17:30		157	6	163	3.7	1.9	23	6	2	8	25.0	2.8	0
17:30-17:45		158	11	169	6.5	1.9	11	2	2	4	50.0	1.4	0
17:45-18:00		160	8	168	4.8	1.9	8	2	1	3	33.3	1.0	0
1時間計		613	35	648	5.4	7.4	57	13	5	18	27.8	6.3	0
18:00-18:15		168	5	173	2.9	2.0	13	0	1	1	100.0	0.3	0
18:15-18:30		178	4	182	2.2	2.1	9	1	1	2	50.0	0.7	0
18:30-18:45		162	5	167	3.0	1.9	7	0	0	0	0.0	0.0	0
18:45-19:00		149	6	155	3.9	1.8	10	2	0	2	0.0	0.7	0
1時間計		657	20	677	3.0	7.8	39	3	2	5	40.0	1.7	0
昼12時間計		5695	508	6203	8.2	71.0	331	133	51	184	27.7	63.9	9
19:00-19:15		178	4	182	2.2	2.1	14	1	0	1	0.0	0.3	0
19:15-19:30		133	3	136	2.2	1.6	10	0	3	3	100.0	1.0	0
19:30-19:45		137	4	141	2.8	1.6	7	1	1	2	50.0	0.7	0
19:45-20:00		115	3	118	2.5	1.4	5	5	2	7	28.6	2.4	0
1時間計		563	14	577	2.4	6.6	36	7	6	13	46.2	4.5	0
20:00-20:15		111	4	115	3.5	1.3	8	2	0	2	0.0	0.7	0
20:15-20:30		112	2	114	1.8	1.3	3	0	0	0	0.0	0.0	0
20:30-20:45		120	2	122	1.6	1.4	8	5	2	7	28.6	2.4	0
20:45-21:00		97	3	100	3.0	1.1	6	3	0	3	0.0	1.0	0
1時間計		440	11	451	2.4	5.2	25	10	2	12	16.7	4.2	0
21:00-21:15		123	4	127	3.1	1.5	6	4	2	6	33.3	2.1	0
21:15-21:30		113	3	116	2.6	1.3	6	2	0	2	0.0	0.7	0
21:30-21:45		98	3	101	3.0	1.2	4	3	0	3	0.0	1.0	0
21:45-22:00		75	3	78	3.8	0.9	2	3	3	6	50.0	2.1	0
1時間計		409	13	422	3.1	4.8	18	12	5	17	29.4	5.9	0
22:00-22:15		75	2	77	2.6	0.9	3	4	1	5	20.0	1.7	0
22:15-22:30		45	5	50	10.0	0.6	3	2	0	2	0.0	0.7	0
22:30-22:45		74	6	80	7.5	0.9	8	4	1	5	20.0	1.7	0
22:45-23:00		50	1	51	2.0	0.6	3	1	2	3	66.7	1.0	0
1時間計		244	14	258	5.4	3.0	17	11	4	15	26.7	5.2	0

方向別自動車交通量調査表

調査地点：地域社会4 滝沢

調査年月日：令和2年9月21日(月・祝) 天候：曇りのち晴れ



方向 種別 時間帯	3						4					
	小型車 (台)	大型車 (台)	合計 (台)	大型車 混入率 (%)	時間 係数 (%)	二輪車 (台)	小型車 (台)	大型車 (台)	合計 (台)	大型車 混入率 (%)	時間 係数 (%)	二輪車 (台)
23:00-23:15	41	4	45	8.9	0.5	2	2	0	2	0.0	0.7	0
23:15-23:30	37	2	39	5.1	0.4	4	1	2	3	66.7	1.0	0
23:30-23:45	25	2	27	7.4	0.3	0	1	0	1	0.0	0.3	0
23:45-24:00	32	3	35	8.6	0.4	1	0	0	0	0.0	0.0	0
1時間計	135	11	146	7.5	1.7	7	4	2	6	33.3	2.1	0
0:00-0:15	15	3	18	16.7	0.2	2	2	0	2	0.0	0.7	0
0:15-0:30	21	2	23	8.7	0.3	1	1	0	1	0.0	0.3	0
0:30-0:45	18	4	22	18.2	0.3	3	1	0	1	0.0	0.3	1
0:45-1:00	8	1	9	11.1	0.1	1	1	0	1	0.0	0.3	0
1時間計	62	10	72	13.9	0.8	7	5	0	5	0.0	1.7	1
1:00-1:15	10	2	12	16.7	0.1	3	1	2	3	66.7	1.0	0
1:15-1:30	9	6	15	40.0	0.2	2	3	0	3	0.0	1.0	0
1:30-1:45	5	2	7	28.6	0.1	1	2	0	2	0.0	0.7	0
1:45-2:00	8	2	10	20.0	0.1	1	1	0	1	0.0	0.3	0
1時間計	32	12	44	27.3	0.5	7	7	2	9	22.2	3.1	0
2:00-2:15	10	3	13	23.1	0.1	1	1	1	2	50.0	0.7	0
2:15-2:30	10	1	11	9.1	0.1	2	0	1	1	100.0	0.3	0
2:30-2:45	8	3	11	27.3	0.1	0	0	0	0	0.0	0.0	0
2:45-3:00	2	3	5	60.0	0.1	0	1	0	1	0.0	0.3	0
1時間計	30	10	40	25.0	0.5	3	2	2	4	50.0	1.4	0
3:00-3:15	6	2	8	25.0	0.1	1	0	0	0	0.0	0.0	0
3:15-3:30	8	4	12	33.3	0.1	1	0	1	1	100.0	0.3	0
3:30-3:45	9	3	12	25.0	0.1	0	1	1	2	50.0	0.7	0
3:45-4:00	5	1	6	16.7	0.1	2	0	0	0	0.0	0.0	0
1時間計	28	10	38	26.3	0.4	4	1	2	3	66.7	1.0	0
4:00-4:15	12	1	13	7.7	0.1	0	1	2	3	66.7	1.0	0
4:15-4:30	9	2	11	18.2	0.1	0	1	0	1	0.0	0.3	0
4:30-4:45	16	1	17	5.9	0.2	2	1	0	1	0.0	0.3	0
4:45-5:00	28	5	33	15.2	0.4	2	3	0	3	0.0	1.0	0
1時間計	65	9	74	12.2	0.8	4	6	2	8	25.0	2.8	0
5:00-5:15	27	8	35	22.9	0.4	2	0	2	2	100.0	0.7	0
5:15-5:30	16	1	17	5.9	0.2	2	3	1	4	25.0	1.4	0
5:30-5:45	28	5	33	15.2	0.4	6	0	0	0	0.0	0.0	1
5:45-6:00	30	8	38	21.1	0.4	5	3	0	3	0.0	1.0	0
1時間計	101	22	123	17.9	1.4	15	6	3	9	33.3	3.1	1
6:00-6:15	48	9	57	15.8	0.7	3	1	1	2	50.0	0.7	0
6:15-6:30	66	13	79	16.5	0.9	6	0	0	0	0.0	0.0	0
6:30-6:45	62	9	71	12.7	0.8	4	0	1	1	100.0	0.3	0
6:45-7:00	68	8	76	10.5	0.9	7	0	0	0	0.0	0.0	0
1時間計	244	39	283	13.8	3.2	20	1	2	3	66.7	1.0	0
夜12時間計	2353	175	2528	6.9	29.0	163	72	32	104	30.8	36.1	2
全時間合計	8048	683	8731	7.8	100.0	494	205	83	288	28.8	100.0	11
昼夜率	1.41	1.34	1.41	-	-	1.49	1.54	1.63	1.57	-	-	1.22

方向別自動車交通量調査表

調査地点：地域社会4 滝沢

調査年月日：令和2年9月21日(月・祝) 天候：曇りのち晴れ



方向 種別 時間帯							B 合計 (3+4)					
	小型車 (台)	大型車 (台)	合計 (台)	大型車 混入率 (%)	時間 係数 (%)	二輪車 (台)	小型車 (台)	大型車 (台)	合計 (台)	大型車 混入率 (%)	時間 係数 (%)	二輪車 (台)
7:00-7:15							85	12	97	12.4	1.1	9
7:15-7:30							106	16	122	13.1	1.4	3
7:30-7:45							106	19	125	15.2	1.4	7
7:45-8:00							79	14	93	15.1	1.0	7
1時間計							376	61	437	14.0	4.8	26
8:00-8:15							93	9	102	8.8	1.1	9
8:15-8:30							112	17	129	13.2	1.4	3
8:30-8:45							100	19	119	16.0	1.3	1
8:45-9:00							87	25	112	22.3	1.2	4
1時間計							392	70	462	15.2	5.1	17
9:00-9:15							68	23	91	25.3	1.0	5
9:15-9:30							99	18	117	15.4	1.3	13
9:30-9:45							89	22	111	19.8	1.2	3
9:45-10:00							112	18	130	13.8	1.4	3
1時間計							368	81	449	18.0	5.0	24
10:00-10:15							120	16	136	11.8	1.5	3
10:15-10:30							86	8	94	8.5	1.0	5
10:30-10:45							84	17	101	16.8	1.1	3
10:45-11:00							93	8	101	7.9	1.1	3
1時間計							383	49	432	11.3	4.8	14
11:00-11:15							91	12	103	11.7	1.1	4
11:15-11:30							79	9	88	10.2	1.0	8
11:30-11:45							100	4	104	3.8	1.2	3
11:45-12:00							87	11	98	11.2	1.1	7
1時間計							357	36	393	9.2	4.4	22
12:00-12:15							101	7	108	6.5	1.2	6
12:15-12:30							86	8	94	8.5	1.0	6
12:30-12:45							106	12	118	10.2	1.3	8
12:45-13:00							116	10	126	7.9	1.4	6
1時間計							409	37	446	8.3	4.9	26
13:00-13:15							98	8	106	7.5	1.2	5
13:15-13:30							107	13	120	10.8	1.3	7
13:30-13:45							132	13	145	9.0	1.6	8
13:45-14:00							126	10	136	7.4	1.5	5
1時間計							463	44	507	8.7	5.6	25
14:00-14:15							147	16	163	9.8	1.8	6
14:15-14:30							153	6	159	3.8	1.8	9
14:30-14:45							134	10	144	6.9	1.6	12
14:45-15:00							132	11	143	7.7	1.6	8
1時間計							566	43	609	7.1	6.8	35

方向別自動車交通量調査表

調査地点：地域社会4 滝沢

調査年月日：令和2年9月21日(月・祝) 天候：曇りのち晴れ



方向 種別 時間帯							B 合計 (3+4)					
	小型車 (台)	大型車 (台)	合計 (台)	大型車 混入率 (%)	時間 係数 (%)	二輪車 (台)	小型車 (台)	大型車 (台)	合計 (台)	大型車 混入率 (%)	時間 係数 (%)	二輪車 (台)
15:00-15:15							172	10	182	5.5	2.0	6
15:15-15:30							128	10	138	7.2	1.5	6
15:30-15:45							136	11	147	7.5	1.6	8
15:45-16:00							144	10	154	6.5	1.7	10
1時間計							580	41	621	6.6	6.9	30
16:00-16:15							149	6	155	3.9	1.7	5
16:15-16:30							166	11	177	6.2	2.0	4
16:30-16:45							184	10	194	5.2	2.2	6
16:45-17:00							149	8	157	5.1	1.7	10
1時間計							648	35	683	5.1	7.6	25
17:00-17:15							141	10	151	6.6	1.7	15
17:15-17:30							163	8	171	4.7	1.9	23
17:30-17:45							160	13	173	7.5	1.9	11
17:45-18:00							162	9	171	5.3	1.9	8
1時間計							626	40	666	6.0	7.4	57
18:00-18:15							168	6	174	3.4	1.9	13
18:15-18:30							179	5	184	2.7	2.0	9
18:30-18:45							162	5	167	3.0	1.9	7
18:45-19:00							151	6	157	3.8	1.7	10
1時間計							660	22	682	3.2	7.6	39
昼12時間計							5828	559	6387	8.8	70.8	340
19:00-19:15							179	4	183	2.2	2.0	14
19:15-19:30							133	6	139	4.3	1.5	10
19:30-19:45							138	5	143	3.5	1.6	7
19:45-20:00							120	5	125	4.0	1.4	5
1時間計							570	20	590	3.4	6.5	36
20:00-20:15							113	4	117	3.4	1.3	8
20:15-20:30							112	2	114	1.8	1.3	3
20:30-20:45							125	4	129	3.1	1.4	8
20:45-21:00							100	3	103	2.9	1.1	6
1時間計							450	13	463	2.8	5.1	25
21:00-21:15							127	6	133	4.5	1.5	6
21:15-21:30							115	3	118	2.5	1.3	6
21:30-21:45							101	3	104	2.9	1.2	4
21:45-22:00							78	6	84	7.1	0.9	2
1時間計							421	18	439	4.1	4.9	18
22:00-22:15							79	3	82	3.7	0.9	3
22:15-22:30							47	5	52	9.6	0.6	3
22:30-22:45							78	7	85	8.2	0.9	8
22:45-23:00							51	3	54	5.6	0.6	3
1時間計							255	18	273	6.6	3.0	17

方向別自動車交通量調査表

調査地点：地域社会4 滝沢

調査年月日：令和2年9月21日(月・祝) 天候：曇りのち晴れ



時間帯	方向 種別						B 合計 (3+4)					
		小型車 (台)	大型車 (台)	合計 (台)	大型車 混入率 (%)	時係 数 (%)	二輪車 (台)	小型車 (台)	大型車 (台)	合計 (台)	大型車 混入率 (%)	時係 数 (%)
23:00-23:15							43	4	47	8.5	0.5	2
23:15-23:30							38	4	42	9.5	0.5	4
23:30-23:45							26	2	28	7.1	0.3	0
23:45-24:00							32	3	35	8.6	0.4	1
1時間計							139	13	152	8.6	1.7	7
0:00-0:15							17	3	20	15.0	0.2	2
0:15-0:30							22	2	24	8.3	0.3	1
0:30-0:45							19	4	23	17.4	0.3	4
0:45-1:00							9	1	10	10.0	0.1	1
1時間計							67	10	77	13.0	0.9	8
1:00-1:15							11	4	15	26.7	0.2	3
1:15-1:30							12	6	18	33.3	0.2	2
1:30-1:45							7	2	9	22.2	0.1	1
1:45-2:00							9	2	11	18.2	0.1	1
1時間計							39	14	53	26.4	0.6	7
2:00-2:15							11	4	15	26.7	0.2	1
2:15-2:30							10	2	12	16.7	0.1	2
2:30-2:45							8	3	11	27.3	0.1	0
2:45-3:00							3	3	6	50.0	0.1	0
1時間計							32	12	44	27.3	0.5	3
3:00-3:15							6	2	8	25.0	0.1	1
3:15-3:30							8	5	13	38.5	0.1	1
3:30-3:45							10	4	14	28.6	0.2	0
3:45-4:00							5	1	6	16.7	0.1	2
1時間計							29	12	41	29.3	0.5	4
4:00-4:15							13	3	16	18.8	0.2	0
4:15-4:30							10	2	12	16.7	0.1	0
4:30-4:45							17	1	18	5.6	0.2	2
4:45-5:00							31	5	36	13.9	0.4	2
1時間計							71	11	82	13.4	0.9	4
5:00-5:15							27	10	37	27.0	0.4	2
5:15-5:30							19	2	21	9.5	0.2	2
5:30-5:45							28	5	33	15.2	0.4	7
5:45-6:00							33	8	41	19.5	0.5	5
1時間計							107	25	132	18.9	1.5	16
6:00-6:15							49	10	59	16.9	0.7	3
6:15-6:30							66	13	79	16.5	0.9	6
6:30-6:45							62	10	72	13.9	0.8	4
6:45-7:00							68	8	76	10.5	0.8	7
1時間計							245	41	286	14.3	3.2	20
夜12時間計							2425	207	2632	7.9	29.2	165
全時間合計							8253	766	9019	8.5	100.0	505
昼夜率							1.42	1.37	1.41	-	-	1.49

方向別自動車交通量調査表

調査地点 : 地域社会 4 滝沢

調査年月日 : 令和 2年 9月21日(月・祝) 天候:曇りのち晴れ



方向 時間帯	5						6					
	種別 小型車 (台)	大型車 (台)	合計 (台)	大型車 混入率 (%)	時間 係数 (%)	二輪車 (台)	小型車 (台)	大型車 (台)	合計 (台)	大型車 混入率 (%)	時間 係数 (%)	二輪車 (台)
7:00-7:15	5	6	11	54.5	0.7	0	18	9	27	33.3	0.9	2
7:15-7:30	10	3	13	23.1	0.9	0	18	3	21	14.3	0.7	1
7:30-7:45	12	4	16	25.0	1.1	0	21	6	27	22.2	0.9	3
7:45-8:00	8	2	10	20.0	0.7	0	20	1	21	4.8	0.7	1
1時間計	35	15	50	30.0	3.3	0	77	19	96	19.8	3.2	7
8:00-8:15	7	2	9	22.2	0.6	0	27	8	35	22.9	1.2	2
8:15-8:30	8	4	12	33.3	0.8	1	20	2	22	9.1	0.7	0
8:30-8:45	9	2	11	18.2	0.7	0	20	5	25	20.0	0.8	0
8:45-9:00	9	4	13	30.8	0.9	0	24	3	27	11.1	0.9	0
1時間計	33	12	45	26.7	3.0	1	91	18	109	16.5	3.6	2
9:00-9:15	9	2	11	18.2	0.7	0	12	1	13	7.7	0.4	0
9:15-9:30	9	1	10	10.0	0.7	1	19	6	25	24.0	0.8	4
9:30-9:45	19	7	26	26.9	1.7	0	15	9	24	37.5	0.8	0
9:45-10:00	9	3	12	25.0	0.8	1	17	1	18	5.6	0.6	0
1時間計	46	13	59	22.0	3.9	2	63	17	80	21.3	2.7	4
10:00-10:15	3	5	8	62.5	0.5	0	21	6	27	22.2	0.9	2
10:15-10:30	8	4	12	33.3	0.8	0	24	3	27	11.1	0.9	1
10:30-10:45	8	4	12	33.3	0.8	2	21	3	24	12.5	0.8	0
10:45-11:00	10	4	14	28.6	0.9	1	27	3	30	10.0	1.0	1
1時間計	29	17	46	37.0	3.0	3	93	15	108	13.9	3.6	4
11:00-11:15	3	3	6	50.0	0.4	0	30	3	33	9.1	1.1	0
11:15-11:30	12	4	16	25.0	1.1	0	26	5	31	16.1	1.0	2
11:30-11:45	14	6	20	30.0	1.3	0	35	2	37	5.4	1.2	5
11:45-12:00	11	6	17	35.3	1.1	0	47	6	53	11.3	1.8	0
1時間計	40	19	59	32.2	3.9	0	138	16	154	10.4	5.1	7
12:00-12:15	8	3	11	27.3	0.7	0	32	1	33	3.0	1.1	2
12:15-12:30	12	5	17	29.4	1.1	0	41	2	43	4.7	1.4	1
12:30-12:45	11	2	13	15.4	0.9	0	49	3	52	5.8	1.7	0
12:45-13:00	12	1	13	7.7	0.9	1	39	7	46	15.2	1.5	3
1時間計	43	11	54	20.4	3.5	1	161	13	174	7.5	5.8	6
13:00-13:15	14	4	18	22.2	1.2	0	59	1	60	1.7	2.0	4
13:15-13:30	11	3	14	21.4	0.9	0	55	2	57	3.5	1.9	0
13:30-13:45	11	7	18	38.9	1.2	2	43	3	46	6.5	1.5	2
13:45-14:00	18	5	23	21.7	1.5	2	52	4	56	7.1	1.9	4
1時間計	54	19	73	26.0	4.8	4	209	10	219	4.6	7.3	10
14:00-14:15	14	4	18	22.2	1.2	1	51	3	54	5.6	1.8	3
14:15-14:30	15	3	18	16.7	1.2	0	44	3	47	6.4	1.6	3
14:30-14:45	17	8	25	32.0	1.6	1	53	5	58	8.6	1.9	3
14:45-15:00	23	7	30	23.3	2.0	0	42	3	45	6.7	1.5	2
1時間計	69	22	91	24.2	6.0	2	190	14	204	6.9	6.8	11

方向別自動車交通量調査表

調査地点 : 地域社会 4 滝沢

調査年月日 : 令和 2年 9月21日(月・祝) 天候:曇りのち晴れ



方向 種別 時間帯	5						6					
	小型車 (台)	大型車 (台)	合計 (台)	大型車 混入率 (%)	時間 係数 (%)	二輪車 (台)	小型車 (台)	大型車 (台)	合計 (台)	大型車 混入率 (%)	時間 係数 (%)	二輪車 (台)
15:00-15:15	12	3	15	20.0	1.0	0	48	6	54	11.1	1.8	3
15:15-15:30	23	7	30	23.3	2.0	1	38	0	38	0.0	1.3	1
15:30-15:45	18	6	24	25.0	1.6	0	45	4	49	8.2	1.6	3
15:45-16:00	20	5	25	20.0	1.6	1	45	2	47	4.3	1.6	1
1時間計	73	21	94	22.3	6.2	2	176	12	188	6.4	6.3	8
16:00-16:15	25	2	27	7.4	1.8	1	47	2	49	4.1	1.6	3
16:15-16:30	21	5	26	19.2	1.7	0	42	2	44	4.5	1.5	7
16:30-16:45	18	5	23	21.7	1.5	2	67	4	71	5.6	2.4	1
16:45-17:00	20	7	27	25.9	1.8	0	40	1	41	2.4	1.4	2
1時間計	84	19	103	18.4	6.8	3	196	9	205	4.4	6.8	13
17:00-17:15	13	6	19	31.6	1.2	1	48	1	49	2.0	1.6	3
17:15-17:30	18	4	22	18.2	1.4	2	55	4	59	6.8	2.0	0
17:30-17:45	32	10	42	23.8	2.8	0	52	1	53	1.9	1.8	2
17:45-18:00	32	6	38	15.8	2.5	0	53	0	53	0.0	1.8	2
1時間計	95	26	121	21.5	8.0	3	208	6	214	2.8	7.1	7
18:00-18:15	41	12	53	22.6	3.5	2	68	7	75	9.3	2.5	3
18:15-18:30	35	1	36	2.8	2.4	1	81	1	82	1.2	2.7	5
18:30-18:45	30	6	36	16.7	2.4	0	54	1	55	1.8	1.8	5
18:45-19:00	40	4	44	9.1	2.9	0	52	1	53	1.9	1.8	2
1時間計	146	23	169	13.6	11.1	3	255	10	265	3.8	8.8	15
昼12時間計	747	217	964	22.5	63.3	24	1857	159	2016	7.9	67.1	94
19:00-19:15	20	7	27	25.9	1.8	0	48	0	48	0.0	1.6	1
19:15-19:30	16	1	17	5.9	1.1	0	40	1	41	2.4	1.4	3
19:30-19:45	16	4	20	20.0	1.3	0	56	0	56	0.0	1.9	5
19:45-20:00	15	3	18	16.7	1.2	1	50	1	51	2.0	1.7	2
1時間計	67	15	82	18.3	5.4	1	194	2	196	1.0	6.5	11
20:00-20:15	13	3	16	18.8	1.1	0	44	0	44	0.0	1.5	4
20:15-20:30	20	3	23	13.0	1.5	1	34	0	34	0.0	1.1	2
20:30-20:45	16	3	19	15.8	1.2	1	52	0	52	0.0	1.7	1
20:45-21:00	12	4	16	25.0	1.1	5	28	0	28	0.0	0.9	0
1時間計	61	13	74	17.6	4.9	7	158	0	158	0.0	5.3	7
21:00-21:15	8	2	10	20.0	0.7	0	31	1	32	3.1	1.1	1
21:15-21:30	13	5	18	27.8	1.2	0	26	2	28	7.1	0.9	2
21:30-21:45	9	3	12	25.0	0.8	0	18	2	20	10.0	0.7	1
21:45-22:00	11	2	13	15.4	0.9	0	36	0	36	0.0	1.2	2
1時間計	41	12	53	22.6	3.5	0	111	5	116	4.3	3.9	6
22:00-22:15	8	4	12	33.3	0.8	0	17	1	18	5.6	0.6	0
22:15-22:30	10	4	14	28.6	0.9	0	39	1	40	2.5	1.3	0
22:30-22:45	12	5	17	29.4	1.1	0	45	1	46	2.2	1.5	0
22:45-23:00	11	2	13	15.4	0.9	2	25	1	26	3.8	0.9	1
1時間計	41	15	56	26.8	3.7	2	126	4	130	3.1	4.3	1

方向別自動車交通量調査表

調査地点：地域社会4 滝沢

調査年月日：令和2年9月21日(月・祝) 天候：曇りのち晴れ



方向 種別 時間帯	5						6					
	小型車 (台)	大型車 (台)	合計 (台)	大型車 混入率 (%)	時間 係数 (%)	二輪車 (台)	小型車 (台)	大型車 (台)	合計 (台)	大型車 混入率 (%)	時間 係数 (%)	二輪車 (台)
23:00-23:15	8	0	8	0.0	0.5	0	23	2	25	8.0	0.8	1
23:15-23:30	9	2	11	18.2	0.7	0	26	0	26	0.0	0.9	1
23:30-23:45	7	5	12	41.7	0.8	0	35	1	36	2.8	1.2	1
23:45-24:00	6	4	10	40.0	0.7	0	15	0	15	0.0	0.5	0
1時間計	30	11	41	26.8	2.7	0	99	3	102	2.9	3.4	3
0:00-0:15	6	3	9	33.3	0.6	0	24	0	24	0.0	0.8	1
0:15-0:30	6	0	6	0.0	0.4	0	15	0	15	0.0	0.5	0
0:30-0:45	9	10	19	52.6	1.2	0	7	0	7	0.0	0.2	1
0:45-1:00	8	1	9	11.1	0.6	0	10	0	10	0.0	0.3	0
1時間計	29	14	43	32.6	2.8	0	56	0	56	0.0	1.9	2
1:00-1:15	5	5	10	50.0	0.7	0	14	1	15	6.7	0.5	0
1:15-1:30	3	9	12	75.0	0.8	0	17	1	18	5.6	0.6	0
1:30-1:45	5	12	17	70.6	1.1	0	3	1	4	25.0	0.1	0
1:45-2:00	4	3	7	42.9	0.5	0	7	1	8	12.5	0.3	2
1時間計	17	29	46	63.0	3.0	0	41	4	45	8.9	1.5	2
2:00-2:15	6	12	18	66.7	1.2	0	8	0	8	0.0	0.3	0
2:15-2:30	4	2	6	33.3	0.4	0	8	0	8	0.0	0.3	0
2:30-2:45	1	5	6	83.3	0.4	0	4	0	4	0.0	0.1	0
2:45-3:00	4	2	6	33.3	0.4	0	5	0	5	0.0	0.2	0
1時間計	15	21	36	58.3	2.4	0	25	0	25	0.0	0.8	0
3:00-3:15	7	2	9	22.2	0.6	0	4	3	7	42.9	0.2	0
3:15-3:30	0	2	2	100.0	0.1	0	5	1	6	16.7	0.2	0
3:30-3:45	3	2	5	40.0	0.3	0	8	1	9	11.1	0.3	0
3:45-4:00	0	0	0	0.0	0.0	0	2	1	3	33.3	0.1	0
1時間計	10	6	16	37.5	1.1	0	19	6	25	24.0	0.8	0
4:00-4:15	3	2	5	40.0	0.3	0	5	2	7	28.6	0.2	0
4:15-4:30	3	3	6	50.0	0.4	0	2	1	3	33.3	0.1	0
4:30-4:45	1	1	2	50.0	0.1	0	3	3	6	50.0	0.2	0
4:45-5:00	2	7	9	77.8	0.6	0	0	4	4	100.0	0.1	0
1時間計	9	13	22	59.1	1.4	0	10	10	20	50.0	0.7	0
5:00-5:15	2	4	6	66.7	0.4	2	0	8	8	100.0	0.3	0
5:15-5:30	2	1	3	33.3	0.2	3	7	11	18	61.1	0.6	1
5:30-5:45	11	6	17	35.3	1.1	0	6	3	9	33.3	0.3	1
5:45-6:00	3	5	8	62.5	0.5	0	13	2	15	13.3	0.5	0
1時間計	18	16	34	47.1	2.2	5	26	24	50	48.0	1.7	2
6:00-6:15	12	3	15	20.0	1.0	0	9	3	12	25.0	0.4	1
6:15-6:30	8	3	11	27.3	0.7	2	10	1	11	9.1	0.4	1
6:30-6:45	11	5	16	31.3	1.1	1	14	6	20	30.0	0.7	1
6:45-7:00	9	4	13	30.8	0.9	2	15	6	21	28.6	0.7	1
1時間計	40	15	55	27.3	3.6	5	48	16	64	25.0	2.1	4
夜12時間計	378	180	558	32.3	36.7	20	913	74	987	7.5	32.9	38
全時間合計	1125	397	1522	26.1	100.0	44	2770	233	3003	7.8	100.0	132
昼夜率	1.51	1.83	1.58	-	-	1.83	1.49	1.47	1.49	-	-	1.40

方向別自動車交通量調査表

調査地点：地域社会4 滝沢

調査年月日：令和2年9月21日(月・祝) 天候：曇りのち晴れ



方向 種別 時間帯							C 合計 (5+6)					
	小型車 (台)	大型車 (台)	合計 (台)	大型車 混入率 (%)	時間 係数 (%)	二輪車 (台)	小型車 (台)	大型車 (台)	合計 (台)	大型車 混入率 (%)	時間 係数 (%)	二輪車 (台)
7:00-7:15							23	15	38	39.5	0.8	2
7:15-7:30							28	6	34	17.6	0.8	1
7:30-7:45							33	10	43	23.3	1.0	3
7:45-8:00							28	3	31	9.7	0.7	1
1時間計							112	34	146	23.3	3.2	7
8:00-8:15							34	10	44	22.7	1.0	2
8:15-8:30							28	6	34	17.6	0.8	1
8:30-8:45							29	7	36	19.4	0.8	0
8:45-9:00							33	7	40	17.5	0.9	0
1時間計							124	30	154	19.5	3.4	3
9:00-9:15							21	3	24	12.5	0.5	0
9:15-9:30							28	7	35	20.0	0.8	5
9:30-9:45							34	16	50	32.0	1.1	0
9:45-10:00							26	4	30	13.3	0.7	1
1時間計							109	30	139	21.6	3.1	6
10:00-10:15							24	11	35	31.4	0.8	2
10:15-10:30							32	7	39	17.9	0.9	1
10:30-10:45							29	7	36	19.4	0.8	2
10:45-11:00							37	7	44	15.9	1.0	2
1時間計							122	32	154	20.8	3.4	7
11:00-11:15							33	6	39	15.4	0.9	0
11:15-11:30							38	9	47	19.1	1.0	2
11:30-11:45							49	8	57	14.0	1.3	5
11:45-12:00							58	12	70	17.1	1.5	0
1時間計							178	35	213	16.4	4.7	7
12:00-12:15							40	4	44	9.1	1.0	2
12:15-12:30							53	7	60	11.7	1.3	1
12:30-12:45							60	5	65	7.7	1.4	0
12:45-13:00							51	8	59	13.6	1.3	4
1時間計							204	24	228	10.5	5.0	7
13:00-13:15							73	5	78	6.4	1.7	4
13:15-13:30							66	5	71	7.0	1.6	0
13:30-13:45							54	10	64	15.6	1.4	4
13:45-14:00							70	9	79	11.4	1.7	6
1時間計							263	29	292	9.9	6.5	14
14:00-14:15							65	7	72	9.7	1.6	4
14:15-14:30							59	6	65	9.2	1.4	3
14:30-14:45							70	13	83	15.7	1.8	4
14:45-15:00							65	10	75	13.3	1.7	2
1時間計							259	36	295	12.2	6.5	13

方向別自動車交通量調査表

調査地点：地域社会4 滝沢

調査年月日：令和2年9月21日(月・祝) 天候：曇りのち晴れ



方向 種別 時間帯							C 合計 (5+6)					
	小型車 (台)	大型車 (台)	合計 (台)	大型車 混入率 (%)	時間 係数 (%)	二輪車 (台)	小型車 (台)	大型車 (台)	合計 (台)	大型車 混入率 (%)	時間 係数 (%)	二輪車 (台)
15:00-15:15							60	9	69	13.0	1.5	3
15:15-15:30							61	7	68	10.3	1.5	2
15:30-15:45							63	10	73	13.7	1.6	3
15:45-16:00							65	7	72	9.7	1.6	2
1時間計							249	33	282	11.7	6.2	10
16:00-16:15							72	4	76	5.3	1.7	4
16:15-16:30							63	7	70	10.0	1.5	7
16:30-16:45							85	9	94	9.6	2.1	3
16:45-17:00							60	8	68	11.8	1.5	2
1時間計							280	28	308	9.1	6.8	16
17:00-17:15							61	7	68	10.3	1.5	4
17:15-17:30							73	8	81	9.9	1.8	2
17:30-17:45							84	11	95	11.6	2.1	2
17:45-18:00							85	6	91	6.6	2.0	2
1時間計							303	32	335	9.6	7.4	10
18:00-18:15							109	19	128	14.8	2.8	5
18:15-18:30							116	2	118	1.7	2.6	6
18:30-18:45							84	7	91	7.7	2.0	5
18:45-19:00							92	5	97	5.2	2.1	2
1時間計							401	33	434	7.6	9.6	18
昼12時間計							2604	376	2980	12.6	65.9	118
19:00-19:15							68	7	75	9.3	1.7	1
19:15-19:30							56	2	58	3.4	1.3	3
19:30-19:45							72	4	76	5.3	1.7	5
19:45-20:00							65	4	69	5.8	1.5	3
1時間計							261	17	278	6.1	6.1	12
20:00-20:15							57	3	60	5.0	1.3	4
20:15-20:30							54	3	57	5.3	1.3	3
20:30-20:45							68	3	71	4.2	1.6	2
20:45-21:00							40	4	44	9.1	1.0	5
1時間計							219	13	232	5.6	5.1	14
21:00-21:15							39	3	42	7.1	0.9	1
21:15-21:30							39	7	46	15.2	1.0	2
21:30-21:45							27	5	32	15.6	0.7	1
21:45-22:00							47	2	49	4.1	1.1	2
1時間計							152	17	169	10.1	3.7	6
22:00-22:15							25	5	30	16.7	0.7	0
22:15-22:30							49	5	54	9.3	1.2	0
22:30-22:45							57	6	63	9.5	1.4	0
22:45-23:00							36	3	39	7.7	0.9	3
1時間計							167	19	186	10.2	4.1	3

方向別自動車交通量調査表

調査地点：地域社会4 滝沢

調査年月日：令和2年9月21日(月・祝) 天候：曇りのち晴れ



方向 種別 時間帯							C 合計 (5+6)					
	小型車 (台)	大型車 (台)	合計 (台)	大型車 混入率 (%)	時間 係数 (%)	二輪車 (台)	小型車 (台)	大型車 (台)	合計 (台)	大型車 混入率 (%)	時間 係数 (%)	二輪車 (台)
23:00-23:15							31	2	33	6.1	0.7	1
23:15-23:30							35	2	37	5.4	0.8	1
23:30-23:45							42	6	48	12.5	1.1	1
23:45-24:00							21	4	25	16.0	0.6	0
1時間計							129	14	143	9.8	3.2	3
0:00-0:15							30	3	33	9.1	0.7	1
0:15-0:30							21	0	21	0.0	0.5	0
0:30-0:45							16	10	26	38.5	0.6	1
0:45-1:00							18	1	19	5.3	0.4	0
1時間計							85	14	99	14.1	2.2	2
1:00-1:15							19	6	25	24.0	0.6	0
1:15-1:30							20	10	30	33.3	0.7	0
1:30-1:45							8	13	21	61.9	0.5	0
1:45-2:00							11	4	15	26.7	0.3	2
1時間計							58	33	91	36.3	2.0	2
2:00-2:15							14	12	26	46.2	0.6	0
2:15-2:30							12	2	14	14.3	0.3	0
2:30-2:45							5	5	10	50.0	0.2	0
2:45-3:00							9	2	11	18.2	0.2	0
1時間計							40	21	61	34.4	1.3	0
3:00-3:15							11	5	16	31.3	0.4	0
3:15-3:30							5	3	8	37.5	0.2	0
3:30-3:45							11	3	14	21.4	0.3	0
3:45-4:00							2	1	3	33.3	0.1	0
1時間計							29	12	41	29.3	0.9	0
4:00-4:15							8	4	12	33.3	0.3	0
4:15-4:30							5	4	9	44.4	0.2	0
4:30-4:45							4	4	8	50.0	0.2	0
4:45-5:00							2	11	13	84.6	0.3	0
1時間計							19	23	42	54.8	0.9	0
5:00-5:15							2	12	14	85.7	0.3	2
5:15-5:30							9	12	21	57.1	0.5	4
5:30-5:45							17	9	26	34.6	0.6	1
5:45-6:00							16	7	23	30.4	0.5	0
1時間計							44	40	84	47.6	1.9	7
6:00-6:15							21	6	27	22.2	0.6	1
6:15-6:30							18	4	22	18.2	0.5	3
6:30-6:45							25	11	36	30.6	0.8	2
6:45-7:00							24	10	34	29.4	0.8	3
1時間計							88	31	119	26.1	2.6	9
夜12時間計							1291	254	1545	16.4	34.1	58
全時間合計							3895	630	4525	13.9	100.0	176
昼夜率							1.50	1.68	1.52	-	-	1.49

方向別自動車交通量調査表

調査地点：地域社会4 瀬谷土橋公園入口

調査年月日：令和2年9月21日(月・祝) 天候：曇りのち晴れ



方向 時間帯	1						2					
	種別 小型車 (台)	大型車 (台)	合計 (台)	大型車 混入率 (%)	時間 係数 (%)	二輪車 (台)	小型車 (台)	大型車 (台)	合計 (台)	大型車 混入率 (%)	時間 係数 (%)	二輪車 (台)
7:00-7:15	12	6	18	33.3	1.0	1	55	7	62	11.3	0.8	5
7:15-7:30	21	7	28	25.0	1.6	1	77	13	90	14.4	1.2	6
7:30-7:45	21	5	26	19.2	1.5	0	81	9	90	10.0	1.2	7
7:45-8:00	24	4	28	14.3	1.6	0	74	5	79	6.3	1.1	6
1時間計	78	22	100	22.0	5.7	2	287	34	321	10.6	4.3	24
8:00-8:15	25	3	28	10.7	1.6	0	97	14	111	12.6	1.5	10
8:15-8:30	33	2	35	5.7	2.0	0	88	13	101	12.9	1.3	8
8:30-8:45	43	4	47	8.5	2.7	2	115	14	129	10.9	1.7	4
8:45-9:00	27	5	32	15.6	1.8	2	123	11	134	8.2	1.8	7
1時間計	128	14	142	9.9	8.0	4	423	52	475	10.9	6.3	29
9:00-9:15	29	1	30	3.3	1.7	0	101	14	115	12.2	1.5	9
9:15-9:30	34	3	37	8.1	2.1	2	119	14	133	10.5	1.8	15
9:30-9:45	29	3	32	9.4	1.8	2	105	9	114	7.9	1.5	4
9:45-10:00	16	1	17	5.9	1.0	0	67	6	73	8.2	1.0	7
1時間計	108	8	116	6.9	6.6	4	392	43	435	9.9	5.8	35
10:00-10:15	21	2	23	8.7	1.3	0	78	11	89	12.4	1.2	3
10:15-10:30	32	2	34	5.9	1.9	1	99	15	114	13.2	1.5	4
10:30-10:45	27	0	27	0.0	1.5	1	91	18	109	16.5	1.5	6
10:45-11:00	24	3	27	11.1	1.5	2	97	16	113	14.2	1.5	3
1時間計	104	7	111	6.3	6.3	4	365	60	425	14.1	5.7	16
11:00-11:15	28	3	31	9.7	1.8	2	85	16	101	15.8	1.3	3
11:15-11:30	18	1	19	5.3	1.1	0	71	12	83	14.5	1.1	3
11:30-11:45	27	7	34	20.6	1.9	0	93	21	114	18.4	1.5	2
11:45-12:00	37	9	46	19.6	2.6	4	120	21	141	14.9	1.9	10
1時間計	110	20	130	15.4	7.4	6	369	70	439	15.9	5.9	18
12:00-12:15	43	9	52	17.3	2.9	0	113	16	129	12.4	1.7	6
12:15-12:30	44	5	49	10.2	2.8	0	141	21	162	13.0	2.2	6
12:30-12:45	39	6	45	13.3	2.5	1	169	19	188	10.1	2.5	3
12:45-13:00	30	2	32	6.3	1.8	1	102	16	118	13.6	1.6	6
1時間計	156	22	178	12.4	10.1	2	525	72	597	12.1	8.0	21
13:00-13:15	42	7	49	14.3	2.8	4	145	16	161	9.9	2.1	6
13:15-13:30	34	8	42	19.0	2.4	0	111	9	120	7.5	1.6	7
13:30-13:45	39	6	45	13.3	2.5	2	136	20	156	12.8	2.1	12
13:45-14:00	26	10	36	27.8	2.0	1	135	17	152	11.2	2.0	4
1時間計	141	31	172	18.0	9.7	7	527	62	589	10.5	7.9	29
14:00-14:15	20	9	29	31.0	1.6	0	104	8	112	7.1	1.5	9
14:15-14:30	26	5	31	16.1	1.8	2	138	12	150	8.0	2.0	3
14:30-14:45	13	7	20	35.0	1.1	0	110	13	123	10.6	1.6	10
14:45-15:00	26	5	31	16.1	1.8	1	122	16	138	11.6	1.8	10
1時間計	85	26	111	23.4	6.3	3	474	49	523	9.4	7.0	32

方向別自動車交通量調査表

調査地点：地域社会4 瀬谷土橋公園入口

調査年月日：令和2年9月21日(月・祝) 天候：曇りのち晴れ



方向 種別 時間帯	1						2					
	小型車 (台)	大型車 (台)	合計 (台)	大型車 混入率 (%)	時間 係数 (%)	二輪車 (台)	小型車 (台)	大型車 (台)	合計 (台)	大型車 混入率 (%)	時間 係数 (%)	二輪車 (台)
15:00-15:15	20	2	22	9.1	1.2	3	132	14	146	9.6	1.9	5
15:15-15:30	14	10	24	41.7	1.4	2	160	10	170	5.9	2.3	4
15:30-15:45	22	5	27	18.5	1.5	1	127	8	135	5.9	1.8	12
15:45-16:00	16	2	18	11.1	1.0	2	122	14	136	10.3	1.8	2
1時間計	72	19	91	20.9	5.2	8	541	46	587	7.8	7.8	23
16:00-16:15	24	5	29	17.2	1.6	0	129	16	145	11.0	1.9	7
16:15-16:30	12	3	15	20.0	0.8	0	131	19	150	12.7	2.0	7
16:30-16:45	18	7	25	28.0	1.4	1	105	8	113	7.1	1.5	4
16:45-17:00	22	3	25	12.0	1.4	1	130	10	140	7.1	1.9	7
1時間計	76	18	94	19.1	5.3	2	495	53	548	9.7	7.3	25
17:00-17:15	19	6	25	24.0	1.4	1	109	9	118	7.6	1.6	4
17:15-17:30	17	1	18	5.6	1.0	0	113	7	120	5.8	1.6	8
17:30-17:45	19	8	27	29.6	1.5	0	124	16	140	11.4	1.9	10
17:45-18:00	17	5	22	22.7	1.2	1	109	13	122	10.7	1.6	6
1時間計	72	20	92	21.7	5.2	2	455	45	500	9.0	6.7	28
18:00-18:15	12	3	15	20.0	0.8	1	141	15	156	9.6	2.1	6
18:15-18:30	10	3	13	23.1	0.7	0	138	3	141	2.1	1.9	12
18:30-18:45	11	5	16	31.3	0.9	0	114	8	122	6.6	1.6	3
18:45-19:00	17	3	20	15.0	1.1	0	139	2	141	1.4	1.9	1
1時間計	50	14	64	21.9	3.6	1	532	28	560	5.0	7.5	22
昼12時間計	1180	221	1401	15.8	79.4	45	5385	614	5999	10.2	80.0	302
19:00-19:15	13	3	16	18.8	0.9	0	100	6	106	5.7	1.4	6
19:15-19:30	14	1	15	6.7	0.8	0	58	2	60	3.3	0.8	3
19:30-19:45	16	2	18	11.1	1.0	0	75	3	78	3.8	1.0	5
19:45-20:00	6	1	7	14.3	0.4	0	74	1	75	1.3	1.0	4
1時間計	49	7	56	12.5	3.2	0	307	12	319	3.8	4.3	18
20:00-20:15	9	4	13	30.8	0.7	0	54	1	55	1.8	0.7	4
20:15-20:30	11	3	14	21.4	0.8	0	70	0	70	0.0	0.9	3
20:30-20:45	8	1	9	11.1	0.5	0	67	3	70	4.3	0.9	2
20:45-21:00	10	1	11	9.1	0.6	0	50	4	54	7.4	0.7	3
1時間計	38	9	47	19.1	2.7	0	241	8	249	3.2	3.3	12
21:00-21:15	6	2	8	25.0	0.5	0	45	2	47	4.3	0.6	1
21:15-21:30	5	3	8	37.5	0.5	0	40	3	43	7.0	0.6	2
21:30-21:45	7	1	8	12.5	0.5	0	36	3	39	7.7	0.5	7
21:45-22:00	9	3	12	25.0	0.7	0	23	0	23	0.0	0.3	5
1時間計	27	9	36	25.0	2.0	0	144	8	152	5.3	2.0	15
22:00-22:15	3	3	6	50.0	0.3	0	41	4	45	8.9	0.6	7
22:15-22:30	6	3	9	33.3	0.5	0	28	0	28	0.0	0.4	0
22:30-22:45	6	4	10	40.0	0.6	0	25	1	26	3.8	0.3	1
22:45-23:00	3	0	3	0.0	0.2	0	23	3	26	11.5	0.3	3
1時間計	18	10	28	35.7	1.6	0	117	8	125	6.4	1.7	11

方向別自動車交通量調査表

調査地点：地域社会4 瀬谷土橋公園入口

調査年月日：令和2年9月21日(月・祝) 天候：曇りのち晴れ



方向 種別 時間帯	1						2					
	小型車 (台)	大型車 (台)	合計 (台)	大型車 混入率 (%)	時間 係数 (%)	二輪車 (台)	小型車 (台)	大型車 (台)	合計 (台)	大型車 混入率 (%)	時間 係数 (%)	二輪車 (台)
23:00-23:15	5	0	5	0.0	0.3	0	23	3	26	11.5	0.3	0
23:15-23:30	5	2	7	28.6	0.4	2	26	0	26	0.0	0.3	0
23:30-23:45	4	2	6	33.3	0.3	0	17	0	17	0.0	0.2	2
23:45-24:00	3	1	4	25.0	0.2	0	21	3	24	12.5	0.3	0
1時間計	17	5	22	22.7	1.2	2	87	6	93	6.5	1.2	2
0:00-0:15	3	1	4	25.0	0.2	0	13	2	15	13.3	0.2	2
0:15-0:30	6	3	9	33.3	0.5	0	25	5	30	16.7	0.4	2
0:30-0:45	4	6	10	60.0	0.6	0	10	5	15	33.3	0.2	0
0:45-1:00	3	4	7	57.1	0.4	0	17	5	22	22.7	0.3	1
1時間計	16	14	30	46.7	1.7	0	65	17	82	20.7	1.1	5
1:00-1:15	1	4	5	80.0	0.3	0	11	4	15	26.7	0.2	0
1:15-1:30	2	9	11	81.8	0.6	1	7	5	12	41.7	0.2	1
1:30-1:45	1	5	6	83.3	0.3	0	12	2	14	14.3	0.2	2
1:45-2:00	0	4	4	100.0	0.2	0	10	0	10	0.0	0.1	0
1時間計	4	22	26	84.6	1.5	1	40	11	51	21.6	0.7	3
2:00-2:15	1	3	4	75.0	0.2	0	10	6	16	37.5	0.2	0
2:15-2:30	1	3	4	75.0	0.2	0	4	2	6	33.3	0.1	0
2:30-2:45	0	6	6	100.0	0.3	0	11	3	14	21.4	0.2	1
2:45-3:00	0	0	0	0.0	0.0	0	5	0	5	0.0	0.1	1
1時間計	2	12	14	85.7	0.8	0	30	11	41	26.8	0.5	2
3:00-3:15	1	1	2	50.0	0.1	0	15	4	19	21.1	0.3	1
3:15-3:30	0	1	1	100.0	0.1	0	7	3	10	30.0	0.1	1
3:30-3:45	2	1	3	33.3	0.2	0	10	3	13	23.1	0.2	0
3:45-4:00	1	0	1	0.0	0.1	0	8	1	9	11.1	0.1	0
1時間計	4	3	7	42.9	0.4	0	40	11	51	21.6	0.7	2
4:00-4:15	3	0	3	0.0	0.2	0	7	5	12	41.7	0.2	0
4:15-4:30	2	3	5	60.0	0.3	0	8	0	8	0.0	0.1	0
4:30-4:45	2	0	2	0.0	0.1	0	7	2	9	22.2	0.1	0
4:45-5:00	2	5	7	71.4	0.4	0	7	4	11	36.4	0.1	3
1時間計	9	8	17	47.1	1.0	0	29	11	40	27.5	0.5	3
5:00-5:15	4	1	5	20.0	0.3	0	18	2	20	10.0	0.3	1
5:15-5:30	3	3	6	50.0	0.3	0	16	2	18	11.1	0.2	3
5:30-5:45	7	6	13	46.2	0.7	0	20	4	24	16.7	0.3	3
5:45-6:00	8	1	9	11.1	0.5	0	16	3	19	15.8	0.3	2
1時間計	22	11	33	33.3	1.9	0	70	11	81	13.6	1.1	9
6:00-6:15	10	1	11	9.1	0.6	1	36	6	42	14.3	0.6	2
6:15-6:30	9	2	11	18.2	0.6	0	44	4	48	8.3	0.6	10
6:30-6:45	10	5	15	33.3	0.8	0	54	7	61	11.5	0.8	3
6:45-7:00	10	1	11	9.1	0.6	2	53	9	62	14.5	0.8	2
1時間計	39	9	48	18.8	2.7	3	187	26	213	12.2	2.8	17
夜12時間計	245	119	364	32.7	20.6	6	1357	140	1497	9.4	20.0	99
全時間合計	1425	340	1765	19.3	100.0	51	6742	754	7496	10.1	100.0	401
昼夜率	1.21	1.54	1.26	-	-	1.13	1.25	1.23	1.25	-	-	1.33

方向別自動車交通量調査表

調査地点：地域社会4 瀬谷土橋公園入口

調査年月日：令和2年9月21日(月・祝) 天候：曇りのち晴れ



方向 種別 時間帯							A 合計 (1+2)					
	小型車 (台)	大型車 (台)	合計 (台)	大型車 混入率 (%)	時間 係数 (%)	二輪車 (台)	小型車 (台)	大型車 (台)	合計 (台)	大型車 混入率 (%)	時間 係数 (%)	二輪車 (台)
7:00-7:15							67	13	80	16.3	0.9	6
7:15-7:30							98	20	118	16.9	1.3	7
7:30-7:45							102	14	116	12.1	1.3	7
7:45-8:00							98	9	107	8.4	1.2	6
1時間計							365	56	421	13.3	4.5	26
8:00-8:15							122	17	139	12.2	1.5	10
8:15-8:30							121	15	136	11.0	1.5	8
8:30-8:45							158	18	176	10.2	1.9	6
8:45-9:00							150	16	166	9.6	1.8	9
1時間計							551	66	617	10.7	6.7	33
9:00-9:15							130	15	145	10.3	1.6	9
9:15-9:30							153	17	170	10.0	1.8	17
9:30-9:45							134	12	146	8.2	1.6	6
9:45-10:00							83	7	90	7.8	1.0	7
1時間計							500	51	551	9.3	5.9	39
10:00-10:15							99	13	112	11.6	1.2	3
10:15-10:30							131	17	148	11.5	1.6	5
10:30-10:45							118	18	136	13.2	1.5	7
10:45-11:00							121	19	140	13.6	1.5	5
1時間計							469	67	536	12.5	5.8	20
11:00-11:15							113	19	132	14.4	1.4	5
11:15-11:30							89	13	102	12.7	1.1	3
11:30-11:45							120	28	148	18.9	1.6	2
11:45-12:00							157	30	187	16.0	2.0	14
1時間計							479	90	569	15.8	6.1	24
12:00-12:15							156	25	181	13.8	2.0	6
12:15-12:30							185	26	211	12.3	2.3	6
12:30-12:45							208	25	233	10.7	2.5	4
12:45-13:00							132	18	150	12.0	1.6	7
1時間計							681	94	775	12.1	8.4	23
13:00-13:15							187	23	210	11.0	2.3	10
13:15-13:30							145	17	162	10.5	1.7	7
13:30-13:45							175	26	201	12.9	2.2	14
13:45-14:00							161	27	188	14.4	2.0	5
1時間計							668	93	761	12.2	8.2	36
14:00-14:15							124	17	141	12.1	1.5	9
14:15-14:30							164	17	181	9.4	2.0	5
14:30-14:45							123	20	143	14.0	1.5	10
14:45-15:00							148	21	169	12.4	1.8	11
1時間計							559	75	634	11.8	6.8	35

方向別自動車交通量調査表

調査地点 : 地域社会 4 瀬谷土橋公園入口

調査年月日 : 令和 2年 9月21日(月・祝) 天候:曇りのち晴れ



方向 種別 時間帯							A 合計 (1+2)					
	小型車 (台)	大型車 (台)	合計 (台)	大型車 混入率 (%)	時間 係数 (%)	二輪車 (台)	小型車 (台)	大型車 (台)	合計 (台)	大型車 混入率 (%)	時間 係数 (%)	二輪車 (台)
15:00-15:15							152	16	168	9.5	1.8	8
15:15-15:30							174	20	194	10.3	2.1	6
15:30-15:45							149	13	162	8.0	1.7	13
15:45-16:00							138	16	154	10.4	1.7	4
1時間計							613	65	678	9.6	7.3	31
16:00-16:15							153	21	174	12.1	1.9	7
16:15-16:30							143	22	165	13.3	1.8	7
16:30-16:45							123	15	138	10.9	1.5	5
16:45-17:00							152	13	165	7.9	1.8	8
1時間計							571	71	642	11.1	6.9	27
17:00-17:15							128	15	143	10.5	1.5	5
17:15-17:30							130	8	138	5.8	1.5	8
17:30-17:45							143	24	167	14.4	1.8	10
17:45-18:00							126	18	144	12.5	1.6	7
1時間計							527	65	592	11.0	6.4	30
18:00-18:15							153	18	171	10.5	1.8	7
18:15-18:30							148	6	154	3.9	1.7	12
18:30-18:45							125	13	138	9.4	1.5	3
18:45-19:00							156	5	161	3.1	1.7	1
1時間計							582	42	624	6.7	6.7	23
昼12時間計							6565	835	7400	11.3	79.9	347
19:00-19:15							113	9	122	7.4	1.3	6
19:15-19:30							72	3	75	4.0	0.8	3
19:30-19:45							91	5	96	5.2	1.0	5
19:45-20:00							80	2	82	2.4	0.9	4
1時間計							356	19	375	5.1	4.0	18
20:00-20:15							63	5	68	7.4	0.7	4
20:15-20:30							81	3	84	3.6	0.9	3
20:30-20:45							75	4	79	5.1	0.9	2
20:45-21:00							60	5	65	7.7	0.7	3
1時間計							279	17	296	5.7	3.2	12
21:00-21:15							51	4	55	7.3	0.6	1
21:15-21:30							45	6	51	11.8	0.6	2
21:30-21:45							43	4	47	8.5	0.5	7
21:45-22:00							32	3	35	8.6	0.4	5
1時間計							171	17	188	9.0	2.0	15
22:00-22:15							44	7	51	13.7	0.6	7
22:15-22:30							34	3	37	8.1	0.4	0
22:30-22:45							31	5	36	13.9	0.4	1
22:45-23:00							26	3	29	10.3	0.3	3
1時間計							135	18	153	11.8	1.7	11

方向別自動車交通量調査表

調査地点：地域社会4 瀬谷土橋公園入口

調査年月日：令和2年9月21日(月・祝) 天候：曇りのち晴れ



方向 種別 時間帯							A 合計 (1+2)					
	小型車 (台)	大型車 (台)	合計 (台)	大型車 混入率 (%)	時間 係数 (%)	二輪車 (台)	小型車 (台)	大型車 (台)	合計 (台)	大型車 混入率 (%)	時間 係数 (%)	二輪車 (台)
23:00-23:15							28	3	31	9.7	0.3	0
23:15-23:30							31	2	33	6.1	0.4	2
23:30-23:45							21	2	23	8.7	0.2	2
23:45-24:00							24	4	28	14.3	0.3	0
1時間計							104	11	115	9.6	1.2	4
0:00-0:15							16	3	19	15.8	0.2	2
0:15-0:30							31	8	39	20.5	0.4	2
0:30-0:45							14	11	25	44.0	0.3	0
0:45-1:00							20	9	29	31.0	0.3	1
1時間計							81	31	112	27.7	1.2	5
1:00-1:15							12	8	20	40.0	0.2	0
1:15-1:30							9	14	23	60.9	0.2	2
1:30-1:45							13	7	20	35.0	0.2	2
1:45-2:00							10	4	14	28.6	0.2	0
1時間計							44	33	77	42.9	0.8	4
2:00-2:15							11	9	20	45.0	0.2	0
2:15-2:30							5	5	10	50.0	0.1	0
2:30-2:45							11	9	20	45.0	0.2	1
2:45-3:00							5	0	5	0.0	0.1	1
1時間計							32	23	55	41.8	0.6	2
3:00-3:15							16	5	21	23.8	0.2	1
3:15-3:30							7	4	11	36.4	0.1	1
3:30-3:45							12	4	16	25.0	0.2	0
3:45-4:00							9	1	10	10.0	0.1	0
1時間計							44	14	58	24.1	0.6	2
4:00-4:15							10	5	15	33.3	0.2	0
4:15-4:30							10	3	13	23.1	0.1	0
4:30-4:45							9	2	11	18.2	0.1	0
4:45-5:00							9	9	18	50.0	0.2	3
1時間計							38	19	57	33.3	0.6	3
5:00-5:15							22	3	25	12.0	0.3	1
5:15-5:30							19	5	24	20.8	0.3	3
5:30-5:45							27	10	37	27.0	0.4	3
5:45-6:00							24	4	28	14.3	0.3	2
1時間計							92	22	114	19.3	1.2	9
6:00-6:15							46	7	53	13.2	0.6	3
6:15-6:30							53	6	59	10.2	0.6	10
6:30-6:45							64	12	76	15.8	0.8	3
6:45-7:00							63	10	73	13.7	0.8	4
1時間計							226	35	261	13.4	2.8	20
夜12時間計							1602	259	1861	13.9	20.1	105
全時間合計							8167	1094	9261	11.8	100.0	452
昼夜率							1.24	1.31	1.25	-	-	1.30

方向別自動車交通量調査表

調査地点：地域社会4 瀬谷土橋公園入口

調査年月日：令和2年9月21日(月・祝) 天候：曇りのち晴れ



方向	3						4						
	種別	小型車 (台)	大型車 (台)	合計 (台)	大型車 混入率 (%)	時間 係数 (%)	二輪車 (台)	小型車 (台)	大型車 (台)	合計 (台)	大型車 混入率 (%)	時間 係数 (%)	二輪車 (台)
7:00-7:15		56	6	62	9.7	1.0	9	7	3	10	30.0	1.1	0
7:15-7:30		55	10	65	15.4	1.1	3	14	3	17	17.6	1.9	0
7:30-7:45		78	12	90	13.3	1.5	8	15	4	19	21.1	2.1	0
7:45-8:00		66	8	74	10.8	1.2	6	25	1	26	3.8	2.9	2
1時間計		255	36	291	12.4	4.8	26	61	11	72	15.3	8.0	2
8:00-8:15		60	8	68	11.8	1.1	8	18	3	21	14.3	2.3	0
8:15-8:30		87	7	94	7.4	1.6	3	10	2	12	16.7	1.3	0
8:30-8:45		74	10	84	11.9	1.4	1	8	1	9	11.1	1.0	0
8:45-9:00		73	22	95	23.2	1.6	3	10	2	12	16.7	1.3	0
1時間計		294	47	341	13.8	5.7	15	46	8	54	14.8	6.0	0
9:00-9:15		46	20	66	30.3	1.1	5	9	2	11	18.2	1.2	0
9:15-9:30		80	14	94	14.9	1.6	11	14	0	14	0.0	1.5	0
9:30-9:45		67	17	84	20.2	1.4	4	6	0	6	0.0	0.7	1
9:45-10:00		98	17	115	14.8	1.9	1	9	0	9	0.0	1.0	0
1時間計		291	68	359	18.9	6.0	21	38	2	40	5.0	4.4	1
10:00-10:15		102	16	118	13.6	2.0	1	1	1	2	50.0	0.2	1
10:15-10:30		55	7	62	11.3	1.0	5	4	1	5	20.0	0.6	0
10:30-10:45		73	15	88	17.0	1.5	2	10	2	12	16.7	1.3	1
10:45-11:00		73	5	78	6.4	1.3	3	9	0	9	0.0	1.0	0
1時間計		303	43	346	12.4	5.7	11	24	4	28	14.3	3.1	2
11:00-11:15		84	11	95	11.6	1.6	3	9	1	10	10.0	1.1	0
11:15-11:30		62	9	71	12.7	1.2	7	5	1	6	16.7	0.7	0
11:30-11:45		73	4	77	5.2	1.3	2	17	0	17	0.0	1.9	1
11:45-12:00		71	8	79	10.1	1.3	7	14	1	15	6.7	1.7	0
1時間計		290	32	322	9.9	5.3	19	45	3	48	6.3	5.3	1
12:00-12:15		76	9	85	10.6	1.4	7	17	3	20	15.0	2.2	0
12:15-12:30		69	4	73	5.5	1.2	4	11	0	11	0.0	1.2	0
12:30-12:45		84	7	91	7.7	1.5	5	9	0	9	0.0	1.0	0
12:45-13:00		78	5	83	6.0	1.4	2	16	2	18	11.1	2.0	0
1時間計		307	25	332	7.5	5.5	18	53	5	58	8.6	6.4	0
13:00-13:15		75	3	78	3.8	1.3	7	12	1	13	7.7	1.4	0
13:15-13:30		60	8	68	11.8	1.1	5	10	1	11	9.1	1.2	1
13:30-13:45		89	8	97	8.2	1.6	8	17	4	21	19.0	2.3	1
13:45-14:00		74	6	80	7.5	1.3	3	10	2	12	16.7	1.3	0
1時間計		298	25	323	7.7	5.4	23	49	8	57	14.0	6.3	2
14:00-14:15		78	14	92	15.2	1.5	2	12	3	15	20.0	1.7	0
14:15-14:30		84	5	89	5.6	1.5	7	13	1	14	7.1	1.5	0
14:30-14:45		66	3	69	4.3	1.1	11	13	2	15	13.3	1.7	1
14:45-15:00		84	9	93	9.7	1.5	6	13	0	13	0.0	1.4	0
1時間計		312	31	343	9.0	5.7	26	51	6	57	10.5	6.3	1

方向別自動車交通量調査表

調査地点：地域社会4 瀬谷土橋公園入口

調査年月日：令和2年9月21日(月・祝) 天候：曇りのち晴れ



方向	3						4						
	種別	小型車 (台)	大型車 (台)	合計 (台)	大型車 混入率 (%)	時間 係数 (%)	二輪車 (台)	小型車 (台)	大型車 (台)	合計 (台)	大型車 混入率 (%)	時間 係数 (%)	二輪車 (台)
15:00-15:15		97	11	108	10.2	1.8	5	14	0	14	0.0	1.5	0
15:15-15:30		62	4	66	6.1	1.1	4	8	1	9	11.1	1.0	0
15:30-15:45		72	6	78	7.7	1.3	4	14	1	15	6.7	1.7	0
15:45-16:00		89	8	97	8.2	1.6	8	7	2	9	22.2	1.0	0
1時間計		320	29	349	8.3	5.8	21	43	4	47	8.5	5.2	0
16:00-16:15		73	4	77	5.2	1.3	4	14	0	14	0.0	1.5	0
16:15-16:30		82	3	85	3.5	1.4	5	10	1	11	9.1	1.2	0
16:30-16:45		95	8	103	7.8	1.7	5	13	1	14	7.1	1.5	0
16:45-17:00		96	5	101	5.0	1.7	7	8	0	8	0.0	0.9	0
1時間計		346	20	366	5.5	6.1	21	45	2	47	4.3	5.2	0
17:00-17:15		85	4	89	4.5	1.5	16	8	2	10	20.0	1.1	1
17:15-17:30		110	3	113	2.7	1.9	8	12	2	14	14.3	1.5	0
17:30-17:45		94	10	104	9.6	1.7	5	11	1	12	8.3	1.3	3
17:45-18:00		90	8	98	8.2	1.6	6	17	0	17	0.0	1.9	0
1時間計		379	25	404	6.2	6.7	35	48	5	53	9.4	5.9	4
18:00-18:15		124	4	128	3.1	2.1	10	10	0	10	0.0	1.1	0
18:15-18:30		132	4	136	2.9	2.3	1	3	0	3	0.0	0.3	0
18:30-18:45		107	2	109	1.8	1.8	7	5	1	6	16.7	0.7	0
18:45-19:00		100	7	107	6.5	1.8	6	9	2	11	18.2	1.2	0
1時間計		463	17	480	3.5	8.0	24	27	3	30	10.0	3.3	0
昼12時間計		3858	398	4256	9.4	70.6	260	530	61	591	10.3	65.3	13
19:00-19:15		115	2	117	1.7	1.9	13	19	0	19	0.0	2.1	0
19:15-19:30		81	3	84	3.6	1.4	7	5	0	5	0.0	0.6	0
19:30-19:45		85	5	90	5.6	1.5	5	11	1	12	8.3	1.3	0
19:45-20:00		93	4	97	4.1	1.6	4	6	0	6	0.0	0.7	0
1時間計		374	14	388	3.6	6.4	29	41	1	42	2.4	4.6	0
20:00-20:15		76	5	81	6.2	1.3	7	7	4	11	36.4	1.2	0
20:15-20:30		79	1	80	1.3	1.3	2	5	1	6	16.7	0.7	0
20:30-20:45		98	2	100	2.0	1.7	7	7	1	8	12.5	0.9	0
20:45-21:00		53	3	56	5.4	0.9	2	9	0	9	0.0	1.0	1
1時間計		306	11	317	3.5	5.3	18	28	6	34	17.6	3.8	1
21:00-21:15		79	3	82	3.7	1.4	4	7	0	7	0.0	0.8	0
21:15-21:30		90	3	93	3.2	1.5	4	8	0	8	0.0	0.9	0
21:30-21:45		70	2	72	2.8	1.2	3	11	0	11	0.0	1.2	2
21:45-22:00		69	1	70	1.4	1.2	1	16	1	17	5.9	1.9	0
1時間計		308	9	317	2.8	5.3	12	42	1	43	2.3	4.8	2
22:00-22:15		52	2	54	3.7	0.9	3	10	1	11	9.1	1.2	0
22:15-22:30		25	3	28	10.7	0.5	3	7	1	8	12.5	0.9	1
22:30-22:45		57	4	61	6.6	1.0	10	9	0	9	0.0	1.0	0
22:45-23:00		36	3	39	7.7	0.6	2	2	1	3	33.3	0.3	0
1時間計		170	12	182	6.6	3.0	18	28	3	31	9.7	3.4	1

方向別自動車交通量調査表

調査地点 : 地域社会4 瀬谷土橋公園入口

調査年月日 : 令和 2年 9月21日(月・祝) 天候:曇りのち晴れ



方向 種別 時間帯	3						4					
	小型車 (台)	大型車 (台)	合計 (台)	大型車 混入率 (%)	時間 係数 (%)	二輪車 (台)	小型車 (台)	大型車 (台)	合計 (台)	大型車 混入率 (%)	時間 係数 (%)	二輪車 (台)
23:00-23:15	29	4	33	12.1	0.5	1	3	1	4	25.0	0.4	0
23:15-23:30	28	3	31	9.7	0.5	3	1	2	3	66.7	0.3	0
23:30-23:45	12	1	13	7.7	0.2	0	1	1	2	50.0	0.2	0
23:45-24:00	27	1	28	3.6	0.5	1	6	1	7	14.3	0.8	0
1時間計	96	9	105	8.6	1.7	5	11	5	16	31.3	1.8	0
0:00-0:15	10	2	12	16.7	0.2	2	2	0	2	0.0	0.2	0
0:15-0:30	11	1	12	8.3	0.2	0	2	1	3	33.3	0.3	0
0:30-0:45	8	3	11	27.3	0.2	3	0	1	1	100.0	0.1	0
0:45-1:00	6	1	7	14.3	0.1	0	1	1	2	50.0	0.2	0
1時間計	35	7	42	16.7	0.7	5	5	3	8	37.5	0.9	0
1:00-1:15	9	1	10	10.0	0.2	3	4	1	5	20.0	0.6	0
1:15-1:30	12	1	13	7.7	0.2	2	3	0	3	0.0	0.3	0
1:30-1:45	3	1	4	25.0	0.1	2	2	0	2	0.0	0.2	0
1:45-2:00	2	1	3	33.3	0.0	1	1	1	2	50.0	0.2	0
1時間計	26	4	30	13.3	0.5	8	10	2	12	16.7	1.3	0
2:00-2:15	10	1	11	9.1	0.2	1	0	0	0	0.0	0.0	0
2:15-2:30	3	2	5	40.0	0.1	1	0	1	1	100.0	0.1	1
2:30-2:45	4	2	6	33.3	0.1	0	1	1	2	50.0	0.2	4
2:45-3:00	2	3	5	60.0	0.1	0	3	3	6	50.0	0.7	0
1時間計	19	8	27	29.6	0.4	2	4	5	9	55.6	1.0	5
3:00-3:15	2	1	3	33.3	0.0	0	0	1	1	100.0	0.1	0
3:15-3:30	8	4	12	33.3	0.2	0	1	0	1	0.0	0.1	0
3:30-3:45	8	1	9	11.1	0.1	0	3	0	3	0.0	0.3	0
3:45-4:00	4	2	6	33.3	0.1	0	1	2	3	66.7	0.3	0
1時間計	22	8	30	26.7	0.5	0	5	3	8	37.5	0.9	0
4:00-4:15	9	1	10	10.0	0.2	0	2	1	3	33.3	0.3	0
4:15-4:30	11	1	12	8.3	0.2	0	0	0	0	0.0	0.0	0
4:30-4:45	10	0	10	0.0	0.2	1	2	0	2	0.0	0.2	0
4:45-5:00	24	6	30	20.0	0.5	0	2	1	3	33.3	0.3	0
1時間計	54	8	62	12.9	1.0	1	6	2	8	25.0	0.9	0
5:00-5:15	19	8	27	29.6	0.4	2	4	3	7	42.9	0.8	1
5:15-5:30	14	3	17	17.6	0.3	2	6	1	7	14.3	0.8	3
5:30-5:45	17	3	20	15.0	0.3	7	5	1	6	16.7	0.7	0
5:45-6:00	16	5	21	23.8	0.3	4	13	1	14	7.1	1.5	0
1時間計	66	19	85	22.4	1.4	15	28	6	34	17.6	3.8	4
6:00-6:15	37	5	42	11.9	0.7	5	18	1	19	5.3	2.1	2
6:15-6:30	41	6	47	12.8	0.8	5	15	1	16	6.3	1.8	0
6:30-6:45	35	3	38	7.9	0.6	3	13	1	14	7.1	1.5	0
6:45-7:00	53	7	60	11.7	1.0	8	15	5	20	25.0	2.2	1
1時間計	166	21	187	11.2	3.1	21	61	8	69	11.6	7.6	3
夜12時間計	1642	130	1772	7.3	29.4	134	269	45	314	14.3	34.7	16
全時間合計	5500	528	6028	8.8	100.0	394	799	106	905	11.7	100.0	29
昼夜率	1.43	1.33	1.42	-	-	1.52	1.51	1.74	1.53	-	-	2.23

方向別自動車交通量調査表

調査地点：地域社会4 瀬谷土橋公園入口

調査年月日：令和2年9月21日(月・祝) 天候：曇りのち晴れ



方向							B 合計 (3+4)					
	種別	小型車 (台)	大型車 (台)	合計 (台)	大型車 混入率 (%)	時間 係数 (%)	二輪車 (台)	小型車 (台)	大型車 (台)	合計 (台)	大型車 混入率 (%)	時間 係数 (%)
7:00-7:15							63	9	72	12.5	1.0	9
7:15-7:30							69	13	82	15.9	1.2	3
7:30-7:45							93	16	109	14.7	1.6	8
7:45-8:00							91	9	100	9.0	1.4	8
1時間計							316	47	363	12.9	5.2	28
8:00-8:15							78	11	89	12.4	1.3	8
8:15-8:30							97	9	106	8.5	1.5	3
8:30-8:45							82	11	93	11.8	1.3	1
8:45-9:00							83	24	107	22.4	1.5	3
1時間計							340	55	395	13.9	5.7	15
9:00-9:15							55	22	77	28.6	1.1	5
9:15-9:30							94	14	108	13.0	1.6	11
9:30-9:45							73	17	90	18.9	1.3	5
9:45-10:00							107	17	124	13.7	1.8	1
1時間計							329	70	399	17.5	5.8	22
10:00-10:15							103	17	120	14.2	1.7	2
10:15-10:30							59	8	67	11.9	1.0	5
10:30-10:45							83	17	100	17.0	1.4	3
10:45-11:00							82	5	87	5.7	1.3	3
1時間計							327	47	374	12.6	5.4	13
11:00-11:15							93	12	105	11.4	1.5	3
11:15-11:30							67	10	77	13.0	1.1	7
11:30-11:45							90	4	94	4.3	1.4	3
11:45-12:00							85	9	94	9.6	1.4	7
1時間計							335	35	370	9.5	5.3	20
12:00-12:15							93	12	105	11.4	1.5	7
12:15-12:30							80	4	84	4.8	1.2	4
12:30-12:45							93	7	100	7.0	1.4	5
12:45-13:00							94	7	101	6.9	1.5	2
1時間計							360	30	390	7.7	5.6	18
13:00-13:15							87	4	91	4.4	1.3	7
13:15-13:30							70	9	79	11.4	1.1	6
13:30-13:45							106	12	118	10.2	1.7	9
13:45-14:00							84	8	92	8.7	1.3	3
1時間計							347	33	380	8.7	5.5	25
14:00-14:15							90	17	107	15.9	1.5	2
14:15-14:30							97	6	103	5.8	1.5	7
14:30-14:45							79	5	84	6.0	1.2	12
14:45-15:00							97	9	106	8.5	1.5	6
1時間計							363	37	400	9.3	5.8	27

方向別自動車交通量調査表

調査地点：地域社会4 瀬谷土橋公園入口

調査年月日：令和2年9月21日(月・祝) 天候：曇りのち晴れ



方向 種別 時間帯							B 合計 (3+4)					
	小型車 (台)	大型車 (台)	合計 (台)	大型車 混入率 (%)	時間 係数 (%)	二輪車 (台)	小型車 (台)	大型車 (台)	合計 (台)	大型車 混入率 (%)	時間 係数 (%)	二輪車 (台)
15:00-15:15							111	11	122	9.0	1.8	5
15:15-15:30							70	5	75	6.7	1.1	4
15:30-15:45							86	7	93	7.5	1.3	4
15:45-16:00							96	10	106	9.4	1.5	8
1時間計							363	33	396	8.3	5.7	21
16:00-16:15							87	4	91	4.4	1.3	4
16:15-16:30							92	4	96	4.2	1.4	5
16:30-16:45							108	9	117	7.7	1.7	5
16:45-17:00							104	5	109	4.6	1.6	7
1時間計							391	22	413	5.3	6.0	21
17:00-17:15							93	6	99	6.1	1.4	17
17:15-17:30							122	5	127	3.9	1.8	8
17:30-17:45							105	11	116	9.5	1.7	8
17:45-18:00							107	8	115	7.0	1.7	6
1時間計							427	30	457	6.6	6.6	39
18:00-18:15							134	4	138	2.9	2.0	10
18:15-18:30							135	4	139	2.9	2.0	1
18:30-18:45							112	3	115	2.6	1.7	7
18:45-19:00							109	9	118	7.6	1.7	6
1時間計							490	20	510	3.9	7.4	24
昼12時間計							4388	459	4847	9.5	69.9	273
19:00-19:15							134	2	136	1.5	2.0	13
19:15-19:30							86	3	89	3.4	1.3	7
19:30-19:45							96	6	102	5.9	1.5	5
19:45-20:00							99	4	103	3.9	1.5	4
1時間計							415	15	430	3.5	6.2	29
20:00-20:15							83	9	92	9.8	1.3	7
20:15-20:30							84	2	86	2.3	1.2	2
20:30-20:45							105	3	108	2.8	1.6	7
20:45-21:00							62	3	65	4.6	0.9	3
1時間計							334	17	351	4.8	5.1	19
21:00-21:15							86	3	89	3.4	1.3	4
21:15-21:30							98	3	101	3.0	1.5	4
21:30-21:45							81	2	83	2.4	1.2	5
21:45-22:00							85	2	87	2.3	1.3	1
1時間計							350	10	360	2.8	5.2	14
22:00-22:15							62	3	65	4.6	0.9	3
22:15-22:30							32	4	36	11.1	0.5	4
22:30-22:45							66	4	70	5.7	1.0	10
22:45-23:00							38	4	42	9.5	0.6	2
1時間計							198	15	213	7.0	3.1	19

方向別自動車交通量調査表

調査地点：地域社会4 瀬谷土橋公園入口

調査年月日：令和2年9月21日(月・祝) 天候：曇りのち晴れ



方向 種別 時間帯							B 合計 (3+4)					
	小型車 (台)	大型車 (台)	合計 (台)	大型車 混入率 (%)	時間 係数 (%)	二輪車 (台)	小型車 (台)	大型車 (台)	合計 (台)	大型車 混入率 (%)	時間 係数 (%)	二輪車 (台)
23:00-23:15							32	5	37	13.5	0.5	1
23:15-23:30							29	5	34	14.7	0.5	3
23:30-23:45							13	2	15	13.3	0.2	0
23:45-24:00							33	2	35	5.7	0.5	1
1時間計							107	14	121	11.6	1.7	5
0:00-0:15							12	2	14	14.3	0.2	2
0:15-0:30							13	2	15	13.3	0.2	0
0:30-0:45							8	4	12	33.3	0.2	3
0:45-1:00							7	2	9	22.2	0.1	0
1時間計							40	10	50	20.0	0.7	5
1:00-1:15							13	2	15	13.3	0.2	3
1:15-1:30							15	1	16	6.3	0.2	2
1:30-1:45							5	1	6	16.7	0.1	2
1:45-2:00							3	2	5	40.0	0.1	1
1時間計							36	6	42	14.3	0.6	8
2:00-2:15							10	1	11	9.1	0.2	1
2:15-2:30							3	3	6	50.0	0.1	2
2:30-2:45							5	3	8	37.5	0.1	4
2:45-3:00							5	6	11	54.5	0.2	0
1時間計							23	13	36	36.1	0.5	7
3:00-3:15							2	2	4	50.0	0.1	0
3:15-3:30							9	4	13	30.8	0.2	0
3:30-3:45							11	1	12	8.3	0.2	0
3:45-4:00							5	4	9	44.4	0.1	0
1時間計							27	11	38	28.9	0.5	0
4:00-4:15							11	2	13	15.4	0.2	0
4:15-4:30							11	1	12	8.3	0.2	0
4:30-4:45							12	0	12	0.0	0.2	1
4:45-5:00							26	7	33	21.2	0.5	0
1時間計							60	10	70	14.3	1.0	1
5:00-5:15							23	11	34	32.4	0.5	3
5:15-5:30							20	4	24	16.7	0.3	5
5:30-5:45							22	4	26	15.4	0.4	7
5:45-6:00							29	6	35	17.1	0.5	4
1時間計							94	25	119	21.0	1.7	19
6:00-6:15							55	6	61	9.8	0.9	7
6:15-6:30							56	7	63	11.1	0.9	5
6:30-6:45							48	4	52	7.7	0.8	3
6:45-7:00							68	12	80	15.0	1.2	9
1時間計							227	29	256	11.3	3.7	24
夜12時間計							1911	175	2086	8.4	30.1	150
全時間合計							6299	634	6933	9.1	100.0	423
昼夜率							1.44	1.38	1.43	-	-	1.55

方向別自動車交通量調査表

調査地点：地域社会4 瀬谷土橋公園入口

調査年月日：令和2年9月21日(月・祝) 天候：曇りのち晴れ



方向 時間帯	5						6					
	種別 小型車 (台)	大型車 (台)	合計 (台)	大型車 混入率 (%)	時間 係数 (%)	二輪車 (台)	小型車 (台)	大型車 (台)	合計 (台)	大型車 混入率 (%)	時間 係数 (%)	二輪車 (台)
7:00-7:15	1	0	1	0.0	0.1	0	34	6	40	15.0	1.3	0
7:15-7:30	3	1	4	25.0	0.6	0	44	6	50	12.0	1.7	0
7:30-7:45	4	1	5	20.0	0.7	1	31	7	38	18.4	1.3	0
7:45-8:00	4	3	7	42.9	1.0	0	17	8	25	32.0	0.8	1
1時間計	12	5	17	29.4	2.4	1	126	27	153	17.6	5.1	1
8:00-8:15	5	1	6	16.7	0.8	0	32	2	34	5.9	1.1	1
8:15-8:30	11	1	12	8.3	1.7	0	30	8	38	21.1	1.3	0
8:30-8:45	21	2	23	8.7	3.2	2	17	8	25	32.0	0.8	0
8:45-9:00	12	2	14	14.3	2.0	3	17	4	21	19.0	0.7	1
1時間計	49	6	55	10.9	7.7	5	96	22	118	18.6	3.9	2
9:00-9:15	15	0	15	0.0	2.1	2	19	2	21	9.5	0.7	1
9:15-9:30	17	1	18	5.6	2.5	2	19	4	23	17.4	0.8	1
9:30-9:45	17	0	17	0.0	2.4	1	26	5	31	16.1	1.0	0
9:45-10:00	6	0	6	0.0	0.8	0	18	1	19	5.3	0.6	1
1時間計	55	1	56	1.8	7.8	5	82	12	94	12.8	3.1	3
10:00-10:15	11	1	12	8.3	1.7	0	19	2	21	9.5	0.7	2
10:15-10:30	14	2	16	12.5	2.2	1	23	2	25	8.0	0.8	0
10:30-10:45	7	2	9	22.2	1.3	0	13	0	13	0.0	0.4	0
10:45-11:00	13	0	13	0.0	1.8	1	20	2	22	9.1	0.7	1
1時間計	45	5	50	10.0	7.0	2	75	6	81	7.4	2.7	3
11:00-11:15	14	1	15	6.7	2.1	0	15	2	17	11.8	0.6	0
11:15-11:30	4	1	5	20.0	0.7	0	12	0	12	0.0	0.4	1
11:30-11:45	5	3	8	37.5	1.1	0	23	1	24	4.2	0.8	1
11:45-12:00	10	2	12	16.7	1.7	0	20	2	22	9.1	0.7	0
1時間計	33	7	40	17.5	5.6	0	70	5	75	6.7	2.5	2
12:00-12:15	13	0	13	0.0	1.8	0	24	0	24	0.0	0.8	0
12:15-12:30	9	0	9	0.0	1.3	0	13	2	15	13.3	0.5	1
12:30-12:45	10	0	10	0.0	1.4	1	28	5	33	15.2	1.1	4
12:45-13:00	9	1	10	10.0	1.4	1	32	5	37	13.5	1.2	1
1時間計	41	1	42	2.4	5.9	2	97	12	109	11.0	3.6	6
13:00-13:15	15	0	15	0.0	2.1	0	20	5	25	20.0	0.8	0
13:15-13:30	12	2	14	14.3	2.0	0	42	7	49	14.3	1.6	1
13:30-13:45	7	1	8	12.5	1.1	0	47	4	51	7.8	1.7	1
13:45-14:00	18	0	18	0.0	2.5	1	49	4	53	7.5	1.8	3
1時間計	52	3	55	5.5	7.7	1	158	20	178	11.2	5.9	5
14:00-14:15	2	2	4	50.0	0.6	0	62	2	64	3.1	2.1	3
14:15-14:30	12	1	13	7.7	1.8	1	70	1	71	1.4	2.4	1
14:30-14:45	14	0	14	0.0	2.0	0	72	7	79	8.9	2.6	1
14:45-15:00	10	1	11	9.1	1.5	0	53	3	56	5.4	1.9	2
1時間計	38	4	42	9.5	5.9	1	257	13	270	4.8	9.0	7

方向別自動車交通量調査表

調査地点：地域社会4 瀬谷土橋公園入口

調査年月日：令和2年9月21日(月・祝) 天候：曇りのち晴れ



方向 種別 時間帯	5						6					
	小型車 (台)	大型車 (台)	合計 (台)	大型車 混入率 (%)	時間 係数 (%)	二輪車 (台)	小型車 (台)	大型車 (台)	合計 (台)	大型車 混入率 (%)	時間 係数 (%)	二輪車 (台)
15:00-15:15	14	0	14	0.0	2.0	2	68	1	69	1.4	2.3	1
15:15-15:30	21	2	23	8.7	3.2	0	70	4	74	5.4	2.5	2
15:30-15:45	13	2	15	13.3	2.1	0	64	4	68	5.9	2.3	5
15:45-16:00	17	3	20	15.0	2.8	1	61	2	63	3.2	2.1	1
1時間計	65	7	72	9.7	10.1	3	263	11	274	4.0	9.1	9
16:00-16:15	27	3	30	10.0	4.2	1	72	2	74	2.7	2.5	1
16:15-16:30	22	2	24	8.3	3.4	1	82	8	90	8.9	3.0	1
16:30-16:45	25	1	26	3.8	3.6	0	92	2	94	2.1	3.1	1
16:45-17:00	5	1	6	16.7	0.8	1	49	3	52	5.8	1.7	1
1時間計	79	7	86	8.1	12.0	3	295	15	310	4.8	10.3	4
17:00-17:15	8	0	8	0.0	1.1	2	51	7	58	12.1	1.9	3
17:15-17:30	11	0	11	0.0	1.5	0	57	5	62	8.1	2.1	14
17:30-17:45	9	2	11	18.2	1.5	2	63	2	65	3.1	2.2	6
17:45-18:00	12	2	14	14.3	2.0	2	68	1	69	1.4	2.3	3
1時間計	40	4	44	9.1	6.2	6	239	15	254	5.9	8.5	26
18:00-18:15	15	2	17	11.8	2.4	0	53	2	55	3.6	1.8	2
18:15-18:30	12	0	12	0.0	1.7	0	56	2	58	3.4	1.9	6
18:30-18:45	6	1	7	14.3	1.0	1	47	2	49	4.1	1.6	1
18:45-19:00	13	1	14	7.1	2.0	1	44	1	45	2.2	1.5	2
1時間計	46	4	50	8.0	7.0	2	200	7	207	3.4	6.9	11
昼12時間計	555	54	609	8.9	85.2	31	1958	165	2123	7.8	70.8	79
19:00-19:15	8	0	8	0.0	1.1	0	72	2	74	2.7	2.5	2
19:15-19:30	6	0	6	0.0	0.8	2	52	2	54	3.7	1.8	2
19:30-19:45	4	0	4	0.0	0.6	1	52	1	53	1.9	1.8	2
19:45-20:00	6	0	6	0.0	0.8	0	36	0	36	0.0	1.2	1
1時間計	24	0	24	0.0	3.4	3	212	5	217	2.3	7.2	7
20:00-20:15	2	0	2	0.0	0.3	3	33	0	33	0.0	1.1	2
20:15-20:30	4	0	4	0.0	0.6	0	37	1	38	2.6	1.3	0
20:30-20:45	5	1	6	16.7	0.8	0	35	2	37	5.4	1.2	1
20:45-21:00	2	0	2	0.0	0.3	1	40	0	40	0.0	1.3	4
1時間計	13	1	14	7.1	2.0	4	145	3	148	2.0	4.9	7
21:00-21:15	2	1	3	33.3	0.4	2	43	2	45	4.4	1.5	3
21:15-21:30	2	0	2	0.0	0.3	1	25	1	26	3.8	0.9	0
21:30-21:45	4	0	4	0.0	0.6	0	33	2	35	5.7	1.2	2
21:45-22:00	3	0	3	0.0	0.4	0	15	4	19	21.1	0.6	0
1時間計	11	1	12	8.3	1.7	3	116	9	125	7.2	4.2	5
22:00-22:15	2	1	3	33.3	0.4	0	25	1	26	3.8	0.9	0
22:15-22:30	0	1	1	100.0	0.1	0	22	2	24	8.3	0.8	1
22:30-22:45	1	0	1	0.0	0.1	0	23	3	26	11.5	0.9	0
22:45-23:00	1	0	1	0.0	0.1	0	10	0	10	0.0	0.3	0
1時間計	4	2	6	33.3	0.8	0	80	6	86	7.0	2.9	1

方向別自動車交通量調査表

調査地点：地域社会4 瀬谷土橋公園入口

調査年月日：令和2年9月21日(月・祝) 天候：曇りのち晴れ



方向	5						6						
	種別	小型車 (台)	大型車 (台)	合計 (台)	大型車 混入率 (%)	時間 係数 (%)	二輪車 (台)	小型車 (台)	大型車 (台)	合計 (台)	大型車 混入率 (%)	時間 係数 (%)	二輪車 (台)
23:00-23:15		2	0	2	0.0	0.3	0	10	0	10	0.0	0.3	1
23:15-23:30		3	0	3	0.0	0.4	0	12	1	13	7.7	0.4	0
23:30-23:45		2	0	2	0.0	0.3	0	9	1	10	10.0	0.3	0
23:45-24:00		0	0	0	0.0	0.0	0	10	2	12	16.7	0.4	0
1時間計		7	0	7	0.0	1.0	0	41	4	45	8.9	1.5	1
0:00-0:15		1	0	1	0.0	0.1	0	10	1	11	9.1	0.4	0
0:15-0:30		0	1	1	100.0	0.1	1	6	1	7	14.3	0.2	0
0:30-0:45		4	0	4	0.0	0.6	0	7	2	9	22.2	0.3	0
0:45-1:00		1	0	1	0.0	0.1	0	2	0	2	0.0	0.1	1
1時間計		6	1	7	14.3	1.0	1	25	4	29	13.8	1.0	1
1:00-1:15		1	0	1	0.0	0.1	0	5	2	7	28.6	0.2	0
1:15-1:30		0	0	0	0.0	0.0	0	4	6	10	60.0	0.3	0
1:30-1:45		1	0	1	0.0	0.1	0	6	0	6	0.0	0.2	0
1:45-2:00		2	0	2	0.0	0.3	0	4	1	5	20.0	0.2	0
1時間計		4	0	4	0.0	0.6	0	19	9	28	32.1	0.9	0
2:00-2:15		0	0	0	0.0	0.0	0	3	3	6	50.0	0.2	0
2:15-2:30		1	0	1	0.0	0.1	0	7	0	7	0.0	0.2	1
2:30-2:45		1	0	1	0.0	0.1	1	4	1	5	20.0	0.2	0
2:45-3:00		0	0	0	0.0	0.0	1	0	0	0	0.0	0.0	0
1時間計		2	0	2	0.0	0.3	2	14	4	18	22.2	0.6	1
3:00-3:15		1	0	1	0.0	0.1	0	3	2	5	40.0	0.2	1
3:15-3:30		1	1	2	50.0	0.3	1	0	1	1	100.0	0.0	0
3:30-3:45		0	0	0	0.0	0.0	0	2	2	4	50.0	0.1	0
3:45-4:00		0	0	0	0.0	0.0	0	2	0	2	0.0	0.1	0
1時間計		2	1	3	33.3	0.4	1	7	5	12	41.7	0.4	1
4:00-4:15		1	0	1	0.0	0.1	0	2	2	4	50.0	0.1	0
4:15-4:30		1	0	1	0.0	0.1	0	1	0	1	0.0	0.0	0
4:30-4:45		0	0	0	0.0	0.0	1	8	0	8	0.0	0.3	0
4:45-5:00		2	0	2	0.0	0.3	0	8	1	9	11.1	0.3	0
1時間計		4	0	4	0.0	0.6	1	19	3	22	13.6	0.7	0
5:00-5:15		4	0	4	0.0	0.6	0	6	1	7	14.3	0.2	0
5:15-5:30		0	0	0	0.0	0.0	0	6	0	6	0.0	0.2	0
5:30-5:45		1	1	2	50.0	0.3	2	7	2	9	22.2	0.3	1
5:45-6:00		4	2	6	33.3	0.8	0	15	1	16	6.3	0.5	0
1時間計		9	3	12	25.0	1.7	2	34	4	38	10.5	1.3	1
6:00-6:15		4	0	4	0.0	0.6	0	16	6	22	27.3	0.7	0
6:15-6:30		2	0	2	0.0	0.3	0	28	7	35	20.0	1.2	1
6:30-6:45		2	0	2	0.0	0.3	0	24	6	30	20.0	1.0	1
6:45-7:00		3	0	3	0.0	0.4	0	19	1	20	5.0	0.7	0
1時間計		11	0	11	0.0	1.5	0	87	20	107	18.7	3.6	2
夜12時間計		97	9	106	8.5	14.8	17	799	76	875	8.7	29.2	27
全時間合計		652	63	715	8.8	100.0	48	2757	241	2998	8.0	100.0	106
昼夜率		1.17	1.17	1.17	-	-	1.55	1.41	1.46	1.41	-	-	1.34

方向別自動車交通量調査表

調査地点：地域社会4 瀬谷土橋公園入口

調査年月日：令和2年9月21日(月・祝) 天候：曇りのち晴れ



方向 種別 時間帯	方向						C 合計 (5+6)					
	小型車 (台)	大型車 (台)	合計 (台)	大型車 混入率 (%)	時間 係数 (%)	二輪車 (台)	小型車 (台)	大型車 (台)	合計 (台)	大型車 混入率 (%)	時間 係数 (%)	二輪車 (台)
7:00-7:15							35	6	41	14.6	1.1	0
7:15-7:30							47	7	54	13.0	1.5	0
7:30-7:45							35	8	43	18.6	1.2	1
7:45-8:00							21	11	32	34.4	0.9	1
1時間計							138	32	170	18.8	4.6	2
8:00-8:15							37	3	40	7.5	1.1	1
8:15-8:30							41	9	50	18.0	1.3	0
8:30-8:45							38	10	48	20.8	1.3	2
8:45-9:00							29	6	35	17.1	0.9	4
1時間計							145	28	173	16.2	4.7	7
9:00-9:15							34	2	36	5.6	1.0	3
9:15-9:30							36	5	41	12.2	1.1	3
9:30-9:45							43	5	48	10.4	1.3	1
9:45-10:00							24	1	25	4.0	0.7	1
1時間計							137	13	150	8.7	4.0	8
10:00-10:15							30	3	33	9.1	0.9	2
10:15-10:30							37	4	41	9.8	1.1	1
10:30-10:45							20	2	22	9.1	0.6	0
10:45-11:00							33	2	35	5.7	0.9	2
1時間計							120	11	131	8.4	3.5	5
11:00-11:15							29	3	32	9.4	0.9	0
11:15-11:30							16	1	17	5.9	0.5	1
11:30-11:45							28	4	32	12.5	0.9	1
11:45-12:00							30	4	34	11.8	0.9	0
1時間計							103	12	115	10.4	3.1	2
12:00-12:15							37	0	37	0.0	1.0	0
12:15-12:30							22	2	24	8.3	0.6	1
12:30-12:45							38	5	43	11.6	1.2	5
12:45-13:00							41	6	47	12.8	1.3	2
1時間計							138	13	151	8.6	4.1	8
13:00-13:15							35	5	40	12.5	1.1	0
13:15-13:30							54	9	63	14.3	1.7	1
13:30-13:45							54	5	59	8.5	1.6	1
13:45-14:00							67	4	71	5.6	1.9	4
1時間計							210	23	233	9.9	6.3	6
14:00-14:15							64	4	68	5.9	1.8	3
14:15-14:30							82	2	84	2.4	2.3	2
14:30-14:45							86	7	93	7.5	2.5	1
14:45-15:00							63	4	67	6.0	1.8	2
1時間計							295	17	312	5.4	8.4	8

方向別自動車交通量調査表

調査地点：地域社会4 瀬谷土橋公園入口

調査年月日：令和2年9月21日(月・祝) 天候：曇りのち晴れ



方向 種別 時間帯							C 合計 (5+6)					
	小型車 (台)	大型車 (台)	合計 (台)	大型車 混入率 (%)	時間 係数 (%)	二輪車 (台)	小型車 (台)	大型車 (台)	合計 (台)	大型車 混入率 (%)	時間 係数 (%)	二輪車 (台)
15:00-15:15							82	1	83	1.2	2.2	3
15:15-15:30							91	6	97	6.2	2.6	2
15:30-15:45							77	6	83	7.2	2.2	5
15:45-16:00							78	5	83	6.0	2.2	2
1時間計							328	18	346	5.2	9.3	12
16:00-16:15							99	5	104	4.8	2.8	2
16:15-16:30							104	10	114	8.8	3.1	2
16:30-16:45							117	3	120	2.5	3.2	1
16:45-17:00							54	4	58	6.9	1.6	2
1時間計							374	22	396	5.6	10.7	7
17:00-17:15							59	7	66	10.6	1.8	5
17:15-17:30							68	5	73	6.8	2.0	14
17:30-17:45							72	4	76	5.3	2.0	8
17:45-18:00							80	3	83	3.6	2.2	5
1時間計							279	19	298	6.4	8.0	32
18:00-18:15							68	4	72	5.6	1.9	2
18:15-18:30							68	2	70	2.9	1.9	6
18:30-18:45							53	3	56	5.4	1.5	2
18:45-19:00							57	2	59	3.4	1.6	3
1時間計							246	11	257	4.3	6.9	13
昼12時間計							2513	219	2732	8.0	73.6	110
19:00-19:15							80	2	82	2.4	2.2	2
19:15-19:30							58	2	60	3.3	1.6	4
19:30-19:45							56	1	57	1.8	1.5	3
19:45-20:00							42	0	42	0.0	1.1	1
1時間計							236	5	241	2.1	6.5	10
20:00-20:15							35	0	35	0.0	0.9	5
20:15-20:30							41	1	42	2.4	1.1	0
20:30-20:45							40	3	43	7.0	1.2	1
20:45-21:00							42	0	42	0.0	1.1	5
1時間計							158	4	162	2.5	4.4	11
21:00-21:15							45	3	48	6.3	1.3	5
21:15-21:30							27	1	28	3.6	0.8	1
21:30-21:45							37	2	39	5.1	1.1	2
21:45-22:00							18	4	22	18.2	0.6	0
1時間計							127	10	137	7.3	3.7	8
22:00-22:15							27	2	29	6.9	0.8	0
22:15-22:30							22	3	25	12.0	0.7	1
22:30-22:45							24	3	27	11.1	0.7	0
22:45-23:00							11	0	11	0.0	0.3	0
1時間計							84	8	92	8.7	2.5	1

方向別自動車交通量調査表

調査地点：地域社会4 瀬谷土橋公園入口

調査年月日：令和2年9月21日(月・祝) 天候：曇りのち晴れ



方向 種別 時間帯							C 合計 (5+6)					
	小型車 (台)	大型車 (台)	合計 (台)	大型車 混入率 (%)	時間 係数 (%)	二輪車 (台)	小型車 (台)	大型車 (台)	合計 (台)	大型車 混入率 (%)	時間 係数 (%)	二輪車 (台)
23:00-23:15							12	0	12	0.0	0.3	1
23:15-23:30							15	1	16	6.3	0.4	0
23:30-23:45							11	1	12	8.3	0.3	0
23:45-24:00							10	2	12	16.7	0.3	0
1時間計							48	4	52	7.7	1.4	1
0:00-0:15							11	1	12	8.3	0.3	0
0:15-0:30							6	2	8	25.0	0.2	1
0:30-0:45							11	2	13	15.4	0.4	0
0:45-1:00							3	0	3	0.0	0.1	1
1時間計							31	5	36	13.9	1.0	2
1:00-1:15							6	2	8	25.0	0.2	0
1:15-1:30							4	6	10	60.0	0.3	0
1:30-1:45							7	0	7	0.0	0.2	0
1:45-2:00							6	1	7	14.3	0.2	0
1時間計							23	9	32	28.1	0.9	0
2:00-2:15							3	3	6	50.0	0.2	0
2:15-2:30							8	0	8	0.0	0.2	1
2:30-2:45							5	1	6	16.7	0.2	1
2:45-3:00							0	0	0	0.0	0.0	1
1時間計							16	4	20	20.0	0.5	3
3:00-3:15							4	2	6	33.3	0.2	1
3:15-3:30							1	2	3	66.7	0.1	1
3:30-3:45							2	2	4	50.0	0.1	0
3:45-4:00							2	0	2	0.0	0.1	0
1時間計							9	6	15	40.0	0.4	2
4:00-4:15							3	2	5	40.0	0.1	0
4:15-4:30							2	0	2	0.0	0.1	0
4:30-4:45							8	0	8	0.0	0.2	1
4:45-5:00							10	1	11	9.1	0.3	0
1時間計							23	3	26	11.5	0.7	1
5:00-5:15							10	1	11	9.1	0.3	0
5:15-5:30							6	0	6	0.0	0.2	0
5:30-5:45							8	3	11	27.3	0.3	3
5:45-6:00							19	3	22	13.6	0.6	0
1時間計							43	7	50	14.0	1.3	3
6:00-6:15							20	6	26	23.1	0.7	0
6:15-6:30							30	7	37	18.9	1.0	1
6:30-6:45							26	6	32	18.8	0.9	1
6:45-7:00							22	1	23	4.3	0.6	0
1時間計							98	20	118	16.9	3.2	2
夜12時間計							896	85	981	8.7	26.4	44
全時間合計							3409	304	3713	8.2	100.0	154
昼夜率							1.36	1.39	1.36	-	-	1.40

方向別自動車交通量調査表

調査地点 : 地域社会 4 瀬谷土橋公園前

調査年月日 : 令和 2年 9月21日(月・祝) 天候:曇りのち晴れ



方向 時間帯	1						2					
	種別 小型車 (台)	大型車 (台)	合計 (台)	大型車 混入率 (%)	時間 係数 (%)	二輪車 (台)	小型車 (台)	大型車 (台)	合計 (台)	大型車 混入率 (%)	時間 係数 (%)	二輪車 (台)
7:00-7:15	4	0	4	0.0	0.5	1	33	5	38	13.2	1.2	0
7:15-7:30	6	2	8	25.0	1.0	3	45	5	50	10.0	1.5	1
7:30-7:45	2	1	3	33.3	0.4	0	31	4	35	11.4	1.1	1
7:45-8:00	8	2	10	20.0	1.3	1	20	6	26	23.1	0.8	1
1時間計	20	5	25	20.0	3.2	5	129	20	149	13.4	4.6	3
8:00-8:15	7	1	8	12.5	1.0	1	36	1	37	2.7	1.1	1
8:15-8:30	12	2	14	14.3	1.8	0	34	3	37	8.1	1.1	0
8:30-8:45	5	3	8	37.5	1.0	1	26	5	31	16.1	1.0	2
8:45-9:00	15	0	15	0.0	1.9	1	24	1	25	4.0	0.8	4
1時間計	39	6	45	13.3	5.7	3	120	10	130	7.7	4.0	7
9:00-9:15	11	1	12	8.3	1.5	2	31	0	31	0.0	1.0	2
9:15-9:30	6	2	8	25.0	1.0	2	22	2	24	8.3	0.7	3
9:30-9:45	8	1	9	11.1	1.1	0	32	3	35	8.6	1.1	0
9:45-10:00	11	0	11	0.0	1.4	1	20	1	21	4.8	0.7	1
1時間計	36	4	40	10.0	5.1	5	105	6	111	5.4	3.4	6
10:00-10:15	13	0	13	0.0	1.6	1	20	1	21	4.8	0.7	1
10:15-10:30	11	0	11	0.0	1.4	1	22	2	24	8.3	0.7	0
10:30-10:45	7	3	10	30.0	1.3	0	14	0	14	0.0	0.4	1
10:45-11:00	10	5	15	33.3	1.9	0	28	2	30	6.7	0.9	3
1時間計	41	8	49	16.3	6.2	2	84	5	89	5.6	2.8	5
11:00-11:15	10	3	13	23.1	1.6	0	21	0	21	0.0	0.7	0
11:15-11:30	8	3	11	27.3	1.4	0	11	2	13	15.4	0.4	0
11:30-11:45	10	2	12	16.7	1.5	1	20	2	22	9.1	0.7	0
11:45-12:00	14	2	16	12.5	2.0	1	27	3	30	10.0	0.9	0
1時間計	42	10	52	19.2	6.6	2	79	7	86	8.1	2.7	0
12:00-12:15	8	3	11	27.3	1.4	3	25	0	25	0.0	0.8	1
12:15-12:30	4	6	10	60.0	1.3	0	19	0	19	0.0	0.6	1
12:30-12:45	11	4	15	26.7	1.9	0	27	2	29	6.9	0.9	2
12:45-13:00	9	8	17	47.1	2.1	0	36	2	38	5.3	1.2	4
1時間計	32	21	53	39.6	6.7	3	107	4	111	3.6	3.4	8
13:00-13:15	6	3	9	33.3	1.1	0	33	2	35	5.7	1.1	1
13:15-13:30	13	3	16	18.8	2.0	0	46	2	48	4.2	1.5	0
13:30-13:45	3	4	7	57.1	0.9	0	46	2	48	4.2	1.5	1
13:45-14:00	9	1	10	10.0	1.3	0	59	3	62	4.8	1.9	4
1時間計	31	11	42	26.2	5.3	0	184	9	193	4.7	6.0	6
14:00-14:15	13	4	17	23.5	2.1	0	71	4	75	5.3	2.3	4
14:15-14:30	9	4	13	30.8	1.6	0	75	3	78	3.8	2.4	2
14:30-14:45	13	4	17	23.5	2.1	1	73	9	82	11.0	2.5	1
14:45-15:00	16	1	17	5.9	2.1	0	65	3	68	4.4	2.1	2
1時間計	51	13	64	20.3	8.1	1	284	19	303	6.3	9.4	9

方向別自動車交通量調査表

調査地点 : 地域社会4 瀬谷土橋公園前

調査年月日 : 令和2年9月21日(月・祝) 天候:曇りのち晴れ



方向 種別 時間帯	1						2					
	小型車 (台)	大型車 (台)	合計 (台)	大型車 混入率 (%)	時間 係数 (%)	二輪車 (台)	小型車 (台)	大型車 (台)	合計 (台)	大型車 混入率 (%)	時間 係数 (%)	二輪車 (台)
15:00-15:15	9	3	12	25.0	1.5	0	69	3	72	4.2	2.2	4
15:15-15:30	3	4	7	57.1	0.9	1	78	6	84	7.1	2.6	2
15:30-15:45	7	4	11	36.4	1.4	2	75	6	81	7.4	2.5	6
15:45-16:00	9	6	15	40.0	1.9	0	81	5	86	5.8	2.7	2
1時間計	28	17	45	37.8	5.7	3	303	20	323	6.2	10.0	14
16:00-16:15	12	1	13	7.7	1.6	2	88	1	89	1.1	2.8	1
16:15-16:30	8	4	12	33.3	1.5	0	91	4	95	4.2	2.9	2
16:30-16:45	9	9	18	50.0	2.3	1	100	2	102	2.0	3.2	0
16:45-17:00	6	5	11	45.5	1.4	1	59	2	61	3.3	1.9	2
1時間計	35	19	54	35.2	6.8	4	338	9	347	2.6	10.8	5
17:00-17:15	10	4	14	28.6	1.8	1	55	6	61	9.8	1.9	3
17:15-17:30	8	3	11	27.3	1.4	1	64	3	67	4.5	2.1	14
17:30-17:45	12	10	22	45.5	2.8	4	67	2	69	2.9	2.1	6
17:45-18:00	7	10	17	58.8	2.1	1	79	5	84	6.0	2.6	5
1時間計	37	27	64	42.2	8.1	7	265	16	281	5.7	8.7	28
18:00-18:15	9	10	19	52.6	2.4	0	59	3	62	4.8	1.9	2
18:15-18:30	14	4	18	22.2	2.3	2	72	4	76	5.3	2.4	4
18:30-18:45	12	3	15	20.0	1.9	1	49	4	53	7.5	1.6	1
18:45-19:00	8	4	12	33.3	1.5	0	72	2	74	2.7	2.3	2
1時間計	43	21	64	32.8	8.1	3	252	13	265	4.9	8.2	9
昼12時間計	435	162	597	27.1	75.5	38	2250	138	2388	5.8	74.0	100
19:00-19:15	6	0	6	0.0	0.8	1	58	1	59	1.7	1.8	3
19:15-19:30	5	0	5	0.0	0.6	2	58	2	60	3.3	1.9	4
19:30-19:45	7	1	8	12.5	1.0	4	50	0	50	0.0	1.5	2
19:45-20:00	3	2	5	40.0	0.6	0	39	0	39	0.0	1.2	1
1時間計	21	3	24	12.5	3.0	7	205	3	208	1.4	6.4	10
20:00-20:15	1	1	2	50.0	0.3	1	31	0	31	0.0	1.0	4
20:15-20:30	4	3	7	42.9	0.9	0	38	0	38	0.0	1.2	0
20:30-20:45	1	3	4	75.0	0.5	0	38	3	41	7.3	1.3	2
20:45-21:00	1	3	4	75.0	0.5	0	37	0	37	0.0	1.1	4
1時間計	7	10	17	58.8	2.1	1	144	3	147	2.0	4.6	10
21:00-21:15	1	2	3	66.7	0.4	0	28	1	29	3.4	0.9	2
21:15-21:30	1	2	3	66.7	0.4	0	35	0	35	0.0	1.1	2
21:30-21:45	2	0	2	0.0	0.3	0	31	1	32	3.1	1.0	1
21:45-22:00	2	2	4	50.0	0.5	0	16	2	18	11.1	0.6	0
1時間計	6	6	12	50.0	1.5	0	110	4	114	3.5	3.5	5
22:00-22:15	2	0	2	0.0	0.3	0	22	1	23	4.3	0.7	0
22:15-22:30	2	1	3	33.3	0.4	0	17	2	19	10.5	0.6	0
22:30-22:45	1	0	1	0.0	0.1	0	11	0	11	0.0	0.3	0
22:45-23:00	4	1	5	20.0	0.6	0	13	1	14	7.1	0.4	0
1時間計	9	2	11	18.2	1.4	0	63	4	67	6.0	2.1	0

方向別自動車交通量調査表

調査地点 : 地域社会 4 瀬谷土橋公園前

調査年月日 : 令和 2年 9月21日(月・祝) 天候:曇りのち晴れ



方向 種別 時間帯	1						2					
	小型車 (台)	大型車 (台)	合計 (台)	大型車 混入率 (%)	時 間 係 数 (%)	二輪車 (台)	小型車 (台)	大型車 (台)	合計 (台)	大型車 混入率 (%)	時 間 係 数 (%)	二輪車 (台)
23:00-23:15	2	1	3	33.3	0.4	0	13	0	13	0.0	0.4	1
23:15-23:30	3	0	3	0.0	0.4	0	12	0	12	0.0	0.4	0
23:30-23:45	1	0	1	0.0	0.1	0	14	2	16	12.5	0.5	0
23:45-24:00	2	0	2	0.0	0.3	0	6	2	8	25.0	0.2	0
1時間計	8	1	9	11.1	1.1	0	45	4	49	8.2	1.5	1
0:00-0:15	1	1	2	50.0	0.3	0	9	0	9	0.0	0.3	0
0:15-0:30	2	0	2	0.0	0.3	0	4	1	5	20.0	0.2	1
0:30-0:45	1	0	1	0.0	0.1	0	7	1	8	12.5	0.2	0
0:45-1:00	0	2	2	100.0	0.3	0	1	1	2	50.0	0.1	1
1時間計	4	3	7	42.9	0.9	0	21	3	24	12.5	0.7	2
1:00-1:15	1	2	3	66.7	0.4	1	6	1	7	14.3	0.2	0
1:15-1:30	3	2	5	40.0	0.6	1	2	3	5	60.0	0.2	0
1:30-1:45	1	7	8	87.5	1.0	0	5	0	5	0.0	0.2	0
1:45-2:00	2	3	5	60.0	0.6	0	5	1	6	16.7	0.2	0
1時間計	7	14	21	66.7	2.7	2	18	5	23	21.7	0.7	0
2:00-2:15	0	3	3	100.0	0.4	0	3	3	6	50.0	0.2	0
2:15-2:30	2	5	7	71.4	0.9	1	6	0	6	0.0	0.2	0
2:30-2:45	1	6	7	85.7	0.9	0	4	1	5	20.0	0.2	1
2:45-3:00	1	4	5	80.0	0.6	0	0	0	0	0.0	0.0	0
1時間計	4	18	22	81.8	2.8	1	13	4	17	23.5	0.5	1
3:00-3:15	1	0	1	0.0	0.1	0	2	2	4	50.0	0.1	1
3:15-3:30	5	0	5	0.0	0.6	0	5	1	6	16.7	0.2	1
3:30-3:45	1	0	1	0.0	0.1	0	1	2	3	66.7	0.1	0
3:45-4:00	4	1	5	20.0	0.6	0	2	0	2	0.0	0.1	0
1時間計	11	1	12	8.3	1.5	0	10	5	15	33.3	0.5	2
4:00-4:15	0	1	1	100.0	0.1	0	2	0	2	0.0	0.1	0
4:15-4:30	3	1	4	25.0	0.5	0	1	3	4	75.0	0.1	0
4:30-4:45	1	1	2	50.0	0.3	0	5	0	5	0.0	0.2	1
4:45-5:00	5	0	5	0.0	0.6	1	2	0	2	0.0	0.1	0
1時間計	9	3	12	25.0	1.5	1	10	3	13	23.1	0.4	1
5:00-5:15	1	0	1	0.0	0.1	0	6	0	6	0.0	0.2	0
5:15-5:30	1	3	4	75.0	0.5	0	6	0	6	0.0	0.2	0
5:30-5:45	0	3	3	100.0	0.4	2	5	2	7	28.6	0.2	1
5:45-6:00	1	4	5	80.0	0.6	0	18	2	20	10.0	0.6	0
1時間計	3	10	13	76.9	1.6	2	35	4	39	10.3	1.2	1
6:00-6:15	3	7	10	70.0	1.3	1	18	6	24	25.0	0.7	0
6:15-6:30	6	2	8	25.0	1.0	3	30	7	37	18.9	1.1	1
6:30-6:45	3	7	10	70.0	1.3	1	25	5	30	16.7	0.9	2
6:45-7:00	3	3	6	50.0	0.8	1	29	3	32	9.4	1.0	1
1時間計	15	19	34	55.9	4.3	6	102	21	123	17.1	3.8	4
夜12時間計	104	90	194	46.4	24.5	20	776	63	839	7.5	26.0	37
全時間合計	539	252	791	31.9	100.0	58	3026	201	3227	6.2	100.0	137
昼 夜 率	1.24	1.56	1.32	-	-	1.53	1.34	1.46	1.35	-	-	1.37

方向別自動車交通量調査表

調査地点 : 地域社会4 瀬谷土橋公園前

調査年月日 : 令和2年9月21日(月・祝) 天候:曇りのち晴れ



方向 種別 時間帯							A 合計 (1+2)					
	小型車 (台)	大型車 (台)	合計 (台)	大型車 混入率 (%)	時間 係数 (%)	二輪車 (台)	小型車 (台)	大型車 (台)	合計 (台)	大型車 混入率 (%)	時間 係数 (%)	二輪車 (台)
7:00-7:15							37	5	42	11.9	1.0	1
7:15-7:30							51	7	58	12.1	1.4	4
7:30-7:45							33	5	38	13.2	0.9	1
7:45-8:00							28	8	36	22.2	0.9	2
1時間計							149	25	174	14.4	4.3	8
8:00-8:15							43	2	45	4.4	1.1	2
8:15-8:30							46	5	51	9.8	1.3	0
8:30-8:45							31	8	39	20.5	1.0	3
8:45-9:00							39	1	40	2.5	1.0	5
1時間計							159	16	175	9.1	4.4	10
9:00-9:15							42	1	43	2.3	1.1	4
9:15-9:30							28	4	32	12.5	0.8	5
9:30-9:45							40	4	44	9.1	1.1	0
9:45-10:00							31	1	32	3.1	0.8	2
1時間計							141	10	151	6.6	3.8	11
10:00-10:15							33	1	34	2.9	0.8	2
10:15-10:30							33	2	35	5.7	0.9	1
10:30-10:45							21	3	24	12.5	0.6	1
10:45-11:00							38	7	45	15.6	1.1	3
1時間計							125	13	138	9.4	3.4	7
11:00-11:15							31	3	34	8.8	0.8	0
11:15-11:30							19	5	24	20.8	0.6	0
11:30-11:45							30	4	34	11.8	0.8	1
11:45-12:00							41	5	46	10.9	1.1	1
1時間計							121	17	138	12.3	3.4	2
12:00-12:15							33	3	36	8.3	0.9	4
12:15-12:30							23	6	29	20.7	0.7	1
12:30-12:45							38	6	44	13.6	1.1	2
12:45-13:00							45	10	55	18.2	1.4	4
1時間計							139	25	164	15.2	4.1	11
13:00-13:15							39	5	44	11.4	1.1	1
13:15-13:30							59	5	64	7.8	1.6	0
13:30-13:45							49	6	55	10.9	1.4	1
13:45-14:00							68	4	72	5.6	1.8	4
1時間計							215	20	235	8.5	5.8	6
14:00-14:15							84	8	92	8.7	2.3	4
14:15-14:30							84	7	91	7.7	2.3	2
14:30-14:45							86	13	99	13.1	2.5	2
14:45-15:00							81	4	85	4.7	2.1	2
1時間計							335	32	367	8.7	9.1	10

方向別自動車交通量調査表

調査地点：地域社会4 瀬谷土橋公園前

調査年月日：令和2年9月21日(月・祝) 天候：曇りのち晴れ



方向 種別 時間帯							A 合計 (1+2)					
	小型車 (台)	大型車 (台)	合計 (台)	大型車 混入率 (%)	時間 係数 (%)	二輪車 (台)	小型車 (台)	大型車 (台)	合計 (台)	大型車 混入率 (%)	時間 係数 (%)	二輪車 (台)
15:00-15:15							78	6	84	7.1	2.1	4
15:15-15:30							81	10	91	11.0	2.3	3
15:30-15:45							82	10	92	10.9	2.3	8
15:45-16:00							90	11	101	10.9	2.5	2
1時間計							331	37	368	10.1	9.2	17
16:00-16:15							100	2	102	2.0	2.5	3
16:15-16:30							99	8	107	7.5	2.7	2
16:30-16:45							109	11	120	9.2	3.0	1
16:45-17:00							65	7	72	9.7	1.8	3
1時間計							373	28	401	7.0	10.0	9
17:00-17:15							65	10	75	13.3	1.9	4
17:15-17:30							72	6	78	7.7	1.9	15
17:30-17:45							79	12	91	13.2	2.3	10
17:45-18:00							86	15	101	14.9	2.5	6
1時間計							302	43	345	12.5	8.6	35
18:00-18:15							68	13	81	16.0	2.0	2
18:15-18:30							86	8	94	8.5	2.3	6
18:30-18:45							61	7	68	10.3	1.7	2
18:45-19:00							80	6	86	7.0	2.1	2
1時間計							295	34	329	10.3	8.2	12
昼12時間計							2685	300	2985	10.1	74.3	138
19:00-19:15							64	1	65	1.5	1.6	4
19:15-19:30							63	2	65	3.1	1.6	6
19:30-19:45							57	1	58	1.7	1.4	6
19:45-20:00							42	2	44	4.5	1.1	1
1時間計							226	6	232	2.6	5.8	17
20:00-20:15							32	1	33	3.0	0.8	5
20:15-20:30							42	3	45	6.7	1.1	0
20:30-20:45							39	6	45	13.3	1.1	2
20:45-21:00							38	3	41	7.3	1.0	4
1時間計							151	13	164	7.9	4.1	11
21:00-21:15							29	3	32	9.4	0.8	2
21:15-21:30							36	2	38	5.3	0.9	2
21:30-21:45							33	1	34	2.9	0.8	1
21:45-22:00							18	4	22	18.2	0.5	0
1時間計							116	10	126	7.9	3.1	5
22:00-22:15							24	1	25	4.0	0.6	0
22:15-22:30							19	3	22	13.6	0.5	0
22:30-22:45							12	0	12	0.0	0.3	0
22:45-23:00							17	2	19	10.5	0.5	0
1時間計							72	6	78	7.7	1.9	0

方向別自動車交通量調査表

調査地点：地域社会4 瀬谷土橋公園前

調査年月日：令和2年9月21日(月・祝) 天候：曇りのち晴れ



時間帯	方向 種別						A 合計 (1+2)					
		小型車 (台)	大型車 (台)	合計 (台)	大型車 混入率 (%)	時係 数 (%)	二輪車 (台)	小型車 (台)	大型車 (台)	合計 (台)	大型車 混入率 (%)	時係 数 (%)
23:00-23:15							15	1	16	6.3	0.4	1
23:15-23:30							15	0	15	0.0	0.4	0
23:30-23:45							15	2	17	11.8	0.4	0
23:45-24:00							8	2	10	20.0	0.2	0
1時間計							53	5	58	8.6	1.4	1
0:00-0:15							10	1	11	9.1	0.3	0
0:15-0:30							6	1	7	14.3	0.2	1
0:30-0:45							8	1	9	11.1	0.2	0
0:45-1:00							1	3	4	75.0	0.1	1
1時間計							25	6	31	19.4	0.8	2
1:00-1:15							7	3	10	30.0	0.2	1
1:15-1:30							5	5	10	50.0	0.2	1
1:30-1:45							6	7	13	53.8	0.3	0
1:45-2:00							7	4	11	36.4	0.3	0
1時間計							25	19	44	43.2	1.1	2
2:00-2:15							3	6	9	66.7	0.2	0
2:15-2:30							8	5	13	38.5	0.3	1
2:30-2:45							5	7	12	58.3	0.3	1
2:45-3:00							1	4	5	80.0	0.1	0
1時間計							17	22	39	56.4	1.0	2
3:00-3:15							3	2	5	40.0	0.1	1
3:15-3:30							10	1	11	9.1	0.3	1
3:30-3:45							2	2	4	50.0	0.1	0
3:45-4:00							6	1	7	14.3	0.2	0
1時間計							21	6	27	22.2	0.7	2
4:00-4:15							2	1	3	33.3	0.1	0
4:15-4:30							4	4	8	50.0	0.2	0
4:30-4:45							6	1	7	14.3	0.2	1
4:45-5:00							7	0	7	0.0	0.2	1
1時間計							19	6	25	24.0	0.6	2
5:00-5:15							7	0	7	0.0	0.2	0
5:15-5:30							7	3	10	30.0	0.2	0
5:30-5:45							5	5	10	50.0	0.2	3
5:45-6:00							19	6	25	24.0	0.6	0
1時間計							38	14	52	26.9	1.3	3
6:00-6:15							21	13	34	38.2	0.8	1
6:15-6:30							36	9	45	20.0	1.1	4
6:30-6:45							28	12	40	30.0	1.0	3
6:45-7:00							32	6	38	15.8	0.9	2
1時間計							117	40	157	25.5	3.9	10
夜12時間計							880	153	1033	14.8	25.7	57
全時間合計							3565	453	4018	11.3	100.0	195
昼夜率							1.33	1.51	1.35	-	-	1.41

方向別自動車交通量調査表

調査地点 : 地域社会 4 瀬谷土橋公園前

調査年月日 : 令和 2年 9月21日(月・祝) 天候:曇りのち晴れ



方向 時間帯	3						4					
	種別 小型車 (台)	大型車 (台)	合計 (台)	大型車 混入率 (%)	時間 係数 (%)	二輪車 (台)	小型車 (台)	大型車 (台)	合計 (台)	大型車 混入率 (%)	時間 係数 (%)	二輪車 (台)
7:00-7:15	21	5	26	19.2	1.1	0	2	3	5	60.0	1.1	0
7:15-7:30	26	3	29	10.3	1.2	1	10	3	13	23.1	2.8	0
7:30-7:45	36	6	42	14.3	1.8	0	1	0	1	0.0	0.2	0
7:45-8:00	53	3	56	5.4	2.4	1	3	1	4	25.0	0.9	0
1時間計	136	17	153	11.1	6.4	2	16	7	23	30.4	5.0	0
8:00-8:15	49	5	54	9.3	2.3	1	4	1	5	20.0	1.1	0
8:15-8:30	48	3	51	5.9	2.1	0	4	0	4	0.0	0.9	0
8:30-8:45	42	3	45	6.7	1.9	1	9	2	11	18.2	2.4	1
8:45-9:00	36	1	37	2.7	1.6	0	7	3	10	30.0	2.2	1
1時間計	175	12	187	6.4	7.9	2	24	6	30	20.0	6.5	2
9:00-9:15	37	5	42	11.9	1.8	0	8	3	11	27.3	2.4	0
9:15-9:30	41	2	43	4.7	1.8	1	7	1	8	12.5	1.7	0
9:30-9:45	26	2	28	7.1	1.2	2	1	2	3	66.7	0.7	0
9:45-10:00	29	0	29	0.0	1.2	2	2	1	3	33.3	0.7	0
1時間計	133	9	142	6.3	6.0	5	18	7	25	28.0	5.4	0
10:00-10:15	20	2	22	9.1	0.9	1	1	0	1	0.0	0.2	0
10:15-10:30	34	1	35	2.9	1.5	1	1	0	1	0.0	0.2	0
10:30-10:45	40	4	44	9.1	1.9	2	4	0	4	0.0	0.9	0
10:45-11:00	32	2	34	5.9	1.4	6	3	1	4	25.0	0.9	0
1時間計	126	9	135	6.7	5.7	10	9	1	10	10.0	2.2	0
11:00-11:15	39	3	42	7.1	1.8	3	2	0	2	0.0	0.4	0
11:15-11:30	32	2	34	5.9	1.4	3	0	0	0	0.0	0.0	0
11:30-11:45	35	7	42	16.7	1.8	1	2	0	2	0.0	0.4	0
11:45-12:00	50	6	56	10.7	2.4	4	8	2	10	20.0	2.2	0
1時間計	156	18	174	10.3	7.3	11	12	2	14	14.3	3.1	0
12:00-12:15	51	8	59	13.6	2.5	0	7	4	11	36.4	2.4	0
12:15-12:30	51	2	53	3.8	2.2	0	0	3	3	100.0	0.7	0
12:30-12:45	46	3	49	6.1	2.1	1	7	4	11	36.4	2.4	0
12:45-13:00	49	4	53	7.5	2.2	0	5	1	6	16.7	1.3	0
1時間計	197	17	214	7.9	9.0	1	19	12	31	38.7	6.8	0
13:00-13:15	55	6	61	9.8	2.6	2	3	1	4	25.0	0.9	0
13:15-13:30	45	4	49	8.2	2.1	2	5	5	10	50.0	2.2	0
13:30-13:45	48	6	54	11.1	2.3	1	7	1	8	12.5	1.7	1
13:45-14:00	41	8	49	16.3	2.1	1	5	2	7	28.6	1.5	1
1時間計	189	24	213	11.3	9.0	6	20	9	29	31.0	6.3	2
14:00-14:15	38	8	46	17.4	1.9	0	4	7	11	63.6	2.4	0
14:15-14:30	42	2	44	4.5	1.9	1	3	1	4	25.0	0.9	0
14:30-14:45	26	6	32	18.8	1.3	2	6	4	10	40.0	2.2	0
14:45-15:00	33	2	35	5.7	1.5	1	8	1	9	11.1	2.0	0
1時間計	139	18	157	11.5	6.6	4	21	13	34	38.2	7.4	0

方向別自動車交通量調査表

調査地点 : 地域社会 4 瀬谷土橋公園前

調査年月日 : 令和 2年 9月21日(月・祝) 天候:曇りのち晴れ



方向	3						4						
	種別	小型車 (台)	大型車 (台)	合計 (台)	大型車 混入率 (%)	時間 係数 (%)	二輪車 (台)	小型車 (台)	大型車 (台)	合計 (台)	大型車 混入率 (%)	時間 係数 (%)	二輪車 (台)
15:00-15:15		32	2	34	5.9	1.4	2	6	2	8	25.0	1.7	0
15:15-15:30		23	3	26	11.5	1.1	2	6	2	8	25.0	1.7	0
15:30-15:45		32	8	40	20.0	1.7	3	4	1	5	20.0	1.1	0
15:45-16:00		19	4	23	17.4	1.0	2	8	2	10	20.0	2.2	0
1時間計		106	17	123	13.8	5.2	9	24	7	31	22.6	6.8	0
16:00-16:15		29	5	34	14.7	1.4	0	7	2	9	22.2	2.0	0
16:15-16:30		19	2	21	9.5	0.9	0	7	1	8	12.5	1.7	0
16:30-16:45		26	5	31	16.1	1.3	1	4	4	8	50.0	1.7	0
16:45-17:00		24	1	25	4.0	1.1	1	6	2	8	25.0	1.7	0
1時間計		98	13	111	11.7	4.7	2	24	9	33	27.3	7.2	0
17:00-17:15		26	9	35	25.7	1.5	1	9	3	12	25.0	2.6	1
17:15-17:30		27	3	30	10.0	1.3	0	6	0	6	0.0	1.3	1
17:30-17:45		25	5	30	16.7	1.3	2	8	6	14	42.9	3.1	0
17:45-18:00		32	3	35	8.6	1.5	0	4	2	6	33.3	1.3	0
1時間計		110	20	130	15.4	5.5	3	27	11	38	28.9	8.3	2
18:00-18:15		19	1	20	5.0	0.8	1	4	1	5	20.0	1.1	0
18:15-18:30		13	1	14	7.1	0.6	0	4	4	8	50.0	1.7	0
18:30-18:45		17	5	22	22.7	0.9	0	3	2	5	40.0	1.1	0
18:45-19:00		22	3	25	12.0	1.1	0	7	0	7	0.0	1.5	0
1時間計		71	10	81	12.3	3.4	1	18	7	25	28.0	5.4	0
昼12時間計		1636	184	1820	10.1	76.6	56	232	91	323	28.2	70.4	6
19:00-19:15		31	3	34	8.8	1.4	0	6	1	7	14.3	1.5	0
19:15-19:30		19	0	19	0.0	0.8	0	2	1	3	33.3	0.7	0
19:30-19:45		27	0	27	0.0	1.1	0	3	2	5	40.0	1.1	0
19:45-20:00		7	1	8	12.5	0.3	0	3	2	5	40.0	1.1	0
1時間計		84	4	88	4.5	3.7	0	14	6	20	30.0	4.4	0
20:00-20:15		20	8	28	28.6	1.2	0	4	0	4	0.0	0.9	0
20:15-20:30		13	4	17	23.5	0.7	0	0	1	1	100.0	0.2	0
20:30-20:45		15	1	16	6.3	0.7	0	1	0	1	0.0	0.2	0
20:45-21:00		19	3	22	13.6	0.9	1	2	0	2	0.0	0.4	0
1時間計		67	16	83	19.3	3.5	1	7	1	8	12.5	1.7	0
21:00-21:15		13	0	13	0.0	0.5	0	0	1	1	100.0	0.2	0
21:15-21:30		9	1	10	10.0	0.4	0	3	1	4	25.0	0.9	0
21:30-21:45		12	0	12	0.0	0.5	0	2	1	3	33.3	0.7	0
21:45-22:00		13	4	17	23.5	0.7	0	3	0	3	0.0	0.7	0
1時間計		47	5	52	9.6	2.2	0	8	3	11	27.3	2.4	0
22:00-22:15		13	2	15	13.3	0.6	0	2	2	4	50.0	0.9	0
22:15-22:30		13	4	17	23.5	0.7	0	1	0	1	0.0	0.2	0
22:30-22:45		13	4	17	23.5	0.7	1	2	0	2	0.0	0.4	0
22:45-23:00		6	0	6	0.0	0.3	0	4	0	4	0.0	0.9	0
1時間計		45	10	55	18.2	2.3	1	9	2	11	18.2	2.4	0

方向別自動車交通量調査表

調査地点 : 地域社会 4 瀬谷土橋公園前

調査年月日 : 令和 2年 9月21日(月・祝) 天候:曇りのち晴れ



方向 種別 時間帯	3						4					
	小型車 (台)	大型車 (台)	合計 (台)	大型車 混入率 (%)	時間 係数 (%)	二輪車 (台)	小型車 (台)	大型車 (台)	合計 (台)	大型車 混入率 (%)	時間 係数 (%)	二輪車 (台)
23:00-23:15	9	1	10	10.0	0.4	0	0	0	0	0.0	0.0	0
23:15-23:30	4	2	6	33.3	0.3	2	0	1	1	100.0	0.2	0
23:30-23:45	8	3	11	27.3	0.5	0	0	0	0	0.0	0.0	1
23:45-24:00	8	1	9	11.1	0.4	0	1	1	2	50.0	0.4	0
1時間計	29	7	36	19.4	1.5	2	1	2	3	66.7	0.7	1
0:00-0:15	4	1	5	20.0	0.2	0	1	1	2	50.0	0.4	0
0:15-0:30	3	1	4	25.0	0.2	0	1	1	2	50.0	0.4	0
0:30-0:45	10	3	13	23.1	0.5	0	0	5	5	100.0	1.1	0
0:45-1:00	3	2	5	40.0	0.2	0	0	2	2	100.0	0.4	0
1時間計	20	7	27	25.9	1.1	0	2	9	11	81.8	2.4	0
1:00-1:15	1	5	6	83.3	0.3	4	0	0	0	0.0	0.0	0
1:15-1:30	1	1	2	50.0	0.1	1	0	6	6	100.0	1.3	0
1:30-1:45	4	1	5	20.0	0.2	1	0	3	3	100.0	0.7	0
1:45-2:00	1	4	5	80.0	0.2	0	0	3	3	100.0	0.7	0
1時間計	7	11	18	61.1	0.8	6	0	12	12	100.0	2.6	0
2:00-2:15	2	0	2	0.0	0.1	1	0	4	4	100.0	0.9	0
2:15-2:30	1	1	2	50.0	0.1	1	0	1	1	100.0	0.2	0
2:30-2:45	3	3	6	50.0	0.3	4	1	4	5	80.0	1.1	0
2:45-3:00	4	1	5	20.0	0.2	0	0	2	2	100.0	0.4	0
1時間計	10	5	15	33.3	0.6	6	1	11	12	91.7	2.6	0
3:00-3:15	0	2	2	100.0	0.1	0	1	1	2	50.0	0.4	0
3:15-3:30	1	1	2	50.0	0.1	0	0	0	0	0.0	0.0	0
3:30-3:45	4	1	5	20.0	0.2	0	0	0	0	0.0	0.0	0
3:45-4:00	2	1	3	33.3	0.1	0	2	0	2	0.0	0.4	0
1時間計	7	5	12	41.7	0.5	0	3	1	4	25.0	0.9	0
4:00-4:15	4	0	4	0.0	0.2	0	0	0	0	0.0	0.0	0
4:15-4:30	3	1	4	25.0	0.2	0	1	1	2	50.0	0.4	0
4:30-4:45	1	1	2	50.0	0.1	0	1	0	1	0.0	0.2	0
4:45-5:00	2	4	6	66.7	0.3	0	1	2	3	66.7	0.7	0
1時間計	10	6	16	37.5	0.7	0	3	3	6	50.0	1.3	0
5:00-5:15	10	3	13	23.1	0.5	1	0	0	0	0.0	0.0	0
5:15-5:30	7	2	9	22.2	0.4	2	3	2	5	40.0	1.1	1
5:30-5:45	9	3	12	25.0	0.5	0	2	4	6	66.7	1.3	0
5:45-6:00	19	1	20	5.0	0.8	0	2	1	3	33.3	0.7	0
1時間計	45	9	54	16.7	2.3	3	7	7	14	50.0	3.1	1
6:00-6:15	23	1	24	4.2	1.0	5	3	2	5	40.0	1.1	0
6:15-6:30	19	1	20	5.0	0.8	0	2	1	3	33.3	0.7	0
6:30-6:45	20	7	27	25.9	1.1	0	3	1	4	25.0	0.9	0
6:45-7:00	23	7	30	23.3	1.3	2	9	3	12	25.0	2.6	0
1時間計	85	16	101	15.8	4.2	7	17	7	24	29.2	5.2	0
夜12時間計	456	101	557	18.1	23.4	26	72	64	136	47.1	29.6	2
全時間合計	2092	285	2377	12.0	100.0	82	304	155	459	33.8	100.0	8
昼夜率	1.28	1.55	1.31	-	-	1.46	1.31	1.70	1.42	-	-	1.33

方向別自動車交通量調査表

調査地点：地域社会4 瀬谷土橋公園前

調査年月日：令和2年9月21日(月・祝) 天候：曇りのち晴れ



方向 種別 時間帯							B 合計 (3+4)					
	小型車 (台)	大型車 (台)	合計 (台)	大型車 混入率 (%)	時間 係数 (%)	二輪車 (台)	小型車 (台)	大型車 (台)	合計 (台)	大型車 混入率 (%)	時間 係数 (%)	二輪車 (台)
7:00-7:15							23	8	31	25.8	1.1	0
7:15-7:30							36	6	42	14.3	1.5	1
7:30-7:45							37	6	43	14.0	1.5	0
7:45-8:00							56	4	60	6.7	2.1	1
1時間計							152	24	176	13.6	6.2	2
8:00-8:15							53	6	59	10.2	2.1	1
8:15-8:30							52	3	55	5.5	1.9	0
8:30-8:45							51	5	56	8.9	2.0	2
8:45-9:00							43	4	47	8.5	1.7	1
1時間計							199	18	217	8.3	7.7	4
9:00-9:15							45	8	53	15.1	1.9	0
9:15-9:30							48	3	51	5.9	1.8	1
9:30-9:45							27	4	31	12.9	1.1	2
9:45-10:00							31	1	32	3.1	1.1	2
1時間計							151	16	167	9.6	5.9	5
10:00-10:15							21	2	23	8.7	0.8	1
10:15-10:30							35	1	36	2.8	1.3	1
10:30-10:45							44	4	48	8.3	1.7	2
10:45-11:00							35	3	38	7.9	1.3	6
1時間計							135	10	145	6.9	5.1	10
11:00-11:15							41	3	44	6.8	1.6	3
11:15-11:30							32	2	34	5.9	1.2	3
11:30-11:45							37	7	44	15.9	1.6	1
11:45-12:00							58	8	66	12.1	2.3	4
1時間計							168	20	188	10.6	6.6	11
12:00-12:15							58	12	70	17.1	2.5	0
12:15-12:30							51	5	56	8.9	2.0	0
12:30-12:45							53	7	60	11.7	2.1	1
12:45-13:00							54	5	59	8.5	2.1	0
1時間計							216	29	245	11.8	8.6	1
13:00-13:15							58	7	65	10.8	2.3	2
13:15-13:30							50	9	59	15.3	2.1	2
13:30-13:45							55	7	62	11.3	2.2	2
13:45-14:00							46	10	56	17.9	2.0	2
1時間計							209	33	242	13.6	8.5	8
14:00-14:15							42	15	57	26.3	2.0	0
14:15-14:30							45	3	48	6.3	1.7	1
14:30-14:45							32	10	42	23.8	1.5	2
14:45-15:00							41	3	44	6.8	1.6	1
1時間計							160	31	191	16.2	6.7	4

方向別自動車交通量調査表

調査地点：地域社会4 瀬谷土橋公園前

調査年月日：令和2年9月21日(月・祝) 天候：曇りのち晴れ



方向 種別 時間帯							B 合計 (3+4)					
	小型車 (台)	大型車 (台)	合計 (台)	大型車 混入率 (%)	時間 係数 (%)	二輪車 (台)	小型車 (台)	大型車 (台)	合計 (台)	大型車 混入率 (%)	時間 係数 (%)	二輪車 (台)
15:00-15:15							38	4	42	9.5	1.5	2
15:15-15:30							29	5	34	14.7	1.2	2
15:30-15:45							36	9	45	20.0	1.6	3
15:45-16:00							27	6	33	18.2	1.2	2
1時間計							130	24	154	15.6	5.4	9
16:00-16:15							36	7	43	16.3	1.5	0
16:15-16:30							26	3	29	10.3	1.0	0
16:30-16:45							30	9	39	23.1	1.4	1
16:45-17:00							30	3	33	9.1	1.2	1
1時間計							122	22	144	15.3	5.1	2
17:00-17:15							35	12	47	25.5	1.7	2
17:15-17:30							33	3	36	8.3	1.3	1
17:30-17:45							33	11	44	25.0	1.6	2
17:45-18:00							36	5	41	12.2	1.4	0
1時間計							137	31	168	18.5	5.9	5
18:00-18:15							23	2	25	8.0	0.9	1
18:15-18:30							17	5	22	22.7	0.8	0
18:30-18:45							20	7	27	25.9	1.0	0
18:45-19:00							29	3	32	9.4	1.1	0
1時間計							89	17	106	16.0	3.7	1
昼12時間計							1868	275	2143	12.8	75.6	62
19:00-19:15							37	4	41	9.8	1.4	0
19:15-19:30							21	1	22	4.5	0.8	0
19:30-19:45							30	2	32	6.3	1.1	0
19:45-20:00							10	3	13	23.1	0.5	0
1時間計							98	10	108	9.3	3.8	0
20:00-20:15							24	8	32	25.0	1.1	0
20:15-20:30							13	5	18	27.8	0.6	0
20:30-20:45							16	1	17	5.9	0.6	0
20:45-21:00							21	3	24	12.5	0.8	1
1時間計							74	17	91	18.7	3.2	1
21:00-21:15							13	1	14	7.1	0.5	0
21:15-21:30							12	2	14	14.3	0.5	0
21:30-21:45							14	1	15	6.7	0.5	0
21:45-22:00							16	4	20	20.0	0.7	0
1時間計							55	8	63	12.7	2.2	0
22:00-22:15							15	4	19	21.1	0.7	0
22:15-22:30							14	4	18	22.2	0.6	0
22:30-22:45							15	4	19	21.1	0.7	1
22:45-23:00							10	0	10	0.0	0.4	0
1時間計							54	12	66	18.2	2.3	1

方向別自動車交通量調査表

調査地点：地域社会4 瀬谷土橋公園前

調査年月日：令和2年9月21日(月・祝) 天候：曇りのち晴れ



時間帯	方向 種別						B 合計 (3+4)					
		小型車 (台)	大型車 (台)	合計 (台)	大型車 混入率 (%)	時係 数 (%)	二輪車 (台)	小型車 (台)	大型車 (台)	合計 (台)	大型車 混入率 (%)	時係 数 (%)
23:00-23:15							9	1	10	10.0	0.4	0
23:15-23:30							4	3	7	42.9	0.2	2
23:30-23:45							8	3	11	27.3	0.4	1
23:45-24:00							9	2	11	18.2	0.4	0
1時間計							30	9	39	23.1	1.4	3
0:00-0:15							5	2	7	28.6	0.2	0
0:15-0:30							4	2	6	33.3	0.2	0
0:30-0:45							10	8	18	44.4	0.6	0
0:45-1:00							3	4	7	57.1	0.2	0
1時間計							22	16	38	42.1	1.3	0
1:00-1:15							1	5	6	83.3	0.2	4
1:15-1:30							1	7	8	87.5	0.3	1
1:30-1:45							4	4	8	50.0	0.3	1
1:45-2:00							1	7	8	87.5	0.3	0
1時間計							7	23	30	76.7	1.1	6
2:00-2:15							2	4	6	66.7	0.2	1
2:15-2:30							1	2	3	66.7	0.1	1
2:30-2:45							4	7	11	63.6	0.4	4
2:45-3:00							4	3	7	42.9	0.2	0
1時間計							11	16	27	59.3	1.0	6
3:00-3:15							1	3	4	75.0	0.1	0
3:15-3:30							1	1	2	50.0	0.1	0
3:30-3:45							4	1	5	20.0	0.2	0
3:45-4:00							4	1	5	20.0	0.2	0
1時間計							10	6	16	37.5	0.6	0
4:00-4:15							4	0	4	0.0	0.1	0
4:15-4:30							4	2	6	33.3	0.2	0
4:30-4:45							2	1	3	33.3	0.1	0
4:45-5:00							3	6	9	66.7	0.3	0
1時間計							13	9	22	40.9	0.8	0
5:00-5:15							10	3	13	23.1	0.5	1
5:15-5:30							10	4	14	28.6	0.5	3
5:30-5:45							11	7	18	38.9	0.6	0
5:45-6:00							21	2	23	8.7	0.8	0
1時間計							52	16	68	23.5	2.4	4
6:00-6:15							26	3	29	10.3	1.0	5
6:15-6:30							21	2	23	8.7	0.8	0
6:30-6:45							23	8	31	25.8	1.1	0
6:45-7:00							32	10	42	23.8	1.5	2
1時間計							102	23	125	18.4	4.4	7
夜12時間計							528	165	693	23.8	24.4	28
全時間合計							2396	440	2836	15.5	100.0	90
昼夜率							1.28	1.60	1.32	-	-	1.45

方向別自動車交通量調査表

調査地点 : 地域社会4 瀬谷土橋公園前

調査年月日 : 令和 2年 9月21日(月・祝) 天候:曇りのち晴れ



方向 時間帯	5						6					
	種別 小型車 (台)	大型車 (台)	合計 (台)	大型車 混入率 (%)	時間 係数 (%)	二輪車 (台)	小型車 (台)	大型車 (台)	合計 (台)	大型車 混入率 (%)	時間 係数 (%)	二輪車 (台)
7:00-7:15	1	1	2	50.0	0.6	0	10	3	13	23.1	1.4	0
7:15-7:30	2	3	5	60.0	1.6	0	10	6	16	37.5	1.7	0
7:30-7:45	5	1	6	16.7	1.9	0	7	2	9	22.2	0.9	0
7:45-8:00	3	1	4	25.0	1.3	0	11	2	13	15.4	1.4	1
1時間計	11	6	17	35.3	5.3	0	38	13	51	25.5	5.3	1
8:00-8:15	6	0	6	0.0	1.9	0	18	2	20	10.0	2.1	2
8:15-8:30	3	0	3	0.0	0.9	0	8	2	10	20.0	1.0	0
8:30-8:45	6	1	7	14.3	2.2	0	13	2	15	13.3	1.6	0
8:45-9:00	1	3	4	75.0	1.3	0	16	1	17	5.9	1.8	2
1時間計	16	4	20	20.0	6.3	0	55	7	62	11.3	6.5	4
9:00-9:15	4	3	7	42.9	2.2	0	9	4	13	30.8	1.4	0
9:15-9:30	5	2	7	28.6	2.2	0	8	2	10	20.0	1.0	0
9:30-9:45	3	0	3	0.0	0.9	0	5	5	10	50.0	1.0	2
9:45-10:00	2	0	2	0.0	0.6	0	14	3	17	17.6	1.8	0
1時間計	14	5	19	26.3	5.9	0	36	14	50	28.0	5.2	2
10:00-10:15	2	1	3	33.3	0.9	0	16	1	17	5.9	1.8	2
10:15-10:30	11	0	11	0.0	3.4	0	16	0	16	0.0	1.7	0
10:30-10:45	5	1	6	16.7	1.9	0	15	1	16	6.3	1.7	0
10:45-11:00	4	1	5	20.0	1.6	0	19	2	21	9.5	2.2	0
1時間計	22	3	25	12.0	7.8	0	66	4	70	5.7	7.3	2
11:00-11:15	5	3	8	37.5	2.5	0	18	3	21	14.3	2.2	0
11:15-11:30	3	0	3	0.0	0.9	0	10	11	21	52.4	2.2	2
11:30-11:45	2	3	5	60.0	1.6	1	10	3	13	23.1	1.4	0
11:45-12:00	7	2	9	22.2	2.8	0	19	3	22	13.6	2.3	0
1時間計	17	8	25	32.0	7.8	1	57	20	77	26.0	8.0	2
12:00-12:15	5	0	5	0.0	1.6	0	12	4	16	25.0	1.7	0
12:15-12:30	3	1	4	25.0	1.3	0	12	3	15	20.0	1.6	0
12:30-12:45	9	2	11	18.2	3.4	1	8	6	14	42.9	1.5	0
12:45-13:00	7	5	12	41.7	3.8	0	6	4	10	40.0	1.0	0
1時間計	24	8	32	25.0	10.0	1	38	17	55	30.9	5.7	0
13:00-13:15	2	4	6	66.7	1.9	0	13	4	17	23.5	1.8	0
13:15-13:30	4	2	6	33.3	1.9	0	13	3	16	18.8	1.7	0
13:30-13:45	5	1	6	16.7	1.9	0	9	4	13	30.8	1.4	1
13:45-14:00	3	1	4	25.0	1.3	1	5	5	10	50.0	1.0	0
1時間計	14	8	22	36.4	6.9	1	40	16	56	28.6	5.8	1
14:00-14:15	2	0	2	0.0	0.6	0	20	2	22	9.1	2.3	1
14:15-14:30	6	0	6	0.0	1.9	0	9	1	10	10.0	1.0	0
14:30-14:45	8	0	8	0.0	2.5	0	12	2	14	14.3	1.5	0
14:45-15:00	4	0	4	0.0	1.3	0	7	3	10	30.0	1.0	0
1時間計	20	0	20	0.0	6.3	0	48	8	56	14.3	5.8	1

方向別自動車交通量調査表

調査地点：地域社会4 瀬谷土橋公園前

調査年月日：令和2年9月21日(月・祝) 天候：曇りのち晴れ



方向 種別 時間帯	5						6					
	小型車 (台)	大型車 (台)	合計 (台)	大型車 混入率 (%)	時間 係数 (%)	二輪車 (台)	小型車 (台)	大型車 (台)	合計 (台)	大型車 混入率 (%)	時間 係数 (%)	二輪車 (台)
15:00-15:15	1	0	1	0.0	0.3	0	10	3	13	23.1	1.4	1
15:15-15:30	5	0	5	0.0	1.6	0	5	3	8	37.5	0.8	0
15:30-15:45	1	0	1	0.0	0.3	0	6	5	11	45.5	1.1	0
15:45-16:00	4	0	4	0.0	1.3	0	5	3	8	37.5	0.8	0
1時間計	11	0	11	0.0	3.4	0	26	14	40	35.0	4.2	1
16:00-16:15	7	1	8	12.5	2.5	0	10	0	10	0.0	1.0	2
16:15-16:30	6	2	8	25.0	2.5	0	5	1	6	16.7	0.6	0
16:30-16:45	8	0	8	0.0	2.5	0	11	1	12	8.3	1.3	1
16:45-17:00	6	0	6	0.0	1.9	1	8	1	9	11.1	0.9	0
1時間計	27	3	30	10.0	9.4	1	34	3	37	8.1	3.9	3
17:00-17:15	3	1	4	25.0	1.3	2	11	3	14	21.4	1.5	0
17:15-17:30	7	2	9	22.2	2.8	0	8	1	9	11.1	0.9	1
17:30-17:45	5	1	6	16.7	1.9	2	11	4	15	26.7	1.6	0
17:45-18:00	7	0	7	0.0	2.2	0	11	1	12	8.3	1.3	2
1時間計	22	4	26	15.4	8.1	4	41	9	50	18.0	5.2	3
18:00-18:15	5	1	6	16.7	1.9	0	13	1	14	7.1	1.5	1
18:15-18:30	2	0	2	0.0	0.6	0	15	1	16	6.3	1.7	0
18:30-18:45	3	0	3	0.0	0.9	0	8	1	9	11.1	0.9	0
18:45-19:00	1	1	2	50.0	0.6	1	4	4	8	50.0	0.8	1
1時間計	11	2	13	15.4	4.1	1	40	7	47	14.9	4.9	2
昼12時間計	209	51	260	19.6	81.3	9	519	132	651	20.3	68.0	22
19:00-19:15	1	0	1	0.0	0.3	0	4	1	5	20.0	0.5	0
19:15-19:30	3	0	3	0.0	0.9	0	3	2	5	40.0	0.5	1
19:30-19:45	1	1	2	50.0	0.6	0	7	2	9	22.2	0.9	1
19:45-20:00	3	0	3	0.0	0.9	0	2	2	4	50.0	0.4	1
1時間計	8	1	9	11.1	2.8	0	16	7	23	30.4	2.4	3
20:00-20:15	1	0	1	0.0	0.3	0	3	1	4	25.0	0.4	0
20:15-20:30	0	1	1	100.0	0.3	1	4	0	4	0.0	0.4	0
20:30-20:45	1	0	1	0.0	0.3	0	11	1	12	8.3	1.3	1
20:45-21:00	3	0	3	0.0	0.9	0	3	0	3	0.0	0.3	0
1時間計	5	1	6	16.7	1.9	1	21	2	23	8.7	2.4	1
21:00-21:15	1	2	3	66.7	0.9	0	3	2	5	40.0	0.5	0
21:15-21:30	1	1	2	50.0	0.6	0	5	3	8	37.5	0.8	0
21:30-21:45	2	1	3	33.3	0.9	1	3	0	3	0.0	0.3	0
21:45-22:00	1	2	3	66.7	0.9	0	4	6	10	60.0	1.0	0
1時間計	5	6	11	54.5	3.4	1	15	11	26	42.3	2.7	0
22:00-22:15	0	1	1	100.0	0.3	0	1	3	4	75.0	0.4	0
22:15-22:30	0	0	0	0.0	0.0	0	3	1	4	25.0	0.4	0
22:30-22:45	2	1	3	33.3	0.9	0	4	6	10	60.0	1.0	0
22:45-23:00	2	0	2	0.0	0.6	0	1	3	4	75.0	0.4	0
1時間計	4	2	6	33.3	1.9	0	9	13	22	59.1	2.3	0

方向別自動車交通量調査表

調査地点 : 地域社会 4 瀬谷土橋公園前

調査年月日 : 令和 2年 9月21日(月・祝) 天候:曇りのち晴れ



方向 種別 時間帯	5						6					
	小型車 (台)	大型車 (台)	合計 (台)	大型車 混入率 (%)	時間 係数 (%)	二輪車 (台)	小型車 (台)	大型車 (台)	合計 (台)	大型車 混入率 (%)	時間 係数 (%)	二輪車 (台)
23:00-23:15	1	0	1	0.0	0.3	0	3	2	5	40.0	0.5	0
23:15-23:30	0	1	1	100.0	0.3	0	2	2	4	50.0	0.4	0
23:30-23:45	0	0	0	0.0	0.0	0	3	5	8	62.5	0.8	0
23:45-24:00	2	1	3	33.3	0.9	0	4	5	9	55.6	0.9	0
1時間計	3	2	5	40.0	1.6	0	12	14	26	53.8	2.7	0
0:00-0:15	0	0	0	0.0	0.0	0	2	9	11	81.8	1.1	0
0:15-0:30	1	0	1	0.0	0.3	0	3	3	6	50.0	0.6	0
0:30-0:45	1	0	1	0.0	0.3	0	4	3	7	42.9	0.7	0
0:45-1:00	0	0	0	0.0	0.0	0	4	6	10	60.0	1.0	0
1時間計	2	0	2	0.0	0.6	0	13	21	34	61.8	3.5	0
1:00-1:15	0	0	0	0.0	0.0	0	1	7	8	87.5	0.8	4
1:15-1:30	1	2	3	66.7	0.9	0	5	3	8	37.5	0.8	0
1:30-1:45	1	2	3	66.7	0.9	0	4	3	7	42.9	0.7	0
1:45-2:00	0	0	0	0.0	0.0	0	1	4	5	80.0	0.5	0
1時間計	2	4	6	66.7	1.9	0	11	17	28	60.7	2.9	4
2:00-2:15	0	0	0	0.0	0.0	1	0	0	0	0.0	0.0	1
2:15-2:30	0	0	0	0.0	0.0	0	0	1	1	100.0	0.1	0
2:30-2:45	1	0	1	0.0	0.3	0	1	2	3	66.7	0.3	0
2:45-3:00	0	0	0	0.0	0.0	0	4	3	7	42.9	0.7	0
1時間計	1	0	1	0.0	0.3	1	5	6	11	54.5	1.1	1
3:00-3:15	0	0	0	0.0	0.0	0	0	2	2	100.0	0.2	1
3:15-3:30	0	0	0	0.0	0.0	0	2	1	3	33.3	0.3	0
3:30-3:45	0	0	0	0.0	0.0	0	1	2	3	66.7	0.3	0
3:45-4:00	0	0	0	0.0	0.0	0	0	0	0	0.0	0.0	0
1時間計	0	0	0	0.0	0.0	0	3	5	8	62.5	0.8	1
4:00-4:15	0	0	0	0.0	0.0	0	2	1	3	33.3	0.3	0
4:15-4:30	0	0	0	0.0	0.0	0	0	1	1	100.0	0.1	1
4:30-4:45	0	0	0	0.0	0.0	0	1	1	2	50.0	0.2	1
4:45-5:00	0	1	1	100.0	0.3	0	0	1	1	100.0	0.1	0
1時間計	0	1	1	100.0	0.3	0	3	4	7	57.1	0.7	2
5:00-5:15	0	1	1	100.0	0.3	0	2	7	9	77.8	0.9	0
5:15-5:30	2	0	2	0.0	0.6	0	4	6	10	60.0	1.0	0
5:30-5:45	0	2	2	100.0	0.6	1	4	4	8	50.0	0.8	1
5:45-6:00	1	0	1	0.0	0.3	0	5	7	12	58.3	1.3	1
1時間計	3	3	6	50.0	1.9	1	15	24	39	61.5	4.1	2
6:00-6:15	0	1	1	100.0	0.3	0	11	6	17	35.3	1.8	0
6:15-6:30	0	2	2	100.0	0.6	0	7	7	14	50.0	1.5	0
6:30-6:45	0	3	3	100.0	0.9	0	8	10	18	55.6	1.9	2
6:45-7:00	0	1	1	100.0	0.3	0	7	4	11	36.4	1.1	1
1時間計	0	7	7	100.0	2.2	0	33	27	60	45.0	6.3	3
夜12時間計	33	27	60	45.0	18.8	4	156	151	307	49.2	32.0	17
全時間合計	242	78	320	24.4	100.0	13	675	283	958	29.5	100.0	39
昼夜率	1.16	1.53	1.23	-	-	1.44	1.30	2.14	1.47	-	-	1.77

方向別自動車交通量調査表

調査地点：地域社会4 瀬谷土橋公園前

調査年月日：令和2年9月21日(月・祝) 天候：曇りのち晴れ



方向 種別 時間帯							C 合計 (5+6)					
	小型車 (台)	大型車 (台)	合計 (台)	大型車 混入率 (%)	時間 係数 (%)	二輪車 (台)	小型車 (台)	大型車 (台)	合計 (台)	大型車 混入率 (%)	時間 係数 (%)	二輪車 (台)
7:00-7:15							11	4	15	26.7	1.2	0
7:15-7:30							12	9	21	42.9	1.6	0
7:30-7:45							12	3	15	20.0	1.2	0
7:45-8:00							14	3	17	17.6	1.3	1
1時間計							49	19	68	27.9	5.3	1
8:00-8:15							24	2	26	7.7	2.0	2
8:15-8:30							11	2	13	15.4	1.0	0
8:30-8:45							19	3	22	13.6	1.7	0
8:45-9:00							17	4	21	19.0	1.6	2
1時間計							71	11	82	13.4	6.4	4
9:00-9:15							13	7	20	35.0	1.6	0
9:15-9:30							13	4	17	23.5	1.3	0
9:30-9:45							8	5	13	38.5	1.0	2
9:45-10:00							16	3	19	15.8	1.5	0
1時間計							50	19	69	27.5	5.4	2
10:00-10:15							18	2	20	10.0	1.6	2
10:15-10:30							27	0	27	0.0	2.1	0
10:30-10:45							20	2	22	9.1	1.7	0
10:45-11:00							23	3	26	11.5	2.0	0
1時間計							88	7	95	7.4	7.4	2
11:00-11:15							23	6	29	20.7	2.3	0
11:15-11:30							13	11	24	45.8	1.9	2
11:30-11:45							12	6	18	33.3	1.4	1
11:45-12:00							26	5	31	16.1	2.4	0
1時間計							74	28	102	27.5	8.0	3
12:00-12:15							17	4	21	19.0	1.6	0
12:15-12:30							15	4	19	21.1	1.5	0
12:30-12:45							17	8	25	32.0	2.0	1
12:45-13:00							13	9	22	40.9	1.7	0
1時間計							62	25	87	28.7	6.8	1
13:00-13:15							15	8	23	34.8	1.8	0
13:15-13:30							17	5	22	22.7	1.7	0
13:30-13:45							14	5	19	26.3	1.5	1
13:45-14:00							8	6	14	42.9	1.1	1
1時間計							54	24	78	30.8	6.1	2
14:00-14:15							22	2	24	8.3	1.9	1
14:15-14:30							15	1	16	6.3	1.3	0
14:30-14:45							20	2	22	9.1	1.7	0
14:45-15:00							11	3	14	21.4	1.1	0
1時間計							68	8	76	10.5	5.9	1

方向別自動車交通量調査表

調査地点：地域社会4 瀬谷土橋公園前

調査年月日：令和2年9月21日(月・祝) 天候：曇りのち晴れ



方向 種別 時間帯							C 合計 (5+6)					
	小型車 (台)	大型車 (台)	合計 (台)	大型車 混入率 (%)	時間 係数 (%)	二輪車 (台)	小型車 (台)	大型車 (台)	合計 (台)	大型車 混入率 (%)	時間 係数 (%)	二輪車 (台)
15:00-15:15							11	3	14	21.4	1.1	1
15:15-15:30							10	3	13	23.1	1.0	0
15:30-15:45							7	5	12	41.7	0.9	0
15:45-16:00							9	3	12	25.0	0.9	0
1時間計							37	14	51	27.5	4.0	1
16:00-16:15							17	1	18	5.6	1.4	2
16:15-16:30							11	3	14	21.4	1.1	0
16:30-16:45							19	1	20	5.0	1.6	1
16:45-17:00							14	1	15	6.7	1.2	1
1時間計							61	6	67	9.0	5.2	4
17:00-17:15							14	4	18	22.2	1.4	2
17:15-17:30							15	3	18	16.7	1.4	1
17:30-17:45							16	5	21	23.8	1.6	2
17:45-18:00							18	1	19	5.3	1.5	2
1時間計							63	13	76	17.1	5.9	7
18:00-18:15							18	2	20	10.0	1.6	1
18:15-18:30							17	1	18	5.6	1.4	0
18:30-18:45							11	1	12	8.3	0.9	0
18:45-19:00							5	5	10	50.0	0.8	2
1時間計							51	9	60	15.0	4.7	3
昼12時間計							728	183	911	20.1	71.3	31
19:00-19:15							5	1	6	16.7	0.5	0
19:15-19:30							6	2	8	25.0	0.6	1
19:30-19:45							8	3	11	27.3	0.9	1
19:45-20:00							5	2	7	28.6	0.5	1
1時間計							24	8	32	25.0	2.5	3
20:00-20:15							4	1	5	20.0	0.4	0
20:15-20:30							4	1	5	20.0	0.4	1
20:30-20:45							12	1	13	7.7	1.0	1
20:45-21:00							6	0	6	0.0	0.5	0
1時間計							26	3	29	10.3	2.3	2
21:00-21:15							4	4	8	50.0	0.6	0
21:15-21:30							6	4	10	40.0	0.8	0
21:30-21:45							5	1	6	16.7	0.5	1
21:45-22:00							5	8	13	61.5	1.0	0
1時間計							20	17	37	45.9	2.9	1
22:00-22:15							1	4	5	80.0	0.4	0
22:15-22:30							3	1	4	25.0	0.3	0
22:30-22:45							6	7	13	53.8	1.0	0
22:45-23:00							3	3	6	50.0	0.5	0
1時間計							13	15	28	53.6	2.2	0

方向別自動車交通量調査表

調査地点：地域社会4 瀬谷土橋公園前

調査年月日：令和2年9月21日(月・祝) 天候：曇りのち晴れ



方向 種別 時間帯							C 合計 (5+6)					
	小型車 (台)	大型車 (台)	合計 (台)	大型車 混入率 (%)	時間 係数 (%)	二輪車 (台)	小型車 (台)	大型車 (台)	合計 (台)	大型車 混入率 (%)	時間 係数 (%)	二輪車 (台)
23:00-23:15							4	2	6	33.3	0.5	0
23:15-23:30							2	3	5	60.0	0.4	0
23:30-23:45							3	5	8	62.5	0.6	0
23:45-24:00							6	6	12	50.0	0.9	0
1時間計							15	16	31	51.6	2.4	0
0:00-0:15							2	9	11	81.8	0.9	0
0:15-0:30							4	3	7	42.9	0.5	0
0:30-0:45							5	3	8	37.5	0.6	0
0:45-1:00							4	6	10	60.0	0.8	0
1時間計							15	21	36	58.3	2.8	0
1:00-1:15							1	7	8	87.5	0.6	4
1:15-1:30							6	5	11	45.5	0.9	0
1:30-1:45							5	5	10	50.0	0.8	0
1:45-2:00							1	4	5	80.0	0.4	0
1時間計							13	21	34	61.8	2.7	4
2:00-2:15							0	0	0	0.0	0.0	2
2:15-2:30							0	1	1	100.0	0.1	0
2:30-2:45							2	2	4	50.0	0.3	0
2:45-3:00							4	3	7	42.9	0.5	0
1時間計							6	6	12	50.0	0.9	2
3:00-3:15							0	2	2	100.0	0.2	1
3:15-3:30							2	1	3	33.3	0.2	0
3:30-3:45							1	2	3	66.7	0.2	0
3:45-4:00							0	0	0	0.0	0.0	0
1時間計							3	5	8	62.5	0.6	1
4:00-4:15							2	1	3	33.3	0.2	0
4:15-4:30							0	1	1	100.0	0.1	1
4:30-4:45							1	1	2	50.0	0.2	1
4:45-5:00							0	2	2	100.0	0.2	0
1時間計							3	5	8	62.5	0.6	2
5:00-5:15							2	8	10	80.0	0.8	0
5:15-5:30							6	6	12	50.0	0.9	0
5:30-5:45							4	6	10	60.0	0.8	2
5:45-6:00							6	7	13	53.8	1.0	1
1時間計							18	27	45	60.0	3.5	3
6:00-6:15							11	7	18	38.9	1.4	0
6:15-6:30							7	9	16	56.3	1.3	0
6:30-6:45							8	13	21	61.9	1.6	2
6:45-7:00							7	5	12	41.7	0.9	1
1時間計							33	34	67	50.7	5.2	3
夜12時間計							189	178	367	48.5	28.7	21
全時間合計							917	361	1278	28.2	100.0	52
昼夜率							1.26	1.97	1.40	-	-	1.68

方向別自動車交通量調査表

調査地点：地域社会5

調査年月日：令和元年10月13日(日) 天候：曇りのち雨

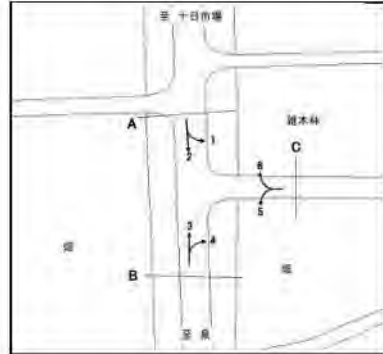

方向	1						2						
	種別	小型車 (台)	大型車 (台)	合計 (台)	大型車 混入率 (%)	時係 数 (%)	二輪車 (台)	小型車 (台)	大型車 (台)	合計 (台)	大型車 混入率 (%)	時係 数 (%)	二輪車 (台)
22:00-22:15		19	0	19	0.0	1.2	3	63	4	67	6.0	1.2	4
22:15-22:30		17	1	18	5.6	1.1	2	46	5	51	9.8	0.9	11
22:30-22:45		10	0	10	0.0	0.6	3	49	8	57	14.0	1.0	4
22:45-23:00		15	0	15	0.0	0.9	2	52	3	55	5.5	1.0	2
1時間計		61	1	62	1.6	3.8	10	210	20	230	8.7	4.1	21
23:00-23:15		9	0	9	0.0	0.6	1	47	6	53	11.3	0.9	3
23:15-23:30		9	0	9	0.0	0.6	0	35	2	37	5.4	0.7	2
23:30-23:45		8	0	8	0.0	0.5	2	26	2	28	7.1	0.5	3
23:45-24:00		5	0	5	0.0	0.3	0	22	3	25	12.0	0.4	4
1時間計		31	0	31	0.0	1.9	3	130	13	143	9.1	2.6	12
0:00-0:15		4	0	4	0.0	0.2	0	33	1	34	2.9	0.6	3
0:15-0:30		3	0	3	0.0	0.2	0	13	2	15	13.3	0.3	1
0:30-0:45		5	0	5	0.0	0.3	0	22	10	32	31.3	0.6	3
0:45-1:00		2	0	2	0.0	0.1	0	17	3	20	15.0	0.4	2
1時間計		14	0	14	0.0	0.9	0	85	16	101	15.8	1.8	9
1:00-1:15		2	0	2	0.0	0.1	0	13	1	14	7.1	0.3	3
1:15-1:30		3	1	4	25.0	0.2	0	17	2	19	10.5	0.3	3
1:30-1:45		2	0	2	0.0	0.1	0	10	3	13	23.1	0.2	2
1:45-2:00		2	0	2	0.0	0.1	0	6	7	13	53.8	0.2	0
1時間計		9	1	10	10.0	0.6	0	46	13	59	22.0	1.1	8
2:00-2:15		3	0	3	0.0	0.2	1	14	0	14	0.0	0.3	1
2:15-2:30		4	0	4	0.0	0.2	0	14	2	16	12.5	0.3	1
2:30-2:45		1	0	1	0.0	0.1	0	9	0	9	0.0	0.2	0
2:45-3:00		1	1	2	50.0	0.1	0	10	4	14	28.6	0.3	2
1時間計		9	1	10	10.0	0.6	1	47	6	53	11.3	0.9	4
3:00-3:15		0	0	0	0.0	0.0	1	8	1	9	11.1	0.2	1
3:15-3:30		1	0	1	0.0	0.1	1	7	2	9	22.2	0.2	0
3:30-3:45		3	0	3	0.0	0.2	0	8	1	9	11.1	0.2	1
3:45-4:00		1	1	2	50.0	0.1	0	11	3	14	21.4	0.3	0
1時間計		5	1	6	16.7	0.4	2	34	7	41	17.1	0.7	2
4:00-4:15		4	0	4	0.0	0.2	0	12	3	15	20.0	0.3	0
4:15-4:30		0	0	0	0.0	0.0	0	11	5	16	31.3	0.3	1
4:30-4:45		1	0	1	0.0	0.1	1	11	5	16	31.3	0.3	1
4:45-5:00		2	0	2	0.0	0.1	0	19	6	25	24.0	0.4	0
1時間計		7	0	7	0.0	0.4	1	53	19	72	26.4	1.3	2
5:00-5:15		1	0	1	0.0	0.1	0	11	8	19	42.1	0.3	3
5:15-5:30		5	1	6	16.7	0.4	0	16	3	19	15.8	0.3	5
5:30-5:45		8	0	8	0.0	0.5	0	23	4	27	14.8	0.5	1
5:45-6:00		9	0	9	0.0	0.6	0	29	7	36	19.4	0.6	1
1時間計		23	1	24	4.2	1.5	0	79	22	101	21.8	1.8	10

方向別自動車交通量調査表

調査地点 : 地域社会5

調査年月日 : 令和元年10月13日(日) 天候:曇りのち雨

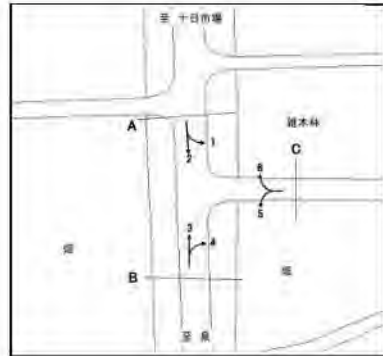

方向 種別 時間帯	1						2					
	小型車 (台)	大型車 (台)	合計 (台)	大型車 混入率 (%)	時間 係数 (%)	二輪車 (台)	小型車 (台)	大型車 (台)	合計 (台)	大型車 混入率 (%)	時間 係数 (%)	二輪車 (台)
6:00-6:15	9	0	9	0.0	0.6	0	44	9	53	17.0	0.9	1
6:15-6:30	13	1	14	7.1	0.9	2	39	7	46	15.2	0.8	3
6:30-6:45	13	2	15	13.3	0.9	0	39	14	53	26.4	0.9	8
6:45-7:00	16	0	16	0.0	1.0	1	46	17	63	27.0	1.1	5
1時間計	51	3	54	5.6	3.3	3	168	47	215	21.9	3.8	17
7:00-7:15	21	3	24	12.5	1.5	1	47	9	56	16.1	1.0	8
7:15-7:30	24	2	26	7.7	1.6	0	60	10	70	14.3	1.3	3
7:30-7:45	29	3	32	9.4	2.0	0	72	11	83	13.3	1.5	6
7:45-8:00	20	1	21	4.8	1.3	1	71	15	86	17.4	1.5	5
1時間計	94	9	103	8.7	6.3	2	250	45	295	15.3	5.3	22
8:00-8:15	33	0	33	0.0	2.0	2	76	19	95	20.0	1.7	3
8:15-8:30	15	0	15	0.0	0.9	0	53	10	63	15.9	1.1	4
8:30-8:45	29	1	30	3.3	1.8	1	52	6	58	10.3	1.0	1
8:45-9:00	22	0	22	0.0	1.4	2	71	8	79	10.1	1.4	6
1時間計	99	1	100	1.0	6.1	5	252	43	295	14.6	5.3	14
9:00-9:15	21	0	21	0.0	1.3	2	71	12	83	14.5	1.5	2
9:15-9:30	17	3	20	15.0	1.2	0	76	7	83	8.4	1.5	4
9:30-9:45	20	2	22	9.1	1.4	1	71	7	78	9.0	1.4	4
9:45-10:00	16	1	17	5.9	1.0	0	78	8	86	9.3	1.5	5
1時間計	74	6	80	7.5	4.9	3	296	34	330	10.3	5.9	15
10:00-10:15	21	2	23	8.7	1.4	0	77	11	88	12.5	1.6	3
10:15-10:30	17	2	19	10.5	1.2	0	60	14	74	18.9	1.3	1
10:30-10:45	13	3	16	18.8	1.0	1	54	16	70	22.9	1.3	4
10:45-11:00	16	3	19	15.8	1.2	0	68	14	82	17.1	1.5	4
1時間計	67	10	77	13.0	4.7	1	259	55	314	17.5	5.6	12
11:00-11:15	20	1	21	4.8	1.3	0	65	15	80	18.8	1.4	2
11:15-11:30	28	2	30	6.7	1.8	1	80	9	89	10.1	1.6	1
11:30-11:45	26	2	28	7.1	1.7	0	66	11	77	14.3	1.4	2
11:45-12:00	20	1	21	4.8	1.3	1	72	12	84	14.3	1.5	2
1時間計	94	6	100	6.0	6.1	2	283	47	330	14.2	5.9	7
12:00-12:15	25	2	27	7.4	1.7	2	61	14	75	18.7	1.3	3
12:15-12:30	19	1	20	5.0	1.2	1	69	5	74	6.8	1.3	4
12:30-12:45	31	0	31	0.0	1.9	1	77	4	81	4.9	1.4	3
12:45-13:00	23	0	23	0.0	1.4	0	75	9	84	10.7	1.5	1
1時間計	98	3	101	3.0	6.2	4	282	32	314	10.2	5.6	11
13:00-13:15	26	3	29	10.3	1.8	0	68	5	73	6.8	1.3	3
13:15-13:30	15	1	16	6.3	1.0	1	76	8	84	9.5	1.5	2
13:30-13:45	29	1	30	3.3	1.8	0	63	14	77	18.2	1.4	0
13:45-14:00	28	2	30	6.7	1.8	0	53	5	58	8.6	1.0	1
1時間計	98	7	105	6.7	6.4	1	260	32	292	11.0	5.2	6

方向別自動車交通量調査表

調査地点 : 地域社会5

調査年月日 : 令和元年10月13日(日) 天候:曇りのち雨

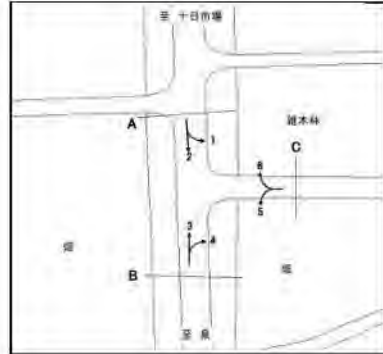

方向 種別 時間帯	1						2					
	小型車 (台)	大型車 (台)	合計 (台)	大型車 混入率 (%)	時間 係数 (%)	二輪車 (台)	小型車 (台)	大型車 (台)	合計 (台)	大型車 混入率 (%)	時間 係数 (%)	二輪車 (台)
14:00-14:15	17	1	18	5.6	1.1	0	72	5	77	6.5	1.4	3
14:15-14:30	19	1	20	5.0	1.2	0	57	6	63	9.5	1.1	7
14:30-14:45	17	0	17	0.0	1.0	0	66	1	67	1.5	1.2	0
14:45-15:00	26	0	26	0.0	1.6	1	87	4	91	4.4	1.6	1
1時間計	79	2	81	2.5	5.0	1	282	16	298	5.4	5.3	11
15:00-15:15	26	0	26	0.0	1.6	2	64	2	66	3.0	1.2	3
15:15-15:30	33	0	33	0.0	2.0	0	76	7	83	8.4	1.5	2
15:30-15:45	28	0	28	0.0	1.7	2	86	5	91	5.5	1.6	1
15:45-16:00	32	0	32	0.0	2.0	1	83	11	94	11.7	1.7	0
1時間計	119	0	119	0.0	7.3	5	309	25	334	7.5	6.0	6
16:00-16:15	30	0	30	0.0	1.8	0	81	9	90	10.0	1.6	3
16:15-16:30	49	0	49	0.0	3.0	1	71	10	81	12.3	1.4	2
16:30-16:45	35	2	37	5.4	2.3	0	92	9	101	8.9	1.8	5
16:45-17:00	34	2	36	5.6	2.2	2	65	10	75	13.3	1.3	3
1時間計	148	4	152	2.6	9.3	3	309	38	347	11.0	6.2	13
17:00-17:15	35	3	38	7.9	2.3	0	90	12	102	11.8	1.8	3
17:15-17:30	32	0	32	0.0	2.0	1	77	9	86	10.5	1.5	7
17:30-17:45	23	0	23	0.0	1.4	1	73	12	85	14.1	1.5	7
17:45-18:00	36	0	36	0.0	2.2	1	87	3	90	3.3	1.6	6
1時間計	126	3	129	2.3	7.9	3	327	36	363	9.9	6.5	23
18:00-18:15	28	0	28	0.0	1.7	2	101	12	113	10.6	2.0	2
18:15-18:30	25	0	25	0.0	1.5	1	65	2	67	3.0	1.2	2
18:30-18:45	17	0	17	0.0	1.0	0	74	3	77	3.9	1.4	3
18:45-19:00	21	1	22	4.5	1.4	1	56	3	59	5.1	1.1	4
1時間計	91	1	92	1.1	5.7	4	296	20	316	6.3	5.6	11
19:00-19:15	19	0	19	0.0	1.2	0	50	4	54	7.4	1.0	0
19:15-19:30	11	0	11	0.0	0.7	0	59	2	61	3.3	1.1	0
19:30-19:45	15	0	15	0.0	0.9	0	64	3	67	4.5	1.2	2
19:45-20:00	18	0	18	0.0	1.1	0	46	2	48	4.2	0.9	2
1時間計	63	0	63	0.0	3.9	0	219	11	230	4.8	4.1	4
20:00-20:15	20	2	22	9.1	1.4	1	83	5	88	5.7	1.6	7
20:15-20:30	13	0	13	0.0	0.8	0	56	2	58	3.4	1.0	4
20:30-20:45	18	0	18	0.0	1.1	1	57	4	61	6.6	1.1	4
20:45-21:00	4	0	4	0.0	0.2	0	59	8	67	11.9	1.2	3
1時間計	55	2	57	3.5	3.5	2	255	19	274	6.9	4.9	18
21:00-21:15	20	0	20	0.0	1.2	1	71	2	73	2.7	1.3	0
21:15-21:30	11	0	11	0.0	0.7	1	58	1	59	1.7	1.1	6
21:30-21:45	10	0	10	0.0	0.6	1	57	3	60	5.0	1.1	9
21:45-22:00	10	0	10	0.0	0.6	1	53	2	55	3.6	1.0	2
1時間計	51	0	51	0.0	3.1	4	239	8	247	3.2	4.4	17
昼12時間計	1187	52	1239	4.2	76.1	34	3405	423	3828	11.1	68.4	151
夜12時間計	379	10	389	2.6	23.9	26	1565	201	1766	11.4	31.6	124
全時間合計	1566	62	1628	3.8	100.0	60	4970	624	5594	11.2	100.0	275
昼夜率	1.32	1.19	1.31	-	-	1.76	1.46	1.48	1.46	-	-	1.82

方向別自動車交通量調査表

調査地点 : 地域社会5

調査年月日 : 令和元年10月13日(日) 天候:曇りのち雨

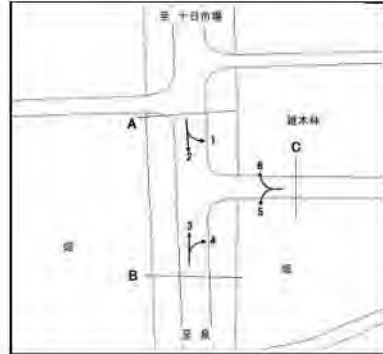

方向 種別 時間帯							A 合計 (1+2)					
	小型車 (台)	大型車 (台)	合計 (台)	大型車 混入率 (%)	時係 数 (%)	二輪車 (台)	小型車 (台)	大型車 (台)	合計 (台)	大型車 混入率 (%)	時係 数 (%)	二輪車 (台)
22:00-22:15							82	4	86	4.7	1.2	7
22:15-22:30							63	6	69	8.7	1.0	13
22:30-22:45							59	8	67	11.9	0.9	7
22:45-23:00							67	3	70	4.3	1.0	4
1時間計							271	21	292	7.2	4.0	31
23:00-23:15							56	6	62	9.7	0.9	4
23:15-23:30							44	2	46	4.3	0.6	2
23:30-23:45							34	2	36	5.6	0.5	5
23:45-24:00							27	3	30	10.0	0.4	4
1時間計							161	13	174	7.5	2.4	15
0:00-0:15							37	1	38	2.6	0.5	3
0:15-0:30							16	2	18	11.1	0.2	1
0:30-0:45							27	10	37	27.0	0.5	3
0:45-1:00							19	3	22	13.6	0.3	2
1時間計							99	16	115	13.9	1.6	9
1:00-1:15							15	1	16	6.3	0.2	3
1:15-1:30							20	3	23	13.0	0.3	3
1:30-1:45							12	3	15	20.0	0.2	2
1:45-2:00							8	7	15	46.7	0.2	0
1時間計							55	14	69	20.3	1.0	8
2:00-2:15							17	0	17	0.0	0.2	2
2:15-2:30							18	2	20	10.0	0.3	1
2:30-2:45							10	0	10	0.0	0.1	0
2:45-3:00							11	5	16	31.3	0.2	2
1時間計							56	7	63	11.1	0.9	5
3:00-3:15							8	1	9	11.1	0.1	2
3:15-3:30							8	2	10	20.0	0.1	1
3:30-3:45							11	1	12	8.3	0.2	1
3:45-4:00							12	4	16	25.0	0.2	0
1時間計							39	8	47	17.0	0.7	4
4:00-4:15							16	3	19	15.8	0.3	0
4:15-4:30							11	5	16	31.3	0.2	1
4:30-4:45							12	5	17	29.4	0.2	2
4:45-5:00							21	6	27	22.2	0.4	0
1時間計							60	19	79	24.1	1.1	3
5:00-5:15							12	8	20	40.0	0.3	3
5:15-5:30							21	4	25	16.0	0.3	5
5:30-5:45							31	4	35	11.4	0.5	1
5:45-6:00							38	7	45	15.6	0.6	1
1時間計							102	23	125	18.4	1.7	10

方向別自動車交通量調査表

調査地点 : 地域社会5

調査年月日 : 令和元年10月13日(日) 天候:曇りのち雨

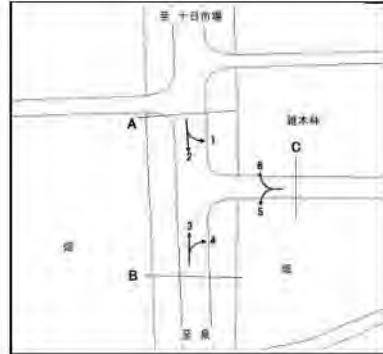

時間帯	方向 種別						A 合計 (1+2)					
		小型車 (台)	大型車 (台)	合計 (台)	大型車 混入率 (%)	時 間 係 数 (%)	二輪車 (台)	小型車 (台)	大型車 (台)	合計 (台)	大型車 混入率 (%)	時 間 係 数 (%)
6:00-6:15							53	9	62	14.5	0.9	1
6:15-6:30							52	8	60	13.3	0.8	5
6:30-6:45							52	16	68	23.5	0.9	8
6:45-7:00							62	17	79	21.5	1.1	6
1時間計							219	50	269	18.6	3.7	20
7:00-7:15							68	12	80	15.0	1.1	9
7:15-7:30							84	12	96	12.5	1.3	3
7:30-7:45							101	14	115	12.2	1.6	6
7:45-8:00							91	16	107	15.0	1.5	6
1時間計							344	54	398	13.6	5.5	24
8:00-8:15							109	19	128	14.8	1.8	5
8:15-8:30							68	10	78	12.8	1.1	4
8:30-8:45							81	7	88	8.0	1.2	2
8:45-9:00							93	8	101	7.9	1.4	8
1時間計							351	44	395	11.1	5.5	19
9:00-9:15							92	12	104	11.5	1.4	4
9:15-9:30							93	10	103	9.7	1.4	4
9:30-9:45							91	9	100	9.0	1.4	5
9:45-10:00							94	9	103	8.7	1.4	5
1時間計							370	40	410	9.8	5.7	18
10:00-10:15							98	13	111	11.7	1.5	3
10:15-10:30							77	16	93	17.2	1.3	1
10:30-10:45							67	19	86	22.1	1.2	5
10:45-11:00							84	17	101	16.8	1.4	4
1時間計							326	65	391	16.6	5.4	13
11:00-11:15							85	16	101	15.8	1.4	2
11:15-11:30							108	11	119	9.2	1.6	2
11:30-11:45							92	13	105	12.4	1.5	2
11:45-12:00							92	13	105	12.4	1.5	3
1時間計							377	53	430	12.3	6.0	9
12:00-12:15							86	16	102	15.7	1.4	5
12:15-12:30							88	6	94	6.4	1.3	5
12:30-12:45							108	4	112	3.6	1.6	4
12:45-13:00							98	9	107	8.4	1.5	1
1時間計							380	35	415	8.4	5.7	15
13:00-13:15							94	8	102	7.8	1.4	3
13:15-13:30							91	9	100	9.0	1.4	3
13:30-13:45							92	15	107	14.0	1.5	0
13:45-14:00							81	7	88	8.0	1.2	1
1時間計							358	39	397	9.8	5.5	7

方向別自動車交通量調査表

調査地点 : 地域社会5

調査年月日 : 令和元年10月13日(日) 天候:曇りのち雨



方向 種別 時間帯							A 合計 (1+2)					
	小型車 (台)	大型車 (台)	合計 (台)	大型車 混入率 (%)	時間 係数 (%)	二輪車 (台)	小型車 (台)	大型車 (台)	合計 (台)	大型車 混入率 (%)	時間 係数 (%)	二輪車 (台)
14:00-14:15							89	6	95	6.3	1.3	3
14:15-14:30							76	7	83	8.4	1.1	7
14:30-14:45							83	1	84	1.2	1.2	0
14:45-15:00							113	4	117	3.4	1.6	2
1時間計							361	18	379	4.7	5.2	12
15:00-15:15							90	2	92	2.2	1.3	5
15:15-15:30							109	7	116	6.0	1.6	2
15:30-15:45							114	5	119	4.2	1.6	3
15:45-16:00							115	11	126	8.7	1.7	1
1時間計							428	25	453	5.5	6.3	11
16:00-16:15							111	9	120	7.5	1.7	3
16:15-16:30							120	10	130	7.7	1.8	3
16:30-16:45							127	11	138	8.0	1.9	5
16:45-17:00							99	12	111	10.8	1.5	5
1時間計							457	42	499	8.4	6.9	16
17:00-17:15							125	15	140	10.7	1.9	3
17:15-17:30							109	9	118	7.6	1.6	8
17:30-17:45							96	12	108	11.1	1.5	8
17:45-18:00							123	3	126	2.4	1.7	7
1時間計							453	39	492	7.9	6.8	26
18:00-18:15							129	12	141	8.5	2.0	4
18:15-18:30							90	2	92	2.2	1.3	3
18:30-18:45							91	3	94	3.2	1.3	3
18:45-19:00							77	4	81	4.9	1.1	5
1時間計							387	21	408	5.1	5.6	15
19:00-19:15							69	4	73	5.5	1.0	0
19:15-19:30							70	2	72	2.8	1.0	0
19:30-19:45							79	3	82	3.7	1.1	2
19:45-20:00							64	2	66	3.0	0.9	2
1時間計							282	11	293	3.8	4.1	4
20:00-20:15							103	7	110	6.4	1.5	8
20:15-20:30							69	2	71	2.8	1.0	4
20:30-20:45							75	4	79	5.1	1.1	5
20:45-21:00							63	8	71	11.3	1.0	3
1時間計							310	21	331	6.3	4.6	20
21:00-21:15							91	2	93	2.2	1.3	1
21:15-21:30							69	1	70	1.4	1.0	7
21:30-21:45							67	3	70	4.3	1.0	10
21:45-22:00							63	2	65	3.1	0.9	3
1時間計							290	8	298	2.7	4.1	21
昼12時間計							4592	475	5067	9.4	70.2	185
夜12時間計							1944	211	2155	9.8	29.8	150
全時間合計							6536	686	7222	9.5	100.0	335
昼夜率							1.42	1.44	1.43	-	-	1.81

方向別自動車交通量調査表

調査地点 : 地域社会5

調査年月日 : 令和元年10月13日(日) 天候:曇りのち雨

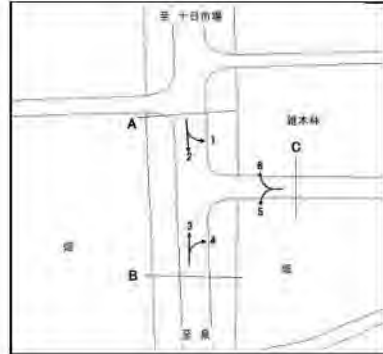

方向 種別 時間帯	3						4					
	小型車 (台)	大型車 (台)	合計 (台)	大型車 混入率 (%)	時間 係数 (%)	二輪車 (台)	小型車 (台)	大型車 (台)	合計 (台)	大型車 混入率 (%)	時間 係数 (%)	二輪車 (台)
22:00-22:15	46	3	49	6.1	0.8	2	7	0	7	0.0	0.9	0
22:15-22:30	32	3	35	8.6	0.6	6	7	0	7	0.0	0.9	0
22:30-22:45	41	5	46	10.9	0.8	4	4	1	5	20.0	0.7	1
22:45-23:00	36	11	47	23.4	0.8	4	2	0	2	0.0	0.3	0
1時間計	155	22	177	12.4	3.0	16	20	1	21	4.8	2.8	1
23:00-23:15	26	5	31	16.1	0.5	3	6	0	6	0.0	0.8	0
23:15-23:30	30	5	35	14.3	0.6	4	1	0	1	0.0	0.1	0
23:30-23:45	36	4	40	10.0	0.7	2	5	0	5	0.0	0.7	0
23:45-24:00	13	1	14	7.1	0.2	2	1	0	1	0.0	0.1	0
1時間計	105	15	120	12.5	2.0	11	13	0	13	0.0	1.7	0
0:00-0:15	22	3	25	12.0	0.4	3	1	0	1	0.0	0.1	0
0:15-0:30	11	1	12	8.3	0.2	2	1	0	1	0.0	0.1	0
0:30-0:45	14	1	15	6.7	0.3	2	0	0	0	0.0	0.0	0
0:45-1:00	13	0	13	0.0	0.2	3	1	0	1	0.0	0.1	0
1時間計	60	5	65	7.7	1.1	10	3	0	3	0.0	0.4	0
1:00-1:15	9	5	14	35.7	0.2	1	0	0	0	0.0	0.0	0
1:15-1:30	12	4	16	25.0	0.3	1	2	0	2	0.0	0.3	0
1:30-1:45	15	2	17	11.8	0.3	1	1	0	1	0.0	0.1	0
1:45-2:00	9	8	17	47.1	0.3	3	1	0	1	0.0	0.1	0
1時間計	45	19	64	29.7	1.1	6	4	0	4	0.0	0.5	0
2:00-2:15	16	3	19	15.8	0.3	0	2	0	2	0.0	0.3	0
2:15-2:30	5	9	14	64.3	0.2	2	1	1	2	50.0	0.3	0
2:30-2:45	7	5	12	41.7	0.2	1	0	0	0	0.0	0.0	0
2:45-3:00	12	8	20	40.0	0.3	1	1	0	1	0.0	0.1	0
1時間計	40	25	65	38.5	1.1	4	4	1	5	20.0	0.7	0
3:00-3:15	6	3	9	33.3	0.2	0	2	0	2	0.0	0.3	0
3:15-3:30	9	6	15	40.0	0.3	0	0	0	0	0.0	0.0	0
3:30-3:45	13	4	17	23.5	0.3	0	0	0	0	0.0	0.0	0
3:45-4:00	10	3	13	23.1	0.2	0	0	0	0	0.0	0.0	0
1時間計	38	16	54	29.6	0.9	0	2	0	2	0.0	0.3	0
4:00-4:15	8	5	13	38.5	0.2	1	0	0	0	0.0	0.0	0
4:15-4:30	13	4	17	23.5	0.3	1	0	0	0	0.0	0.0	0
4:30-4:45	18	3	21	14.3	0.4	2	2	0	2	0.0	0.3	0
4:45-5:00	14	8	22	36.4	0.4	2	0	0	0	0.0	0.0	0
1時間計	53	20	73	27.4	1.2	6	2	0	2	0.0	0.3	0
5:00-5:15	24	16	40	40.0	0.7	2	3	0	3	0.0	0.4	0
5:15-5:30	31	6	37	16.2	0.6	1	2	0	2	0.0	0.3	0
5:30-5:45	44	7	51	13.7	0.9	3	11	0	11	0.0	1.4	0
5:45-6:00	54	7	61	11.5	1.0	7	2	0	2	0.0	0.3	0
1時間計	153	36	189	19.0	3.2	13	18	0	18	0.0	2.4	0

方向別自動車交通量調査表

調査地点 : 地域社会5

調査年月日 : 令和元年10月13日(日) 天候:曇りのち雨



方向 時間帯	3						4					
	種別 小型車 (台)	大型車 (台)	合計 (台)	大型車 混入率 (%)	時間 係数 (%)	二輪車 (台)	小型車 (台)	大型車 (台)	合計 (台)	大型車 混入率 (%)	時間 係数 (%)	二輪車 (台)
6:00-6:15	45	3	48	6.3	0.8	3	4	0	4	0.0	0.5	0
6:15-6:30	79	14	93	15.1	1.6	9	3	0	3	0.0	0.4	0
6:30-6:45	80	12	92	13.0	1.5	8	14	0	14	0.0	1.8	2
6:45-7:00	75	5	80	6.3	1.3	8	6	1	7	14.3	0.9	0
1時間計	279	34	313	10.9	5.3	28	27	1	28	3.6	3.7	2
7:00-7:15	72	23	95	24.2	1.6	3	4	2	6	33.3	0.8	0
7:15-7:30	81	18	99	18.2	1.7	3	15	3	18	16.7	2.4	0
7:30-7:45	73	23	96	24.0	1.6	9	22	0	22	0.0	2.9	0
7:45-8:00	73	24	97	24.7	1.6	10	9	1	10	10.0	1.3	0
1時間計	299	88	387	22.7	6.5	25	50	6	56	10.7	7.4	0
8:00-8:15	83	13	96	13.5	1.6	18	17	2	19	10.5	2.5	0
8:15-8:30	103	17	120	14.2	2.0	20	15	3	18	16.7	2.4	0
8:30-8:45	110	22	132	16.7	2.2	8	11	1	12	8.3	1.6	0
8:45-9:00	74	15	89	16.9	1.5	8	7	1	8	12.5	1.1	0
1時間計	370	67	437	15.3	7.3	54	50	7	57	12.3	7.5	0
9:00-9:15	98	21	119	17.6	2.0	7	9	0	9	0.0	1.2	3
9:15-9:30	73	13	86	15.1	1.4	5	9	1	10	10.0	1.3	1
9:30-9:45	80	10	90	11.1	1.5	2	7	1	8	12.5	1.1	0
9:45-10:00	72	12	84	14.3	1.4	2	5	0	5	0.0	0.7	0
1時間計	323	56	379	14.8	6.4	16	30	2	32	6.3	4.2	4
10:00-10:15	62	10	72	13.9	1.2	7	9	2	11	18.2	1.4	2
10:15-10:30	81	10	91	11.0	1.5	1	8	0	8	0.0	1.1	0
10:30-10:45	68	5	73	6.8	1.2	1	6	0	6	0.0	0.8	0
10:45-11:00	85	7	92	7.6	1.5	1	13	0	13	0.0	1.7	0
1時間計	296	32	328	9.8	5.5	10	36	2	38	5.3	5.0	2
11:00-11:15	95	8	103	7.8	1.7	2	10	3	13	23.1	1.7	0
11:15-11:30	71	4	75	5.3	1.3	1	12	1	13	7.7	1.7	1
11:30-11:45	96	13	109	11.9	1.8	2	28	2	30	6.7	3.9	1
11:45-12:00	78	5	83	6.0	1.4	4	9	0	9	0.0	1.2	1
1時間計	340	30	370	8.1	6.2	9	59	6	65	9.2	8.5	3
12:00-12:15	84	5	89	5.6	1.5	4	15	0	15	0.0	2.0	0
12:15-12:30	103	11	114	9.6	1.9	2	13	0	13	0.0	1.7	0
12:30-12:45	97	6	103	5.8	1.7	6	15	1	16	6.3	2.1	0
12:45-13:00	87	8	95	8.4	1.6	3	10	1	11	9.1	1.4	0
1時間計	271	30	401	7.5	6.7	15	53	2	55	3.6	7.2	0
13:00-13:15	108	17	125	13.6	2.1	2	7	0	7	0.0	0.9	0
13:15-13:30	82	9	91	9.9	1.5	3	7	2	9	22.2	1.2	0
13:30-13:45	84	9	93	9.7	1.6	0	21	2	23	8.7	3.0	2
13:45-14:00	71	10	81	12.3	1.4	0	9	2	11	18.2	1.4	0
1時間計	345	45	390	11.5	6.5	5	44	6	50	12.0	6.6	2

方向別自動車交通量調査表

調査地点 : 地域社会5

調査年月日 : 令和元年10月13日(日) 天候:曇りのち雨

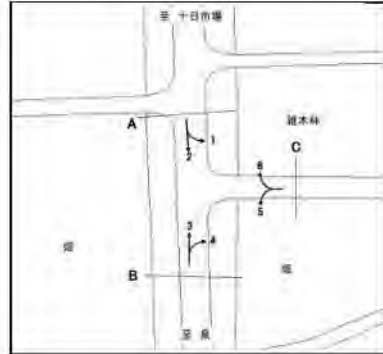

方向 種別 時間帯	3						4					
	小型車 (台)	大型車 (台)	合計 (台)	大型車 混入率 (%)	時 間 係 数 (%)	二輪車 (台)	小型車 (台)	大型車 (台)	合計 (台)	大型車 混入率 (%)	時 間 係 数 (%)	二輪車 (台)
14:00-14:15	63	9	72	12.5	1.2	7	12	1	13	7.7	1.7	0
14:15-14:30	52	3	55	5.5	0.9	3	12	1	13	7.7	1.7	2
14:30-14:45	80	7	87	8.0	1.5	5	7	1	8	12.5	1.1	0
14:45-15:00	59	10	69	14.5	1.2	1	9	0	9	0.0	1.2	1
1時間計	254	29	283	10.2	4.8	16	40	3	43	7.0	5.7	3
15:00-15:15	90	17	107	15.9	1.8	1	15	0	15	0.0	2.0	0
15:15-15:30	60	5	65	7.7	1.1	2	22	0	22	0.0	2.9	1
15:30-15:45	72	7	79	8.9	1.3	1	12	0	12	0.0	1.6	1
15:45-16:00	68	5	73	6.8	1.2	1	13	2	15	13.3	2.0	0
1時間計	290	34	324	10.5	5.4	5	62	2	64	3.1	8.4	2
16:00-16:15	76	8	84	9.5	1.4	4	15	0	15	0.0	2.0	0
16:15-16:30	54	9	63	14.3	1.1	0	9	0	9	0.0	1.2	0
16:30-16:45	71	5	76	6.6	1.3	4	8	0	8	0.0	1.1	0
16:45-17:00	70	8	78	10.3	1.3	4	14	3	17	17.6	2.2	0
1時間計	271	30	301	10.0	5.1	12	46	3	49	6.1	6.4	0
17:00-17:15	106	7	113	6.2	1.9	2	8	1	9	11.1	1.2	0
17:15-17:30	80	9	89	10.1	1.5	3	14	0	14	0.0	1.8	2
17:30-17:45	93	4	97	4.1	1.6	2	16	0	16	0.0	2.1	1
17:45-18:00	73	2	75	2.7	1.3	4	12	1	13	7.7	1.7	0
1時間計	352	22	374	5.9	6.3	11	50	2	52	3.8	6.8	3
18:00-18:15	72	3	75	4.0	1.3	5	5	0	5	0.0	0.7	1
18:15-18:30	78	6	84	7.1	1.4	5	14	0	14	0.0	1.8	0
18:30-18:45	56	6	62	9.7	1.0	3	7	0	7	0.0	0.9	0
18:45-19:00	56	2	58	3.4	1.0	6	7	0	7	0.0	0.9	0
1時間計	262	17	279	6.1	4.7	19	33	0	33	0.0	4.3	1
19:00-19:15	55	2	57	3.5	1.0	3	7	0	7	0.0	0.9	0
19:15-19:30	79	4	83	4.8	1.4	4	11	0	11	0.0	1.4	1
19:30-19:45	55	2	57	3.5	1.0	1	5	0	5	0.0	0.7	1
19:45-20:00	57	8	65	12.3	1.1	1	8	0	8	0.0	1.1	0
1時間計	246	16	262	6.1	4.4	9	31	0	31	0.0	4.1	2
20:00-20:15	39	4	43	9.3	0.7	5	1	0	1	0.0	0.1	0
20:15-20:30	50	5	55	9.1	0.9	4	5	1	6	16.7	0.8	1
20:30-20:45	36	2	38	5.3	0.6	2	6	0	6	0.0	0.8	0
20:45-21:00	42	6	48	12.5	0.8	4	5	0	5	0.0	0.7	1
1時間計	167	17	184	9.2	3.1	15	17	1	18	5.6	2.4	2
21:00-21:15	33	3	36	8.3	0.6	0	5	0	5	0.0	0.7	0
21:15-21:30	36	7	43	16.3	0.7	2	13	0	13	0.0	1.7	0
21:30-21:45	31	0	31	0.0	0.5	1	4	0	4	0.0	0.5	0
21:45-22:00	27	0	27	0.0	0.5	4	0	0	0	0.0	0.0	0
1時間計	127	10	137	7.3	2.3	7	22	0	22	0.0	2.9	0
昼12時間計	3773	480	4253	11.3	71.4	197	553	41	594	6.9	78.1	20
夜12時間計	1468	235	1703	13.8	28.6	125	163	4	167	2.4	21.9	7
全時間合計	5241	715	5956	12.0	100.0	322	716	45	761	5.9	100.0	27
昼 夜 率	1.39	1.49	1.40	-	-	1.63	1.29	1.10	1.28	-	-	1.35

方向別自動車交通量調査表

調査地点 : 地域社会5

調査年月日 : 令和元年10月13日(日) 天候:曇りのち雨

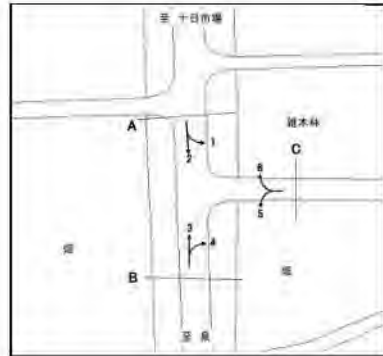

方向 種別 時間帯							B 合計 (3+ 4)					
	小型車 (台)	大型車 (台)	合計 (台)	大型車 混入率 (%)	時 間 係 数 (%)	二輪車 (台)	小型車 (台)	大型車 (台)	合計 (台)	大型車 混入率 (%)	時 間 係 数 (%)	二輪車 (台)
22:00-22:15							53	3	56	5.4	0.8	2
22:15-22:30							39	3	42	7.1	0.6	6
22:30-22:45							45	6	51	11.8	0.8	5
22:45-23:00							38	11	49	22.4	0.7	4
1 時間計							175	23	198	11.6	2.9	17
23:00-23:15							32	5	37	13.5	0.6	3
23:15-23:30							31	5	36	13.9	0.5	4
23:30-23:45							41	4	45	8.9	0.7	2
23:45-24:00							14	1	15	6.7	0.2	2
1 時間計							118	15	133	11.3	2.0	11
0:00- 0:15							23	3	26	11.5	0.4	3
0:15- 0:30							12	1	13	7.7	0.2	2
0:30- 0:45							14	1	15	6.7	0.2	2
0:45- 1:00							14	0	14	0.0	0.2	3
1 時間計							63	5	68	7.4	1.0	10
1:00- 1:15							9	5	14	35.7	0.2	1
1:15- 1:30							14	4	18	22.2	0.3	1
1:30- 1:45							16	2	18	11.1	0.3	1
1:45- 2:00							10	8	18	44.4	0.3	3
1 時間計							49	19	68	27.9	1.0	6
2:00- 2:15							18	3	21	14.3	0.3	0
2:15- 2:30							6	10	16	62.5	0.2	2
2:30- 2:45							7	5	12	41.7	0.2	1
2:45- 3:00							13	8	21	38.1	0.3	1
1 時間計							44	26	70	37.1	1.0	4
3:00- 3:15							8	3	11	27.3	0.2	0
3:15- 3:30							9	6	15	40.0	0.2	0
3:30- 3:45							13	4	17	23.5	0.3	0
3:45- 4:00							10	3	13	23.1	0.2	0
1 時間計							40	16	56	28.6	0.8	0
4:00- 4:15							8	5	13	38.5	0.2	1
4:15- 4:30							13	4	17	23.5	0.3	1
4:30- 4:45							20	3	23	13.0	0.3	2
4:45- 5:00							14	8	22	36.4	0.3	2
1 時間計							55	20	75	26.7	1.1	6
5:00- 5:15							27	16	43	37.2	0.6	2
5:15- 5:30							33	6	39	15.4	0.6	1
5:30- 5:45							55	7	62	11.3	0.9	3
5:45- 6:00							56	7	63	11.1	0.9	7
1 時間計							171	36	207	17.4	3.1	13

方向別自動車交通量調査表

調査地点：地域社会5

調査年月日：令和元年10月13日(日) 天候：曇りのち雨



時間帯	方向 種別						B 合計 (3+4)					
		小型車 (台)	大型車 (台)	合計 (台)	大型車 混入率 (%)	時間 係数 (%)	二輪車 (台)	小型車 (台)	大型車 (台)	合計 (台)	大型車 混入率 (%)	時間 係数 (%)
6:00-6:15							49	3	52	5.8	0.8	3
6:15-6:30							82	14	96	14.6	1.4	9
6:30-6:45							94	12	106	11.3	1.6	10
6:45-7:00							81	6	87	6.9	1.3	8
1時間計							306	35	341	10.3	5.1	30
7:00-7:15							76	25	101	24.8	1.5	3
7:15-7:30							96	21	117	17.9	1.7	3
7:30-7:45							95	23	118	19.5	1.8	9
7:45-8:00							82	25	107	23.4	1.6	10
1時間計							349	94	443	21.2	6.6	25
8:00-8:15							100	15	115	13.0	1.7	18
8:15-8:30							118	20	138	14.5	2.1	20
8:30-8:45							121	23	144	16.0	2.1	8
8:45-9:00							81	16	97	16.5	1.4	8
1時間計							420	74	494	15.0	7.4	54
9:00-9:15							107	21	128	16.4	1.9	10
9:15-9:30							82	14	96	14.6	1.4	6
9:30-9:45							87	11	98	11.2	1.5	2
9:45-10:00							77	12	89	13.5	1.3	2
1時間計							353	58	411	14.1	6.1	20
10:00-10:15							71	12	83	14.5	1.2	9
10:15-10:30							89	10	99	10.1	1.5	1
10:30-10:45							74	5	79	6.3	1.2	1
10:45-11:00							98	7	105	6.7	1.6	1
1時間計							332	34	366	9.3	5.4	12
11:00-11:15							105	11	116	9.5	1.7	2
11:15-11:30							83	5	88	5.7	1.3	2
11:30-11:45							124	15	139	10.8	2.1	3
11:45-12:00							87	5	92	5.4	1.4	5
1時間計							399	36	435	8.3	6.5	12
12:00-12:15							99	5	104	4.8	1.5	4
12:15-12:30							116	11	127	8.7	1.9	2
12:30-12:45							112	7	119	5.9	1.8	6
12:45-13:00							97	9	106	8.5	1.6	3
1時間計							424	32	456	7.0	6.8	15
13:00-13:15							115	17	132	12.9	2.0	2
13:15-13:30							89	11	100	11.0	1.5	3
13:30-13:45							105	11	116	9.5	1.7	2
13:45-14:00							80	12	92	13.0	1.4	0
1時間計							389	51	440	11.6	6.6	7

方向別自動車交通量調査表

調査地点：地域社会5

調査年月日：令和元年10月13日(日) 天候：曇りのち雨

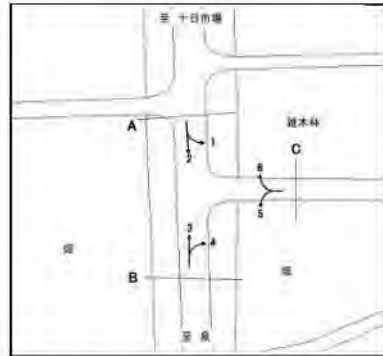

方向 種別 時間帯							B 合計 (3+4)					
	小型車 (台)	大型車 (台)	合計 (台)	大型車 混入率 (%)	時間 係数 (%)	二輪車 (台)	小型車 (台)	大型車 (台)	合計 (台)	大型車 混入率 (%)	時間 係数 (%)	二輪車 (台)
14:00-14:15							75	10	85	11.8	1.3	7
14:15-14:30							64	4	68	5.9	1.0	5
14:30-14:45							87	8	95	8.4	1.4	5
14:45-15:00							68	10	78	12.8	1.2	2
1時間計							294	32	326	9.8	4.9	19
15:00-15:15							105	17	122	13.9	1.8	1
15:15-15:30							82	5	87	5.7	1.3	3
15:30-15:45							84	7	91	7.7	1.4	2
15:45-16:00							81	7	88	8.0	1.3	1
1時間計							352	36	388	9.3	5.8	7
16:00-16:15							91	8	99	8.1	1.5	4
16:15-16:30							63	9	72	12.5	1.1	0
16:30-16:45							79	5	84	6.0	1.3	4
16:45-17:00							84	11	95	11.6	1.4	4
1時間計							317	33	350	9.4	5.2	12
17:00-17:15							114	8	122	6.6	1.8	2
17:15-17:30							94	9	103	8.7	1.5	5
17:30-17:45							109	4	113	3.5	1.7	3
17:45-18:00							85	3	88	3.4	1.3	4
1時間計							402	24	426	5.6	6.3	14
18:00-18:15							77	3	80	3.8	1.2	6
18:15-18:30							92	6	98	6.1	1.5	5
18:30-18:45							63	6	69	8.7	1.0	3
18:45-19:00							63	2	65	3.1	1.0	6
1時間計							295	17	312	5.4	4.6	20
19:00-19:15							62	2	64	3.1	1.0	3
19:15-19:30							90	4	94	4.3	1.4	5
19:30-19:45							60	2	62	3.2	0.9	2
19:45-20:00							65	8	73	11.0	1.1	1
1時間計							277	16	293	5.5	4.4	11
20:00-20:15							40	4	44	9.1	0.7	5
20:15-20:30							55	6	61	9.8	0.9	5
20:30-20:45							42	2	44	4.5	0.7	2
20:45-21:00							47	6	53	11.3	0.8	5
1時間計							184	18	202	8.9	3.0	17
21:00-21:15							38	3	41	7.3	0.6	0
21:15-21:30							49	7	56	12.5	0.8	2
21:30-21:45							35	0	35	0.0	0.5	1
21:45-22:00							27	0	27	0.0	0.4	4
1時間計							149	10	159	6.3	2.4	7
昼12時間計							4326	521	4847	10.7	72.2	217
夜12時間計							1631	239	1870	12.8	27.8	132
全時間合計							5957	760	6717	11.3	100.0	349
昼夜率							1.38	1.46	1.39	-	-	1.61

方向別自動車交通量調査表

調査地点 : 地域社会5

調査年月日 : 令和元年10月13日(日) 天候:曇りのち雨

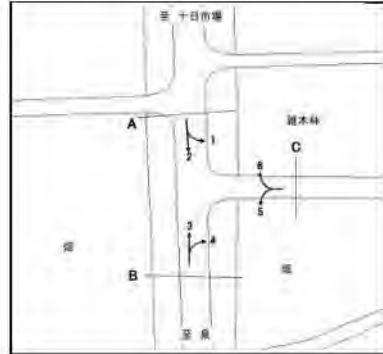

方向 種別 時間帯	5						6					
	小型車 (台)	大型車 (台)	合計 (台)	大型車 混入率 (%)	時間 係数 (%)	二輪車 (台)	小型車 (台)	大型車 (台)	合計 (台)	大型車 混入率 (%)	時間 係数 (%)	二輪車 (台)
22:00-22:15	5	0	5	0.0	0.6	2	11	0	11	0.0	0.6	2
22:15-22:30	4	0	4	0.0	0.5	0	7	0	7	0.0	0.4	0
22:30-22:45	1	0	1	0.0	0.1	0	16	0	16	0.0	0.9	0
22:45-23:00	3	0	3	0.0	0.3	0	8	1	9	11.1	0.5	1
1時間計	13	0	13	0.0	1.5	2	42	1	43	2.3	2.3	3
23:00-23:15	4	0	4	0.0	0.5	1	3	0	3	0.0	0.2	1
23:15-23:30	1	0	1	0.0	0.1	0	2	0	2	0.0	0.1	1
23:30-23:45	1	0	1	0.0	0.1	1	3	0	3	0.0	0.2	0
23:45-24:00	2	0	2	0.0	0.2	0	2	0	2	0.0	0.1	0
1時間計	8	0	8	0.0	0.9	2	10	0	10	0.0	0.5	2
0:00-0:15	1	0	1	0.0	0.1	0	2	0	2	0.0	0.1	0
0:15-0:30	1	0	1	0.0	0.1	0	2	0	2	0.0	0.1	0
0:30-0:45	4	0	4	0.0	0.5	0	4	1	5	20.0	0.3	1
0:45-1:00	1	0	1	0.0	0.1	0	4	1	5	20.0	0.3	1
1時間計	7	0	7	0.0	0.8	0	12	2	14	14.3	0.7	2
1:00-1:15	2	0	2	0.0	0.2	0	2	0	2	0.0	0.1	0
1:15-1:30	4	1	5	20.0	0.6	0	4	0	4	0.0	0.2	0
1:30-1:45	1	0	1	0.0	0.1	0	1	0	1	0.0	0.1	0
1:45-2:00	0	0	0	0.0	0.0	0	1	1	2	50.0	0.1	0
1時間計	7	1	8	12.5	0.9	0	8	1	9	11.1	0.5	0
2:00-2:15	0	0	0	0.0	0.0	0	2	0	2	0.0	0.1	0
2:15-2:30	0	0	0	0.0	0.0	0	0	1	1	100.0	0.1	0
2:30-2:45	0	0	0	0.0	0.0	0	2	0	2	0.0	0.1	1
2:45-3:00	1	0	1	0.0	0.1	0	1	0	1	0.0	0.1	0
1時間計	1	0	1	0.0	0.1	0	5	1	6	16.7	0.3	1
3:00-3:15	0	0	0	0.0	0.0	0	3	1	4	25.0	0.2	0
3:15-3:30	0	1	1	100.0	0.1	0	0	1	1	100.0	0.1	0
3:30-3:45	2	0	2	0.0	0.2	0	3	1	4	25.0	0.2	1
3:45-4:00	1	0	1	0.0	0.1	0	2	0	2	0.0	0.1	0
1時間計	3	1	4	25.0	0.5	0	8	3	11	27.3	0.6	1
4:00-4:15	0	0	0	0.0	0.0	0	1	0	1	0.0	0.1	1
4:15-4:30	0	0	0	0.0	0.0	0	2	2	4	50.0	0.2	0
4:30-4:45	0	0	0	0.0	0.0	0	2	0	2	0.0	0.1	0
4:45-5:00	2	0	2	0.0	0.2	0	3	0	3	0.0	0.2	0
1時間計	2	0	2	0.0	0.2	0	8	2	10	20.0	0.5	1
5:00-5:15	0	0	0	0.0	0.0	0	3	0	3	0.0	0.2	1
5:15-5:30	1	0	1	0.0	0.1	1	4	0	4	0.0	0.2	0
5:30-5:45	3	1	4	25.0	0.5	0	8	0	8	0.0	0.4	1
5:45-6:00	8	0	8	0.0	0.9	1	9	1	10	10.0	0.5	0
1時間計	12	1	13	7.7	1.5	2	24	1	25	4.0	1.3	2

方向別自動車交通量調査表

調査地点 : 地域社会5

調査年月日 : 令和元年10月13日(日) 天候:曇りのち雨

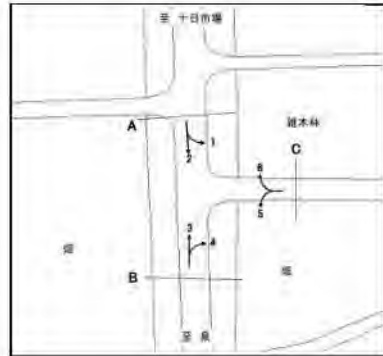

方向 種別 時間帯	5						6					
	小型車 (台)	大型車 (台)	合計 (台)	大型車 混入率 (%)	時間 係数 (%)	二輪車 (台)	小型車 (台)	大型車 (台)	合計 (台)	大型車 混入率 (%)	時間 係数 (%)	二輪車 (台)
6:00-6:15	2	0	2	0.0	0.2	1	17	0	17	0.0	0.9	3
6:15-6:30	3	0	3	0.0	0.3	0	16	0	16	0.0	0.9	1
6:30-6:45	4	0	4	0.0	0.5	0	19	1	20	5.0	1.1	4
6:45-7:00	13	1	14	7.1	1.6	1	17	0	17	0.0	0.9	0
1時間計	22	1	23	4.3	2.7	2	69	1	70	1.4	3.7	8
7:00-7:15	12	1	13	7.7	1.5	0	20	2	22	9.1	1.2	3
7:15-7:30	15	3	18	16.7	2.1	1	17	6	23	26.1	1.2	1
7:30-7:45	13	1	14	7.1	1.6	1	21	3	24	12.5	1.3	2
7:45-8:00	15	1	16	6.3	1.8	2	24	4	28	14.3	1.5	1
1時間計	55	6	61	9.8	7.1	4	82	15	97	15.5	5.2	7
8:00-8:15	13	0	13	0.0	1.5	0	29	5	34	14.7	1.8	1
8:15-8:30	20	0	20	0.0	2.3	0	34	0	34	0.0	1.8	1
8:30-8:45	12	1	13	7.7	1.5	1	28	4	32	12.5	1.7	3
8:45-9:00	9	1	10	10.0	1.2	1	29	4	33	12.1	1.8	0
1時間計	54	2	56	3.6	6.5	2	120	13	133	9.8	7.1	5
9:00-9:15	13	0	13	0.0	1.5	1	43	2	45	4.4	2.4	1
9:15-9:30	14	1	15	6.7	1.7	1	38	0	38	0.0	2.0	1
9:30-9:45	16	0	16	0.0	1.8	0	39	2	41	4.9	2.2	1
9:45-10:00	20	0	20	0.0	2.3	0	30	2	32	6.3	1.7	1
1時間計	63	1	64	1.6	7.4	2	150	6	156	3.8	8.3	4
10:00-10:15	19	1	20	5.0	2.3	2	24	2	26	7.7	1.4	0
10:15-10:30	9	3	12	25.0	1.4	0	39	0	39	0.0	2.1	3
10:30-10:45	16	1	17	5.9	2.0	0	38	0	38	0.0	2.0	1
10:45-11:00	10	0	10	0.0	1.2	0	37	2	39	5.1	2.1	0
1時間計	54	5	59	8.5	6.8	2	138	4	142	2.8	7.6	4
11:00-11:15	30	2	32	6.3	3.7	0	34	0	34	0.0	1.8	0
11:15-11:30	49	2	51	3.9	5.9	0	42	0	42	0.0	2.2	0
11:30-11:45	7	4	11	36.4	1.3	1	32	2	34	5.9	1.8	0
11:45-12:00	13	2	15	13.3	1.7	1	40	0	40	0.0	2.1	2
1時間計	99	10	109	9.2	12.6	2	148	2	150	1.3	8.0	2
12:00-12:15	14	3	17	17.6	2.0	0	38	0	38	0.0	2.0	1
12:15-12:30	17	5	22	22.7	2.5	0	24	0	24	0.0	1.3	2
12:30-12:45	12	2	14	14.3	1.6	0	39	1	40	2.5	2.1	1
12:45-13:00	9	0	9	0.0	1.0	0	31	1	32	3.1	1.7	0
1時間計	52	10	62	16.1	7.2	0	132	2	134	1.5	7.1	4
13:00-13:15	11	0	11	0.0	1.3	1	33	5	38	13.2	2.0	1
13:15-13:30	10	2	12	16.7	1.4	0	25	1	26	3.8	1.4	1
13:30-13:45	13	2	15	13.3	1.7	0	32	1	33	3.0	1.8	0
13:45-14:00	12	3	15	20.0	1.7	0	35	0	35	0.0	1.9	1
1時間計	46	7	53	13.2	6.1	1	125	7	132	5.3	7.0	3

方向別自動車交通量調査表

調査地点 : 地域社会5

調査年月日 : 令和元年10月13日(日) 天候:曇りのち雨

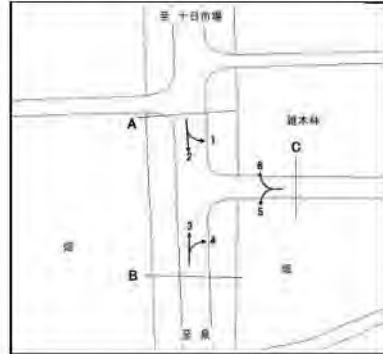

方向 種別 時間帯	5						6					
	小型車 (台)	大型車 (台)	合計 (台)	大型車 混入率 (%)	時間 係数 (%)	二輪車 (台)	小型車 (台)	大型車 (台)	合計 (台)	大型車 混入率 (%)	時間 係数 (%)	二輪車 (台)
14:00-14:15	21	2	23	8.7	2.7	1	26	3	29	10.3	1.5	0
14:15-14:30	7	2	9	22.2	1.0	0	30	2	32	6.3	1.7	2
14:30-14:45	15	0	15	0.0	1.7	0	26	2	28	7.1	1.5	1
14:45-15:00	17	0	17	0.0	2.0	0	15	1	16	6.3	0.9	0
1時間計	60	4	64	6.3	7.4	1	97	8	105	7.6	5.6	3
15:00-15:15	5	0	5	0.0	0.6	0	35	2	37	5.4	2.0	0
15:15-15:30	15	4	19	21.1	2.2	0	29	0	29	0.0	1.5	1
15:30-15:45	8	1	9	11.1	1.0	1	26	1	27	3.7	1.4	0
15:45-16:00	16	0	16	0.0	1.8	0	22	0	22	0.0	1.2	0
1時間計	44	5	49	10.2	5.7	1	112	3	115	2.6	6.1	1
16:00-16:15	7	1	8	12.5	0.9	1	40	2	42	4.8	2.2	1
16:15-16:30	23	5	28	17.9	3.2	0	39	0	39	0.0	2.1	0
16:30-16:45	14	1	15	6.7	1.7	0	30	0	30	0.0	1.6	0
16:45-17:00	10	1	11	9.1	1.3	1	28	0	28	0.0	1.5	1
1時間計	54	8	62	12.9	7.2	2	137	2	139	1.4	7.4	2
17:00-17:15	11	1	12	8.3	1.4	0	35	0	35	0.0	1.9	0
17:15-17:30	18	4	22	18.2	2.5	0	32	0	32	0.0	1.7	2
17:30-17:45	3	1	4	25.0	0.5	0	32	0	32	0.0	1.7	1
17:45-18:00	12	3	15	20.0	1.7	0	27	0	27	0.0	1.4	0
1時間計	44	9	53	17.0	6.1	0	126	0	126	0.0	6.7	3
18:00-18:15	15	0	15	0.0	1.7	2	33	0	33	0.0	1.8	0
18:15-18:30	8	0	8	0.0	0.9	1	28	0	28	0.0	1.5	1
18:30-18:45	9	4	13	30.8	1.5	0	36	1	37	2.7	2.0	0
18:45-19:00	10	1	11	9.1	1.3	0	28	0	28	0.0	1.5	1
1時間計	42	5	47	10.6	5.4	3	125	1	126	0.8	6.7	2
19:00-19:15	2	1	3	33.3	0.3	0	13	0	13	0.0	0.7	1
19:15-19:30	2	0	2	0.0	0.2	1	14	1	15	6.7	0.8	2
19:30-19:45	4	0	4	0.0	0.5	0	18	0	18	0.0	1.0	0
19:45-20:00	3	2	5	40.0	0.6	0	15	0	15	0.0	0.8	1
1時間計	11	3	14	21.4	1.6	1	60	1	61	1.6	3.2	4
20:00-20:15	7	1	8	12.5	0.9	0	8	0	8	0.0	0.4	0
20:15-20:30	5	0	5	0.0	0.6	0	14	0	14	0.0	0.7	0
20:30-20:45	1	0	1	0.0	0.1	0	2	0	2	0.0	0.1	0
20:45-21:00	4	0	4	0.0	0.5	0	8	0	8	0.0	0.4	0
1時間計	17	1	18	5.6	2.1	0	32	0	32	0.0	1.7	0
21:00-21:15	2	0	2	0.0	0.2	0	14	3	17	17.6	0.9	0
21:15-21:30	4	0	4	0.0	0.5	0	0	0	0	0.0	0.0	0
21:30-21:45	6	0	6	0.0	0.7	2	9	0	9	0.0	0.5	0
21:45-22:00	3	0	3	0.0	0.3	0	5	0	5	0.0	0.3	0
1時間計	15	0	15	0.0	1.7	2	28	3	31	9.7	1.7	0
昼12時間計	667	72	739	9.7	85.4	20	1492	63	1555	4.1	82.8	40
夜12時間計	118	8	126	6.3	14.6	11	306	16	322	5.0	17.2	24
全時間合計	785	80	865	9.2	100.0	31	1798	79	1877	4.2	100.0	64
昼夜率	1.18	1.11	1.17	-	-	1.55	1.21	1.25	1.21	-	-	1.60

方向別自動車交通量調査表

調査地点 : 地域社会5

調査年月日 : 令和元年10月13日(日) 天候:曇りのち雨

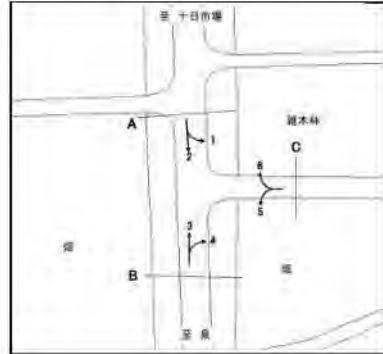

方向 種別 時間帯							C 合計 (5+ 6)					
	小型車 (台)	大型車 (台)	合計 (台)	大型車 混入率 (%)	時間 係数 (%)	二輪車 (台)	小型車 (台)	大型車 (台)	合計 (台)	大型車 混入率 (%)	時間 係数 (%)	二輪車 (台)
22:00-22:15							16	0	16	0.0	0.6	4
22:15-22:30							11	0	11	0.0	0.4	0
22:30-22:45							17	0	17	0.0	0.6	0
22:45-23:00							11	1	12	8.3	0.4	1
1時間計							55	1	56	1.8	2.0	5
23:00-23:15							7	0	7	0.0	0.3	2
23:15-23:30							3	0	3	0.0	0.1	1
23:30-23:45							4	0	4	0.0	0.1	1
23:45-24:00							4	0	4	0.0	0.1	0
1時間計							18	0	18	0.0	0.7	4
0:00- 0:15							3	0	3	0.0	0.1	0
0:15- 0:30							3	0	3	0.0	0.1	0
0:30- 0:45							8	1	9	11.1	0.3	1
0:45- 1:00							5	1	6	16.7	0.2	1
1時間計							19	2	21	9.5	0.8	2
1:00- 1:15							4	0	4	0.0	0.1	0
1:15- 1:30							8	1	9	11.1	0.3	0
1:30- 1:45							2	0	2	0.0	0.1	0
1:45- 2:00							1	1	2	50.0	0.1	0
1時間計							15	2	17	11.8	0.6	0
2:00- 2:15							2	0	2	0.0	0.1	0
2:15- 2:30							0	1	1	100.0	0.0	0
2:30- 2:45							2	0	2	0.0	0.1	1
2:45- 3:00							2	0	2	0.0	0.1	0
1時間計							6	1	7	14.3	0.3	1
3:00- 3:15							3	1	4	25.0	0.1	0
3:15- 3:30							0	2	2	100.0	0.1	0
3:30- 3:45							5	1	6	16.7	0.2	1
3:45- 4:00							3	0	3	0.0	0.1	0
1時間計							11	4	15	26.7	0.5	1
4:00- 4:15							1	0	1	0.0	0.0	1
4:15- 4:30							2	2	4	50.0	0.1	0
4:30- 4:45							2	0	2	0.0	0.1	0
4:45- 5:00							5	0	5	0.0	0.2	0
1時間計							10	2	12	16.7	0.4	1
5:00- 5:15							3	0	3	0.0	0.1	1
5:15- 5:30							5	0	5	0.0	0.2	1
5:30- 5:45							11	1	12	8.3	0.4	1
5:45- 6:00							17	1	18	5.6	0.7	1
1時間計							36	2	38	5.3	1.4	4

方向別自動車交通量調査表

調査地点：地域社会5

調査年月日：令和元年10月13日(日) 天候：曇りのち雨

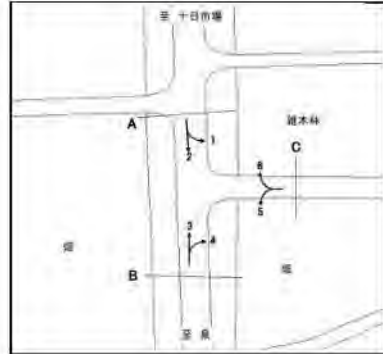

方向	種別						C 合計 (5+ 6)					
		小型車 (台)	大型車 (台)	合計 (台)	大型車 混入率 (%)	時係 数 (%)	二輪車 (台)	小型車 (台)	大型車 (台)	合計 (台)	大型車 混入率 (%)	時係 数 (%)
6:00-6:15							19	0	19	0.0	0.7	4
6:15-6:30							19	0	19	0.0	0.7	1
6:30-6:45							23	1	24	4.2	0.9	4
6:45-7:00							30	1	31	3.2	1.1	1
1時間計							91	2	93	2.2	3.4	10
7:00-7:15							32	3	35	8.6	1.3	3
7:15-7:30							32	9	41	22.0	1.5	2
7:30-7:45							34	4	38	10.5	1.4	3
7:45-8:00							39	5	44	11.4	1.6	3
1時間計							137	21	158	13.3	5.8	11
8:00-8:15							42	5	47	10.6	1.7	1
8:15-8:30							54	0	54	0.0	2.0	1
8:30-8:45							40	5	45	11.1	1.6	4
8:45-9:00							38	5	43	11.6	1.6	1
1時間計							174	15	189	7.9	6.9	7
9:00-9:15							56	2	58	3.4	2.1	2
9:15-9:30							52	1	53	1.9	1.9	2
9:30-9:45							55	2	57	3.5	2.1	1
9:45-10:00							50	2	52	3.8	1.9	1
1時間計							213	7	220	3.2	8.0	6
10:00-10:15							43	3	46	6.5	1.7	2
10:15-10:30							48	3	51	5.9	1.9	3
10:30-10:45							54	1	55	1.8	2.0	1
10:45-11:00							47	2	49	4.1	1.8	0
1時間計							192	9	201	4.5	7.3	6
11:00-11:15							64	2	66	3.0	2.4	0
11:15-11:30							91	2	93	2.2	3.4	0
11:30-11:45							39	6	45	13.3	1.6	1
11:45-12:00							53	2	55	3.6	2.0	3
1時間計							247	12	259	4.6	9.4	4
12:00-12:15							52	3	55	5.5	2.0	1
12:15-12:30							41	5	46	10.9	1.7	2
12:30-12:45							51	3	54	5.6	2.0	1
12:45-13:00							40	1	41	2.4	1.5	0
1時間計							184	12	196	6.1	7.1	4
13:00-13:15							44	5	49	10.2	1.8	2
13:15-13:30							35	3	38	7.9	1.4	1
13:30-13:45							45	3	48	6.3	1.8	0
13:45-14:00							47	3	50	6.0	1.8	1
1時間計							171	14	185	7.6	6.7	4

方向別自動車交通量調査表

調査地点：地域社会5

調査年月日：令和元年10月13日(日) 天候：曇りのち雨

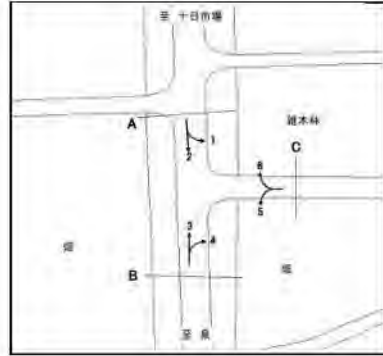

時間帯	方向 種別							C 合計 (5+ 6)					
		小型車 (台)	大型車 (台)	合計 (台)	大型車 混入率 (%)	時 間 係 数 (%)	二輪車 (台)	小型車 (台)	大型車 (台)	合計 (台)	大型車 混入率 (%)	時 間 係 数 (%)	二輪車 (台)
14:00-14:15							47	5	52	9.6	1.9	1	
14:15-14:30							37	4	41	9.8	1.5	2	
14:30-14:45							41	2	43	4.7	1.6	1	
14:45-15:00							32	1	33	3.0	1.2	0	
1時間計							157	12	169	7.1	6.2	4	
15:00-15:15							40	2	42	4.8	1.5	0	
15:15-15:30							44	4	48	8.3	1.8	1	
15:30-15:45							34	2	36	5.6	1.3	1	
15:45-16:00							38	0	38	0.0	1.4	0	
1時間計							156	8	164	4.9	6.0	2	
16:00-16:15							47	3	50	6.0	1.8	2	
16:15-16:30							62	5	67	7.5	2.4	0	
16:30-16:45							44	1	45	2.2	1.6	0	
16:45-17:00							38	1	39	2.6	1.4	2	
1時間計							191	10	201	5.0	7.3	4	
17:00-17:15							46	1	47	2.1	1.7	0	
17:15-17:30							50	4	54	7.4	2.0	2	
17:30-17:45							35	1	36	2.8	1.3	1	
17:45-18:00							39	3	42	7.1	1.5	0	
1時間計							170	9	179	5.0	6.5	3	
18:00-18:15							48	0	48	0.0	1.8	2	
18:15-18:30							36	0	36	0.0	1.3	2	
18:30-18:45							45	5	50	10.0	1.8	0	
18:45-19:00							38	1	39	2.6	1.4	1	
1時間計							167	6	173	3.5	6.3	5	
19:00-19:15							15	1	16	6.3	0.6	1	
19:15-19:30							16	1	17	5.9	0.6	3	
19:30-19:45							22	0	22	0.0	0.8	0	
19:45-20:00							18	2	20	10.0	0.7	1	
1時間計							71	4	75	5.3	2.7	5	
20:00-20:15							15	1	16	6.3	0.6	0	
20:15-20:30							19	0	19	0.0	0.7	0	
20:30-20:45							3	0	3	0.0	0.1	0	
20:45-21:00							12	0	12	0.0	0.4	0	
1時間計							49	1	50	2.0	1.8	0	
21:00-21:15							16	3	19	15.8	0.7	0	
21:15-21:30							4	0	4	0.0	0.1	0	
21:30-21:45							15	0	15	0.0	0.5	2	
21:45-22:00							8	0	8	0.0	0.3	0	
1時間計							43	3	46	6.5	1.7	2	
昼12時間計							2159	135	2294	5.9	83.7	60	
夜12時間計							424	24	448	5.4	16.3	35	
全時間合計							2583	159	2742	5.8	100.0	95	
昼 夜 率							1.20	1.18	1.20	-	-	1.58	

方向別自動車交通量調査表

調査地点：地域社会6 瀬谷中学校前

調査年月日：令和元年10月13日(日) 天候：曇りのち雨



方向 種別 時間帯	1						2					
	小型車 (台)	大型車 (台)	合計 (台)	大型車 混入率 (%)	時間 係数 (%)	二輪車 (台)	小型車 (台)	大型車 (台)	合計 (台)	大型車 混入率 (%)	時間 係数 (%)	二輪車 (台)
22:00-22:15	12	0	12	0.0	0.8	1	39	1	40	2.5	0.8	3
22:15-22:30	8	1	9	11.1	0.6	0	48	6	54	11.1	1.1	9
22:30-22:45	9	0	9	0.0	0.6	1	39	2	41	4.9	0.8	3
22:45-23:00	7	2	9	22.2	0.6	1	26	3	29	10.3	0.6	0
1時間計	36	3	39	7.7	2.6	3	152	12	164	7.3	3.3	15
23:00-23:15	9	0	9	0.0	0.6	1	32	6	38	15.8	0.8	4
23:15-23:30	8	0	8	0.0	0.5	0	28	1	29	3.4	0.6	2
23:30-23:45	3	0	3	0.0	0.2	0	20	1	21	4.8	0.4	2
23:45-24:00	10	0	10	0.0	0.7	1	13	3	16	18.8	0.3	3
1時間計	30	0	30	0.0	2.0	2	93	11	104	10.6	2.1	11
0:00-0:15	7	0	7	0.0	0.5	2	12	1	13	7.7	0.3	0
0:15-0:30	3	0	3	0.0	0.2	0	15	3	18	16.7	0.4	2
0:30-0:45	0	2	2	100.0	0.1	0	16	7	23	30.4	0.5	1
0:45-1:00	5	0	5	0.0	0.3	0	12	1	13	7.7	0.3	1
1時間計	15	2	17	11.8	1.1	2	55	12	67	17.9	1.4	4
1:00-1:15	4	0	4	0.0	0.3	0	15	3	18	16.7	0.4	4
1:15-1:30	0	0	0	0.0	0.0	0	11	0	11	0.0	0.2	1
1:30-1:45	2	0	2	0.0	0.1	0	11	1	12	8.3	0.2	4
1:45-2:00	2	0	2	0.0	0.1	0	8	7	15	46.7	0.3	0
1時間計	8	0	8	0.0	0.5	0	45	11	56	19.6	1.1	9
2:00-2:15	2	0	2	0.0	0.1	1	7	1	8	12.5	0.2	1
2:15-2:30	1	0	1	0.0	0.1	0	12	1	13	7.7	0.3	3
2:30-2:45	2	0	2	0.0	0.1	0	8	2	10	20.0	0.2	1
2:45-3:00	1	0	1	0.0	0.1	0	8	1	9	11.1	0.2	1
1時間計	6	0	6	0.0	0.4	1	35	5	40	12.5	0.8	6
3:00-3:15	2	1	3	33.3	0.2	2	6	1	7	14.3	0.1	0
3:15-3:30	1	0	1	0.0	0.1	1	4	4	8	50.0	0.2	0
3:30-3:45	0	0	0	0.0	0.0	0	2	1	3	33.3	0.1	0
3:45-4:00	6	1	7	14.3	0.5	0	10	4	14	28.6	0.3	0
1時間計	9	2	11	18.2	0.7	3	22	10	32	31.3	0.6	0
4:00-4:15	2	1	3	33.3	0.2	1	14	1	15	6.7	0.3	0
4:15-4:30	3	1	4	25.0	0.3	1	9	0	9	0.0	0.2	1
4:30-4:45	2	0	2	0.0	0.1	0	18	5	23	21.7	0.5	3
4:45-5:00	4	0	4	0.0	0.3	0	10	2	12	16.7	0.2	0
1時間計	11	2	13	15.4	0.9	2	51	8	59	13.6	1.2	4
5:00-5:15	3	0	3	0.0	0.2	0	11	10	21	47.6	0.4	2
5:15-5:30	0	0	0	0.0	0.0	0	19	3	22	13.6	0.4	4
5:30-5:45	5	2	7	28.6	0.5	0	21	3	24	12.5	0.5	4
5:45-6:00	5	0	5	0.0	0.3	1	30	6	36	16.7	0.7	0
1時間計	13	2	15	13.3	1.0	1	81	22	103	21.4	2.1	10

方向別自動車交通量調査表

調査地点：地域社会6 瀬谷中学校前

調査年月日：令和元年10月13日(日) 天候：曇りのち雨



時間帯	1						2					
	小型車 (台)	大型車 (台)	合計 (台)	大型車 混入率 (%)	時間 係数 (%)	二輪車 (台)	小型車 (台)	大型車 (台)	合計 (台)	大型車 混入率 (%)	時間 係数 (%)	二輪車 (台)
6:00-6:15	7	3	10	30.0	0.7	0	34	4	38	10.5	0.8	1
6:15-6:30	7	0	7	0.0	0.5	0	39	3	42	7.1	0.8	6
6:30-6:45	8	0	8	0.0	0.5	1	46	10	56	17.9	1.1	6
6:45-7:00	9	3	12	25.0	0.8	1	42	7	49	14.3	1.0	5
1時間計	31	6	37	16.2	2.4	2	161	24	185	13.0	3.7	18
7:00-7:15	8	1	9	11.1	0.6	0	35	5	40	12.5	0.8	5
7:15-7:30	5	1	6	16.7	0.4	0	46	10	56	17.9	1.1	4
7:30-7:45	16	1	17	5.9	1.1	0	72	5	77	6.5	1.6	4
7:45-8:00	18	1	19	5.3	1.3	2	58	11	69	15.9	1.4	3
1時間計	47	4	51	7.8	3.4	2	211	31	242	12.8	4.9	16
8:00-8:15	20	3	23	13.0	1.5	0	51	15	66	22.7	1.3	5
8:15-8:30	22	2	24	8.3	1.6	0	62	10	72	13.9	1.5	2
8:30-8:45	23	2	25	8.0	1.6	0	60	9	69	13.0	1.4	6
8:45-9:00	15	4	19	21.1	1.3	0	61	6	67	9.0	1.4	4
1時間計	80	11	91	12.1	6.0	0	234	40	274	14.6	5.5	17
9:00-9:15	16	3	19	15.8	1.3	0	60	10	70	14.3	1.4	5
9:15-9:30	20	1	21	4.8	1.4	0	75	2	77	2.6	1.6	3
9:30-9:45	37	1	38	2.6	2.5	1	73	0	73	0.0	1.5	4
9:45-10:00	34	0	34	0.0	2.2	2	82	0	82	0.0	1.7	2
1時間計	107	5	112	4.5	7.4	3	290	12	302	4.0	6.1	14
10:00-10:15	32	2	34	5.9	2.2	0	80	5	85	5.9	1.7	2
10:15-10:30	18	1	19	5.3	1.3	1	65	3	68	4.4	1.4	0
10:30-10:45	17	0	17	0.0	1.1	4	53	7	60	11.7	1.2	1
10:45-11:00	16	3	19	15.8	1.3	1	90	8	98	8.2	2.0	5
1時間計	83	6	89	6.7	5.9	6	288	23	311	7.4	6.3	8
11:00-11:15	25	2	27	7.4	1.8	0	63	9	72	12.5	1.5	1
11:15-11:30	21	1	22	4.5	1.4	0	92	3	95	3.2	1.9	3
11:30-11:45	24	1	25	4.0	1.6	1	82	6	88	6.8	1.8	1
11:45-12:00	30	1	31	3.2	2.0	0	82	8	90	8.9	1.8	3
1時間計	100	5	105	4.8	6.9	1	319	26	345	7.5	7.0	8
12:00-12:15	24	2	26	7.7	1.7	0	63	15	78	19.2	1.6	1
12:15-12:30	19	1	20	5.0	1.3	1	84	5	89	5.6	1.8	3
12:30-12:45	31	0	31	0.0	2.0	0	68	6	74	8.1	1.5	3
12:45-13:00	21	1	22	4.5	1.4	0	66	6	72	8.3	1.5	1
1時間計	95	4	99	4.0	6.5	1	281	32	313	10.2	6.3	8
13:00-13:15	27	1	28	3.6	1.8	0	77	5	82	6.1	1.7	2
13:15-13:30	25	1	26	3.8	1.7	3	46	6	52	11.5	1.0	2
13:30-13:45	31	0	31	0.0	2.0	0	71	6	77	7.8	1.6	0
13:45-14:00	25	0	25	0.0	1.6	2	67	4	71	5.6	1.4	1
1時間計	108	2	110	1.8	7.2	5	261	21	282	7.4	5.7	5

方向別自動車交通量調査表

調査地点 : 地域社会6 瀬谷中学校前

調査年月日 : 令和元年10月13日(日) 天候:曇りのち雨



時間帯	1						2					
	小型車 (台)	大型車 (台)	合計 (台)	大型車 混入率 (%)	時間 係数 (%)	二輪車 (台)	小型車 (台)	大型車 (台)	合計 (台)	大型車 混入率 (%)	時間 係数 (%)	二輪車 (台)
14:00-14:15	26	1	27	3.7	1.8	0	63	6	69	8.7	1.4	1
14:15-14:30	22	2	24	8.3	1.6	0	53	1	54	1.9	1.1	3
14:30-14:45	30	0	30	0.0	2.0	0	59	6	65	9.2	1.3	4
14:45-15:00	23	0	23	0.0	1.5	0	87	3	90	3.3	1.8	0
1時間計	101	3	104	2.9	6.8	0	262	16	278	5.8	5.6	8
15:00-15:15	14	2	16	12.5	1.1	2	63	5	68	7.4	1.4	0
15:15-15:30	12	1	13	7.7	0.9	0	58	1	59	1.7	1.2	0
15:30-15:45	42	0	42	0.0	2.8	0	78	10	88	11.4	1.8	1
15:45-16:00	27	1	28	3.6	1.8	0	76	4	80	5.0	1.6	1
1時間計	95	4	99	4.0	6.5	2	275	20	295	6.8	5.9	2
16:00-16:15	29	0	29	0.0	1.9	0	85	1	86	1.2	1.7	1
16:15-16:30	24	2	26	7.7	1.7	1	59	3	62	4.8	1.3	0
16:30-16:45	15	2	17	11.8	1.1	1	70	4	74	5.4	1.5	3
16:45-17:00	35	0	35	0.0	2.3	1	70	3	73	4.1	1.5	1
1時間計	103	4	107	3.7	7.0	3	284	11	295	3.7	5.9	5
17:00-17:15	37	0	37	0.0	2.4	1	81	5	86	5.8	1.7	6
17:15-17:30	27	0	27	0.0	1.8	0	71	5	76	6.6	1.5	5
17:30-17:45	21	1	22	4.5	1.4	0	79	6	85	7.1	1.7	5
17:45-18:00	21	2	23	8.7	1.5	0	63	3	66	4.5	1.3	5
1時間計	106	3	109	2.8	7.2	1	294	19	313	6.1	6.3	21
18:00-18:15	26	0	26	0.0	1.7	0	78	1	79	1.3	1.6	0
18:15-18:30	21	1	22	4.5	1.4	1	68	2	70	2.9	1.4	6
18:30-18:45	24	2	26	7.7	1.7	2	68	1	69	1.4	1.4	2
18:45-19:00	22	1	23	4.3	1.5	0	68	1	69	1.4	1.4	7
1時間計	93	4	97	4.1	6.4	3	282	5	287	1.7	5.8	15
19:00-19:15	14	0	14	0.0	0.9	0	50	2	52	3.8	1.0	1
19:15-19:30	22	1	23	4.3	1.5	1	71	2	73	2.7	1.5	2
19:30-19:45	26	0	26	0.0	1.7	0	64	3	67	4.5	1.4	3
19:45-20:00	11	0	11	0.0	0.7	0	58	1	59	1.7	1.2	3
1時間計	73	1	74	1.4	4.9	1	243	8	251	3.2	5.1	9
20:00-20:15	8	1	9	11.1	0.6	0	64	1	65	1.5	1.3	8
20:15-20:30	29	1	30	3.3	2.0	1	53	0	53	0.0	1.1	2
20:30-20:45	8	2	10	20.0	0.7	0	61	2	63	3.2	1.3	2
20:45-21:00	9	2	11	18.2	0.7	0	52	8	60	13.3	1.2	2
1時間計	54	6	60	10.0	3.9	1	230	11	241	4.6	4.9	14
21:00-21:15	7	0	7	0.0	0.5	0	40	1	41	2.4	0.8	3
21:15-21:30	9	1	10	10.0	0.7	0	39	0	39	0.0	0.8	5
21:30-21:45	11	0	11	0.0	0.7	0	26	2	28	7.1	0.6	4
21:45-22:00	8	0	8	0.0	0.5	0	11	0	11	0.0	0.2	2
1時間計	35	1	36	2.8	2.4	0	116	3	119	2.5	2.4	14
昼12時間計	1118	55	1173	4.7	77.2	27	3281	256	3537	7.2	71.3	127
夜12時間計	321	25	346	7.2	22.8	18	1284	137	1421	9.6	28.7	114
全時間合計	1439	80	1519	5.3	100.0	45	4565	393	4958	7.9	100.0	241
昼夜率	1.29	1.45	1.29	-	-	1.67	1.39	1.54	1.40	-	-	1.90

方向別自動車交通量調査表

調査地点：地域社会6 瀬谷中学校前

調査年月日：令和元年10月13日(日) 天候：曇りのち雨



方向 種別	3					A 合計 (1+ 3)						
	小型車 (台)	大型車 (台)	合計 (台)	大型車 混入率 (%)	時間 係数 (%)	二輪車 (台)	小型車 (台)	大型車 (台)	合計 (台)	大型車 混入率 (%)	時間 係数 (%)	二輪車 (台)
22:00-22:15	2	0	2	0.0	0.5	0	53	1	54	1.9	0.8	4
22:15-22:30	1	0	1	0.0	0.3	0	57	7	64	10.9	0.9	9
22:30-22:45	2	0	2	0.0	0.5	0	50	2	52	3.8	0.8	4
22:45-23:00	9	0	9	0.0	2.5	0	42	5	47	10.6	0.7	1
1時間計	14	0	14	0.0	3.8	0	202	15	217	6.9	3.2	18
23:00-23:15	6	0	6	0.0	1.6	0	47	6	53	11.3	0.8	5
23:15-23:30	2	0	2	0.0	0.5	0	38	1	39	2.6	0.6	2
23:30-23:45	1	0	1	0.0	0.3	0	24	1	25	4.0	0.4	2
23:45-24:00	3	0	3	0.0	0.8	0	26	3	29	10.3	0.4	4
1時間計	12	0	12	0.0	3.3	0	135	11	146	7.5	2.1	13
0:00- 0:15	2	0	2	0.0	0.5	1	21	1	22	4.5	0.3	3
0:15- 0:30	1	0	1	0.0	0.3	0	19	3	22	13.6	0.3	2
0:30- 0:45	1	0	1	0.0	0.3	1	17	9	26	34.6	0.4	2
0:45- 1:00	3	0	3	0.0	0.8	0	20	1	21	4.8	0.3	1
1時間計	7	0	7	0.0	1.9	2	77	14	91	15.4	1.3	8
1:00- 1:15	1	0	1	0.0	0.3	0	20	3	23	13.0	0.3	4
1:15- 1:30	1	0	1	0.0	0.3	0	12	0	12	0.0	0.2	1
1:30- 1:45	0	0	0	0.0	0.0	0	13	1	14	7.1	0.2	4
1:45- 2:00	0	0	0	0.0	0.0	1	10	7	17	41.2	0.2	1
1時間計	2	0	2	0.0	0.5	1	55	11	66	16.7	1.0	10
2:00- 2:15	0	0	0	0.0	0.0	0	9	1	10	10.0	0.1	2
2:15- 2:30	0	0	0	0.0	0.0	0	13	1	14	7.1	0.2	3
2:30- 2:45	0	0	0	0.0	0.0	0	10	2	12	16.7	0.2	1
2:45- 3:00	0	0	0	0.0	0.0	0	9	1	10	10.0	0.1	1
1時間計	0	0	0	0.0	0.0	0	41	5	46	10.9	0.7	7
3:00- 3:15	1	0	1	0.0	0.3	0	9	2	11	18.2	0.2	2
3:15- 3:30	0	0	0	0.0	0.0	0	5	4	9	44.4	0.1	1
3:30- 3:45	0	0	0	0.0	0.0	0	2	1	3	33.3	0.0	0
3:45- 4:00	0	0	0	0.0	0.0	0	16	5	21	23.8	0.3	0
1時間計	1	0	1	0.0	0.3	0	32	12	44	27.3	0.6	3
4:00- 4:15	1	0	1	0.0	0.3	0	17	2	19	10.5	0.3	1
4:15- 4:30	0	0	0	0.0	0.0	0	12	1	13	7.7	0.2	2
4:30- 4:45	0	0	0	0.0	0.0	0	20	5	25	20.0	0.4	3
4:45- 5:00	0	0	0	0.0	0.0	0	14	2	16	12.5	0.2	0
1時間計	1	0	1	0.0	0.3	0	63	10	73	13.7	1.1	6
5:00- 5:15	0	0	0	0.0	0.0	0	14	10	24	41.7	0.4	2
5:15- 5:30	0	0	0	0.0	0.0	0	19	3	22	13.6	0.3	4
5:30- 5:45	1	0	1	0.0	0.3	0	27	5	32	15.6	0.5	4
5:45- 6:00	1	0	1	0.0	0.3	0	36	6	42	14.3	0.6	1
1時間計	2	0	2	0.0	0.5	0	96	24	120	20.0	1.8	11

方向別自動車交通量調査表

調査地点：地域社会6 瀬谷中学校前

調査年月日：令和元年10月13日(日) 天候：曇りのち雨



方向	3						A 合計 (1+ 2+ 3)					
	種別 時間帯	小型車 (台)	大型車 (台)	合計 (台)	大型車 混入率 (%)	時 間 係 数 (%)	二輪車 (台)	小型車 (台)	大型車 (台)	合計 (台)	大型車 混入率 (%)	時 間 係 数 (%)
6:00- 6:15	2	0	2	0.0	0.5	0	43	7	50	14.0	0.7	1
6:15- 6:30	3	0	3	0.0	0.8	0	49	3	52	5.8	0.8	6
6:30- 6:45	1	0	1	0.0	0.3	0	55	10	65	15.4	0.9	7
6:45- 7:00	1	0	1	0.0	0.3	0	52	10	62	16.1	0.9	6
1 時間計	7	0	7	0.0	1.9	0	199	30	229	13.1	3.3	20
7:00- 7:15	1	0	1	0.0	0.3	0	44	6	50	12.0	0.7	5
7:15- 7:30	0	0	0	0.0	0.0	0	51	11	62	17.7	0.9	4
7:30- 7:45	4	0	4	0.0	1.1	0	92	6	98	6.1	1.4	4
7:45- 8:00	5	0	5	0.0	1.4	0	81	12	93	12.9	1.4	5
1 時間計	10	0	10	0.0	2.7	0	268	35	303	11.6	4.4	18
8:00- 8:15	6	1	7	14.3	1.9	0	77	19	96	19.8	1.4	5
8:15- 8:30	2	0	2	0.0	0.5	0	86	12	98	12.2	1.4	2
8:30- 8:45	3	0	3	0.0	0.8	0	86	11	97	11.3	1.4	6
8:45- 9:00	7	0	7	0.0	1.9	1	83	10	93	10.8	1.4	5
1 時間計	18	1	19	5.3	5.2	1	332	52	384	13.5	5.6	18
9:00- 9:15	6	2	8	25.0	2.2	0	82	15	97	15.5	1.4	5
9:15- 9:30	6	0	6	0.0	1.6	0	101	3	104	2.9	1.5	3
9:30- 9:45	3	0	3	0.0	0.8	0	113	1	114	0.9	1.7	5
9:45- 10:00	3	3	6	50.0	1.6	0	119	3	122	2.5	1.8	4
1 時間計	18	5	23	21.7	6.3	0	415	22	437	5.0	6.4	17
10:00- 10:15	6	1	7	14.3	1.9	0	118	8	126	6.3	1.8	2
10:15- 10:30	6	0	6	0.0	1.6	0	89	4	93	4.3	1.4	1
10:30- 10:45	8	0	8	0.0	2.2	0	78	7	85	8.2	1.2	5
10:45- 11:00	4	0	4	0.0	1.1	1	110	11	121	9.1	1.8	7
1 時間計	24	1	25	4.0	6.8	1	395	30	425	7.1	6.2	15
11:00- 11:15	8	0	8	0.0	2.2	0	96	11	107	10.3	1.6	1
11:15- 11:30	5	0	5	0.0	1.4	0	118	4	122	3.3	1.8	3
11:30- 11:45	8	0	8	0.0	2.2	0	114	7	121	5.8	1.8	2
11:45- 12:00	15	0	15	0.0	4.1	1	127	9	136	6.6	2.0	4
1 時間計	36	0	36	0.0	9.8	1	455	31	486	6.4	7.1	10
12:00- 12:15	4	0	4	0.0	1.1	1	91	17	108	15.7	1.6	2
12:15- 12:30	12	0	12	0.0	3.3	0	115	6	121	5.0	1.8	4
12:30- 12:45	8	0	8	0.0	2.2	0	107	6	113	5.3	1.7	3
12:45- 13:00	4	0	4	0.0	1.1	1	91	7	98	7.1	1.4	2
1 時間計	28	0	28	0.0	7.6	2	404	36	440	8.2	6.4	11
13:00- 13:15	12	0	12	0.0	3.3	0	116	6	122	4.9	1.8	2
13:15- 13:30	8	1	9	11.1	2.5	0	79	8	87	9.2	1.3	5
13:30- 13:45	5	1	6	16.7	1.6	0	107	7	114	6.1	1.7	0
13:45- 14:00	3	0	3	0.0	0.8	0	95	4	99	4.0	1.4	3
1 時間計	28	2	30	6.7	8.2	0	397	25	422	5.9	6.2	10

方向別自動車交通量調査表

調査地点 : 地域社会6 瀬谷中学校前

調査年月日 : 令和元年10月13日(日) 天候:曇りのち雨



方向 時間帯	3						A 合計 (1+ 3)					
	種別 小型車 (台)	大型車 (台)	合計 (台)	大型車 混入率 (%)	時間 係数 (%)	二輪車 (台)	小型車 (台)	大型車 (台)	合計 (台)	大型車 混入率 (%)	時間 係数 (%)	二輪車 (台)
14:00-14:15	11	1	12	8.3	3.3	0	100	8	108	7.4	1.6	1
14:15-14:30	7	1	8	12.5	2.2	0	82	4	86	4.7	1.3	3
14:30-14:45	2	1	3	33.3	0.8	0	91	7	98	7.1	1.4	4
14:45-15:00	14	0	14	0.0	3.8	0	124	3	127	2.4	1.9	0
1時間計	34	3	37	8.1	10.1	0	397	22	419	5.3	6.1	8
15:00-15:15	3	1	4	25.0	1.1	0	80	8	88	9.1	1.3	2
15:15-15:30	5	0	5	0.0	1.4	1	75	2	77	2.6	1.1	1
15:30-15:45	10	0	10	0.0	2.7	0	130	10	140	7.1	2.0	1
15:45-16:00	1	0	1	0.0	0.3	0	104	5	109	4.6	1.6	1
1時間計	19	1	20	5.0	5.4	1	389	25	414	6.0	6.0	5
16:00-16:15	2	1	3	33.3	0.8	0	116	2	118	1.7	1.7	1
16:15-16:30	4	0	4	0.0	1.1	0	87	5	92	5.4	1.3	1
16:30-16:45	5	0	5	0.0	1.4	0	90	6	96	6.3	1.4	4
16:45-17:00	2	0	2	0.0	0.5	0	107	3	110	2.7	1.6	2
1時間計	13	1	14	7.1	3.8	0	400	16	416	3.8	6.1	8
17:00-17:15	5	1	6	16.7	1.6	0	123	6	129	4.7	1.9	7
17:15-17:30	10	0	10	0.0	2.7	0	108	5	113	4.4	1.7	5
17:30-17:45	11	1	12	8.3	3.3	0	111	8	119	6.7	1.7	5
17:45-18:00	8	0	8	0.0	2.2	0	92	5	97	5.2	1.4	5
1時間計	34	2	36	5.6	9.8	0	434	24	458	5.2	6.7	22
18:00-18:15	5	0	5	0.0	1.4	0	109	1	110	0.9	1.6	0
18:15-18:30	5	0	5	0.0	1.4	0	94	3	97	3.1	1.4	7
18:30-18:45	5	0	5	0.0	1.4	0	97	3	100	3.0	1.5	4
18:45-19:00	3	0	3	0.0	0.8	0	93	2	95	2.1	1.4	7
1時間計	18	0	18	0.0	4.9	0	393	9	402	2.2	5.9	18
19:00-19:15	4	0	4	0.0	1.1	0	68	2	70	2.9	1.0	1
19:15-19:30	2	1	3	33.3	0.8	0	95	4	99	4.0	1.4	3
19:30-19:45	1	0	1	0.0	0.3	0	91	3	94	3.2	1.4	3
19:45-20:00	1	1	2	50.0	0.5	0	70	2	72	2.8	1.1	3
1時間計	8	2	10	20.0	2.7	0	324	11	335	3.3	4.9	10
20:00-20:15	1	0	1	0.0	0.3	0	73	2	75	2.7	1.1	8
20:15-20:30	4	0	4	0.0	1.1	0	86	1	87	1.1	1.3	3
20:30-20:45	1	0	1	0.0	0.3	0	70	4	74	5.4	1.1	2
20:45-21:00	1	0	1	0.0	0.3	0	62	10	72	13.9	1.1	2
1時間計	7	0	7	0.0	1.9	0	291	17	308	5.5	4.5	15
21:00-21:15	1	0	1	0.0	0.3	0	48	1	49	2.0	0.7	3
21:15-21:30	2	0	2	0.0	0.5	0	50	1	51	2.0	0.7	5
21:30-21:45	1	0	1	0.0	0.3	0	38	2	40	5.0	0.6	4
21:45-22:00	3	1	4	25.0	1.1	0	22	1	23	4.3	0.3	2
1時間計	7	1	8	12.5	2.2	0	158	5	163	3.1	2.4	14
昼12時間計	280	16	296	5.4	80.7	6	4679	327	5006	6.5	73.1	160
夜12時間計	68	3	71	4.2	19.3	3	1673	165	1838	9.0	26.9	135
全時間合計	348	19	367	5.2	100.0	9	6352	492	6844	7.2	100.0	295
昼夜率	1.24	1.19	1.24	-	-	1.50	1.36	1.50	1.37	-	-	1.84

方向別自動車交通量調査表

調査地点 : 地域社会6 瀬谷中学校前

調査年月日 : 令和元年10月13日(日) 天候:曇りのち雨



方向 種別 時間帯	4						5					
	小型車 (台)	大型車 (台)	合計 (台)	大型車 混入率 (%)	時間 係数 (%)	二輪車 (台)	小型車 (台)	大型車 (台)	合計 (台)	大型車 混入率 (%)	時間 係数 (%)	二輪車 (台)
22:00-22:15	6	0	6	0.0	1.8	0	26	1	27	3.7	0.8	2
22:15-22:30	0	0	0	0.0	0.0	0	28	0	28	0.0	0.8	1
22:30-22:45	3	0	3	0.0	0.9	0	27	0	27	0.0	0.8	4
22:45-23:00	1	0	1	0.0	0.3	0	12	0	12	0.0	0.3	0
1時間計	10	0	10	0.0	3.0	0	93	1	94	1.1	2.7	7
23:00-23:15	2	0	2	0.0	0.6	0	14	0	14	0.0	0.4	1
23:15-23:30	5	0	5	0.0	1.5	0	17	0	17	0.0	0.5	0
23:30-23:45	2	0	2	0.0	0.6	0	19	0	19	0.0	0.6	0
23:45-24:00	0	0	0	0.0	0.0	0	4	0	4	0.0	0.1	1
1時間計	9	0	9	0.0	2.7	0	54	0	54	0.0	1.6	2
0:00-0:15	0	0	0	0.0	0.0	0	6	0	6	0.0	0.2	3
0:15-0:30	0	0	0	0.0	0.0	0	10	0	10	0.0	0.3	0
0:30-0:45	1	0	1	0.0	0.3	0	6	0	6	0.0	0.2	1
0:45-1:00	2	0	2	0.0	0.6	0	6	0	6	0.0	0.2	2
1時間計	3	0	3	0.0	0.9	0	28	0	28	0.0	0.8	6
1:00-1:15	0	0	0	0.0	0.0	0	11	0	11	0.0	0.3	2
1:15-1:30	2	0	2	0.0	0.6	0	10	0	10	0.0	0.3	0
1:30-1:45	0	0	0	0.0	0.0	0	3	0	3	0.0	0.1	1
1:45-2:00	0	0	0	0.0	0.0	0	4	0	4	0.0	0.1	0
1時間計	2	0	2	0.0	0.6	0	28	0	28	0.0	0.8	3
2:00-2:15	0	0	0	0.0	0.0	0	1	1	2	50.0	0.1	2
2:15-2:30	1	0	1	0.0	0.3	0	6	0	6	0.0	0.2	1
2:30-2:45	0	0	0	0.0	0.0	0	2	2	4	50.0	0.1	0
2:45-3:00	0	0	0	0.0	0.0	0	1	0	1	0.0	0.0	1
1時間計	1	0	1	0.0	0.3	0	10	3	13	23.1	0.4	4
3:00-3:15	0	0	0	0.0	0.0	0	0	1	1	100.0	0.0	0
3:15-3:30	0	0	0	0.0	0.0	0	4	0	4	0.0	0.1	0
3:30-3:45	0	0	0	0.0	0.0	0	1	0	1	0.0	0.0	2
3:45-4:00	2	0	2	0.0	0.6	0	6	1	7	14.3	0.2	0
1時間計	2	0	2	0.0	0.6	0	11	2	13	15.4	0.4	2
4:00-4:15	0	0	0	0.0	0.0	0	7	1	8	12.5	0.2	0
4:15-4:30	0	0	0	0.0	0.0	0	6	0	6	0.0	0.2	1
4:30-4:45	0	0	0	0.0	0.0	0	8	0	8	0.0	0.2	1
4:45-5:00	0	0	0	0.0	0.0	0	6	0	6	0.0	0.2	2
1時間計	0	0	0	0.0	0.0	0	27	1	28	3.6	0.8	4
5:00-5:15	1	0	1	0.0	0.3	0	12	0	12	0.0	0.3	2
5:15-5:30	0	0	0	0.0	0.0	0	15	0	15	0.0	0.4	1
5:30-5:45	2	0	2	0.0	0.6	0	23	0	23	0.0	0.7	0
5:45-6:00	1	0	1	0.0	0.3	0	19	1	20	5.0	0.6	1
1時間計	4	0	4	0.0	1.2	0	69	1	70	1.4	2.0	4

方向別自動車交通量調査表

調査地点：地域社会6 瀬谷中学校前

調査年月日：令和元年10月13日(日) 天候：曇りのち雨



方向	4						5							
	種別	小型車 (台)	大型車 (台)	合計 (台)	大型車 混入率 (%)	時間 係数 (%)	二輪車 (台)	種別	小型車 (台)	大型車 (台)	合計 (台)	大型車 混入率 (%)	時間 係数 (%)	二輪車 (台)
6:00-6:15		0	0	0	0.0	0.0	0		30	0	30	0.0	0.9	3
6:15-6:30		1	0	1	0.0	0.3	1		49	1	50	2.0	1.5	7
6:30-6:45		1	0	1	0.0	0.3	0		33	5	38	13.2	1.1	0
6:45-7:00		1	0	1	0.0	0.3	0		38	2	40	5.0	1.2	4
1時間計		3	0	3	0.0	0.9	1		150	8	158	5.1	4.6	14
7:00-7:15		2	0	2	0.0	0.6	0		47	4	51	7.8	1.5	2
7:15-7:30		2	0	2	0.0	0.6	0		31	2	33	6.1	1.0	0
7:30-7:45		4	1	5	20.0	1.5	0		33	2	35	5.7	1.0	0
7:45-8:00		4	0	4	0.0	1.2	0		65	4	69	5.8	2.0	2
1時間計		12	1	13	7.7	3.9	0		176	12	188	6.4	5.5	4
8:00-8:15		2	0	2	0.0	0.6	1		47	5	52	9.6	1.5	1
8:15-8:30		5	0	5	0.0	1.5	2		43	4	47	8.5	1.4	0
8:30-8:45		4	0	4	0.0	1.2	0		47	3	50	6.0	1.5	3
8:45-9:00		9	0	9	0.0	2.7	0		51	2	53	3.8	1.5	1
1時間計		20	0	20	0.0	6.0	3		188	14	202	6.9	5.9	5
9:00-9:15		6	0	6	0.0	1.8	0		48	3	51	5.9	1.5	2
9:15-9:30		5	1	6	16.7	1.8	2		43	3	46	6.5	1.3	4
9:30-9:45		6	0	6	0.0	1.8	0		52	4	56	7.1	1.6	4
9:45-10:00		3	0	3	0.0	0.9	0		31	2	33	6.1	1.0	2
1時間計		20	1	21	4.8	6.3	2		174	12	186	6.5	5.4	12
10:00-10:15		3	0	3	0.0	0.9	0		45	6	51	11.8	1.5	2
10:15-10:30		3	0	3	0.0	0.9	0		32	1	33	3.0	1.0	3
10:30-10:45		6	0	6	0.0	1.8	0		50	3	53	5.7	1.5	2
10:45-11:00		6	1	7	14.3	2.1	1		42	2	44	4.5	1.3	1
1時間計		18	1	19	5.3	5.7	1		169	12	181	6.6	5.2	8
11:00-11:15		4	0	4	0.0	1.2	0		28	1	29	3.4	0.8	1
11:15-11:30		2	0	2	0.0	0.6	0		55	5	60	8.3	1.7	1
11:30-11:45		2	0	2	0.0	0.6	0		50	4	54	7.4	1.6	2
11:45-12:00		2	0	2	0.0	0.6	0		53	2	55	3.6	1.6	1
1時間計		10	0	10	0.0	3.0	0		186	12	198	6.1	5.7	5
12:00-12:15		7	0	7	0.0	2.1	0		51	1	52	1.9	1.5	0
12:15-12:30		6	0	6	0.0	1.8	0		38	1	39	2.6	1.1	3
12:30-12:45		9	0	9	0.0	2.7	0		58	2	60	3.3	1.7	3
12:45-13:00		2	0	2	0.0	0.6	0		32	2	34	5.9	1.0	3
1時間計		24	0	24	0.0	7.2	0		179	6	185	3.2	5.4	9
13:00-13:15		3	0	3	0.0	0.9	0		50	0	50	0.0	1.5	1
13:15-13:30		5	0	5	0.0	1.5	0		61	1	62	1.6	1.8	1
13:30-13:45		2	0	2	0.0	0.6	0		26	1	27	3.7	0.8	0
13:45-14:00		7	0	7	0.0	2.1	1		37	3	40	7.5	1.2	1
1時間計		17	0	17	0.0	5.1	1		174	5	179	2.8	5.2	3

方向別自動車交通量調査表

調査地点：地域社会6 瀬谷中学校前

調査年月日：令和元年10月13日(日) 天候：曇りのち雨



方向 種別 時間帯	4						5					
	小型車 (台)	大型車 (台)	合計 (台)	大型車 混入率 (%)	時間 係数 (%)	二輪車 (台)	小型車 (台)	大型車 (台)	合計 (台)	大型車 混入率 (%)	時間 係数 (%)	二輪車 (台)
14:00-14:15	6	0	6	0.0	1.8	0	46	2	48	4.2	1.4	3
14:15-14:30	4	0	4	0.0	1.2	0	42	1	43	2.3	1.2	3
14:30-14:45	3	0	3	0.0	0.9	0	38	0	38	0.0	1.1	1
14:45-15:00	6	1	7	14.3	2.1	0	47	1	48	2.1	1.4	0
1時間計	19	1	20	5.0	6.0	0	173	4	177	2.3	5.1	7
15:00-15:15	5	0	5	0.0	1.5	0	52	1	53	1.9	1.5	1
15:15-15:30	3	0	3	0.0	0.9	0	52	2	54	3.7	1.6	5
15:30-15:45	9	1	10	10.0	3.0	0	69	1	70	1.4	2.0	3
15:45-16:00	7	0	7	0.0	2.1	0	58	4	62	6.5	1.8	1
1時間計	24	1	25	4.0	7.5	0	231	8	239	3.3	6.9	10
16:00-16:15	5	0	5	0.0	1.5	0	61	0	61	0.0	1.8	3
16:15-16:30	7	0	7	0.0	2.1	0	53	2	55	3.6	1.6	3
16:30-16:45	6	0	6	0.0	1.8	0	62	1	63	1.6	1.8	0
16:45-17:00	14	0	14	0.0	4.2	0	45	2	47	4.3	1.4	3
1時間計	32	0	32	0.0	9.6	0	221	5	226	2.2	6.6	9
17:00-17:15	23	0	23	0.0	6.9	0	86	3	89	3.4	2.6	3
17:15-17:30	11	0	11	0.0	3.3	0	69	2	71	2.8	2.1	0
17:30-17:45	5	0	5	0.0	1.5	0	44	0	44	0.0	1.3	3
17:45-18:00	3	0	3	0.0	0.9	0	55	4	59	6.8	1.7	2
1時間計	42	0	42	0.0	12.6	0	254	9	263	3.4	7.6	8
18:00-18:15	7	0	7	0.0	2.1	0	51	3	54	5.6	1.6	2
18:15-18:30	7	0	7	0.0	2.1	0	54	0	54	0.0	1.6	3
18:30-18:45	4	0	4	0.0	1.2	0	67	2	69	2.9	2.0	3
18:45-19:00	12	0	12	0.0	3.6	0	110	3	113	2.7	3.3	6
1時間計	30	0	30	0.0	9.0	0	282	8	290	2.8	8.4	14
19:00-19:15	6	0	6	0.0	1.8	0	59	0	59	0.0	1.7	3
19:15-19:30	3	0	3	0.0	0.9	0	31	2	33	6.1	1.0	1
19:30-19:45	4	0	4	0.0	1.2	0	65	2	67	3.0	1.9	2
19:45-20:00	1	0	1	0.0	0.3	0	32	1	33	3.0	1.0	1
1時間計	14	0	14	0.0	4.2	0	187	5	192	2.6	5.6	7
20:00-20:15	1	0	1	0.0	0.3	0	34	1	35	2.9	1.0	4
20:15-20:30	2	0	2	0.0	0.6	0	42	1	43	2.3	1.2	0
20:30-20:45	2	0	2	0.0	0.6	0	31	0	31	0.0	0.9	2
20:45-21:00	1	0	1	0.0	0.3	0	24	1	25	4.0	0.7	4
1時間計	6	0	6	0.0	1.8	0	131	3	134	2.2	3.9	10
21:00-21:15	2	0	2	0.0	0.6	0	30	2	32	6.3	0.9	1
21:15-21:30	1	0	1	0.0	0.3	0	32	0	32	0.0	0.9	4
21:30-21:45	3	0	3	0.0	0.9	0	31	1	32	3.1	0.9	2
21:45-22:00	1	0	1	0.0	0.3	0	26	0	26	0.0	0.8	2
1時間計	7	0	7	0.0	2.1	0	119	3	122	2.5	3.5	9
昼12時間計	268	5	273	1.8	81.7	7	2407	107	2514	4.3	72.9	94
夜12時間計	61	0	61	0.0	18.3	1	907	27	934	2.9	27.1	72
全時間合計	329	5	334	1.5	100.0	8	3314	134	3448	3.9	100.0	166
昼夜率	1.23	1.00	1.22	-	-	1.14	1.38	1.25	1.37	-	-	1.77

方向別自動車交通量調査表

調査地点：地域社会6 瀬谷中学校前

調査年月日：令和元年10月13日(日) 天候：曇りのち雨



方向 種別 時間帯	6						B 合計 (4+ 5+ 6)					
	小型車 (台)	大型車 (台)	合計 (台)	大型車 混入率 (%)	時間 係数 (%)	二輪車 (台)	小型車 (台)	大型車 (台)	合計 (台)	大型車 混入率 (%)	時間 係数 (%)	二輪車 (台)
22:00-22:15	33	0	33	0.0	1.1	2	65	1	66	1.5	1.0	4
22:15-22:30	27	0	27	0.0	0.9	1	55	0	55	0.0	0.8	2
22:30-22:45	30	0	30	0.0	1.0	3	60	0	60	0.0	0.9	7
22:45-23:00	13	1	14	7.1	0.5	3	26	1	27	3.7	0.4	3
1時間計	103	1	104	1.0	3.6	9	206	2	208	1.0	3.1	16
23:00-23:15	19	2	21	9.5	0.7	1	35	2	37	5.4	0.6	2
23:15-23:30	16	0	16	0.0	0.6	2	38	0	38	0.0	0.6	2
23:30-23:45	14	1	15	6.7	0.5	0	35	1	36	2.8	0.5	0
23:45-24:00	3	0	3	0.0	0.1	1	7	0	7	0.0	0.1	2
1時間計	52	3	55	5.5	1.9	4	115	3	118	2.5	1.8	6
0:00- 0:15	11	0	11	0.0	0.4	0	17	0	17	0.0	0.3	3
0:15- 0:30	10	0	10	0.0	0.3	2	20	0	20	0.0	0.3	2
0:30- 0:45	13	0	13	0.0	0.5	0	20	0	20	0.0	0.3	1
0:45- 1:00	19	1	20	5.0	0.7	3	27	1	28	3.6	0.4	5
1時間計	53	1	54	1.9	1.9	5	84	1	85	1.2	1.3	11
1:00- 1:15	5	1	6	16.7	0.2	3	16	1	17	5.9	0.3	5
1:15- 1:30	10	1	11	9.1	0.4	3	22	1	23	4.3	0.3	3
1:30- 1:45	4	0	4	0.0	0.1	0	7	0	7	0.0	0.1	1
1:45- 2:00	5	1	6	16.7	0.2	1	9	1	10	10.0	0.2	1
1時間計	24	3	27	11.1	0.9	7	54	3	57	5.3	0.9	10
2:00- 2:15	4	0	4	0.0	0.1	0	5	1	6	16.7	0.1	2
2:15- 2:30	2	0	2	0.0	0.1	0	9	0	9	0.0	0.1	1
2:30- 2:45	6	1	7	14.3	0.2	1	8	3	11	27.3	0.2	1
2:45- 3:00	1	0	1	0.0	0.0	0	2	0	2	0.0	0.0	1
1時間計	13	1	14	7.1	0.5	1	24	4	28	14.3	0.4	5
3:00- 3:15	3	0	3	0.0	0.1	0	3	1	4	25.0	0.1	0
3:15- 3:30	2	1	3	33.3	0.1	0	6	1	7	14.3	0.1	0
3:30- 3:45	3	0	3	0.0	0.1	0	4	0	4	0.0	0.1	2
3:45- 4:00	5	1	6	16.7	0.2	0	13	2	15	13.3	0.2	0
1時間計	13	2	15	13.3	0.5	0	26	4	30	13.3	0.5	2
4:00- 4:15	3	0	3	0.0	0.1	0	10	1	11	9.1	0.2	0
4:15- 4:30	2	0	2	0.0	0.1	1	8	0	8	0.0	0.1	2
4:30- 4:45	8	0	8	0.0	0.3	1	16	0	16	0.0	0.2	2
4:45- 5:00	3	0	3	0.0	0.1	0	9	0	9	0.0	0.1	2
1時間計	16	0	16	0.0	0.6	2	43	1	44	2.3	0.7	6
5:00- 5:15	14	3	17	17.6	0.6	0	27	3	30	10.0	0.5	2
5:15- 5:30	7	0	7	0.0	0.2	0	22	0	22	0.0	0.3	1
5:30- 5:45	25	2	27	7.4	0.9	0	50	2	52	3.8	0.8	0
5:45- 6:00	18	4	22	18.2	0.8	4	38	5	43	11.6	0.6	5
1時間計	64	9	73	12.3	2.5	4	137	10	147	6.8	2.2	8

方向別自動車交通量調査表

調査地点：地域社会6 瀬谷中学校前

調査年月日：令和元年10月13日(日) 天候：曇りのち雨



方向 時間帯	6						B 合計 (4+ 5+ 6)					
	種別 小型車 (台)	大型車 (台)	合計 (台)	大型車 混入率 (%)	時間 係数 (%)	二輪車 (台)	小型車 (台)	大型車 (台)	合計 (台)	大型車 混入率 (%)	時間 係数 (%)	二輪車 (台)
6:00-6:15	17	0	17	0.0	0.6	2	47	0	47	0.0	0.7	5
6:15-6:30	24	0	24	0.0	0.8	1	74	1	75	1.3	1.1	9
6:30-6:45	42	4	46	8.7	1.6	3	76	9	85	10.6	1.3	3
6:45-7:00	37	1	38	2.6	1.3	1	76	3	79	3.8	1.2	5
1時間計	120	5	125	4.0	4.4	7	273	13	286	4.5	4.3	22
7:00-7:15	35	1	36	2.8	1.3	1	84	5	89	5.6	1.3	3
7:15-7:30	34	2	36	5.6	1.3	4	67	4	71	5.6	1.1	4
7:30-7:45	20	4	24	16.7	0.8	0	57	7	64	10.9	1.0	0
7:45-8:00	46	4	50	8.0	1.7	2	115	8	123	6.5	1.8	4
1時間計	135	11	146	7.5	5.1	7	323	24	347	6.9	5.2	11
8:00-8:15	44	0	44	0.0	1.5	3	93	5	98	5.1	1.5	5
8:15-8:30	34	6	40	15.0	1.4	1	82	10	92	10.9	1.4	3
8:30-8:45	42	0	42	0.0	1.5	1	93	3	96	3.1	1.4	4
8:45-9:00	35	4	39	10.3	1.4	2	95	6	101	5.9	1.5	3
1時間計	155	10	165	6.1	5.7	7	363	24	387	6.2	5.8	15
9:00-9:15	28	3	31	9.7	1.1	1	82	6	88	6.8	1.3	3
9:15-9:30	45	3	48	6.3	1.7	1	93	7	100	7.0	1.5	7
9:30-9:45	33	2	35	5.7	1.2	0	91	6	97	6.2	1.5	4
9:45-10:00	36	2	38	5.3	1.3	2	70	4	74	5.4	1.1	4
1時間計	142	10	152	6.6	5.3	4	336	23	359	6.4	5.4	18
10:00-10:15	57	1	58	1.7	2.0	1	105	7	112	6.3	1.7	3
10:15-10:30	33	2	35	5.7	1.2	2	68	3	71	4.2	1.1	5
10:30-10:45	48	2	50	4.0	1.7	0	104	5	109	4.6	1.6	2
10:45-11:00	42	0	42	0.0	1.5	2	90	3	93	3.2	1.4	4
1時間計	180	5	185	2.7	6.4	5	367	18	385	4.7	5.8	14
11:00-11:15	25	2	27	7.4	0.9	3	57	3	60	5.0	0.9	4
11:15-11:30	54	1	55	1.8	1.9	2	111	6	117	5.1	1.8	3
11:30-11:45	57	2	59	3.4	2.1	2	109	6	115	5.2	1.7	4
11:45-12:00	36	1	37	2.7	1.3	2	91	3	94	3.2	1.4	3
1時間計	172	6	178	3.4	6.2	9	368	18	386	4.7	5.8	14
12:00-12:15	55	3	58	5.2	2.0	0	113	4	117	3.4	1.8	0
12:15-12:30	36	0	36	0.0	1.3	0	80	1	81	1.2	1.2	3
12:30-12:45	55	1	56	1.8	2.0	0	122	3	125	2.4	1.9	3
12:45-13:00	29	0	29	0.0	1.0	3	63	2	65	3.1	1.0	6
1時間計	175	4	179	2.2	6.2	3	378	10	388	2.6	5.8	12
13:00-13:15	46	0	46	0.0	1.6	0	99	0	99	0.0	1.5	1
13:15-13:30	40	1	41	2.4	1.4	0	106	2	108	1.9	1.6	1
13:30-13:45	24	2	26	7.7	0.9	0	52	3	55	5.5	0.8	0
13:45-14:00	38	3	41	7.3	1.4	1	82	6	88	6.8	1.3	3
1時間計	148	6	154	3.9	5.4	1	339	11	350	3.1	5.3	5

方向別自動車交通量調査表

調査地点：地域社会6 瀬谷中学校前

調査年月日：令和元年10月13日(日) 天候：曇りのち雨



方向 種別 時間帯	6						B 合計 (4+5+6)					
	小型車 (台)	大型車 (台)	合計 (台)	大型車 混入率 (%)	時間 係数 (%)	二輪車 (台)	小型車 (台)	大型車 (台)	合計 (台)	大型車 混入率 (%)	時間 係数 (%)	二輪車 (台)
14:00-14:15	42	5	47	10.6	1.6	1	94	7	101	6.9	1.5	4
14:15-14:30	39	5	44	11.4	1.5	0	85	6	91	6.8	1.4	3
14:30-14:45	46	0	46	0.0	1.6	0	87	0	87	0.0	1.3	1
14:45-15:00	44	0	44	0.0	1.5	2	97	2	99	2.0	1.5	2
1時間計	171	10	181	5.5	6.3	3	363	15	378	4.0	5.7	10
15:00-15:15	32	6	38	15.8	1.3	3	89	7	96	7.3	1.4	4
15:15-15:30	42	3	45	6.7	1.6	0	97	5	102	4.9	1.5	5
15:30-15:45	50	1	51	2.0	1.8	0	128	3	131	2.3	2.0	3
15:45-16:00	51	1	52	1.9	1.8	0	116	5	121	4.1	1.8	1
1時間計	175	11	186	5.9	6.5	3	430	20	450	4.4	6.8	13
16:00-16:15	41	2	43	4.7	1.5	1	107	2	109	1.8	1.6	4
16:15-16:30	39	1	40	2.5	1.4	0	99	3	102	2.9	1.5	3
16:30-16:45	38	1	39	2.6	1.4	3	106	2	108	1.9	1.6	3
16:45-17:00	41	0	41	0.0	1.4	0	100	2	102	2.0	1.5	3
1時間計	159	4	163	2.5	5.7	4	412	9	421	2.1	6.3	13
17:00-17:15	42	1	43	2.3	1.5	1	151	4	155	2.6	2.3	4
17:15-17:30	48	0	48	0.0	1.7	2	128	2	130	1.5	2.0	2
17:30-17:45	31	1	32	3.1	1.1	0	80	1	81	1.2	1.2	3
17:45-18:00	65	0	65	0.0	2.3	0	123	4	127	3.1	1.9	2
1時間計	186	2	188	1.1	6.5	3	482	11	493	2.2	7.4	11
18:00-18:15	36	1	37	2.7	1.3	1	94	4	98	4.1	1.5	3
18:15-18:30	42	0	42	0.0	1.5	2	103	0	103	0.0	1.5	5
18:30-18:45	46	1	47	2.1	1.6	1	117	3	120	2.5	1.8	4
18:45-19:00	34	0	34	0.0	1.2	0	156	3	159	1.9	2.4	6
1時間計	158	2	160	1.3	5.6	4	470	10	480	2.1	7.2	18
19:00-19:15	43	1	44	2.3	1.5	3	108	1	109	0.9	1.6	6
19:15-19:30	21	0	21	0.0	0.7	0	55	2	57	3.5	0.9	1
19:30-19:45	52	0	52	0.0	1.8	2	121	2	123	1.6	1.8	4
19:45-20:00	19	0	19	0.0	0.7	2	52	1	53	1.9	0.8	3
1時間計	135	1	136	0.7	4.7	7	336	6	342	1.8	5.1	14
20:00-20:15	37	1	38	2.6	1.3	0	72	2	74	2.7	1.1	4
20:15-20:30	35	1	36	2.8	1.3	2	79	2	81	2.5	1.2	2
20:30-20:45	21	0	21	0.0	0.7	0	54	0	54	0.0	0.8	2
20:45-21:00	22	0	22	0.0	0.8	2	47	1	48	2.1	0.7	6
1時間計	115	2	117	1.7	4.1	4	252	5	257	1.9	3.9	14
21:00-21:15	35	1	36	2.8	1.3	0	67	3	70	4.3	1.1	1
21:15-21:30	21	0	21	0.0	0.7	0	54	0	54	0.0	0.8	4
21:30-21:45	32	1	33	3.0	1.1	1	66	2	68	2.9	1.0	3
21:45-22:00	8	0	8	0.0	0.3	2	35	0	35	0.0	0.5	4
1時間計	96	2	98	2.0	3.4	3	222	5	227	2.2	3.4	12
昼12時間計	1956	81	2037	4.0	71.0	53	4631	193	4824	4.0	72.5	154
夜12時間計	804	30	834	3.6	29.0	53	1772	57	1829	3.1	27.5	126
全時間合計	2760	111	2871	3.9	100.0	106	6403	250	6653	3.8	100.0	280
昼夜率	1.41	1.37	1.41	-	-	2.00	1.38	1.30	1.38	-	-	1.82

方向別自動車交通量調査表

調査地点：地域社会6 瀬谷中学校前

調査年月日：令和元年10月13日(日) 天候：曇りのち雨



方向 種別 時間帯	7						8					
	小型車 (台)	大型車 (台)	合計 (台)	大型車 混入率 (%)	時間 係数 (%)	二輪車 (台)	小型車 (台)	大型車 (台)	合計 (台)	大型車 混入率 (%)	時間 係数 (%)	二輪車 (台)
22:00-22:15	13	1	14	7.1	0.5	0	41	1	42	2.4	0.7	2
22:15-22:30	12	0	12	0.0	0.4	2	27	2	29	6.9	0.5	5
22:30-22:45	14	0	14	0.0	0.5	0	32	2	34	5.9	0.6	2
22:45-23:00	13	0	13	0.0	0.5	1	28	4	32	12.5	0.6	6
1時間計	52	1	53	1.9	1.9	3	128	9	137	6.6	2.4	15
23:00-23:15	13	0	13	0.0	0.5	1	31	2	33	6.1	0.6	4
23:15-23:30	12	0	12	0.0	0.4	0	18	2	20	10.0	0.4	5
23:30-23:45	8	0	8	0.0	0.3	1	24	2	26	7.7	0.5	1
23:45-24:00	5	0	5	0.0	0.2	0	19	1	20	5.0	0.4	2
1時間計	38	0	38	0.0	1.4	2	92	7	99	7.1	1.7	12
0:00-0:15	11	0	11	0.0	0.4	0	21	3	24	12.5	0.4	3
0:15-0:30	10	0	10	0.0	0.4	1	14	2	16	12.5	0.3	2
0:30-0:45	7	0	7	0.0	0.3	1	11	1	12	8.3	0.2	3
0:45-1:00	6	0	6	0.0	0.2	1	15	0	15	0.0	0.3	3
1時間計	34	0	34	0.0	1.2	3	61	6	67	9.0	1.2	11
1:00-1:15	4	0	4	0.0	0.1	0	11	4	15	26.7	0.3	2
1:15-1:30	3	0	3	0.0	0.1	1	7	2	9	22.2	0.2	0
1:30-1:45	5	0	5	0.0	0.2	0	13	2	15	13.3	0.3	2
1:45-2:00	7	0	7	0.0	0.3	0	8	7	15	46.7	0.3	1
1時間計	19	0	19	0.0	0.7	1	39	15	54	27.8	0.9	5
2:00-2:15	4	1	5	20.0	0.2	0	9	4	13	30.8	0.2	1
2:15-2:30	4	0	4	0.0	0.1	0	7	6	13	46.2	0.2	0
2:30-2:45	2	0	2	0.0	0.1	1	9	1	10	10.0	0.2	2
2:45-3:00	3	0	3	0.0	0.1	0	9	4	13	30.8	0.2	1
1時間計	13	1	14	7.1	0.5	1	34	15	49	30.6	0.9	4
3:00-3:15	7	0	7	0.0	0.3	0	5	1	6	16.7	0.1	0
3:15-3:30	3	1	4	25.0	0.1	0	9	3	12	25.0	0.2	0
3:30-3:45	1	0	1	0.0	0.0	0	11	3	14	21.4	0.2	0
3:45-4:00	1	0	1	0.0	0.0	0	9	2	11	18.2	0.2	0
1時間計	12	1	13	7.7	0.5	0	34	9	43	20.9	0.8	0
4:00-4:15	4	2	6	33.3	0.2	0	8	6	14	42.9	0.2	1
4:15-4:30	3	1	4	25.0	0.1	0	12	5	17	29.4	0.3	1
4:30-4:45	2	0	2	0.0	0.1	2	11	2	13	15.4	0.2	1
4:45-5:00	9	1	10	10.0	0.4	2	12	5	17	29.4	0.3	1
1時間計	18	4	22	18.2	0.8	4	43	18	61	29.5	1.1	4
5:00-5:15	9	4	13	30.8	0.5	0	22	18	40	45.0	0.7	2
5:15-5:30	14	0	14	0.0	0.5	1	23	6	29	20.7	0.5	2
5:30-5:45	15	1	16	6.3	0.6	1	22	7	29	24.1	0.5	6
5:45-6:00	11	0	11	0.0	0.4	0	38	5	43	11.6	0.8	3
1時間計	49	5	54	9.3	2.0	2	105	36	141	25.5	2.5	13

方向別自動車交通量調査表

調査地点：地域社会6 瀬谷中学校前

調査年月日：令和元年10月13日(日) 天候：曇りのち雨



方向 時間帯	7						8					
	種別 小型車 (台)	大型車 (台)	合計 (台)	大型車 混入率 (%)	時間 係数 (%)	二輪車 (台)	小型車 (台)	大型車 (台)	合計 (台)	大型車 混入率 (%)	時間 係数 (%)	二輪車 (台)
6:00-6:15	21	2	23	8.7	0.8	2	45	5	50	10.0	0.9	5
6:15-6:30	19	0	19	0.0	0.7	2	67	8	75	10.7	1.3	11
6:30-6:45	18	2	20	10.0	0.7	1	66	10	76	13.2	1.3	4
6:45-7:00	24	1	25	4.0	0.9	0	70	5	75	6.7	1.3	3
1時間計	82	5	87	5.7	3.2	5	248	28	276	10.1	4.8	23
7:00-7:15	26	2	28	7.1	1.0	0	78	4	82	4.9	1.4	8
7:15-7:30	28	1	29	3.4	1.1	3	92	12	104	11.5	1.8	5
7:30-7:45	22	2	24	8.3	0.9	1	84	14	98	14.3	1.7	14
7:45-8:00	37	3	40	7.5	1.5	0	82	6	88	6.8	1.5	8
1時間計	113	8	121	6.6	4.4	4	336	36	372	9.7	6.5	35
8:00-8:15	42	0	42	0.0	1.5	1	110	6	116	5.2	2.0	13
8:15-8:30	32	2	34	5.9	1.2	4	104	4	108	3.7	1.9	13
8:30-8:45	37	5	42	11.9	1.5	1	89	8	97	8.2	1.7	7
8:45-9:00	47	1	48	2.1	1.8	1	84	5	89	5.6	1.6	5
1時間計	158	8	166	4.8	6.1	7	387	23	410	5.6	7.2	38
9:00-9:15	54	1	55	1.8	2.0	2	102	11	113	9.7	2.0	8
9:15-9:30	33	0	33	0.0	1.2	4	61	8	69	13.6	1.0	8
9:30-9:45	39	2	41	4.9	1.5	3	88	6	94	6.4	1.6	4
9:45-10:00	45	3	48	6.3	1.8	2	77	4	81	4.9	1.4	1
1時間計	171	6	177	3.4	6.5	11	318	29	347	8.4	6.1	21
10:00-10:15	33	3	36	8.3	1.3	4	63	8	71	11.3	1.2	3
10:15-10:30	41	0	41	0.0	1.5	1	58	5	63	7.9	1.1	0
10:30-10:45	34	4	38	10.5	1.4	1	78	10	88	11.4	1.5	3
10:45-11:00	40	0	40	0.0	1.5	0	84	4	88	4.5	1.5	1
1時間計	148	7	155	4.5	5.7	6	283	27	310	8.7	5.4	7
11:00-11:15	43	1	44	2.3	1.6	2	75	10	85	11.8	1.5	2
11:15-11:30	46	1	47	2.1	1.7	0	74	11	85	12.9	1.5	3
11:30-11:45	47	3	50	6.0	1.8	0	73	7	80	8.8	1.4	2
11:45-12:00	38	1	39	2.6	1.4	1	68	5	73	6.8	1.3	2
1時間計	174	6	180	3.3	6.6	3	290	33	323	10.2	5.7	9
12:00-12:15	32	2	34	5.9	1.2	1	69	9	78	11.5	1.4	4
12:15-12:30	39	2	41	4.9	1.5	2	66	6	72	8.3	1.3	1
12:30-12:45	40	2	42	4.8	1.5	0	77	11	88	12.5	1.5	6
12:45-13:00	42	1	43	2.3	1.6	1	88	6	94	6.4	1.6	2
1時間計	153	7	160	4.4	5.9	4	300	32	332	9.6	5.8	13
13:00-13:15	45	0	45	0.0	1.6	1	86	6	92	6.5	1.6	4
13:15-13:30	53	1	54	1.9	2.0	1	79	4	83	4.8	1.5	3
13:30-13:45	41	0	41	0.0	1.5	0	88	6	94	6.4	1.6	0
13:45-14:00	55	2	57	3.5	2.1	0	68	7	75	9.3	1.3	1
1時間計	194	3	197	1.5	7.2	2	321	23	344	6.7	6.0	8

方向別自動車交通量調査表

調査地点 : 地域社会6 瀬谷中学校前

調査年月日 : 令和元年10月13日(日) 天候:曇りのち雨



時間帯	7						8					
	小型車 (台)	大型車 (台)	合計 (台)	大型車 混入率 (%)	時係 数 (%)	二輪車 (台)	小型車 (台)	大型車 (台)	合計 (台)	大型車 混入率 (%)	時係 数 (%)	二輪車 (台)
14:00-14:15	71	2	73	2.7	2.7	0	92	16	108	14.8	1.9	12
14:15-14:30	70	1	71	1.4	2.6	0	59	4	63	6.3	1.1	4
14:30-14:45	41	4	45	8.9	1.6	0	82	5	87	5.7	1.5	5
14:45-15:00	36	0	36	0.0	1.3	0	55	6	61	9.8	1.1	0
1時間計	218	7	225	3.1	8.2	0	288	31	319	9.7	5.6	21
15:00-15:15	39	0	39	0.0	1.4	0	74	9	83	10.8	1.5	2
15:15-15:30	57	5	62	8.1	2.3	0	74	7	81	8.6	1.4	4
15:30-15:45	49	1	50	2.0	1.8	3	75	4	79	5.1	1.4	2
15:45-16:00	48	1	49	2.0	1.8	1	85	2	87	2.3	1.5	0
1時間計	193	7	200	3.5	7.3	4	308	22	330	6.7	5.8	8
16:00-16:15	32	1	33	3.0	1.2	0	67	7	74	9.5	1.3	4
16:15-16:30	46	1	47	2.1	1.7	3	66	7	73	9.6	1.3	2
16:30-16:45	36	2	38	5.3	1.4	1	76	3	79	3.8	1.4	3
16:45-17:00	36	1	37	2.7	1.4	2	80	9	89	10.1	1.6	3
1時間計	150	5	155	3.2	5.7	6	289	26	315	8.3	5.5	12
17:00-17:15	52	2	54	3.7	2.0	0	81	5	86	5.8	1.5	2
17:15-17:30	35	1	36	2.8	1.3	0	78	7	85	8.2	1.5	4
17:30-17:45	34	1	35	2.9	1.3	2	73	4	77	5.2	1.4	3
17:45-18:00	38	2	40	5.0	1.5	0	75	3	78	3.8	1.4	3
1時間計	159	6	165	3.6	6.0	2	307	19	326	5.8	5.7	12
18:00-18:15	32	0	32	0.0	1.2	2	76	1	77	1.3	1.4	4
18:15-18:30	46	1	47	2.1	1.7	5	87	8	95	8.4	1.7	4
18:30-18:45	47	1	48	2.1	1.8	0	78	5	83	6.0	1.5	4
18:45-19:00	40	0	40	0.0	1.5	3	76	8	84	9.5	1.5	5
1時間計	165	2	167	1.2	6.1	10	317	22	339	6.5	5.9	17
19:00-19:15	41	0	41	0.0	1.5	1	68	10	78	12.8	1.4	2
19:15-19:30	22	1	23	4.3	0.8	2	47	8	55	14.5	1.0	4
19:30-19:45	18	1	19	5.3	0.7	4	75	4	79	5.1	1.4	2
19:45-20:00	30	2	32	6.3	1.2	6	59	11	70	15.7	1.2	3
1時間計	111	4	115	3.5	4.2	13	249	33	282	11.7	4.9	11
20:00-20:15	42	0	42	0.0	1.5	4	71	2	73	2.7	1.3	4
20:15-20:30	27	0	27	0.0	1.0	1	77	4	81	4.9	1.4	7
20:30-20:45	29	0	29	0.0	1.1	3	45	2	47	4.3	0.8	1
20:45-21:00	20	1	21	4.8	0.8	3	59	1	60	1.7	1.1	3
1時間計	118	1	119	0.8	4.4	11	252	9	261	3.4	4.6	15
21:00-21:15	29	0	29	0.0	1.1	0	34	3	37	8.1	0.6	0
21:15-21:30	31	0	31	0.0	1.1	2	37	4	41	9.8	0.7	5
21:30-21:45	18	0	18	0.0	0.7	2	40	2	42	4.8	0.7	2
21:45-22:00	13	1	14	7.1	0.5	1	40	1	41	2.4	0.7	1
1時間計	91	1	92	1.1	3.4	5	151	10	161	6.2	2.8	8
昼12時間計	1996	72	2068	3.5	75.8	59	3744	323	4067	7.9	71.4	201
夜12時間計	637	23	660	3.5	24.2	50	1436	195	1631	12.0	28.6	121
全時間合計	2633	95	2728	3.5	100.0	109	5180	518	5698	9.1	100.0	322
昼夜率	1.32	1.32	1.32	-	-	1.85	1.38	1.60	1.40	-	-	1.60

方向別自動車交通量調査表

調査地点：地域社会6 瀬谷中学校前

調査年月日：令和元年10月13日(日) 天候：曇りのち雨



方向	9						C 合計 (7+ 8+ 9)					
	小型車 (台)	大型車 (台)	合計 (台)	大型車 混入率 (%)	時間 係数 (%)	二輪車 (台)	小型車 (台)	大型車 (台)	合計 (台)	大型車 混入率 (%)	時間 係数 (%)	二輪車 (台)
22:00-22:15	11	0	11	0.0	0.6	1	65	2	67	3.0	0.6	3
22:15-22:30	18	0	18	0.0	0.9	0	57	2	59	3.4	0.6	7
22:30-22:45	11	0	11	0.0	0.6	1	57	2	59	3.4	0.6	3
22:45-23:00	10	0	10	0.0	0.5	1	51	4	55	7.3	0.5	8
1時間計	50	0	50	0.0	2.5	3	230	10	240	4.2	2.3	21
23:00-23:15	12	0	12	0.0	0.6	0	56	2	58	3.4	0.6	5
23:15-23:30	14	0	14	0.0	0.7	1	44	2	46	4.3	0.4	6
23:30-23:45	5	0	5	0.0	0.3	2	37	2	39	5.1	0.4	4
23:45-24:00	6	0	6	0.0	0.3	0	30	1	31	3.2	0.3	2
1時間計	37	0	37	0.0	1.9	3	167	7	174	4.0	1.7	17
0:00- 0:15	7	0	7	0.0	0.4	0	39	3	42	7.1	0.4	3
0:15- 0:30	12	0	12	0.0	0.6	1	36	2	38	5.3	0.4	4
0:30- 0:45	2	0	2	0.0	0.1	1	20	1	21	4.8	0.2	5
0:45- 1:00	6	0	6	0.0	0.3	3	27	0	27	0.0	0.3	7
1時間計	27	0	27	0.0	1.4	5	122	6	128	4.7	1.2	19
1:00- 1:15	1	0	1	0.0	0.1	1	16	4	20	20.0	0.2	3
1:15- 1:30	3	0	3	0.0	0.2	0	13	2	15	13.3	0.1	1
1:30- 1:45	5	1	6	16.7	0.3	1	23	3	26	11.5	0.3	3
1:45- 2:00	2	0	2	0.0	0.1	0	17	7	24	29.2	0.2	1
1時間計	11	1	12	8.3	0.6	2	69	16	85	18.8	0.8	8
2:00- 2:15	3	0	3	0.0	0.2	0	16	5	21	23.8	0.2	1
2:15- 2:30	2	0	2	0.0	0.1	0	13	6	19	31.6	0.2	0
2:30- 2:45	2	0	2	0.0	0.1	0	13	1	14	7.1	0.1	3
2:45- 3:00	2	0	2	0.0	0.1	0	14	4	18	22.2	0.2	1
1時間計	9	0	9	0.0	0.5	0	56	16	72	22.2	0.7	5
3:00- 3:15	1	1	2	50.0	0.1	1	13	2	15	13.3	0.1	1
3:15- 3:30	0	0	0	0.0	0.0	1	12	4	16	25.0	0.2	1
3:30- 3:45	0	1	1	100.0	0.1	0	12	4	16	25.0	0.2	0
3:45- 4:00	2	0	2	0.0	0.1	0	12	2	14	14.3	0.1	0
1時間計	3	2	5	40.0	0.3	2	49	12	61	19.7	0.6	2
4:00- 4:15	1	1	2	50.0	0.1	0	13	9	22	40.9	0.2	1
4:15- 4:30	0	0	0	0.0	0.0	0	15	6	21	28.6	0.2	1
4:30- 4:45	5	0	5	0.0	0.3	0	18	2	20	10.0	0.2	3
4:45- 5:00	1	0	1	0.0	0.1	0	22	6	28	21.4	0.3	3
1時間計	7	1	8	12.5	0.4	0	68	23	91	25.3	0.9	8
5:00- 5:15	7	2	9	22.2	0.5	0	38	24	62	38.7	0.6	2
5:15- 5:30	8	1	9	11.1	0.5	0	45	7	52	13.5	0.5	3
5:30- 5:45	4	1	5	20.0	0.3	0	41	9	50	18.0	0.5	7
5:45- 6:00	8	0	8	0.0	0.4	0	57	5	62	8.1	0.6	3
1時間計	27	4	31	12.9	1.6	0	181	45	226	19.9	2.2	15

方向別自動車交通量調査表

調査地点：地域社会6 瀬谷中学校前

調査年月日：令和元年10月13日(日) 天候：曇りのち雨



方向 時間帯	9						C 合計 (7+ 8+ 9)					
	小型車 (台)	大型車 (台)	合計 (台)	大型車 混入率 (%)	時間 係数 (%)	二輪車 (台)	小型車 (台)	大型車 (台)	合計 (台)	大型車 混入率 (%)	時間 係数 (%)	二輪車 (台)
6:00-6:15	5	0	5	0.0	0.3	0	71	7	78	9.0	0.8	7
6:15-6:30	5	0	5	0.0	0.3	0	91	8	99	8.1	1.0	13
6:30-6:45	10	0	10	0.0	0.5	0	94	12	106	11.3	1.0	5
6:45-7:00	9	2	11	18.2	0.6	1	103	8	111	7.2	1.1	4
1時間計	29	2	31	6.5	1.6	1	359	35	394	8.9	3.8	29
7:00-7:15	13	1	14	7.1	0.7	0	117	7	124	5.6	1.2	8
7:15-7:30	15	2	17	11.8	0.9	0	135	15	150	10.0	1.4	8
7:30-7:45	16	2	18	11.1	0.9	2	122	18	140	12.9	1.3	17
7:45-8:00	8	1	9	11.1	0.5	1	127	10	137	7.3	1.3	9
1時間計	52	6	58	10.3	3.0	3	501	50	551	9.1	5.3	42
8:00-8:15	19	2	21	9.5	1.1	1	171	8	179	4.5	1.7	15
8:15-8:30	28	0	28	0.0	1.4	0	164	6	170	3.5	1.6	17
8:30-8:45	32	1	33	3.0	1.7	1	158	14	172	8.1	1.7	9
8:45-9:00	37	2	39	5.1	2.0	3	168	8	176	4.5	1.7	9
1時間計	116	5	121	4.1	6.2	5	661	36	697	5.2	6.7	50
9:00-9:15	26	1	27	3.7	1.4	1	182	13	195	6.7	1.9	11
9:15-9:30	27	2	29	6.9	1.5	1	111	10	121	8.3	1.2	13
9:30-9:45	31	2	33	6.1	1.7	2	158	10	168	6.0	1.6	9
9:45-10:00	27	1	28	3.6	1.4	0	149	8	157	5.1	1.5	3
1時間計	111	6	117	5.1	6.0	4	600	41	641	6.4	6.2	36
10:00-10:15	25	2	27	7.4	1.4	0	121	13	134	9.7	1.3	7
10:15-10:30	33	1	34	2.9	1.7	1	132	6	138	4.3	1.3	2
10:30-10:45	30	2	32	6.3	1.6	1	142	16	158	10.1	1.5	5
10:45-11:00	28	2	30	6.7	1.5	0	152	6	158	3.8	1.5	1
1時間計	116	7	123	5.7	6.3	2	547	41	588	7.0	5.7	15
11:00-11:15	25	1	26	3.8	1.3	1	143	12	155	7.7	1.5	5
11:15-11:30	28	1	29	3.4	1.5	1	148	13	161	8.1	1.5	4
11:30-11:45	33	1	34	2.9	1.7	1	153	11	164	6.7	1.6	3
11:45-12:00	33	2	35	5.7	1.8	0	139	8	147	5.4	1.4	3
1時間計	119	5	124	4.0	6.3	3	583	44	627	7.0	6.0	15
12:00-12:15	34	2	36	5.6	1.8	1	135	13	148	8.8	1.4	6
12:15-12:30	24	2	26	7.7	1.3	0	129	10	139	7.2	1.3	3
12:30-12:45	25	2	27	7.4	1.4	0	142	15	157	9.6	1.5	6
12:45-13:00	32	0	32	0.0	1.6	1	162	7	169	4.1	1.6	4
1時間計	115	6	121	5.0	6.2	2	568	45	613	7.3	5.9	19
13:00-13:15	25	0	25	0.0	1.3	2	156	6	162	3.7	1.6	7
13:15-13:30	28	1	29	3.4	1.5	1	160	6	166	3.6	1.6	5
13:30-13:45	46	0	46	0.0	2.3	1	175	6	181	3.3	1.7	1
13:45-14:00	23	1	24	4.2	1.2	1	146	10	156	6.4	1.5	2
1時間計	122	2	124	1.6	6.3	5	637	28	665	4.2	6.4	15

方向別自動車交通量調査表

調査地点：地域社会6 瀬谷中学校前

調査年月日：令和元年10月13日(日) 天候：曇りのち雨



方向	9						C 合計 (7+ 8+ 9)					
	小型車 (台)	大型車 (台)	合計 (台)	大型車 混入率 (%)	時間 係数 (%)	二輪車 (台)	小型車 (台)	大型車 (台)	合計 (台)	大型車 混入率 (%)	時間 係数 (%)	二輪車 (台)
14:00-14:15	42	1	43	2.3	2.2	1	205	19	224	8.5	2.2	13
14:15-14:30	42	0	42	0.0	2.1	1	171	5	176	2.8	1.7	5
14:30-14:45	48	1	49	2.0	2.5	0	171	10	181	5.5	1.7	5
14:45-15:00	42	0	42	0.0	2.1	0	133	6	139	4.3	1.3	0
1時間計	174	2	176	1.1	9.0	2	680	40	720	5.6	6.9	23
15:00-15:15	42	2	44	4.5	2.2	1	155	11	166	6.6	1.6	3
15:15-15:30	29	4	33	12.1	1.7	0	160	16	176	9.1	1.7	4
15:30-15:45	35	1	36	2.8	1.8	0	159	6	165	3.6	1.6	5
15:45-16:00	41	1	42	2.4	2.1	0	174	4	178	2.2	1.7	1
1時間計	147	8	155	5.2	7.9	1	648	37	685	5.4	6.6	13
16:00-16:15	24	0	24	0.0	1.2	0	123	8	131	6.1	1.3	4
16:15-16:30	28	2	30	6.7	1.5	0	140	10	150	6.7	1.4	5
16:30-16:45	34	1	35	2.9	1.8	1	146	6	152	3.9	1.5	5
16:45-17:00	34	1	35	2.9	1.8	0	150	11	161	6.8	1.5	5
1時間計	120	4	124	3.2	6.3	1	559	35	594	5.9	5.7	19
17:00-17:15	33	1	34	2.9	1.7	1	166	8	174	4.6	1.7	3
17:15-17:30	36	1	37	2.7	1.9	1	149	9	158	5.7	1.5	5
17:30-17:45	39	1	40	2.5	2.0	1	146	6	152	3.9	1.5	6
17:45-18:00	27	0	27	0.0	1.4	1	140	5	145	3.4	1.4	4
1時間計	135	3	138	2.2	7.0	4	601	28	629	4.5	6.1	18
18:00-18:15	18	0	18	0.0	0.9	2	126	1	127	0.8	1.2	8
18:15-18:30	28	1	29	3.4	1.5	1	161	10	171	5.8	1.6	10
18:30-18:45	36	1	37	2.7	1.9	0	161	7	168	4.2	1.6	4
18:45-19:00	19	2	21	9.5	1.1	3	135	10	145	6.9	1.4	11
1時間計	101	4	105	3.8	5.4	6	583	28	611	4.6	5.9	33
19:00-19:15	29	0	29	0.0	1.5	3	138	10	148	6.8	1.4	6
19:15-19:30	28	1	29	3.4	1.5	2	97	10	107	9.3	1.0	8
19:30-19:45	32	1	33	3.0	1.7	4	125	6	131	4.6	1.3	10
19:45-20:00	28	2	30	6.7	1.5	4	117	15	132	11.4	1.3	13
1時間計	117	4	121	3.3	6.2	13	477	41	518	7.9	5.0	37
20:00-20:15	20	0	20	0.0	1.0	0	133	2	135	1.5	1.3	8
20:15-20:30	18	3	21	14.3	1.1	0	122	7	129	5.4	1.2	8
20:30-20:45	25	1	26	3.8	1.3	0	99	3	102	2.9	1.0	4
20:45-21:00	25	0	25	0.0	1.3	1	104	2	106	1.9	1.0	7
1時間計	88	4	92	4.3	4.7	1	458	14	472	3.0	4.5	27
21:00-21:15	22	0	22	0.0	1.1	0	85	3	88	3.4	0.8	0
21:15-21:30	14	0	14	0.0	0.7	2	82	4	86	4.7	0.8	9
21:30-21:45	9	0	9	0.0	0.5	3	67	2	69	2.9	0.7	7
21:45-22:00	8	0	8	0.0	0.4	1	61	2	63	3.2	0.6	3
1時間計	53	0	53	0.0	2.7	6	295	11	306	3.6	2.9	19
昼12時間計	1428	58	1486	3.9	75.7	38	7168	453	7621	5.9	73.4	298
夜12時間計	458	18	476	3.8	24.3	36	2531	236	2767	8.5	26.6	207
全時間合計	1886	76	1962	3.9	100.0	74	9699	689	10388	6.6	100.0	505
昼夜率	1.32	1.31	1.32	-	-	1.95	1.35	1.52	1.36	-	-	1.69

方向別自動車交通量調査表

調査地点 : 地域社会6 瀬谷中学校前

調査年月日 : 令和元年10月13日(日) 天候:曇りのち雨



方向 種別 時間帯	10						11					
	小型車 (台)	大型車 (台)	合 計 (台)	大型車 混入率 (%)	時 間 係 数 (%)	二輪車 (台)	小型車 (台)	大型車 (台)	合 計 (台)	大型車 混入率 (%)	時 間 係 数 (%)	二輪車 (台)
22:00-22:15	15	0	15	0.0	0.8	2	25	1	26	3.8	0.8	4
22:15-22:30	11	0	11	0.0	0.6	0	34	0	34	0.0	1.0	2
22:30-22:45	12	0	12	0.0	0.7	0	16	0	16	0.0	0.5	1
22:45-23:00	11	0	11	0.0	0.6	2	24	0	24	0.0	0.7	3
1時間計	49	0	49	0.0	2.8	4	99	1	100	1.0	2.9	10
23:00-23:15	11	1	12	8.3	0.7	0	20	1	21	4.8	0.6	2
23:15-23:30	7	0	7	0.0	0.4	0	12	0	12	0.0	0.4	0
23:30-23:45	2	0	2	0.0	0.1	1	9	0	9	0.0	0.3	1
23:45-24:00	5	0	5	0.0	0.3	0	7	0	7	0.0	0.2	1
1時間計	25	1	26	3.8	1.5	1	48	1	49	2.0	1.4	4
0:00- 0:15	6	0	6	0.0	0.3	1	11	0	11	0.0	0.3	2
0:15- 0:30	9	0	9	0.0	0.5	0	8	0	8	0.0	0.2	0
0:30- 0:45	11	0	11	0.0	0.6	0	10	0	10	0.0	0.3	2
0:45- 1:00	5	1	6	16.7	0.3	0	8	2	10	20.0	0.3	1
1時間計	31	1	32	3.1	1.8	1	37	2	39	5.1	1.1	5
1:00- 1:15	3	0	3	0.0	0.2	0	4	1	5	20.0	0.1	0
1:15- 1:30	2	0	2	0.0	0.1	0	3	0	3	0.0	0.1	3
1:30- 1:45	4	0	4	0.0	0.2	1	4	0	4	0.0	0.1	0
1:45- 2:00	1	0	1	0.0	0.1	0	3	0	3	0.0	0.1	0
1時間計	10	0	10	0.0	0.6	1	14	1	15	6.7	0.4	3
2:00- 2:15	2	1	3	33.3	0.2	0	3	1	4	25.0	0.1	0
2:15- 2:30	0	1	1	100.0	0.1	0	2	0	2	0.0	0.1	0
2:30- 2:45	0	2	2	100.0	0.1	0	8	0	8	0.0	0.2	0
2:45- 3:00	3	0	3	0.0	0.2	1	2	0	2	0.0	0.1	1
1時間計	5	4	9	44.4	0.5	1	15	1	16	6.3	0.5	1
3:00- 3:15	0	1	1	100.0	0.1	0	5	0	5	0.0	0.1	2
3:15- 3:30	1	1	2	50.0	0.1	0	0	1	1	100.0	0.0	1
3:30- 3:45	0	0	0	0.0	0.0	0	2	0	2	0.0	0.1	1
3:45- 4:00	0	1	1	100.0	0.1	1	8	0	8	0.0	0.2	1
1時間計	1	3	4	75.0	0.2	1	15	1	16	6.3	0.5	5
4:00- 4:15	0	2	2	100.0	0.1	2	2	0	2	0.0	0.1	2
4:15- 4:30	2	0	2	0.0	0.1	0	1	0	1	0.0	0.0	0
4:30- 4:45	0	0	0	0.0	0.0	0	4	0	4	0.0	0.1	1
4:45- 5:00	3	0	3	0.0	0.2	0	6	0	6	0.0	0.2	1
1時間計	5	2	7	28.6	0.4	2	13	0	13	0.0	0.4	4
5:00- 5:15	2	0	2	0.0	0.1	1	13	0	13	0.0	0.4	0
5:15- 5:30	4	1	5	20.0	0.3	0	15	0	15	0.0	0.4	1
5:30- 5:45	4	1	5	20.0	0.3	0	11	1	12	8.3	0.4	2
5:45- 6:00	7	0	7	0.0	0.4	0	13	2	15	13.3	0.4	1
1時間計	17	2	19	10.5	1.1	1	52	3	55	5.5	1.6	4

方向別自動車交通量調査表

調査地点：地域社会6 瀬谷中学校前

調査年月日：令和元年10月13日(日) 天候：曇りのち雨



方向 時間帯	10						11					
	種別 小型車 (台)	大型車 (台)	合計 (台)	大型車 混入率 (%)	時間 係数 (%)	二輪車 (台)	小型車 (台)	大型車 (台)	合計 (台)	大型車 混入率 (%)	時間 係数 (%)	二輪車 (台)
6:00-6:15	6	0	6	0.0	0.3	0	19	1	20	5.0	0.6	2
6:15-6:30	10	0	10	0.0	0.6	0	14	0	14	0.0	0.4	4
6:30-6:45	14	1	15	6.7	0.8	1	25	1	26	3.8	0.8	2
6:45-7:00	8	1	9	11.1	0.5	2	27	2	29	6.9	0.9	1
1時間計	38	2	40	5.0	2.3	3	85	4	89	4.5	2.6	9
7:00-7:15	11	1	12	8.3	0.7	0	42	1	43	2.3	1.3	3
7:15-7:30	16	1	17	5.9	1.0	0	36	4	40	10.0	1.2	3
7:30-7:45	15	0	15	0.0	0.8	0	45	2	47	4.3	1.4	3
7:45-8:00	17	2	19	10.5	1.1	0	25	1	26	3.8	0.8	2
1時間計	59	4	63	6.3	3.6	0	148	8	156	5.1	4.6	11
8:00-8:15	17	1	18	5.6	1.0	0	33	2	35	5.7	1.0	4
8:15-8:30	22	3	25	12.0	1.4	1	28	1	29	3.4	0.9	1
8:30-8:45	29	1	30	3.3	1.7	0	27	5	32	15.6	0.9	1
8:45-9:00	10	3	13	23.1	0.7	1	49	2	51	3.9	1.5	3
1時間計	78	8	86	9.3	4.9	2	137	10	147	6.8	4.3	9
9:00-9:15	28	2	30	6.7	1.7	0	45	1	46	2.2	1.4	1
9:15-9:30	23	0	23	0.0	1.3	0	43	2	45	4.4	1.3	3
9:30-9:45	33	1	34	2.9	1.9	1	47	1	48	2.1	1.4	3
9:45-10:00	32	2	34	5.9	1.9	2	49	2	51	3.9	1.5	3
1時間計	116	5	121	4.1	6.9	3	184	6	190	3.2	5.6	10
10:00-10:15	32	0	32	0.0	1.8	0	43	2	45	4.4	1.3	0
10:15-10:30	31	1	32	3.1	1.8	1	56	4	60	6.7	1.8	1
10:30-10:45	36	1	37	2.7	2.1	1	52	3	55	5.5	1.6	1
10:45-11:00	29	1	30	3.3	1.7	1	57	2	59	3.4	1.7	1
1時間計	128	3	131	2.3	7.4	3	208	11	219	5.0	6.4	3
11:00-11:15	33	0	33	0.0	1.9	0	93	1	94	1.1	2.8	2
11:15-11:30	41	0	41	0.0	2.3	1	49	2	51	3.9	1.5	3
11:30-11:45	29	1	30	3.3	1.7	0	79	1	80	1.3	2.4	4
11:45-12:00	37	2	39	5.1	2.2	1	62	2	64	3.1	1.9	0
1時間計	140	3	143	2.1	8.1	2	283	6	289	2.1	8.5	9
12:00-12:15	33	1	34	2.9	1.9	0	62	4	66	6.1	1.9	1
12:15-12:30	37	2	39	5.1	2.2	0	54	1	55	1.8	1.6	4
12:30-12:45	27	1	28	3.6	1.6	0	56	3	59	5.1	1.7	2
12:45-13:00	26	1	27	3.7	1.5	1	68	1	69	1.4	2.0	2
1時間計	123	5	128	3.9	7.3	1	240	9	249	3.6	7.3	9
13:00-13:15	23	0	23	0.0	1.3	0	50	1	51	2.0	1.5	1
13:15-13:30	26	3	29	10.3	1.6	0	52	2	54	3.7	1.6	2
13:30-13:45	30	2	32	6.3	1.8	0	42	6	48	12.5	1.4	3
13:45-14:00	30	0	30	0.0	1.7	1	58	2	60	3.3	1.8	0
1時間計	109	5	114	4.4	6.5	1	202	11	213	5.2	6.3	6

方向別自動車交通量調査表

調査地点：地域社会6 瀬谷中学校前

調査年月日：令和元年10月13日(日) 天候：曇りのち雨



方向	10						11						
	種別	小型車 (台)	大型車 (台)	合計 (台)	大型車 混入率 (%)	時係 数 (%)	二輪車 (台)	種別	小型車 (台)	大型車 (台)	合計 (台)	大型車 混入率 (%)	時係 数 (%)
14:00-14:15		28	1	29	3.4	1.6	0	65	1	66	1.5	1.9	1
14:15-14:30		26	0	26	0.0	1.5	0	51	3	54	5.6	1.6	3
14:30-14:45		32	1	33	3.0	1.9	0	52	4	56	7.1	1.6	1
14:45-15:00		35	2	37	5.4	2.1	1	50	3	53	5.7	1.6	0
1時間計		121	4	125	3.2	7.1	1	218	11	229	4.8	6.7	5
15:00-15:15		24	1	25	4.0	1.4	1	46	0	46	0.0	1.4	0
15:15-15:30		27	0	27	0.0	1.5	1	69	3	72	4.2	2.1	3
15:30-15:45		35	0	35	0.0	2.0	0	58	4	62	6.5	1.8	2
15:45-16:00		24	0	24	0.0	1.4	1	62	3	65	4.6	1.9	1
1時間計		110	1	111	0.9	6.3	3	235	10	245	4.1	7.2	6
16:00-16:15		28	2	30	6.7	1.7	1	55	4	59	6.8	1.7	2
16:15-16:30		32	0	32	0.0	1.8	0	57	3	60	5.0	1.8	3
16:30-16:45		46	1	47	2.1	2.7	1	48	3	51	5.9	1.5	1
16:45-17:00		28	0	28	0.0	1.6	1	49	1	50	2.0	1.5	0
1時間計		134	3	137	2.2	7.8	3	209	11	220	5.0	6.5	6
17:00-17:15		26	1	27	3.7	1.5	0	69	1	70	1.4	2.1	0
17:15-17:30		37	0	37	0.0	2.1	0	59	3	62	4.8	1.8	3
17:30-17:45		26	0	26	0.0	1.5	0	63	4	67	6.0	2.0	2
17:45-18:00		25	1	26	3.8	1.5	1	40	4	44	9.1	1.3	1
1時間計		114	2	116	1.7	6.6	1	231	12	243	4.9	7.1	6
18:00-18:15		37	0	37	0.0	2.1	0	58	3	61	4.9	1.8	2
18:15-18:30		17	1	18	5.6	1.0	0	49	1	50	2.0	1.5	0
18:30-18:45		17	0	17	0.0	1.0	0	46	3	49	6.1	1.4	3
18:45-19:00		32	1	33	3.0	1.9	0	37	1	38	2.6	1.1	3
1時間計		103	2	105	1.9	5.9	0	190	8	198	4.0	5.8	8
19:00-19:15		25	2	27	7.4	1.5	0	55	2	57	3.5	1.7	0
19:15-19:30		11	0	11	0.0	0.6	0	35	2	37	5.4	1.1	3
19:30-19:45		35	1	36	2.8	2.0	0	39	4	43	9.3	1.3	1
19:45-20:00		16	1	17	5.9	1.0	0	44	2	46	4.3	1.4	1
1時間計		87	4	91	4.4	5.2	0	173	10	183	5.5	5.4	5
20:00-20:15		21	0	21	0.0	1.2	1	27	0	27	0.0	0.8	0
20:15-20:30		14	1	15	6.7	0.8	0	27	1	28	3.6	0.8	2
20:30-20:45		12	0	12	0.0	0.7	1	44	3	47	6.4	1.4	3
20:45-21:00		13	1	14	7.1	0.8	0	22	2	24	8.3	0.7	1
1時間計		60	2	62	3.2	3.5	2	120	6	126	4.8	3.7	6
21:00-21:15		6	2	8	25.0	0.5	0	31	1	32	3.1	0.9	0
21:15-21:30		9	0	9	0.0	0.5	0	30	0	30	0.0	0.9	1
21:30-21:45		8	1	9	11.1	0.5	0	20	2	22	9.1	0.6	2
21:45-22:00		10	0	10	0.0	0.6	0	21	0	21	0.0	0.6	3
1時間計		33	3	36	8.3	2.0	0	102	3	105	2.9	3.1	6
昼12時間計		1335	45	1380	3.3	78.2	20	2485	113	2598	4.3	76.3	88
夜12時間計		361	24	385	6.2	21.8	17	773	33	806	4.1	23.7	62
全時間合計		1696	69	1765	3.9	100.0	37	3258	146	3404	4.3	100.0	150
昼夜率		1.27	1.53	1.28	-	-	1.85	1.31	1.29	1.31	-	-	1.70

方向別自動車交通量調査表

調査地点 : 地域社会6 瀬谷中学校前

調査年月日 : 令和元年10月13日(日) 天候:曇りのち雨



方向	12						D 合計 (10+11+12)					
	小型車 (台)	大型車 (台)	合計 (台)	大型車 混入率 (%)	時間 係数 (%)	二輪車 (台)	小型車 (台)	大型車 (台)	合計 (台)	大型車 混入率 (%)	時間 係数 (%)	二輪車 (台)
22:00-22:15	11	0	11	0.0	0.7	0	51	1	52	1.9	0.8	6
22:15-22:30	8	1	9	11.1	0.5	4	53	1	54	1.9	0.8	6
22:30-22:45	9	0	9	0.0	0.5	1	37	0	37	0.0	0.5	2
22:45-23:00	5	0	5	0.0	0.3	0	40	0	40	0.0	0.6	5
1時間計	33	1	34	2.9	2.1	5	181	2	183	1.1	2.7	19
23:00-23:15	3	0	3	0.0	0.2	0	34	2	36	5.6	0.5	2
23:15-23:30	5	0	5	0.0	0.3	1	24	0	24	0.0	0.4	1
23:30-23:45	7	1	8	12.5	0.5	0	18	1	19	5.3	0.3	2
23:45-24:00	6	0	6	0.0	0.4	1	18	0	18	0.0	0.3	2
1時間計	21	1	22	4.5	1.3	2	94	3	97	3.1	1.4	7
0:00- 0:15	4	0	4	0.0	0.2	0	21	0	21	0.0	0.3	3
0:15- 0:30	4	0	4	0.0	0.2	0	21	0	21	0.0	0.3	0
0:30- 0:45	3	0	3	0.0	0.2	0	24	0	24	0.0	0.4	2
0:45- 1:00	4	0	4	0.0	0.2	2	17	3	20	15.0	0.3	3
1時間計	15	0	15	0.0	0.9	2	83	3	86	3.5	1.3	8
1:00- 1:15	5	0	5	0.0	0.3	1	12	1	13	7.7	0.2	1
1:15- 1:30	2	1	3	33.3	0.2	0	7	1	8	12.5	0.1	3
1:30- 1:45	0	0	0	0.0	0.0	1	8	0	8	0.0	0.1	2
1:45- 2:00	1	0	1	0.0	0.1	1	5	0	5	0.0	0.1	1
1時間計	8	1	9	11.1	0.5	3	32	2	34	5.9	0.5	7
2:00- 2:15	2	0	2	0.0	0.1	0	7	2	9	22.2	0.1	0
2:15- 2:30	2	1	3	33.3	0.2	0	4	2	6	33.3	0.1	0
2:30- 2:45	0	0	0	0.0	0.0	1	8	2	10	20.0	0.1	1
2:45- 3:00	1	0	1	0.0	0.1	0	6	0	6	0.0	0.1	2
1時間計	5	1	6	16.7	0.4	1	25	6	31	19.4	0.5	3
3:00- 3:15	1	0	1	0.0	0.1	0	6	1	7	14.3	0.1	2
3:15- 3:30	1	0	1	0.0	0.1	1	2	2	4	50.0	0.1	2
3:30- 3:45	0	0	0	0.0	0.0	0	2	0	2	0.0	0.0	1
3:45- 4:00	2	0	2	0.0	0.1	0	10	1	11	9.1	0.2	2
1時間計	4	0	4	0.0	0.2	1	20	4	24	16.7	0.4	7
4:00- 4:15	2	0	2	0.0	0.1	0	4	2	6	33.3	0.1	4
4:15- 4:30	2	1	3	33.3	0.2	1	5	1	6	16.7	0.1	1
4:30- 4:45	1	0	1	0.0	0.1	0	5	0	5	0.0	0.1	1
4:45- 5:00	3	0	3	0.0	0.2	0	12	0	12	0.0	0.2	1
1時間計	8	1	9	11.1	0.5	1	26	3	29	10.3	0.4	7
5:00- 5:15	3	0	3	0.0	0.2	0	18	0	18	0.0	0.3	1
5:15- 5:30	5	1	6	16.7	0.4	0	24	2	26	7.7	0.4	1
5:30- 5:45	9	0	9	0.0	0.5	0	24	2	26	7.7	0.4	2
5:45- 6:00	6	1	7	14.3	0.4	0	26	3	29	10.3	0.4	1
1時間計	23	2	25	8.0	1.5	0	92	7	99	7.1	1.5	5

方向別自動車交通量調査表

調査地点：地域社会6 瀬谷中学校前

調査年月日：令和元年10月13日(日) 天候：曇りのち雨



方向	12						D 合計 (10+11+12)						
	種別	小型車 (台)	大型車 (台)	合計 (台)	大型車混入率 (%)	時間係数 (%)	二輪車 (台)	小型車 (台)	大型車 (台)	合計 (台)	大型車混入率 (%)	時間係数 (%)	二輪車 (台)
6:00-6:15		8	0	8	0.0	0.5	0	33	1	34	2.9	0.5	2
6:15-6:30		6	1	7	14.3	0.4	0	30	1	31	3.2	0.5	4
6:30-6:45		11	0	11	0.0	0.7	1	50	2	52	3.8	0.8	4
6:45-7:00		9	1	10	10.0	0.6	0	44	4	48	8.3	0.7	3
1時間計		34	2	36	5.6	2.2	1	157	8	165	4.8	2.4	13
7:00-7:15		17	3	20	15.0	1.2	1	70	5	75	6.7	1.1	4
7:15-7:30		20	0	20	0.0	1.2	0	72	5	77	6.5	1.1	3
7:30-7:45		14	0	14	0.0	0.9	1	74	2	76	2.6	1.1	4
7:45-8:00		20	1	21	4.8	1.3	1	62	4	66	6.1	1.0	3
1時間計		71	4	75	5.3	4.6	3	278	16	294	5.4	4.3	14
8:00-8:15		22	0	22	0.0	1.3	0	72	3	75	4.0	1.1	4
8:15-8:30		21	5	26	19.2	1.6	3	71	9	80	11.3	1.2	5
8:30-8:45		14	2	16	12.5	1.0	1	70	8	78	10.3	1.1	2
8:45-9:00		22	0	22	0.0	1.3	0	81	5	86	5.8	1.3	4
1時間計		79	7	86	8.1	5.2	4	294	25	319	7.8	4.7	15
9:00-9:15		14	4	18	22.2	1.1	1	87	7	94	7.4	1.4	2
9:15-9:30		26	1	27	3.7	1.6	0	92	3	95	3.2	1.4	3
9:30-9:45		41	4	45	8.9	2.7	0	121	6	127	4.7	1.9	4
9:45-10:00		28	1	29	3.4	1.8	2	109	5	114	4.4	1.7	7
1時間計		109	10	119	8.4	7.3	3	409	21	430	4.9	6.3	16
10:00-10:15		20	0	20	0.0	1.2	3	95	2	97	2.1	1.4	3
10:15-10:30		34	1	35	2.9	2.1	1	121	6	127	4.7	1.9	3
10:30-10:45		32	0	32	0.0	2.0	1	120	4	124	3.2	1.8	3
10:45-11:00		31	1	32	3.1	2.0	1	117	4	121	3.3	1.8	3
1時間計		117	2	119	1.7	7.3	6	453	16	469	3.4	6.9	12
11:00-11:15		27	2	29	6.9	1.8	1	153	3	156	1.9	2.3	3
11:15-11:30		27	1	28	3.6	1.7	2	117	3	120	2.5	1.8	6
11:30-11:45		26	0	26	0.0	1.6	0	134	2	136	1.5	2.0	4
11:45-12:00		28	0	28	0.0	1.7	3	127	4	131	3.1	1.9	4
1時間計		108	3	111	2.7	6.8	6	531	12	543	2.2	8.0	17
12:00-12:15		40	2	42	4.8	2.6	0	135	7	142	4.9	2.1	1
12:15-12:30		25	1	26	3.8	1.6	1	116	4	120	3.3	1.8	5
12:30-12:45		40	2	42	4.8	2.6	1	123	6	129	4.7	1.9	3
12:45-13:00		32	2	34	5.9	2.1	1	126	4	130	3.1	1.9	4
1時間計		137	7	144	4.9	8.8	3	500	21	521	4.0	7.7	13
13:00-13:15		25	0	25	0.0	1.5	1	98	1	99	1.0	1.5	2
13:15-13:30		30	1	31	3.2	1.9	2	108	6	114	5.3	1.7	4
13:30-13:45		18	2	20	10.0	1.2	2	90	10	100	10.0	1.5	5
13:45-14:00		24	0	24	0.0	1.5	2	112	2	114	1.8	1.7	3
1時間計		97	3	100	3.0	6.1	7	408	19	427	4.4	6.3	14

方向別自動車交通量調査表

調査地点：地域社会6 瀬谷中学校前

調査年月日：令和元年10月13日(日) 天候：曇りのち雨



方向 種別 時間帯	12						D 合計 (10+11+12)					
	小型車 (台)	大型車 (台)	合計 (台)	大型車 混入率 (%)	時間 係数 (%)	二輪車 (台)	小型車 (台)	大型車 (台)	合計 (台)	大型車 混入率 (%)	時間 係数 (%)	二輪車 (台)
14:00-14:15	25	0	25	0.0	1.5	0	118	2	120	1.7	1.8	1
14:15-14:30	19	1	20	5.0	1.2	1	96	4	100	4.0	1.5	4
14:30-14:45	18	0	18	0.0	1.1	0	102	5	107	4.7	1.6	1
14:45-15:00	26	1	27	3.7	1.6	0	111	6	117	5.1	1.7	1
1時間計	88	2	90	2.2	5.5	1	427	17	444	3.8	6.5	7
15:00-15:15	27	0	27	0.0	1.6	0	97	1	98	1.0	1.4	1
15:15-15:30	29	1	30	3.3	1.8	1	125	4	129	3.1	1.9	5
15:30-15:45	31	1	32	3.1	2.0	1	124	5	129	3.9	1.9	3
15:45-16:00	32	0	32	0.0	2.0	2	118	3	121	2.5	1.8	4
1時間計	119	2	121	1.7	7.4	4	464	13	477	2.7	7.0	13
16:00-16:15	26	2	28	7.1	1.7	2	109	8	117	6.8	1.7	5
16:15-16:30	33	0	33	0.0	2.0	0	122	3	125	2.4	1.8	3
16:30-16:45	32	2	34	5.9	2.1	2	126	6	132	4.5	1.9	4
16:45-17:00	23	0	23	0.0	1.4	2	100	1	101	1.0	1.5	3
1時間計	114	4	118	3.4	7.2	6	457	18	475	3.8	7.0	15
17:00-17:15	30	2	32	6.3	2.0	0	125	4	129	3.1	1.9	0
17:15-17:30	27	0	27	0.0	1.6	0	123	3	126	2.4	1.9	3
17:30-17:45	35	2	37	5.4	2.3	3	124	6	130	4.6	1.9	5
17:45-18:00	27	2	29	6.9	1.8	1	92	7	99	7.1	1.5	3
1時間計	119	6	125	4.8	7.6	4	464	20	484	4.1	7.1	11
18:00-18:15	20	7	27	25.9	1.6	2	115	10	125	8.0	1.8	4
18:15-18:30	21	1	22	4.5	1.3	0	87	3	90	3.3	1.3	0
18:30-18:45	13	1	14	7.1	0.9	1	76	4	80	5.0	1.2	4
18:45-19:00	17	1	18	5.6	1.1	2	86	3	89	3.4	1.3	5
1時間計	71	10	81	12.3	4.9	5	364	20	384	5.2	5.6	13
19:00-19:15	32	0	32	0.0	2.0	0	112	4	116	3.4	1.7	0
19:15-19:30	19	1	20	5.0	1.2	0	65	3	68	4.4	1.0	3
19:30-19:45	18	0	18	0.0	1.1	0	92	5	97	5.2	1.4	1
19:45-20:00	20	0	20	0.0	1.2	1	80	3	83	3.6	1.2	2
1時間計	89	1	90	1.1	5.5	1	349	15	364	4.1	5.3	6
20:00-20:15	11	0	11	0.0	0.7	2	59	0	59	0.0	0.9	3
20:15-20:30	18	1	19	5.3	1.2	3	59	3	62	4.8	0.9	5
20:30-20:45	14	0	14	0.0	0.9	2	70	3	73	4.1	1.1	6
20:45-21:00	16	2	18	11.1	1.1	0	51	5	56	8.9	0.8	1
1時間計	59	3	62	4.8	3.8	7	239	11	250	4.4	3.7	15
21:00-21:15	8	1	9	11.1	0.5	0	45	4	49	8.2	0.7	0
21:15-21:30	6	1	7	14.3	0.4	0	45	1	46	2.2	0.7	1
21:30-21:45	14	1	15	6.7	0.9	0	42	4	46	8.7	0.7	2
21:45-22:00	8	1	9	11.1	0.5	0	39	1	40	2.5	0.6	3
1時間計	36	4	40	10.0	2.4	0	171	10	181	5.5	2.7	6
昼12時間計	1229	60	1289	4.7	78.5	52	5049	218	5267	4.1	77.3	160
夜12時間計	335	17	352	4.8	21.5	24	1469	74	1543	4.8	22.7	103
全時間合計	1564	77	1641	4.7	100.0	76	6518	292	6810	4.3	100.0	263
昼夜率	1.27	1.28	1.27	-	-	1.46	1.29	1.34	1.29	-	-	1.64

交差点合計自動車交通量調査表

調査地点 : 地域社会1 目黒

調査年月日 : 令和元年10月13日(日) 天候:曇りのち雨

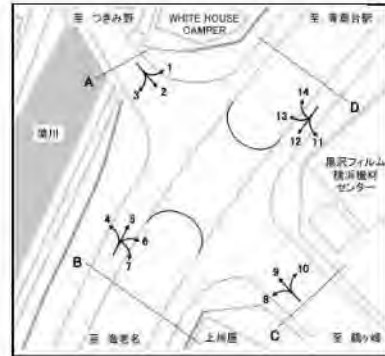

方向 時間帯	交差点合計(1+2+3+4+5+6+7+8+9+10+11+12+13+14)											
	種別 小型車 (台)	大型車 (台)	合計 (台)	大型車 混入率 (%)	時間 係数 (%)	二輪車 (台)	小型車 (台)	大型車 (台)	合計 (台)	大型車 混入率 (%)	時間 係数 (%)	二輪車 (台)
22:00-22:15	244	26	270	43.6	3.1	7						
22:15-22:30	270	28	298	48.4	3.3	17						
22:30-22:45	205	25	230	49.2	2.7	12						
22:45-23:00	199	33	232	54.3	2.8	14						
23:00-23:15	230	38	268	60.8	3.0	9						
23:15-23:30	146	33	179	71.9	2.1	13						
23:30-23:45	134	38	172	79.7	1.9	7						
23:45-24:00	149	26	175	60.2	2.1	9						
0:00-0:15	138	32	170	72.6	2.1	15						
0:15-0:30	100	35	135	93.0	1.6	3						
0:30-0:45	84	34	118	110.8	1.5	5						
0:45-1:00	89	39	128	108.1	1.5	7						
1:00-1:15	85	34	119	103.9	1.3	8						
1:15-1:30	62	48	110	174.2	1.4	5						
1:30-1:45	65	33	98	121.9	1.1	3						
1:45-2:00	84	33	117	101.0	1.3	1						
2:00-2:15	75	49	124	145.0	1.3	3						
2:15-2:30	67	43	110	164.7	1.2	2						
2:30-2:45	52	42	94	158.2	0.9	3						
2:45-3:00	72	43	115	152.2	1.3	7						
3:00-3:15	35	51	86	230.0	1.2	2						
3:15-3:30	40	36	76	176.4	1.0	5						
3:30-3:45	50	57	107	215.8	1.2	5						
3:45-4:00	62	55	117	202.5	1.2	2						
4:00-4:15	44	62	106	230.3	1.2	5						
4:15-4:30	69	66	135	190.4	1.7	8						
4:30-4:45	75	39	114	122.1	1.2	3						
4:45-5:00	75	44	119	149.4	1.5	5						
5:00-5:15	112	76	188	151.0	2.2	13						
5:15-5:30	117	63	180	156.9	2.1	12						
5:30-5:45	164	73	237	133.8	2.9	9						
5:45-6:00	217	60	277	80.9	3.4	5						
6:00-6:15	270	68	338	88.3	3.6	9						
6:15-6:30	241	70	311	89.4	3.6	16						
6:30-6:45	258	92	350	106.6	4.0	16						
6:45-7:00	318	101	419	98.1	4.7	28						
7:00-7:15	285	89	374	96.6	4.2	24						
7:15-7:30	351	98	449	88.8	4.8	22						
7:30-7:45	368	78	446	66.9	4.9	20						
7:45-8:00	322	99	421	90.5	4.7	20						
8:00-8:15	413	76	489	68.2	5.5	24						
8:15-8:30	328	94	422	90.0	4.6	21						
8:30-8:45	368	95	463	81.8	5.4	17						
8:45-9:00	345	61	406	60.6	4.5	19						
9:00-9:15	379	93	472	79.2	5.8	12						
9:15-9:30	326	99	425	88.0	4.9	12						
9:30-9:45	385	76	461	60.9	5.3	11						
9:45-10:00	402	78	480	72.8	5.3	9						

交 差 点 合 計 自 動 車 交 通 量 調 査 表

調査地点 : 地域社会1 目黒

調査年月日 : 令和元年10月13日(日) 天候:曇りのち雨

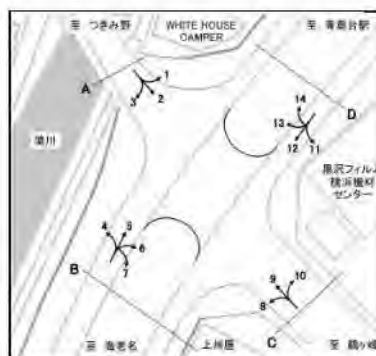

方向	交差点合計(1+2+3+4+5+6+7+8+9+10+11+12+13+14)												
	種別	小型車 (台)	大型車 (台)	合 計 (台)	大型車 混入率 (%)	時 間 係 数 (%)	二輪車 (台)	小型車 (台)	大型車 (台)	合 計 (台)	大型車 混入率 (%)	時 間 係 数 (%)	二輪車 (台)
10:00-10:15		419	106	525	83.6	6.3	6						
10:15-10:30		413	79	492	62.6	5.5	8						
10:30-10:45		448	85	533	60.9	6.0	8						
10:45-11:00		397	72	469	58.9	5.2	4						
11:00-11:15		438	77	515	57.1	5.9	6						
11:15-11:30		444	73	517	58.1	5.8	6						
11:30-11:45		458	93	551	64.1	6.3	5						
11:45-12:00		460	74	534	53.9	6.3	10						
12:00-12:15		509	83	592	55.0	7.1	3						
12:15-12:30		449	50	499	36.6	5.8	8						
12:30-12:45		473	84	557	62.0	6.7	15						
12:45-13:00		447	68	515	46.7	5.9	5						
13:00-13:15		451	84	535	59.6	6.2	4						
13:15-13:30		362	57	419	52.7	5.1	3						
13:30-13:45		453	82	535	60.4	6.2	6						
13:45-14:00		355	64	419	64.9	4.8	3						
14:00-14:15		459	68	527	50.8	6.1	8						
14:15-14:30		432	74	506	55.7	5.8	10						
14:30-14:45		502	58	560	39.9	6.2	7						
14:45-15:00		450	57	507	47.5	6.1	7						
15:00-15:15		504	78	582	50.9	6.8	10						
15:15-15:30		437	48	485	42.0	5.6	7						
15:30-15:45		402	62	464	49.2	5.6	7						
15:45-16:00		451	68	519	47.9	5.7	13						
16:00-16:15		463	65	528	50.0	6.1	11						
16:15-16:30		458	53	511	46.7	5.8	11						
16:30-16:45		453	33	486	33.6	5.5	13						
16:45-17:00		432	42	474	37.0	5.2	8						
17:00-17:15		468	47	515	40.1	5.8	8						
17:15-17:30		483	52	535	38.5	6.0	23						
17:30-17:45		467	40	507	33.1	5.5	23						
17:45-18:00		449	30	479	26.4	5.5	15						
18:00-18:15		548	47	595	32.9	6.6	22						
18:15-18:30		436	53	489	45.4	5.6	16						
18:30-18:45		538	57	595	40.6	6.4	10						
18:45-19:00		443	51	494	42.9	5.6	18						
19:00-19:15		490	41	531	35.6	6.0	8						
19:15-19:30		353	36	389	38.2	4.8	6						
19:30-19:45		383	58	441	55.9	5.2	16						
19:45-20:00		347	31	378	32.0	4.4	10						
20:00-20:15		377	50	427	50.7	5.1	9						
20:15-20:30		381	51	432	51.3	5.0	14						
20:30-20:45		290	53	343	59.5	4.2	5						
20:45-21:00		311	53	364	60.9	4.3	6						
21:00-21:15		420	57	477	52.6	4.9	8						
21:15-21:30		291	35	326	38.9	3.7	23						
21:30-21:45		238	33	271	48.1	3.1	7						
21:45-22:00		202	41	243	71.6	2.9	8						
全時間合計		29303	5614	34917	63.9	400.0	971						

交差点合計自動車交通量調査表

調査地点 : 地域社会2 目黒交番前

調査年月日 : 令和元年10月13日(日) 天候:曇りのち雨



方向 時間帯	交差点合計(1+2+3+4+5+6+7+8+9+10+11+12+13+14)											
	種別 小型車 (台)	大型車 (台)	合計 (台)	大型車 混入率 (%)	時間 係数 (%)	二輪車 (台)	小型車 (台)	大型車 (台)	合計 (台)	大型車 混入率 (%)	時間 係数 (%)	二輪車 (台)
22:00-22:15	253	25	278	28.3	2.8	18						
22:15-22:30	259	17	276	23.1	2.9	18						
22:30-22:45	225	35	260	58.6	2.7	7						
22:45-23:00	195	35	230	58.3	2.5	24						
23:00-23:15	183	45	228	70.5	2.4	18						
23:15-23:30	133	40	173	91.6	1.8	9						
23:30-23:45	143	30	173	65.9	2.1	10						
23:45-24:00	116	28	144	75.6	1.7	11						
0:00-0:15	136	24	160	56.3	1.7	12						
0:15-0:30	89	27	116	71.6	1.3	6						
0:30-0:45	87	39	126	107.1	1.4	9						
0:45-1:00	95	29	124	71.4	1.3	8						
1:00-1:15	80	32	112	98.8	1.3	9						
1:15-1:30	57	31	88	113.3	1.0	17						
1:30-1:45	83	47	130	121.3	1.5	6						
1:45-2:00	59	25	84	106.1	0.9	4						
2:00-2:15	64	28	92	107.1	1.0	5						
2:15-2:30	50	30	80	148.0	0.9	8						
2:30-2:45	44	39	83	151.2	1.0	2						
2:45-3:00	53	33	86	161.2	1.0	6						
3:00-3:15	45	36	81	130.2	0.8	5						
3:15-3:30	44	47	91	185.1	1.0	5						
3:30-3:45	56	48	104	137.7	1.1	8						
3:45-4:00	51	40	91	122.2	0.9	8						
4:00-4:15	65	53	118	147.2	1.3	1						
4:15-4:30	67	53	120	149.2	1.2	7						
4:30-4:45	78	43	121	122.3	1.2	7						
4:45-5:00	86	57	143	152.6	1.6	6						
5:00-5:15	96	63	159	140.2	1.8	14						
5:15-5:30	144	65	209	102.6	2.3	15						
5:30-5:45	165	72	237	104.5	2.5	13						
5:45-6:00	253	63	316	74.1	3.5	13						
6:00-6:15	298	55	353	59.8	3.9	11						
6:15-6:30	313	64	377	57.0	4.3	17						
6:30-6:45	404	120	524	79.4	5.8	31						
6:45-7:00	366	65	431	53.7	4.8	30						
7:00-7:15	324	63	387	57.9	4.5	23						
7:15-7:30	399	81	480	58.4	5.6	29						
7:30-7:45	370	82	452	64.2	5.2	36						
7:45-8:00	344	91	435	74.7	4.9	21						
8:00-8:15	450	96	546	64.8	6.6	32						
8:15-8:30	438	94	532	66.7	6.1	29						
8:30-8:45	412	98	510	70.5	6.1	22						
8:45-9:00	413	84	497	56.6	5.6	13						
9:00-9:15	375	89	464	70.7	5.4	20						
9:15-9:30	426	98	524	66.0	6.1	18						
9:30-9:45	407	87	494	62.7	5.6	15						
9:45-10:00	390	76	466	57.8	5.5	9						

交差点合計自動車交通量調査表

調査地点：地域社会2 目黒交番前

調査年月日：令和元年10月13日(日) 天候：曇りのち雨



方向 時間帯	交差点合計(1+2+3+4+5+6+7+8+9+10+11+12+13+14)											
	種別 小型車 (台)	大型車 (台)	合計 (台)	大型車 混入率 (%)	時間 係数 (%)	二輪車 (台)	小型車 (台)	大型車 (台)	合計 (台)	大型車 混入率 (%)	時間 係数 (%)	二輪車 (台)
10:00-10:15	395	88	483	67.6	5.5	10						
10:15-10:30	365	80	445	67.6	5.1	11						
10:30-10:45	395	101	496	73.3	5.8	10						
10:45-11:00	433	85	518	62.3	6.2	7						
11:00-11:15	488	81	569	55.1	6.7	6						
11:15-11:30	429	81	510	57.6	6.0	9						
11:30-11:45	438	90	528	66.6	6.3	15						
11:45-12:00	403	64	467	51.7	5.4	9						
12:00-12:15	432	75	507	52.9	5.6	10						
12:15-12:30	405	65	470	49.8	5.6	9						
12:30-12:45	427	69	496	49.5	5.8	8						
12:45-13:00	401	73	474	54.0	5.4	6						
13:00-13:15	396	79	475	58.7	5.4	5						
13:15-13:30	475	69	544	47.6	6.2	7						
13:30-13:45	468	72	540	49.5	6.2	7						
13:45-14:00	394	50	444	39.6	4.9	5						
14:00-14:15	435	68	503	48.2	5.6	13						
14:15-14:30	416	71	487	50.2	5.3	13						
14:30-14:45	461	63	524	42.9	6.0	9						
14:45-15:00	442	72	514	51.8	5.7	6						
15:00-15:15	436	56	492	42.7	5.9	11						
15:15-15:30	468	71	539	44.9	5.9	11						
15:30-15:45	402	70	472	55.7	5.6	7						
15:45-16:00	420	70	490	50.9	5.7	9						
16:00-16:15	511	88	599	54.8	6.9	18						
16:15-16:30	510	73	583	46.8	6.7	11						
16:30-16:45	490	65	555	44.0	6.3	13						
16:45-17:00	483	61	544	44.1	6.2	13						
17:00-17:15	541	55	596	34.2	6.9	24						
17:15-17:30	514	57	571	37.5	6.8	23						
17:30-17:45	572	63	635	35.5	7.0	26						
17:45-18:00	517	38	555	24.4	6.5	15						
18:00-18:15	537	41	578	25.7	6.6	29						
18:15-18:30	504	44	548	27.5	6.1	26						
18:30-18:45	518	51	569	31.5	6.2	18						
18:45-19:00	417	43	460	33.7	4.9	25						
19:00-19:15	442	41	483	29.8	5.3	17						
19:15-19:30	326	48	374	46.3	4.3	9						
19:30-19:45	403	47	450	38.1	5.0	14						
19:45-20:00	294	46	340	47.4	3.7	17						
20:00-20:15	375	38	413	34.8	4.7	14						
20:15-20:30	318	38	356	36.0	3.9	12						
20:30-20:45	378	38	416	26.7	4.5	9						
20:45-21:00	314	47	361	44.9	3.8	13						
21:00-21:15	310	53	363	49.8	3.6	13						
21:15-21:30	262	27	289	37.0	3.3	19						
21:30-21:45	226	34	260	41.8	2.7	17						
21:45-22:00	221	28	249	34.0	2.7	7						
全時間合計	29890	5549	35439	56.2	400.0	1280						

交差点合計自動車交通量調査表

調査地点：地域社会3 上川井IC

調査年月日：令和元年10月13日(日) 天候：曇りのち雨

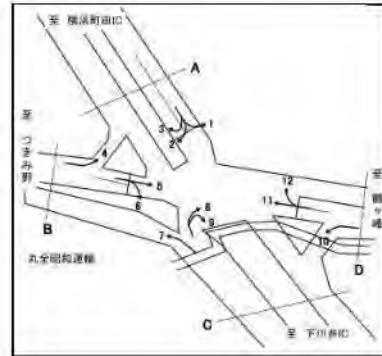

方向 種別	交差点合計(1+2+3+4+5+6+7+8+9+10+11+12)											
	小型車 (台)	大型車 (台)	合計 (台)	大型車 混入率 (%)	時間 係数 (%)	二輪車 (台)	小型車 (台)	大型車 (台)	合計 (台)	大型車 混入率 (%)	時間 係数 (%)	二輪車 (台)
22:00-22:15	158	21	179	30.5	2.5	8						
22:15-22:30	206	17	223	30.1	3.2	11						
22:30-22:45	153	27	180	47.0	2.6	9						
22:45-23:00	154	21	175	39.7	2.5	13						
23:00-23:15	146	34	180	64.8	2.8	12						
23:15-23:30	87	31	118	114.5	1.5	9						
23:30-23:45	91	34	125	81.7	1.7	6						
23:45-24:00	84	27	111	72.7	1.5	8						
0:00-0:15	105	33	138	71.8	1.9	10						
0:15-0:30	79	34	113	133.2	1.5	3						
0:30-0:45	73	28	101	96.6	1.4	6						
0:45-1:00	64	28	92	104.1	1.4	6						
1:00-1:15	69	27	96	90.8	1.5	8						
1:15-1:30	45	26	71	142.9	1.0	6						
1:30-1:45	57	32	89	121.2	1.2	2						
1:45-2:00	38	30	68	159.7	1.1	5						
2:00-2:15	55	27	82	102.3	1.3	1						
2:15-2:30	47	27	74	91.6	1.1	2						
2:30-2:45	24	35	59	213.0	1.1	2						
2:45-3:00	45	20	65	115.3	0.9	4						
3:00-3:15	38	30	68	173.7	1.1	2						
3:15-3:30	37	45	82	195.2	1.0	5						
3:30-3:45	34	39	73	208.4	0.9	4						
3:45-4:00	42	39	81	139.7	1.1	8						
4:00-4:15	36	42	78	218.0	1.1	1						
4:15-4:30	46	43	89	138.4	1.0	2						
4:30-4:45	53	40	93	182.8	1.4	7						
4:45-5:00	86	57	143	150.7	2.2	3						
5:00-5:15	82	47	129	147.6	2.1	6						
5:15-5:30	117	63	180	119.2	2.6	12						
5:30-5:45	135	71	206	120.7	2.8	9						
5:45-6:00	201	58	259	69.8	3.8	10						
6:00-6:15	254	76	330	81.6	4.6	16						
6:15-6:30	272	64	336	61.5	4.5	9						
6:30-6:45	248	72	320	87.3	4.3	24						
6:45-7:00	276	75	351	81.1	5.4	25						
7:00-7:15	291	66	357	63.5	5.4	23						
7:15-7:30	314	85	399	84.9	6.2	20						
7:30-7:45	320	54	374	48.1	5.9	31						
7:45-8:00	308	73	381	75.5	5.6	17						
8:00-8:15	330	78	408	80.5	6.2	15						
8:15-8:30	307	79	386	75.4	6.0	20						
8:30-8:45	322	70	392	61.5	5.9	20						
8:45-9:00	359	66	425	62.9	6.0	10						
9:00-9:15	256	78	334	95.1	4.7	12						
9:15-9:30	313	81	394	71.5	5.6	11						
9:30-9:45	313	75	388	76.4	5.7	16						
9:45-10:00	326	82	408	72.7	6.0	6						

交差点合計自動車交通量調査表

調査地点：地域社会3 上川井1C

調査年月日：令和元年10月13日(日) 天候：曇りのち雨

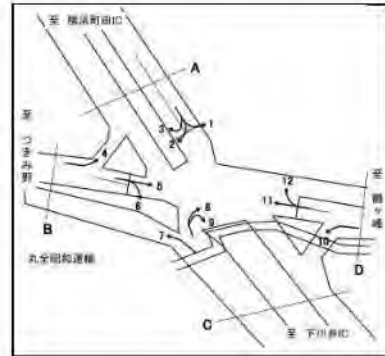

方向 時間帯	交差点合計(1+2+3+4+5+6+7+8+9+10+11+12)											
	種別 小型車 (台)	大型車 (台)	合計 (台)	大型車 混入率 (%)	時 間 係 数 (%)	二輪車 (台)	小型車 (台)	大型車 (台)	合計 (台)	大型車 混入率 (%)	時 間 係 数 (%)	二輪車 (台)
10:00-10:15	316	94	410	92.7	6.1	9						
10:15-10:30	310	81	391	84.1	5.9	14						
10:30-10:45	291	65	356	73.2	5.3	7						
10:45-11:00	385	95	480	83.3	6.9	4						
11:00-11:15	319	58	377	69.1	6.0	5						
11:15-11:30	316	63	379	58.2	6.0	3						
11:30-11:45	310	67	377	77.6	5.8	9						
11:45-12:00	281	71	352	79.6	5.7	11						
12:00-12:15	292	49	341	51.8	5.1	1						
12:15-12:30	342	87	429	83.4	6.5	5						
12:30-12:45	302	53	355	62.7	5.3	3						
12:45-13:00	294	66	360	68.4	5.5	8						
13:00-13:15	312	63	375	64.7	5.6	2						
13:15-13:30	293	55	348	64.1	5.2	2						
13:30-13:45	337	65	402	66.0	6.0	7						
13:45-14:00	311	54	365	58.9	5.4	6						
14:00-14:15	341	67	408	64.0	5.6	2						
14:15-14:30	320	62	382	72.5	5.2	5						
14:30-14:45	304	56	360	61.5	5.2	6						
14:45-15:00	319	59	378	60.6	5.3	9						
15:00-15:15	342	59	401	55.1	6.2	10						
15:15-15:30	351	56	407	64.4	5.9	9						
15:30-15:45	348	67	415	58.3	6.3	7						
15:45-16:00	330	57	387	56.7	5.6	9						
16:00-16:15	378	66	444	66.3	6.3	15						
16:15-16:30	353	83	436	76.2	6.2	10						
16:30-16:45	390	59	449	58.4	6.4	9						
16:45-17:00	349	55	404	55.4	6.1	13						
17:00-17:15	366	49	415	45.6	6.0	20						
17:15-17:30	368	55	423	61.7	6.3	22						
17:30-17:45	348	49	397	55.7	6.2	19						
17:45-18:00	398	36	434	30.1	6.2	16						
18:00-18:15	417	45	462	42.7	6.3	24						
18:15-18:30	390	48	438	52.0	6.3	18						
18:30-18:45	276	43	419	35.3	5.7	14						
18:45-19:00	297	34	331	44.6	4.8	18						
19:00-19:15	329	35	364	40.4	5.4	19						
19:15-19:30	267	47	314	58.3	4.6	9						
19:30-19:45	257	29	286	38.4	4.2	9						
19:45-20:00	257	44	301	54.7	4.4	10						
20:00-20:15	246	38	284	56.3	4.1	9						
20:15-20:30	228	43	271	68.2	3.7	4						
20:30-20:45	244	43	287	58.6	4.1	8						
20:45-21:00	211	35	246	42.5	3.4	9						
21:00-21:15	224	40	264	54.9	3.7	11						
21:15-21:30	210	33	243	46.0	3.2	13						
21:30-21:45	166	36	202	63.3	2.8	7						
21:45-22:00	152	30	182	55.3	2.5	8						
全時間合計	22383	4951	27334	69.5	400.0	942						

交差点合計自動車交通量調査表

調査地点 : 地域社会4 滝沢

調査年月日 : 令和 2年 9月21日(月・祝) 天候:曇りのち晴れ



方向	交差点合計(1+2+3+4+5+6)						
	種別	小型車 (台)	大型車 (台)	合計 (台)	大型車 混入率 (%)	時間 係数 (%)	二輪車 (台)
7:00-7:15		198	46	244	18.9	1.0	20
7:15-7:30		246	39	285	13.7	1.2	16
7:30-7:45		269	45	314	14.3	1.3	17
7:45-8:00		254	28	282	9.9	1.1	13
1時間計		967	158	1125	14.0	4.6	66
8:00-8:15		307	36	343	10.5	1.4	27
8:15-8:30		307	44	351	12.5	1.4	14
8:30-8:45		322	42	364	11.5	1.5	6
8:45-9:00		334	52	386	13.5	1.6	17
1時間計		1270	174	1444	12.0	5.9	64
9:00-9:15		263	46	309	14.9	1.3	17
9:15-9:30		327	44	371	11.9	1.5	38
9:30-9:45		324	55	379	14.5	1.5	15
9:45-10:00		283	34	317	10.7	1.3	10
1時間計		1197	179	1376	13.0	5.6	80
10:00-10:15		279	36	315	11.4	1.3	12
10:15-10:30		274	28	302	9.3	1.2	15
10:30-10:45		291	43	334	12.9	1.4	16
10:45-11:00		279	30	309	9.7	1.3	13
1時間計		1123	137	1260	10.9	5.1	56
11:00-11:15		268	39	307	12.7	1.3	11
11:15-11:30		228	33	261	12.6	1.1	16
11:30-11:45		296	39	335	11.6	1.4	12
11:45-12:00		357	50	407	12.3	1.7	24
1時間計		1149	161	1310	12.3	5.3	63
12:00-12:15		301	34	335	10.1	1.4	16
12:15-12:30		334	40	374	10.7	1.5	21
12:30-12:45		392	41	433	9.5	1.8	14
12:45-13:00		358	37	395	9.4	1.6	19
1時間計		1385	152	1537	9.9	6.3	70
13:00-13:15		398	34	432	7.9	1.8	17
13:15-13:30		394	38	432	8.8	1.8	14
13:30-13:45		365	39	404	9.7	1.6	24
13:45-14:00		373	38	411	9.2	1.7	16
1時間計		1530	149	1679	8.9	6.8	71
14:00-14:15		404	46	450	10.2	1.8	22
14:15-14:30		406	36	442	8.1	1.8	21
14:30-14:45		361	40	401	10.0	1.6	25
14:45-15:00		342	37	379	9.8	1.5	22
1時間計		1513	159	1672	9.5	6.8	90

交差点合計自動車交通量調査表

調査地点 : 地域社会4 滝沢

調査年月日 : 令和 2年 9月21日(月・祝) 天候:曇りのち晴れ



方向 種別 時間帯	交差点合計(1+2+3+4+5+6)					
	小型車 (台)	大型車 (台)	合計 (台)	大型車 混入率 (%)	時間 係数 (%)	二輪車 (台)
15:00-15:15	424	38	462	8.2	1.9	19
15:15-15:30	361	33	394	8.4	1.6	13
15:30-15:45	408	37	445	8.3	1.8	27
15:45-16:00	384	36	420	8.6	1.7	17
1時間計	1577	144	1721	8.4	7.0	76
16:00-16:15	395	28	423	6.6	1.7	14
16:15-16:30	372	35	407	8.6	1.7	21
16:30-16:45	463	35	498	7.0	2.0	13
16:45-17:00	392	25	417	6.0	1.7	24
1時間計	1622	123	1745	7.0	7.1	72
17:00-17:15	401	28	429	6.5	1.7	26
17:15-17:30	388	19	407	4.7	1.7	33
17:30-17:45	387	38	425	8.9	1.7	23
17:45-18:00	392	25	417	6.0	1.7	17
1時間計	1568	110	1678	6.6	6.8	99
18:00-18:15	445	36	481	7.5	2.0	25
18:15-18:30	433	13	446	2.9	1.8	26
18:30-18:45	362	19	381	5.0	1.6	18
18:45-19:00	402	17	419	4.1	1.7	15
1時間計	1642	85	1727	4.9	7.0	84
昼12時間計	16543	1731	18274	9.5	74.5	891
19:00-19:15	367	14	381	3.7	1.6	16
19:15-19:30	286	10	296	3.4	1.2	22
19:30-19:45	312	12	324	3.7	1.3	17
19:45-20:00	265	10	275	3.6	1.1	13
1時間計	1230	46	1276	3.6	5.2	68
20:00-20:15	263	9	272	3.3	1.1	17
20:15-20:30	252	6	258	2.3	1.1	8
20:30-20:45	278	8	286	2.8	1.2	13
20:45-21:00	204	8	212	3.8	0.9	13
1時間計	997	31	1028	3.0	4.2	51
21:00-21:15	236	11	247	4.5	1.0	10
21:15-21:30	203	11	214	5.1	0.9	11
21:30-21:45	182	10	192	5.2	0.8	12
21:45-22:00	179	10	189	5.3	0.8	13
1時間計	800	42	842	5.0	3.4	46
22:00-22:15	151	10	161	6.2	0.7	10
22:15-22:30	129	12	141	8.5	0.6	5
22:30-22:45	169	16	185	8.6	0.8	10
22:45-23:00	116	7	123	5.7	0.5	7
1時間計	565	45	610	7.4	2.5	32

交差点合計自動車交通量調査表

調査地点 : 地域社会4 滝沢

調査年月日 : 令和 2年 9月21日(月・祝) 天候:曇りのち晴れ



方向 種別 時間帯	交差点合計(1+2+3+4+5+6)					
	小型車 (台)	大型車 (台)	合計 (台)	大型車 混入率 (%)	時間 係数 (%)	二輪車 (台)
23:00-23:15	104	8	112	7.1	0.5	3
23:15-23:30	106	8	114	7.0	0.5	7
23:30-23:45	94	9	103	8.7	0.4	4
23:45-24:00	78	9	87	10.3	0.4	3
1時間計	382	34	416	8.2	1.7	17
0:00- 0:15	73	9	82	11.0	0.3	5
0:15- 0:30	61	7	68	10.3	0.3	3
0:30- 0:45	62	19	81	23.5	0.3	6
0:45- 1:00	45	5	50	10.0	0.2	2
1時間計	241	40	281	14.2	1.1	16
1:00- 1:15	46	16	62	25.8	0.3	3
1:15- 1:30	44	21	65	32.3	0.3	4
1:30- 1:45	27	18	45	40.0	0.2	3
1:45- 2:00	36	7	43	16.3	0.2	3
1時間計	153	62	215	28.8	0.9	13
2:00- 2:15	37	18	55	32.7	0.2	1
2:15- 2:30	29	7	36	19.4	0.1	2
2:30- 2:45	28	10	38	26.3	0.2	1
2:45- 3:00	15	5	20	25.0	0.1	1
1時間計	109	40	149	26.8	0.6	5
3:00- 3:15	39	11	50	22.0	0.2	2
3:15- 3:30	29	10	39	25.6	0.2	2
3:30- 3:45	33	9	42	21.4	0.2	0
3:45- 4:00	23	4	27	14.8	0.1	2
1時間計	124	34	158	21.5	0.6	6
4:00- 4:15	29	9	38	23.7	0.2	0
4:15- 4:30	30	7	37	18.9	0.2	0
4:30- 4:45	36	8	44	18.2	0.2	3
4:45- 5:00	50	19	69	27.5	0.3	5
1時間計	145	43	188	22.9	0.8	8
5:00- 5:15	68	26	94	27.7	0.4	6
5:15- 5:30	54	19	73	26.0	0.3	7
5:30- 5:45	95	20	115	17.4	0.5	12
5:45- 6:00	80	15	95	15.8	0.4	7
1時間計	297	80	377	21.2	1.5	32
6:00- 6:15	127	20	147	13.6	0.6	9
6:15- 6:30	141	23	164	14.0	0.7	15
6:30- 6:45	161	32	193	16.6	0.8	11
6:45- 7:00	198	27	225	12.0	0.9	16
1時間計	627	102	729	14.0	3.0	51
夜12時間計	5670	599	6269	9.6	25.5	345
18時間計	21144	2031	23175	8.8	94.4	1156
全時間合計	22213	2330	24543	9.5	100.0	1236
昼夜率	1.34	1.35	1.34	-	-	1.39

交差点合計自動車交通量調査表

調査地点 : 地域社会4 瀬谷土橋公園入口

調査年月日 : 令和 2年 9月21日(月・祝) 天候:曇りのち晴れ



方向	交差点合計(1+2+3+4+5+6)						
	種別	小型車 (台)	大型車 (台)	合計 (台)	大型車 混入率 (%)	時間 係数 (%)	二輪車 (台)
7:00-7:15		165	28	193	14.5	1.0	15
7:15-7:30		214	40	254	15.7	1.3	10
7:30-7:45		230	38	268	14.2	1.3	16
7:45-8:00		210	29	239	12.1	1.2	15
1時間計		819	135	954	14.2	4.8	56
8:00-8:15		237	31	268	11.6	1.3	19
8:15-8:30		259	33	292	11.3	1.5	11
8:30-8:45		278	39	317	12.3	1.6	9
8:45-9:00		262	46	308	14.9	1.5	16
1時間計		1036	149	1185	12.6	6.0	55
9:00-9:15		219	39	258	15.1	1.3	17
9:15-9:30		283	36	319	11.3	1.6	31
9:30-9:45		250	34	284	12.0	1.4	12
9:45-10:00		214	25	239	10.5	1.2	9
1時間計		966	134	1100	12.2	5.5	69
10:00-10:15		232	33	265	12.5	1.3	7
10:15-10:30		227	29	256	11.3	1.3	11
10:30-10:45		221	37	258	14.3	1.3	10
10:45-11:00		236	26	262	9.9	1.3	10
1時間計		916	125	1041	12.0	5.2	38
11:00-11:15		235	34	269	12.6	1.4	8
11:15-11:30		172	24	196	12.2	1.0	11
11:30-11:45		238	36	274	13.1	1.4	6
11:45-12:00		272	43	315	13.7	1.6	21
1時間計		917	137	1054	13.0	5.3	46
12:00-12:15		286	37	323	11.5	1.6	13
12:15-12:30		287	32	319	10.0	1.6	11
12:30-12:45		339	37	376	9.8	1.9	14
12:45-13:00		267	31	298	10.4	1.5	11
1時間計		1179	137	1316	10.4	6.6	49
13:00-13:15		309	32	341	9.4	1.7	17
13:15-13:30		269	35	304	11.5	1.5	14
13:30-13:45		335	43	378	11.4	1.9	24
13:45-14:00		312	39	351	11.1	1.8	12
1時間計		1225	149	1374	10.8	6.9	67
14:00-14:15		278	38	316	12.0	1.6	14
14:15-14:30		343	25	368	6.8	1.8	14
14:30-14:45		288	32	320	10.0	1.6	23
14:45-15:00		308	34	342	9.9	1.7	19
1時間計		1217	129	1346	9.6	6.8	70

交差点合計自動車交通量調査表

調査地点：地域社会4 瀬谷土橋公園入口

調査年月日：令和 2年 9月21日(月・祝) 天候：曇りのち晴れ



方向 時間帯	交差点合計(1+2+3+4+5+6)					
	種別 小型車 (台)	大型車 (台)	合計 (台)	大型車 混入率 (%)	時間 係数 (%)	二輪車 (台)
15:00-15:15	345	28	373	7.5	1.9	16
15:15-15:30	335	31	366	8.5	1.8	12
15:30-15:45	312	26	338	7.7	1.7	22
15:45-16:00	312	31	343	9.0	1.7	14
1時間計	1304	116	1420	8.2	7.1	64
16:00-16:15	339	30	369	8.1	1.9	13
16:15-16:30	339	36	375	9.6	1.9	14
16:30-16:45	348	27	375	7.2	1.9	11
16:45-17:00	310	22	332	6.6	1.7	17
1時間計	1336	115	1451	7.9	7.3	55
17:00-17:15	280	28	308	9.1	1.5	27
17:15-17:30	320	18	338	5.3	1.7	30
17:30-17:45	320	39	359	10.9	1.8	26
17:45-18:00	313	29	342	8.5	1.7	18
1時間計	1233	114	1347	8.5	6.8	101
18:00-18:15	355	26	381	6.8	1.9	19
18:15-18:30	351	12	363	3.3	1.8	19
18:30-18:45	290	19	309	6.1	1.6	12
18:45-19:00	322	16	338	4.7	1.7	10
1時間計	1318	73	1391	5.2	7.0	60
昼12時間計	13466	1513	14979	10.1	75.2	730
19:00-19:15	327	13	340	3.8	1.7	21
19:15-19:30	216	8	224	3.6	1.1	14
19:30-19:45	243	12	255	4.7	1.3	13
19:45-20:00	221	6	227	2.6	1.1	9
1時間計	1007	39	1046	3.7	5.3	57
20:00-20:15	181	14	195	7.2	1.0	16
20:15-20:30	206	6	212	2.8	1.1	5
20:30-20:45	220	10	230	4.3	1.2	10
20:45-21:00	164	8	172	4.7	0.9	11
1時間計	771	38	809	4.7	4.1	42
21:00-21:15	182	10	192	5.2	1.0	10
21:15-21:30	170	10	180	5.6	0.9	7
21:30-21:45	161	8	169	4.7	0.8	14
21:45-22:00	135	9	144	6.3	0.7	6
1時間計	648	37	685	5.4	3.4	37
22:00-22:15	133	12	145	8.3	0.7	10
22:15-22:30	88	10	98	10.2	0.5	5
22:30-22:45	121	12	133	9.0	0.7	11
22:45-23:00	75	7	82	8.5	0.4	5
1時間計	417	41	458	9.0	2.3	31

交差点合計自動車交通量調査表

調査地点 : 地域社会4 瀬谷土橋公園入口

調査年月日 : 令和 2年 9月21日(月・祝) 天候:曇りのち晴れ



方向	交差点合計(1+2+3+4+5+6)						
	種別	小型車 (台)	大型車 (台)	合計 (台)	大型車 混入率 (%)	時間 係数 (%)	二輪車 (台)
23:00-23:15		72	8	80	10.0	0.4	2
23:15-23:30		75	8	83	9.6	0.4	5
23:30-23:45		45	5	50	10.0	0.3	2
23:45-24:00		67	8	75	10.7	0.4	1
1時間計		259	29	288	10.1	1.4	10
0:00-0:15		39	6	45	13.3	0.2	4
0:15-0:30		50	12	62	19.4	0.3	3
0:30-0:45		33	17	50	34.0	0.3	3
0:45-1:00		30	11	41	26.8	0.2	2
1時間計		152	46	198	23.2	1.0	12
1:00-1:15		31	12	43	27.9	0.2	3
1:15-1:30		28	21	49	42.9	0.2	4
1:30-1:45		25	8	33	24.2	0.2	4
1:45-2:00		19	7	26	26.9	0.1	1
1時間計		103	48	151	31.8	0.8	12
2:00-2:15		24	13	37	35.1	0.2	1
2:15-2:30		16	8	24	33.3	0.1	3
2:30-2:45		21	13	34	38.2	0.2	6
2:45-3:00		10	6	16	37.5	0.1	2
1時間計		71	40	111	36.0	0.6	12
3:00-3:15		22	9	31	29.0	0.2	2
3:15-3:30		17	10	27	37.0	0.1	2
3:30-3:45		25	7	32	21.9	0.2	0
3:45-4:00		16	5	21	23.8	0.1	0
1時間計		80	31	111	27.9	0.6	4
4:00-4:15		24	9	33	27.3	0.2	0
4:15-4:30		23	4	27	14.8	0.1	0
4:30-4:45		29	2	31	6.5	0.2	2
4:45-5:00		45	17	62	27.4	0.3	3
1時間計		121	32	153	20.9	0.8	5
5:00-5:15		55	15	70	21.4	0.4	4
5:15-5:30		45	9	54	16.7	0.3	8
5:30-5:45		57	17	74	23.0	0.4	13
5:45-6:00		72	13	85	15.3	0.4	6
1時間計		229	54	283	19.1	1.4	31
6:00-6:15		121	19	140	13.6	0.7	10
6:15-6:30		139	20	159	12.6	0.8	16
6:30-6:45		138	22	160	13.8	0.8	7
6:45-7:00		153	23	176	13.1	0.9	13
1時間計		551	84	635	13.2	3.2	46
夜12時間計		4409	519	4928	10.5	24.8	299
18時間計		17119	1781	18900	9.4	94.9	953
全時間合計		17875	2032	19907	10.2	100.0	1029
昼夜率		1.33	1.34	1.33	-	-	1.41

交差点合計自動車交通量調査表

調査地点 : 地域社会4 瀬谷土橋公園前

調査年月日 : 令和 2年 9月21日(月・祝) 天候:曇りのち晴れ



方向 時間帯	交差点合計(1+2+3+4+5+6)					
	種別 小型車 (台)	大型車 (台)	合計 (台)	大型車 混入率 (%)	時間 係数 (%)	二輪車 (台)
7:00-7:15	71	17	88	19.3	1.1	1
7:15-7:30	99	22	121	18.2	1.5	5
7:30-7:45	82	14	96	14.6	1.2	1
7:45-8:00	98	15	113	13.3	1.4	4
1時間計	350	68	418	16.3	5.1	11
8:00-8:15	120	10	130	7.7	1.6	5
8:15-8:30	109	10	119	8.4	1.5	0
8:30-8:45	101	16	117	13.7	1.4	5
8:45-9:00	99	9	108	8.3	1.3	8
1時間計	429	45	474	9.5	5.8	18
9:00-9:15	100	16	116	13.8	1.4	4
9:15-9:30	89	11	100	11.0	1.2	6
9:30-9:45	75	13	88	14.8	1.1	4
9:45-10:00	78	5	83	6.0	1.0	4
1時間計	342	45	387	11.6	4.8	18
10:00-10:15	72	5	77	6.5	0.9	5
10:15-10:30	95	3	98	3.1	1.2	2
10:30-10:45	85	9	94	9.6	1.2	3
10:45-11:00	96	13	109	11.9	1.3	9
1時間計	348	30	378	7.9	4.6	19
11:00-11:15	95	12	107	11.2	1.3	3
11:15-11:30	64	18	82	22.0	1.0	5
11:30-11:45	79	17	96	17.7	1.2	3
11:45-12:00	125	18	143	12.6	1.8	5
1時間計	363	65	428	15.2	5.3	16
12:00-12:15	108	19	127	15.0	1.6	4
12:15-12:30	89	15	104	14.4	1.3	1
12:30-12:45	108	21	129	16.3	1.6	4
12:45-13:00	112	24	136	17.6	1.7	4
1時間計	417	79	496	15.9	6.1	13
13:00-13:15	112	20	132	15.2	1.6	3
13:15-13:30	126	19	145	13.1	1.8	2
13:30-13:45	118	18	136	13.2	1.7	4
13:45-14:00	122	20	142	14.1	1.7	7
1時間計	478	77	555	13.9	6.8	16
14:00-14:15	148	25	173	14.5	2.1	5
14:15-14:30	144	11	155	7.1	1.9	3
14:30-14:45	138	25	163	15.3	2.0	4
14:45-15:00	133	10	143	7.0	1.8	3
1時間計	563	71	634	11.2	7.8	15

交差点合計自動車交通量調査表

調査地点：地域社会4 瀬谷土橋公園前

調査年月日：令和 2年 9月21日(月・祝) 天候：曇りのち晴れ



方向 種別 時間帯	交差点合計(1+2+3+4+5+6)					
	小型車 (台)	大型車 (台)	合計 (台)	大型車 混入率 (%)	時間 係数 (%)	二輪車 (台)
15:00-15:15	127	13	140	9.3	1.7	7
15:15-15:30	120	18	138	13.0	1.7	5
15:30-15:45	125	24	149	16.1	1.8	11
15:45-16:00	126	20	146	13.7	1.8	4
1時間計	498	75	573	13.1	7.0	27
16:00-16:15	153	10	163	6.1	2.0	5
16:15-16:30	136	14	150	9.3	1.8	2
16:30-16:45	158	21	179	11.7	2.2	3
16:45-17:00	109	11	120	9.2	1.5	5
1時間計	556	56	612	9.2	7.5	15
17:00-17:15	114	26	140	18.6	1.7	8
17:15-17:30	120	12	132	9.1	1.6	17
17:30-17:45	128	28	156	17.9	1.9	14
17:45-18:00	140	21	161	13.0	2.0	8
1時間計	502	87	589	14.8	7.2	47
18:00-18:15	109	17	126	13.5	1.5	4
18:15-18:30	120	14	134	10.4	1.6	6
18:30-18:45	92	15	107	14.0	1.3	2
18:45-19:00	114	14	128	10.9	1.6	4
1時間計	435	60	495	12.1	6.1	16
昼12時間計	5281	758	6039	12.6	74.3	231
19:00-19:15	106	6	112	5.4	1.4	4
19:15-19:30	90	5	95	5.3	1.2	7
19:30-19:45	95	6	101	5.9	1.2	7
19:45-20:00	57	7	64	10.9	0.8	2
1時間計	348	24	372	6.5	4.6	20
20:00-20:15	60	10	70	14.3	0.9	5
20:15-20:30	59	9	68	13.2	0.8	1
20:30-20:45	67	8	75	10.7	0.9	3
20:45-21:00	65	6	71	8.5	0.9	5
1時間計	251	33	284	11.6	3.5	14
21:00-21:15	46	8	54	14.8	0.7	2
21:15-21:30	54	8	62	12.9	0.8	2
21:30-21:45	52	3	55	5.5	0.7	2
21:45-22:00	39	16	55	29.1	0.7	0
1時間計	191	35	226	15.5	2.8	6
22:00-22:15	40	9	49	18.4	0.6	0
22:15-22:30	36	8	44	18.2	0.5	0
22:30-22:45	33	11	44	25.0	0.5	1
22:45-23:00	30	5	35	14.3	0.4	0
1時間計	139	33	172	19.2	2.1	1

交差点合計自動車交通量調査表

調査地点 : 地域社会4 瀬谷土橋公園前

調査年月日 : 令和 2年 9月21日(月・祝) 天候:曇りのち晴れ



方向 種別 時間帯	交差点合計(1+2+3+4+5+6)					
	小型車 (台)	大型車 (台)	合計 (台)	大型車 混入率 (%)	時間 係数 (%)	二輪車 (台)
23:00-23:15	28	4	32	12.5	0.4	1
23:15-23:30	21	6	27	22.2	0.3	2
23:30-23:45	26	10	36	27.8	0.4	1
23:45-24:00	23	10	33	30.3	0.4	0
1時間計	98	30	128	23.4	1.6	4
0:00-0:15	17	12	29	41.4	0.4	0
0:15-0:30	14	6	20	30.0	0.2	1
0:30-0:45	23	12	35	34.3	0.4	0
0:45-1:00	8	13	21	61.9	0.3	1
1時間計	62	43	105	41.0	1.3	2
1:00-1:15	9	15	24	62.5	0.3	9
1:15-1:30	12	17	29	58.6	0.4	2
1:30-1:45	15	16	31	51.6	0.4	1
1:45-2:00	9	15	24	62.5	0.3	0
1時間計	45	63	108	58.3	1.3	12
2:00-2:15	5	10	15	66.7	0.2	3
2:15-2:30	9	8	17	47.1	0.2	2
2:30-2:45	11	16	27	59.3	0.3	5
2:45-3:00	9	10	19	52.6	0.2	0
1時間計	34	44	78	56.4	1.0	10
3:00-3:15	4	7	11	63.6	0.1	2
3:15-3:30	13	3	16	18.8	0.2	1
3:30-3:45	7	5	12	41.7	0.1	0
3:45-4:00	10	2	12	16.7	0.1	0
1時間計	34	17	51	33.3	0.6	3
4:00-4:15	8	2	10	20.0	0.1	0
4:15-4:30	8	7	15	46.7	0.2	1
4:30-4:45	9	3	12	25.0	0.1	2
4:45-5:00	10	8	18	44.4	0.2	1
1時間計	35	20	55	36.4	0.7	4
5:00-5:15	19	11	30	36.7	0.4	1
5:15-5:30	23	13	36	36.1	0.4	3
5:30-5:45	20	18	38	47.4	0.5	5
5:45-6:00	46	15	61	24.6	0.8	1
1時間計	108	57	165	34.5	2.0	10
6:00-6:15	58	23	81	28.4	1.0	6
6:15-6:30	64	20	84	23.8	1.0	4
6:30-6:45	59	33	92	35.9	1.1	5
6:45-7:00	71	21	92	22.8	1.1	5
1時間計	252	97	349	27.8	4.3	20
夜12時間計	1597	496	2093	23.7	25.7	106
18時間計	6560	1010	7570	13.3	93.1	296
全時間合計	6878	1254	8132	15.4	100.0	337
昼夜率	1.30	1.65	1.35	-	-	1.46

交差点合計自動車交通量調査表

調査地点 : 地域社会5

調査年月日 : 令和元年10月13日(日) 天候:曇りのち雨



時間帯	種別	交差点合計(1+2+3+4+5+6)												
		小型車 (台)	大型車 (台)	合計 (台)	大型車 混入率 (%)	時間 係数 (%)	二輪車 (台)	小型車 (台)	大型車 (台)	合計 (台)	大型車 混入率 (%)	時間 係数 (%)	二輪車 (台)	
22:00-22:15		151	7	158	10.1	2.6	13							
22:15-22:30		113	9	122	15.8	2.0	19							
22:30-22:45		121	14	135	23.7	2.3	12							
22:45-23:00		116	15	131	35.0	2.1	9							
23:00-23:15		95	11	106	23.2	1.8	9							
23:15-23:30		78	7	85	18.2	1.2	7							
23:30-23:45		79	6	85	14.5	1.3	8							
23:45-24:00		45	4	49	16.7	0.7	6							
0:00-0:15		63	4	67	14.1	1.0	6							
0:15-0:30		31	3	34	18.8	0.5	3							
0:30-0:45		49	12	61	44.8	1.0	6							
0:45-1:00		38	4	42	30.3	0.7	6							
1:00-1:15		28	6	34	42.0	0.5	4							
1:15-1:30		42	8	50	46.3	0.9	4							
1:30-1:45		30	5	35	31.1	0.6	3							
1:45-2:00		19	16	35	141.1	0.6	3							
2:00-2:15		37	3	40	14.3	0.6	2							
2:15-2:30		24	13	37	172.5	0.5	3							
2:30-2:45		19	5	24	41.7	0.4	2							
2:45-3:00		26	13	39	69.4	0.6	3							
3:00-3:15		19	5	24	63.4	0.4	2							
3:15-3:30		17	10	27	160.0	0.4	1							
3:30-3:45		29	6	35	48.5	0.7	2							
3:45-4:00		25	7	32	48.1	0.5	0							
4:00-4:15		25	8	33	54.3	0.5	2							
4:15-4:30		26	11	37	104.8	0.6	2							
4:30-4:45		34	8	42	42.4	0.6	4							
4:45-5:00		40	14	54	58.6	0.9	2							
5:00-5:15		42	24	66	77.2	1.0	6							
5:15-5:30		59	10	69	31.4	1.1	7							
5:30-5:45		97	12	109	31.0	1.8	5							
5:45-6:00		111	15	126	32.3	2.2	9							
6:00-6:15		121	12	133	20.3	2.4	8							
6:15-6:30		153	22	175	27.9	2.9	15							
6:30-6:45		169	29	198	39.0	3.4	22							
6:45-7:00		173	24	197	31.6	3.5	15							
7:00-7:15		176	40	216	48.4	3.9	15							
7:15-7:30		212	42	254	52.4	4.5	8							
7:30-7:45		230	41	271	42.2	4.8	18							
7:45-8:00		212	46	258	49.8	4.7	19							
8:00-8:15		251	39	290	38.4	5.2	24							
8:15-8:30		240	30	270	27.3	5.2	25							
8:30-8:45		242	35	277	35.1	4.9	14							
8:45-9:00		212	29	241	36.0	4.4	17							
9:00-9:15		255	35	290	31.3	5.4	16							
9:15-9:30		227	25	252	26.2	4.7	12							
9:30-9:45		233	22	255	23.7	5.0	8							
9:45-10:00		221	23	244	26.0	4.6	8							

交差点合計自動車交通量調査表

調査地点 : 地域社会5

調査年月日 : 令和元年10月13日(日) 天候:曇りのち雨



方向 時間帯	交差点合計 (1+2+3+4+5+6)											
	種別 小型車 (台)	大型車 (台)	合計 (台)	大型車 混入率 (%)	時 間 係 数 (%)	二 輪 車 (台)	小型車 (台)	大型車 (台)	合計 (台)	大型車 混入率 (%)	時 間 係 数 (%)	二 輪 車 (台)
10:00-10:15	212	28	240	32.7	4.4	14						
10:15-10:30	214	29	243	33.2	4.7	5						
10:30-10:45	195	25	220	30.2	4.4	7						
10:45-11:00	229	26	255	27.6	4.8	5						
11:00-11:15	254	29	283	28.3	5.5	4						
11:15-11:30	282	18	300	17.1	6.3	4						
11:30-11:45	255	34	289	36.5	5.2	6						
11:45-12:00	232	20	252	21.4	4.9	11						
12:00-12:15	237	24	261	26.0	4.9	10						
12:15-12:30	245	22	267	26.0	4.9	9						
12:30-12:45	271	14	285	15.1	5.4	11						
12:45-13:00	235	19	254	19.3	4.6	4						
13:00-13:15	253	30	283	30.9	5.2	7						
13:15-13:30	215	23	238	27.9	4.3	7						
13:30-13:45	242	29	271	29.8	5.0	2						
13:45-14:00	208	22	230	27.0	4.4	2						
14:00-14:15	211	21	232	27.7	4.5	11						
14:15-14:30	177	15	192	24.1	3.6	14						
14:30-14:45	211	11	222	14.3	4.2	6						
14:45-15:00	213	15	228	19.2	4.0	4						
15:00-15:15	235	21	256	20.9	4.6	6						
15:15-15:30	235	16	251	20.0	4.7	6						
15:30-15:45	232	14	246	17.5	4.3	6						
15:45-16:00	234	18	252	16.7	4.4	2						
16:00-16:15	249	20	269	21.6	5.0	9						
16:15-16:30	245	24	269	27.7	5.3	3						
16:30-16:45	250	17	267	16.2	4.8	9						
16:45-17:00	221	24	245	25.0	4.3	11						
17:00-17:15	285	24	309	19.4	5.4	5						
17:15-17:30	253	22	275	23.7	5.1	15						
17:30-17:45	240	17	257	17.4	4.5	12						
17:45-18:00	247	9	256	12.9	4.5	11						
18:00-18:15	254	15	269	12.3	5.0	12						
18:15-18:30	218	8	226	8.3	4.1	10						
18:30-18:45	199	14	213	21.9	4.1	6						
18:45-19:00	178	7	185	10.6	3.5	12						
19:00-19:15	146	7	153	14.9	2.6	4						
19:15-19:30	176	7	183	13.0	3.0	8						
19:30-19:45	161	5	166	6.9	2.8	4						
19:45-20:00	147	12	159	24.0	2.7	4						
20:00-20:15	158	12	170	21.8	2.8	13						
20:15-20:30	143	8	151	12.6	2.6	9						
20:30-20:45	120	6	126	9.6	1.9	7						
20:45-21:00	122	14	136	22.6	2.2	8						
21:00-21:15	145	8	153	25.3	2.6	1						
21:15-21:30	122	8	130	13.9	1.9	9						
21:30-21:45	117	3	120	4.3	2.0	13						
21:45-22:00	98	2	100	3.1	1.6	7						
全時間合計	15076	1605	16681	26.6	300.0	779						

交差点合計自動車交通量調査表

調査地点 : 地域社会6 瀬谷中学校前

調査年月日 : 令和元年10月13日(日) 天候 : 曇りのち雨



方向 時間帯	交差点合計 (1+2+3+4+5+6+7+8+9+10+11+12)											
	種別 小型車 (台)	大型車 (台)	合計 (台)	大型車 混入率 (%)	時間 係数 (%)	二輪車 (台)	小型車 (台)	大型車 (台)	合計 (台)	大型車 混入率 (%)	時間 係数 (%)	二輪車 (台)
22:00-22:15	234	5	239	8.3	3.2	17						
22:15-22:30	222	10	232	16.2	3.1	24						
22:30-22:45	204	4	208	7.2	2.8	16						
22:45-23:00	159	10	169	21.6	2.2	17						
23:00-23:15	172	12	184	25.7	2.5	14						
23:15-23:30	144	3	147	6.9	2.0	11						
23:30-23:45	114	5	119	17.2	1.6	8						
23:45-24:00	81	4	85	13.5	1.1	10						
0:00-0:15	98	4	102	11.6	1.3	12						
0:15-0:30	96	5	101	18.9	1.3	8						
0:30-0:45	81	10	91	39.4	1.3	10						
0:45-1:00	91	5	96	23.4	1.3	16						
1:00-1:15	64	9	73	46.6	1.0	13						
1:15-1:30	54	4	58	30.1	0.7	8						
1:30-1:45	51	4	55	18.6	0.7	10						
1:45-2:00	41	15	56	80.4	0.7	4						
2:00-2:15	37	9	46	72.7	0.5	5						
2:15-2:30	39	9	48	72.0	0.6	4						
2:30-2:45	39	8	47	71.1	0.6	6						
2:45-3:00	31	5	36	32.2	0.4	5						
3:00-3:15	31	6	37	70.8	0.5	5						
3:15-3:30	25	11	36	133.7	0.5	4						
3:30-3:45	20	5	25	58.3	0.3	3						
3:45-4:00	51	10	61	60.5	0.8	2						
4:00-4:15	44	14	58	93.8	0.8	6						
4:15-4:30	40	8	48	53.0	0.6	6						
4:30-4:45	59	7	66	30.0	0.9	9						
4:45-5:00	57	8	65	33.9	0.8	6						
5:00-5:15	97	37	134	90.4	1.8	7						
5:15-5:30	110	12	122	34.8	1.5	9						
5:30-5:45	142	18	160	45.1	2.2	13						
5:45-6:00	157	19	176	44.3	2.2	10						
6:00-6:15	194	15	209	25.9	2.7	15						
6:15-6:30	244	13	257	18.4	3.4	32						
6:30-6:45	275	33	308	41.1	4.0	19						
6:45-7:00	275	25	300	35.4	3.9	18						
7:00-7:15	315	23	338	29.9	4.3	20						
7:15-7:30	325	35	360	39.8	4.5	19						
7:30-7:45	345	33	378	32.5	4.8	25						
7:45-8:00	385	34	419	32.8	5.5	21						
8:00-8:15	413	35	448	33.4	5.7	29						
8:15-8:30	403	37	440	37.9	5.6	27						
8:30-8:45	407	36	443	32.8	5.6	21						
8:45-9:00	427	29	456	27.0	5.9	21						
9:00-9:15	433	41	474	36.4	6.0	21						
9:15-9:30	397	23	420	21.4	5.6	26						
9:30-9:45	483	23	506	17.8	6.7	22						
9:45-10:00	447	20	467	17.4	6.1	18						

交差点合計自動車交通量調査表

調査地点 : 地域社会6 瀬谷中学校前

調査年月日 : 令和元年10月13日(日) 天候:曇りのち雨



方向	交差点合計(1+2+3+4+5+6+7+8+9+10+11+12)												
	種別	小型車 (台)	大型車 (台)	合計 (台)	大型車 混入率 (%)	時間 係数 (%)	二輪車 (台)	小型車 (台)	大型車 (台)	合計 (台)	大型車 混入率 (%)	時間 係数 (%)	二輪車 (台)
10:00-10:15		439	30	469	24.4	6.2	15						
10:15-10:30		410	19	429	17.5	5.7	11						
10:30-10:45		444	32	476	26.1	6.1	15						
10:45-11:00		469	24	493	19.4	6.5	15						
11:00-11:15		449	29	478	24.9	6.3	13						
11:15-11:30		494	26	520	19.0	6.9	16						
11:30-11:45		510	26	536	19.2	7.1	13						
11:45-12:00		484	24	508	18.3	6.7	14						
12:00-12:15		474	41	515	32.8	6.9	9						
12:15-12:30		440	21	461	16.7	6.1	15						
12:30-12:45		494	30	524	22.0	7.0	15						
12:45-13:00		442	20	462	17.4	5.9	16						
13:00-13:15		469	13	482	9.6	6.4	12						
13:15-13:30		453	22	475	20.0	6.2	15						
13:30-13:45		424	26	450	24.9	5.7	6						
13:45-14:00		435	22	457	19.0	5.9	11						
14:00-14:15		517	36	553	24.5	7.1	19						
14:15-14:30		434	19	453	18.1	5.9	15						
14:30-14:45		451	22	473	17.3	6.0	11						
14:45-15:00		465	17	482	13.8	6.4	3						
15:00-15:15		421	27	448	24.0	5.7	10						
15:15-15:30		457	27	484	19.7	6.2	15						
15:30-15:45		541	24	565	16.9	7.5	12						
15:45-16:00		512	17	529	13.4	6.9	7						
16:00-16:15		455	20	475	16.4	6.3	14						
16:15-16:30		448	21	469	17.4	6.0	12						
16:30-16:45		468	20	488	16.6	6.4	16						
16:45-17:00		457	17	474	12.5	6.1	13						
17:00-17:15		565	22	587	15.0	7.8	14						
17:15-17:30		508	19	527	14.0	7.1	15						
17:30-17:45		461	21	482	16.4	6.3	19						
17:45-18:00		447	21	468	18.8	6.2	14						
18:00-18:15		444	16	460	13.8	6.1	15						
18:15-18:30		445	16	461	12.2	5.8	22						
18:30-18:45		451	17	468	14.7	6.1	16						
18:45-19:00		470	18	488	14.3	6.5	29						
19:00-19:15		426	17	443	14.0	5.7	13						
19:15-19:30		312	19	331	21.2	4.3	15						
19:30-19:45		429	16	445	14.6	5.9	18						
19:45-20:00		319	21	340	19.7	4.4	21						
20:00-20:15		337	6	343	6.9	4.4	23						
20:15-20:30		346	13	359	13.8	4.6	18						
20:30-20:45		293	10	303	12.4	4.0	14						
20:45-21:00		264	18	282	26.8	3.6	16						
21:00-21:15		245	11	256	17.9	3.3	4						
21:15-21:30		231	6	237	8.9	3.0	19						
21:30-21:45		213	10	223	19.5	3.0	16						
21:45-22:00		157	4	161	10.0	2.0	12						
全時間合計		28972	1723	30695	21.9	400.0	1343						

9.17-2 交差点における横断歩道部歩行者等調査結果

対象事業実施区域周辺の主要交差点（7交差点）において、平日・休日・混雑時に実施した調査結果は、平日はP.資料 地域-600～681、休日はP.資料 地域-682～763、混雑時はP.資料 地域-764～845 に示すとおりです。

歩行者通行量調査表

調査地点 地域社会1 目黒

調査年月日 令和元年 5月14日(火) 天候 雨のち曇り

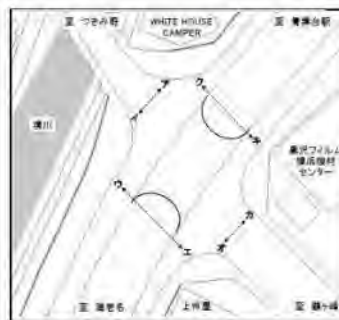

方向	7				4				合計				
	種別	歩行者 (人)	自転車 (台)	合計 (人・台)	時間 係数 (%)	歩行者 (人)	自転車 (台)	合計 (人・台)	時間 係数 (%)	歩行者 (人)	自転車 (台)	合計 (人・台)	時間 係数 (%)
7:00-7:15	時間帯	0	0	0	0.0	0	0	0	0.0	0	0	0	0.0
7:15-7:30		2	1	3	2.0	0	1	1	0.7	2	2	4	1.4
7:30-7:45		4	2	6	4.0	0	3	3	2.1	4	5	9	3.1
7:45-8:00		0	5	5	3.3	0	2	2	1.4	0	7	7	2.4
	1時間計	6	8	14	9.3	0	6	6	4.2	6	14	20	6.8
8:00-8:15		4	2	6	4.0	5	3	8	5.6	9	5	14	4.8
8:15-8:30		2	12	14	9.3	2	2	4	2.8	4	14	18	6.1
8:30-8:45		4	1	5	3.3	1	1	2	1.4	5	2	7	2.4
8:45-9:00		2	0	2	1.3	0	1	1	0.7	2	1	3	1.0
	1時間計	12	15	27	17.9	8	7	15	10.6	20	22	42	14.3
9:00-9:15		3	1	4	2.6	0	1	1	0.7	3	2	5	1.7
9:15-9:30		1	0	1	0.7	1	0	1	0.7	2	0	2	0.7
9:30-9:45		1	1	2	1.3	0	0	0	0.0	1	1	2	0.7
9:45-10:00		0	1	1	0.7	0	0	0	0.0	0	1	1	0.3
	1時間計	5	3	8	5.3	1	1	2	1.4	6	4	10	3.4
10:00-10:15		0	0	0	0.0	1	1	2	1.4	1	1	2	0.7
10:15-10:30		1	0	1	0.7	0	0	0	0.0	1	0	1	0.3
10:30-10:45		0	0	0	0.0	0	1	1	0.7	0	1	1	0.3
10:45-11:00		1	0	1	0.7	0	0	0	0.0	1	0	1	0.3
	1時間計	2	0	2	1.3	1	2	3	2.1	3	2	5	1.7
11:00-11:15		0	0	0	0.0	0	0	0	0.0	0	0	0	0.0
11:15-11:30		0	0	0	0.0	0	0	0	0.0	0	0	0	0.0
11:30-11:45		0	0	0	0.0	0	0	0	0.0	0	0	0	0.0
11:45-12:00		0	1	1	0.7	0	1	1	0.7	0	2	2	0.7
	1時間計	0	1	1	0.7	0	1	1	0.7	0	2	2	0.7
12:00-12:15		0	0	0	0.0	0	1	1	0.7	0	1	1	0.3
12:15-12:30		1	0	1	0.7	1	0	1	0.7	2	0	2	0.7
12:30-12:45		0	0	0	0.0	1	0	1	0.7	1	0	1	0.3
12:45-13:00		0	0	0	0.0	0	2	2	1.4	0	2	2	0.7
	1時間計	1	0	1	0.7	2	3	5	3.5	3	3	6	2.0
13:00-13:15		0	0	0	0.0	0	1	1	0.7	0	1	1	0.3
13:15-13:30		0	0	0	0.0	0	1	1	0.7	0	1	1	0.3
13:30-13:45		1	1	2	1.3	1	1	2	1.4	2	2	4	1.4
13:45-14:00		0	0	0	0.0	0	0	0	0.0	0	0	0	0.0
	1時間計	1	1	2	1.3	1	3	4	2.8	2	4	6	2.0
14:00-14:15		0	0	0	0.0	2	1	3	2.1	2	1	3	1.0
14:15-14:30		0	1	1	0.7	3	1	4	2.8	3	2	5	1.7
14:30-14:45		0	2	2	1.3	0	0	0	0.0	0	2	2	0.7
14:45-15:00		1	1	2	1.3	0	1	1	0.7	1	2	3	1.0
	1時間計	1	4	5	3.3	5	3	8	5.6	6	7	13	4.4

歩行者通行量調査表

調査地点 地域社会1 目黒

調査年月日 令和元年 5月14日(火) 天候 雨のち曇り



方向 種別	7				イ				合計			
	歩行者 (人)	自転車 (台)	合計 (人・台)	時間 係数 (%)	歩行者 (人)	自転車 (台)	合計 (人・台)	時間 係数 (%)	歩行者 (人)	自転車 (台)	合計 (人・台)	時間 係数 (%)
時間帯												
15.00-15.15	1	0	1	0.7	3	0	3	2.1	4	0	4	1.4
15.15-15.30	1	1	2	1.3	1	1	2	1.4	2	2	4	1.4
15.30-15.45	1	1	2	1.3	1	3	4	2.8	2	4	6	2.0
15.45-16.00	0	1	1	0.7	0	3	3	2.1	0	4	4	1.4
1時間計	3	3	6	4.0	5	7	12	8.5	8	10	18	6.1
16.00-16.15	0	0	0	0.0	4	2	6	4.2	4	2	6	2.0
16.15-16.30	2	2	4	2.6	1	1	2	1.4	3	3	6	2.0
16.30-16.45	5	4	9	6.0	2	5	7	4.9	7	9	16	5.5
16.45-17.00	2	0	2	1.3	1	0	1	0.7	3	0	3	1.0
1時間計	9	6	15	9.9	8	8	16	11.3	17	14	31	10.6
17.00-17.15	2	1	3	2.0	3	5	8	5.6	5	6	11	3.8
17.15-17.30	1	3	4	2.6	1	4	5	3.5	2	7	9	3.1
17.30-17.45	1	3	4	2.6	4	3	7	4.9	5	6	11	3.8
17.45-18.00	3	4	7	4.6	0	1	1	0.7	3	5	8	2.7
1時間計	7	11	18	11.9	8	13	21	14.8	15	24	39	13.3
18.00-18.15	2	1	3	2.0	1	1	2	1.4	3	2	5	1.7
18.15-18.30	1	0	1	0.7	3	1	4	2.8	4	1	5	1.7
18.30-18.45	3	3	6	4.0	4	2	6	4.2	7	5	12	4.1
18.45-19.00	1	0	1	0.7	0	1	1	0.7	1	1	2	0.7
1時間計	7	4	11	7.3	8	5	13	9.2	15	9	24	8.2
昼12時間計	54	56	110	72.8	47	59	106	74.6	101	115	216	73.7
19.00-19.15	2	3	5	3.3	1	0	1	0.7	3	3	6	2.0
19.15-19.30	1	3	4	2.6	1	1	2	1.4	2	4	6	2.0
19.30-19.45	0	1	1	0.7	3	0	3	2.1	3	1	4	1.4
19.45-20.00	0	0	0	0.0	0	0	0	0.0	0	0	0	0.0
1時間計	3	7	10	6.6	5	1	6	4.2	8	8	16	5.5
20.00-20.15	1	0	1	0.7	0	0	0	0.0	1	0	1	0.3
20.15-20.30	0	0	0	0.0	0	0	0	0.0	0	0	0	0.0
20.30-20.45	0	0	0	0.0	1	0	1	0.7	1	0	1	0.3
20.45-21.00	0	0	0	0.0	0	1	1	0.7	0	1	1	0.3
1時間計	1	0	1	0.7	1	1	2	1.4	2	1	3	1.0
21.00-21.15	0	5	5	3.3	0	1	1	0.7	0	6	6	2.0
21.15-21.30	0	1	1	0.7	0	0	0	0.0	0	1	1	0.3
21.30-21.45	0	0	0	0.0	2	0	2	1.4	2	0	2	0.7
21.45-22.00	0	0	0	0.0	0	0	0	0.0	0	0	0	0.0
1時間計	0	6	6	4.0	2	1	3	2.1	2	7	9	3.1
22.00-22.15	0	2	2	1.3	0	1	1	0.7	0	3	3	1.0
22.15-22.30	0	1	1	0.7	0	3	3	2.1	0	4	4	1.4
22.30-22.45	0	1	1	0.7	1	0	1	0.7	1	1	2	0.7
22.45-23.00	1	1	2	1.3	0	0	0	0.0	1	1	2	0.7
1時間計	1	5	6	4.0	1	4	5	3.5	2	9	11	3.8

歩行者通行量調査表

調査地点 地域社会1 目黒

調査年月日 令和元年 5月14日(火) 天候 雨のち曇り

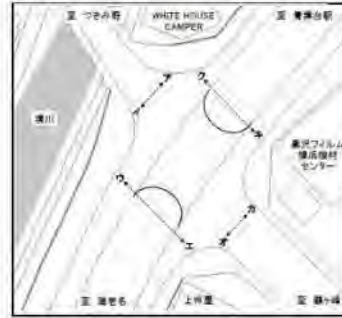

時間帯	方向				合計							
	歩行者 (人)	自転車 (台)	合計 (人・台)	時間 係数 (%)	歩行者 (人)	自転車 (台)	合計 (人・台)	時間 係数 (%)	歩行者 (人)	自転車 (台)	合計 (人・台)	時間 係数 (%)
23:00-23:15	0	0	0	0.0	1	0	1	0.7	1	0	1	0.3
23:15-23:30	0	1	1	0.7	0	0	0	0.0	0	1	1	0.3
23:30-23:45	0	0	0	0.0	1	0	1	0.7	1	0	1	0.3
23:45-24:00	0	1	1	0.7	0	0	0	0.0	0	1	1	0.3
1時間計	0	2	2	1.3	2	0	2	1.4	2	2	4	1.4
0:00-0:15	1	0	1	0.7	0	0	0	0.0	1	0	1	0.3
0:15-0:30	0	0	0	0.0	1	0	1	0.7	1	0	1	0.3
0:30-0:45	0	0	0	0.0	0	0	0	0.0	0	0	0	0.0
0:45-1:00	0	1	1	0.7	0	0	0	0.0	0	1	1	0.3
1時間計	1	1	2	1.3	1	0	1	0.7	2	1	3	1.0
1:00-1:15	1	0	1	0.7	0	0	0	0.0	1	0	1	0.3
1:15-1:30	0	0	0	0.0	0	0	0	0.0	0	0	0	0.0
1:30-1:45	0	0	0	0.0	0	0	0	0.0	0	0	0	0.0
1:45-2:00	0	0	0	0.0	0	0	0	0.0	0	0	0	0.0
1時間計	1	0	1	0.7	0	0	0	0.0	1	0	1	0.3
2:00-2:15	0	0	0	0.0	0	0	0	0.0	0	0	0	0.0
2:15-2:30	0	0	0	0.0	0	0	0	0.0	0	0	0	0.0
2:30-2:45	0	0	0	0.0	0	0	0	0.0	0	0	0	0.0
2:45-3:00	0	0	0	0.0	0	0	0	0.0	0	0	0	0.0
1時間計	0	0	0	0.0	0	0	0	0.0	0	0	0	0.0
3:00-3:15	0	0	0	0.0	0	0	0	0.0	0	0	0	0.0
3:15-3:30	0	0	0	0.0	0	0	0	0.0	0	0	0	0.0
3:30-3:45	0	0	0	0.0	0	0	0	0.0	0	0	0	0.0
3:45-4:00	0	0	0	0.0	0	0	0	0.0	0	0	0	0.0
1時間計	0	0	0	0.0	0	0	0	0.0	0	0	0	0.0
4:00-4:15	0	0	0	0.0	1	0	1	0.7	1	0	1	0.3
4:15-4:30	0	0	0	0.0	0	0	0	0.0	0	0	0	0.0
4:30-4:45	0	0	0	0.0	0	0	0	0.0	0	0	0	0.0
4:45-5:00	0	1	1	0.7	0	0	0	0.0	0	1	1	0.3
1時間計	0	1	1	0.7	1	0	1	0.7	1	1	2	0.7
5:00-5:15	0	0	0	0.0	1	0	1	0.7	1	0	1	0.3
5:15-5:30	0	1	1	0.7	0	1	1	0.7	0	2	2	0.7
5:30-5:45	0	1	1	0.7	0	1	1	0.7	0	2	2	0.7
5:45-6:00	1	0	1	0.7	0	1	1	0.7	1	1	2	0.7
1時間計	1	2	3	2.0	1	3	4	2.8	2	5	7	2.4
6:00-6:15	1	1	2	1.3	0	3	3	2.1	1	4	5	1.7
6:15-6:30	0	2	2	1.3	0	1	1	0.7	0	3	3	1.0
6:30-6:45	0	0	0	0.0	1	1	2	1.4	1	1	2	0.7
6:45-7:00	0	5	5	3.3	3	3	6	4.2	3	8	11	3.8
1時間計	1	8	9	6.0	4	8	12	8.5	5	16	21	7.2
夜12時間計	9	32	41	27.2	18	18	36	25.4	27	50	77	26.3
全時間合計	63	88	151	100.0	65	77	142	100.0	128	165	293	100.0
昼夜平均	1.17	1.57	1.37	-	1.38	1.31	1.34	-	1.27	1.43	1.36	-

歩行者通行量調査表

調査地点 地域社会1 目黒

調査年月日 令和元年 5月14日(火) 天候 雨のち曇り

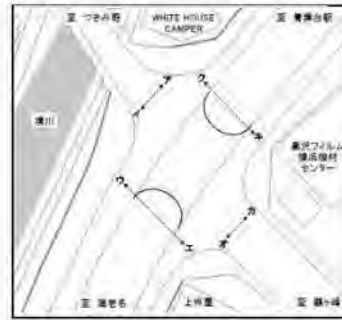

時間帯	ウ				エ				合計				
	種別	歩行者 (人)	自転車 (台)	合計 (人・台)	時間 係数 (%)	歩行者 (人)	自転車 (台)	合計 (人・台)	時間 係数 (%)	歩行者 (人)	自転車 (台)	合計 (人・台)	時間 係数 (%)
7:00-7:15		1	1	2	0.8	3	2	5	2.2	4	3	7	1.4
7:15-7:30		0	4	4	1.5	4	2	6	2.6	4	6	10	2.0
7:30-7:45		1	5	6	2.3	6	10	16	7.0	7	15	22	4.5
7:45-8:00		2	7	9	3.4	12	6	18	7.9	14	13	27	5.5
1時間計		4	17	21	7.9	25	20	45	19.8	29	37	66	13.4
8:00-8:15		2	4	6	2.3	9	14	23	10.1	11	18	29	5.9
8:15-8:30		5	7	12	4.5	9	9	18	7.9	14	16	30	6.1
8:30-8:45		3	3	6	2.3	7	6	13	5.7	10	9	19	3.9
8:45-9:00		0	0	0	0.0	1	3	4	1.8	1	3	4	0.8
1時間計		10	14	24	9.1	26	32	58	25.6	36	46	82	16.7
9:00-9:15		1	0	1	0.4	3	6	9	4.0	4	6	10	2.0
9:15-9:30		0	1	1	0.4	6	1	7	3.1	6	2	8	1.6
9:30-9:45		1	1	2	0.8	1	0	1	0.4	2	1	3	0.6
9:45-10:00		2	4	6	2.3	0	1	1	0.4	2	5	7	1.4
1時間計		4	6	10	3.8	10	8	18	7.9	14	14	28	5.7
10:00-10:15		0	0	0	0.0	3	1	4	1.8	3	1	4	0.8
10:15-10:30		0	0	0	0.0	0	1	1	0.4	0	1	1	0.2
10:30-10:45		0	0	0	0.0	1	0	1	0.4	1	0	1	0.2
10:45-11:00		1	1	2	0.8	1	1	2	0.9	2	2	4	0.8
1時間計		1	1	2	0.8	5	3	8	3.5	6	4	10	2.0
11:00-11:15		0	0	0	0.0	0	0	0	0.0	0	0	0	0.0
11:15-11:30		1	0	1	0.4	1	0	1	0.4	2	0	2	0.4
11:30-11:45		0	0	0	0.0	1	0	1	0.4	1	0	1	0.2
11:45-12:00		1	0	1	0.4	1	0	1	0.4	2	0	2	0.4
1時間計		2	0	2	0.8	3	0	3	1.3	5	0	5	1.0
12:00-12:15		0	3	3	1.1	0	0	0	0.0	0	3	3	0.6
12:15-12:30		5	0	5	1.9	7	1	8	3.5	12	1	13	2.6
12:30-12:45		1	2	3	1.1	2	1	3	1.3	3	3	6	1.2
12:45-13:00		1	1	2	0.8	1	1	2	0.9	2	2	4	0.8
1時間計		7	6	13	4.9	10	3	13	5.7	17	9	26	5.3
13:00-13:15		0	0	0	0.0	3	2	5	2.2	3	2	5	1.0
13:15-13:30		0	0	0	0.0	0	0	0	0.0	0	0	0	0.0
13:30-13:45		4	0	4	1.5	1	0	1	0.4	5	0	5	1.0
13:45-14:00		2	0	2	0.8	0	1	1	0.4	2	1	3	0.6
1時間計		6	0	6	2.3	4	3	7	3.1	10	3	13	2.6
14:00-14:15		0	0	0	0.0	0	0	0	0.0	0	0	0	0.0
14:15-14:30		0	0	0	0.0	0	1	1	0.4	0	1	1	0.2
14:30-14:45		0	1	1	0.4	0	0	0	0.0	0	1	1	0.2
14:45-15:00		0	1	1	0.4	1	0	1	0.4	1	1	2	0.4
1時間計		0	2	2	0.8	1	1	2	0.9	1	3	4	0.8

歩行者通行量調査表

調査地点 地域社会1 目黒

調査年月日 令和元年 5月14日(火) 天候 雨のち曇り

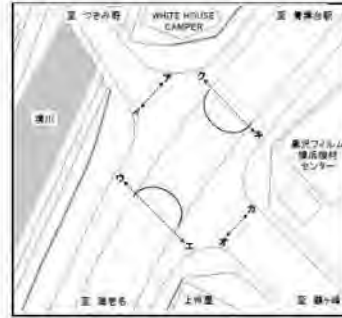

方向	ウ				エ				合計			
	歩行者 (人)	自転車 (台)	合計 (人・台)	時間 係数 (%)	歩行者 (人)	自転車 (台)	合計 (人・台)	時間 係数 (%)	歩行者 (人)	自転車 (台)	合計 (人・台)	時間 係数 (%)
15:00-15:15	0	2	2	0.8	1	0	1	0.4	1	2	3	0.6
15:15-15:30	0	2	2	0.8	0	0	0	0.0	0	2	2	0.4
15:30-15:45	1	3	4	1.5	1	0	1	0.4	2	3	5	1.0
15:45-16:00	0	1	1	0.4	1	1	2	0.9	1	2	3	0.6
1時間計	1	8	9	3.4	3	1	4	1.8	4	9	13	2.6
16:00-16:15	1	2	3	1.1	3	1	4	1.8	4	3	7	1.4
16:15-16:30	3	3	6	2.3	3	0	3	1.3	6	3	9	1.8
16:30-16:45	1	2	3	1.1	0	1	1	0.4	1	3	4	0.8
16:45-17:00	2	3	5	1.9	1	2	3	1.3	3	5	8	1.6
1時間計	7	10	17	6.4	7	4	11	4.8	14	14	28	5.7
17:00-17:15	4	4	8	3.0	1	0	1	0.4	5	4	9	1.8
17:15-17:30	2	3	5	1.9	0	1	1	0.4	2	4	6	1.2
17:30-17:45	6	2	8	3.0	2	0	2	0.9	8	2	10	2.0
17:45-18:00	4	2	6	2.3	0	0	0	0.0	4	2	6	1.2
1時間計	16	11	27	10.2	3	1	4	1.8	19	12	31	6.3
18:00-18:15	6	4	10	3.8	0	2	2	0.9	6	6	12	2.4
18:15-18:30	6	2	8	3.0	0	1	1	0.4	6	3	9	1.8
18:30-18:45	2	6	7	2.6	0	0	0	0.0	2	6	8	1.6
18:45-19:00	8	2	10	3.8	1	2	3	1.3	9	4	13	2.6
1時間計	22	13	35	13.2	1	5	6	2.6	23	18	41	8.3
昼12時間計	80	88	168	63.4	98	81	179	78.9	178	169	347	70.5
19:00-19:15	3	3	6	2.3	0	3	3	1.3	3	6	9	1.8
19:15-19:30	0	5	5	1.9	2	2	4	1.8	2	7	9	1.8
19:30-19:45	2	6	7	2.6	0	1	1	0.4	2	6	8	1.6
19:45-20:00	3	9	12	4.5	0	2	2	0.9	3	11	14	2.8
1時間計	8	22	30	11.3	2	8	10	4.4	10	30	40	8.1
20:00-20:15	6	5	11	4.2	0	4	4	1.8	6	9	15	3.0
20:15-20:30	0	6	6	2.3	1	2	3	1.3	1	8	9	1.8
20:30-20:45	2	2	4	1.5	1	1	2	0.9	3	3	6	1.2
20:45-21:00	3	3	6	2.3	0	1	1	0.4	3	4	7	1.4
1時間計	11	16	27	10.2	2	8	10	4.4	13	24	37	7.5
21:00-21:15	0	3	3	1.1	1	1	2	0.9	1	4	5	1.0
21:15-21:30	1	2	3	1.1	0	0	0	0.0	1	2	3	0.6
21:30-21:45	1	4	5	1.9	1	1	2	0.9	2	5	7	1.4
21:45-22:00	1	3	4	1.5	0	1	1	0.4	1	4	5	1.0
1時間計	3	12	15	5.7	2	3	5	2.2	5	15	20	4.1
22:00-22:15	0	0	0	0.0	0	0	0	0.0	0	0	0	0.0
22:15-22:30	2	4	6	2.3	0	0	0	0.0	2	4	6	1.2
22:30-22:45	1	1	2	0.8	0	1	1	0.4	1	2	3	0.6
22:45-23:00	0	0	0	0.0	0	0	0	0.0	0	0	0	0.0
1時間計	3	5	8	3.0	0	1	1	0.4	3	6	9	1.8

歩行者通行量調査表

調査地点 地域社会1 目黒

調査年月日 令和元年 5月14日(火) 天候 雨のち曇り

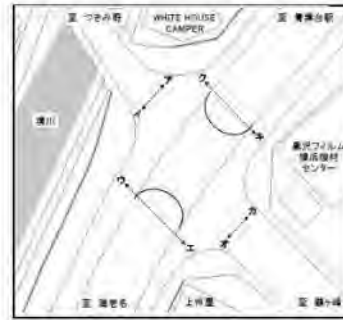

時間帯	ウ				エ				合計			
	歩行者 (人)	自転車 (台)	合計 (人・台)	時間 係数 (%)	歩行者 (人)	自転車 (台)	合計 (人・台)	時間 係数 (%)	歩行者 (人)	自転車 (台)	合計 (人・台)	時間 係数 (%)
23:00-23:15	0	0	0	0.0	1	0	1	0.4	1	0	1	0.2
23:15-23:30	0	0	0	0.0	0	0	0	0.0	0	0	0	0.0
23:30-23:45	0	0	0	0.0	0	0	0	0.0	0	0	0	0.0
23:45-24:00	1	0	1	0.4	0	0	0	0.0	1	0	1	0.2
1時間計	1	0	1	0.4	1	0	1	0.4	2	0	2	0.4
0:00-0:15	0	1	1	0.4	1	0	1	0.4	1	1	2	0.4
0:15-0:30	0	0	0	0.0	0	1	1	0.4	0	1	1	0.2
0:30-0:45	0	0	0	0.0	0	0	0	0.0	0	0	0	0.0
0:45-1:00	1	0	1	0.4	0	0	0	0.0	1	0	1	0.2
1時間計	1	1	2	0.8	1	1	2	0.9	2	2	4	0.8
1:00-1:15	0	0	0	0.0	1	1	2	0.9	1	1	2	0.4
1:15-1:30	0	0	0	0.0	0	0	0	0.0	0	0	0	0.0
1:30-1:45	0	0	0	0.0	0	1	1	0.4	0	1	1	0.2
1:45-2:00	0	0	0	0.0	0	0	0	0.0	0	0	0	0.0
1時間計	0	0	0	0.0	1	2	3	1.3	1	2	3	0.6
2:00-2:15	0	0	0	0.0	0	0	0	0.0	0	0	0	0.0
2:15-2:30	1	0	1	0.4	0	0	0	0.0	1	0	1	0.2
2:30-2:45	0	0	0	0.0	0	0	0	0.0	0	0	0	0.0
2:45-3:00	0	1	1	0.4	0	1	1	0.4	0	2	2	0.4
1時間計	1	1	2	0.8	0	1	1	0.4	1	2	3	0.6
3:00-3:15	0	1	1	0.4	0	0	0	0.0	0	1	1	0.2
3:15-3:30	0	0	0	0.0	0	0	0	0.0	0	0	0	0.0
3:30-3:45	0	0	0	0.0	0	0	0	0.0	0	0	0	0.0
3:45-4:00	0	0	0	0.0	0	0	0	0.0	0	0	0	0.0
1時間計	0	1	1	0.4	0	0	0	0.0	0	1	1	0.2
4:00-4:15	0	0	0	0.0	0	0	0	0.0	0	0	0	0.0
4:15-4:30	0	0	0	0.0	0	0	0	0.0	0	0	0	0.0
4:30-4:45	0	0	0	0.0	0	0	0	0.0	0	0	0	0.0
4:45-5:00	1	0	1	0.4	0	1	1	0.4	1	1	2	0.4
1時間計	1	0	1	0.4	0	1	1	0.4	1	1	2	0.4
5:00-5:15	0	0	0	0.0	0	0	0	0.0	0	0	0	0.0
5:15-5:30	0	0	0	0.0	0	0	0	0.0	0	0	0	0.0
5:30-5:45	1	1	2	0.8	3	0	3	1.3	4	1	5	1.0
5:45-6:00	3	0	3	1.1	2	0	2	0.9	5	0	5	1.0
1時間計	4	1	5	1.9	5	0	5	2.2	9	1	10	2.0
6:00-6:15	0	1	1	0.4	0	1	1	0.4	0	2	2	0.4
6:15-6:30	0	2	2	0.8	0	0	0	0.0	0	2	2	0.4
6:30-6:45	0	1	1	0.4	2	1	3	1.3	2	2	4	0.8
6:45-7:00	0	1	1	0.4	1	4	5	2.2	1	5	6	1.2
1時間計	0	5	5	1.9	3	6	9	4.0	3	11	14	2.8
夜12時間計	33	64	97	36.6	17	31	48	21.1	50	95	145	29.5
全時間合計	113	152	265	100.0	115	112	227	100.0	228	264	492	100.0
昼夜平均	1.41	1.73	1.58	-	1.17	1.38	1.27	-	1.28	1.56	1.42	-

歩行者通行量調査表

調査地点 地域社会1 目黒

調査年月日 令和元年 5月14日(火) 天候 雨のち曇り

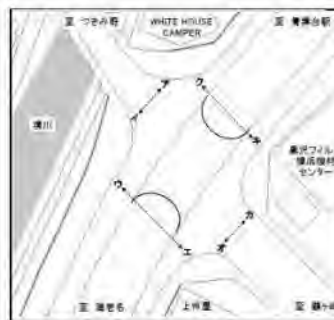

方向	ア				カ				合計				
	種別	歩行者 (人)	自転車 (台)	合計 (人・台)	時間 係数 (%)	歩行者 (人)	自転車 (台)	合計 (人・台)	時間 係数 (%)	歩行者 (人)	自転車 (台)	合計 (人・台)	時間 係数 (%)
時間帯													
7:00-7:15		0	1	1	1.0	0	0	0	0.0	0	1	1	0.5
7:15-7:30		4	3	7	7.2	1	0	1	1.0	5	3	8	4.0
7:30-7:45		0	3	3	3.1	0	6	6	5.8	0	9	9	4.5
7:45-8:00		1	5	6	6.2	1	2	3	2.9	2	7	9	4.5
1時間計		5	12	17	17.5	2	8	10	9.7	7	20	27	13.5
8:00-8:15		1	0	1	1.0	1	0	1	1.0	2	0	2	1.0
8:15-8:30		1	1	2	2.1	1	1	2	1.9	2	2	4	2.0
8:30-8:45		2	0	2	2.1	0	1	1	1.0	2	1	3	1.5
8:45-9:00		1	2	3	3.1	1	1	2	1.9	2	3	5	2.5
1時間計		5	3	8	8.2	3	3	6	5.8	8	6	14	7.0
9:00-9:15		0	0	0	0.0	0	0	0	0.0	0	0	0	0.0
9:15-9:30		0	0	0	0.0	0	0	0	0.0	0	0	0	0.0
9:30-9:45		0	0	0	0.0	1	2	3	2.9	1	2	3	1.5
9:45-10:00		0	0	0	0.0	1	2	3	2.9	1	2	3	1.5
1時間計		0	0	0	0.0	2	4	6	5.8	2	4	6	3.0
10:00-10:15		0	0	0	0.0	1	1	2	1.9	1	1	2	1.0
10:15-10:30		0	0	0	0.0	0	0	0	0.0	0	0	0	0.0
10:30-10:45		0	0	0	0.0	0	0	0	0.0	0	0	0	0.0
10:45-11:00		0	0	0	0.0	2	0	2	1.9	2	0	2	1.0
1時間計		0	0	0	0.0	3	1	4	3.9	3	1	4	2.0
11:00-11:15		0	0	0	0.0	0	0	0	0.0	0	0	0	0.0
11:15-11:30		1	0	1	1.0	0	1	1	1.0	1	1	2	1.0
11:30-11:45		0	0	0	0.0	0	0	0	0.0	0	0	0	0.0
11:45-12:00		0	0	0	0.0	0	0	0	0.0	0	0	0	0.0
1時間計		1	0	1	1.0	0	1	1	1.0	1	1	2	1.0
12:00-12:15		3	0	3	3.1	1	2	3	2.9	4	2	6	3.0
12:15-12:30		4	1	5	5.2	6	2	8	7.6	10	3	13	6.5
12:30-12:45		1	0	1	1.0	1	0	1	1.0	2	0	2	1.0
12:45-13:00		0	1	1	1.0	0	0	0	0.0	0	1	1	0.5
1時間計		8	2	10	10.3	8	4	12	11.7	16	6	22	11.0
13:00-13:15		0	0	0	0.0	0	3	3	2.9	0	3	3	1.5
13:15-13:30		1	1	2	2.1	3	0	3	2.9	4	1	5	2.5
13:30-13:45		2	1	3	3.1	2	0	2	1.9	4	1	5	2.5
13:45-14:00		1	0	1	1.0	1	0	1	1.0	2	0	2	1.0
1時間計		4	2	6	6.2	6	3	9	8.7	10	5	15	7.5
14:00-14:15		0	0	0	0.0	1	0	1	1.0	1	0	1	0.5
14:15-14:30		0	0	0	0.0	1	0	1	1.0	1	0	1	0.5
14:30-14:45		0	0	0	0.0	1	0	1	1.0	1	0	1	0.5
14:45-15:00		0	0	0	0.0	1	0	1	1.0	1	0	1	0.5
1時間計		0	0	0	0.0	4	0	4	3.9	4	0	4	2.0

歩行者通行量調査表

調査地点 地域社会1 目黒

調査年月日 令和元年 5月14日(火) 天候 雨のち曇り

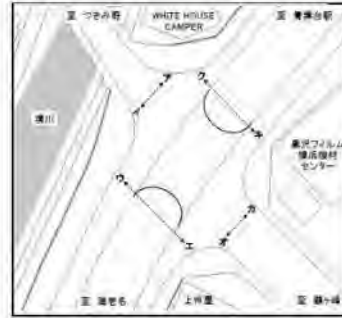

時間帯	方向				合計							
	歩行者 (人)	自転車 (台)	合計 (人・台)	時間 係数 (%)	歩行者 (人)	自転車 (台)	合計 (人・台)	時間 係数 (%)	歩行者 (人)	自転車 (台)	合計 (人・台)	時間 係数 (%)
15:00-15:15	0	0	0	0.0	0	0	0	0.0	0	0	0	0.0
15:15-15:30	0	0	0	0.0	0	0	0	0.0	0	0	0	0.0
15:30-15:45	0	0	0	0.0	1	0	1	1.0	1	0	1	0.5
15:45-16:00	0	0	0	0.0	1	0	1	1.0	1	0	1	0.5
1時間計	0	0	0	0.0	2	0	2	1.9	2	0	2	1.0
16:00-16:15	0	0	0	0.0	0	1	1	1.0	0	1	1	0.5
16:15-16:30	2	0	2	2.1	0	0	0	0.0	2	0	2	1.0
16:30-16:45	0	0	0	0.0	3	0	3	2.9	3	0	3	1.5
16:45-17:00	1	2	3	3.1	0	0	0	0.0	1	2	3	1.5
1時間計	3	2	5	5.2	3	1	4	3.9	6	3	9	4.5
17:00-17:15	0	0	0	0.0	0	0	0	0.0	0	0	0	0.0
17:15-17:30	1	1	2	2.1	1	1	2	1.9	2	2	4	2.0
17:30-17:45	0	3	3	3.1	0	1	1	1.0	0	4	4	2.0
17:45-18:00	0	2	2	2.1	0	3	3	2.9	0	5	5	2.5
1時間計	1	6	7	7.2	1	5	6	5.8	2	11	13	6.5
18:00-18:15	0	0	0	0.0	0	5	5	4.9	0	5	5	2.5
18:15-18:30	1	2	3	3.1	2	1	3	2.9	3	3	6	3.0
18:30-18:45	1	1	2	2.1	2	1	3	2.9	3	2	5	2.5
18:45-19:00	0	1	1	1.0	1	2	3	2.9	1	3	4	2.0
1時間計	2	4	6	6.2	5	9	14	13.6	7	13	20	10.0
昼12時間計	29	31	60	61.9	39	39	78	75.7	68	70	138	69.0
19:00-19:15	0	2	2	2.1	3	3	6	5.8	3	5	8	4.0
19:15-19:30	1	0	1	1.0	1	1	2	1.9	2	1	3	1.5
19:30-19:45	0	1	1	1.0	0	1	1	1.0	0	2	2	1.0
19:45-20:00	1	0	1	1.0	3	0	3	2.9	4	0	4	2.0
1時間計	2	3	5	5.2	7	5	12	11.7	9	8	17	8.5
20:00-20:15	2	1	3	3.1	0	0	0	0.0	2	1	3	1.5
20:15-20:30	0	1	1	1.0	0	2	2	1.9	0	3	3	1.5
20:30-20:45	0	0	0	0.0	0	0	0	0.0	0	0	0	0.0
20:45-21:00	0	2	2	2.1	0	0	0	0.0	0	2	2	1.0
1時間計	2	4	6	6.2	0	2	2	1.9	2	6	8	4.0
21:00-21:15	0	0	0	0.0	0	0	0	0.0	0	0	0	0.0
21:15-21:30	0	1	1	1.0	0	0	0	0.0	0	1	1	0.5
21:30-21:45	0	0	0	0.0	0	0	0	0.0	0	0	0	0.0
21:45-22:00	0	0	0	0.0	0	0	0	0.0	0	0	0	0.0
1時間計	0	1	1	1.0	0	0	0	0.0	0	1	1	0.5
22:00-22:15	0	0	0	0.0	0	0	0	0.0	0	0	0	0.0
22:15-22:30	0	1	1	1.0	0	0	0	0.0	0	1	1	0.5
22:30-22:45	0	0	0	0.0	0	0	0	0.0	0	0	0	0.0
22:45-23:00	0	0	0	0.0	0	0	0	0.0	0	0	0	0.0
1時間計	0	1	1	1.0	0	0	0	0.0	0	1	1	0.5

歩行者通行量調査表

調査地点：地域社会1 目黒

調査年月日：令和元年 5月14日(火) 天候：雨のち曇り

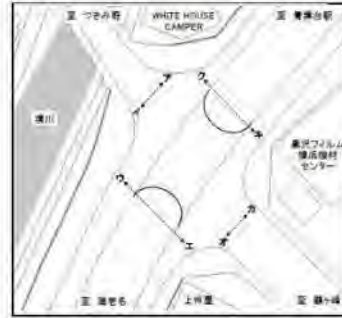

方向	ア				カ				合計				
	種別	歩行者 (人)	自転車 (台)	合計 (人・台)	時間 係数 (%)	歩行者 (人)	自転車 (台)	合計 (人・台)	時間 係数 (%)	歩行者 (人)	自転車 (台)	合計 (人・台)	時間 係数 (%)
時間帯													
23:00-23:15		0	0	0	0.0	2	0	2	1.9	2	0	2	1.0
23:15-23:30		0	0	0	0.0	0	0	0	0.0	0	0	0	0.0
23:30-23:45		0	0	0	0.0	0	0	0	0.0	0	0	0	0.0
23:45-24:00		0	0	0	0.0	0	0	0	0.0	0	0	0	0.0
1時間計		0	0	0	0.0	2	0	2	1.9	2	0	2	1.0
0:00-0:15		0	0	0	0.0	0	0	0	0.0	0	0	0	0.0
0:15-0:30		0	0	0	0.0	0	0	0	0.0	0	0	0	0.0
0:30-0:45		1	0	1	1.0	0	0	0	0.0	1	0	1	0.5
0:45-1:00		0	0	0	0.0	0	0	0	0.0	0	0	0	0.0
1時間計		1	0	1	1.0	0	0	0	0.0	1	0	1	0.5
1:00-1:15		0	1	1	1.0	0	0	0	0.0	0	1	1	0.5
1:15-1:30		0	0	0	0.0	0	0	0	0.0	0	0	0	0.0
1:30-1:45		0	0	0	0.0	0	0	0	0.0	0	0	0	0.0
1:45-2:00		0	0	0	0.0	0	0	0	0.0	0	0	0	0.0
1時間計		0	1	1	1.0	0	0	0	0.0	0	1	1	0.5
2:00-2:15		0	0	0	0.0	0	0	0	0.0	0	0	0	0.0
2:15-2:30		1	1	2	2.1	0	0	0	0.0	1	1	2	1.0
2:30-2:45		0	0	0	0.0	0	0	0	0.0	0	0	0	0.0
2:45-3:00		0	0	0	0.0	0	0	0	0.0	0	0	0	0.0
1時間計		1	1	2	2.1	0	0	0	0.0	1	1	2	1.0
3:00-3:15		0	0	0	0.0	0	0	0	0.0	0	0	0	0.0
3:15-3:30		0	0	0	0.0	0	0	0	0.0	0	0	0	0.0
3:30-3:45		0	0	0	0.0	0	0	0	0.0	0	0	0	0.0
3:45-4:00		0	0	0	0.0	0	0	0	0.0	0	0	0	0.0
1時間計		0	0	0	0.0	0	0	0	0.0	0	0	0	0.0
4:00-4:15		1	0	1	1.0	0	0	0	0.0	1	0	1	0.5
4:15-4:30		0	0	0	0.0	0	0	0	0.0	0	0	0	0.0
4:30-4:45		0	0	0	0.0	0	0	0	0.0	0	0	0	0.0
4:45-5:00		0	1	1	1.0	0	0	0	0.0	0	1	1	0.5
1時間計		1	1	2	2.1	0	0	0	0.0	1	1	2	1.0
5:00-5:15		0	0	0	0.0	0	0	0	0.0	0	0	0	0.0
5:15-5:30		1	0	1	1.0	0	0	0	0.0	1	0	1	0.5
5:30-5:45		0	1	1	1.0	0	0	0	0.0	0	1	1	0.5
5:45-6:00		1	1	2	2.1	0	0	0	0.0	1	1	2	1.0
1時間計		2	2	4	4.1	0	0	0	0.0	2	2	4	2.0
6:00-6:15		1	1	2	2.1	0	3	3	2.9	1	4	5	2.5
6:15-6:30		1	0	1	1.0	0	1	1	1.0	1	1	2	1.0
6:30-6:45		3	1	4	4.1	0	0	0	0.0	3	1	4	2.0
6:45-7:00		0	7	7	7.2	2	3	5	4.9	2	10	12	6.0
1時間計		5	9	14	14.4	2	7	9	8.7	7	16	23	11.5
夜12時間計		14	23	37	36.1	11	14	25	24.3	25	37	62	31.0
全時間合計		43	54	97	100.0	50	53	103	100.0	93	107	200	100.0
昼夜平均		1.48	1.74	1.62	-	1.28	1.36	1.32	-	1.37	1.53	1.45	-

歩行者通行量調査表

調査地点 地域社会1 目黒

調査年月日 令和元年 5月14日(火) 天候 雨のち曇り



時間帯	キ				ウ				合計			
	歩行者 (人)	自転車 (台)	合計 (人・台)	時間 係数 (%)	歩行者 (人)	自転車 (台)	合計 (人・台)	時間 係数 (%)	歩行者 (人)	自転車 (台)	合計 (人・台)	時間 係数 (%)
7:00-7:15	1	5	6	2.0	1	2	3	0.9	2	6	8	1.5
7:15-7:30	5	4	9	2.9	3	4	7	3.2	8	8	16	3.0
7:30-7:45	6	11	17	5.6	2	1	3	1.4	8	12	20	3.8
7:45-8:00	4	3	7	2.3	2	2	4	1.8	6	5	11	2.1
1時間計	16	23	39	12.7	8	8	16	7.2	24	31	55	10.4
8:00-8:15	4	8	12	3.9	1	6	7	3.2	5	14	19	3.6
8:15-8:30	3	16	19	6.2	3	2	5	2.3	6	18	24	4.5
8:30-8:45	4	14	18	5.9	2	1	3	1.4	6	15	21	4.0
8:45-9:00	3	4	7	2.3	1	2	3	1.4	4	6	10	1.9
1時間計	14	42	56	18.3	7	11	18	8.1	21	53	74	14.0
9:00-9:15	1	0	1	0.3	0	0	0	0.0	1	0	1	0.2
9:15-9:30	1	0	1	0.3	1	1	2	0.9	2	1	3	0.6
9:30-9:45	0	0	0	0.0	0	0	0	0.0	0	0	0	0.0
9:45-10:00	0	2	2	0.7	0	0	0	0.0	0	2	2	0.4
1時間計	2	2	4	1.3	1	1	2	0.9	3	3	6	1.1
10:00-10:15	0	1	1	0.3	0	0	0	0.0	0	1	1	0.2
10:15-10:30	0	0	0	0.0	0	0	0	0.0	0	0	0	0.0
10:30-10:45	0	1	1	0.3	0	1	1	0.5	0	2	2	0.4
10:45-11:00	0	0	0	0.0	0	0	0	0.0	0	0	0	0.0
1時間計	0	2	2	0.7	0	1	1	0.5	0	3	3	0.6
11:00-11:15	0	0	0	0.0	0	0	0	0.0	0	0	0	0.0
11:15-11:30	0	1	1	0.3	0	0	0	0.0	0	1	1	0.2
11:30-11:45	0	0	0	0.0	0	0	0	0.0	0	0	0	0.0
11:45-12:00	0	0	0	0.0	0	0	0	0.0	0	0	0	0.0
1時間計	0	1	1	0.3	0	0	0	0.0	0	1	1	0.2
12:00-12:15	0	0	0	0.0	4	2	6	2.7	4	2	6	1.1
12:15-12:30	1	1	2	0.7	1	0	1	0.5	2	1	3	0.6
12:30-12:45	0	1	1	0.3	0	0	0	0.0	0	1	1	0.2
12:45-13:00	0	0	0	0.0	1	0	1	0.5	1	0	1	0.2
1時間計	1	2	3	1.0	6	2	8	3.6	7	4	11	2.1
13:00-13:15	1	1	2	0.7	1	2	3	1.4	2	3	5	0.9
13:15-13:30	2	1	3	1.0	2	4	6	2.7	4	5	9	1.7
13:30-13:45	2	3	5	1.6	0	3	3	1.4	2	6	8	1.5
13:45-14:00	1	0	1	0.3	1	2	3	1.4	2	2	4	0.8
1時間計	6	5	11	3.6	4	11	15	6.8	10	16	26	4.9
14:00-14:15	1	3	4	1.3	2	1	3	1.4	3	4	7	1.3
14:15-14:30	2	2	4	1.3	1	1	2	0.9	3	3	6	1.1
14:30-14:45	0	2	2	0.7	1	1	2	0.9	1	3	4	0.8
14:45-15:00	3	2	5	1.6	1	2	3	1.4	4	4	8	1.5
1時間計	6	9	15	4.9	5	5	10	4.5	11	14	25	4.7

歩行者通行量調査表

調査地点 地域社会1 目黒

調査年月日 令和元年 5月14日(火) 天候 雨のち曇り

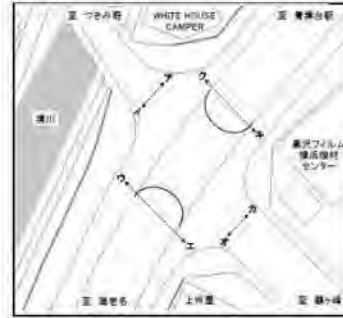

時間帯	キ				ウ				合計			
	歩行者 (人)	自転車 (台)	合計 (人・台)	時間 係数 (%)	歩行者 (人)	自転車 (台)	合計 (人・台)	時間 係数 (%)	歩行者 (人)	自転車 (台)	合計 (人・台)	時間 係数 (%)
15:00-15:15	1	0	1	0.3	0	1	1	0.5	1	1	2	0.4
15:15-15:30	2	2	4	1.3	2	0	2	0.9	4	2	6	1.1
15:30-15:45	1	4	5	1.6	3	2	5	2.3	4	6	10	1.9
15:45-16:00	0	1	1	0.3	2	1	3	1.4	2	2	4	0.8
1時間計	4	7	11	3.6	7	4	11	5.0	11	11	22	4.2
16:00-16:15	4	3	7	2.3	4	0	4	1.8	8	3	11	2.1
16:15-16:30	3	3	6	2.0	5	4	9	4.1	8	7	15	2.8
16:30-16:45	3	3	6	2.0	6	3	9	4.1	9	6	15	2.8
16:45-17:00	5	3	8	2.6	0	1	1	0.5	5	4	9	1.7
1時間計	15	12	27	8.8	15	8	23	10.4	30	20	50	9.5
17:00-17:15	1	4	5	1.6	5	1	6	2.7	6	5	11	2.1
17:15-17:30	1	1	2	0.7	1	10	11	5.0	2	11	13	2.5
17:30-17:45	2	2	4	1.3	4	6	10	4.5	6	8	14	2.7
17:45-18:00	1	6	7	2.3	2	4	6	2.7	3	10	13	2.5
1時間計	5	13	18	5.9	12	21	33	14.9	17	34	51	9.7
18:00-18:15	0	0	0	0.0	1	7	8	3.6	1	7	8	1.5
18:15-18:30	0	1	1	0.3	2	3	5	2.3	2	4	6	1.1
18:30-18:45	0	2	2	0.7	1	4	5	2.3	1	6	7	1.3
18:45-19:00	0	0	0	0.0	1	0	1	0.5	1	0	1	0.2
1時間計	0	3	3	1.0	5	14	19	8.6	5	17	22	4.2
昼12時間計	69	121	190	62.1	70	86	156	70.3	139	207	346	65.5
19:00-19:15	7	6	13	4.2	4	2	6	2.7	11	8	19	3.6
19:15-19:30	0	4	4	1.3	0	1	1	0.5	0	5	5	0.9
19:30-19:45	7	1	8	2.6	3	2	5	2.3	10	3	13	2.5
19:45-20:00	2	1	3	1.0	0	1	1	0.5	2	2	4	0.8
1時間計	16	12	28	9.2	7	6	13	5.9	23	18	41	7.8
20:00-20:15	1	1	2	0.7	2	1	3	1.4	3	2	5	0.9
20:15-20:30	2	5	7	2.3	0	4	4	1.8	2	9	11	2.1
20:30-20:45	2	2	4	1.3	1	0	1	0.5	3	2	5	0.9
20:45-21:00	3	1	4	1.3	0	1	1	0.5	3	2	5	0.9
1時間計	8	9	17	5.6	3	6	9	4.1	11	15	26	4.9
21:00-21:15	1	0	1	0.3	3	0	3	1.4	4	0	4	0.8
21:15-21:30	1	4	5	1.6	2	2	4	1.8	3	6	9	1.7
21:30-21:45	1	0	1	0.3	0	1	1	0.5	1	1	2	0.4
21:45-22:00	1	0	1	0.3	0	1	1	0.5	1	1	2	0.4
1時間計	4	4	8	2.6	5	4	9	4.1	9	8	17	3.2
22:00-22:15	2	4	6	2.0	3	1	4	1.8	5	5	10	1.9
22:15-22:30	0	4	4	1.3	0	3	3	1.4	0	7	7	1.3
22:30-22:45	5	2	7	2.3	1	0	1	0.5	6	2	8	1.5
22:45-23:00	2	2	4	1.3	1	0	1	0.5	3	2	5	0.9
1時間計	9	12	21	6.9	5	4	9	4.1	14	16	30	5.7

歩行者通行量調査表

調査地点 地域社会1 目黒

調査年月日 令和元年 5月14日(火) 天候 雨のち曇り

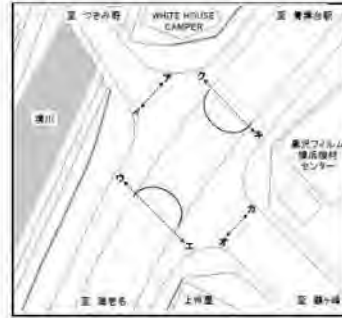

方向	キ				ウ				合計				
	種別	歩行者 (人)	自転車 (台)	合計 (人・台)	時間 係数 (%)	歩行者 (人)	自転車 (台)	合計 (人・台)	時間 係数 (%)	歩行者 (人)	自転車 (台)	合計 (人・台)	時間 係数 (%)
時間帯													
23:00-23:15		0	1	1	0.3	2	0	2	0.9	2	1	3	0.6
23:15-23:30		0	0	0	0.0	0	0	0	0.0	0	0	0	0.0
23:30-23:45		2	0	2	0.7	0	0	0	0.0	2	0	2	0.4
23:45-24:00		0	0	0	0.0	0	0	0	0.0	0	0	0	0.0
1時間計		2	1	3	1.0	2	0	2	0.9	4	1	5	0.9
0:00-0:15		0	0	0	0.0	0	0	0	0.0	0	0	0	0.0
0:15-0:30		0	0	0	0.0	0	0	0	0.0	0	0	0	0.0
0:30-0:45		0	0	0	0.0	0	0	0	0.0	0	0	0	0.0
0:45-1:00		0	0	0	0.0	0	0	0	0.0	0	0	0	0.0
1時間計		0	0	0	0.0	0	0	0	0.0	0	0	0	0.0
1:00-1:15		0	0	0	0.0	0	1	1	0.5	0	1	1	0.2
1:15-1:30		1	0	1	0.3	0	0	0	0.0	1	0	1	0.2
1:30-1:45		0	1	1	0.3	0	0	0	0.0	0	1	1	0.2
1:45-2:00		0	0	0	0.0	0	0	0	0.0	0	0	0	0.0
1時間計		1	1	2	0.7	0	1	1	0.5	1	2	3	0.6
2:00-2:15		0	0	0	0.0	0	0	0	0.0	0	0	0	0.0
2:15-2:30		0	0	0	0.0	0	1	1	0.5	0	1	1	0.2
2:30-2:45		0	0	0	0.0	0	0	0	0.0	0	0	0	0.0
2:45-3:00		0	0	0	0.0	1	0	1	0.5	1	0	1	0.2
1時間計		0	0	0	0.0	1	1	2	0.9	1	1	2	0.4
3:00-3:15		0	0	0	0.0	0	1	1	0.5	0	1	1	0.2
3:15-3:30		0	0	0	0.0	0	0	0	0.0	0	0	0	0.0
3:30-3:45		0	0	0	0.0	0	0	0	0.0	0	0	0	0.0
3:45-4:00		0	0	0	0.0	0	0	0	0.0	0	0	0	0.0
1時間計		0	0	0	0.0	0	1	1	0.5	0	1	1	0.2
4:00-4:15		1	0	1	0.3	0	0	0	0.0	1	0	1	0.2
4:15-4:30		0	0	0	0.0	0	0	0	0.0	0	0	0	0.0
4:30-4:45		1	0	1	0.3	0	0	0	0.0	1	0	1	0.2
4:45-5:00		0	0	0	0.0	1	1	2	0.9	1	1	2	0.4
1時間計		2	0	2	0.7	1	1	2	0.9	3	1	4	0.8
5:00-5:15		0	0	0	0.0	0	0	0	0.0	0	0	0	0.0
5:15-5:30		2	2	4	1.3	1	1	2	0.9	3	3	6	1.1
5:30-5:45		0	3	3	1.0	0	0	0	0.0	0	3	3	0.6
5:45-6:00		0	5	5	1.6	2	4	6	2.7	2	9	11	2.1
1時間計		2	10	12	3.9	3	5	8	3.6	5	15	20	3.8
6:00-6:15		1	5	6	2.0	1	2	3	1.4	2	7	9	1.7
6:15-6:30		2	8	10	3.3	1	2	3	1.4	3	10	13	2.5
6:30-6:45		2	2	4	1.3	0	3	3	1.4	2	5	7	1.3
6:45-7:00		1	2	3	1.0	0	1	1	0.5	1	3	4	0.8
1時間計		6	17	23	7.5	2	8	10	4.5	8	25	33	6.3
夜12時間計		50	66	116	37.9	29	37	66	29.7	79	103	182	34.5
全時間合計		119	187	306	100.0	99	123	222	100.0	218	310	528	100.0
昼夜平均		1.72	1.55	1.61	-	1.41	1.43	1.42	-	1.57	1.50	1.53	-

歩行者通行量調査表

調査地点 地域社会1 目黒

調査年月日 令和元年 5月14日(火) 天候 雨のち曇り

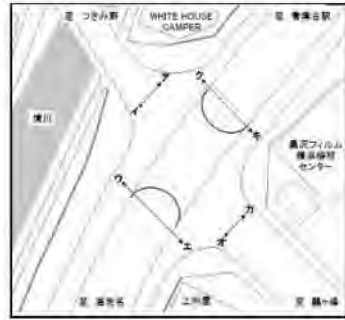

時間帯	方向	合計 (7+イ+ウ+エ+オ+カ+キ+ク)				
		種別	歩行者 (人)	自転車 (台)	合計 (人・台)	時間係数 (%)
7:00-7:15			6	10	16	1.1
7:15-7:30			19	19	38	2.5
7:30-7:45			19	41	60	4.0
7:45-8:00			22	32	54	3.6
1時間計			66	102	168	11.1
8:00-8:15			27	37	64	4.2
8:15-8:30			26	50	76	5.0
8:30-8:45			23	27	50	3.3
8:45-9:00			9	13	22	1.5
1時間計			85	127	212	14.0
9:00-9:15			8	8	16	1.1
9:15-9:30			10	3	13	0.9
9:30-9:45			4	4	8	0.5
9:45-10:00			3	10	13	0.9
1時間計			25	25	50	3.3
10:00-10:15			5	4	9	0.6
10:15-10:30			1	1	2	0.1
10:30-10:45			1	3	4	0.3
10:45-11:00			5	2	7	0.5
1時間計			12	10	22	1.5
11:00-11:15			0	0	0	0.0
11:15-11:30			3	2	5	0.3
11:30-11:45			1	0	1	0.1
11:45-12:00			2	2	4	0.3
1時間計			6	4	10	0.7
12:00-12:15			8	8	16	1.1
12:15-12:30			26	5	31	2.0
12:30-12:45			6	4	10	0.7
12:45-13:00			3	5	8	0.5
1時間計			43	22	65	4.3
13:00-13:15			5	9	14	0.9
13:15-13:30			8	7	15	1.0
13:30-13:45			13	9	22	1.5
13:45-14:00			6	3	9	0.6
1時間計			32	28	60	4.0
14:00-14:15			6	5	11	0.7
14:15-14:30			7	6	13	0.9
14:30-14:45			2	6	8	0.5
14:45-15:00			7	7	14	0.9
1時間計			22	24	46	3.0
15:00-15:15			6	3	9	0.6
15:15-15:30			6	6	12	0.8
15:30-15:45			9	13	22	1.5
15:45-16:00			4	8	12	0.8
1時間計			25	30	55	3.6
16:00-16:15			16	9	25	1.7
16:15-16:30			19	13	32	2.1
16:30-16:45			20	18	38	2.5
16:45-17:00			12	11	23	1.5
1時間計			67	51	118	7.8
17:00-17:15			16	15	31	2.0
17:15-17:30			8	24	32	2.1
17:30-17:45			19	20	39	2.6
17:45-18:00			10	22	32	2.1
1時間計			53	81	134	8.9
18:00-18:15			10	20	30	2.0
18:15-18:30			15	11	26	1.7
18:30-18:45			13	18	31	2.0
18:45-19:00			12	8	20	1.3
1時間計			50	57	107	7.1
昼12時間計			486	561	1047	69.2

時間帯	方向	合計 (7+イ+ウ+エ+オ+カ+キ+ク)				
		種別	歩行者 (人)	自転車 (台)	合計 (人・台)	時間係数 (%)
7:00-8:00			66	102	168	11.1
7:15-8:15			87	129	216	14.3
7:30-8:30			94	160	254	16.8
7:45-8:45			98	146	244	16.1
8:00-9:00			85	127	212	14.0
8:15-9:15			66	98	164	10.8
8:30-9:30			50	51	101	6.7
8:45-9:45			31	28	59	3.9
9:00-10:00			25	25	50	3.3
9:15-10:15			22	21	43	2.8
9:30-10:30			13	19	32	2.1
9:45-10:45			10	18	28	1.9
10:00-11:00			12	10	22	1.5
10:15-11:15			7	6	13	0.9
10:30-11:30			9	7	16	1.1
10:45-11:45			9	4	13	0.9
11:00-12:00			6	4	10	0.7
11:15-12:15			14	12	26	1.7
11:30-12:30			37	15	52	3.4
11:45-12:45			42	19	61	4.0
12:00-13:00			43	22	65	4.3
12:15-13:15			40	23	63	4.2
12:30-13:30			22	25	47	3.1
12:45-13:45			29	30	59	3.9
13:00-14:00			32	28	60	4.0
13:15-14:15			33	24	57	3.8
13:30-14:30			32	23	55	3.6
13:45-14:45			21	20	41	2.7
14:00-15:00			22	24	46	3.0
14:15-15:15			22	22	44	2.9
14:30-15:30			21	22	43	2.8
14:45-15:45			28	29	57	3.8
15:00-16:00			25	30	55	3.6
15:15-16:15			35	36	71	4.7
15:30-16:30			48	43	91	6.0
15:45-16:45			59	48	107	7.1
16:00-17:00			67	51	118	7.8
16:15-17:15			67	57	124	8.2
16:30-17:30			56	68	124	8.2
16:45-17:45			55	70	125	8.3
17:00-18:00			53	81	134	8.9
17:15-18:15			47	86	133	8.8
17:30-18:30			54	73	127	8.4
17:45-18:45			48	71	119	7.9
18:00-19:00			50	57	107	7.1
18:15-19:15			60	59	119	7.9
18:30-19:30			51	65	116	7.7
18:45-19:45			53	59	112	7.4
19:00-20:00			50	64	114	7.5
19:15-20:15			42	54	96	6.3
19:30-20:30			39	57	96	6.3
19:45-20:45			31	50	81	5.4
20:00-21:00			28	46	74	4.9
20:15-21:15			21	44	65	4.3
20:30-21:30			22	34	56	3.7
20:45-21:45			20	35	55	3.6
21:00-22:00			16	31	47	3.1
21:15-22:15			16	29	45	3.0
21:30-22:30			14	35	49	3.2
21:45-22:45			17	34	51	3.4
22:00-23:00			19	32	51	3.4

歩行者通行量調査表

調査地点 地域社会1 目黒

調査年月日 令和元年 5月14日(火) 天候 雨のち曇り

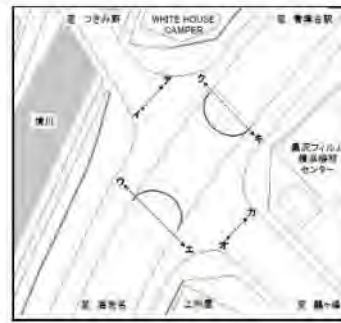

時間帯	方向	合計 (7+イ+ウ+エ+オ+カ+キ+ク)			
		歩行者 (人)	自転車 (台)	合計 (人・台)	時間 係数 (%)
19:00-19:15		20	22	42	2.8
19:15-19:30		6	17	23	1.5
19:30-19:45		15	12	27	1.8
19:45-20:00		9	13	22	1.5
1時間計		50	64	114	7.5
20:00-20:15		12	12	24	1.6
20:15-20:30		3	20	23	1.5
20:30-20:45		7	5	12	0.8
20:45-21:00		6	9	15	1.0
1時間計		28	46	74	4.9
21:00-21:15		5	10	15	1.0
21:15-21:30		4	10	14	0.9
21:30-21:45		5	6	11	0.7
21:45-22:00		2	5	7	0.5
1時間計		16	31	47	3.1
22:00-22:15		5	8	13	0.9
22:15-22:30		2	16	18	1.2
22:30-22:45		8	5	13	0.9
22:45-23:00		4	3	7	0.5
1時間計		19	32	51	3.4
23:00-23:15		6	1	7	0.5
23:15-23:30		0	1	1	0.1
23:30-23:45		3	0	3	0.2
23:45-24:00		1	1	2	0.1
1時間計		10	3	13	0.9
0:00-0:15		2	1	3	0.2
0:15-0:30		1	1	2	0.1
0:30-0:45		1	0	1	0.1
0:45-1:00		1	1	2	0.1
1時間計		5	3	8	0.5
1:00-1:15		2	3	5	0.3
1:15-1:30		1	0	1	0.1
1:30-1:45		0	2	2	0.1
1:45-2:00		0	0	0	0.0
1時間計		3	5	8	0.5
2:00-2:15		0	0	0	0.0
2:15-2:30		2	2	4	0.3
2:30-2:45		0	0	0	0.0
2:45-3:00		1	2	3	0.2
1時間計		3	4	7	0.5
3:00-3:15		0	2	2	0.1
3:15-3:30		0	0	0	0.0
3:30-3:45		0	0	0	0.0
3:45-4:00		0	0	0	0.0
1時間計		0	2	2	0.1
4:00-4:15		3	0	3	0.2
4:15-4:30		0	0	0	0.0
4:30-4:45		1	0	1	0.1
4:45-5:00		2	4	6	0.4
1時間計		6	4	10	0.7
5:00-5:15		1	0	1	0.1
5:15-5:30		4	5	9	0.6
5:30-5:45		4	7	11	0.7
5:45-6:00		9	11	20	1.3
1時間計		18	23	41	2.7
6:00-6:15		4	17	21	1.4
6:15-6:30		4	16	20	1.3
6:30-6:45		8	9	17	1.1
6:45-7:00		7	26	33	2.2
1時間計		23	68	91	6.0
夜12時間計		181	285	466	30.8
全時間合計		667	846	1513	100.0
昼夜率		1.37	1.51	1.45	-

時間帯	方向	合計 (7+イ+ウ+エ+オ+カ+キ+ク)			
		歩行者 (人)	自転車 (台)	合計 (人・台)	時間 係数 (%)
22:15-23:15		20	25	45	3.0
22:30-23:30		18	10	28	1.9
22:45-23:45		13	5	18	1.2
23:00-0:00		10	3	13	0.9
23:15-0:15		6	3	9	0.6
23:30-0:30		7	3	10	0.7
23:45-0:45		5	3	8	0.5
0:00-1:00		5	3	8	0.5
0:15-1:15		5	5	10	0.7
0:30-1:30		5	4	9	0.6
0:45-1:45		4	6	10	0.7
1:00-2:00		3	5	8	0.5
1:15-2:15		1	2	3	0.2
1:30-2:30		2	4	6	0.4
1:45-2:45		2	2	4	0.3
2:00-3:00		3	4	7	0.5
2:15-3:15		3	6	9	0.6
2:30-3:30		1	4	5	0.3
2:45-3:45		1	4	5	0.3
3:00-4:00		0	2	2	0.1
3:15-4:15		3	0	3	0.2
3:30-4:30		3	0	3	0.2
3:45-4:45		4	0	4	0.3
4:00-5:00		6	4	10	0.7
4:15-5:15		4	4	8	0.5
4:30-5:30		8	9	17	1.1
4:45-5:45		11	16	27	1.8
5:00-6:00		18	23	41	2.7
5:15-6:15		21	40	61	4.0
5:30-6:30		21	51	72	4.8
5:45-6:45		25	53	78	5.2
6:00-7:00		23	68	91	6.0
全時間合計		667	846	1513	100.0

歩行者通行量調査表

調査地点 地域社会2 目黒交番前

調査年月日 令和元年 5月14日(火) 天候 雨のち曇り



方向	7				イ				合計				
	種別	歩行者 (人)	自転車 (台)	合計 (人・台)	時間 係数 (%)	歩行者 (人)	自転車 (台)	合計 (人・台)	時間 係数 (%)	歩行者 (人)	自転車 (台)	合計 (人・台)	時間 係数 (%)
7:00-7:15		0	6	6	3.9	0	0	0	0.0	0	6	6	2.2
7:15-7:30		0	2	2	1.3	2	1	3	2.6	2	3	5	1.9
7:30-7:45		2	0	2	1.3	0	0	0	0.0	2	0	2	0.7
7:45-8:00		0	7	7	4.6	1	2	3	2.6	1	9	10	3.7
1時間計		2	15	17	11.1	3	3	6	5.3	5	18	23	8.6
8:00-8:15		3	9	12	7.8	4	3	7	6.1	7	12	19	7.1
8:15-8:30		3	15	18	11.8	2	3	5	4.4	5	18	23	8.6
8:30-8:45		1	5	6	3.9	1	0	1	0.9	2	5	7	2.6
8:45-9:00		3	2	5	3.3	1	0	1	0.9	4	2	6	2.2
1時間計		10	31	41	26.8	8	6	14	12.3	18	37	65	20.6
9:00-9:15		0	0	0	0.0	2	0	2	1.8	2	0	2	0.7
9:15-9:30		3	1	4	2.6	0	1	1	0.9	3	2	5	1.9
9:30-9:45		4	1	5	3.3	0	0	0	0.0	4	1	5	1.9
9:45-10:00		0	0	0	0.0	2	0	2	1.8	2	0	2	0.7
1時間計		7	2	9	5.9	4	1	5	4.4	11	3	14	5.2
10:00-10:15		0	1	1	0.7	0	0	0	0.0	0	1	1	0.4
10:15-10:30		0	0	0	0.0	0	0	0	0.0	0	0	0	0.0
10:30-10:45		2	0	2	1.3	0	0	0	0.0	2	0	2	0.7
10:45-11:00		0	0	0	0.0	0	1	1	0.9	0	1	1	0.4
1時間計		2	1	3	2.0	0	1	1	0.9	2	2	4	1.5
11:00-11:15		1	0	1	0.7	0	0	0	0.0	1	0	1	0.4
11:15-11:30		0	0	0	0.0	0	0	0	0.0	0	0	0	0.0
11:30-11:45		0	1	1	0.7	0	1	1	0.9	0	2	2	0.7
11:45-12:00		0	0	0	0.0	1	1	2	1.8	1	1	2	0.7
1時間計		1	1	2	1.3	1	2	3	2.6	2	3	5	1.9
12:00-12:15		0	0	0	0.0	1	0	1	0.9	1	0	1	0.4
12:15-12:30		0	0	0	0.0	0	0	0	0.0	0	0	0	0.0
12:30-12:45		0	0	0	0.0	0	0	0	0.0	0	0	0	0.0
12:45-13:00		1	1	2	1.3	0	0	0	0.0	1	1	2	0.7
1時間計		1	1	2	1.3	1	0	1	0.9	2	1	3	1.1
13:00-13:15		0	0	0	0.0	2	1	3	2.6	2	1	3	1.1
13:15-13:30		0	0	0	0.0	1	1	2	1.8	1	1	2	0.7
13:30-13:45		2	1	3	2.0	0	1	1	0.9	2	2	4	1.5
13:45-14:00		0	0	0	0.0	0	0	0	0.0	0	0	0	0.0
1時間計		2	1	3	2.0	3	3	6	5.3	5	4	9	3.4
14:00-14:15		0	0	0	0.0	1	0	1	0.9	1	0	1	0.4
14:15-14:30		0	0	0	0.0	0	0	0	0.0	0	0	0	0.0
14:30-14:45		0	0	0	0.0	0	0	0	0.0	0	0	0	0.0
14:45-15:00		0	2	2	1.3	0	0	0	0.0	0	2	2	0.7
1時間計		0	2	2	1.3	1	0	1	0.9	1	2	3	1.1

歩行者通行量調査表

調査地点 地域社会2 目黒交番前

調査年月日 令和元年 5月14日(火) 天候 雨のち曇り



時間帯	方向 7				方向 4				合計			
	歩行者 (人)	自転車 (台)	合計 (人・台)	時間 係数 (%)	歩行者 (人)	自転車 (台)	合計 (人・台)	時間 係数 (%)	歩行者 (人)	自転車 (台)	合計 (人・台)	時間 係数 (%)
15:00-15:15	1	0	1	0.7	0	1	1	0.9	1	1	2	0.7
15:15-15:30	0	1	1	0.7	0	1	1	0.9	0	2	2	0.7
15:30-15:45	0	2	2	1.3	0	1	1	0.9	0	3	3	1.1
15:45-16:00	0	0	0	0.0	1	4	5	4.4	1	4	5	1.9
1時間計	1	3	4	2.6	1	7	8	7.0	2	10	12	4.5
16:00-16:15	2	0	2	1.3	0	0	0	0.0	2	0	2	0.7
16:15-16:30	1	2	3	2.0	1	2	3	2.6	2	4	6	2.2
16:30-16:45	0	0	0	0.0	1	2	3	2.6	1	2	3	1.1
16:45-17:00	0	0	0	0.0	1	1	2	1.8	1	1	2	0.7
1時間計	3	2	5	3.3	3	5	8	7.0	6	7	13	4.9
17:00-17:15	0	0	0	0.0	1	1	2	1.8	1	1	2	0.7
17:15-17:30	0	7	7	4.6	10	3	13	11.4	10	10	20	7.5
17:30-17:45	3	3	6	3.9	2	0	2	1.8	5	3	8	3.0
17:45-18:00	0	1	1	0.7	0	3	3	2.6	0	4	4	1.5
1時間計	3	11	14	9.2	13	7	20	17.5	16	18	34	12.7
18:00-18:15	3	1	4	2.6	0	2	2	1.8	3	3	6	2.2
18:15-18:30	3	4	7	4.6	1	3	4	3.5	4	7	11	4.1
18:30-18:45	2	0	2	1.3	1	6	7	6.1	3	6	9	3.4
18:45-19:00	0	0	0	0.0	1	2	3	2.6	1	2	3	1.1
1時間計	8	5	13	8.5	3	13	16	14.0	11	18	29	10.9
昼12時間計	40	75	115	75.2	41	48	89	78.1	81	123	204	76.4
19:00-19:15	2	2	4	2.6	0	1	1	0.9	2	3	5	1.9
19:15-19:30	2	0	2	1.3	0	3	3	2.6	2	3	5	1.9
19:30-19:45	0	1	1	0.7	0	1	1	0.9	0	2	2	0.7
19:45-20:00	0	0	0	0.0	0	0	0	0.0	0	0	0	0.0
1時間計	4	3	7	4.6	0	5	5	4.4	4	8	12	4.5
20:00-20:15	0	1	1	0.7	0	3	3	2.6	0	4	4	1.5
20:15-20:30	0	0	0	0.0	0	2	2	1.8	0	2	2	0.7
20:30-20:45	0	2	2	1.3	0	1	1	0.9	0	3	3	1.1
20:45-21:00	0	1	1	0.7	2	1	3	2.6	2	2	4	1.5
1時間計	0	4	4	2.6	2	7	9	7.9	2	11	13	4.9
21:00-21:15	0	1	1	0.7	1	0	1	0.9	1	1	2	0.7
21:15-21:30	0	0	0	0.0	0	1	1	0.9	0	1	1	0.4
21:30-21:45	0	0	0	0.0	0	4	4	3.5	0	4	4	1.5
21:45-22:00	0	0	0	0.0	0	0	0	0.0	0	0	0	0.0
1時間計	0	1	1	0.7	1	5	6	5.3	1	6	7	2.6
22:00-22:15	0	2	2	1.3	0	0	0	0.0	0	2	2	0.7
22:15-22:30	0	0	0	0.0	0	0	0	0.0	0	0	0	0.0
22:30-22:45	0	0	0	0.0	1	0	1	0.9	1	0	1	0.4
22:45-23:00	0	1	1	0.7	0	0	0	0.0	0	1	1	0.4
1時間計	0	3	3	2.0	1	0	1	0.9	1	3	4	1.5

歩行者通行量調査表

調査地点 地域社会2 目黒交番前

調査年月日 令和元年 5月14日(火) 天候 雨のち曇り



方向	ア				イ				合計			
	歩行者 (人)	自転車 (台)	合計 (人・台)	時間 係数 (%)	歩行者 (人)	自転車 (台)	合計 (人・台)	時間 係数 (%)	歩行者 (人)	自転車 (台)	合計 (人・台)	時間 係数 (%)
時間帯												
23:00-23:15	0	0	0	0.0	0	0	0	0.0	0	0	0	0.0
23:15-23:30	0	0	0	0.0	0	1	1	0.9	0	1	1	0.4
23:30-23:45	0	0	0	0.0	0	0	0	0.0	0	0	0	0.0
23:45-24:00	0	0	0	0.0	0	0	0	0.0	0	0	0	0.0
1時間計	0	0	0	0.0	0	1	1	0.9	0	1	1	0.4
0:00-0:15	0	0	0	0.0	0	1	1	0.9	0	1	1	0.4
0:15-0:30	0	0	0	0.0	0	0	0	0.0	0	0	0	0.0
0:30-0:45	0	1	1	0.7	0	0	0	0.0	0	1	1	0.4
0:45-1:00	0	0	0	0.0	0	0	0	0.0	0	0	0	0.0
1時間計	0	1	1	0.7	0	1	1	0.9	0	2	2	0.7
1:00-1:15	0	0	0	0.0	0	0	0	0.0	0	0	0	0.0
1:15-1:30	0	0	0	0.0	0	0	0	0.0	0	0	0	0.0
1:30-1:45	0	0	0	0.0	0	0	0	0.0	0	0	0	0.0
1:45-2:00	0	0	0	0.0	0	0	0	0.0	0	0	0	0.0
1時間計	0	0	0	0.0	0	0	0	0.0	0	0	0	0.0
2:00-2:15	0	0	0	0.0	1	0	1	0.9	1	0	1	0.4
2:15-2:30	0	0	0	0.0	0	0	0	0.0	0	0	0	0.0
2:30-2:45	0	0	0	0.0	0	0	0	0.0	0	0	0	0.0
2:45-3:00	0	0	0	0.0	0	0	0	0.0	0	0	0	0.0
1時間計	0	0	0	0.0	1	0	1	0.9	1	0	1	0.4
3:00-3:15	0	0	0	0.0	0	0	0	0.0	0	0	0	0.0
3:15-3:30	0	0	0	0.0	0	0	0	0.0	0	0	0	0.0
3:30-3:45	0	0	0	0.0	0	0	0	0.0	0	0	0	0.0
3:45-4:00	0	0	0	0.0	0	1	1	0.9	0	1	1	0.4
1時間計	0	0	0	0.0	0	1	1	0.9	0	1	1	0.4
4:00-4:15	0	0	0	0.0	0	0	0	0.0	0	0	0	0.0
4:15-4:30	0	0	0	0.0	0	0	0	0.0	0	0	0	0.0
4:30-4:45	0	0	0	0.0	0	0	0	0.0	0	0	0	0.0
4:45-5:00	0	2	2	1.3	0	0	0	0.0	0	2	2	0.7
1時間計	0	2	2	1.3	0	0	0	0.0	0	2	2	0.7
5:00-5:15	0	1	1	0.7	0	0	0	0.0	0	1	1	0.4
5:15-5:30	0	3	3	2.0	0	0	0	0.0	0	3	3	1.1
5:30-5:45	0	3	3	2.0	0	0	0	0.0	0	3	3	1.1
5:45-6:00	0	2	2	1.3	0	0	0	0.0	0	2	2	0.7
1時間計	0	9	9	5.9	0	0	0	0.0	0	9	9	3.4
6:00-6:15	0	1	1	0.7	0	0	0	0.0	0	1	1	0.4
6:15-6:30	1	1	2	1.3	0	0	0	0.0	1	1	2	0.7
6:30-6:45	0	4	4	2.6	0	0	0	0.0	0	4	4	1.5
6:45-7:00	0	4	4	2.6	0	0	0	0.0	0	4	4	1.5
1時間計	1	10	11	7.2	0	0	0	0.0	1	10	11	4.1
夜12時間計	5	33	38	24.8	5	20	25	21.9	10	53	63	23.6
全時間合計	45	108	153	100.0	46	68	114	100.0	91	176	267	100.0
昼夜平均	1.13	1.44	1.33	-	1.12	1.42	1.28	-	1.12	1.43	1.31	-

歩行者通行量調査表

調査地点 地域社会2 目黒交番前

調査年月日 令和元年 5月14日(火) 天候 雨のち曇り



方向	ウ				エ				合計				
	種別	歩行者 (人)	自転車 (台)	合計 (人・台)	時間 係数 (%)	歩行者 (人)	自転車 (台)	合計 (人・台)	時間 係数 (%)	歩行者 (人)	自転車 (台)	合計 (人・台)	時間 係数 (%)
7:00-7:15	時間帯	0	2	2	4.3	0	0	0	0.0	0	2	2	1.7
7:15-7:30		2	0	2	4.3	0	0	0	0.0	2	0	2	1.7
7:30-7:45		0	0	0	0.0	1	0	1	1.3	1	0	1	0.8
7:45-8:00		0	2	2	4.3	0	0	0	0.0	0	2	2	1.7
1時間計		2	4	6	13.0	1	0	1	1.3	3	4	7	5.8
8:00-8:15		2	5	7	15.2	1	5	6	9.0	3	10	13	10.7
8:15-8:30		0	3	3	6.5	0	1	1	1.3	0	4	4	3.3
8:30-8:45		1	1	2	4.3	0	0	0	0.0	1	1	2	1.7
8:45-9:00		1	1	2	4.3	0	0	0	0.0	1	1	2	1.7
1時間計		4	10	14	30.4	1	6	7	9.3	5	16	21	17.4
9:00-9:15		0	0	0	0.0	0	0	0	0.0	0	0	0	0.0
9:15-9:30		0	0	0	0.0	0	1	1	1.3	0	1	1	0.8
9:30-9:45		1	0	1	2.2	0	0	0	0.0	1	0	1	0.8
9:45-10:00		1	0	1	2.2	0	0	0	0.0	1	0	1	0.8
1時間計		2	0	2	4.3	0	1	1	1.3	2	1	3	2.5
10:00-10:15		0	1	1	2.2	0	0	0	0.0	0	1	1	0.8
10:15-10:30		0	0	0	0.0	0	0	0	0.0	0	0	0	0.0
10:30-10:45		1	0	1	2.2	0	0	0	0.0	1	0	1	0.8
10:45-11:00		0	0	0	0.0	0	0	0	0.0	0	0	0	0.0
1時間計		1	1	2	4.3	0	0	0	0.0	1	1	2	1.7
11:00-11:15		0	0	0	0.0	0	0	0	0.0	0	0	0	0.0
11:15-11:30		0	0	0	0.0	0	0	0	0.0	0	0	0	0.0
11:30-11:45		0	0	0	0.0	0	1	1	1.3	0	1	1	0.8
11:45-12:00		1	0	1	2.2	0	0	0	0.0	1	0	1	0.8
1時間計		1	0	1	2.2	0	1	1	1.3	1	1	2	1.7
12:00-12:15		0	0	0	0.0	0	2	2	2.7	0	2	2	1.7
12:15-12:30		0	0	0	0.0	0	1	1	1.3	0	1	1	0.8
12:30-12:45		0	0	0	0.0	0	0	0	0.0	0	0	0	0.0
12:45-13:00		0	0	0	0.0	1	1	2	2.7	1	1	2	1.7
1時間計		0	0	0	0.0	1	4	5	6.7	1	4	5	4.1
13:00-13:15		1	1	2	4.3	0	0	0	0.0	1	1	2	1.7
13:15-13:30		0	0	0	0.0	0	1	1	1.3	0	1	1	0.8
13:30-13:45		0	0	0	0.0	0	0	0	0.0	0	0	0	0.0
13:45-14:00		0	0	0	0.0	0	0	0	0.0	0	0	0	0.0
1時間計		1	1	2	4.3	0	1	1	1.3	1	2	3	2.5
14:00-14:15		0	0	0	0.0	1	0	1	1.3	1	0	1	0.8
14:15-14:30		0	0	0	0.0	0	1	1	1.3	0	1	1	0.8
14:30-14:45		0	0	0	0.0	0	0	0	0.0	0	0	0	0.0
14:45-15:00		0	0	0	0.0	0	0	0	0.0	0	0	0	0.0
1時間計		0	0	0	0.0	1	1	2	2.7	1	1	2	1.7

歩行者通行量調査表

調査地点 地域社会2 目黒交番前

調査年月日 令和元年 5月14日(火) 天候 雨のち曇り



方向	ウ				エ				合計			
	歩行者 (人)	自転車 (台)	合計 (人・台)	時間 係数 (%)	歩行者 (人)	自転車 (台)	合計 (人・台)	時間 係数 (%)	歩行者 (人)	自転車 (台)	合計 (人・台)	時間 係数 (%)
15:00-15:15	1	0	1	2.2	1	1	2	2.7	2	1	3	2.5
15:15-15:30	0	0	0	0.0	0	2	2	2.7	0	2	2	1.7
15:30-15:45	0	0	0	0.0	0	2	2	2.7	0	2	2	1.7
15:45-16:00	0	1	1	2.2	0	3	3	4.0	0	4	4	3.3
1時間計	1	1	2	4.3	1	8	9	12.0	2	9	11	9.1
16:00-16:15	0	0	0	0.0	1	3	4	5.3	1	3	4	3.3
16:15-16:30	1	0	1	2.2	2	2	4	5.3	3	2	5	4.1
16:30-16:45	0	0	0	0.0	1	0	1	1.3	1	0	1	0.8
16:45-17:00	0	0	0	0.0	0	0	0	0.0	0	0	0	0.0
1時間計	1	0	1	2.2	4	5	9	12.0	5	5	10	8.3
17:00-17:15	1	0	1	2.2	0	2	2	2.7	1	2	3	2.5
17:15-17:30	0	1	1	2.2	3	2	5	6.7	3	3	6	5.0
17:30-17:45	0	0	0	0.0	0	0	0	0.0	0	0	0	0.0
17:45-18:00	0	2	2	4.3	0	1	1	1.3	0	3	3	2.5
1時間計	1	3	4	8.7	3	5	8	10.7	4	8	12	9.9
18:00-18:15	0	0	0	0.0	0	2	2	2.7	0	2	2	1.7
18:15-18:30	1	0	1	2.2	1	3	4	5.3	2	3	5	4.1
18:30-18:45	0	1	1	2.2	1	2	3	4.0	1	3	4	3.3
18:45-19:00	0	0	0	0.0	0	1	1	1.3	0	1	1	0.8
1時間計	1	1	2	4.3	2	8	10	13.3	3	9	12	9.9
昼12時間計	15	21	36	78.3	14	40	54	72.0	29	61	90	74.4
19:00-19:15	0	0	0	0.0	0	0	0	0.0	0	0	0	0.0
19:15-19:30	0	0	0	0.0	1	2	3	4.0	1	2	3	2.5
19:30-19:45	0	0	0	0.0	0	1	1	1.3	0	1	1	0.8
19:45-20:00	0	0	0	0.0	0	1	1	1.3	0	1	1	0.8
1時間計	0	0	0	0.0	1	4	5	6.7	1	4	5	4.1
20:00-20:15	0	0	0	0.0	1	2	3	4.0	1	2	3	2.5
20:15-20:30	0	0	0	0.0	0	1	1	1.3	0	1	1	0.8
20:30-20:45	0	0	0	0.0	0	2	2	2.7	0	2	2	1.7
20:45-21:00	0	0	0	0.0	0	1	1	1.3	0	1	1	0.8
1時間計	0	0	0	0.0	1	6	7	9.3	1	6	7	5.8
21:00-21:15	0	0	0	0.0	0	1	1	1.3	0	1	1	0.8
21:15-21:30	0	0	0	0.0	0	2	2	2.7	0	2	2	1.7
21:30-21:45	0	0	0	0.0	0	1	1	1.3	0	1	1	0.8
21:45-22:00	0	0	0	0.0	0	0	0	0.0	0	0	0	0.0
1時間計	0	0	0	0.0	0	4	4	5.3	0	4	4	3.3
22:00-22:15	0	0	0	0.0	0	0	0	0.0	0	0	0	0.0
22:15-22:30	0	0	0	0.0	0	1	1	1.3	0	1	1	0.8
22:30-22:45	0	0	0	0.0	0	0	0	0.0	0	0	0	0.0
22:45-23:00	0	0	0	0.0	0	0	0	0.0	0	0	0	0.0
1時間計	0	0	0	0.0	0	1	1	1.3	0	1	1	0.8

歩行者通行量調査表

調査地点：地域社会2 目黒交番前

調査年月日：令和元年 5月14日(火) 天候：雨のち曇り



方向	ウ				エ				合計				
	種別	歩行者 (人)	自転車 (台)	合計 (人・台)	時間係数 (%)	歩行者 (人)	自転車 (台)	合計 (人・台)	時間係数 (%)	歩行者 (人)	自転車 (台)	合計 (人・台)	時間係数 (%)
時間帯													
23:00-23:15		0	0	0	0.0	0	0	0	0.0	0	0	0	0.0
23:15-23:30		0	0	0	0.0	0	0	0	0.0	0	0	0	0.0
23:30-23:45		0	1	1	2.2	0	0	0	0.0	0	1	1	0.8
23:45-24:00		0	0	0	0.0	0	0	0	0.0	0	0	0	0.0
1時間計		0	1	1	2.2	0	0	0	0.0	0	1	1	0.8
0:00-0:15		0	0	0	0.0	0	0	0	0.0	0	0	0	0.0
0:15-0:30		0	0	0	0.0	0	0	0	0.0	0	0	0	0.0
0:30-0:45		0	0	0	0.0	0	0	0	0.0	0	0	0	0.0
0:45-1:00		0	0	0	0.0	0	0	0	0.0	0	0	0	0.0
1時間計		0	0	0	0.0	0	0	0	0.0	0	0	0	0.0
1:00-1:15		0	0	0	0.0	0	0	0	0.0	0	0	0	0.0
1:15-1:30		0	0	0	0.0	0	0	0	0.0	0	0	0	0.0
1:30-1:45		0	0	0	0.0	0	0	0	0.0	0	0	0	0.0
1:45-2:00		0	0	0	0.0	0	0	0	0.0	0	0	0	0.0
1時間計		0	0	0	0.0	0	0	0	0.0	0	0	0	0.0
2:00-2:15		0	0	0	0.0	0	0	0	0.0	0	0	0	0.0
2:15-2:30		0	0	0	0.0	0	0	0	0.0	0	0	0	0.0
2:30-2:45		0	0	0	0.0	0	0	0	0.0	0	0	0	0.0
2:45-3:00		0	0	0	0.0	0	0	0	0.0	0	0	0	0.0
1時間計		0	0	0	0.0	0	0	0	0.0	0	0	0	0.0
3:00-3:15		0	0	0	0.0	0	0	0	0.0	0	0	0	0.0
3:15-3:30		0	0	0	0.0	0	0	0	0.0	0	0	0	0.0
3:30-3:45		1	0	1	2.2	0	0	0	0.0	1	0	1	0.8
3:45-4:00		1	0	1	2.2	0	0	0	0.0	1	0	1	0.8
1時間計		2	0	2	4.3	0	0	0	0.0	2	0	2	1.7
4:00-4:15		0	0	0	0.0	0	0	0	0.0	0	0	0	0.0
4:15-4:30		0	0	0	0.0	0	0	0	0.0	0	0	0	0.0
4:30-4:45		0	0	0	0.0	0	0	0	0.0	0	0	0	0.0
4:45-5:00		0	0	0	0.0	0	0	0	0.0	0	0	0	0.0
1時間計		0	0	0	0.0	0	0	0	0.0	0	0	0	0.0
5:00-5:15		0	0	0	0.0	0	1	1	1.3	0	1	1	0.8
5:15-5:30		0	0	0	0.0	0	0	0	0.0	0	0	0	0.0
5:30-5:45		1	1	2	4.3	0	0	0	0.0	1	1	2	1.7
5:45-6:00		0	0	0	0.0	2	0	2	2.7	2	0	2	1.7
1時間計		1	1	2	4.3	2	1	3	4.0	3	2	5	4.1
6:00-6:15		0	0	0	0.0	0	0	0	0.0	0	0	0	0.0
6:15-6:30		0	1	1	2.2	0	0	0	0.0	0	1	1	0.8
6:30-6:45		0	3	3	6.5	0	0	0	0.0	0	3	3	2.5
6:45-7:00		0	1	1	2.2	0	1	1	1.3	0	2	2	1.7
1時間計		0	5	5	10.9	0	1	1	1.3	0	6	6	5.0
夜12時間計		3	7	10	21.7	4	17	21	28.0	7	24	31	25.6
全時間合計		18	28	46	100.0	18	57	75	100.0	36	85	121	100.0
昼夜平均		1.20	1.33	1.28	-	1.29	1.43	1.39	-	1.24	1.39	1.34	-

歩行者通行量調査表

調査地点 地域社会2 目黒交番前

調査年月日 令和元年 5月14日(火) 天候 雨のち曇り



方向 種別 時間帯	ま				か				合計			
	歩行者 (人)	自転車 (台)	合計 (人・台)	時間 係数 (%)	歩行者 (人)	自転車 (台)	合計 (人・台)	時間 係数 (%)	歩行者 (人)	自転車 (台)	合計 (人・台)	時間 係数 (%)
7:00-7:15	0	1	1	1.6	0	1	1	3.4	0	2	2	2.2
7:15-7:30	0	1	1	1.6	0	0	0	0.0	0	1	1	1.1
7:30-7:45	0	1	1	1.6	1	1	2	6.9	1	2	3	3.3
7:45-8:00	0	1	1	1.6	2	4	6	20.7	2	5	7	7.8
1時間計	0	4	4	6.6	3	6	9	31.0	3	10	13	14.4
8:00-8:15	1	3	4	6.6	1	1	2	6.9	2	4	6	6.7
8:15-8:30	1	0	1	1.6	0	0	0	0.0	1	0	1	1.1
8:30-8:45	0	1	1	1.6	0	0	0	0.0	0	1	1	1.1
8:45-9:00	0	0	0	0.0	0	0	0	0.0	0	0	0	0.0
1時間計	2	4	6	9.8	1	1	2	6.9	3	5	8	8.9
9:00-9:15	0	0	0	0.0	0	1	1	3.4	0	1	1	1.1
9:15-9:30	0	0	0	0.0	0	0	0	0.0	0	0	0	0.0
9:30-9:45	0	0	0	0.0	2	0	2	6.9	2	0	2	2.2
9:45-10:00	0	1	1	1.6	0	0	0	0.0	0	1	1	1.1
1時間計	0	1	1	1.6	2	1	3	10.3	2	2	4	4.4
10:00-10:15	3	1	4	6.6	0	0	0	0.0	3	1	4	4.4
10:15-10:30	3	0	3	4.9	0	1	1	3.4	3	1	4	4.4
10:30-10:45	0	0	0	0.0	0	0	0	0.0	0	0	0	0.0
10:45-11:00	0	0	0	0.0	0	0	0	0.0	0	0	0	0.0
1時間計	6	1	7	11.5	0	1	1	3.4	6	2	8	8.9
11:00-11:15	0	0	0	0.0	0	1	1	3.4	0	1	1	1.1
11:15-11:30	0	0	0	0.0	0	0	0	0.0	0	0	0	0.0
11:30-11:45	0	0	0	0.0	0	0	0	0.0	0	0	0	0.0
11:45-12:00	0	0	0	0.0	0	0	0	0.0	0	0	0	0.0
1時間計	0	0	0	0.0	0	1	1	3.4	0	1	1	1.1
12:00-12:15	0	0	0	0.0	0	0	0	0.0	0	0	0	0.0
12:15-12:30	0	0	0	0.0	0	0	0	0.0	0	0	0	0.0
12:30-12:45	0	0	0	0.0	0	0	0	0.0	0	0	0	0.0
12:45-13:00	0	0	0	0.0	0	0	0	0.0	0	0	0	0.0
1時間計	0	0	0	0.0	0	0	0	0.0	0	0	0	0.0
13:00-13:15	0	0	0	0.0	0	0	0	0.0	0	0	0	0.0
13:15-13:30	1	0	1	1.6	1	0	1	3.4	2	0	2	2.2
13:30-13:45	0	0	0	0.0	0	0	0	0.0	0	0	0	0.0
13:45-14:00	0	0	0	0.0	0	1	1	3.4	0	1	1	1.1
1時間計	1	0	1	1.6	1	1	2	6.9	2	1	3	3.3
14:00-14:15	1	1	2	3.3	0	0	0	0.0	1	1	2	2.2
14:15-14:30	0	1	1	1.6	1	0	1	3.4	1	1	2	2.2
14:30-14:45	0	0	0	0.0	0	0	0	0.0	0	0	0	0.0
14:45-15:00	0	0	0	0.0	0	0	0	0.0	0	0	0	0.0
1時間計	1	2	3	4.9	1	0	1	3.4	2	2	4	4.4

歩行者通行量調査表

調査地点 地域社会2 目黒交番前

調査年月日 令和元年 5月14日(火) 天候 雨のち曇り



方向	イ				カ				合計			
	歩行者 (人)	自転車 (台)	合計 (人・台)	時間 係数 (%)	歩行者 (人)	自転車 (台)	合計 (人・台)	時間 係数 (%)	歩行者 (人)	自転車 (台)	合計 (人・台)	時間 係数 (%)
時間帯												
15:00-15:15	0	4	4	6.6	0	0	0	0.0	0	4	4	4.4
15:15-15:30	0	1	1	1.6	0	0	0	0.0	0	1	1	1.1
15:30-15:45	0	1	1	1.6	0	0	0	0.0	0	1	1	1.1
15:45-16:00	0	0	0	0.0	0	0	0	0.0	0	0	0	0.0
1時間計	0	6	6	9.8	0	0	0	0.0	0	6	6	6.7
16:00-16:15	0	0	0	0.0	0	0	0	0.0	0	0	0	0.0
16:15-16:30	0	0	0	0.0	0	0	0	0.0	0	0	0	0.0
16:30-16:45	0	3	3	4.9	0	1	1	3.4	0	4	4	4.4
16:45-17:00	0	2	2	3.3	0	0	0	0.0	0	2	2	2.2
1時間計	0	5	5	8.2	0	1	1	3.4	0	6	6	6.7
17:00-17:15	0	1	1	1.6	0	0	0	0.0	0	1	1	1.1
17:15-17:30	1	0	1	1.6	0	0	0	0.0	1	0	1	1.1
17:30-17:45	0	1	1	1.6	0	0	0	0.0	0	1	1	1.1
17:45-18:00	0	0	0	0.0	0	0	0	0.0	0	0	0	0.0
1時間計	1	2	3	4.9	0	0	0	0.0	1	2	3	3.3
18:00-18:15	1	0	1	1.6	0	0	0	0.0	1	0	1	1.1
18:15-18:30	0	4	4	6.6	0	1	1	3.4	0	5	5	5.6
18:30-18:45	0	0	0	0.0	0	1	1	3.4	0	1	1	1.1
18:45-19:00	0	2	2	3.3	0	0	0	0.0	0	2	2	2.2
1時間計	1	6	7	11.5	0	2	2	6.9	1	8	9	10.0
昼12時間計	12	31	43	70.5	8	14	22	75.9	20	45	65	72.2
19:00-19:15	0	1	1	1.6	0	0	0	0.0	0	1	1	1.1
19:15-19:30	0	1	1	1.6	0	0	0	0.0	0	1	1	1.1
19:30-19:45	1	1	2	3.3	0	0	0	0.0	1	1	2	2.2
19:45-20:00	1	1	2	3.3	0	0	0	0.0	1	1	2	2.2
1時間計	2	4	6	9.8	0	0	0	0.0	2	4	6	6.7
20:00-20:15	1	1	2	3.3	0	0	0	0.0	1	1	2	2.2
20:15-20:30	0	0	0	0.0	0	0	0	0.0	0	0	0	0.0
20:30-20:45	0	0	0	0.0	0	0	0	0.0	0	0	0	0.0
20:45-21:00	0	0	0	0.0	0	0	0	0.0	0	0	0	0.0
1時間計	1	1	2	3.3	0	0	0	0.0	1	1	2	2.2
21:00-21:15	0	0	0	0.0	0	0	0	0.0	0	0	0	0.0
21:15-21:30	0	1	1	1.6	0	0	0	0.0	0	1	1	1.1
21:30-21:45	0	0	0	0.0	0	0	0	0.0	0	0	0	0.0
21:45-22:00	1	0	1	1.6	0	0	0	0.0	1	0	1	1.1
1時間計	1	1	2	3.3	0	0	0	0.0	1	1	2	2.2
22:00-22:15	0	0	0	0.0	0	0	0	0.0	0	0	0	0.0
22:15-22:30	0	1	1	1.6	0	0	0	0.0	0	1	1	1.1
22:30-22:45	0	0	0	0.0	0	0	0	0.0	0	0	0	0.0
22:45-23:00	0	0	0	0.0	0	0	0	0.0	0	0	0	0.0
1時間計	0	1	1	1.6	0	0	0	0.0	0	1	1	1.1

歩行者通行量調査表

調査地点 地域社会2 目黒交番前

調査年月日：令和元年 5月14日(火) 天候：雨のち曇り



時間帯	方向				合計			
	歩行者		自転車		歩行者		自転車	
種別	歩行者(人)	自転車(台)	合計(人・台)	時間係数(%)	歩行者(人)	自転車(台)	合計(人・台)	時間係数(%)
23:00-23:15	0	0	0	0.0	0	0	0	0.0
23:15-23:30	0	1	1	1.6	0	0	0	0.0
23:30-23:45	0	0	0	0.0	0	0	0	0.0
23:45-24:00	0	0	0	0.0	0	0	0	0.0
1時間計	0	1	1	1.6	0	0	0	0.0
0:00-0:15	0	0	0	0.0	0	0	0	0.0
0:15-0:30	0	0	0	0.0	0	0	0	0.0
0:30-0:45	0	0	0	0.0	0	0	0	0.0
0:45-1:00	0	0	0	0.0	0	0	0	0.0
1時間計	0	0	0	0.0	0	0	0	0.0
1:00-1:15	0	0	0	0.0	0	0	0	0.0
1:15-1:30	0	0	0	0.0	0	0	0	0.0
1:30-1:45	0	0	0	0.0	0	0	0	0.0
1:45-2:00	0	0	0	0.0	0	0	0	0.0
1時間計	0	0	0	0.0	0	0	0	0.0
2:00-2:15	0	0	0	0.0	0	0	0	0.0
2:15-2:30	0	0	0	0.0	0	0	0	0.0
2:30-2:45	0	1	1	1.6	0	0	0	0.0
2:45-3:00	0	0	0	0.0	0	0	0	0.0
1時間計	0	1	1	1.6	0	0	0	0.0
3:00-3:15	0	0	0	0.0	0	0	0	0.0
3:15-3:30	0	0	0	0.0	0	0	0	0.0
3:30-3:45	0	0	0	0.0	0	0	0	0.0
3:45-4:00	0	0	0	0.0	0	0	0	0.0
1時間計	0	0	0	0.0	0	0	0	0.0
4:00-4:15	0	0	0	0.0	0	0	0	0.0
4:15-4:30	0	0	0	0.0	0	0	0	0.0
4:30-4:45	0	0	0	0.0	0	0	0	0.0
4:45-5:00	0	0	0	0.0	0	1	1	3.4
1時間計	0	0	0	0.0	0	1	1	3.4
5:00-5:15	0	0	0	0.0	0	0	0	0.0
5:15-5:30	0	0	0	0.0	0	0	0	0.0
5:30-5:45	1	1	2	3.3	0	0	0	0.0
5:45-6:00	1	0	1	1.6	2	0	2	6.9
1時間計	2	1	3	4.9	2	0	2	6.9
6:00-6:15	0	1	1	1.6	0	2	2	6.9
6:15-6:30	0	0	0	0.0	0	1	1	3.4
6:30-6:45	0	1	1	1.6	0	1	1	3.4
6:45-7:00	0	0	0	0.0	0	0	0	0.0
1時間計	0	2	2	3.3	0	4	4	13.8
夜12時間計	6	12	18	29.5	2	5	7	24.1
全時間合計	18	43	61	100.0	10	19	29	100.0
昼夜平均	1.50	1.39	1.42	-	1.25	1.36	1.32	-

歩行者通行量調査表

調査地点 地域社会2 目黒交番前

調査年月日 令和元年 5月14日(火) 天候 雨のち曇り



方向	キ				ウ				合計				
	種別	歩行者 (人)	自転車 (台)	合計 (人・台)	時間 係数 (%)	歩行者 (人)	自転車 (台)	合計 (人・台)	時間 係数 (%)	歩行者 (人)	自転車 (台)	合計 (人・台)	時間 係数 (%)
時間帯													
7:00-7:15		0	0	0	0.0	0	0	0	0.0	0	0	0	0.0
7:15-7:30		0	0	0	0.0	0	1	1	2.0	0	1	1	1.0
7:30-7:45		0	0	0	0.0	0	0	0	0.0	0	0	0	0.0
7:45-8:00		0	1	1	1.9	0	1	1	2.0	0	2	2	1.9
1時間計		0	1	1	1.9	0	2	2	4.1	0	3	3	2.9
8:00-8:15		1	2	3	5.6	0	5	5	10.2	1	7	8	7.8
8:15-8:30		1	0	1	1.9	0	2	2	4.1	1	2	3	2.9
8:30-8:45		1	1	2	3.7	0	4	4	8.2	1	5	6	5.8
8:45-9:00		7	0	7	13.0	0	1	1	2.0	7	1	8	7.8
1時間計		10	3	13	24.1	0	12	12	24.5	10	15	25	24.3
9:00-9:15		0	0	0	0.0	0	1	1	2.0	0	1	1	1.0
9:15-9:30		0	0	0	0.0	0	1	1	2.0	0	1	1	1.0
9:30-9:45		0	0	0	0.0	0	1	1	2.0	0	1	1	1.0
9:45-10:00		0	0	0	0.0	0	0	0	0.0	0	0	0	0.0
1時間計		0	0	0	0.0	0	3	3	6.1	0	3	3	2.9
10:00-10:15		0	0	0	0.0	0	1	1	2.0	0	1	1	1.0
10:15-10:30		0	0	0	0.0	0	1	1	2.0	0	1	1	1.0
10:30-10:45		0	0	0	0.0	0	0	0	0.0	0	0	0	0.0
10:45-11:00		0	0	0	0.0	0	0	0	0.0	0	0	0	0.0
1時間計		0	0	0	0.0	0	2	2	4.1	0	2	2	1.9
11:00-11:15		1	0	1	1.9	0	0	0	0.0	1	0	1	1.0
11:15-11:30		0	1	1	1.9	0	0	0	0.0	0	1	1	1.0
11:30-11:45		0	0	0	0.0	0	0	0	0.0	0	0	0	0.0
11:45-12:00		0	0	0	0.0	0	0	0	0.0	0	0	0	0.0
1時間計		1	1	2	3.7	0	0	0	0.0	1	1	2	1.9
12:00-12:15		0	0	0	0.0	0	0	0	0.0	0	0	0	0.0
12:15-12:30		0	0	0	0.0	0	0	0	0.0	0	0	0	0.0
12:30-12:45		1	0	1	1.9	0	1	1	2.0	1	1	2	1.9
12:45-13:00		1	0	1	1.9	1	0	1	2.0	2	0	2	1.9
1時間計		2	0	2	3.7	1	1	2	4.1	3	1	4	3.9
13:00-13:15		0	0	0	0.0	0	0	0	0.0	0	0	0	0.0
13:15-13:30		0	0	0	0.0	0	0	0	0.0	0	0	0	0.0
13:30-13:45		0	0	0	0.0	0	1	1	2.0	0	1	1	1.0
13:45-14:00		0	0	0	0.0	0	1	1	2.0	0	1	1	1.0
1時間計		0	0	0	0.0	0	2	2	4.1	0	2	2	1.9
14:00-14:15		0	0	0	0.0	0	0	0	0.0	0	0	0	0.0
14:15-14:30		0	1	1	1.9	1	0	1	2.0	1	1	2	1.9
14:30-14:45		0	0	0	0.0	0	0	0	0.0	0	0	0	0.0
14:45-15:00		0	1	1	1.9	0	0	0	0.0	0	1	1	1.0
1時間計		0	2	2	3.7	1	0	1	2.0	1	2	3	2.9

歩行者通行量調査表

調査地点 地域社会2 目黒交番前

調査年月日 令和元年 5月14日(火) 天候 雨のち曇り



方向	キ				ウ				合計			
	歩行者 (人)	自転車 (台)	合計 (人・台)	時間 係数 (%)	歩行者 (人)	自転車 (台)	合計 (人・台)	時間 係数 (%)	歩行者 (人)	自転車 (台)	合計 (人・台)	時間 係数 (%)
時間帯												
15.00-15.15	0	0	0	0.0	0	0	0	0.0	0	0	0	0.0
15.15-15.30	0	0	0	0.0	0	0	0	0.0	0	0	0	0.0
15.30-15.45	0	0	0	0.0	0	0	0	0.0	0	0	0	0.0
15.45-16.00	0	2	2	3.7	0	0	0	0.0	0	2	2	1.9
1時間計	0	2	2	3.7	0	0	0	0.0	0	2	2	1.9
16.00-16.15	0	0	0	0.0	0	0	0	0.0	0	0	0	0.0
16.15-16.30	0	0	0	0.0	0	3	3	6.1	0	3	3	2.9
16.30-16.45	0	0	0	0.0	0	2	2	4.1	0	2	2	1.9
16.45-17.00	0	1	1	1.9	1	1	2	4.1	1	2	3	2.9
1時間計	0	1	1	1.9	1	6	7	14.3	1	7	8	7.8
17.00-17.15	1	2	3	5.6	1	0	1	2.0	2	2	4	3.9
17.15-17.30	0	6	6	11.1	0	0	0	0.0	0	6	6	5.8
17.30-17.45	1	1	2	3.7	0	0	0	0.0	1	1	2	1.9
17.45-18.00	1	3	4	7.4	1	1	2	4.1	2	4	6	5.8
1時間計	3	12	15	27.8	2	1	3	6.1	5	13	18	17.5
18.00-18.15	0	0	0	0.0	2	0	2	4.1	2	0	2	1.9
18.15-18.30	0	7	7	13.0	2	0	2	4.1	2	7	9	8.7
18.30-18.45	0	2	2	3.7	0	1	1	2.0	0	3	3	2.9
18.45-19.00	1	0	1	1.9	1	0	1	2.0	2	0	2	1.9
1時間計	1	9	10	18.5	5	1	6	12.2	6	10	16	15.5
昼12時間計	17	31	48	88.9	10	30	40	81.6	27	61	88	85.4
19.00-19.15	0	1	1	1.9	1	0	1	2.0	1	1	2	1.9
19.15-19.30	0	0	0	0.0	1	0	1	2.0	1	0	1	1.0
19.30-19.45	0	0	0	0.0	0	1	1	2.0	0	1	1	1.0
19.45-20.00	1	0	1	1.9	0	1	1	2.0	1	1	2	1.9
1時間計	1	1	2	3.7	2	2	4	8.2	3	3	6	5.8
20.00-20.15	0	2	2	3.7	0	3	3	6.1	0	5	5	4.9
20.15-20.30	0	0	0	0.0	0	0	0	0.0	0	0	0	0.0
20.30-20.45	0	0	0	0.0	0	0	0	0.0	0	0	0	0.0
20.45-21.00	0	0	0	0.0	0	0	0	0.0	0	0	0	0.0
1時間計	0	2	2	3.7	0	3	3	6.1	0	5	5	4.9
21.00-21.15	0	0	0	0.0	0	0	0	0.0	0	0	0	0.0
21.15-21.30	0	0	0	0.0	0	0	0	0.0	0	0	0	0.0
21.30-21.45	0	0	0	0.0	0	0	0	0.0	0	0	0	0.0
21.45-22.00	0	0	0	0.0	0	0	0	0.0	0	0	0	0.0
1時間計	0	0	0	0.0	0	0	0	0.0	0	0	0	0.0
22.00-22.15	0	0	0	0.0	0	0	0	0.0	0	0	0	0.0
22.15-22.30	0	0	0	0.0	0	0	0	0.0	0	0	0	0.0
22.30-22.45	0	0	0	0.0	0	0	0	0.0	0	0	0	0.0
22.45-23.00	0	0	0	0.0	0	0	0	0.0	0	0	0	0.0
1時間計	0	0	0	0.0	0	0	0	0.0	0	0	0	0.0

歩行者通行量調査表

調査地点 地域社会2 目黒交番前

調査年月日 令和元年 5月14日(火) 天候 雨のち曇り



方向	キ				ウ				合計			
	歩行者 (人)	自転車 (台)	合計 (人・台)	時間 係数 (%)	歩行者 (人)	自転車 (台)	合計 (人・台)	時間 係数 (%)	歩行者 (人)	自転車 (台)	合計 (人・台)	時間 係数 (%)
時間帯												
23:00-23:15	0	0	0	0.0	0	0	0	0.0	0	0	0	0.0
23:15-23:30	0	0	0	0.0	0	0	0	0.0	0	0	0	0.0
23:30-23:45	0	0	0	0.0	0	0	0	0.0	0	0	0	0.0
23:45-24:00	0	0	0	0.0	0	0	0	0.0	0	0	0	0.0
1時間計	0	0	0	0.0	0	0	0	0.0	0	0	0	0.0
0:00-0:15	1	0	1	1.9	0	0	0	0.0	1	0	1	1.0
0:15-0:30	0	0	0	0.0	0	0	0	0.0	0	0	0	0.0
0:30-0:45	0	0	0	0.0	0	0	0	0.0	0	0	0	0.0
0:45-1:00	0	0	0	0.0	0	0	0	0.0	0	0	0	0.0
1時間計	1	0	1	1.9	0	0	0	0.0	1	0	1	1.0
1:00-1:15	0	0	0	0.0	0	0	0	0.0	0	0	0	0.0
1:15-1:30	0	0	0	0.0	0	0	0	0.0	0	0	0	0.0
1:30-1:45	0	0	0	0.0	0	0	0	0.0	0	0	0	0.0
1:45-2:00	0	0	0	0.0	0	0	0	0.0	0	0	0	0.0
1時間計	0	0	0	0.0	0	0	0	0.0	0	0	0	0.0
2:00-2:15	0	0	0	0.0	0	0	0	0.0	0	0	0	0.0
2:15-2:30	0	0	0	0.0	0	0	0	0.0	0	0	0	0.0
2:30-2:45	0	0	0	0.0	0	0	0	0.0	0	0	0	0.0
2:45-3:00	0	0	0	0.0	0	0	0	0.0	0	0	0	0.0
1時間計	0	0	0	0.0	0	0	0	0.0	0	0	0	0.0
3:00-3:15	0	0	0	0.0	0	0	0	0.0	0	0	0	0.0
3:15-3:30	0	0	0	0.0	0	0	0	0.0	0	0	0	0.0
3:30-3:45	0	0	0	0.0	0	0	0	0.0	0	0	0	0.0
3:45-4:00	0	0	0	0.0	0	0	0	0.0	0	0	0	0.0
1時間計	0	0	0	0.0	0	0	0	0.0	0	0	0	0.0
4:00-4:15	0	0	0	0.0	0	0	0	0.0	0	0	0	0.0
4:15-4:30	0	0	0	0.0	0	0	0	0.0	0	0	0	0.0
4:30-4:45	0	0	0	0.0	0	0	0	0.0	0	0	0	0.0
4:45-5:00	0	0	0	0.0	0	0	0	0.0	0	0	0	0.0
1時間計	0	0	0	0.0	0	0	0	0.0	0	0	0	0.0
5:00-5:15	0	0	0	0.0	0	0	0	0.0	0	0	0	0.0
5:15-5:30	0	0	0	0.0	0	0	0	0.0	0	0	0	0.0
5:30-5:45	0	0	0	0.0	0	0	0	0.0	0	0	0	0.0
5:45-6:00	0	0	0	0.0	0	0	0	0.0	0	0	0	0.0
1時間計	0	0	0	0.0	0	0	0	0.0	0	0	0	0.0
6:00-6:15	1	0	1	1.9	0	0	0	0.0	1	0	1	1.0
6:15-6:30	0	0	0	0.0	0	0	0	0.0	0	0	0	0.0
6:30-6:45	0	0	0	0.0	0	0	0	0.0	0	0	0	0.0
6:45-7:00	0	0	0	0.0	1	1	2	4.1	1	1	2	1.9
1時間計	1	0	1	1.9	1	1	2	4.1	2	1	3	2.9
夜12時間計	3	3	6	11.1	3	6	9	18.4	6	9	15	14.6
全時間合計	20	34	54	100.0	13	36	49	100.0	33	70	103	100.0
昼夜平均	1.18	1.10	1.13	-	1.30	1.20	1.23	-	1.22	1.15	1.17	-

歩行者通行量調査表

調査地点 地域社会2 目黒交番前

調査年月日 令和元年 5月14日(火) 天候 雨のち曇り



時間帯	方向 種別	合計 (7+イ+ウ+1+オ+カ+キ)			時間 係数 (%)
		歩行者 (人)	自転車 (台)	合計 (人・台)	
7:00-7:15		0	10	10	1.7
7:15-7:30		4	5	9	1.5
7:30-7:45		4	2	6	1.0
7:45-8:00		3	18	21	3.6
1時間計		11	35	46	7.9
8:00-8:15		13	33	46	7.9
8:15-8:30		7	24	31	5.3
8:30-8:45		4	12	16	2.8
8:45-9:00		12	4	16	2.8
1時間計		36	73	109	18.8
9:00-9:15		2	2	4	0.7
9:15-9:30		3	4	7	1.2
9:30-9:45		7	2	9	1.5
9:45-10:00		3	1	4	0.7
1時間計		15	9	24	4.1
10:00-10:15		3	4	7	1.2
10:15-10:30		3	2	5	0.9
10:30-10:45		3	0	3	0.5
10:45-11:00		0	1	1	0.2
1時間計		9	7	16	2.8
11:00-11:15		2	1	3	0.5
11:15-11:30		0	1	1	0.2
11:30-11:45		0	3	3	0.5
11:45-12:00		2	1	3	0.5
1時間計		4	6	10	1.7
12:00-12:15		1	2	3	0.5
12:15-12:30		0	1	1	0.2
12:30-12:45		1	1	2	0.3
12:45-13:00		4	2	6	1.0
1時間計		6	6	12	2.1
13:00-13:15		3	2	5	0.9
13:15-13:30		3	2	5	0.9
13:30-13:45		2	3	5	0.9
13:45-14:00		0	2	2	0.3
1時間計		8	9	17	2.9
14:00-14:15		3	1	4	0.7
14:15-14:30		2	3	5	0.9
14:30-14:45		0	0	0	0.0
14:45-15:00		0	3	3	0.5
1時間計		5	7	12	2.1
15:00-15:15		3	6	9	1.5
15:15-15:30		0	5	5	0.9
15:30-15:45		0	6	6	1.0
15:45-16:00		1	10	11	1.9
1時間計		4	27	31	5.3
16:00-16:15		3	3	6	1.0
16:15-16:30		5	9	14	2.4
16:30-16:45		2	8	10	1.7
16:45-17:00		2	5	7	1.2
1時間計		12	25	37	6.4
17:00-17:15		4	6	10	1.7
17:15-17:30		14	19	33	5.7
17:30-17:45		6	5	11	1.9
17:45-18:00		2	11	13	2.2
1時間計		26	41	67	11.5
18:00-18:15		6	5	11	1.9
18:15-18:30		8	22	30	5.2
18:30-18:45		4	13	17	2.9
18:45-19:00		3	5	8	1.4
1時間計		21	45	66	11.4
昼12時間計		157	290	447	76.9

時間帯	方向 種別	合計 (7+イ+ウ+1+オ+カ+キ)			時間 係数 (%)
		歩行者 (人)	自転車 (台)	合計 (人・台)	
7:00-8:00		11	35	46	7.9
7:15-8:15		24	58	82	14.1
7:30-8:30		27	77	104	17.9
7:45-8:45		27	87	114	19.6
8:00-9:00		36	73	109	18.8
8:15-9:15		25	42	67	11.5
8:30-9:30		21	22	43	7.4
8:45-9:45		24	12	36	6.2
9:00-10:00		15	9	24	4.1
9:15-10:15		16	11	27	4.6
9:30-10:30		16	9	25	4.3
9:45-10:45		12	7	19	3.3
10:00-11:00		9	7	16	2.8
10:15-11:15		8	4	12	2.1
10:30-11:30		5	3	8	1.4
10:45-11:45		2	6	8	1.4
11:00-12:00		4	6	10	1.7
11:15-12:15		3	7	10	1.7
11:30-12:30		3	7	10	1.7
11:45-12:45		4	5	9	1.5
12:00-13:00		6	6	12	2.1
12:15-13:15		8	6	14	2.4
12:30-13:30		11	7	18	3.1
12:45-13:45		12	9	21	3.6
13:00-14:00		8	9	17	2.9
13:15-14:15		8	8	16	2.8
13:30-14:30		7	9	16	2.8
13:45-14:45		5	6	11	1.9
14:00-15:00		5	7	12	2.1
14:15-15:15		5	12	17	2.9
14:30-15:30		3	14	17	2.9
14:45-15:45		3	20	23	4.0
15:00-16:00		4	27	31	5.3
15:15-16:15		4	24	28	4.8
15:30-16:30		9	28	37	6.4
15:45-16:45		11	30	41	7.1
16:00-17:00		12	25	37	6.4
16:15-17:15		13	28	41	7.1
16:30-17:30		22	38	60	10.3
16:45-17:45		26	35	61	10.5
17:00-18:00		26	41	67	11.5
17:15-18:15		28	40	68	11.7
17:30-18:30		22	43	65	11.2
17:45-18:45		20	51	71	12.2
18:00-19:00		21	45	66	11.4
18:15-19:15		18	45	63	10.8
18:30-19:30		14	29	43	7.4
18:45-19:45		11	21	32	5.5
19:00-20:00		10	19	29	5.0
19:15-20:15		9	26	35	6.0
19:30-20:30		5	23	28	4.8
19:45-20:45		4	23	27	4.6
20:00-21:00		4	23	27	4.6
20:15-21:15		3	13	16	2.8
20:30-21:30		3	14	17	2.9
20:45-21:45		3	14	17	2.9
21:00-22:00		2	11	13	2.2
21:15-22:15		1	11	12	2.1
21:30-22:30		1	9	10	1.7
21:45-22:45		2	4	6	1.0
22:00-23:00		1	5	6	1.0

歩行者通行量調査表

調査地点 地域社会2 目黒交番前

調査年月日 令和元年 5月14日(火) 天候: 雨のち曇り



時間帯	方向	種別	合計 (7+イ+ウ+1+オ+カ+キ+リ)			時間係数 (%)
			歩行者 (人)	自転車 (台)	合計 (人・台)	
19 00-19:15			3	5	8	1.4
19 15-19:30			4	6	10	1.7
19 30-19:45			1	5	6	1.0
19 45-20:00			2	3	5	0.9
1時間計			10	19	29	5.0
20 00-20:15			2	12	14	2.4
20 15-20:30			0	3	3	0.5
20 30-20:45			0	5	5	0.9
20 45-21:00			2	3	5	0.9
1時間計			4	23	27	4.6
21 00-21:15			1	2	3	0.5
21 15-21:30			0	4	4	0.7
21 30-21:45			0	5	5	0.9
21 45-22:00			1	0	1	0.2
1時間計			2	11	13	2.2
22 00-22:15			0	2	2	0.3
22 15-22:30			0	2	2	0.3
22 30-22:45			1	0	1	0.2
22 45-23:00			0	1	1	0.2
1時間計			1	5	6	1.0
23 00-23:15			0	0	0	0.0
23 15-23:30			0	2	2	0.3
23 30-23:45			0	1	1	0.2
23 45-24:00			0	0	0	0.0
1時間計			0	3	3	0.5
0 00- 0:15			1	1	2	0.3
0 15- 0:30			0	0	0	0.0
0 30- 0:45			0	1	1	0.2
0 45- 1:00			0	0	0	0.0
1時間計			1	2	3	0.5
1 00- 1:15			0	0	0	0.0
1 15- 1:30			0	0	0	0.0
1 30- 1:45			0	0	0	0.0
1 45- 2:00			0	0	0	0.0
1時間計			0	0	0	0.0
2 00- 2:15			1	0	1	0.2
2 15- 2:30			0	0	0	0.0
2 30- 2:45			0	1	1	0.2
2 45- 3:00			0	0	0	0.0
1時間計			1	1	2	0.3
3 00- 3:15			0	0	0	0.0
3 15- 3:30			0	0	0	0.0
3 30- 3:45			1	0	1	0.2
3 45- 4:00			1	1	2	0.3
1時間計			2	1	3	0.5
4 00- 4:15			0	0	0	0.0
4 15- 4:30			0	0	0	0.0
4 30- 4:45			0	0	0	0.0
4 45- 5:00			0	3	3	0.5
1時間計			0	3	3	0.5
5 00- 5:15			0	2	2	0.3
5 15- 5:30			0	3	3	0.5
5 30- 5:45			2	5	7	1.2
5 45- 6:00			5	2	7	1.2
1時間計			7	12	19	3.3
6 00- 6:15			1	4	5	0.9
6 15- 6:30			1	3	4	0.7
6 30- 6:45			0	9	9	1.5
6 45- 7:00			1	7	8	1.4
1時間計			3	23	26	4.5
夜12時間計			31	103	134	23.1
全時間合計			188	393	581	100.0
昼夜率			1.20	1.36	1.30	-

時間帯	方向	種別	合計 (7+イ+ウ+1+オ+カ+キ+リ)			時間係数 (%)
			歩行者 (人)	自転車 (台)	合計 (人・台)	
22 15-23:15			1	3	4	0.7
22 30-23:30			1	3	4	0.7
22 45-23:45			0	4	4	0.7
23 00-0:00			0	3	3	0.5
23 15-0:15			1	4	5	0.9
23 30-0:30			1	2	3	0.5
23 45-0:45			1	2	3	0.5
0 00-1:00			1	2	3	0.5
0 15-1:15			0	1	1	0.2
0 30-1:30			0	1	1	0.2
0 45-1:45			0	0	0	0.0
1 00-2:00			0	0	0	0.0
1 15-2:15			1	0	1	0.2
1 30-2:30			1	0	1	0.2
1 45-2:45			1	1	2	0.3
2 00-3:00			1	1	2	0.3
2 15-3:15			0	1	1	0.2
2 30-3:30			0	1	1	0.2
2 45-3:45			1	0	1	0.2
3 00-4:00			2	1	3	0.5
3 15-4:15			2	1	3	0.5
3 30-4:30			2	1	3	0.5
3 45-4:45			1	1	2	0.3
4 00-5:00			0	3	3	0.5
4 15-5:15			0	5	5	0.9
4 30-5:30			0	8	8	1.4
4 45-5:45			2	13	15	2.6
5 00-6:00			7	12	19	3.3
5 15-6:15			8	14	22	3.8
5 30-6:30			9	14	23	4.0
5 45-6:45			7	18	25	4.3
6 00-7:00			3	23	26	4.5
全時間合計			188	393	581	100.0

歩行者通行量調査表

調査地点 地域社会3 上川井IC

調査年月日 令和元年 5月14日(火) 天候 雨のち曇り

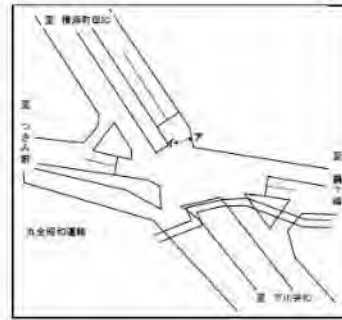

時間帯	方向 7				方向 1				合計			
	歩行者 (人)	自転車 (台)	合計 (人・台)	時間 係数 (%)	歩行者 (人)	自転車 (台)	合計 (人・台)	時間 係数 (%)	歩行者 (人)	自転車 (台)	合計 (人・台)	時間 係数 (%)
7:00-7:15	8	2	10	4.9	1	0	1	0.6	9	2	11	2.9
7:15-7:30	5	0	5	2.5	4	2	6	3.6	9	2	11	2.9
7:30-7:45	2	1	3	1.5	2	0	2	1.2	4	1	5	1.3
7:45-8:00	15	10	25	12.3	4	2	6	3.6	19	12	31	8.3
1時間計	30	13	43	21.1	11	4	15	8.9	41	17	58	15.5
8:00-8:15	3	10	13	6.4	6	3	9	5.3	9	13	22	5.9
8:15-8:30	3	9	12	5.9	1	5	6	3.6	4	14	18	4.8
8:30-8:45	2	2	4	2.0	2	2	4	2.4	4	4	8	2.1
8:45-9:00	3	0	3	1.5	2	2	4	2.4	5	2	7	1.9
1時間計	11	21	32	15.7	11	12	23	13.6	22	33	55	14.7
9:00-9:15	0	0	0	0.0	1	2	3	1.8	1	2	3	0.8
9:15-9:30	4	0	4	2.0	0	0	0	0.0	4	0	4	1.1
9:30-9:45	0	0	0	0.0	1	1	2	1.2	1	1	2	0.5
9:45-10:00	0	0	0	0.0	0	0	0	0.0	0	0	0	0.0
1時間計	4	0	4	2.0	2	3	5	3.0	6	3	9	2.4
10:00-10:15	0	0	0	0.0	1	2	3	1.8	1	2	3	0.8
10:15-10:30	2	1	3	1.5	1	1	2	1.2	3	2	5	1.3
10:30-10:45	0	0	0	0.0	0	0	0	0.0	0	0	0	0.0
10:45-11:00	1	0	1	0.5	1	0	1	0.6	2	0	2	0.5
1時間計	3	1	4	2.0	3	3	6	3.6	6	4	10	2.7
11:00-11:15	2	0	2	1.0	0	0	0	0.0	2	0	2	0.5
11:15-11:30	0	0	0	0.0	0	0	0	0.0	0	0	0	0.0
11:30-11:45	0	0	0	0.0	0	0	0	0.0	0	0	0	0.0
11:45-12:00	0	0	0	0.0	1	0	1	0.6	1	0	1	0.3
1時間計	2	0	2	1.0	1	0	1	0.6	3	0	3	0.8
12:00-12:15	0	0	0	0.0	0	0	0	0.0	0	0	0	0.0
12:15-12:30	0	0	0	0.0	0	0	0	0.0	0	0	0	0.0
12:30-12:45	0	0	0	0.0	2	0	2	1.2	2	0	2	0.5
12:45-13:00	3	0	3	1.5	0	0	0	0.0	3	0	3	0.8
1時間計	3	0	3	1.5	2	0	2	1.2	5	0	5	1.3
13:00-13:15	5	0	5	2.5	0	0	0	0.0	5	0	5	1.3
13:15-13:30	1	0	1	0.5	0	2	2	1.2	1	2	3	0.8
13:30-13:45	0	0	0	0.0	0	0	0	0.0	0	0	0	0.0
13:45-14:00	2	0	2	1.0	0	0	0	0.0	2	0	2	0.5
1時間計	8	0	8	3.9	0	2	2	1.2	8	2	10	2.7
14:00-14:15	2	0	2	1.0	0	0	0	0.0	2	0	2	0.5
14:15-14:30	1	0	1	0.5	0	0	0	0.0	1	0	1	0.3
14:30-14:45	0	0	0	0.0	1	0	1	0.6	1	0	1	0.3
14:45-15:00	1	1	2	1.0	5	0	5	3.0	6	1	7	1.9
1時間計	4	1	5	2.5	6	0	6	3.6	10	1	11	2.9

歩行者通行量調査表

調査地点 地域社会3 上川井IC

調査年月日 令和元年 5月14日(火) 天候 雨のち曇り

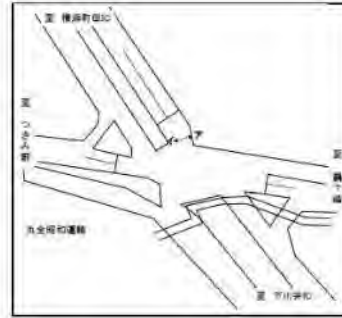

時間帯	方向 7				方向 1				合計			
	歩行者 (人)	自転車 (台)	合計 (人・台)	時間 係数 (%)	歩行者 (人)	自転車 (台)	合計 (人・台)	時間 係数 (%)	歩行者 (人)	自転車 (台)	合計 (人・台)	時間 係数 (%)
15:00-15:15	1	1	2	1.0	0	0	0	0.0	1	1	2	0.5
15:15-15:30	1	1	2	1.0	1	0	1	0.6	2	1	3	0.8
15:30-15:45	0	1	1	0.5	3	1	4	2.4	3	2	5	1.3
15:45-16:00	0	4	4	2.0	8	4	12	7.1	8	8	16	4.3
1時間計	2	7	9	4.4	12	5	17	10.1	14	12	26	7.0
16:00-16:15	0	3	3	1.5	4	4	8	4.7	4	7	11	2.9
16:15-16:30	0	4	4	2.0	2	1	3	1.8	2	5	7	1.9
16:30-16:45	1	0	1	0.5	4	5	9	5.3	5	5	10	2.7
16:45-17:00	0	3	3	1.5	1	1	2	1.2	1	4	5	1.3
1時間計	1	10	11	5.4	11	11	22	13.0	12	21	33	8.8
17:00-17:15	3	2	5	2.5	4	1	5	3.0	7	3	10	2.7
17:15-17:30	3	1	4	2.0	1	1	2	1.2	4	2	6	1.6
17:30-17:45	3	3	6	2.9	3	2	5	3.0	6	5	11	2.9
17:45-18:00	1	1	2	1.0	2	1	3	1.8	3	2	5	1.3
1時間計	10	7	17	8.3	10	5	15	8.9	20	12	32	8.6
18:00-18:15	0	0	0	0.0	2	1	3	1.8	2	1	3	0.8
18:15-18:30	1	3	4	2.0	3	2	5	3.0	4	5	9	2.4
18:30-18:45	0	0	0	0.0	2	0	2	1.2	2	0	2	0.5
18:45-19:00	1	2	3	1.5	0	0	0	0.0	1	2	3	0.8
1時間計	2	5	7	3.4	7	3	10	5.9	9	8	17	4.6
昼12時間計	80	65	145	71.1	76	48	124	73.4	156	113	269	72.1
19:00-19:15	1	3	4	2.0	4	1	5	3.0	5	4	9	2.4
19:15-19:30	0	0	0	0.0	5	2	7	4.1	5	2	7	1.9
19:30-19:45	1	2	3	1.5	2	0	2	1.2	3	2	5	1.3
19:45-20:00	0	1	1	0.5	1	1	2	1.2	1	2	3	0.8
1時間計	2	6	8	3.9	12	4	16	9.5	14	10	24	6.4
20:00-20:15	1	1	2	1.0	3	1	4	2.4	4	2	6	1.6
20:15-20:30	2	3	5	2.5	0	1	1	0.6	2	4	6	1.6
20:30-20:45	0	0	0	0.0	1	0	1	0.6	1	0	1	0.3
20:45-21:00	2	3	5	2.5	0	0	0	0.0	2	3	5	1.3
1時間計	5	7	12	5.9	4	2	6	3.6	9	9	18	4.8
21:00-21:15	0	0	0	0.0	3	0	3	1.8	3	0	3	0.8
21:15-21:30	0	0	0	0.0	3	0	3	1.8	3	0	3	0.8
21:30-21:45	0	0	0	0.0	4	0	4	2.4	4	0	4	1.1
21:45-22:00	0	0	0	0.0	4	0	4	2.4	4	0	4	1.1
1時間計	0	0	0	0.0	14	0	14	8.3	14	0	14	3.8
22:00-22:15	1	0	1	0.5	0	0	0	0.0	1	0	1	0.3
22:15-22:30	0	0	0	0.0	0	0	0	0.0	0	0	0	0.0
22:30-22:45	0	0	0	0.0	1	0	1	0.6	1	0	1	0.3
22:45-23:00	0	1	1	0.5	1	0	1	0.6	1	1	2	0.5
1時間計	1	1	2	1.0	2	0	2	1.2	3	1	4	1.1

歩行者通行量調査表

調査地点 地域社会3 上川井IC

調査年月日 令和元年 5月14日(火) 天候 雨のち曇り

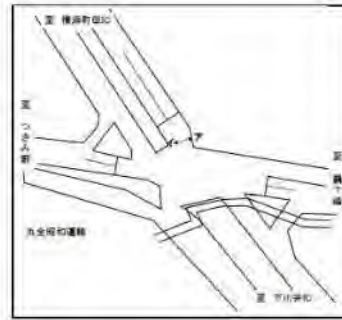

方向	7				1				合計			
	歩行者 (人)	自転車 (台)	合計 (人・台)	時間 係数 (%)	歩行者 (人)	自転車 (台)	合計 (人・台)	時間 係数 (%)	歩行者 (人)	自転車 (台)	合計 (人・台)	時間 係数 (%)
時間帯												
23:00-23:15	0	0	0	0.0	1	0	1	0.6	1	0	1	0.3
23:15-23:30	0	0	0	0.0	0	0	0	0.0	0	0	0	0.0
23:30-23:45	0	0	0	0.0	0	0	0	0.0	0	0	0	0.0
23:45-24:00	0	0	0	0.0	0	0	0	0.0	0	0	0	0.0
1時間計	0	0	0	0.0	1	0	1	0.6	1	0	1	0.3
0:00-0:15	0	0	0	0.0	0	0	0	0.0	0	0	0	0.0
0:15-0:30	0	0	0	0.0	0	0	0	0.0	0	0	0	0.0
0:30-0:45	0	1	1	0.5	0	0	0	0.0	0	1	1	0.3
0:45-1:00	0	0	0	0.0	0	0	0	0.0	0	0	0	0.0
1時間計	0	1	1	0.5	0	0	0	0.0	0	1	1	0.3
1:00-1:15	0	0	0	0.0	0	0	0	0.0	0	0	0	0.0
1:15-1:30	0	0	0	0.0	0	0	0	0.0	0	0	0	0.0
1:30-1:45	0	0	0	0.0	0	0	0	0.0	0	0	0	0.0
1:45-2:00	0	0	0	0.0	0	0	0	0.0	0	0	0	0.0
1時間計	0	0	0	0.0	0	0	0	0.0	0	0	0	0.0
2:00-2:15	0	0	0	0.0	0	1	1	0.6	0	1	1	0.3
2:15-2:30	0	0	0	0.0	0	0	0	0.0	0	0	0	0.0
2:30-2:45	0	0	0	0.0	0	0	0	0.0	0	0	0	0.0
2:45-3:00	0	0	0	0.0	0	0	0	0.0	0	0	0	0.0
1時間計	0	0	0	0.0	0	1	1	0.6	0	1	1	0.3
3:00-3:15	0	0	0	0.0	0	0	0	0.0	0	0	0	0.0
3:15-3:30	0	0	0	0.0	0	0	0	0.0	0	0	0	0.0
3:30-3:45	0	0	0	0.0	0	0	0	0.0	0	0	0	0.0
3:45-4:00	0	0	0	0.0	0	0	0	0.0	0	0	0	0.0
1時間計	0	0	0	0.0	0	0	0	0.0	0	0	0	0.0
4:00-4:15	0	0	0	0.0	0	0	0	0.0	0	0	0	0.0
4:15-4:30	0	0	0	0.0	0	0	0	0.0	0	0	0	0.0
4:30-4:45	1	0	1	0.5	0	0	0	0.0	1	0	1	0.3
4:45-5:00	1	1	2	1.0	0	0	0	0.0	1	1	2	0.5
1時間計	2	1	3	1.5	0	0	0	0.0	2	1	3	0.8
5:00-5:15	1	0	1	0.5	1	0	1	0.6	2	0	2	0.5
5:15-5:30	0	0	0	0.0	0	0	0	0.0	0	0	0	0.0
5:30-5:45	1	1	2	1.0	0	0	0	0.0	1	1	2	0.5
5:45-6:00	2	1	3	1.5	0	0	0	0.0	2	1	3	0.8
1時間計	4	2	6	2.9	1	0	1	0.6	5	2	7	1.9
6:00-6:15	3	3	6	2.9	0	1	1	0.6	3	4	7	1.9
6:15-6:30	3	0	3	1.5	0	0	0	0.0	3	0	3	0.8
6:30-6:45	5	5	10	4.9	0	1	1	0.6	5	6	11	2.9
6:45-7:00	4	4	8	3.9	1	1	2	1.2	5	5	10	2.7
1時間計	15	12	27	13.2	1	3	4	2.4	16	15	31	8.3
夜12時間計	29	30	59	28.9	35	10	45	26.6	64	40	104	27.9
全時間合計	109	95	204	100.0	111	58	169	100.0	220	153	373	100.0
昼夜平均	1.36	1.46	1.41	-	1.46	1.21	1.36	-	1.41	1.35	1.39	-

歩行者通行量調査表

調査地点 地域社会3 上川井IC

調査年月日 令和元年 5月14日(火) 天候 雨のち曇り

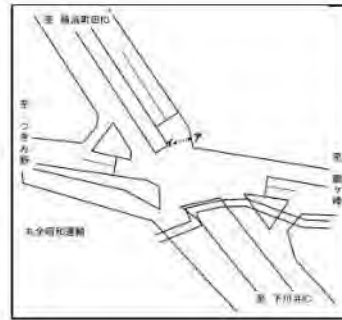

時間帯	方向 種別	合計 (7+1)			時間 係数 (%)
		歩行者 (人)	自転車 (台)	合計 (人・台)	
7:00-7:15		9	2	11	2.9
7:15-7:30		9	2	11	2.9
7:30-7:45		4	1	5	1.3
7:45-8:00		19	12	31	8.3
1時間計		41	17	58	15.5
8:00-8:15		9	13	22	5.9
8:15-8:30		4	14	18	4.8
8:30-8:45		4	4	8	2.1
8:45-9:00		5	2	7	1.9
1時間計		22	33	55	14.7
9:00-9:15		1	2	3	0.8
9:15-9:30		4	0	4	1.1
9:30-9:45		1	1	2	0.5
9:45-10:00		0	0	0	0.0
1時間計		6	3	9	2.4
10:00-10:15		1	2	3	0.8
10:15-10:30		3	2	5	1.3
10:30-10:45		0	0	0	0.0
10:45-11:00		2	0	2	0.5
1時間計		6	4	10	2.7
11:00-11:15		2	0	2	0.5
11:15-11:30		0	0	0	0.0
11:30-11:45		0	0	0	0.0
11:45-12:00		1	0	1	0.3
1時間計		3	0	3	0.8
12:00-12:15		0	0	0	0.0
12:15-12:30		0	0	0	0.0
12:30-12:45		2	0	2	0.5
12:45-13:00		3	0	3	0.8
1時間計		5	0	5	1.3
13:00-13:15		5	0	5	1.3
13:15-13:30		1	2	3	0.8
13:30-13:45		0	0	0	0.0
13:45-14:00		2	0	2	0.5
1時間計		8	2	10	2.7
14:00-14:15		2	0	2	0.5
14:15-14:30		1	0	1	0.3
14:30-14:45		1	0	1	0.3
14:45-15:00		6	1	7	1.9
1時間計		10	1	11	2.9
15:00-15:15		1	1	2	0.5
15:15-15:30		2	1	3	0.8
15:30-15:45		3	2	5	1.3
15:45-16:00		8	8	16	4.3
1時間計		14	12	26	7.0
16:00-16:15		4	7	11	2.9
16:15-16:30		2	5	7	1.9
16:30-16:45		5	5	10	2.7
16:45-17:00		1	4	5	1.3
1時間計		12	21	33	8.8
17:00-17:15		7	3	10	2.7
17:15-17:30		4	2	6	1.6
17:30-17:45		6	5	11	2.9
17:45-18:00		3	2	5	1.3
1時間計		20	12	32	8.6
18:00-18:15		2	1	3	0.8
18:15-18:30		4	5	9	2.4
18:30-18:45		2	0	2	0.5
18:45-19:00		1	2	3	0.8
1時間計		9	8	17	4.6
昼12時間計		156	113	269	72.1

時間帯	方向 種別	合計 (7+1)			時間 係数 (%)
		歩行者 (人)	自転車 (台)	合計 (人・台)	
7:00-8:00		41	17	58	15.5
7:15-8:15		41	28	69	18.5
7:30-8:30		36	40	76	20.4
7:45-8:45		36	43	79	21.2
8:00-9:00		22	33	55	14.7
8:15-9:15		14	22	36	9.7
8:30-9:30		14	8	22	5.9
8:45-9:45		11	5	16	4.3
9:00-10:00		6	3	9	2.4
9:15-10:15		6	3	9	2.4
9:30-10:30		5	5	10	2.7
9:45-10:45		4	4	8	2.1
10:00-11:00		6	4	10	2.7
10:15-11:15		7	2	9	2.4
10:30-11:30		4	0	4	1.1
10:45-11:45		4	0	4	1.1
11:00-12:00		3	0	3	0.8
11:15-12:15		1	0	1	0.3
11:30-12:30		1	0	1	0.3
11:45-12:45		3	0	3	0.8
12:00-13:00		5	0	5	1.3
12:15-13:15		10	0	10	2.7
12:30-13:30		11	2	13	3.5
12:45-13:45		9	2	11	2.9
13:00-14:00		8	2	10	2.7
13:15-14:15		5	2	7	1.9
13:30-14:30		5	0	5	1.3
13:45-14:45		6	0	6	1.6
14:00-15:00		10	1	11	2.9
14:15-15:15		9	2	11	2.9
14:30-15:30		10	3	13	3.5
14:45-15:45		12	5	17	4.6
15:00-16:00		14	12	26	7.0
15:15-16:15		17	18	35	9.4
15:30-16:30		17	22	39	10.5
15:45-16:45		19	25	44	11.8
16:00-17:00		12	21	33	8.8
16:15-17:15		15	17	32	8.6
16:30-17:30		17	14	31	8.3
16:45-17:45		18	14	32	8.6
17:00-18:00		20	12	32	8.6
17:15-18:15		15	10	25	6.7
17:30-18:30		15	13	28	7.5
17:45-18:45		11	8	19	5.1
18:00-19:00		9	8	17	4.6
18:15-19:15		12	11	23	6.2
18:30-19:30		13	8	21	5.6
18:45-19:45		14	10	24	6.4
19:00-20:00		14	10	24	6.4
19:15-20:15		13	8	21	5.6
19:30-20:30		10	10	20	5.4
19:45-20:45		8	8	16	4.3
20:00-21:00		9	9	18	4.8
20:15-21:15		8	7	15	4.0
20:30-21:30		9	3	12	3.2
20:45-21:45		12	3	15	4.0
21:00-22:00		14	0	14	3.8
21:15-22:15		12	0	12	3.2
21:30-22:30		9	0	9	2.4
21:45-22:45		6	0	6	1.6
22:00-23:00		3	1	4	1.1

歩行者通行量調査表

調査地点 地域社会3 上川井IC

調査年月日 令和元年 5月14日(火) 天候 雨のち曇り

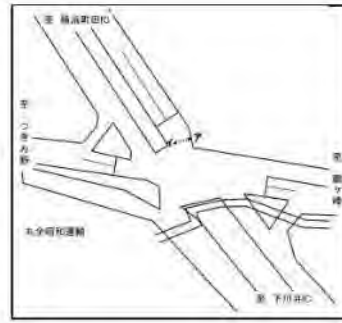

時間帯	方向 種別	合計 (7+1)			時間 係数 (%)
		歩行者 (人)	自転車 (台)	合計 (人・台)	
19:00-19:15		5	4	9	2.4
19:15-19:30		5	2	7	1.9
19:30-19:45		3	2	5	1.3
19:45-20:00		1	2	3	0.8
1時間計		14	10	24	6.4
20:00-20:15		4	2	6	1.6
20:15-20:30		2	4	6	1.6
20:30-20:45		1	0	1	0.3
20:45-21:00		2	3	5	1.3
1時間計		9	9	18	4.8
21:00-21:15		3	0	3	0.8
21:15-21:30		3	0	3	0.8
21:30-21:45		4	0	4	1.1
21:45-22:00		4	0	4	1.1
1時間計		14	0	14	3.8
22:00-22:15		1	0	1	0.3
22:15-22:30		0	0	0	0.0
22:30-22:45		1	0	1	0.3
22:45-23:00		1	1	2	0.5
1時間計		3	1	4	1.1
23:00-23:15		1	0	1	0.3
23:15-23:30		0	0	0	0.0
23:30-23:45		0	0	0	0.0
23:45-24:00		0	0	0	0.0
1時間計		1	0	1	0.3
0:00-0:15		0	0	0	0.0
0:15-0:30		0	0	0	0.0
0:30-0:45		0	1	1	0.3
0:45-1:00		0	0	0	0.0
1時間計		0	1	1	0.3
1:00-1:15		0	0	0	0.0
1:15-1:30		0	0	0	0.0
1:30-1:45		0	0	0	0.0
1:45-2:00		0	0	0	0.0
1時間計		0	0	0	0.0
2:00-2:15		0	1	1	0.3
2:15-2:30		0	0	0	0.0
2:30-2:45		0	0	0	0.0
2:45-3:00		0	0	0	0.0
1時間計		0	1	1	0.3
3:00-3:15		0	0	0	0.0
3:15-3:30		0	0	0	0.0
3:30-3:45		0	0	0	0.0
3:45-4:00		0	0	0	0.0
1時間計		0	0	0	0.0
4:00-4:15		0	0	0	0.0
4:15-4:30		0	0	0	0.0
4:30-4:45		1	0	1	0.3
4:45-5:00		1	1	2	0.5
1時間計		2	1	3	0.8
5:00-5:15		2	0	2	0.5
5:15-5:30		0	0	0	0.0
5:30-5:45		1	1	2	0.5
5:45-6:00		2	1	3	0.8
1時間計		5	2	7	1.9
6:00-6:15		3	4	7	1.9
6:15-6:30		3	0	3	0.8
6:30-6:45		5	6	11	2.9
6:45-7:00		5	5	10	2.7
1時間計		16	15	31	8.3
夜12時間計		64	40	104	27.9
全時間合計		220	153	373	100.0
昼 夜 率		1.41	1.35	1.39	-

時間帯	方向 種別	合計 (7+1)			時間 係数 (%)
		歩行者 (人)	自転車 (台)	合計 (人・台)	
22:15-23:15		3	1	4	1.1
22:30-23:30		3	1	4	1.1
22:45-23:45		2	1	3	0.8
23:00-0:00		1	0	1	0.3
23:15-0:15		0	0	0	0.0
23:30-0:30		0	0	0	0.0
23:45-0:45		0	1	1	0.3
0:00-1:00		0	1	1	0.3
0:15-1:15		0	1	1	0.3
0:30-1:30		0	1	1	0.3
0:45-1:45		0	0	0	0.0
1:00-2:00		0	0	0	0.0
1:15-2:15		0	1	1	0.3
1:30-2:30		0	1	1	0.3
1:45-2:45		0	1	1	0.3
2:00-3:00		0	1	1	0.3
2:15-3:15		0	0	0	0.0
2:30-3:30		0	0	0	0.0
2:45-3:45		0	0	0	0.0
3:00-4:00		0	0	0	0.0
3:15-4:15		0	0	0	0.0
3:30-4:30		0	0	0	0.0
3:45-4:45		1	0	1	0.3
4:00-5:00		2	1	3	0.8
4:15-5:15		4	1	5	1.3
4:30-5:30		4	1	5	1.3
4:45-5:45		4	2	6	1.6
5:00-6:00		5	2	7	1.9
5:15-6:15		6	6	12	3.2
5:30-6:30		9	6	15	4.0
5:45-6:45		13	11	24	6.4
6:00-7:00		16	15	31	8.3
全時間合計		220	153	373	100.0

歩行者通行量調査表

調査地点 地域社会4 滝沢

調査年月日 令和 2年 9月29日(火) 天候 曇りのち晴れ



時間帯	種別	方向 7				方向 1				合計			
		歩行者 (人)	自転車 (台)	合計 (人・台)	時間 係数 (%)	歩行者 (人)	自転車 (台)	合計 (人・台)	時間 係数 (%)	歩行者 (人)	自転車 (台)	合計 (人・台)	時間 係数 (%)
7:00-7:15		0	1	1	6.7	0	0	0	0.0	0	1	1	4.2
7:15-7:30		0	0	0	0.0	0	0	0	0.0	0	0	0	0.0
7:30-7:45		0	0	0	0.0	1	0	1	11.1	1	0	1	4.2
7:45-8:00		0	0	0	0.0	0	0	0	0.0	0	0	0	0.0
1時間計		0	1	1	6.7	1	0	1	11.1	1	1	2	8.3
8:00-8:15		0	0	0	0.0	0	0	0	0.0	0	0	0	0.0
8:15-8:30		0	0	0	0.0	0	0	0	0.0	0	0	0	0.0
8:30-8:45		0	0	0	0.0	1	0	1	11.1	1	0	1	4.2
8:45-9:00		0	0	0	0.0	0	1	1	11.1	0	1	1	4.2
1時間計		0	0	0	0.0	1	1	2	22.2	1	1	2	8.3
9:00-9:15		0	0	0	0.0	0	0	0	0.0	0	0	0	0.0
9:15-9:30		0	1	1	6.7	0	0	0	0.0	0	1	1	4.2
9:30-9:45		0	0	0	0.0	0	0	0	0.0	0	0	0	0.0
9:45-10:00		0	0	0	0.0	0	0	0	0.0	0	0	0	0.0
1時間計		0	1	1	6.7	0	0	0	0.0	0	1	1	4.2
10:00-10:15		0	1	1	6.7	0	0	0	0.0	0	1	1	4.2
10:15-10:30		0	0	0	0.0	0	0	0	0.0	0	0	0	0.0
10:30-10:45		0	0	0	0.0	0	0	0	0.0	0	0	0	0.0
10:45-11:00		0	0	0	0.0	0	0	0	0.0	0	0	0	0.0
1時間計		0	1	1	6.7	0	0	0	0.0	0	1	1	4.2
11:00-11:15		0	0	0	0.0	0	0	0	0.0	0	0	0	0.0
11:15-11:30		0	0	0	0.0	0	0	0	0.0	0	0	0	0.0
11:30-11:45		0	0	0	0.0	1	0	1	11.1	1	0	1	4.2
11:45-12:00		0	0	0	0.0	0	0	0	0.0	0	0	0	0.0
1時間計		0	0	0	0.0	1	0	1	11.1	1	0	1	4.2
12:00-12:15		0	0	0	0.0	0	0	0	0.0	0	0	0	0.0
12:15-12:30		0	0	0	0.0	0	0	0	0.0	0	0	0	0.0
12:30-12:45		0	0	0	0.0	0	0	0	0.0	0	0	0	0.0
12:45-13:00		0	0	0	0.0	0	0	0	0.0	0	0	0	0.0
1時間計		0	0	0	0.0	0	0	0	0.0	0	0	0	0.0
13:00-13:15		0	0	0	0.0	1	1	1	11.1	0	1	1	4.2
13:15-13:30		0	0	0	0.0	0	0	0	0.0	0	0	0	0.0
13:30-13:45		0	0	0	0.0	0	0	0	0.0	0	0	0	0.0
13:45-14:00		0	0	0	0.0	3	0	3	33.3	3	0	3	12.5
1時間計		0	0	0	0.0	3	1	4	44.4	3	1	4	16.7
14:00-14:15		1	0	1	6.7	1	0	1	11.1	2	0	2	8.3
14:15-14:30		0	0	0	0.0	0	0	0	0.0	0	0	0	0.0
14:30-14:45		3	0	3	20.0	0	0	0	0.0	3	0	3	12.5
14:45-15:00		0	0	0	0.0	0	0	0	0.0	0	0	0	0.0
1時間計		4	0	4	26.7	1	0	1	11.1	5	0	5	20.8

歩行者通行量調査表

調査地点 地域社会4 滝沢

調査年月日 令和 2年 9月29日(火) 天候 曇りのち晴れ



時間帯	7				4				合計			
	歩行者 (人)	自転車 (台)	合計 (人・台)	時間 係数 (%)	歩行者 (人)	自転車 (台)	合計 (人・台)	時間 係数 (%)	歩行者 (人)	自転車 (台)	合計 (人・台)	時間 係数 (%)
15:00-15:15	0	0	0	0.0	0	0	0	0.0	0	0	0	0.0
15:15-15:30	0	0	0	0.0	0	0	0	0.0	0	0	0	0.0
15:30-15:45	0	0	0	0.0	0	0	0	0.0	0	0	0	0.0
15:45-16:00	0	0	0	0.0	0	0	0	0.0	0	0	0	0.0
1時間計	0	0	0	0.0	0	0	0	0.0	0	0	0	0.0
16:00-16:15	0	0	0	0.0	0	0	0	0.0	0	0	0	0.0
16:15-16:30	1	0	1	6.7	0	0	0	0.0	1	0	1	4.2
16:30-16:45	0	0	0	0.0	0	0	0	0.0	0	0	0	0.0
16:45-17:00	0	0	0	0.0	0	0	0	0.0	0	0	0	0.0
1時間計	1	0	1	6.7	0	0	0	0.0	1	0	1	4.2
17:00-17:15	0	0	0	0.0	0	0	0	0.0	0	0	0	0.0
17:15-17:30	0	0	0	0.0	0	0	0	0.0	0	0	0	0.0
17:30-17:45	3	0	3	20.0	0	0	0	0.0	3	0	3	12.5
17:45-18:00	1	0	1	6.7	0	0	0	0.0	1	0	1	4.2
1時間計	4	0	4	26.7	0	0	0	0.0	4	0	4	16.7
18:00-18:15	1	0	1	6.7	0	0	0	0.0	1	0	1	4.2
18:15-18:30	0	0	0	0.0	0	0	0	0.0	0	0	0	0.0
18:30-18:45	0	0	0	0.0	0	0	0	0.0	0	0	0	0.0
18:45-19:00	0	1	1	6.7	0	0	0	0.0	0	1	1	4.2
1時間計	1	1	2	13.3	0	0	0	0.0	1	1	2	8.3
昼12時間計	10	4	14	93.3	7	2	9	100.0	17	6	23	95.8
19:00-19:15	0	0	0	0.0	0	0	0	0.0	0	0	0	0.0
19:15-19:30	0	0	0	0.0	0	0	0	0.0	0	0	0	0.0
19:30-19:45	0	0	0	0.0	0	0	0	0.0	0	0	0	0.0
19:45-20:00	0	0	0	0.0	0	0	0	0.0	0	0	0	0.0
1時間計	0	0	0	0.0	0	0	0	0.0	0	0	0	0.0
20:00-20:15	0	0	0	0.0	0	0	0	0.0	0	0	0	0.0
20:15-20:30	0	1	1	6.7	0	0	0	0.0	0	1	1	4.2
20:30-20:45	0	0	0	0.0	0	0	0	0.0	0	0	0	0.0
20:45-21:00	0	0	0	0.0	0	0	0	0.0	0	0	0	0.0
1時間計	0	1	1	6.7	0	0	0	0.0	0	1	1	4.2
21:00-21:15	0	0	0	0.0	0	0	0	0.0	0	0	0	0.0
21:15-21:30	0	0	0	0.0	0	0	0	0.0	0	0	0	0.0
21:30-21:45	0	0	0	0.0	0	0	0	0.0	0	0	0	0.0
21:45-22:00	0	0	0	0.0	0	0	0	0.0	0	0	0	0.0
1時間計	0	0	0	0.0	0	0	0	0.0	0	0	0	0.0
22:00-22:15	0	0	0	0.0	0	0	0	0.0	0	0	0	0.0
22:15-22:30	0	0	0	0.0	0	0	0	0.0	0	0	0	0.0
22:30-22:45	0	0	0	0.0	0	0	0	0.0	0	0	0	0.0
22:45-23:00	0	0	0	0.0	0	0	0	0.0	0	0	0	0.0
1時間計	0	0	0	0.0	0	0	0	0.0	0	0	0	0.0

歩行者通行量調査表

調査地点 地域社会4 滝沢

調査年月日 令和 2年 9月29日(火) 天候 曇りのち晴れ



時間帯	方向 7				方向 4				合計			
	歩行者 (人)	自転車 (台)	合計 (人・台)	時間 係数 (%)	歩行者 (人)	自転車 (台)	合計 (人・台)	時間 係数 (%)	歩行者 (人)	自転車 (台)	合計 (人・台)	時間 係数 (%)
23:00-23:15	0	0	0	0.0	0	0	0	0.0	0	0	0	0.0
23:15-23:30	0	0	0	0.0	0	0	0	0.0	0	0	0	0.0
23:30-23:45	0	0	0	0.0	0	0	0	0.0	0	0	0	0.0
23:45-24:00	0	0	0	0.0	0	0	0	0.0	0	0	0	0.0
1時間計	0	0	0	0.0	0	0	0	0.0	0	0	0	0.0
0:00-0:15	0	0	0	0.0	0	0	0	0.0	0	0	0	0.0
0:15-0:30	0	0	0	0.0	0	0	0	0.0	0	0	0	0.0
0:30-0:45	0	0	0	0.0	0	0	0	0.0	0	0	0	0.0
0:45-1:00	0	0	0	0.0	0	0	0	0.0	0	0	0	0.0
1時間計	0	0	0	0.0	0	0	0	0.0	0	0	0	0.0
1:00-1:15	0	0	0	0.0	0	0	0	0.0	0	0	0	0.0
1:15-1:30	0	0	0	0.0	0	0	0	0.0	0	0	0	0.0
1:30-1:45	0	0	0	0.0	0	0	0	0.0	0	0	0	0.0
1:45-2:00	0	0	0	0.0	0	0	0	0.0	0	0	0	0.0
1時間計	0	0	0	0.0	0	0	0	0.0	0	0	0	0.0
2:00-2:15	0	0	0	0.0	0	0	0	0.0	0	0	0	0.0
2:15-2:30	0	0	0	0.0	0	0	0	0.0	0	0	0	0.0
2:30-2:45	0	0	0	0.0	0	0	0	0.0	0	0	0	0.0
2:45-3:00	0	0	0	0.0	0	0	0	0.0	0	0	0	0.0
1時間計	0	0	0	0.0	0	0	0	0.0	0	0	0	0.0
3:00-3:15	0	0	0	0.0	0	0	0	0.0	0	0	0	0.0
3:15-3:30	0	0	0	0.0	0	0	0	0.0	0	0	0	0.0
3:30-3:45	0	0	0	0.0	0	0	0	0.0	0	0	0	0.0
3:45-4:00	0	0	0	0.0	0	0	0	0.0	0	0	0	0.0
1時間計	0	0	0	0.0	0	0	0	0.0	0	0	0	0.0
4:00-4:15	0	0	0	0.0	0	0	0	0.0	0	0	0	0.0
4:15-4:30	0	0	0	0.0	0	0	0	0.0	0	0	0	0.0
4:30-4:45	0	0	0	0.0	0	0	0	0.0	0	0	0	0.0
4:45-5:00	0	0	0	0.0	0	0	0	0.0	0	0	0	0.0
1時間計	0	0	0	0.0	0	0	0	0.0	0	0	0	0.0
5:00-5:15	0	0	0	0.0	0	0	0	0.0	0	0	0	0.0
5:15-5:30	0	0	0	0.0	0	0	0	0.0	0	0	0	0.0
5:30-5:45	0	0	0	0.0	0	0	0	0.0	0	0	0	0.0
5:45-6:00	0	0	0	0.0	0	0	0	0.0	0	0	0	0.0
1時間計	0	0	0	0.0	0	0	0	0.0	0	0	0	0.0
6:00-6:15	0	0	0	0.0	0	0	0	0.0	0	0	0	0.0
6:15-6:30	0	0	0	0.0	0	0	0	0.0	0	0	0	0.0
6:30-6:45	0	0	0	0.0	0	0	0	0.0	0	0	0	0.0
6:45-7:00	0	0	0	0.0	0	0	0	0.0	0	0	0	0.0
1時間計	0	0	0	0.0	0	0	0	0.0	0	0	0	0.0
夜12時間計	0	1	1	6.7	0	0	0	0.0	0	1	1	4.2
全時間合計	10	5	15	100.0	7	2	9	100.0	17	7	24	100.0
昼夜平均	1.00	1.25	1.07	-	1.00	1.00	1.00	-	1.00	1.17	1.04	-

歩行者通行量調査表

調査地点 地域社会4 滝沢

調査年月日 令和 2年 9月29日(火) 天候 曇りのち晴れ



方向	ウ				エ				合計				
	種別	歩行者 (人)	自転車 (台)	合計 (人・台)	時間 係数 (%)	歩行者 (人)	自転車 (台)	合計 (人・台)	時間 係数 (%)	歩行者 (人)	自転車 (台)	合計 (人・台)	時間 係数 (%)
7:00-7:15		1	3	4	1.4	2	0	2	1.2	3	3	6	1.3
7:15-7:30		2	5	7	2.5	0	1	1	0.6	2	6	8	1.8
7:30-7:45		7	4	11	3.9	2	0	2	1.2	9	4	13	2.9
7:45-8:00		1	4	5	1.8	0	1	1	0.6	1	5	6	1.3
1時間計		11	16	27	9.5	4	2	6	3.5	15	18	33	7.3
8:00-8:15		1	5	6	2.1	2	1	3	1.7	3	6	9	2.0
8:15-8:30		11	16	27	9.5	1	1	2	1.2	12	17	29	6.4
8:30-8:45		5	10	15	5.3	0	12	12	7.0	5	22	27	5.9
8:45-9:00		1	3	4	1.4	0	22	22	12.8	1	25	26	5.7
1時間計		18	34	52	18.4	3	36	39	22.7	21	70	91	20.0
9:00-9:15		3	0	3	1.1	3	1	4	2.3	6	1	7	1.5
9:15-9:30		1	0	1	0.4	1	1	2	1.2	2	1	3	0.7
9:30-9:45		1	5	6	2.1	2	0	2	1.2	3	5	8	1.8
9:45-10:00		2	3	5	1.8	2	0	2	1.2	4	3	7	1.5
1時間計		7	8	15	5.3	8	2	10	5.8	15	10	25	5.5
10:00-10:15		0	2	2	0.7	0	0	0	0.0	0	2	2	0.4
10:15-10:30		0	7	7	2.5	0	0	0	0.0	0	7	7	1.5
10:30-10:45		1	4	5	1.8	0	1	1	0.6	1	5	6	1.3
10:45-11:00		1	3	4	1.4	1	1	2	1.2	2	4	6	1.3
1時間計		2	16	18	6.4	1	2	3	1.7	3	18	21	4.6
11:00-11:15		2	1	3	1.1	1	1	2	1.2	3	2	5	1.1
11:15-11:30		2	1	3	1.1	1	0	1	0.6	3	1	4	0.9
11:30-11:45		1	1	2	0.7	1	1	2	1.2	2	2	4	0.9
11:45-12:00		2	0	2	0.7	0	0	0	0.0	2	0	2	0.4
1時間計		7	3	10	3.5	3	2	5	2.9	10	5	15	3.3
12:00-12:15		0	2	2	0.7	0	1	1	0.6	0	3	3	0.7
12:15-12:30		2	2	4	1.4	0	0	0	0.0	2	2	4	0.9
12:30-12:45		1	0	1	0.4	1	0	1	0.6	2	0	2	0.4
12:45-13:00		2	2	4	1.4	0	0	0	0.0	2	2	4	0.9
1時間計		5	6	11	3.9	1	1	2	1.2	6	7	13	2.9
13:00-13:15		0	5	5	1.8	0	0	0	0.0	0	5	5	1.1
13:15-13:30		0	11	11	3.9	0	1	1	0.6	0	12	12	2.6
13:30-13:45		1	13	14	4.9	0	1	1	0.6	1	14	15	3.3
13:45-14:00		1	2	3	1.1	0	0	0	0.0	1	2	3	0.7
1時間計		2	31	33	11.7	0	2	2	1.2	2	33	35	7.7
14:00-14:15		1	0	1	0.4	2	1	3	1.7	3	1	4	0.9
14:15-14:30		2	0	2	0.7	1	0	1	0.6	3	0	3	0.7
14:30-14:45		0	0	0	0.0	0	0	0	0.0	0	0	0	0.0
14:45-15:00		2	2	4	1.4	0	0	0	0.0	2	2	4	0.9
1時間計		5	2	7	2.5	3	1	4	2.3	8	3	11	2.4

歩行者通行量調査表

調査地点 地域社会4 滝沢

調査年月日 令和 2年 9月29日(火) 天候 曇りのち晴れ



方向	ウ				エ				合計				
	種別	歩行者 (人)	自転車 (台)	合計 (人・台)	時間 係数 (%)	歩行者 (人)	自転車 (台)	合計 (人・台)	時間 係数 (%)	歩行者 (人)	自転車 (台)	合計 (人・台)	時間 係数 (%)
時間帯													
15.00-15:15		0	2	2	0.7	1	1	2	1.2	1	3	4	0.9
15.15-15:30		3	1	4	1.4	1	0	1	0.6	4	1	5	1.1
15.30-15:45		0	0	0	0.0	1	2	3	1.7	1	2	3	0.7
15.45-16:00		0	14	14	4.9	1	2	3	1.7	1	16	17	3.7
1時間計		3	17	20	7.1	4	5	9	5.2	7	22	29	6.4
16.00-16:15		1	7	8	2.8	1	6	7	4.1	2	13	15	3.3
16.15-16:30		1	0	1	0.4	2	2	4	2.3	3	2	5	1.1
16.30-16:45		2	1	3	1.1	3	4	7	4.1	5	5	10	2.2
16.45-17:00		1	3	4	1.4	0	2	2	1.2	1	5	6	1.3
1時間計		5	11	16	5.7	6	14	20	11.6	11	25	36	7.9
17.00-17:15		1	0	1	0.4	0	1	1	0.6	1	1	2	0.4
17.15-17:30		1	2	3	1.1	2	1	3	1.7	3	3	6	1.3
17.30-17:45		1	5	6	2.1	3	3	6	3.5	4	8	12	2.6
17.45-18:00		0	4	4	1.4	1	2	3	1.7	1	6	7	1.5
1時間計		3	11	14	4.9	6	7	13	7.6	9	18	27	5.9
18.00-18:15		2	3	5	1.8	4	0	4	2.3	6	3	9	2.0
18.15-18:30		1	5	6	2.1	0	3	3	1.7	1	8	9	2.0
18.30-18:45		0	3	3	1.1	1	1	2	1.2	1	4	5	1.1
18.45-19:00		1	6	7	2.5	3	1	4	2.3	4	7	11	2.4
1時間計		4	17	21	7.4	8	5	13	7.6	12	22	34	7.5
昼12時間計		72	172	244	86.2	47	79	126	73.3	119	251	370	81.3
19.00-19:15		0	4	4	1.4	2	4	6	3.5	2	8	10	2.2
19.15-19:30		1	5	6	2.1	0	2	2	1.2	1	7	8	1.8
19.30-19:45		0	0	0	0.0	1	3	4	2.3	1	3	4	0.9
19.45-20:00		2	1	3	1.1	2	3	5	2.9	4	4	8	1.8
1時間計		3	10	13	4.6	5	12	17	9.9	8	22	30	6.6
20.00-20:15		0	1	1	0.4	1	0	1	0.6	1	1	2	0.4
20.15-20:30		0	0	0	0.0	1	2	3	1.7	1	2	3	0.7
20.30-20:45		0	0	0	0.0	0	2	2	1.2	0	2	2	0.4
20.45-21:00		0	2	2	0.7	0	2	2	1.2	0	4	4	0.9
1時間計		0	3	3	1.1	2	6	8	4.7	2	9	11	2.4
21.00-21:15		0	0	0	0.0	1	0	1	0.6	1	0	1	0.2
21.15-21:30		0	1	1	0.4	0	1	1	0.6	0	2	2	0.4
21.30-21:45		0	0	0	0.0	0	2	2	1.2	0	2	2	0.4
21.45-22:00		0	2	2	0.7	0	3	3	1.7	0	5	5	1.1
1時間計		0	3	3	1.1	1	6	7	4.1	1	9	10	2.2
22.00-22:15		0	3	3	1.1	0	0	0	0.0	0	3	3	0.7
22.15-22:30		0	1	1	0.4	1	2	3	1.7	1	3	4	0.9
22.30-22:45		0	1	1	0.4	0	0	0	0.0	0	1	1	0.2
22.45-23:00		0	0	0	0.0	0	1	1	0.6	0	1	1	0.2
1時間計		0	5	5	1.8	1	3	4	2.3	1	8	9	2.0

歩行者通行量調査表

調査地点 地域社会4 滝沢

調査年月日 令和 2年 9月29日(火) 天候 曇りのち晴れ



方向	ウ				エ				合計				
	種別	歩行者 (人)	自転車 (台)	合計 (人・台)	時間 係数 (%)	歩行者 (人)	自転車 (台)	合計 (人・台)	時間 係数 (%)	歩行者 (人)	自転車 (台)	合計 (人・台)	時間 係数 (%)
時間帯													
23:00-23:15		0	0	0	0.0	0	0	0	0.0	0	0	0	0.0
23:15-23:30		0	1	1	0.4	0	0	0	0.0	0	1	1	0.2
23:30-23:45		0	0	0	0.0	1	0	1	0.6	1	0	1	0.2
23:45-24:00		0	1	1	0.4	0	0	0	0.0	0	1	1	0.2
1時間計		0	2	2	0.7	1	0	1	0.6	1	2	3	0.7
0:00-0:15		0	0	0	0.0	0	0	0	0.0	0	0	0	0.0
0:15-0:30		0	0	0	0.0	0	0	0	0.0	0	0	0	0.0
0:30-0:45		0	0	0	0.0	0	0	0	0.0	0	0	0	0.0
0:45-1:00		0	0	0	0.0	0	0	0	0.0	0	0	0	0.0
1時間計		0	0	0	0.0	0	0	0	0.0	0	0	0	0.0
1:00-1:15		1	0	1	0.4	0	0	0	0.0	1	0	1	0.2
1:15-1:30		0	0	0	0.0	0	0	0	0.0	0	0	0	0.0
1:30-1:45		0	0	0	0.0	0	0	0	0.0	0	0	0	0.0
1:45-2:00		0	0	0	0.0	0	0	0	0.0	0	0	0	0.0
1時間計		1	0	1	0.4	0	0	0	0.0	1	0	1	0.2
2:00-2:15		0	0	0	0.0	0	0	0	0.0	0	0	0	0.0
2:15-2:30		0	0	0	0.0	0	0	0	0.0	0	0	0	0.0
2:30-2:45		0	0	0	0.0	0	0	0	0.0	0	0	0	0.0
2:45-3:00		0	0	0	0.0	0	0	0	0.0	0	0	0	0.0
1時間計		0	0	0	0.0	0	0	0	0.0	0	0	0	0.0
3:00-3:15		0	1	1	0.4	0	0	0	0.0	0	1	1	0.2
3:15-3:30		0	0	0	0.0	0	0	0	0.0	0	0	0	0.0
3:30-3:45		0	0	0	0.0	0	0	0	0.0	0	0	0	0.0
3:45-4:00		0	0	0	0.0	0	0	0	0.0	0	0	0	0.0
1時間計		0	1	1	0.4	0	0	0	0.0	0	1	1	0.2
4:00-4:15		0	0	0	0.0	0	0	0	0.0	0	0	0	0.0
4:15-4:30		0	0	0	0.0	0	0	0	0.0	0	0	0	0.0
4:30-4:45		0	0	0	0.0	1	0	1	0.6	1	0	1	0.2
4:45-5:00		0	1	1	0.4	1	0	1	0.6	1	1	2	0.4
1時間計		0	1	1	0.4	2	0	2	1.2	2	1	3	0.7
5:00-5:15		1	0	1	0.4	0	0	0	0.0	1	0	1	0.2
5:15-5:30		0	0	0	0.0	0	1	1	0.6	0	1	1	0.2
5:30-5:45		2	0	2	0.7	0	0	0	0.0	2	0	2	0.4
5:45-6:00		0	0	0	0.0	0	0	0	0.0	0	0	0	0.0
1時間計		3	0	3	1.1	0	1	1	0.6	3	1	4	0.9
6:00-6:15		0	1	1	0.4	0	0	0	0.0	0	1	1	0.2
6:15-6:30		1	1	2	0.7	0	0	0	0.0	1	1	2	0.4
6:30-6:45		0	2	2	0.7	1	2	3	1.7	1	4	5	1.1
6:45-7:00		0	2	2	0.7	2	1	3	1.7	2	3	5	1.1
1時間計		1	6	7	2.5	3	3	6	3.5	4	9	13	2.9
夜12時間計		8	31	39	13.8	15	31	46	26.7	23	62	85	18.7
全時間合計		80	203	283	100.0	62	110	172	100.0	142	313	455	100.0
昼夜平均		1.11	1.18	1.16	-	1.32	1.39	1.37	-	1.19	1.25	1.23	-

歩行者通行量調査表

調査地点：地域社会4 滝沢

調査年月日：令和 2年 9月29日(火) 天候 曇りのち晴れ



時間帯	種別	合計 (7+(+)+1)			時間係数 (%)
		歩行者 (人)	自転車 (台)	合計 (人・台)	
7:00-7:15		3	4	7	1.5
7:15-7:30		2	6	8	1.7
7:30-7:45		10	4	14	2.9
7:45-8:00		1	5	6	1.3
1時間計		16	19	35	7.3
8:00-8:15		3	6	9	1.9
8:15-8:30		12	17	29	6.1
8:30-8:45		6	22	28	5.8
8:45-9:00		1	26	27	5.6
1時間計		22	71	93	19.4
9:00-9:15		6	1	7	1.5
9:15-9:30		2	2	4	0.8
9:30-9:45		3	5	8	1.7
9:45-10:00		4	3	7	1.5
1時間計		15	11	26	5.4
10:00-10:15		0	3	3	0.6
10:15-10:30		0	7	7	1.5
10:30-10:45		1	5	6	1.3
10:45-11:00		2	4	6	1.3
1時間計		3	19	22	4.6
11:00-11:15		3	2	5	1.0
11:15-11:30		3	1	4	0.8
11:30-11:45		3	2	5	1.0
11:45-12:00		2	0	2	0.4
1時間計		11	5	16	3.3
12:00-12:15		0	3	3	0.6
12:15-12:30		2	2	4	0.8
12:30-12:45		2	0	2	0.4
12:45-13:00		2	2	4	0.8
1時間計		6	7	13	2.7
13:00-13:15		0	6	6	1.3
13:15-13:30		0	12	12	2.5
13:30-13:45		1	14	15	3.1
13:45-14:00		4	2	6	1.3
1時間計		5	34	39	8.1
14:00-14:15		5	1	6	1.3
14:15-14:30		3	0	3	0.6
14:30-14:45		3	0	3	0.6
14:45-15:00		2	2	4	0.8
1時間計		13	3	16	3.3
15:00-15:15		1	3	4	0.8
15:15-15:30		4	1	5	1.0
15:30-15:45		1	2	3	0.6
15:45-16:00		1	16	17	3.5
1時間計		7	22	29	6.1
16:00-16:15		2	13	15	3.1
16:15-16:30		4	2	6	1.3
16:30-16:45		5	5	10	2.1
16:45-17:00		1	5	6	1.3
1時間計		12	25	37	7.7
17:00-17:15		1	1	2	0.4
17:15-17:30		3	3	6	1.3
17:30-17:45		7	8	15	3.1
17:45-18:00		2	6	8	1.7
1時間計		13	18	31	6.5
18:00-18:15		7	3	10	2.1
18:15-18:30		1	8	9	1.9
18:30-18:45		1	4	5	1.0
18:45-19:00		4	8	12	2.5
1時間計		13	23	36	7.5
昼12時間計		136	257	393	82.0

時間帯	種別	合計 (7+(+)+1)			時間係数 (%)
		歩行者 (人)	自転車 (台)	合計 (人・台)	
7:00-8:00		16	19	35	7.3
7:15-8:15		16	21	37	7.7
7:30-8:30		26	32	58	12.1
7:45-8:45		22	50	72	15.0
8:00-9:00		22	71	93	19.4
8:15-9:15		25	66	91	19.0
8:30-9:30		15	51	66	13.8
8:45-9:45		12	34	46	9.6
9:00-10:00		15	11	26	5.4
9:15-10:15		9	13	22	4.6
9:30-10:30		7	18	25	5.2
9:45-10:45		5	18	23	4.8
10:00-11:00		3	19	22	4.6
10:15-11:15		6	18	24	5.0
10:30-11:30		9	12	21	4.4
10:45-11:45		11	9	20	4.2
11:00-12:00		11	5	16	3.3
11:15-12:15		8	6	14	2.9
11:30-12:30		7	7	14	2.9
11:45-12:45		6	5	11	2.3
12:00-13:00		6	7	13	2.7
12:15-13:15		6	10	16	3.3
12:30-13:30		4	20	24	5.0
12:45-13:45		3	34	37	7.7
13:00-14:00		5	34	39	8.1
13:15-14:15		10	29	39	8.1
13:30-14:30		13	17	30	6.3
13:45-14:45		15	3	18	3.8
14:00-15:00		13	3	16	3.3
14:15-15:15		9	5	14	2.9
14:30-15:30		10	6	16	3.3
14:45-15:45		8	8	16	3.3
15:00-16:00		7	22	29	6.1
15:15-16:15		8	32	40	8.4
15:30-16:30		8	33	41	8.6
15:45-16:45		12	36	48	10.0
16:00-17:00		12	25	37	7.7
16:15-17:15		11	13	24	5.0
16:30-17:30		10	14	24	5.0
16:45-17:45		12	17	29	6.1
17:00-18:00		13	18	31	6.5
17:15-18:15		19	20	39	8.1
17:30-18:30		17	25	42	8.8
17:45-18:45		11	21	32	6.7
18:00-19:00		13	23	36	7.5
18:15-19:15		8	28	36	7.5
18:30-19:30		8	27	35	7.3
18:45-19:45		8	26	34	7.1
19:00-20:00		8	22	30	6.3
19:15-20:15		7	15	22	4.6
19:30-20:30		7	11	18	3.8
19:45-20:45		6	10	16	3.3
20:00-21:00		2	10	12	2.5
20:15-21:15		2	9	11	2.3
20:30-21:30		1	8	9	1.9
20:45-21:45		1	8	9	1.9
21:00-22:00		1	9	10	2.1
21:15-22:15		0	12	12	2.5
21:30-22:30		1	13	14	2.9
21:45-22:45		1	12	13	2.7
22:00-23:00		1	8	9	1.9

歩行者通行量調査表

調査地点：地域社会4 滝沢

調査年月日：令和 2年 9月29日(火) 天候：曇りのち晴れ



時間帯	種別	合計 (7+4+0+1)			時間係数 (%)
		歩行者 (人)	自転車 (台)	合計 (人・台)	
19:00-19:15		2	8	10	2.1
19:15-19:30		1	7	8	1.7
19:30-19:45		1	3	4	0.8
19:45-20:00		4	4	8	1.7
1時間計		8	22	30	6.3
20:00-20:15		1	1	2	0.4
20:15-20:30		1	3	4	0.8
20:30-20:45		0	2	2	0.4
20:45-21:00		0	4	4	0.8
1時間計		2	10	12	2.5
21:00-21:15		1	0	1	0.2
21:15-21:30		0	2	2	0.4
21:30-21:45		0	2	2	0.4
21:45-22:00		0	5	5	1.0
1時間計		1	9	10	2.1
22:00-22:15		0	3	3	0.6
22:15-22:30		1	3	4	0.8
22:30-22:45		0	1	1	0.2
22:45-23:00		0	1	1	0.2
1時間計		1	8	9	1.9
23:00-23:15		0	0	0	0.0
23:15-23:30		0	1	1	0.2
23:30-23:45		1	0	1	0.2
23:45-24:00		0	1	1	0.2
1時間計		1	2	3	0.6
0:00-0:15		0	0	0	0.0
0:15-0:30		0	0	0	0.0
0:30-0:45		0	0	0	0.0
0:45-1:00		0	0	0	0.0
1時間計		0	0	0	0.0
1:00-1:15		1	0	1	0.2
1:15-1:30		0	0	0	0.0
1:30-1:45		0	0	0	0.0
1:45-2:00		0	0	0	0.0
1時間計		1	0	1	0.2
2:00-2:15		0	0	0	0.0
2:15-2:30		0	0	0	0.0
2:30-2:45		0	0	0	0.0
2:45-3:00		0	0	0	0.0
1時間計		0	0	0	0.0
3:00-3:15		0	1	1	0.2
3:15-3:30		0	0	0	0.0
3:30-3:45		0	0	0	0.0
3:45-4:00		0	0	0	0.0
1時間計		0	1	1	0.2
4:00-4:15		0	0	0	0.0
4:15-4:30		0	0	0	0.0
4:30-4:45		1	0	1	0.2
4:45-5:00		1	1	2	0.4
1時間計		2	1	3	0.6
5:00-5:15		1	0	1	0.2
5:15-5:30		0	1	1	0.2
5:30-5:45		2	0	2	0.4
5:45-6:00		0	0	0	0.0
1時間計		3	1	4	0.8
6:00-6:15		0	1	1	0.2
6:15-6:30		1	1	2	0.4
6:30-6:45		1	4	5	1.0
6:45-7:00		2	3	5	1.0
1時間計		4	9	13	2.7
夜12時間計		23	63	86	18.0
全時間合計		159	320	479	100.0
昼夜率		1.17	1.25	1.22	-

時間帯	種別	合計 (7+4+0+1)			時間係数 (%)
		歩行者 (人)	自転車 (台)	合計 (人・台)	
22:15-23:15		1	5	6	1.3
22:30-23:30		0	3	3	0.6
22:45-23:45		1	2	3	0.6
23:00-0:00		1	2	3	0.6
23:15-0:15		1	2	3	0.6
23:30-0:30		1	1	2	0.4
23:45-0:45		0	1	1	0.2
0:00-1:00		0	0	0	0.0
0:15-1:15		1	0	1	0.2
0:30-1:30		1	0	1	0.2
0:45-1:45		1	0	1	0.2
1:00-2:00		1	0	1	0.2
1:15-2:15		0	0	0	0.0
1:30-2:30		0	0	0	0.0
1:45-2:45		0	0	0	0.0
2:00-3:00		0	0	0	0.0
2:15-3:15		0	1	1	0.2
2:30-3:30		0	1	1	0.2
2:45-3:45		0	1	1	0.2
3:00-4:00		0	1	1	0.2
3:15-4:15		0	0	0	0.0
3:30-4:30		0	0	0	0.0
3:45-4:45		1	0	1	0.2
4:00-5:00		2	1	3	0.6
4:15-5:15		3	1	4	0.8
4:30-5:30		3	2	5	1.0
4:45-5:45		4	2	6	1.3
5:00-6:00		3	1	4	0.8
5:15-6:15		2	2	4	0.8
5:30-6:30		3	2	5	1.0
5:45-6:45		2	6	8	1.7
6:00-7:00		4	9	13	2.7
全時間合計		159	320	479	100.0

歩行者通行量調査表

調査地点 地域社会4 瀬谷土橋公園入口

調査年月日 令和 2年 9月29日(火) 天候 曇りのち晴れ



時間帯	種別	方向 7				方向 1				合計			
		歩行者 (人)	自転車 (台)	合計 (人・台)	時間 係数 (%)	歩行者 (人)	自転車 (台)	合計 (人・台)	時間 係数 (%)	歩行者 (人)	自転車 (台)	合計 (人・台)	時間 係数 (%)
7:00-7:15		0	0	0	0.0	0	0	0	0.0	0	0	0	0.0
7:15-7:30		0	1	1	2.9	0	0	0	0.0	0	1	1	1.6
7:30-7:45		0	1	1	2.9	0	0	0	0.0	0	1	1	1.6
7:45-8:00		0	1	1	2.9	0	0	0	0.0	0	1	1	1.6
1時間計		0	3	3	8.6	0	0	0	0.0	0	3	3	4.8
8:00-8:15		0	0	0	0.0	0	2	2	7.4	0	2	2	3.2
8:15-8:30		0	1	1	2.9	0	0	0	0.0	0	1	1	1.6
8:30-8:45		0	3	3	8.6	0	0	0	0.0	0	3	3	4.8
8:45-9:00		0	0	0	0.0	0	0	0	0.0	0	0	0	0.0
1時間計		0	4	4	11.4	0	2	2	7.4	0	6	6	9.7
9:00-9:15		0	0	0	0.0	0	0	0	0.0	0	0	0	0.0
9:15-9:30		0	0	0	0.0	0	0	0	0.0	0	0	0	0.0
9:30-9:45		0	0	0	0.0	0	0	0	0.0	0	0	0	0.0
9:45-10:00		0	0	0	0.0	0	0	0	0.0	0	0	0	0.0
1時間計		0	0	0	0.0	0	0	0	0.0	0	0	0	0.0
10:00-10:15		0	0	0	0.0	0	0	0	0.0	0	0	0	0.0
10:15-10:30		0	0	0	0.0	0	0	0	0.0	0	0	0	0.0
10:30-10:45		0	0	0	0.0	0	0	0	0.0	0	0	0	0.0
10:45-11:00		0	0	0	0.0	0	0	0	0.0	0	0	0	0.0
1時間計		0	0	0	0.0	0	0	0	0.0	0	0	0	0.0
11:00-11:15		1	1	2	5.7	1	0	1	3.7	2	1	3	4.8
11:15-11:30		0	0	0	0.0	0	0	0	0.0	0	0	0	0.0
11:30-11:45		0	1	1	2.9	0	0	0	0.0	0	1	1	1.6
11:45-12:00		1	0	1	2.9	1	0	1	3.7	2	0	2	3.2
1時間計		2	2	4	11.4	2	0	2	7.4	4	2	6	9.7
12:00-12:15		0	0	0	0.0	1	0	1	3.7	1	0	1	1.6
12:15-12:30		0	0	0	0.0	1	0	1	3.7	1	0	1	1.6
12:30-12:45		2	0	2	5.7	1	0	1	3.7	3	0	3	4.8
12:45-13:00		0	0	0	0.0	0	0	0	0.0	0	0	0	0.0
1時間計		2	0	2	5.7	3	0	3	11.1	5	0	5	8.1
13:00-13:15		0	0	0	0.0	0	0	0	0.0	0	0	0	0.0
13:15-13:30		2	0	2	5.7	1	1	2	7.4	3	1	4	6.5
13:30-13:45		0	1	1	2.9	0	1	1	3.7	0	2	2	3.2
13:45-14:00		0	0	0	0.0	0	0	0	0.0	0	0	0	0.0
1時間計		2	1	3	8.6	1	2	3	11.1	3	3	6	9.7
14:00-14:15		0	0	0	0.0	0	0	0	0.0	0	0	0	0.0
14:15-14:30		1	0	1	2.9	0	0	0	0.0	1	0	1	1.6
14:30-14:45		1	0	1	2.9	0	1	1	3.7	1	1	2	3.2
14:45-15:00		0	1	1	2.9	1	0	1	3.7	1	1	2	3.2
1時間計		2	1	3	8.6	1	1	2	7.4	3	2	5	8.1

歩行者通行量調査表

調査地点 地域社会4 瀬谷土橋公園入口

調査年月日 令和 2年 9月29日(火) 天候 曇りのち晴れ



方向	7				イ				合計			
	歩行者 (人)	自転車 (台)	合計 (人・台)	時間 係数 (%)	歩行者 (人)	自転車 (台)	合計 (人・台)	時間 係数 (%)	歩行者 (人)	自転車 (台)	合計 (人・台)	時間 係数 (%)
時間帯												
15:00-15:15	0	0	0	0.0	0	0	0	0.0	0	0	0	0.0
15:15-15:30	0	0	0	0.0	0	0	0	0.0	0	0	0	0.0
15:30-15:45	0	1	1	2.9	0	0	0	0.0	0	1	1	1.6
15:45-16:00	0	0	0	0.0	0	0	0	0.0	0	0	0	0.0
1時間計	0	1	1	2.9	0	0	0	0.0	0	1	1	1.6
16:00-16:15	1	0	1	2.9	0	1	1	3.7	1	1	2	3.2
16:15-16:30	0	0	0	0.0	0	0	0	0.0	0	0	0	0.0
16:30-16:45	0	0	0	0.0	0	0	0	0.0	0	0	0	0.0
16:45-17:00	0	0	0	0.0	0	0	0	0.0	0	0	0	0.0
1時間計	1	0	1	2.9	0	1	1	3.7	1	1	2	3.2
17:00-17:15	1	0	1	2.9	1	0	1	3.7	2	0	2	3.2
17:15-17:30	0	1	1	2.9	1	2	3	11.1	1	3	4	6.5
17:30-17:45	1	0	1	2.9	2	0	2	7.4	3	0	3	4.8
17:45-18:00	1	0	1	2.9	0	0	0	0.0	1	0	1	1.6
1時間計	3	1	4	11.4	4	2	6	22.2	7	3	10	16.1
18:00-18:15	0	1	1	2.9	0	0	0	0.0	0	1	1	1.6
18:15-18:30	0	0	0	0.0	0	0	0	0.0	0	0	0	0.0
18:30-18:45	0	1	1	2.9	0	0	0	0.0	0	1	1	1.6
18:45-19:00	1	0	1	2.9	0	0	0	0.0	1	0	1	1.6
1時間計	1	2	3	8.6	0	0	0	0.0	1	2	3	4.8
昼12時間計	13	15	28	80.0	11	8	19	70.4	24	23	47	75.8
19:00-19:15	0	0	0	0.0	0	0	0	0.0	0	0	0	0.0
19:15-19:30	0	0	0	0.0	0	0	0	0.0	0	0	0	0.0
19:30-19:45	1	0	1	2.9	1	0	1	3.7	2	0	2	3.2
19:45-20:00	0	0	0	0.0	0	0	0	0.0	0	0	0	0.0
1時間計	1	0	1	2.9	1	0	1	3.7	2	0	2	3.2
20:00-20:15	0	0	0	0.0	0	0	0	0.0	0	0	0	0.0
20:15-20:30	0	0	0	0.0	0	0	0	0.0	0	0	0	0.0
20:30-20:45	0	0	0	0.0	0	0	0	0.0	0	0	0	0.0
20:45-21:00	0	0	0	0.0	0	0	0	0.0	0	0	0	0.0
1時間計	0	0	0	0.0	0	0	0	0.0	0	0	0	0.0
21:00-21:15	1	0	1	2.9	0	0	0	0.0	1	0	1	1.6
21:15-21:30	0	0	0	0.0	0	0	0	0.0	0	0	0	0.0
21:30-21:45	0	0	0	0.0	0	1	1	3.7	0	1	1	1.6
21:45-22:00	0	0	0	0.0	0	0	0	0.0	0	0	0	0.0
1時間計	1	0	1	2.9	0	1	1	3.7	1	1	2	3.2
22:00-22:15	0	0	0	0.0	0	0	0	0.0	0	0	0	0.0
22:15-22:30	0	0	0	0.0	0	0	0	0.0	0	0	0	0.0
22:30-22:45	0	0	0	0.0	0	0	0	0.0	0	0	0	0.0
22:45-23:00	0	0	0	0.0	0	0	0	0.0	0	0	0	0.0
1時間計	0	0	0	0.0	0	0	0	0.0	0	0	0	0.0

歩行者通行量調査表

調査地点 地域社会4 瀬谷土橋公園入口

調査年月日 令和 2年 9月29日(火) 天候 曇りのち晴れ



時間帯	方向 7				方向 イ				合計			
	歩行者 (人)	自転車 (台)	合計 (人・台)	時間 係数 (%)	歩行者 (人)	自転車 (台)	合計 (人・台)	時間 係数 (%)	歩行者 (人)	自転車 (台)	合計 (人・台)	時間 係数 (%)
23:00-23:15	0	0	0	0.0	1	1	2	7.4	1	1	2	3.2
23:15-23:30	0	0	0	0.0	1	0	1	3.7	1	0	1	1.6
23:30-23:45	0	0	0	0.0	0	0	0	0.0	0	0	0	0.0
23:45-24:00	0	0	0	0.0	0	0	0	0.0	0	0	0	0.0
1時間計	0	0	0	0.0	2	1	3	11.1	2	1	3	4.8
0:00-0:15	0	0	0	0.0	0	0	0	0.0	0	0	0	0.0
0:15-0:30	0	0	0	0.0	0	0	0	0.0	0	0	0	0.0
0:30-0:45	0	0	0	0.0	0	0	0	0.0	0	0	0	0.0
0:45-1:00	1	0	1	2.9	0	0	0	0.0	1	0	1	1.6
1時間計	1	0	1	2.9	0	0	0	0.0	1	0	1	1.6
1:00-1:15	0	0	0	0.0	0	0	0	0.0	0	0	0	0.0
1:15-1:30	0	0	0	0.0	0	0	0	0.0	0	0	0	0.0
1:30-1:45	0	0	0	0.0	0	0	0	0.0	0	0	0	0.0
1:45-2:00	0	0	0	0.0	0	0	0	0.0	0	0	0	0.0
1時間計	0	0	0	0.0	0	0	0	0.0	0	0	0	0.0
2:00-2:15	0	0	0	0.0	0	0	0	0.0	0	0	0	0.0
2:15-2:30	0	0	0	0.0	0	0	0	0.0	0	0	0	0.0
2:30-2:45	0	0	0	0.0	0	0	0	0.0	0	0	0	0.0
2:45-3:00	0	0	0	0.0	0	0	0	0.0	0	0	0	0.0
1時間計	0	0	0	0.0	0	0	0	0.0	0	0	0	0.0
3:00-3:15	0	0	0	0.0	0	0	0	0.0	0	0	0	0.0
3:15-3:30	0	0	0	0.0	0	0	0	0.0	0	0	0	0.0
3:30-3:45	0	0	0	0.0	0	0	0	0.0	0	0	0	0.0
3:45-4:00	0	0	0	0.0	0	0	0	0.0	0	0	0	0.0
1時間計	0	0	0	0.0	0	0	0	0.0	0	0	0	0.0
4:00-4:15	0	0	0	0.0	0	0	0	0.0	0	0	0	0.0
4:15-4:30	0	0	0	0.0	0	0	0	0.0	0	0	0	0.0
4:30-4:45	0	0	0	0.0	0	0	0	0.0	0	0	0	0.0
4:45-5:00	0	0	0	0.0	0	0	0	0.0	0	0	0	0.0
1時間計	0	0	0	0.0	0	0	0	0.0	0	0	0	0.0
5:00-5:15	1	0	1	2.9	0	0	0	0.0	1	0	1	1.6
5:15-5:30	0	0	0	0.0	0	0	0	0.0	0	0	0	0.0
5:30-5:45	1	0	1	2.9	0	0	0	0.0	1	0	1	1.6
5:45-6:00	1	0	1	2.9	1	0	1	3.7	2	0	2	3.2
1時間計	3	0	3	8.6	1	0	1	3.7	4	0	4	6.5
6:00-6:15	1	0	1	2.9	1	0	1	3.7	2	0	2	3.2
6:15-6:30	0	0	0	0.0	1	0	1	3.7	1	0	1	1.6
6:30-6:45	0	0	0	0.0	0	0	0	0.0	0	0	0	0.0
6:45-7:00	0	0	0	0.0	0	0	0	0.0	0	0	0	0.0
1時間計	1	0	1	2.9	2	0	2	7.4	3	0	3	4.8
夜12時間計	7	0	7	20.0	6	2	8	29.6	13	2	15	24.2
全時間合計	20	18	35	100.0	17	10	27	100.0	37	25	62	100.0
昼夜平均	1.54	1.00	1.25	-	1.55	1.25	1.42	-	1.54	1.09	1.32	-

歩行者通行量調査表

調査地点 地域社会4 瀬谷土橋公園入口

調査年月日 令和 2年 9月29日(火) 天候 曇りのち晴れ



方向	ウ				エ				合計				
	種別	歩行者 (人)	自転車 (台)	合計 (人・台)	時間 係数 (%)	歩行者 (人)	自転車 (台)	合計 (人・台)	時間 係数 (%)	歩行者 (人)	自転車 (台)	合計 (人・台)	時間 係数 (%)
7:00-7:15	時間帯	0	1	1	0.4	1	0	1	0.7	1	1	2	0.5
7:15-7:30		0	4	4	1.5	0	1	1	0.7	0	5	5	1.2
7:30-7:45		1	3	4	1.5	0	0	0	0.0	1	3	4	1.0
7:45-8:00		2	4	6	2.3	0	2	2	1.4	2	6	8	2.0
1時間計		3	12	15	5.7	1	3	4	2.9	4	15	19	4.7
8:00-8:15		0	5	5	1.9	3	2	5	3.6	3	7	10	2.6
8:15-8:30		7	14	21	8.0	0	3	3	2.2	7	17	24	6.0
8:30-8:45		6	9	15	5.7	3	15	18	13.0	9	24	33	8.2
8:45-9:00		4	3	7	2.7	1	14	15	10.9	5	17	22	5.5
1時間計		17	31	48	18.3	7	34	41	29.7	24	65	89	22.2
9:00-9:15		0	0	0	0.0	1	1	2	1.4	1	1	2	0.5
9:15-9:30		2	0	2	0.8	2	0	2	1.4	4	0	4	1.0
9:30-9:45		3	6	9	3.4	1	2	3	2.2	4	8	12	3.0
9:45-10:00		1	0	1	0.4	0	0	0	0.0	1	0	1	0.2
1時間計		6	6	12	4.6	4	3	7	5.1	10	9	19	4.7
10:00-10:15		0	2	2	0.8	0	0	0	0.0	0	2	2	0.5
10:15-10:30		0	6	6	2.3	1	0	1	0.7	1	6	7	1.7
10:30-10:45		1	4	5	1.9	0	1	1	0.7	1	5	6	1.5
10:45-11:00		1	2	3	1.1	0	1	1	0.7	1	3	4	1.0
1時間計		2	14	16	6.1	1	2	3	2.2	3	16	19	4.7
11:00-11:15		3	0	3	1.1	1	0	1	0.7	4	0	4	1.0
11:15-11:30		1	2	3	1.1	1	0	1	0.7	2	2	4	1.0
11:30-11:45		0	1	1	0.4	0	2	2	1.4	0	3	3	0.7
11:45-12:00		3	0	3	1.1	1	0	1	0.7	4	0	4	1.0
1時間計		7	3	10	3.8	3	2	5	3.6	10	5	15	3.7
12:00-12:15		0	1	1	0.4	0	0	0	0.0	0	1	1	0.2
12:15-12:30		0	2	2	0.8	0	0	0	0.0	0	2	2	0.5
12:30-12:45		1	2	3	1.1	1	0	1	0.7	2	2	4	1.0
12:45-13:00		1	4	5	1.9	0	0	0	0.0	1	4	5	1.2
1時間計		2	9	11	4.2	1	0	1	0.7	3	9	12	3.0
13:00-13:15		0	4	4	1.5	0	0	0	0.0	0	4	4	1.0
13:15-13:30		1	13	14	5.3	2	1	3	2.2	3	14	17	4.2
13:30-13:45		0	5	5	1.9	0	0	0	0.0	0	5	5	1.2
13:45-14:00		1	1	2	0.8	1	0	1	0.7	2	1	3	0.7
1時間計		2	23	25	9.5	3	1	4	2.9	5	24	29	7.2
14:00-14:15		0	3	3	1.1	3	0	3	2.2	3	3	6	1.5
14:15-14:30		1	0	1	0.4	0	0	0	0.0	1	0	1	0.2
14:30-14:45		1	0	1	0.4	0	0	0	0.0	1	0	1	0.2
14:45-15:00		2	2	4	1.5	2	0	2	1.4	4	2	6	1.5
1時間計		4	5	9	3.4	5	0	5	3.6	9	5	14	3.5

歩行者通行量調査表

調査地点 地域社会4 瀬谷土橋公園入口

調査年月日 令和 2年 9月29日(火) 天候 曇りのち晴れ



方向	ウ				エ				合計			
	歩行者 (人)	自転車 (台)	合計 (人・台)	時間 係数 (%)	歩行者 (人)	自転車 (台)	合計 (人・台)	時間 係数 (%)	歩行者 (人)	自転車 (台)	合計 (人・台)	時間 係数 (%)
時間帯												
15:00-15:15	0	1	1	0.4	2	0	2	1.4	2	1	3	0.7
15:15-15:30	2	1	3	1.1	0	1	1	0.7	2	2	4	1.0
15:30-15:45	0	0	0	0.0	1	2	3	2.2	1	2	3	0.7
15:45-16:00	0	13	13	4.9	0	1	1	0.7	0	14	14	3.5
1時間計	2	15	17	6.5	3	4	7	5.1	5	19	24	6.0
16:00-16:15	0	6	6	2.3	0	6	6	4.3	0	12	12	3.0
16:15-16:30	0	0	0	0.0	0	2	2	1.4	0	2	2	0.5
16:30-16:45	1	1	2	0.8	1	3	4	2.9	2	4	6	1.5
16:45-17:00	0	4	4	1.5	1	0	1	0.7	1	4	5	1.2
1時間計	1	11	12	4.6	2	11	13	9.4	3	22	25	6.2
17:00-17:15	0	1	1	0.4	1	1	2	1.4	1	2	3	0.7
17:15-17:30	0	4	4	1.5	3	4	7	5.1	3	8	11	2.7
17:30-17:45	0	7	7	2.7	0	0	0	0.0	0	7	7	1.7
17:45-18:00	2	7	9	3.4	0	0	0	0.0	2	7	9	2.2
1時間計	2	19	21	8.0	4	5	9	6.5	6	24	30	7.5
18:00-18:15	1	2	3	1.1	0	0	0	0.0	1	2	3	0.7
18:15-18:30	1	3	4	1.5	0	1	1	0.7	1	4	5	1.2
18:30-18:45	0	7	7	2.7	0	1	1	0.7	0	8	8	2.0
18:45-19:00	0	4	4	1.5	0	1	1	0.7	0	5	5	1.2
1時間計	2	16	18	6.8	0	3	3	2.2	2	19	21	5.2
昼12時間計	50	164	214	81.4	34	68	102	73.9	84	232	316	78.8
19:00-19:15	0	3	3	1.1	2	1	3	2.2	2	4	6	1.5
19:15-19:30	1	6	7	2.7	0	1	1	0.7	1	7	8	2.0
19:30-19:45	0	2	2	0.8	1	1	2	1.4	1	3	4	1.0
19:45-20:00	0	0	0	0.0	0	0	0	0.0	0	0	0	0.0
1時間計	1	11	12	4.6	3	3	6	4.3	4	14	18	4.5
20:00-20:15	3	0	3	1.1	1	1	2	1.4	4	1	5	1.2
20:15-20:30	0	2	2	0.8	1	1	2	1.4	1	3	4	1.0
20:30-20:45	2	0	2	0.8	1	2	3	2.2	3	2	5	1.2
20:45-21:00	1	1	2	0.8	0	1	1	0.7	1	2	3	0.7
1時間計	6	3	9	3.4	3	5	8	5.8	9	8	17	4.2
21:00-21:15	0	0	0	0.0	0	0	0	0.0	0	0	0	0.0
21:15-21:30	0	0	0	0.0	0	0	0	0.0	0	0	0	0.0
21:30-21:45	5	0	5	1.9	3	1	4	2.9	8	1	9	2.2
21:45-22:00	0	1	1	0.4	0	2	2	1.4	0	3	3	0.7
1時間計	5	1	6	2.3	3	3	6	4.3	8	4	12	3.0
22:00-22:15	1	1	2	0.8	0	0	0	0.0	1	1	2	0.5
22:15-22:30	0	2	2	0.8	0	2	2	1.4	0	4	4	1.0
22:30-22:45	0	0	0	0.0	0	0	0	0.0	0	0	0	0.0
22:45-23:00	0	0	0	0.0	0	0	0	0.0	0	0	0	0.0
1時間計	1	3	4	1.5	0	2	2	1.4	1	5	6	1.5

歩行者通行量調査表

調査地点 地域社会4 瀬谷土橋公園入口

調査年月日 令和 2年 9月29日(火) 天候 曇りのち晴れ



方向	ウ				エ				合計				
	種別	歩行者 (人)	自転車 (台)	合計 (人・台)	時間 係数 (%)	歩行者 (人)	自転車 (台)	合計 (人・台)	時間 係数 (%)	歩行者 (人)	自転車 (台)	合計 (人・台)	時間 係数 (%)
時間帯													
23:00-23:15		1	0	1	0.4	1	2	3	2.2	2	2	4	1.0
23:15-23:30		0	0	0	0.0	0	0	0	0.0	0	0	0	0.0
23:30-23:45		0	0	0	0.0	0	0	0	0.0	0	0	0	0.0
23:45-24:00		0	1	1	0.4	0	0	0	0.0	0	1	1	0.2
1時間計		1	1	2	0.8	1	2	3	2.2	2	3	5	1.2
0:00-0:15		1	0	1	0.4	1	0	1	0.7	2	0	2	0.5
0:15-0:30		0	0	0	0.0	0	0	0	0.0	0	0	0	0.0
0:30-0:45		0	0	0	0.0	0	0	0	0.0	0	0	0	0.0
0:45-1:00		0	0	0	0.0	0	0	0	0.0	0	0	0	0.0
1時間計		1	0	1	0.4	1	0	1	0.7	2	0	2	0.5
1:00-1:15		1	0	1	0.4	0	0	0	0.0	1	0	1	0.2
1:15-1:30		0	0	0	0.0	0	0	0	0.0	0	0	0	0.0
1:30-1:45		0	0	0	0.0	0	0	0	0.0	0	0	0	0.0
1:45-2:00		0	0	0	0.0	0	0	0	0.0	0	0	0	0.0
1時間計		1	0	1	0.4	0	0	0	0.0	1	0	1	0.2
2:00-2:15		0	0	0	0.0	0	0	0	0.0	0	0	0	0.0
2:15-2:30		0	1	1	0.4	0	0	0	0.0	0	1	1	0.2
2:30-2:45		1	0	1	0.4	0	0	0	0.0	1	0	1	0.2
2:45-3:00		1	0	1	0.4	0	0	0	0.0	1	0	1	0.2
1時間計		2	1	3	1.1	0	0	0	0.0	2	1	3	0.7
3:00-3:15		0	0	0	0.0	1	0	1	0.7	1	0	1	0.2
3:15-3:30		0	1	1	0.4	0	0	0	0.0	0	1	1	0.2
3:30-3:45		0	0	0	0.0	0	0	0	0.0	0	0	0	0.0
3:45-4:00		0	0	0	0.0	0	0	0	0.0	0	0	0	0.0
1時間計		0	1	1	0.4	1	0	1	0.7	1	1	2	0.5
4:00-4:15		0	0	0	0.0	0	0	0	0.0	0	0	0	0.0
4:15-4:30		0	0	0	0.0	0	0	0	0.0	0	0	0	0.0
4:30-4:45		0	0	0	0.0	0	0	0	0.0	0	0	0	0.0
4:45-5:00		0	0	0	0.0	0	0	0	0.0	0	0	0	0.0
1時間計		0	0	0	0.0	0	0	0	0.0	0	0	0	0.0
5:00-5:15		0	3	3	1.1	0	0	0	0.0	0	3	3	0.7
5:15-5:30		0	0	0	0.0	0	0	0	0.0	0	0	0	0.0
5:30-5:45		3	0	3	1.1	0	0	0	0.0	3	0	3	0.7
5:45-6:00		0	0	0	0.0	0	0	0	0.0	0	0	0	0.0
1時間計		3	3	6	2.3	0	0	0	0.0	3	3	6	1.5
6:00-6:15		0	0	0	0.0	0	0	0	0.0	0	0	0	0.0
6:15-6:30		0	0	0	0.0	3	0	3	2.2	3	0	3	0.7
6:30-6:45		0	2	2	0.8	1	2	3	2.2	1	4	5	1.2
6:45-7:00		2	0	2	0.8	3	0	3	2.2	5	0	5	1.2
1時間計		2	2	4	1.5	7	2	9	6.5	9	4	13	3.2
夜12時間計		23	26	49	18.6	19	17	36	26.1	42	43	85	21.2
全時間合計		73	190	263	100.0	53	85	138	100.0	126	275	401	100.0
昼夜平均		1.46	1.16	1.23	-	1.56	1.25	1.35	-	1.50	1.19	1.27	-

歩行者通行量調査表

調査地点：地域社会4 瀬谷土橋公園入口

調査年月日：令和 2年 9月29日(火) 天候：曇りのち晴れ



時間帯	方向 種別	合計 (7+イ+ウ+1)			時 間 係 数 (%)
		歩行者 (人)	自転車 (台)	合 計 (人・台)	
7:00-7:15		1	1	2	0.4
7:15-7:30		0	6	6	1.3
7:30-7:45		1	4	5	1.1
7:45-8:00		2	7	9	1.9
1時間計		4	18	22	4.8
8:00-8:15		3	9	12	2.6
8:15-8:30		7	18	25	5.4
8:30-8:45		9	27	36	7.8
8:45-9:00		5	17	22	4.8
1時間計		24	71	95	20.5
9:00-9:15		1	1	2	0.4
9:15-9:30		4	0	4	0.9
9:30-9:45		4	8	12	2.6
9:45-10:00		1	0	1	0.2
1時間計		10	9	19	4.1
10:00-10:15		0	2	2	0.4
10:15-10:30		1	6	7	1.5
10:30-10:45		1	5	6	1.3
10:45-11:00		1	3	4	0.9
1時間計		3	16	19	4.1
11:00-11:15		6	1	7	1.5
11:15-11:30		2	2	4	0.9
11:30-11:45		0	4	4	0.9
11:45-12:00		6	0	6	1.3
1時間計		14	7	21	4.5
12:00-12:15		1	1	2	0.4
12:15-12:30		1	2	3	0.6
12:30-12:45		5	2	7	1.5
12:45-13:00		1	4	5	1.1
1時間計		8	9	17	3.7
13:00-13:15		0	4	4	0.9
13:15-13:30		6	15	21	4.5
13:30-13:45		0	7	7	1.5
13:45-14:00		2	1	3	0.6
1時間計		8	27	35	7.6
14:00-14:15		3	3	6	1.3
14:15-14:30		2	0	2	0.4
14:30-14:45		2	1	3	0.6
14:45-15:00		5	3	8	1.7
1時間計		12	7	19	4.1
15:00-15:15		2	1	3	0.6
15:15-15:30		2	2	4	0.9
15:30-15:45		1	3	4	0.9
15:45-16:00		0	14	14	3.0
1時間計		5	20	25	5.4
16:00-16:15		1	13	14	3.0
16:15-16:30		0	2	2	0.4
16:30-16:45		2	4	6	1.3
16:45-17:00		1	4	5	1.1
1時間計		4	23	27	5.8
17:00-17:15		3	2	5	1.1
17:15-17:30		4	11	15	3.2
17:30-17:45		3	7	10	2.2
17:45-18:00		3	7	10	2.2
1時間計		13	27	40	8.6
18:00-18:15		1	3	4	0.9
18:15-18:30		1	4	5	1.1
18:30-18:45		0	9	9	1.9
18:45-19:00		1	5	6	1.3
1時間計		3	21	24	5.2
昼12時間計		108	255	363	78.4

時間帯	方向 種別	合計 (7+イ+ウ+1)			時 間 係 数 (%)
		歩行者 (人)	自転車 (台)	合 計 (人・台)	
7:00-8:00		4	18	22	4.8
7:15-8:15		6	26	32	6.9
7:30-8:30		13	38	51	11.0
7:45-8:45		21	61	82	17.7
8:00-9:00		24	71	95	20.5
8:15-9:15		22	63	85	18.4
8:30-9:30		19	45	64	13.8
8:45-9:45		14	26	40	8.6
9:00-10:00		10	9	19	4.1
9:15-10:15		9	10	19	4.1
9:30-10:30		6	16	22	4.8
9:45-10:45		3	13	16	3.5
10:00-11:00		3	16	19	4.1
10:15-11:15		9	15	24	5.2
10:30-11:30		10	11	21	4.5
10:45-11:45		9	10	19	4.1
11:00-12:00		14	7	21	4.5
11:15-12:15		9	7	16	3.5
11:30-12:30		8	7	15	3.2
11:45-12:45		13	5	18	3.9
12:00-13:00		8	9	17	3.7
12:15-13:15		7	12	19	4.1
12:30-13:30		12	25	37	8.0
12:45-13:45		7	30	37	8.0
13:00-14:00		8	27	35	7.6
13:15-14:15		11	26	37	8.0
13:30-14:30		7	11	18	3.9
13:45-14:45		9	5	14	3.0
14:00-15:00		12	7	19	4.1
14:15-15:15		11	5	16	3.5
14:30-15:30		11	7	18	3.9
14:45-15:45		10	9	19	4.1
15:00-16:00		5	20	25	5.4
15:15-16:15		4	32	36	7.8
15:30-16:30		2	32	34	7.3
15:45-16:45		3	33	36	7.8
16:00-17:00		4	23	27	5.8
16:15-17:15		6	12	18	3.9
16:30-17:30		10	21	31	6.7
16:45-17:45		11	24	35	7.6
17:00-18:00		13	27	40	8.6
17:15-18:15		11	28	39	8.4
17:30-18:30		8	21	29	6.3
17:45-18:45		5	23	28	6.0
18:00-19:00		3	21	24	5.2
18:15-19:15		4	22	26	5.6
18:30-19:30		4	25	29	6.3
18:45-19:45		7	19	26	5.6
19:00-20:00		6	14	20	4.3
19:15-20:15		8	11	19	4.1
19:30-20:30		8	7	15	3.2
19:45-20:45		8	6	14	3.0
20:00-21:00		9	8	17	3.7
20:15-21:15		6	7	13	2.8
20:30-21:30		5	4	9	1.9
20:45-21:45		10	4	14	3.0
21:00-22:00		9	5	14	3.0
21:15-22:15		9	6	15	3.2
21:30-22:30		9	10	19	4.1
21:45-22:45		1	8	9	1.9
22:00-23:00		1	5	6	1.3

歩行者通行量調査表

調査地点：地域社会4 瀬谷土橋公園入口

調査年月日：令和2年9月29日(火) 天候：曇りのち晴れ



時間帯	種別	方向			
		歩行者 (人)	自転車 (台)	合計 (人・台)	時間 係数 (%)
19:00-19:15		2	4	6	1.3
19:15-19:30		1	7	8	1.7
19:30-19:45		3	3	6	1.3
19:45-20:00		0	0	0	0.0
1時間計		6	14	20	4.3
20:00-20:15		4	1	5	1.1
20:15-20:30		1	3	4	0.9
20:30-20:45		3	2	5	1.1
20:45-21:00		1	2	3	0.6
1時間計		9	8	17	3.7
21:00-21:15		1	0	1	0.2
21:15-21:30		0	0	0	0.0
21:30-21:45		8	2	10	2.2
21:45-22:00		0	3	3	0.6
1時間計		9	5	14	3.0
22:00-22:15		1	1	2	0.4
22:15-22:30		0	4	4	0.9
22:30-22:45		0	0	0	0.0
22:45-23:00		0	0	0	0.0
1時間計		1	5	6	1.3
23:00-23:15		3	3	6	1.3
23:15-23:30		1	0	1	0.2
23:30-23:45		0	0	0	0.0
23:45-24:00		0	1	1	0.2
1時間計		4	4	8	1.7
0:00-0:15		2	0	2	0.4
0:15-0:30		0	0	0	0.0
0:30-0:45		0	0	0	0.0
0:45-1:00		1	0	1	0.2
1時間計		3	0	3	0.6
1:00-1:15		1	0	1	0.2
1:15-1:30		0	0	0	0.0
1:30-1:45		0	0	0	0.0
1:45-2:00		0	0	0	0.0
1時間計		1	0	1	0.2
2:00-2:15		0	0	0	0.0
2:15-2:30		0	1	1	0.2
2:30-2:45		1	0	1	0.2
2:45-3:00		1	0	1	0.2
1時間計		2	1	3	0.6
3:00-3:15		1	0	1	0.2
3:15-3:30		0	1	1	0.2
3:30-3:45		0	0	0	0.0
3:45-4:00		0	0	0	0.0
1時間計		1	1	2	0.4
4:00-4:15		0	0	0	0.0
4:15-4:30		0	0	0	0.0
4:30-4:45		0	0	0	0.0
4:45-5:00		0	0	0	0.0
1時間計		0	0	0	0.0
5:00-5:15		1	3	4	0.9
5:15-5:30		0	0	0	0.0
5:30-5:45		4	0	4	0.9
5:45-6:00		2	0	2	0.4
1時間計		7	3	10	2.2
6:00-6:15		2	0	2	0.4
6:15-6:30		4	0	4	0.9
6:30-6:45		1	4	5	1.1
6:45-7:00		5	0	5	1.1
1時間計		12	4	16	3.5
夜12時間計		55	45	100	21.6
全時間合計		163	300	463	100.0
昼夜率		1.51	1.18	1.28	-

時間帯	種別	方向			
		歩行者 (人)	自転車 (台)	合計 (人・台)	時間 係数 (%)
22:15-23:15		3	7	10	2.2
22:30-23:30		4	3	7	1.5
22:45-23:45		4	3	7	1.5
23:00-0:00		4	4	8	1.7
23:15-0:15		3	1	4	0.9
23:30-0:30		2	1	3	0.6
23:45-0:45		2	1	3	0.6
0:00-1:00		3	0	3	0.6
0:15-1:15		2	0	2	0.4
0:30-1:30		2	0	2	0.4
0:45-1:45		2	0	2	0.4
1:00-2:00		1	0	1	0.2
1:15-2:15		0	0	0	0.0
1:30-2:30		0	1	1	0.2
1:45-2:45		1	1	2	0.4
2:00-3:00		2	1	3	0.6
2:15-3:15		3	1	4	0.9
2:30-3:30		3	1	4	0.9
2:45-3:45		2	1	3	0.6
3:00-4:00		1	1	2	0.4
3:15-4:15		0	1	1	0.2
3:30-4:30		0	0	0	0.0
3:45-4:45		0	0	0	0.0
4:00-5:00		0	0	0	0.0
4:15-5:15		1	3	4	0.9
4:30-5:30		1	3	4	0.9
4:45-5:45		5	3	8	1.7
5:00-6:00		7	3	10	2.2
5:15-6:15		8	0	8	1.7
5:30-6:30		12	0	12	2.6
5:45-6:45		9	4	13	2.8
6:00-7:00		12	4	16	3.5
全時間合計		163	300	463	100.0

歩行者通行量調査表

調査地点 地域社会4 瀬谷土橋公園前

調査年月日 令和 2年 9月29日(火) 天候 曇りのち晴れ



方向	ア				イ				合計				
	種別	歩行者 (人)	自転車 (台)	合計 (人・台)	時間 係数 (%)	歩行者 (人)	自転車 (台)	合計 (人・台)	時間 係数 (%)	歩行者 (人)	自転車 (台)	合計 (人・台)	時間 係数 (%)
7:00-7:15		0	1	1	1.5	0	1	1	1.7	0	2	2	1.6
7:15-7:30		0	0	0	0.0	0	0	0	0.0	0	0	0	0.0
7:30-7:45		0	0	0	0.0	0	0	0	0.0	0	0	0	0.0
7:45-8:00		0	1	1	1.5	0	0	0	0.0	0	1	1	0.8
1時間計		0	2	2	2.9	0	1	1	1.7	0	3	3	2.4
8:00-8:15		1	0	1	1.5	2	0	2	3.4	3	0	3	2.4
8:15-8:30		1	0	1	1.5	4	3	7	11.9	5	3	8	6.3
8:30-8:45		1	0	1	1.5	1	1	2	3.4	2	1	3	2.4
8:45-9:00		1	0	1	1.5	2	1	3	5.1	3	1	4	3.1
1時間計		4	0	4	5.9	9	5	14	23.7	13	5	18	14.2
9:00-9:15		0	0	0	0.0	1	0	1	1.7	1	0	1	0.8
9:15-9:30		0	0	0	0.0	0	0	0	0.0	0	0	0	0.0
9:30-9:45		1	0	1	1.5	0	1	1	1.7	1	1	2	1.6
9:45-10:00		0	0	0	0.0	0	0	0	0.0	0	0	0	0.0
1時間計		1	0	1	1.5	1	1	2	3.4	2	1	3	2.4
10:00-10:15		1	0	1	1.5	0	0	0	0.0	1	0	1	0.8
10:15-10:30		0	0	0	0.0	0	0	0	0.0	0	0	0	0.0
10:30-10:45		0	0	0	0.0	0	0	0	0.0	0	0	0	0.0
10:45-11:00		1	0	1	1.5	0	0	0	0.0	1	0	1	0.8
1時間計		2	0	2	2.9	0	0	0	0.0	2	0	2	1.6
11:00-11:15		1	0	1	1.5	0	0	0	0.0	1	0	1	0.8
11:15-11:30		1	0	1	1.5	0	0	0	0.0	1	0	1	0.8
11:30-11:45		1	0	1	1.5	0	0	0	0.0	1	0	1	0.8
11:45-12:00		0	0	0	0.0	1	0	1	1.7	1	0	1	0.8
1時間計		3	0	3	4.4	1	0	1	1.7	4	0	4	3.1
12:00-12:15		6	1	7	10.3	4	0	4	6.8	10	1	11	8.7
12:15-12:30		2	1	3	4.4	4	1	5	8.5	6	2	8	6.3
12:30-12:45		5	0	5	7.4	1	0	1	1.7	6	0	6	4.7
12:45-13:00		2	1	3	4.4	8	0	8	13.6	10	1	11	8.7
1時間計		15	3	18	26.5	17	1	18	30.5	32	4	36	28.3
13:00-13:15		3	0	3	4.4	1	1	2	3.4	4	1	5	3.9
13:15-13:30		2	0	2	2.9	2	0	2	3.4	4	0	4	3.1
13:30-13:45		0	0	0	0.0	0	0	0	0.0	0	0	0	0.0
13:45-14:00		1	0	1	1.5	1	1	2	3.4	2	1	3	2.4
1時間計		6	0	6	8.8	4	2	6	10.2	10	2	12	9.4
14:00-14:15		0	1	1	1.5	2	1	3	5.1	2	2	4	3.1
14:15-14:30		0	1	1	1.5	0	0	0	0.0	0	1	1	0.8
14:30-14:45		1	0	1	1.5	0	0	0	0.0	1	0	1	0.8
14:45-15:00		0	0	0	0.0	2	0	2	3.4	2	0	2	1.6
1時間計		1	2	3	4.4	4	1	5	8.5	5	3	8	6.3

歩行者通行量調査表

調査地点 地域社会4 瀬谷土橋公園前

調査年月日 令和 2年 9月29日(火) 天候 曇りのち晴れ



方向	ア				イ				合計			
	歩行者 (人)	自転車 (台)	合計 (人・台)	時間 係数 (%)	歩行者 (人)	自転車 (台)	合計 (人・台)	時間 係数 (%)	歩行者 (人)	自転車 (台)	合計 (人・台)	時間 係数 (%)
時間帯												
15.00-15:15	1	0	1	1.5	0	0	0	0.0	1	0	1	0.8
15.15-15:30	0	0	0	0.0	0	0	0	0.0	0	0	0	0.0
15.30-15:45	0	0	0	0.0	0	0	0	0.0	0	0	0	0.0
15.45-16:00	0	0	0	0.0	0	0	0	0.0	0	0	0	0.0
1時間計	1	0	1	1.5	0	0	0	0.0	1	0	1	0.8
16.00-16:15	1	0	1	1.5	0	0	0	0.0	1	0	1	0.8
16.15-16:30	2	0	2	2.9	1	0	1	1.7	3	0	3	2.4
16.30-16:45	0	1	1	1.5	0	0	0	0.0	0	1	1	0.8
16.45-17:00	0	1	1	1.5	1	0	1	1.7	1	1	2	1.6
1時間計	3	2	5	7.4	2	0	2	3.4	5	2	7	5.5
17.00-17:15	1	0	1	1.5	0	0	0	0.0	1	0	1	0.8
17.15-17:30	0	0	0	0.0	0	0	0	0.0	0	0	0	0.0
17.30-17:45	3	1	4	5.9	0	0	0	0.0	3	1	4	3.1
17.45-18:00	1	1	2	2.9	0	0	0	0.0	1	1	2	1.6
1時間計	5	2	7	10.3	0	0	0	0.0	5	2	7	5.5
18.00-18:15	0	0	0	0.0	0	1	1	1.7	0	1	1	0.8
18.15-18:30	0	0	0	0.0	0	0	0	0.0	0	0	0	0.0
18.30-18:45	0	0	0	0.0	0	0	0	0.0	0	0	0	0.0
18.45-19:00	1	0	1	1.5	0	0	0	0.0	1	0	1	0.8
1時間計	1	0	1	1.5	0	1	1	1.7	1	1	2	1.6
昼12時間計	42	11	53	77.9	38	12	50	84.7	80	23	103	81.1
19.00-19:15	0	1	1	1.5	0	0	0	0.0	0	1	1	0.8
19.15-19:30	2	1	3	4.4	3	0	3	5.1	5	1	6	4.7
19.30-19:45	0	2	2	2.9	1	0	1	1.7	1	2	3	2.4
19.45-20:00	1	1	2	2.9	0	0	0	0.0	1	1	2	1.6
1時間計	3	5	8	11.8	4	0	4	6.8	7	5	12	9.4
20.00-20:15	0	0	0	0.0	0	0	0	0.0	0	0	0	0.0
20.15-20:30	0	0	0	0.0	0	0	0	0.0	0	0	0	0.0
20.30-20:45	0	0	0	0.0	0	0	0	0.0	0	0	0	0.0
20.45-21:00	0	0	0	0.0	0	0	0	0.0	0	0	0	0.0
1時間計	0	0	0	0.0	0	0	0	0.0	0	0	0	0.0
21.00-21:15	0	0	0	0.0	0	0	0	0.0	0	0	0	0.0
21.15-21:30	0	0	0	0.0	0	0	0	0.0	0	0	0	0.0
21.30-21:45	0	0	0	0.0	0	0	0	0.0	0	0	0	0.0
21.45-22:00	1	0	1	1.5	1	0	1	1.7	2	0	2	1.6
1時間計	1	0	1	1.5	1	0	1	1.7	2	0	2	1.6
22.00-22:15	0	0	0	0.0	0	0	0	0.0	0	0	0	0.0
22.15-22:30	1	0	1	1.5	0	0	0	0.0	1	0	1	0.8
22.30-22:45	0	0	0	0.0	0	0	0	0.0	0	0	0	0.0
22.45-23:00	0	0	0	0.0	1	0	1	1.7	1	0	1	0.8
1時間計	1	0	1	1.5	1	0	1	1.7	2	0	2	1.6

歩行者通行量調査表

調査地点 地域社会4 瀬谷土橋公園前

調査年月日 令和 2年 9月29日(火) 天候 曇りのち晴れ



方向	ア				イ				合計				
	種別	歩行者 (人)	自転車 (台)	合計 (人・台)	時間 係数 (%)	歩行者 (人)	自転車 (台)	合計 (人・台)	時間 係数 (%)	歩行者 (人)	自転車 (台)	合計 (人・台)	時間 係数 (%)
時間帯													
23:00-23:15		0	0	0	0.0	0	0	0	0.0	0	0	0	0.0
23:15-23:30		1	0	1	1.5	0	0	0	0.0	1	0	1	0.8
23:30-23:45		0	0	0	0.0	0	0	0	0.0	0	0	0	0.0
23:45-24:00		0	0	0	0.0	0	0	0	0.0	0	0	0	0.0
1時間計		1	0	1	1.5	0	0	0	0.0	1	0	1	0.8
0:00-0:15		1	0	1	1.5	0	0	0	0.0	1	0	1	0.8
0:15-0:30		0	0	0	0.0	0	0	0	0.0	0	0	0	0.0
0:30-0:45		0	0	0	0.0	0	0	0	0.0	0	0	0	0.0
0:45-1:00		0	0	0	0.0	0	0	0	0.0	0	0	0	0.0
1時間計		1	0	1	1.5	0	0	0	0.0	1	0	1	0.8
1:00-1:15		0	0	0	0.0	0	0	0	0.0	0	0	0	0.0
1:15-1:30		0	0	0	0.0	0	0	0	0.0	0	0	0	0.0
1:30-1:45		0	0	0	0.0	0	0	0	0.0	0	0	0	0.0
1:45-2:00		0	0	0	0.0	0	0	0	0.0	0	0	0	0.0
1時間計		0	0	0	0.0	0	0	0	0.0	0	0	0	0.0
2:00-2:15		0	0	0	0.0	0	0	0	0.0	0	0	0	0.0
2:15-2:30		0	0	0	0.0	0	0	0	0.0	0	0	0	0.0
2:30-2:45		0	0	0	0.0	0	0	0	0.0	0	0	0	0.0
2:45-3:00		0	0	0	0.0	0	0	0	0.0	0	0	0	0.0
1時間計		0	0	0	0.0	0	0	0	0.0	0	0	0	0.0
3:00-3:15		0	0	0	0.0	0	0	0	0.0	0	0	0	0.0
3:15-3:30		0	0	0	0.0	0	0	0	0.0	0	0	0	0.0
3:30-3:45		0	0	0	0.0	0	0	0	0.0	0	0	0	0.0
3:45-4:00		0	0	0	0.0	0	0	0	0.0	0	0	0	0.0
1時間計		0	0	0	0.0	0	0	0	0.0	0	0	0	0.0
4:00-4:15		0	0	0	0.0	0	0	0	0.0	0	0	0	0.0
4:15-4:30		0	1	1	1.5	0	0	0	0.0	0	1	1	0.8
4:30-4:45		0	0	0	0.0	0	0	0	0.0	0	0	0	0.0
4:45-5:00		0	0	0	0.0	0	0	0	0.0	0	0	0	0.0
1時間計		0	1	1	1.5	0	0	0	0.0	0	1	1	0.8
5:00-5:15		0	0	0	0.0	0	0	0	0.0	0	0	0	0.0
5:15-5:30		0	1	1	1.5	0	0	0	0.0	0	1	1	0.8
5:30-5:45		0	0	0	0.0	0	0	0	0.0	0	0	0	0.0
5:45-6:00		0	0	0	0.0	0	0	0	0.0	0	0	0	0.0
1時間計		0	1	1	1.5	0	0	0	0.0	0	1	1	0.8
6:00-6:15		0	0	0	0.0	0	0	0	0.0	0	0	0	0.0
6:15-6:30		0	1	1	1.5	1	1	2	3.4	1	2	3	2.4
6:30-6:45		0	0	0	0.0	0	0	0	0.0	0	0	0	0.0
6:45-7:00		0	0	0	0.0	0	1	1	1.7	0	1	1	0.8
1時間計		0	1	1	1.5	1	2	3	5.1	1	3	4	3.1
夜12時間計		7	8	15	22.1	7	2	9	15.3	14	10	24	18.9
全時間合計		49	19	68	100.0	45	14	59	100.0	94	33	127	100.0
昼夜平均		1.17	1.73	1.28	-	1.18	1.17	1.18	-	1.18	1.43	1.23	-

歩行者通行量調査表

調査地点 地域社会4 瀬谷土橋公園前

調査年月日 令和 2年 9月29日(火) 天候 曇りのち晴れ



方向	ウ				エ				合計				
	種別	歩行者 (人)	自転車 (台)	合計 (人・台)	時間 係数 (%)	歩行者 (人)	自転車 (台)	合計 (人・台)	時間 係数 (%)	歩行者 (人)	自転車 (台)	合計 (人・台)	時間 係数 (%)
時間帯													
7:00-7:15		0	0	0	0.0	0	0	0	0.0	0	0	0	0.0
7:15-7:30		1	1	2	4.4	0	0	0	0.0	1	1	2	2.6
7:30-7:45		0	0	0	0.0	0	0	0	0.0	0	0	0	0.0
7:45-8:00		1	0	1	2.2	0	0	0	0.0	1	0	1	1.3
1時間計		2	1	3	6.7	0	0	0	0.0	2	1	3	3.9
8:00-8:15		0	1	1	2.2	0	0	0	0.0	0	1	1	1.3
8:15-8:30		0	0	0	0.0	2	2	4	12.5	2	2	4	5.2
8:30-8:45		0	0	0	0.0	0	1	1	3.1	0	1	1	1.3
8:45-9:00		2	0	2	4.4	2	2	4	12.5	4	2	6	7.8
1時間計		2	1	3	6.7	4	5	9	28.1	6	6	12	15.6
9:00-9:15		1	0	1	2.2	0	0	0	0.0	1	0	1	1.3
9:15-9:30		1	0	1	2.2	1	0	1	3.1	2	0	2	2.6
9:30-9:45		1	0	1	2.2	0	1	1	3.1	1	1	2	2.6
9:45-10:00		0	0	0	0.0	1	0	1	3.1	1	0	1	1.3
1時間計		3	0	3	6.7	2	1	3	9.4	5	1	6	7.8
10:00-10:15		0	0	0	0.0	0	0	0	0.0	0	0	0	0.0
10:15-10:30		0	0	0	0.0	0	1	1	3.1	0	1	1	1.3
10:30-10:45		0	0	0	0.0	0	0	0	0.0	0	0	0	0.0
10:45-11:00		0	0	0	0.0	0	0	0	0.0	0	0	0	0.0
1時間計		0	0	0	0.0	0	1	1	3.1	0	1	1	1.3
11:00-11:15		0	1	1	2.2	0	0	0	0.0	0	1	1	1.3
11:15-11:30		0	1	1	2.2	0	0	0	0.0	0	1	1	1.3
11:30-11:45		1	0	1	2.2	0	0	0	0.0	1	0	1	1.3
11:45-12:00		1	0	1	2.2	1	0	1	3.1	2	0	2	2.6
1時間計		2	2	4	8.9	1	0	1	3.1	3	2	5	6.5
12:00-12:15		1	0	1	2.2	0	0	0	0.0	1	0	1	1.3
12:15-12:30		1	0	1	2.2	2	0	2	6.3	3	0	3	3.9
12:30-12:45		0	0	0	0.0	0	0	0	0.0	0	0	0	0.0
12:45-13:00		2	0	2	4.4	1	1	2	6.3	3	1	4	5.2
1時間計		4	0	4	8.9	3	1	4	12.5	7	1	8	10.4
13:00-13:15		2	1	3	6.7	1	0	1	3.1	3	1	4	5.2
13:15-13:30		0	0	0	0.0	1	0	1	3.1	1	0	1	1.3
13:30-13:45		1	0	1	2.2	1	0	1	3.1	2	0	2	2.6
13:45-14:00		0	0	0	0.0	0	1	1	3.1	0	1	1	1.3
1時間計		3	1	4	8.9	3	1	4	12.5	6	2	8	10.4
14:00-14:15		1	0	1	2.2	1	0	1	3.1	2	0	2	2.6
14:15-14:30		0	0	0	0.0	0	0	0	0.0	0	0	0	0.0
14:30-14:45		2	0	2	4.4	0	1	1	3.1	2	1	3	3.9
14:45-15:00		0	0	0	0.0	2	0	2	6.3	2	0	2	2.6
1時間計		3	0	3	6.7	3	1	4	12.5	6	1	7	9.1

歩行者通行量調査表

調査地点 地域社会4 瀬谷土橋公園前

調査年月日 令和 2年 9月29日(火) 天候 曇りのち晴れ



方向	ウ				エ				合計			
	歩行者 (人)	自転車 (台)	合計 (人・台)	時間 係数 (%)	歩行者 (人)	自転車 (台)	合計 (人・台)	時間 係数 (%)	歩行者 (人)	自転車 (台)	合計 (人・台)	時間 係数 (%)
15:00-15:15	0	0	0	0.0	0	0	0	0.0	0	0	0	0.0
15:15-15:30	0	0	0	0.0	0	0	0	0.0	0	0	0	0.0
15:30-15:45	0	0	0	0.0	0	0	0	0.0	0	0	0	0.0
15:45-16:00	0	0	0	0.0	0	0	0	0.0	0	0	0	0.0
1時間計	0	0	0	0.0	0	0	0	0.0	0	0	0	0.0
16:00-16:15	0	0	0	0.0	0	1	1	3.1	0	1	1	1.3
16:15-16:30	2	0	2	4.4	0	0	0	0.0	2	0	2	2.6
16:30-16:45	0	0	0	0.0	0	0	0	0.0	0	0	0	0.0
16:45-17:00	0	1	1	2.2	0	0	0	0.0	0	1	1	1.3
1時間計	2	1	3	6.7	0	1	1	3.1	2	2	4	5.2
17:00-17:15	0	0	0	0.0	0	0	0	0.0	0	0	0	0.0
17:15-17:30	0	0	0	0.0	0	0	0	0.0	0	0	0	0.0
17:30-17:45	0	0	0	0.0	0	0	0	0.0	0	0	0	0.0
17:45-18:00	0	0	0	0.0	0	0	0	0.0	0	0	0	0.0
1時間計	0	0	0	0.0	0	0	0	0.0	0	0	0	0.0
18:00-18:15	0	1	1	2.2	0	1	1	3.1	0	2	2	2.6
18:15-18:30	0	2	2	4.4	0	0	0	0.0	0	2	2	2.6
18:30-18:45	0	1	1	2.2	0	0	0	0.0	0	1	1	1.3
18:45-19:00	0	0	0	0.0	0	0	0	0.0	0	0	0	0.0
1時間計	0	4	4	8.9	0	1	1	3.1	0	5	5	6.5
昼12時間計	21	10	31	68.9	16	12	28	87.5	37	22	59	76.6
19:00-19:15	0	2	2	4.4	0	0	0	0.0	0	2	2	2.6
19:15-19:30	2	0	2	4.4	2	0	2	6.3	4	0	4	5.2
19:30-19:45	0	0	0	0.0	0	0	0	0.0	0	0	0	0.0
19:45-20:00	0	1	1	2.2	0	0	0	0.0	0	1	1	1.3
1時間計	2	3	5	11.1	2	0	2	6.3	4	3	7	9.1
20:00-20:15	0	1	1	2.2	0	0	0	0.0	0	1	1	1.3
20:15-20:30	0	0	0	0.0	0	0	0	0.0	0	0	0	0.0
20:30-20:45	0	0	0	0.0	0	0	0	0.0	0	0	0	0.0
20:45-21:00	0	0	0	0.0	0	0	0	0.0	0	0	0	0.0
1時間計	0	1	1	2.2	0	0	0	0.0	0	1	1	1.3
21:00-21:15	0	0	0	0.0	0	0	0	0.0	0	0	0	0.0
21:15-21:30	0	0	0	0.0	0	0	0	0.0	0	0	0	0.0
21:30-21:45	0	0	0	0.0	0	0	0	0.0	0	0	0	0.0
21:45-22:00	0	1	1	2.2	0	1	1	3.1	0	2	2	2.6
1時間計	0	1	1	2.2	0	1	1	3.1	0	2	2	2.6
22:00-22:15	0	0	0	0.0	0	0	0	0.0	0	0	0	0.0
22:15-22:30	0	0	0	0.0	0	0	0	0.0	0	0	0	0.0
22:30-22:45	0	0	0	0.0	0	0	0	0.0	0	0	0	0.0
22:45-23:00	1	0	1	2.2	0	0	0	0.0	1	0	1	1.3
1時間計	1	0	1	2.2	0	0	0	0.0	1	0	1	1.3

歩行者通行量調査表

調査地点 地域社会4 瀬谷土橋公園前

調査年月日 令和 2年 9月29日(火) 天候 曇りのち晴れ



方向	ウ				エ				合計				
	種別	歩行者 (人)	自転車 (台)	合計 (人・台)	時間 係数 (%)	歩行者 (人)	自転車 (台)	合計 (人・台)	時間 係数 (%)	歩行者 (人)	自転車 (台)	合計 (人・台)	時間 係数 (%)
時間帯													
23:00-23:15		0	0	0	0.0	0	0	0	0.0	0	0	0	0.0
23:15-23:30		0	0	0	0.0	0	0	0	0.0	0	0	0	0.0
23:30-23:45		0	0	0	0.0	0	0	0	0.0	0	0	0	0.0
23:45-24:00		0	0	0	0.0	0	0	0	0.0	0	0	0	0.0
1時間計		0	0	0	0.0	0	0	0	0.0	0	0	0	0.0
0:00-0:15		1	0	1	2.2	1	0	1	3.1	2	0	2	2.6
0:15-0:30		0	0	0	0.0	0	0	0	0.0	0	0	0	0.0
0:30-0:45		0	0	0	0.0	0	0	0	0.0	0	0	0	0.0
0:45-1:00		0	0	0	0.0	0	0	0	0.0	0	0	0	0.0
1時間計		1	0	1	2.2	1	0	1	3.1	2	0	2	2.6
1:00-1:15		0	0	0	0.0	0	0	0	0.0	0	0	0	0.0
1:15-1:30		0	0	0	0.0	0	0	0	0.0	0	0	0	0.0
1:30-1:45		0	0	0	0.0	0	0	0	0.0	0	0	0	0.0
1:45-2:00		0	0	0	0.0	0	0	0	0.0	0	0	0	0.0
1時間計		0	0	0	0.0	0	0	0	0.0	0	0	0	0.0
2:00-2:15		0	0	0	0.0	0	0	0	0.0	0	0	0	0.0
2:15-2:30		0	0	0	0.0	0	0	0	0.0	0	0	0	0.0
2:30-2:45		0	0	0	0.0	0	0	0	0.0	0	0	0	0.0
2:45-3:00		0	0	0	0.0	0	0	0	0.0	0	0	0	0.0
1時間計		0	0	0	0.0	0	0	0	0.0	0	0	0	0.0
3:00-3:15		0	0	0	0.0	0	0	0	0.0	0	0	0	0.0
3:15-3:30		0	1	1	2.2	0	0	0	0.0	0	1	1	1.3
3:30-3:45		0	0	0	0.0	0	0	0	0.0	0	0	0	0.0
3:45-4:00		0	0	0	0.0	0	0	0	0.0	0	0	0	0.0
1時間計		0	1	1	2.2	0	0	0	0.0	0	1	1	1.3
4:00-4:15		0	1	1	2.2	0	0	0	0.0	0	1	1	1.3
4:15-4:30		1	1	2	4.4	0	0	0	0.0	1	1	2	2.6
4:30-4:45		0	0	0	0.0	0	0	0	0.0	0	0	0	0.0
4:45-5:00		0	0	0	0.0	0	0	0	0.0	0	0	0	0.0
1時間計		1	2	3	6.7	0	0	0	0.0	1	2	3	3.9
5:00-5:15		0	0	0	0.0	0	0	0	0.0	0	0	0	0.0
5:15-5:30		0	0	0	0.0	0	0	0	0.0	0	0	0	0.0
5:30-5:45		0	1	1	2.2	0	0	0	0.0	0	1	1	1.3
5:45-6:00		0	0	0	0.0	0	0	0	0.0	0	0	0	0.0
1時間計		0	1	1	2.2	0	0	0	0.0	0	1	1	1.3
6:00-6:15		0	0	0	0.0	0	0	0	0.0	0	0	0	0.0
6:15-6:30		0	0	0	0.0	0	0	0	0.0	0	0	0	0.0
6:30-6:45		0	0	0	0.0	0	0	0	0.0	0	0	0	0.0
6:45-7:00		0	0	0	0.0	0	0	0	0.0	0	0	0	0.0
1時間計		0	0	0	0.0	0	0	0	0.0	0	0	0	0.0
夜12時間計		5	9	14	31.1	3	1	4	12.5	8	10	18	23.4
全時間合計		26	19	45	100.0	19	13	32	100.0	45	32	77	100.0
昼夜平均		1.24	1.90	1.45	-	1.19	1.08	1.14	-	1.22	1.45	1.31	-

歩行者通行量調査表

調査地点：地域社会4 瀬谷土橋公園前

調査年月日：令和2年9月29日(火) 天候 曇りのち晴れ



時間帯	方向 種別	合計 (7+イ+ウ+1)			時間 係数 (%)
		歩行者 (人)	自転車 (台)	合計 (人・台)	
7:00-7:15		0	2	2	1.0
7:15-7:30		1	1	2	1.0
7:30-7:45		0	0	0	0.0
7:45-8:00		1	1	2	1.0
1時間計		2	4	6	2.9
8:00-8:15		3	1	4	2.0
8:15-8:30		7	5	12	5.9
8:30-8:45		2	2	4	2.0
8:45-9:00		7	3	10	4.9
1時間計		19	11	30	14.7
9:00-9:15		2	0	2	1.0
9:15-9:30		2	0	2	1.0
9:30-9:45		2	2	4	2.0
9:45-10:00		1	0	1	0.5
1時間計		7	2	9	4.4
10:00-10:15		1	0	1	0.5
10:15-10:30		0	1	1	0.5
10:30-10:45		0	0	0	0.0
10:45-11:00		1	0	1	0.5
1時間計		2	1	3	1.5
11:00-11:15		1	1	2	1.0
11:15-11:30		1	1	2	1.0
11:30-11:45		2	0	2	1.0
11:45-12:00		3	0	3	1.5
1時間計		7	2	9	4.4
12:00-12:15		11	1	12	5.9
12:15-12:30		9	2	11	5.4
12:30-12:45		6	0	6	2.9
12:45-13:00		13	2	15	7.4
1時間計		39	5	44	21.6
13:00-13:15		7	2	9	4.4
13:15-13:30		5	0	5	2.5
13:30-13:45		2	0	2	1.0
13:45-14:00		2	2	4	2.0
1時間計		16	4	20	9.8
14:00-14:15		4	2	6	2.9
14:15-14:30		0	1	1	0.5
14:30-14:45		3	1	4	2.0
14:45-15:00		4	0	4	2.0
1時間計		11	4	15	7.4
15:00-15:15		1	0	1	0.5
15:15-15:30		0	0	0	0.0
15:30-15:45		0	0	0	0.0
15:45-16:00		0	0	0	0.0
1時間計		1	0	1	0.5
16:00-16:15		1	1	2	1.0
16:15-16:30		5	0	5	2.5
16:30-16:45		0	1	1	0.5
16:45-17:00		1	2	3	1.5
1時間計		7	4	11	5.4
17:00-17:15		1	0	1	0.5
17:15-17:30		0	0	0	0.0
17:30-17:45		3	1	4	2.0
17:45-18:00		1	1	2	1.0
1時間計		5	2	7	3.4
18:00-18:15		0	3	3	1.5
18:15-18:30		0	2	2	1.0
18:30-18:45		0	1	1	0.5
18:45-19:00		1	0	1	0.5
1時間計		1	6	7	3.4
昼12時間計		117	45	162	79.4

時間帯	方向 種別	合計 (7+イ+ウ+1)			時間 係数 (%)
		歩行者 (人)	自転車 (台)	合計 (人・台)	
7:00-8:00		2	4	6	2.9
7:15-8:15		5	3	8	3.9
7:30-8:30		11	7	18	8.8
7:45-8:45		13	9	22	10.8
8:00-9:00		19	11	30	14.7
8:15-9:15		18	10	28	13.7
8:30-9:30		13	5	18	8.8
8:45-9:45		13	5	18	8.8
9:00-10:00		7	2	9	4.4
9:15-10:15		6	2	8	3.9
9:30-10:30		4	3	7	3.4
9:45-10:45		2	1	3	1.5
10:00-11:00		2	1	3	1.5
10:15-11:15		2	2	4	2.0
10:30-11:30		3	2	5	2.5
10:45-11:45		5	2	7	3.4
11:00-12:00		7	2	9	4.4
11:15-12:15		17	2	19	9.3
11:30-12:30		27	3	30	14.7
11:45-12:45		28	3	41	20.1
12:00-13:00		39	5	44	21.6
12:15-13:15		35	6	41	20.1
12:30-13:30		31	4	35	17.2
12:45-13:45		27	4	31	15.2
13:00-14:00		16	4	20	9.8
13:15-14:15		13	4	17	8.3
13:30-14:30		8	5	13	6.4
13:45-14:45		9	6	15	7.4
14:00-15:00		11	4	15	7.4
14:15-15:15		8	2	10	4.9
14:30-15:30		8	1	9	4.4
14:45-15:45		5	0	5	2.5
15:00-16:00		1	0	1	0.5
15:15-16:15		1	1	2	1.0
15:30-16:30		6	1	7	3.4
15:45-16:45		6	2	8	3.9
16:00-17:00		7	4	11	5.4
16:15-17:15		7	3	10	4.9
16:30-17:30		2	3	5	2.5
16:45-17:45		5	3	8	3.9
17:00-18:00		5	2	7	3.4
17:15-18:15		4	5	9	4.4
17:30-18:30		4	7	11	5.4
17:45-18:45		1	7	8	3.9
18:00-19:00		1	6	7	3.4
18:15-19:15		1	6	7	3.4
18:30-19:30		10	5	15	7.4
18:45-19:45		11	6	17	8.2
19:00-20:00		11	8	19	9.3
19:15-20:15		11	6	17	8.3
19:30-20:30		2	5	7	3.4
19:45-20:45		1	3	4	2.0
20:00-21:00		0	1	1	0.5
20:15-21:15		0	0	0	0.0
20:30-21:30		0	0	0	0.0
20:45-21:45		0	0	0	0.0
21:00-22:00		2	2	4	2.0
21:15-22:15		2	2	4	2.0
21:30-22:30		3	2	5	2.5
21:45-22:45		3	2	5	2.5
22:00-23:00		3	0	3	1.5

歩行者通行量調査表

調査地点：地域社会4 瀬谷土橋公園前

調査年月日：令和2年9月29日(火) 天候：曇りのち晴れ



時間帯	種別	合計 (7+イ+ウ+1)			時間係数 (%)
		歩行者 (人)	自転車 (台)	合計 (人・台)	
19:00-19:15		0	3	3	1.5
19:15-19:30		9	1	10	4.9
19:30-19:45		1	2	3	1.5
19:45-20:00		1	2	3	1.5
1時間計		11	8	19	9.3
20:00-20:15		0	1	1	0.5
20:15-20:30		0	0	0	0.0
20:30-20:45		0	0	0	0.0
20:45-21:00		0	0	0	0.0
1時間計		0	1	1	0.5
21:00-21:15		0	0	0	0.0
21:15-21:30		0	0	0	0.0
21:30-21:45		0	0	0	0.0
21:45-22:00		2	2	4	2.0
1時間計		2	2	4	2.0
22:00-22:15		0	0	0	0.0
22:15-22:30		1	0	1	0.5
22:30-22:45		0	0	0	0.0
22:45-23:00		2	0	2	1.0
1時間計		3	0	3	1.5
23:00-23:15		0	0	0	0.0
23:15-23:30		1	0	1	0.5
23:30-23:45		0	0	0	0.0
23:45-24:00		0	0	0	0.0
1時間計		1	0	1	0.5
0:00-0:15		3	0	3	1.5
0:15-0:30		0	0	0	0.0
0:30-0:45		0	0	0	0.0
0:45-1:00		0	0	0	0.0
1時間計		3	0	3	1.5
1:00-1:15		0	0	0	0.0
1:15-1:30		0	0	0	0.0
1:30-1:45		0	0	0	0.0
1:45-2:00		0	0	0	0.0
1時間計		0	0	0	0.0
2:00-2:15		0	0	0	0.0
2:15-2:30		0	0	0	0.0
2:30-2:45		0	0	0	0.0
2:45-3:00		0	0	0	0.0
1時間計		0	0	0	0.0
3:00-3:15		0	0	0	0.0
3:15-3:30		0	1	1	0.5
3:30-3:45		0	0	0	0.0
3:45-4:00		0	0	0	0.0
1時間計		0	1	1	0.5
4:00-4:15		0	1	1	0.5
4:15-4:30		1	2	3	1.5
4:30-4:45		0	0	0	0.0
4:45-5:00		0	0	0	0.0
1時間計		1	3	4	2.0
5:00-5:15		0	0	0	0.0
5:15-5:30		0	1	1	0.5
5:30-5:45		0	1	1	0.5
5:45-6:00		0	0	0	0.0
1時間計		0	2	2	1.0
6:00-6:15		0	0	0	0.0
6:15-6:30		1	2	3	1.5
6:30-6:45		0	0	0	0.0
6:45-7:00		0	1	1	0.5
1時間計		1	3	4	2.0
夜12時間計		22	20	42	20.6
全時間合計		139	65	204	100.0
昼夜率		1.19	1.44	1.26	

時間帯	種別	合計 (7+イ+ウ+1)			時間係数 (%)
		歩行者 (人)	自転車 (台)	合計 (人・台)	
22:15-23:15		3	0	3	1.5
22:30-23:30		3	0	3	1.5
22:45-23:45		3	0	3	1.5
23:00-0:00		1	0	1	0.5
23:15-0:15		4	0	4	2.0
23:30-0:30		3	0	3	1.5
23:45-0:45		3	0	3	1.5
0:00-1:00		3	0	3	1.5
0:15-1:15		0	0	0	0.0
0:30-1:30		0	0	0	0.0
0:45-1:45		0	0	0	0.0
1:00-2:00		0	0	0	0.0
1:15-2:15		0	0	0	0.0
1:30-2:30		0	0	0	0.0
1:45-2:45		0	0	0	0.0
2:00-3:00		0	0	0	0.0
2:15-3:15		0	0	0	0.0
2:30-3:30		0	1	1	0.5
2:45-3:45		0	1	1	0.5
3:00-4:00		0	1	1	0.5
3:15-4:15		0	2	2	1.0
3:30-4:30		1	3	4	2.0
3:45-4:45		1	3	4	2.0
4:00-5:00		1	3	4	2.0
4:15-5:15		2	2	4	2.0
4:30-5:30		0	1	1	0.5
4:45-5:45		0	2	2	1.0
5:00-6:00		0	2	2	1.0
5:15-6:15		0	2	2	1.0
5:30-6:30		1	3	4	2.0
5:45-6:45		1	2	3	1.5
6:00-7:00		1	3	4	2.0
全時間合計		139	65	204	100.0

歩行者通行量調査表

調査地点 地域社会5

調査年月日 令和元年 5月14日(火) 天候 雨のち曇り



方向	ア				イ				合計				
	種別	歩行者 (人)	自転車 (台)	合計 (人・台)	時間 係数 (%)	歩行者 (人)	自転車 (台)	合計 (人・台)	時間 係数 (%)	歩行者 (人)	自転車 (台)	合計 (人・台)	時間 係数 (%)
7:00-7:15	時間帯	0	0	0	0.0	0	1	1	3.7	0	1	1	2.3
7:15-7:30		0	0	0	0.0	0	0	0	0.0	0	0	0	0.0
7:30-7:45		0	0	0	0.0	0	1	1	3.7	0	1	1	2.3
7:45-8:00		0	1	1	5.9	0	0	0	0.0	0	1	1	2.3
1時間計		0	1	1	5.9	0	2	2	7.4	0	3	3	6.8
8:00-8:15		0	0	0	0.0	1	3	4	14.8	1	3	4	9.1
8:15-8:30		0	2	2	11.8	0	0	0	0.0	0	2	2	4.5
8:30-8:45		0	2	2	11.8	0	0	0	0.0	0	2	2	4.5
8:45-9:00		0	1	1	5.9	0	0	0	0.0	0	1	1	2.3
1時間計		0	5	5	29.4	1	3	4	14.8	1	8	9	20.5
9:00-9:15		0	0	0	0.0	0	0	0	0.0	0	0	0	0.0
9:15-9:30		0	0	0	0.0	0	0	0	0.0	0	0	0	0.0
9:30-9:45		0	0	0	0.0	0	1	1	3.7	0	1	1	2.3
9:45-10:00		0	0	0	0.0	0	0	0	0.0	0	0	0	0.0
1時間計		0	0	0	0.0	0	1	1	3.7	0	1	1	2.3
10:00-10:15		0	0	0	0.0	0	0	0	0.0	0	0	0	0.0
10:15-10:30		0	0	0	0.0	0	0	0	0.0	0	0	0	0.0
10:30-10:45		0	0	0	0.0	0	0	0	0.0	0	0	0	0.0
10:45-11:00		0	0	0	0.0	0	0	0	0.0	0	0	0	0.0
1時間計		0	0	0	0.0	0	0	0	0.0	0	0	0	0.0
11:00-11:15		0	0	0	0.0	0	0	0	0.0	0	0	0	0.0
11:15-11:30		0	0	0	0.0	0	0	0	0.0	0	0	0	0.0
11:30-11:45		0	0	0	0.0	0	0	0	0.0	0	0	0	0.0
11:45-12:00		0	0	0	0.0	0	0	0	0.0	0	0	0	0.0
1時間計		0	0	0	0.0	0	0	0	0.0	0	0	0	0.0
12:00-12:15		0	1	1	5.9	0	1	1	3.7	0	2	2	4.5
12:15-12:30		0	0	0	0.0	0	0	0	0.0	0	0	0	0.0
12:30-12:45		0	0	0	0.0	0	0	0	0.0	0	0	0	0.0
12:45-13:00		0	0	0	0.0	1	0	1	3.7	1	0	1	2.3
1時間計		0	1	1	5.9	1	1	2	7.4	1	2	3	6.8
13:00-13:15		0	1	1	5.9	0	0	0	0.0	0	1	1	2.3
13:15-13:30		0	0	0	0.0	0	0	0	0.0	0	0	0	0.0
13:30-13:45		0	1	1	5.9	0	0	0	0.0	0	1	1	2.3
13:45-14:00		0	0	0	0.0	0	0	0	0.0	0	0	0	0.0
1時間計		0	2	2	11.8	0	0	0	0.0	0	2	2	4.5
14:00-14:15		0	0	0	0.0	0	0	0	0.0	0	0	0	0.0
14:15-14:30		0	0	0	0.0	0	0	0	0.0	0	0	0	0.0
14:30-14:45		0	1	1	5.9	0	1	1	3.7	0	2	2	4.5
14:45-15:00		0	0	0	0.0	0	0	0	0.0	0	0	0	0.0
1時間計		0	1	1	5.9	0	1	1	3.7	0	2	2	4.5

歩行者通行量調査表

調査地点 地域社会5

調査年月日 令和元年 5月14日(火) 天候 雨のち曇り



方向	ア				イ				合計			
	歩行者 (人)	自転車 (台)	合計 (人・台)	時間 係数 (%)	歩行者 (人)	自転車 (台)	合計 (人・台)	時間 係数 (%)	歩行者 (人)	自転車 (台)	合計 (人・台)	時間 係数 (%)
時間帯												
15:00-15:15	0	0	0	0.0	0	1	1	3.7	0	1	1	2.3
15:15-15:30	0	0	0	0.0	0	0	0	0.0	0	0	0	0.0
15:30-15:45	0	0	0	0.0	0	0	0	0.0	0	0	0	0.0
15:45-16:00	1	0	1	5.9	0	0	0	0.0	1	0	1	2.3
1時間計	1	0	1	5.9	0	1	1	3.7	1	1	2	4.5
16:00-16:15	0	0	0	0.0	0	0	0	0.0	0	0	0	0.0
16:15-16:30	0	0	0	0.0	0	0	0	0.0	0	0	0	0.0
16:30-16:45	0	0	0	0.0	0	0	0	0.0	0	0	0	0.0
16:45-17:00	0	0	0	0.0	0	0	0	0.0	0	0	0	0.0
1時間計	0	0	0	0.0	0	0	0	0.0	0	0	0	0.0
17:00-17:15	0	0	0	0.0	0	0	0	0.0	0	0	0	0.0
17:15-17:30	0	1	1	5.9	0	1	1	3.7	0	2	2	4.5
17:30-17:45	0	0	0	0.0	0	1	1	3.7	0	1	1	2.3
17:45-18:00	0	0	0	0.0	0	1	1	3.7	0	1	1	2.3
1時間計	0	1	1	5.9	0	3	3	11.1	0	4	4	9.1
18:00-18:15	0	0	0	0.0	1	0	1	3.7	1	0	1	2.3
18:15-18:30	0	0	0	0.0	1	1	2	7.4	1	1	2	4.5
18:30-18:45	0	2	2	11.8	0	1	1	3.7	0	3	3	6.8
18:45-19:00	0	0	0	0.0	0	0	0	0.0	0	0	0	0.0
1時間計	0	2	2	11.8	2	2	4	14.8	2	4	6	13.6
昼12時間計	1	13	14	82.4	4	14	18	66.7	5	27	32	72.7
19:00-19:15	0	0	0	0.0	0	0	0	0.0	0	0	0	0.0
19:15-19:30	1	0	1	5.9	0	0	0	0.0	1	0	1	2.3
19:30-19:45	0	0	0	0.0	0	0	0	0.0	0	0	0	0.0
19:45-20:00	0	0	0	0.0	0	0	0	0.0	0	0	0	0.0
1時間計	1	0	1	5.9	0	0	0	0.0	1	0	1	2.3
20:00-20:15	0	0	0	0.0	0	0	0	0.0	0	0	0	0.0
20:15-20:30	0	0	0	0.0	0	0	0	0.0	0	0	0	0.0
20:30-20:45	0	0	0	0.0	0	4	4	14.8	0	4	4	9.1
20:45-21:00	0	0	0	0.0	0	0	0	0.0	0	0	0	0.0
1時間計	0	0	0	0.0	0	4	4	14.8	0	4	4	9.1
21:00-21:15	0	0	0	0.0	0	0	0	0.0	0	0	0	0.0
21:15-21:30	0	0	0	0.0	0	0	0	0.0	0	0	0	0.0
21:30-21:45	0	0	0	0.0	0	0	0	0.0	0	0	0	0.0
21:45-22:00	0	0	0	0.0	0	0	0	0.0	0	0	0	0.0
1時間計	0	0	0	0.0	0	0	0	0.0	0	0	0	0.0
22:00-22:15	0	0	0	0.0	0	0	0	0.0	0	0	0	0.0
22:15-22:30	0	0	0	0.0	0	1	1	3.7	0	1	1	2.3
22:30-22:45	1	0	1	5.9	0	0	0	0.0	1	0	1	2.3
22:45-23:00	0	0	0	0.0	0	0	0	0.0	0	0	0	0.0
1時間計	1	0	1	5.9	0	1	1	3.7	1	1	2	4.5

歩行者通行量調査表

調査地点 地域社会5

調査年月日 令和元年 5月14日(火) 天候 雨のち曇り



方向	ア				イ				合計				
	種別	歩行者 (人)	自転車 (台)	合計 (人・台)	時間 係数 (%)	歩行者 (人)	自転車 (台)	合計 (人・台)	時間 係数 (%)	歩行者 (人)	自転車 (台)	合計 (人・台)	時間 係数 (%)
時間帯													
23:00-23:15		0	0	0	0.0	0	0	0	0.0	0	0	0	0.0
23:15-23:30		0	0	0	0.0	0	0	0	0.0	0	0	0	0.0
23:30-23:45		0	0	0	0.0	0	0	0	0.0	0	0	0	0.0
23:45-24:00		0	0	0	0.0	0	0	0	0.0	0	0	0	0.0
1時間計		0	0	0	0.0	0	0	0	0.0	0	0	0	0.0
0:00-0:15		0	0	0	0.0	0	0	0	0.0	0	0	0	0.0
0:15-0:30		0	0	0	0.0	0	0	0	0.0	0	0	0	0.0
0:30-0:45		0	0	0	0.0	0	0	0	0.0	0	0	0	0.0
0:45-1:00		0	0	0	0.0	0	0	0	0.0	0	0	0	0.0
1時間計		0	0	0	0.0	0	0	0	0.0	0	0	0	0.0
1:00-1:15		0	0	0	0.0	0	0	0	0.0	0	0	0	0.0
1:15-1:30		0	0	0	0.0	0	0	0	0.0	0	0	0	0.0
1:30-1:45		0	0	0	0.0	0	0	0	0.0	0	0	0	0.0
1:45-2:00		0	0	0	0.0	0	0	0	0.0	0	0	0	0.0
1時間計		0	0	0	0.0	0	0	0	0.0	0	0	0	0.0
2:00-2:15		0	0	0	0.0	0	0	0	0.0	0	0	0	0.0
2:15-2:30		0	0	0	0.0	0	0	0	0.0	0	0	0	0.0
2:30-2:45		0	0	0	0.0	0	0	0	0.0	0	0	0	0.0
2:45-3:00		0	0	0	0.0	0	0	0	0.0	0	0	0	0.0
1時間計		0	0	0	0.0	0	0	0	0.0	0	0	0	0.0
3:00-3:15		0	0	0	0.0	0	0	0	0.0	0	0	0	0.0
3:15-3:30		0	0	0	0.0	0	0	0	0.0	0	0	0	0.0
3:30-3:45		0	0	0	0.0	0	0	0	0.0	0	0	0	0.0
3:45-4:00		0	0	0	0.0	0	0	0	0.0	0	0	0	0.0
1時間計		0	0	0	0.0	0	0	0	0.0	0	0	0	0.0
4:00-4:15		0	0	0	0.0	0	0	0	0.0	0	0	0	0.0
4:15-4:30		0	0	0	0.0	0	0	0	0.0	0	0	0	0.0
4:30-4:45		0	0	0	0.0	0	0	0	0.0	0	0	0	0.0
4:45-5:00		0	0	0	0.0	0	0	0	0.0	0	0	0	0.0
1時間計		0	0	0	0.0	0	0	0	0.0	0	0	0	0.0
5:00-5:15		0	0	0	0.0	0	0	0	0.0	0	0	0	0.0
5:15-5:30		0	0	0	0.0	0	0	0	0.0	0	0	0	0.0
5:30-5:45		0	0	0	0.0	0	0	0	0.0	0	0	0	0.0
5:45-6:00		0	0	0	0.0	1	0	1	3.7	1	0	1	2.3
1時間計		0	0	0	0.0	1	0	1	3.7	1	0	1	2.3
6:00-6:15		0	0	0	0.0	1	0	1	3.7	1	0	1	2.3
6:15-6:30		1	0	1	5.9	1	1	2	7.4	2	1	3	6.8
6:30-6:45		0	0	0	0.0	0	0	0	0.0	0	0	0	0.0
6:45-7:00		0	0	0	0.0	0	0	0	0.0	0	0	0	0.0
1時間計		1	0	1	5.9	2	1	3	11.1	3	1	4	9.1
夜12時間計		3	0	3	17.6	3	6	9	33.3	6	6	12	27.3
全時間合計		4	13	17	100.0	7	20	27	100.0	11	33	44	100.0
昼夜平均		4.00	1.00	1.21	-	1.75	1.43	1.50	-	2.20	1.22	1.38	-

歩行者通行量調査表

調査地点 地域社会5

調査年月日 令和元年 5月14日(火) 天候 雨のち曇り



方向	ウ				エ				合計				
	種別	歩行者 (人)	自転車 (台)	合計 (人・台)	時間 係数 (%)	歩行者 (人)	自転車 (台)	合計 (人・台)	時間 係数 (%)	歩行者 (人)	自転車 (台)	合計 (人・台)	時間 係数 (%)
7:00-7:15	時間帯	0	1	1	1.7	0	0	0	0.0	0	1	1	1.0
7:15-7:30		0	2	2	3.3	0	0	0	0.0	0	2	2	1.9
7:30-7:45		0	1	1	1.7	0	3	3	6.7	0	4	4	3.8
7:45-8:00		0	1	1	1.7	0	1	1	2.2	0	2	2	1.9
1時間計		0	5	5	8.3	0	4	4	8.9	0	9	9	8.6
8:00-8:15		0	1	1	1.7	0	0	0	0.0	0	1	1	1.0
8:15-8:30		0	4	4	6.7	0	2	2	4.4	0	6	6	5.7
8:30-8:45		0	3	3	5.0	0	1	1	2.2	0	4	4	3.8
8:45-9:00		0	1	1	1.7	0	0	0	0.0	0	1	1	1.0
1時間計		0	9	9	15.0	0	3	3	6.7	0	12	12	11.4
9:00-9:15		1	1	2	3.3	0	0	0	0.0	1	1	2	1.9
9:15-9:30		0	2	2	3.3	0	0	0	0.0	0	2	2	1.9
9:30-9:45		0	3	3	5.0	0	0	0	0.0	0	3	3	2.9
9:45-10:00		0	3	3	5.0	0	0	0	0.0	0	3	3	2.9
1時間計		1	9	10	16.7	0	0	0	0.0	1	9	10	9.5
10:00-10:15		0	0	0	0.0	0	0	0	0.0	0	0	0	0.0
10:15-10:30		0	0	0	0.0	0	0	0	0.0	0	0	0	0.0
10:30-10:45		0	0	0	0.0	0	0	0	0.0	0	0	0	0.0
10:45-11:00		0	0	0	0.0	0	0	0	0.0	0	0	0	0.0
1時間計		0	0	0	0.0	0	0	0	0.0	0	0	0	0.0
11:00-11:15		1	0	1	1.7	0	0	0	0.0	1	0	1	1.0
11:15-11:30		1	0	1	1.7	0	0	0	0.0	1	0	1	1.0
11:30-11:45		0	1	1	1.7	0	0	0	0.0	0	1	1	1.0
11:45-12:00		0	0	0	0.0	0	0	0	0.0	0	0	0	0.0
1時間計		2	1	3	5.0	0	0	0	0.0	2	1	3	2.9
12:00-12:15		0	0	0	0.0	0	0	0	0.0	0	0	0	0.0
12:15-12:30		0	0	0	0.0	0	0	0	0.0	0	0	0	0.0
12:30-12:45		0	0	0	0.0	0	0	0	0.0	0	0	0	0.0
12:45-13:00		0	0	0	0.0	0	0	0	0.0	0	0	0	0.0
1時間計		0	0	0	0.0	0	0	0	0.0	0	0	0	0.0
13:00-13:15		0	0	0	0.0	0	0	0	0.0	0	0	0	0.0
13:15-13:30		0	0	0	0.0	0	0	0	0.0	0	0	0	0.0
13:30-13:45		0	0	0	0.0	0	0	0	0.0	0	0	0	0.0
13:45-14:00		0	0	0	0.0	0	0	0	0.0	0	0	0	0.0
1時間計		0	0	0	0.0	0	0	0	0.0	0	0	0	0.0
14:00-14:15		0	0	0	0.0	0	0	0	0.0	0	0	0	0.0
14:15-14:30		1	0	1	1.7	0	1	1	2.2	1	1	2	1.9
14:30-14:45		1	0	1	1.7	1	1	2	4.4	2	1	3	2.9
14:45-15:00		0	0	0	0.0	0	0	0	0.0	0	0	0	0.0
1時間計		2	0	2	3.3	1	2	3	6.7	3	2	5	4.8

歩行者通行量調査表

調査地点：地域社会5

調査年月日：令和元年 5月14日(火) 天候：雨のち曇り



方向	ウ				エ				合計			
	歩行者 (人)	自転車 (台)	合計 (人・台)	時間 係数 (%)	歩行者 (人)	自転車 (台)	合計 (人・台)	時間 係数 (%)	歩行者 (人)	自転車 (台)	合計 (人・台)	時間 係数 (%)
15:00-15:15	0	0	0	0.0	1	0	1	2.2	1	0	1	1.0
15:15-15:30	0	5	5	8.3	4	0	4	8.9	4	5	9	8.6
15:30-15:45	0	0	0	0.0	0	1	1	2.2	0	1	1	1.0
15:45-16:00	0	0	0	0.0	1	0	1	2.2	1	0	1	1.0
1時間計	0	5	5	8.3	6	1	7	15.6	6	6	12	11.4
16:00-16:15	3	1	4	6.7	0	0	0	0.0	3	1	4	3.8
16:15-16:30	0	0	0	0.0	0	2	2	4.4	0	2	2	1.9
16:30-16:45	0	1	1	1.7	0	0	0	0.0	0	1	1	1.0
16:45-17:00	0	1	1	1.7	0	1	1	2.2	0	2	2	1.9
1時間計	3	3	6	10.0	0	3	3	6.7	3	6	9	8.6
17:00-17:15	0	2	2	3.3	0	0	0	0.0	0	2	2	1.9
17:15-17:30	0	0	0	0.0	0	6	6	13.3	0	6	6	5.7
17:30-17:45	1	0	1	1.7	0	3	3	6.7	1	3	4	3.8
17:45-18:00	0	1	1	1.7	1	4	5	11.1	1	5	6	5.7
1時間計	1	3	4	6.7	1	13	14	31.1	2	16	18	17.1
18:00-18:15	0	0	0	0.0	0	0	0	0.0	0	0	0	0.0
18:15-18:30	0	0	0	0.0	0	1	1	2.2	0	1	1	1.0
18:30-18:45	0	0	0	0.0	0	0	0	0.0	0	0	0	0.0
18:45-19:00	0	1	1	1.7	0	0	0	0.0	0	1	1	1.0
1時間計	0	1	1	1.7	0	1	1	2.2	0	2	2	1.9
昼12時間計	9	36	45	75.0	8	27	35	77.8	17	63	80	76.2
19:00-19:15	0	0	0	0.0	0	0	0	0.0	0	0	0	0.0
19:15-19:30	0	0	0	0.0	1	0	1	2.2	1	0	1	1.0
19:30-19:45	0	0	0	0.0	1	0	1	2.2	1	0	1	1.0
19:45-20:00	0	0	0	0.0	0	0	0	0.0	0	0	0	0.0
1時間計	0	0	0	0.0	2	0	2	4.4	2	0	2	1.9
20:00-20:15	0	0	0	0.0	1	0	1	2.2	1	0	1	1.0
20:15-20:30	0	1	1	1.7	0	1	1	2.2	0	2	2	1.9
20:30-20:45	0	1	1	1.7	0	1	1	2.2	0	2	2	1.9
20:45-21:00	0	0	0	0.0	0	0	0	0.0	0	0	0	0.0
1時間計	0	2	2	3.3	1	2	3	6.7	1	4	5	4.8
21:00-21:15	0	0	0	0.0	0	0	0	0.0	0	0	0	0.0
21:15-21:30	0	4	4	6.7	0	0	0	0.0	0	4	4	3.8
21:30-21:45	0	4	4	6.7	0	0	0	0.0	0	4	4	3.8
21:45-22:00	0	0	0	0.0	0	0	0	0.0	0	0	0	0.0
1時間計	0	8	8	13.3	0	0	0	0.0	0	8	8	7.6
22:00-22:15	0	0	0	0.0	0	0	0	0.0	0	0	0	0.0
22:15-22:30	0	0	0	0.0	0	0	0	0.0	0	0	0	0.0
22:30-22:45	0	0	0	0.0	0	0	0	0.0	0	0	0	0.0
22:45-23:00	0	0	0	0.0	0	0	0	0.0	0	0	0	0.0
1時間計	0	0	0	0.0	0	0	0	0.0	0	0	0	0.0

歩行者通行量調査表

調査地点 地域社会5

調査年月日 令和元年 5月14日(火) 天候 雨のち曇り



時間帯	ウ				エ				合計			
	歩行者 (人)	自転車 (台)	合計 (人・台)	時間 係数 (%)	歩行者 (人)	自転車 (台)	合計 (人・台)	時間 係数 (%)	歩行者 (人)	自転車 (台)	合計 (人・台)	時間 係数 (%)
23:00-23:15	0	0	0	0.0	0	0	0	0.0	0	0	0	0.0
23:15-23:30	0	0	0	0.0	0	0	0	0.0	0	0	0	0.0
23:30-23:45	0	0	0	0.0	0	0	0	0.0	0	0	0	0.0
23:45-24:00	0	0	0	0.0	0	0	0	0.0	0	0	0	0.0
1時間計	0	0	0	0.0	0	0	0	0.0	0	0	0	0.0
0:00-0:15	0	0	0	0.0	0	0	0	0.0	0	0	0	0.0
0:15-0:30	0	0	0	0.0	0	0	0	0.0	0	0	0	0.0
0:30-0:45	0	0	0	0.0	0	0	0	0.0	0	0	0	0.0
0:45-1:00	0	0	0	0.0	0	0	0	0.0	0	0	0	0.0
1時間計	0	0	0	0.0	0	0	0	0.0	0	0	0	0.0
1:00-1:15	0	0	0	0.0	0	0	0	0.0	0	0	0	0.0
1:15-1:30	0	0	0	0.0	0	0	0	0.0	0	0	0	0.0
1:30-1:45	0	0	0	0.0	0	0	0	0.0	0	0	0	0.0
1:45-2:00	0	0	0	0.0	0	0	0	0.0	0	0	0	0.0
1時間計	0	0	0	0.0	0	0	0	0.0	0	0	0	0.0
2:00-2:15	0	0	0	0.0	0	0	0	0.0	0	0	0	0.0
2:15-2:30	0	0	0	0.0	0	0	0	0.0	0	0	0	0.0
2:30-2:45	0	0	0	0.0	0	0	0	0.0	0	0	0	0.0
2:45-3:00	0	0	0	0.0	0	0	0	0.0	0	0	0	0.0
1時間計	0	0	0	0.0	0	0	0	0.0	0	0	0	0.0
3:00-3:15	0	0	0	0.0	0	0	0	0.0	0	0	0	0.0
3:15-3:30	0	0	0	0.0	0	0	0	0.0	0	0	0	0.0
3:30-3:45	0	0	0	0.0	0	0	0	0.0	0	0	0	0.0
3:45-4:00	0	0	0	0.0	0	0	0	0.0	0	0	0	0.0
1時間計	0	0	0	0.0	0	0	0	0.0	0	0	0	0.0
4:00-4:15	0	0	0	0.0	0	0	0	0.0	0	0	0	0.0
4:15-4:30	0	0	0	0.0	0	0	0	0.0	0	0	0	0.0
4:30-4:45	0	0	0	0.0	0	0	0	0.0	0	0	0	0.0
4:45-5:00	0	0	0	0.0	0	0	0	0.0	0	0	0	0.0
1時間計	0	0	0	0.0	0	0	0	0.0	0	0	0	0.0
5:00-5:15	1	0	1	1.7	0	0	0	0.0	1	0	1	1.0
5:15-5:30	0	0	0	0.0	0	1	1	2.2	0	1	1	1.0
5:30-5:45	2	0	2	3.3	0	0	0	0.0	2	0	2	1.9
5:45-6:00	0	0	0	0.0	0	0	0	0.0	0	0	0	0.0
1時間計	3	0	3	5.0	0	1	1	2.2	3	1	4	3.8
6:00-6:15	1	0	1	1.7	0	0	0	0.0	1	0	1	1.0
6:15-6:30	0	0	0	0.0	0	1	1	2.2	0	1	1	1.0
6:30-6:45	1	0	1	1.7	2	0	2	4.4	3	0	3	2.9
6:45-7:00	0	0	0	0.0	0	1	1	2.2	0	1	1	1.0
1時間計	2	0	2	3.3	2	2	4	8.9	4	2	6	5.7
夜12時間計	5	10	15	25.0	5	5	10	22.2	10	15	25	23.8
全時間合計	14	46	60	100.0	13	32	45	100.0	27	78	105	100.0
昼夜平均	1.56	1.28	1.33	-	1.63	1.19	1.29	-	1.59	1.24	1.31	-

歩行者通行量調査表

調査地点 地域社会5

調査年月日 令和元年 5月14日(火) 天候 雨のち曇り



時間帯	種別	方向				合計							
		歩行者 (人)	自転車 (台)	合計 (人・台)	時間 係数 (%)	歩行者 (人)	自転車 (台)	合計 (人・台)	時間 係数 (%)	歩行者 (人)	自転車 (台)	合計 (人・台)	時間 係数 (%)
7:00-7:15		0	1	1	0.9	0	1	1	0.5	0	2	2	0.7
7:15-7:30		0	0	0	0.0	0	1	1	0.5	0	1	1	0.3
7:30-7:45		0	0	0	0.0	0	0	0	0.0	0	0	0	0.0
7:45-8:00		0	1	1	0.9	0	1	1	0.5	0	2	2	0.7
1時間計		0	2	2	1.9	0	3	3	1.6	0	5	5	1.7
8:00-8:15		1	4	5	4.6	0	0	0	0.0	1	4	5	1.7
8:15-8:30		0	2	2	1.9	0	1	1	0.5	0	3	3	1.0
8:30-8:45		1	1	2	1.9	0	0	0	0.0	1	1	2	0.7
8:45-9:00		0	1	1	0.9	1	0	1	0.5	1	1	2	0.7
1時間計		2	8	10	9.3	1	1	2	1.1	3	9	12	4.0
9:00-9:15		0	1	1	0.9	1	0	1	0.5	1	1	2	0.7
9:15-9:30		0	1	1	0.9	0	1	1	0.5	0	2	2	0.7
9:30-9:45		1	0	1	0.9	0	0	0	0.0	1	0	1	0.3
9:45-10:00		2	1	3	2.8	0	1	1	0.5	2	2	4	1.3
1時間計		3	3	6	5.6	1	2	3	1.6	4	5	9	3.0
10:00-10:15		1	0	1	0.9	0	0	0	0.0	1	0	1	0.3
10:15-10:30		0	0	0	0.0	1	2	3	1.6	1	2	3	1.0
10:30-10:45		0	0	0	0.0	0	0	0	0.0	0	0	0	0.0
10:45-11:00		0	0	0	0.0	1	0	1	0.5	1	0	1	0.3
1時間計		1	0	1	0.9	2	2	4	2.1	3	2	5	1.7
11:00-11:15		0	0	0	0.0	1	0	1	0.5	1	0	1	0.3
11:15-11:30		0	0	0	0.0	0	0	0	0.0	0	0	0	0.0
11:30-11:45		0	0	0	0.0	1	1	2	1.1	1	1	2	0.7
11:45-12:00		0	0	0	0.0	1	1	2	1.1	1	1	2	0.7
1時間計		0	0	0	0.0	3	2	5	2.6	3	2	5	1.7
12:00-12:15		0	0	0	0.0	1	0	1	0.5	1	0	1	0.3
12:15-12:30		0	0	0	0.0	1	0	1	0.5	1	0	1	0.3
12:30-12:45		0	0	0	0.0	0	0	0	0.0	0	0	0	0.0
12:45-13:00		0	1	1	0.9	0	0	0	0.0	0	1	1	0.3
1時間計		0	1	1	0.9	2	0	2	1.1	2	1	3	1.0
13:00-13:15		0	0	0	0.0	0	0	0	0.0	0	0	0	0.0
13:15-13:30		0	0	0	0.0	0	0	0	0.0	0	0	0	0.0
13:30-13:45		0	1	1	0.9	0	0	0	0.0	0	1	1	0.3
13:45-14:00		0	0	0	0.0	0	0	0	0.0	0	0	0	0.0
1時間計		0	1	1	0.9	0	0	0	0.0	0	1	1	0.3
14:00-14:15		1	1	2	1.9	0	2	2	1.1	1	3	4	1.3
14:15-14:30		0	0	0	0.0	0	3	3	1.6	0	3	3	1.0
14:30-14:45		0	0	0	0.0	0	3	3	1.6	0	3	3	1.0
14:45-15:00		1	1	2	1.9	0	3	3	1.6	1	4	5	1.7
1時間計		2	2	4	3.7	0	11	11	5.8	2	13	15	5.1

歩行者通行量調査表

調査地点 地域社会5

調査年月日 令和元年 5月14日(火) 天候 雨のち曇り



時間帯	方向				方向				合計			
	歩行者 (人)	自転車 (台)	合計 (人・台)	時間 係数 (%)	歩行者 (人)	自転車 (台)	合計 (人・台)	時間 係数 (%)	歩行者 (人)	自転車 (台)	合計 (人・台)	時間 係数 (%)
15.00-15:15	0	3	3	2.8	0	0	0	0.0	0	3	3	1.0
15.15-15:30	0	1	1	0.9	0	3	3	1.6	0	4	4	1.3
15.30-15:45	0	2	2	1.9	0	0	0	0.0	0	2	2	0.7
15.45-16:00	1	2	3	2.8	1	4	5	2.6	2	6	8	2.7
1時間計	1	8	9	8.3	1	7	8	4.2	2	15	17	5.7
16.00-16:15	5	0	5	4.6	2	1	3	1.6	7	1	8	2.7
16.15-16:30	2	5	7	6.5	1	6	7	3.7	3	11	14	4.7
16.30-16:45	1	0	1	0.9	1	2	3	1.6	2	2	4	1.3
16.45-17:00	0	2	2	1.9	0	2	2	1.1	0	4	4	1.3
1時間計	8	7	15	13.9	4	11	15	7.9	12	18	30	10.1
17.00-17:15	2	0	2	1.9	1	4	5	2.6	3	4	7	2.4
17.15-17:30	0	0	0	0.0	2	11	13	6.9	2	11	13	4.4
17.30-17:45	0	2	2	1.9	0	5	5	2.6	0	7	7	2.4
17.45-18:00	3	0	3	2.8	1	9	10	5.3	4	9	13	4.4
1時間計	5	2	7	6.5	4	29	33	17.5	9	31	40	13.5
18.00-18:15	0	1	1	0.9	0	0	0	0.0	0	1	1	0.3
18.15-18:30	3	1	4	3.7	4	1	5	2.6	7	2	9	3.0
18.30-18:45	0	0	0	0.0	2	2	4	2.1	2	2	4	1.3
18.45-19:00	0	0	0	0.0	2	3	5	2.6	2	3	5	1.7
1時間計	3	2	5	4.6	8	6	14	7.4	11	8	19	6.4
昼12時間計	25	36	61	56.5	26	74	100	52.9	51	110	161	54.2
19.00-19:15	0	0	0	0.0	0	1	1	0.5	0	1	1	0.3
19.15-19:30	0	0	0	0.0	0	4	4	2.1	0	4	4	1.3
19.30-19:45	0	0	0	0.0	0	3	3	1.6	0	3	3	1.0
19.45-20:00	0	1	1	0.9	0	3	3	1.6	0	4	4	1.3
1時間計	0	1	1	0.9	0	11	11	5.8	0	12	12	4.0
20.00-20:15	0	3	3	2.8	0	0	0	0.0	0	3	3	1.0
20.15-20:30	3	2	5	4.6	2	1	3	1.6	5	3	8	2.7
20.30-20:45	1	2	3	2.8	0	1	1	0.5	1	3	4	1.3
20.45-21:00	0	0	0	0.0	1	1	2	1.1	1	1	2	0.7
1時間計	4	7	11	10.2	3	3	6	3.2	7	10	17	5.7
21.00-21:15	0	0	0	0.0	1	3	4	2.1	1	3	4	1.3
21.15-21:30	0	1	1	0.9	0	5	5	2.6	0	6	6	2.0
21.30-21:45	0	3	3	2.8	0	7	7	3.7	0	10	10	3.4
21.45-22:00	0	0	0	0.0	0	3	3	1.6	0	3	3	1.0
1時間計	0	4	4	3.7	1	18	19	10.1	1	22	23	7.7
22.00-22:15	0	0	0	0.0	0	5	5	2.6	0	5	5	1.7
22.15-22:30	0	1	1	0.9	0	0	0	0.0	0	1	1	0.3
22.30-22:45	0	0	0	0.0	1	1	2	1.1	1	1	2	0.7
22.45-23:00	0	0	0	0.0	0	0	0	0.0	0	0	0	0.0
1時間計	0	1	1	0.9	1	6	7	3.7	1	7	8	2.7

歩行者通行量調査表

調査地点 地域社会5

調査年月日 令和元年 5月14日(火) 天候 雨のち曇り



時間帯	方向				方向				合計			
	歩行者 (人)	自転車 (台)	合計 (人・台)	時間 係数 (%)	歩行者 (人)	自転車 (台)	合計 (人・台)	時間 係数 (%)	歩行者 (人)	自転車 (台)	合計 (人・台)	時間 係数 (%)
23:00-23:15	0	0	0	0.0	0	0	0	0.0	0	0	0	0.0
23:15-23:30	0	2	2	1.9	0	0	0	0.0	0	2	2	0.7
23:30-23:45	0	0	0	0.0	0	0	0	0.0	0	0	0	0.0
23:45-24:00	0	0	0	0.0	0	0	0	0.0	0	0	0	0.0
1時間計	0	2	2	1.9	0	0	0	0.0	0	2	2	0.7
0:00-0:15	0	0	0	0.0	0	0	0	0.0	0	0	0	0.0
0:15-0:30	0	0	0	0.0	0	0	0	0.0	0	0	0	0.0
0:30-0:45	0	0	0	0.0	0	0	0	0.0	0	0	0	0.0
0:45-1:00	0	0	0	0.0	0	0	0	0.0	0	0	0	0.0
1時間計	0	0	0	0.0	0	0	0	0.0	0	0	0	0.0
1:00-1:15	0	0	0	0.0	0	0	0	0.0	0	0	0	0.0
1:15-1:30	0	0	0	0.0	0	0	0	0.0	0	0	0	0.0
1:30-1:45	0	0	0	0.0	0	0	0	0.0	0	0	0	0.0
1:45-2:00	0	0	0	0.0	0	0	0	0.0	0	0	0	0.0
1時間計	0	0	0	0.0	0	0	0	0.0	0	0	0	0.0
2:00-2:15	0	1	1	0.9	0	0	0	0.0	0	1	1	0.3
2:15-2:30	0	0	0	0.0	0	0	0	0.0	0	0	0	0.0
2:30-2:45	0	0	0	0.0	0	0	0	0.0	0	0	0	0.0
2:45-3:00	1	0	1	0.9	0	0	0	0.0	1	0	1	0.3
1時間計	1	1	2	1.9	0	0	0	0.0	1	1	2	0.7
3:00-3:15	1	0	1	0.9	0	0	0	0.0	1	0	1	0.3
3:15-3:30	0	0	0	0.0	0	0	0	0.0	0	0	0	0.0
3:30-3:45	0	0	0	0.0	1	0	1	0.5	1	0	1	0.3
3:45-4:00	0	0	0	0.0	0	0	0	0.0	0	0	0	0.0
1時間計	1	0	1	0.9	1	0	1	0.5	2	0	2	0.7
4:00-4:15	1	0	1	0.9	1	0	1	0.5	2	0	2	0.7
4:15-4:30	0	0	0	0.0	1	0	1	0.5	1	0	1	0.3
4:30-4:45	0	0	0	0.0	1	0	1	0.5	1	0	1	0.3
4:45-5:00	0	0	0	0.0	1	0	1	0.5	1	0	1	0.3
1時間計	1	0	1	0.9	4	0	4	2.1	5	0	5	1.7
5:00-5:15	2	0	2	1.9	1	2	3	1.6	3	2	5	1.7
5:15-5:30	1	1	2	1.9	0	0	0	0.0	1	1	2	0.7
5:30-5:45	4	2	6	5.6	2	3	5	2.6	6	5	11	3.7
5:45-6:00	2	1	3	2.8	4	2	6	3.2	6	3	9	3.0
1時間計	9	4	13	12.0	7	7	14	7.4	16	11	27	9.1
6:00-6:15	2	0	2	1.9	4	2	6	3.2	6	2	8	2.7
6:15-6:30	1	2	3	2.8	4	2	6	3.2	5	4	9	3.0
6:30-6:45	1	3	4	3.7	4	7	11	5.8	5	10	15	5.1
6:45-7:00	0	2	2	1.9	1	3	4	2.1	1	5	6	2.0
1時間計	4	7	11	10.2	13	14	27	14.3	17	21	38	12.8
夜12時間計	20	27	47	43.5	30	59	89	47.1	50	86	136	45.8
全時間合計	45	63	108	100.0	56	133	189	100.0	101	196	297	100.0
昼夜平均	1.80	1.75	1.77	-	2.15	1.80	1.89	-	1.98	1.78	1.84	-

歩行者通行量調査表

調査地点 地域社会5

調査年月日 令和元年 5月14日(火) 天候 雨のち曇り

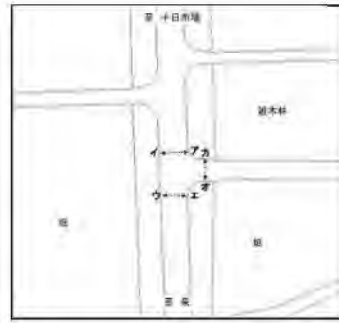

時間帯	方向 種別	合計 (7+イ+ウ+エ+カ)			時間 係数 (%)
		歩行者 (人)	自転車 (台)	合計 (人・台)	
7:00-7:15		0	4	4	0.9
7:15-7:30		0	3	3	0.7
7:30-7:45		0	5	5	1.1
7:45-8:00		0	5	5	1.1
1時間計		0	17	17	3.8
8:00-8:15		2	8	10	2.2
8:15-8:30		0	11	11	2.5
8:30-8:45		1	7	8	1.8
8:45-9:00		1	3	4	0.9
1時間計		4	29	33	7.4
9:00-9:15		2	2	4	0.9
9:15-9:30		0	4	4	0.9
9:30-9:45		1	4	5	1.1
9:45-10:00		2	5	7	1.6
1時間計		5	15	20	4.5
10:00-10:15		1	0	1	0.2
10:15-10:30		1	2	3	0.7
10:30-10:45		0	0	0	0.0
10:45-11:00		1	0	1	0.2
1時間計		3	2	5	1.1
11:00-11:15		2	0	2	0.4
11:15-11:30		1	0	1	0.2
11:30-11:45		1	2	3	0.7
11:45-12:00		1	1	2	0.4
1時間計		5	3	8	1.8
12:00-12:15		1	2	3	0.7
12:15-12:30		1	0	1	0.2
12:30-12:45		0	0	0	0.0
12:45-13:00		1	1	2	0.4
1時間計		3	3	6	1.3
13:00-13:15		0	1	1	0.2
13:15-13:30		0	0	0	0.0
13:30-13:45		0	2	2	0.4
13:45-14:00		0	0	0	0.0
1時間計		0	3	3	0.7
14:00-14:15		1	3	4	0.9
14:15-14:30		1	4	5	1.1
14:30-14:45		2	6	8	1.8
14:45-15:00		1	4	5	1.1
1時間計		5	17	22	4.9
15:00-15:15		1	4	5	1.1
15:15-15:30		4	9	13	2.9
15:30-15:45		0	3	3	0.7
15:45-16:00		4	6	10	2.2
1時間計		9	22	31	7.0
16:00-16:15		10	2	12	2.7
16:15-16:30		3	13	16	3.6
16:30-16:45		2	3	5	1.1
16:45-17:00		0	6	6	1.3
1時間計		15	24	39	8.7
17:00-17:15		3	6	9	2.0
17:15-17:30		2	19	21	4.7
17:30-17:45		1	11	12	2.7
17:45-18:00		5	15	20	4.5
1時間計		11	51	62	13.9
18:00-18:15		1	1	2	0.4
18:15-18:30		8	4	12	2.7
18:30-18:45		2	5	7	1.6
18:45-19:00		2	4	6	1.3
1時間計		13	14	27	6.1
昼12時間計		73	200	273	61.2

時間帯	方向 種別	合計 (7+イ+ウ+エ+カ)			時間 係数 (%)
		歩行者 (人)	自転車 (台)	合計 (人・台)	
7:00-8:00		0	17	17	3.8
7:15-8:15		2	21	23	5.2
7:30-8:30		2	29	31	7.0
7:45-8:45		3	31	34	7.6
8:00-9:00		4	29	33	7.4
8:15-9:15		4	23	27	6.1
8:30-9:30		4	16	20	4.5
8:45-9:45		4	13	17	3.8
9:00-10:00		5	15	20	4.5
9:15-10:15		4	13	17	3.8
9:30-10:30		5	11	16	3.6
9:45-10:45		4	7	11	2.5
10:00-11:00		3	2	5	1.1
10:15-11:15		4	2	6	1.3
10:30-11:30		4	0	4	0.9
10:45-11:45		5	2	7	1.6
11:00-12:00		5	3	8	1.8
11:15-12:15		4	5	9	2.0
11:30-12:30		4	5	9	2.0
11:45-12:45		3	3	6	1.3
12:00-13:00		3	3	6	1.3
12:15-13:15		2	2	4	0.9
12:30-13:30		1	2	3	0.7
12:45-13:45		1	4	5	1.1
13:00-14:00		0	3	3	0.7
13:15-14:15		1	5	6	1.3
13:30-14:30		2	9	11	2.5
13:45-14:45		4	13	17	3.8
14:00-15:00		5	17	22	4.9
14:15-15:15		5	18	23	5.2
14:30-15:30		8	23	31	7.0
14:45-15:45		6	20	26	5.8
15:00-16:00		9	22	31	7.0
15:15-16:15		18	20	38	8.5
15:30-16:30		17	24	41	9.2
15:45-16:45		19	24	43	9.6
16:00-17:00		15	24	39	8.7
16:15-17:15		8	28	36	8.1
16:30-17:30		7	34	41	9.2
16:45-17:45		6	42	48	10.8
17:00-18:00		11	51	62	13.9
17:15-18:15		9	46	55	12.3
17:30-18:30		15	31	46	10.3
17:45-18:45		16	25	41	9.2
18:00-19:00		13	14	27	6.1
18:15-19:15		12	14	26	5.8
18:30-19:30		6	14	20	4.5
18:45-19:45		5	12	17	3.8
19:00-20:00		3	12	15	3.4
19:15-20:15		4	14	18	4.0
19:30-20:30		7	15	22	4.9
19:45-20:45		7	21	28	6.3
20:00-21:00		8	18	26	5.8
20:15-21:15		8	18	26	5.8
20:30-21:30		3	23	26	5.8
20:45-21:45		2	28	30	6.7
21:00-22:00		1	30	31	7.0
21:15-22:15		0	32	32	7.2
21:30-22:30		0	24	24	5.4
21:45-22:45		2	11	13	2.9
22:00-23:00		2	8	10	2.2

歩行者通行量調査表

調査地点 地域社会5

調査年月日 令和元年 5月14日(火) 天候 雨のち曇り

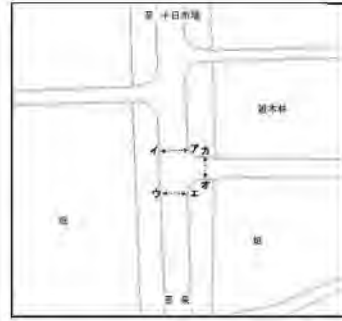

時間帯	種別	方向 合計 (7+イ+ウ+エ+カ)			
		歩行者 (人)	自転車 (台)	合計 (人・台)	時係数 (%)
19:00-19:15		0	1	1	0.2
19:15-19:30		2	4	6	1.3
19:30-19:45		1	3	4	0.9
19:45-20:00		0	4	4	0.9
1時間計		3	12	15	3.4
20:00-20:15		1	3	4	0.9
20:15-20:30		5	5	10	2.2
20:30-20:45		1	9	10	2.2
20:45-21:00		1	1	2	0.4
1時間計		8	18	26	5.8
21:00-21:15		1	3	4	0.9
21:15-21:30		0	10	10	2.2
21:30-21:45		0	14	14	3.1
21:45-22:00		0	3	3	0.7
1時間計		1	30	31	7.0
22:00-22:15		0	5	5	1.1
22:15-22:30		0	2	2	0.4
22:30-22:45		2	1	3	0.7
22:45-23:00		0	0	0	0.0
1時間計		2	8	10	2.2
23:00-23:15		0	0	0	0.0
23:15-23:30		0	2	2	0.4
23:30-23:45		0	0	0	0.0
23:45-24:00		0	0	0	0.0
1時間計		0	2	2	0.4
0:00-0:15		0	0	0	0.0
0:15-0:30		0	0	0	0.0
0:30-0:45		0	0	0	0.0
0:45-1:00		0	0	0	0.0
1時間計		0	0	0	0.0
1:00-1:15		0	0	0	0.0
1:15-1:30		0	0	0	0.0
1:30-1:45		0	0	0	0.0
1:45-2:00		0	0	0	0.0
1時間計		0	0	0	0.0
2:00-2:15		0	1	1	0.2
2:15-2:30		0	0	0	0.0
2:30-2:45		0	0	0	0.0
2:45-3:00		1	0	1	0.2
1時間計		1	1	2	0.4
3:00-3:15		1	0	1	0.2
3:15-3:30		0	0	0	0.0
3:30-3:45		1	0	1	0.2
3:45-4:00		0	0	0	0.0
1時間計		2	0	2	0.4
4:00-4:15		2	0	2	0.4
4:15-4:30		1	0	1	0.2
4:30-4:45		1	0	1	0.2
4:45-5:00		1	0	1	0.2
1時間計		5	0	5	1.1
5:00-5:15		4	2	6	1.3
5:15-5:30		1	2	3	0.7
5:30-5:45		8	5	13	2.9
5:45-6:00		7	3	10	2.2
1時間計		20	12	32	7.2
6:00-6:15		8	2	10	2.2
6:15-6:30		7	6	13	2.9
6:30-6:45		8	10	18	4.0
6:45-7:00		1	6	7	1.6
1時間計		24	24	48	10.8
夜12時間計		66	107	173	38.8
全時間合計		139	307	446	100.0
昼夜率		1.90	1.54	1.63	-

時間帯	種別	方向 合計 (7+イ+ウ+エ+カ)			
		歩行者 (人)	自転車 (台)	合計 (人・台)	時係数 (%)
22:15-23:15		2	3	5	1.1
22:30-23:30		2	3	5	1.1
22:45-23:45		0	2	2	0.4
23:00-0:00		0	2	2	0.4
23:15-0:15		0	2	2	0.4
23:30-0:30		0	0	0	0.0
23:45-0:45		0	0	0	0.0
0:00-1:00		0	0	0	0.0
0:15-1:15		0	0	0	0.0
0:30-1:30		0	0	0	0.0
0:45-1:45		0	0	0	0.0
1:00-2:00		0	0	0	0.0
1:15-2:15		0	1	1	0.2
1:30-2:30		0	1	1	0.2
1:45-2:45		0	1	1	0.2
2:00-3:00		1	1	2	0.4
2:15-3:15		2	0	2	0.4
2:30-3:30		2	0	2	0.4
2:45-3:45		3	0	3	0.7
3:00-4:00		2	0	2	0.4
3:15-4:15		3	0	3	0.7
3:30-4:30		4	0	4	0.9
3:45-4:45		4	0	4	0.9
4:00-5:00		5	0	5	1.1
4:15-5:15		7	2	9	2.0
4:30-5:30		7	4	11	2.5
4:45-5:45		14	9	23	5.2
5:00-6:00		20	12	32	7.2
5:15-6:15		24	12	36	8.1
5:30-6:30		30	16	46	10.3
5:45-6:45		30	21	51	11.4
6:00-7:00		24	24	48	10.8
全時間合計		139	307	446	100.0

歩行者通行量調査表

調査地点 地域社会6 瀬谷中学校前

調査年月日 令和元年 5月14日(火) 天候 雨のち曇り



時間帯	方向 7				方向 1				合計			
	歩行者 (人)	自転車 (台)	合計 (人・台)	時間 係数 (%)	歩行者 (人)	自転車 (台)	合計 (人・台)	時間 係数 (%)	歩行者 (人)	自転車 (台)	合計 (人・台)	時間 係数 (%)
7:00-7:15	28	0	28	4.4	9	0	9	0.8	37	0	37	2.1
7:15-7:30	21	0	21	3.3	11	0	11	1.0	32	0	32	1.8
7:30-7:45	22	0	22	3.4	23	0	23	2.0	45	0	45	2.5
7:45-8:00	34	2	36	5.6	67	1	68	5.9	101	3	104	5.8
1時間計	105	2	107	16.7	110	1	111	9.6	215	3	218	12.1
8:00-8:15	31	1	32	5.0	103	1	104	9.0	134	2	136	7.6
8:15-8:30	28	2	30	4.7	79	1	80	6.9	107	3	110	6.1
8:30-8:45	14	0	14	2.2	18	0	18	1.6	32	0	32	1.8
8:45-9:00	7	0	7	1.1	11	0	11	1.0	18	0	18	1.0
1時間計	80	3	83	13.0	211	2	213	18.4	291	5	296	16.5
9:00-9:15	4	0	4	0.6	5	0	5	0.4	9	0	9	0.5
9:15-9:30	6	0	6	0.9	6	0	6	0.5	12	0	12	0.7
9:30-9:45	6	0	6	0.9	8	0	8	0.7	14	0	14	0.8
9:45-10:00	3	0	3	0.5	6	0	6	0.5	9	0	9	0.5
1時間計	19	0	19	3.0	25	0	25	2.2	44	0	44	2.4
10:00-10:15	2	0	2	0.3	3	0	3	0.3	5	0	5	0.3
10:15-10:30	7	1	8	1.3	7	0	7	0.6	14	1	15	0.8
10:30-10:45	4	1	5	0.8	7	2	9	0.8	11	3	14	0.8
10:45-11:00	4	0	4	0.6	6	0	6	0.5	10	0	10	0.6
1時間計	17	2	19	3.0	23	2	25	2.2	40	4	44	2.4
11:00-11:15	4	0	4	0.6	7	0	7	0.6	11	0	11	0.6
11:15-11:30	3	0	3	0.5	8	0	8	0.7	11	0	11	0.6
11:30-11:45	2	0	2	0.3	6	0	6	0.5	8	0	8	0.4
11:45-12:00	2	0	2	0.3	6	1	7	0.6	8	1	9	0.5
1時間計	11	0	11	1.7	27	1	28	2.4	38	1	39	2.2
12:00-12:15	4	0	4	0.6	10	1	11	1.0	14	1	15	0.8
12:15-12:30	1	1	2	0.3	7	0	7	0.6	8	1	9	0.5
12:30-12:45	2	0	2	0.3	4	0	4	0.3	6	0	6	0.3
12:45-13:00	6	0	6	0.9	4	0	4	0.3	10	0	10	0.6
1時間計	13	1	14	2.2	25	1	26	2.2	38	2	40	2.2
13:00-13:15	1	1	2	0.3	5	0	5	0.4	6	1	7	0.4
13:15-13:30	4	0	4	0.6	3	1	4	0.3	7	1	8	0.4
13:30-13:45	3	2	5	0.8	13	0	13	1.1	16	2	18	1.0
13:45-14:00	1	0	1	0.2	9	1	10	0.9	10	1	11	0.6
1時間計	9	3	12	1.9	30	2	32	2.8	39	5	44	2.4
14:00-14:15	5	1	6	0.9	8	2	10	0.9	13	3	16	0.9
14:15-14:30	0	1	1	0.2	7	1	8	0.7	7	2	9	0.5
14:30-14:45	0	1	1	0.2	11	0	11	1.0	11	1	12	0.7
14:45-15:00	2	1	3	0.5	2	1	3	0.3	4	2	6	0.3
1時間計	7	4	11	1.7	28	4	32	2.8	35	8	43	2.4

歩行者通行量調査表

調査地点 地域社会6 瀬谷中学校前

調査年月日 令和元年 5月14日(火) 天候 雨のち曇り



時間帯	方向 7				方向 1				合計			
	歩行者 (人)	自転車 (台)	合計 (人・台)	時間 係数 (%)	歩行者 (人)	自転車 (台)	合計 (人・台)	時間 係数 (%)	歩行者 (人)	自転車 (台)	合計 (人・台)	時間 係数 (%)
15:00-15:15	9	0	9	1.4	8	2	10	0.9	17	2	19	1.1
15:15-15:30	5	1	6	0.9	6	0	6	0.5	11	1	12	0.7
15:30-15:45	16	1	17	2.7	38	0	38	3.3	54	1	55	3.1
15:45-16:00	42	2	44	6.9	27	1	28	2.4	69	3	72	4.0
1時間計	72	4	76	11.9	79	3	82	7.1	151	7	158	8.8
16:00-16:15	48	2	50	7.8	39	3	42	3.6	87	5	92	5.1
16:15-16:30	9	4	13	2.0	8	2	10	0.9	17	6	23	1.3
16:30-16:45	8	2	10	1.6	13	6	19	1.6	21	8	29	1.6
16:45-17:00	6	4	10	1.6	24	1	25	2.2	30	5	35	1.9
1時間計	71	12	83	13.0	84	12	96	8.3	155	24	179	10.0
17:00-17:15	8	0	8	1.3	11	0	11	1.0	19	0	19	1.1
17:15-17:30	5	2	7	1.1	7	2	9	0.8	12	4	16	0.9
17:30-17:45	5	3	8	1.3	13	2	15	1.3	18	5	23	1.3
17:45-18:00	4	1	5	0.8	35	1	36	3.1	39	2	41	2.3
1時間計	22	6	28	4.4	66	5	71	6.1	88	11	99	5.5
18:00-18:15	5	5	10	1.6	27	2	29	2.5	32	7	39	2.2
18:15-18:30	5	1	6	0.9	18	2	20	1.7	23	3	26	1.4
18:30-18:45	5	3	8	1.3	25	3	28	2.4	30	6	36	2.0
18:45-19:00	7	2	9	1.4	8	1	9	0.8	15	3	18	1.0
1時間計	22	11	33	5.2	78	8	86	7.4	100	19	119	6.6
昼12時間計	448	48	496	77.5	786	41	827	71.5	1234	89	1323	73.6
19:00-19:15	6	4	10	1.6	16	1	17	1.5	22	5	27	1.5
19:15-19:30	3	2	5	0.8	12	2	14	1.2	15	4	19	1.1
19:30-19:45	11	0	11	1.7	24	8	32	2.8	35	8	43	2.4
19:45-20:00	16	0	16	2.5	13	2	15	1.3	29	2	31	1.7
1時間計	36	6	42	6.6	65	13	78	6.7	101	19	120	6.7
20:00-20:15	5	1	6	0.9	16	4	20	1.7	21	5	26	1.4
20:15-20:30	7	2	9	1.4	19	1	20	1.7	26	3	29	1.6
20:30-20:45	5	1	6	0.9	17	4	21	1.8	22	5	27	1.5
20:45-21:00	7	0	7	1.1	14	2	16	1.4	21	2	23	1.3
1時間計	24	4	28	4.4	66	11	77	6.7	90	15	105	5.8
21:00-21:15	0	1	1	0.2	6	1	7	0.6	6	2	8	0.4
21:15-21:30	2	0	2	0.3	26	3	29	2.5	28	3	31	1.7
21:30-21:45	2	1	3	0.5	9	5	14	1.2	11	6	17	0.9
21:45-22:00	1	1	2	0.3	7	1	8	0.7	8	2	10	0.6
1時間計	5	3	8	1.3	48	10	58	5.0	53	13	66	3.7
22:00-22:15	0	0	0	0.0	12	2	14	1.2	12	2	14	0.8
22:15-22:30	2	0	2	0.3	4	2	6	0.5	6	2	8	0.4
22:30-22:45	2	1	3	0.5	19	2	21	1.8	21	3	24	1.3
22:45-23:00	1	0	1	0.2	8	0	8	0.7	9	0	9	0.5
1時間計	5	1	6	0.9	43	6	49	4.2	48	7	55	3.1

歩行者通行量調査表

調査地点 地域社会6 瀬谷中学校前

調査年月日 令和元年 5月14日(火) 天候 雨のち曇り



方向	ア				イ				合計				
	種別	歩行者 (人)	自転車 (台)	合計 (人・台)	時間 係数 (%)	歩行者 (人)	自転車 (台)	合計 (人・台)	時間 係数 (%)	歩行者 (人)	自転車 (台)	合計 (人・台)	時間 係数 (%)
時間帯													
23:00-23:15		0	0	0	0.0	6	0	6	0.5	6	0	6	0.3
23:15-23:30		0	0	0	0.0	8	0	8	0.7	8	0	8	0.4
23:30-23:45		4	0	4	0.6	8	1	9	0.8	12	1	13	0.7
23:45-24:00		0	1	1	0.2	3	0	3	0.3	3	1	4	0.2
1時間計		4	1	5	0.8	25	1	26	2.2	29	2	31	1.7
0:00-0:15		0	0	0	0.0	2	0	2	0.2	2	0	2	0.1
0:15-0:30		1	0	1	0.2	4	0	4	0.3	5	0	5	0.3
0:30-0:45		0	0	0	0.0	3	1	4	0.3	3	1	4	0.2
0:45-1:00		0	0	0	0.0	1	0	1	0.1	1	0	1	0.1
1時間計		1	0	1	0.2	10	1	11	1.0	11	1	12	0.7
1:00-1:15		0	0	0	0.0	0	0	0	0.0	0	0	0	0.0
1:15-1:30		0	0	0	0.0	0	0	0	0.0	0	0	0	0.0
1:30-1:45		1	0	1	0.2	1	1	2	0.2	2	1	3	0.2
1:45-2:00		0	0	0	0.0	0	0	0	0.0	0	0	0	0.0
1時間計		1	0	1	0.2	1	1	2	0.2	2	1	3	0.2
2:00-2:15		0	0	0	0.0	0	0	0	0.0	0	0	0	0.0
2:15-2:30		0	0	0	0.0	0	0	0	0.0	0	0	0	0.0
2:30-2:45		0	0	0	0.0	0	0	0	0.0	0	0	0	0.0
2:45-3:00		0	0	0	0.0	0	0	0	0.0	0	0	0	0.0
1時間計		0	0	0	0.0	0	0	0	0.0	0	0	0	0.0
3:00-3:15		0	0	0	0.0	0	0	0	0.0	0	0	0	0.0
3:15-3:30		0	0	0	0.0	0	0	0	0.0	0	0	0	0.0
3:30-3:45		1	0	1	0.2	0	0	0	0.0	1	0	1	0.1
3:45-4:00		0	0	0	0.0	0	0	0	0.0	0	0	0	0.0
1時間計		1	0	1	0.2	0	0	0	0.0	1	0	1	0.1
4:00-4:15		0	0	0	0.0	0	0	0	0.0	0	0	0	0.0
4:15-4:30		0	0	0	0.0	0	0	0	0.0	0	0	0	0.0
4:30-4:45		0	0	0	0.0	1	0	1	0.1	1	0	1	0.1
4:45-5:00		0	0	0	0.0	0	0	0	0.0	0	0	0	0.0
1時間計		0	0	0	0.0	1	0	1	0.1	1	0	1	0.1
5:00-5:15		0	0	0	0.0	0	0	0	0.0	0	0	0	0.0
5:15-5:30		1	1	2	0.3	1	0	1	0.1	2	1	3	0.2
5:30-5:45		7	2	9	1.4	0	0	0	0.0	7	2	9	0.5
5:45-6:00		3	0	3	0.5	1	0	1	0.1	4	0	4	0.2
1時間計		11	3	14	2.2	2	0	2	0.2	13	3	16	0.9
6:00-6:15		1	1	2	0.3	2	0	2	0.2	3	1	4	0.2
6:15-6:30		4	0	4	0.6	2	0	2	0.2	6	0	6	0.3
6:30-6:45		12	3	15	2.3	8	1	9	0.8	20	4	24	1.3
6:45-7:00		16	1	17	2.7	11	2	13	1.1	27	3	30	1.7
1時間計		33	5	38	5.9	23	3	26	2.2	56	8	64	3.6
夜12時間計		121	23	144	22.5	284	46	330	28.5	405	69	474	26.4
全時間合計		569	71	640	100.0	1070	87	1157	100.0	1639	158	1797	100.0
昼夜平均		1.27	1.48	1.29	-	1.36	2.12	1.40	-	1.33	1.78	1.36	-

歩行者通行量調査表

調査地点 地域社会6 瀬谷中学校前

調査年月日 令和元年 5月14日(火) 天候 雨のち曇り



方向	ウ				エ				合計				
	種別	歩行者 (人)	自転車 (台)	合計 (人・台)	時間 係数 (%)	歩行者 (人)	自転車 (台)	合計 (人・台)	時間 係数 (%)	歩行者 (人)	自転車 (台)	合計 (人・台)	時間 係数 (%)
7:00-7:15		1	0	1	0.1	10	0	10	1.6	11	0	11	0.8
7:15-7:30		2	1	3	0.4	14	4	18	2.8	16	5	21	1.5
7:30-7:45		4	1	5	0.7	24	0	24	3.7	28	1	29	2.1
7:45-8:00		27	1	28	3.9	14	0	14	2.2	41	1	42	3.1
1時間計		34	3	37	5.2	62	4	66	10.2	96	7	103	7.6
8:00-8:15		9	6	15	2.1	19	1	20	3.1	28	7	35	2.6
8:15-8:30		56	7	63	8.8	26	3	29	4.5	82	10	92	6.8
8:30-8:45		4	5	9	1.3	3	2	5	0.8	7	7	14	1.0
8:45-9:00		2	1	3	0.4	1	8	9	1.4	3	9	12	0.9
1時間計		71	19	90	12.6	49	14	63	9.8	120	33	153	11.3
9:00-9:15		1	5	6	0.8	14	1	15	2.3	15	6	21	1.5
9:15-9:30		1	9	10	1.4	16	1	17	2.6	17	10	27	2.0
9:30-9:45		1	1	2	0.3	4	1	5	0.8	5	2	7	0.5
9:45-10:00		2	1	3	0.4	1	0	1	0.2	3	1	4	0.3
1時間計		5	16	21	2.9	35	3	38	5.9	40	19	59	4.3
10:00-10:15		3	1	4	0.6	6	0	6	0.9	9	1	10	0.7
10:15-10:30		7	1	8	1.1	4	0	4	0.6	11	1	12	0.9
10:30-10:45		8	1	9	1.3	15	2	17	2.6	23	3	26	1.9
10:45-11:00		3	0	3	0.4	9	0	9	1.4	12	0	12	0.9
1時間計		21	3	24	3.4	34	2	36	5.6	55	5	60	4.4
11:00-11:15		6	1	7	1.0	10	0	10	1.6	16	1	17	1.3
11:15-11:30		4	0	4	0.6	9	0	9	1.4	13	0	13	1.0
11:30-11:45		5	2	7	1.0	7	1	8	1.2	12	3	15	1.1
11:45-12:00		6	0	6	0.8	3	1	4	0.6	9	1	10	0.7
1時間計		21	3	24	3.4	29	2	31	4.8	50	5	55	4.0
12:00-12:15		3	0	3	0.4	0	1	1	0.2	3	1	4	0.3
12:15-12:30		2	0	2	0.3	3	0	3	0.5	5	0	5	0.4
12:30-12:45		1	1	2	0.3	2	0	2	0.3	3	1	4	0.3
12:45-13:00		4	1	5	0.7	5	0	5	0.8	9	1	10	0.7
1時間計		10	2	12	1.7	10	1	11	1.7	20	3	23	1.7
13:00-13:15		1	0	1	0.1	2	0	2	0.3	3	0	3	0.2
13:15-13:30		0	0	0	0.0	3	0	3	0.5	3	0	3	0.2
13:30-13:45		2	0	2	0.3	0	0	0	0.0	2	0	2	0.1
13:45-14:00		1	0	1	0.1	0	0	0	0.0	1	0	1	0.1
1時間計		4	0	4	0.6	5	0	5	0.8	9	0	9	0.7
14:00-14:15		4	0	4	0.6	3	0	3	0.5	7	0	7	0.5
14:15-14:30		3	2	5	0.7	3	1	4	0.6	6	3	9	0.7
14:30-14:45		2	2	4	0.6	2	0	2	0.3	4	2	6	0.4
14:45-15:00		3	1	4	0.6	4	0	4	0.6	7	1	8	0.6
1時間計		12	5	17	2.4	12	1	13	2.0	24	6	30	2.2

歩行者通行量調査表

調査地点 地域社会6 瀬谷中学校前

調査年月日 令和元年 5月14日(火) 天候 雨のち曇り



方向	ウ				エ				合計			
	歩行者 (人)	自転車 (台)	合計 (人・台)	時間 係数 (%)	歩行者 (人)	自転車 (台)	合計 (人・台)	時間 係数 (%)	歩行者 (人)	自転車 (台)	合計 (人・台)	時間 係数 (%)
15:00-15:15	1	1	2	0.3	5	2	7	1.1	6	3	9	0.7
15:15-15:30	3	3	6	0.8	5	2	7	1.1	8	5	13	1.0
15:30-15:45	7	1	8	1.1	8	2	10	1.6	15	3	18	1.3
15:45-16:00	15	3	18	2.5	37	0	37	5.7	52	3	55	4.0
1時間計	26	8	34	4.8	55	6	61	9.5	81	14	95	7.0
16:00-16:15	21	4	25	3.5	24	2	26	4.0	45	6	51	3.8
16:15-16:30	14	3	17	2.4	20	4	24	3.7	34	7	41	3.0
16:30-16:45	20	7	27	3.8	12	2	14	2.2	32	9	41	3.0
16:45-17:00	11	3	14	2.0	8	2	10	1.6	19	5	24	1.8
1時間計	66	17	83	11.6	64	10	74	11.5	130	27	157	11.6
17:00-17:15	35	0	35	4.9	18	7	25	3.9	53	7	60	4.4
17:15-17:30	18	1	19	2.7	22	0	22	3.4	40	1	41	3.0
17:30-17:45	44	8	52	7.3	15	1	16	2.5	59	9	68	5.0
17:45-18:00	85	2	87	12.2	19	5	24	3.7	104	7	111	8.2
1時間計	182	11	193	27.0	74	13	87	13.5	256	24	280	20.6
18:00-18:15	12	1	13	1.8	7	1	8	1.2	19	2	21	1.5
18:15-18:30	20	3	23	3.2	9	5	14	2.2	29	8	37	2.7
18:30-18:45	3	1	4	0.6	9	3	12	1.9	12	4	16	1.2
18:45-19:00	5	2	7	1.0	1	3	4	0.6	6	5	11	0.8
1時間計	40	7	47	6.6	26	12	38	5.9	66	19	85	6.3
昼12時間計	492	94	586	82.1	455	68	523	81.1	947	162	1109	81.6
19:00-19:15	0	0	0	0.0	2	1	3	0.5	2	1	3	0.2
19:15-19:30	0	0	0	0.0	1	0	1	0.2	1	0	1	0.1
19:30-19:45	3	0	3	0.4	1	1	2	0.3	4	1	5	0.4
19:45-20:00	6	0	6	0.8	0	0	0	0.0	6	0	6	0.4
1時間計	9	0	9	1.3	4	2	6	0.9	13	2	15	1.1
20:00-20:15	8	0	8	1.1	4	1	5	0.8	12	1	13	1.0
20:15-20:30	5	1	6	0.8	2	1	3	0.5	7	2	9	0.7
20:30-20:45	3	1	4	0.6	4	0	4	0.6	7	1	8	0.6
20:45-21:00	5	2	7	1.0	4	0	4	0.6	9	2	11	0.8
1時間計	21	4	25	3.5	14	2	16	2.5	35	6	41	3.0
21:00-21:15	5	3	8	1.1	4	1	5	0.8	9	4	13	1.0
21:15-21:30	5	1	6	0.8	1	3	4	0.6	6	4	10	0.7
21:30-21:45	3	1	4	0.6	3	0	3	0.5	6	1	7	0.5
21:45-22:00	1	1	2	0.3	0	3	3	0.5	1	4	5	0.4
1時間計	14	6	20	2.8	8	7	15	2.3	22	13	35	2.6
22:00-22:15	18	1	19	2.7	1	0	1	0.2	19	1	20	1.5
22:15-22:30	7	1	8	1.1	2	0	2	0.3	9	1	10	0.7
22:30-22:45	3	0	3	0.4	1	0	1	0.2	4	0	4	0.3
22:45-23:00	6	0	6	0.8	0	0	0	0.0	6	0	6	0.4
1時間計	34	2	36	5.0	4	0	4	0.6	38	2	40	2.9

歩行者通行量調査表

調査地点 地域社会6 瀬谷中学校前

調査年月日 令和元年 5月14日(火) 天候 雨のち曇り



方向	ウ				エ				合計				
	種別	歩行者 (人)	自転車 (台)	合計 (人・台)	時間 係数 (%)	歩行者 (人)	自転車 (台)	合計 (人・台)	時間 係数 (%)	歩行者 (人)	自転車 (台)	合計 (人・台)	時間 係数 (%)
時間帯													
23:00-23:15		4	0	4	0.6	1	0	1	0.2	5	0	5	0.4
23:15-23:30		5	0	5	0.7	0	0	0	0.0	5	0	5	0.4
23:30-23:45		2	0	2	0.3	1	0	1	0.2	3	0	3	0.2
23:45-24:00		2	0	2	0.3	0	0	0	0.0	2	0	2	0.1
1時間計		13	0	13	1.8	2	0	2	0.3	15	0	15	1.1
0:00-0:15		1	0	1	0.1	0	0	0	0.0	1	0	1	0.1
0:15-0:30		1	1	2	0.3	0	0	0	0.0	1	1	2	0.1
0:30-0:45		0	0	0	0.0	0	0	0	0.0	0	0	0	0.0
0:45-1:00		1	0	1	0.1	1	0	1	0.2	2	0	2	0.1
1時間計		3	1	4	0.6	1	0	1	0.2	4	1	5	0.4
1:00-1:15		1	0	1	0.1	0	0	0	0.0	1	0	1	0.1
1:15-1:30		1	1	2	0.3	0	0	0	0.0	1	1	2	0.1
1:30-1:45		1	0	1	0.1	0	0	0	0.0	1	0	1	0.1
1:45-2:00		0	0	0	0.0	0	0	0	0.0	0	0	0	0.0
1時間計		3	1	4	0.6	0	0	0	0.0	3	1	4	0.3
2:00-2:15		0	0	0	0.0	0	0	0	0.0	0	0	0	0.0
2:15-2:30		0	0	0	0.0	0	0	0	0.0	0	0	0	0.0
2:30-2:45		0	0	0	0.0	0	0	0	0.0	0	0	0	0.0
2:45-3:00		0	0	0	0.0	0	0	0	0.0	0	0	0	0.0
1時間計		0	0	0	0.0	0	0	0	0.0	0	0	0	0.0
3:00-3:15		0	0	0	0.0	0	0	0	0.0	0	0	0	0.0
3:15-3:30		0	0	0	0.0	0	0	0	0.0	0	0	0	0.0
3:30-3:45		0	0	0	0.0	0	0	0	0.0	0	0	0	0.0
3:45-4:00		0	0	0	0.0	0	0	0	0.0	0	0	0	0.0
1時間計		0	0	0	0.0	0	0	0	0.0	0	0	0	0.0
4:00-4:15		0	0	0	0.0	0	0	0	0.0	0	0	0	0.0
4:15-4:30		0	0	0	0.0	0	1	1	0.2	0	1	1	0.1
4:30-4:45		0	0	0	0.0	0	0	0	0.0	0	0	0	0.0
4:45-5:00		0	0	0	0.0	2	0	2	0.3	2	0	2	0.1
1時間計		0	0	0	0.0	2	1	3	0.5	2	1	3	0.2
5:00-5:15		0	0	0	0.0	4	0	4	0.6	4	0	4	0.3
5:15-5:30		0	2	2	0.3	12	0	12	1.9	12	2	14	1.0
5:30-5:45		0	0	0	0.0	11	1	12	1.9	11	1	12	0.9
5:45-6:00		1	0	1	0.1	5	1	6	0.9	6	1	7	0.5
1時間計		1	2	3	0.4	32	2	34	5.3	33	4	37	2.7
6:00-6:15		1	0	1	0.1	2	1	3	0.5	3	1	4	0.3
6:15-6:30		2	0	2	0.3	9	2	11	1.7	11	2	13	1.0
6:30-6:45		7	2	9	1.3	10	2	12	1.9	17	4	21	1.5
6:45-7:00		1	1	2	0.3	12	3	15	2.3	13	4	17	1.3
1時間計		11	3	14	2.0	33	8	41	6.4	44	11	55	4.0
夜12時間計		109	19	128	17.9	100	22	122	18.9	209	41	250	18.4
全時間合計		601	113	714	100.0	555	90	645	100.0	1156	203	1359	100.0
昼夜平均		1.22	1.20	1.22	-	1.22	1.32	1.23	-	1.22	1.25	1.23	-

歩行者通行量調査表

調査地点 地域社会6 瀬谷中学校前

調査年月日 令和元年 5月14日(火) 天候 雨のち曇り



方向	ア				カ				合計				
	種別	歩行者 (人)	自転車 (台)	合計 (人・台)	時間 係数 (%)	歩行者 (人)	自転車 (台)	合計 (人・台)	時間 係数 (%)	歩行者 (人)	自転車 (台)	合計 (人・台)	時間 係数 (%)
7:00-7:15	時間帯	2	0	2	0.2	36	4	40	3.4	38	4	42	3.8
7:15-7:30		3	0	3	0.3	40	1	41	3.4	43	1	44	1.9
7:30-7:45		5	2	7	0.6	48	2	50	4.2	53	4	57	2.5
7:45-8:00		16	0	16	1.5	34	1	35	2.9	50	1	51	2.2
1時間計		26	2	28	2.6	158	8	166	13.9	184	10	194	8.5
8:00-8:15		34	0	34	3.1	61	0	61	5.1	95	0	95	4.2
8:15-8:30		14	1	15	1.4	121	2	123	10.3	135	3	138	6.1
8:30-8:45		6	0	6	0.6	25	1	26	2.2	31	1	32	1.4
8:45-9:00		1	1	2	0.2	22	1	23	1.9	23	2	25	1.1
1時間計		55	2	57	5.3	229	4	233	19.6	284	6	290	12.8
9:00-9:15		2	0	2	0.2	13	2	15	1.3	15	2	17	0.7
9:15-9:30		3	0	3	0.3	9	0	9	0.8	12	0	12	0.5
9:30-9:45		0	2	2	0.2	13	1	14	1.2	13	3	16	0.7
9:45-10:00		3	0	3	0.3	5	2	7	0.6	8	2	10	0.4
1時間計		8	2	10	0.9	40	5	45	3.8	48	7	55	2.4
10:00-10:15		6	2	8	0.7	7	0	7	0.6	13	2	15	0.7
10:15-10:30		7	0	7	0.6	7	2	9	0.8	14	2	16	0.7
10:30-10:45		3	0	3	0.3	11	0	11	0.9	14	0	14	0.6
10:45-11:00		2	0	2	0.2	11	0	11	0.9	13	0	13	0.6
1時間計		18	2	20	1.9	36	2	38	3.2	54	4	58	2.6
11:00-11:15		5	1	6	0.6	10	0	10	0.8	15	1	16	0.7
11:15-11:30		4	0	4	0.4	15	0	15	1.3	19	0	19	0.8
11:30-11:45		6	2	8	0.7	7	1	8	0.7	13	3	16	0.7
11:45-12:00		6	0	6	0.6	3	1	4	0.3	9	1	10	0.4
1時間計		21	3	24	2.2	35	2	37	3.1	56	5	61	2.7
12:00-12:15		8	0	8	0.7	9	1	10	0.8	17	1	18	0.8
12:15-12:30		8	0	8	0.7	7	0	7	0.6	15	0	15	0.7
12:30-12:45		11	0	11	1.0	7	1	8	0.7	18	1	19	0.8
12:45-13:00		7	0	7	0.6	11	0	11	0.9	18	0	18	0.8
1時間計		34	0	34	3.1	34	2	36	3.0	68	2	70	3.1
13:00-13:15		11	2	13	1.2	7	0	7	0.6	18	2	20	0.9
13:15-13:30		8	0	8	0.7	8	2	10	0.8	16	2	18	0.8
13:30-13:45		12	1	13	1.2	5	0	5	0.4	17	1	18	0.8
13:45-14:00		5	0	5	0.5	6	1	7	0.6	11	1	12	0.5
1時間計		36	3	39	3.6	26	3	29	2.4	62	6	68	3.0
14:00-14:15		6	0	6	0.6	8	0	8	0.7	14	0	14	0.6
14:15-14:30		8	3	11	1.0	7	0	7	0.6	15	3	18	0.8
14:30-14:45		4	2	6	0.6	7	1	8	0.7	11	3	14	0.6
14:45-15:00		3	0	3	0.3	12	0	12	1.0	15	0	15	0.7
1時間計		21	5	26	2.4	34	1	35	2.9	55	6	61	2.7

歩行者通行量調査表

調査地点 地域社会6 瀬谷中学校前

調査年月日 令和元年 5月14日(火) 天候 雨のち曇り



方向	ア				イ				合計			
	歩行者 (人)	自転車 (台)	合計 (人・台)	時間 係数 (%)	歩行者 (人)	自転車 (台)	合計 (人・台)	時間 係数 (%)	歩行者 (人)	自転車 (台)	合計 (人・台)	時間 係数 (%)
15:00-15:15	6	5	11	1.0	16	3	19	1.6	22	8	30	1.3
15:15-15:30	12	1	13	1.2	6	5	11	0.9	18	6	24	1.1
15:30-15:45	47	4	51	4.7	10	1	11	0.9	57	5	62	2.7
15:45-16:00	27	1	28	2.6	16	5	21	1.8	43	6	49	2.2
1時間計	92	11	103	9.5	48	14	62	5.2	140	25	165	7.3
16:00-16:15	25	6	31	2.9	26	5	31	2.6	51	11	62	2.7
16:15-16:30	24	6	30	2.8	32	9	41	3.4	56	15	71	3.1
16:30-16:45	24	7	31	2.9	9	3	12	1.0	33	10	43	1.9
16:45-17:00	13	3	16	1.5	13	3	16	1.3	26	6	32	1.4
1時間計	86	22	108	10.0	80	20	100	8.4	166	42	208	9.2
17:00-17:15	34	0	34	3.1	17	7	24	2.0	51	7	58	2.6
17:15-17:30	32	1	33	3.1	16	0	16	1.3	48	1	49	2.2
17:30-17:45	32	7	39	3.6	14	1	15	1.3	46	8	54	2.4
17:45-18:00	88	1	89	8.2	21	6	27	2.3	109	7	116	5.1
1時間計	186	9	195	18.1	68	14	82	6.9	254	23	277	12.2
18:00-18:15	59	1	60	5.6	14	3	17	1.4	73	4	77	3.4
18:15-18:30	22	2	24	2.2	9	3	12	1.0	31	5	36	1.6
18:30-18:45	17	4	21	1.9	15	5	20	1.7	32	9	41	1.8
18:45-19:00	17	1	18	1.7	15	3	18	1.5	32	4	36	1.6
1時間計	115	8	123	11.4	53	14	67	5.6	168	22	190	8.4
昼12時間計	699	69	767	71.0	841	89	930	78.1	1539	158	1697	74.7
19:00-19:15	23	4	27	2.5	8	2	10	0.8	31	6	37	1.6
19:15-19:30	20	0	20	1.9	9	2	11	0.9	29	2	31	1.4
19:30-19:45	18	1	19	1.8	11	1	12	1.0	29	2	31	1.4
19:45-20:00	13	1	14	1.3	6	0	6	0.5	19	1	20	0.9
1時間計	74	6	80	7.4	34	5	39	3.3	108	11	119	5.2
20:00-20:15	17	2	19	1.8	10	0	10	0.8	27	2	29	1.3
20:15-20:30	18	0	18	1.7	6	2	8	0.7	24	2	26	1.1
20:30-20:45	8	0	8	0.7	6	0	6	0.5	14	0	14	0.6
20:45-21:00	20	2	22	2.0	5	0	5	0.4	25	2	27	1.2
1時間計	63	4	67	6.2	27	2	29	2.4	90	6	96	4.2
21:00-21:15	15	0	15	1.4	4	0	4	0.3	19	0	19	0.8
21:15-21:30	15	4	19	1.8	12	1	13	1.1	27	5	32	1.4
21:30-21:45	23	3	26	2.4	6	0	6	0.5	29	3	32	1.4
21:45-22:00	6	2	8	0.7	4	0	4	0.3	10	2	12	0.5
1時間計	59	9	68	6.3	26	1	27	2.3	85	10	95	4.2
22:00-22:15	18	2	20	1.9	5	0	5	0.4	23	2	25	1.1
22:15-22:30	8	2	10	0.9	9	0	9	0.8	17	2	19	0.8
22:30-22:45	4	0	4	0.4	2	0	2	0.2	6	0	6	0.3
22:45-23:00	6	0	6	0.6	0	0	0	0.0	6	0	6	0.3
1時間計	36	4	40	3.7	16	0	16	1.3	52	4	56	2.5

歩行者通行量調査表

調査地点 地域社会6 瀬谷中学校前

調査年月日 令和元年 5月14日(火) 天候 雨のち曇り



方向	ま				か				合計				
	種別	歩行者 (人)	自転車 (台)	合計 (人・台)	時間 係数 (%)	歩行者 (人)	自転車 (台)	合計 (人・台)	時間 係数 (%)	歩行者 (人)	自転車 (台)	合計 (人・台)	時間 係数 (%)
時間帯													
23:00-23:15		3	0	3	0.3	2	0	2	0.2	5	0	5	0.2
23:15-23:30		6	0	6	0.6	0	0	0	0.0	6	0	6	0.3
23:30-23:45		6	1	7	0.6	0	0	0	0.0	6	1	7	0.3
23:45-24:00		7	0	7	0.6	1	0	1	0.1	8	0	8	0.4
1時間計		22	1	23	2.1	3	0	3	0.3	25	1	26	1.1
0:00-0:15		9	0	9	0.8	4	0	4	0.3	13	0	13	0.6
0:15-0:30		2	0	2	0.2	2	1	3	0.3	4	1	5	0.2
0:30-0:45		4	1	5	0.5	0	0	0	0.0	4	1	5	0.2
0:45-1:00		2	0	2	0.2	0	0	0	0.0	2	0	2	0.1
1時間計		17	1	18	1.7	6	1	7	0.6	23	2	25	1.1
1:00-1:15		2	0	2	0.2	0	1	1	0.1	2	1	3	0.1
1:15-1:30		1	0	1	0.1	0	0	0	0.0	1	0	1	0.0
1:30-1:45		0	0	0	0.0	1	0	1	0.1	1	0	1	0.0
1:45-2:00		0	1	1	0.1	0	0	0	0.0	0	1	1	0.0
1時間計		3	1	4	0.4	1	1	2	0.2	4	2	6	0.3
2:00-2:15		1	0	1	0.1	1	0	1	0.1	2	0	2	0.1
2:15-2:30		0	0	0	0.0	1	0	1	0.1	1	0	1	0.0
2:30-2:45		0	0	0	0.0	0	0	0	0.0	0	0	0	0.0
2:45-3:00		0	0	0	0.0	0	0	0	0.0	0	0	0	0.0
1時間計		1	0	1	0.1	2	0	2	0.2	3	0	3	0.1
3:00-3:15		1	1	2	0.2	0	0	0	0.0	1	1	2	0.1
3:15-3:30		0	0	0	0.0	0	0	0	0.0	0	0	0	0.0
3:30-3:45		0	0	0	0.0	0	0	0	0.0	0	0	0	0.0
3:45-4:00		0	0	0	0.0	1	0	1	0.1	1	0	1	0.0
1時間計		1	1	2	0.2	1	0	1	0.1	2	1	3	0.1
4:00-4:15		0	0	0	0.0	1	0	1	0.1	1	0	1	0.0
4:15-4:30		0	0	0	0.0	1	0	1	0.1	1	0	1	0.0
4:30-4:45		0	0	0	0.0	2	0	2	0.2	2	0	2	0.1
4:45-5:00		0	0	0	0.0	1	0	1	0.1	1	0	1	0.0
1時間計		0	0	0	0.0	5	0	5	0.4	5	0	5	0.2
5:00-5:15		0	0	0	0.0	5	0	5	0.4	5	0	5	0.2
5:15-5:30		1	0	1	0.1	4	0	4	0.3	5	0	5	0.2
5:30-5:45		0	0	0	0.0	14	1	15	1.3	14	1	15	0.7
5:45-6:00		0	0	0	0.0	6	1	7	0.6	6	1	7	0.3
1時間計		1	0	1	0.1	29	2	31	2.6	30	2	32	1.4
6:00-6:15		0	1	1	0.1	13	2	15	1.3	13	3	16	0.7
6:15-6:30		2	0	2	0.2	11	2	13	1.1	13	2	15	0.7
6:30-6:45		1	0	1	0.1	29	1	30	2.5	30	1	31	1.4
6:45-7:00		3	2	5	0.5	38	3	41	3.4	41	5	46	2.0
1時間計		6	3	9	0.8	91	8	99	8.3	97	11	108	4.8
夜12時間計		283	30	313	29.0	241	20	261	21.9	524	50	574	25.3
全時間合計		981	99	1080	100.0	1082	109	1191	100.0	2063	208	2271	100.0
昼夜平均		1.41	1.43	1.41	-	1.29	1.22	1.28	-	1.34	1.32	1.34	-

歩行者通行量調査表

調査地点 地域社会6 瀬谷中学校前

調査年月日 令和元年 5月14日(火) 天候 雨のち曇り



方向	キ				ク				合計				
	種別	歩行者 (人)	自転車 (台)	合計 (人・台)	時間 係数 (%)	歩行者 (人)	自転車 (台)	合計 (人・台)	時間 係数 (%)	歩行者 (人)	自転車 (台)	合計 (人・台)	時間 係数 (%)
7:00-7:15	時間帯	31	3	34	2.1	3	2	5	0.4	34	5	39	1.4
7:15-7:30		60	3	63	3.8	16	2	18	1.6	76	5	81	2.9
7:30-7:45		51	4	55	3.3	6	3	9	0.8	57	7	64	2.3
7:45-8:00		57	7	64	3.9	66	1	67	5.8	123	8	131	4.7
1時間計		199	17	216	13.1	91	8	99	8.5	290	25	315	11.2
8:00-8:15		104	2	106	6.4	204	5	209	18.0	308	7	315	11.2
8:15-8:30		144	5	149	9.0	74	1	75	6.5	218	6	224	8.0
8:30-8:45		19	4	23	1.4	13	5	18	1.6	32	9	41	1.5
8:45-9:00		16	0	16	1.0	5	1	6	0.5	21	1	22	0.8
1時間計		283	11	294	17.8	296	12	308	26.6	579	23	602	21.4
9:00-9:15		6	0	6	0.4	0	0	0	0.0	6	0	6	0.2
9:15-9:30		8	0	8	0.5	5	0	5	0.4	13	0	13	0.5
9:30-9:45		7	0	7	0.4	5	2	7	0.6	12	2	14	0.5
9:45-10:00		12	2	14	0.8	2	1	3	0.3	14	3	17	0.6
1時間計		33	2	35	2.1	12	3	15	1.3	45	5	50	1.8
10:00-10:15		11	1	12	0.7	4	0	4	0.3	15	1	16	0.6
10:15-10:30		11	1	12	0.7	1	3	4	0.3	12	4	16	0.6
10:30-10:45		7	0	7	0.4	6	1	7	0.6	13	1	14	0.5
10:45-11:00		9	1	10	0.6	5	0	5	0.4	14	1	15	0.5
1時間計		38	3	41	2.5	16	4	20	1.7	54	7	61	2.2
11:00-11:15		4	1	5	0.3	1	0	1	0.1	5	1	6	0.2
11:15-11:30		5	0	5	0.3	5	0	5	0.4	10	0	10	0.4
11:30-11:45		7	0	7	0.4	3	0	3	0.3	10	0	10	0.4
11:45-12:00		4	0	4	0.2	5	0	5	0.4	9	0	9	0.3
1時間計		20	1	21	1.3	14	0	14	1.2	34	1	35	1.2
12:00-12:15		5	1	6	0.4	6	0	6	0.5	11	1	12	0.4
12:15-12:30		4	0	4	0.2	2	1	3	0.3	6	1	7	0.2
12:30-12:45		7	0	7	0.4	2	6	8	0.7	9	6	15	0.5
12:45-13:00		6	1	7	0.4	4	1	5	0.4	10	2	12	0.4
1時間計		22	2	24	1.5	14	8	22	1.9	36	10	46	1.6
13:00-13:15		4	2	6	0.4	5	1	6	0.5	9	3	12	0.4
13:15-13:30		8	1	9	0.5	1	1	2	0.2	9	2	11	0.4
13:30-13:45		8	1	9	0.5	11	0	11	0.9	19	1	20	0.7
13:45-14:00		6	0	6	0.4	3	2	5	0.4	9	2	11	0.4
1時間計		26	4	30	1.8	20	4	24	2.1	46	8	54	1.9
14:00-14:15		6	4	10	0.6	6	1	7	0.6	12	5	17	0.6
14:15-14:30		3	2	5	0.3	5	1	6	0.5	8	3	11	0.4
14:30-14:45		8	3	11	0.7	6	1	7	0.6	14	4	18	0.6
14:45-15:00		4	3	7	0.4	2	2	4	0.3	6	5	11	0.4
1時間計		21	12	33	2.0	19	5	24	2.1	40	17	57	2.0

歩行者通行量調査表

調査地点 地域社会6 瀬谷中学校前

調査年月日 令和元年 5月14日(火) 天候 雨のち曇り



方向	キ				ク				合計			
	歩行者 (人)	自転車 (台)	合計 (人・台)	時間 係数 (%)	歩行者 (人)	自転車 (台)	合計 (人・台)	時間 係数 (%)	歩行者 (人)	自転車 (台)	合計 (人・台)	時間 係数 (%)
時間帯												
15:00-15:15	8	2	10	0.6	6	2	8	0.7	14	4	18	0.6
15:15-15:30	20	1	21	1.3	7	2	9	0.8	27	3	30	1.1
15:30-15:45	40	8	48	2.9	44	1	45	3.9	84	9	93	3.3
15:45-16:00	154	6	160	9.7	63	1	64	5.5	217	7	224	8.0
1時間計	222	17	239	14.4	120	6	126	10.9	342	23	365	13.0
16:00-16:15	46	3	49	3.0	17	2	19	1.6	63	5	68	2.4
16:15-16:30	24	7	31	1.9	7	6	13	1.1	31	13	44	1.6
16:30-16:45	45	9	54	3.3	18	6	24	2.1	63	15	78	2.8
16:45-17:00	22	3	25	1.5	16	5	21	1.8	38	8	46	1.6
1時間計	137	22	159	9.6	58	19	77	6.6	195	41	236	8.4
17:00-17:15	17	3	20	1.2	14	6	20	1.7	31	9	40	1.4
17:15-17:30	26	6	32	1.9	13	3	16	1.4	39	9	48	1.7
17:30-17:45	24	6	30	1.8	25	1	26	2.2	49	7	56	2.0
17:45-18:00	13	4	17	1.0	26	7	33	2.8	39	11	50	1.8
1時間計	80	19	99	6.0	78	17	95	8.2	158	36	194	6.9
18:00-18:15	12	2	14	0.8	52	6	58	5.0	64	8	72	2.6
18:15-18:30	19	2	21	1.3	15	4	19	1.6	34	6	40	1.4
18:30-18:45	15	9	24	1.6	14	7	21	1.8	29	16	45	1.6
18:45-19:00	11	3	14	0.8	10	4	14	1.2	21	7	28	1.0
1時間計	57	16	73	4.4	91	21	112	9.7	148	37	185	6.6
昼12時間計	1138	126	1264	76.4	829	107	936	80.8	1967	233	2200	78.2
19:00-19:15	14	3	17	1.0	13	3	16	1.4	27	6	33	1.2
19:15-19:30	39	5	44	2.7	15	3	18	1.6	54	8	62	2.2
19:30-19:45	71	4	75	4.5	9	3	12	1.0	80	7	87	3.1
19:45-20:00	26	9	35	2.1	6	5	11	0.9	32	14	46	1.6
1時間計	150	21	171	10.3	43	14	57	4.9	193	35	228	8.1
20:00-20:15	14	5	19	1.1	10	1	11	0.9	24	6	30	1.1
20:15-20:30	11	7	18	1.1	12	8	20	1.7	23	15	38	1.4
20:30-20:45	10	5	15	0.9	8	6	14	1.2	18	11	29	1.0
20:45-21:00	7	1	8	0.5	13	2	15	1.3	20	3	23	0.8
1時間計	42	18	60	3.6	43	17	60	5.2	85	35	120	4.3
21:00-21:15	1	0	1	0.1	7	0	7	0.6	8	0	8	0.3
21:15-21:30	1	0	1	0.1	7	4	11	0.9	8	4	12	0.4
21:30-21:45	2	0	2	0.1	9	5	14	1.2	11	5	16	0.6
21:45-22:00	1	0	1	0.1	6	1	7	0.6	7	1	8	0.3
1時間計	5	0	5	0.3	29	10	39	3.4	34	10	44	1.6
22:00-22:15	2	1	3	0.2	4	1	5	0.4	6	2	8	0.3
22:15-22:30	4	1	5	0.3	7	2	9	0.8	11	3	14	0.5
22:30-22:45	2	0	2	0.1	8	1	9	0.8	10	1	11	0.4
22:45-23:00	1	0	1	0.1	0	0	0	0.0	1	0	1	0.0
1時間計	9	2	11	0.7	19	4	23	2.0	28	6	34	1.2

歩行者通行量調査表

調査地点 地域社会6 瀬谷中学校前

調査年月日 令和元年 5月14日(火) 天候 雨のち曇り



時間帯	種別	キ				ク				合計			
		歩行者 (人)	自転車 (台)	合計 (人・台)	時間 係数 (%)	歩行者 (人)	自転車 (台)	合計 (人・台)	時間 係数 (%)	歩行者 (人)	自転車 (台)	合計 (人・台)	時間 係数 (%)
23:00-23:15		1	1	2	0.1	2	0	2	0.2	3	1	4	0.1
23:15-23:30		2	0	2	0.1	2	0	2	0.2	4	0	4	0.1
23:30-23:45		1	0	1	0.1	2	1	3	0.3	3	1	4	0.1
23:45-24:00		0	0	0	0.0	0	0	0	0.0	0	0	0	0.0
1時間計		4	1	5	0.3	6	1	7	0.6	10	2	12	0.4
0:00-0:15		0	0	0	0.0	0	0	0	0.0	0	0	0	0.0
0:15-0:30		0	0	0	0.0	0	0	0	0.0	0	0	0	0.0
0:30-0:45		0	0	0	0.0	1	0	1	0.1	1	0	1	0.0
0:45-1:00		0	0	0	0.0	0	0	0	0.0	0	0	0	0.0
1時間計		0	0	0	0.0	1	0	1	0.1	1	0	1	0.0
1:00-1:15		2	0	2	0.1	1	1	2	0.2	3	1	4	0.1
1:15-1:30		1	0	1	0.1	1	0	1	0.1	2	0	2	0.1
1:30-1:45		1	0	1	0.1	1	1	2	0.2	2	1	3	0.1
1:45-2:00		0	0	0	0.0	0	0	0	0.0	0	0	0	0.0
1時間計		4	0	4	0.2	3	2	5	0.4	7	2	9	0.3
2:00-2:15		0	0	0	0.0	0	0	0	0.0	0	0	0	0.0
2:15-2:30		0	0	0	0.0	0	2	2	0.2	0	2	2	0.1
2:30-2:45		0	0	0	0.0	1	0	1	0.1	1	0	1	0.0
2:45-3:00		0	0	0	0.0	0	0	0	0.0	0	0	0	0.0
1時間計		0	0	0	0.0	1	2	3	0.3	1	2	3	0.1
3:00-3:15		0	0	0	0.0	0	1	1	0.1	0	1	1	0.0
3:15-3:30		1	0	1	0.1	0	0	0	0.0	1	0	1	0.0
3:30-3:45		1	0	1	0.1	0	0	0	0.0	1	0	1	0.0
3:45-4:00		0	1	1	0.1	0	0	0	0.0	0	1	1	0.0
1時間計		2	1	3	0.2	0	1	1	0.1	2	2	4	0.1
4:00-4:15		0	0	0	0.0	0	0	0	0.0	0	0	0	0.0
4:15-4:30		0	1	1	0.1	0	0	0	0.0	0	1	1	0.0
4:30-4:45		3	0	3	0.2	1	0	1	0.1	4	0	4	0.1
4:45-5:00		0	1	1	0.1	0	0	0	0.0	0	1	1	0.0
1時間計		3	2	5	0.3	1	0	1	0.1	4	2	6	0.2
5:00-5:15		3	1	4	0.2	2	0	2	0.2	5	1	6	0.2
5:15-5:30		1	2	3	0.2	2	1	3	0.3	3	3	6	0.2
5:30-5:45		6	2	8	0.5	2	0	2	0.2	8	2	10	0.4
5:45-6:00		10	2	12	0.7	2	0	2	0.2	12	2	14	0.5
1時間計		20	7	27	1.6	8	1	9	0.8	28	8	36	1.3
6:00-6:15		5	3	8	0.5	1	0	1	0.1	6	3	9	0.3
6:15-6:30		11	9	20	1.2	4	2	6	0.5	15	11	26	0.9
6:30-6:45		29	4	33	2.0	3	2	5	0.4	32	6	38	1.4
6:45-7:00		34	4	38	2.3	4	1	5	0.4	38	5	43	1.5
1時間計		79	20	99	6.0	12	5	17	1.5	91	25	116	4.1
夜12時間計		318	72	390	23.6	166	57	223	19.2	484	129	613	21.8
全時間合計		1456	198	1654	100.0	995	164	1159	100.0	2451	362	2813	100.0
昼夜平均		1.28	1.57	1.31	-	1.20	1.53	1.24	-	1.25	1.55	1.28	-

歩行者通行量調査表

調査地点 : 地域社会6 瀬谷中学校前

調査年月日 : 令和元年 5月14日(火) 天候 雨のち曇り



時間帯	方向 種別	合計 (7+イ+ウ+エ+オ+カ+キ+ク)			時間 係 数 (%)
		歩行者 (人)	自転車 (台)	合計 (人・台)	
7:00-7:15		120	9	129	1.6
7:15-7:30		167	11	178	2.2
7:30-7:45		183	12	195	2.4
7:45-8:00		315	13	328	4.0
1時間計		785	45	830	10.1
8:00-8:15		565	16	581	7.1
8:15-8:30		542	22	564	6.8
8:30-8:45		102	17	119	1.4
8:45-9:00		65	12	77	0.9
1時間計		1274	67	1341	16.3
9:00-9:15		45	8	53	0.6
9:15-9:30		54	10	64	0.8
9:30-9:45		44	7	51	0.6
9:45-10:00		34	6	40	0.5
1時間計		177	31	208	2.5
10:00-10:15		42	4	46	0.6
10:15-10:30		51	8	59	0.7
10:30-10:45		61	7	68	0.8
10:45-11:00		49	1	50	0.6
1時間計		203	20	223	2.7
11:00-11:15		47	3	50	0.6
11:15-11:30		53	0	53	0.6
11:30-11:45		43	6	49	0.6
11:45-12:00		35	3	38	0.5
1時間計		178	12	190	2.3
12:00-12:15		45	4	49	0.6
12:15-12:30		34	2	36	0.4
12:30-12:45		36	8	44	0.5
12:45-13:00		47	3	50	0.6
1時間計		162	17	179	2.2
13:00-13:15		36	6	42	0.5
13:15-13:30		35	5	40	0.5
13:30-13:45		54	4	58	0.7
13:45-14:00		31	4	35	0.4
1時間計		156	19	175	2.1
14:00-14:15		46	8	54	0.7
14:15-14:30		36	11	47	0.6
14:30-14:45		40	10	50	0.6
14:45-15:00		32	8	40	0.5
1時間計		154	37	191	2.3
15:00-15:15		59	17	76	0.9
15:15-15:30		64	15	79	1.0
15:30-15:45		210	18	228	2.8
15:45-16:00		381	19	400	4.9
1時間計		714	69	783	9.5
16:00-16:15		246	27	273	3.3
16:15-16:30		138	41	179	2.2
16:30-16:45		149	42	191	2.3
16:45-17:00		113	24	137	1.7
1時間計		646	134	780	9.5
17:00-17:15		154	23	177	2.1
17:15-17:30		139	15	154	1.9
17:30-17:45		172	29	201	2.4
17:45-18:00		291	27	318	3.9
1時間計		756	94	850	10.3
18:00-18:15		188	21	209	2.5
18:15-18:30		117	22	139	1.7
18:30-18:45		103	35	138	1.7
18:45-19:00		74	19	93	1.1
1時間計		482	97	579	7.0
昼12時間計		5687	642	6329	76.8

時間帯	方向 種別	合計 (7+イ+ウ+エ+オ+カ+キ+ク)			時間 係 数 (%)
		歩行者 (人)	自転車 (台)	合計 (人・台)	
7:00-8:00		785	45	830	10.1
7:15-8:15		1230	52	1282	15.6
7:30-8:30		1605	63	1668	20.2
7:45-8:45		1524	68	1592	19.3
8:00-9:00		1274	67	1341	16.3
8:15-9:15		754	59	813	9.9
8:30-9:30		266	47	313	3.8
8:45-9:45		208	37	245	3.0
9:00-10:00		177	31	208	2.5
9:15-10:15		174	27	201	2.4
9:30-10:30		171	25	196	2.4
9:45-10:45		188	25	213	2.6
10:00-11:00		203	20	223	2.7
10:15-11:15		208	19	227	2.8
10:30-11:30		210	11	221	2.7
10:45-11:45		192	10	202	2.5
11:00-12:00		178	12	190	2.3
11:15-12:15		176	13	189	2.3
11:30-12:30		157	15	172	2.1
11:45-12:45		150	17	167	2.0
12:00-13:00		162	17	179	2.2
12:15-13:15		153	19	172	2.1
12:30-13:30		154	22	176	2.1
12:45-13:45		172	18	190	2.3
13:00-14:00		156	19	175	2.1
13:15-14:15		166	21	187	2.3
13:30-14:30		167	27	194	2.4
13:45-14:45		153	33	186	2.3
14:00-15:00		154	37	191	2.3
14:15-15:15		167	46	213	2.6
14:30-15:30		195	50	245	3.0
14:45-15:45		365	58	423	5.1
15:00-16:00		714	69	783	9.5
15:15-16:15		901	79	980	11.9
15:30-16:30		975	105	1080	13.1
15:45-16:45		914	129	1043	12.7
16:00-17:00		646	134	780	9.5
16:15-17:15		554	130	684	8.3
16:30-17:30		555	104	659	8.0
16:45-17:45		578	91	669	8.1
17:00-18:00		756	94	850	10.3
17:15-18:15		790	92	882	10.7
17:30-18:30		768	99	867	10.5
17:45-18:45		699	105	804	9.8
18:00-19:00		482	97	579	7.0
18:15-19:15		376	94	470	5.7
18:30-19:30		358	86	444	5.4
18:45-19:45		403	69	472	5.7
19:00-20:00		415	67	482	5.8
19:15-20:15		417	63	480	5.8
19:30-20:30		398	71	469	5.7
19:45-20:45		311	70	381	4.6
20:00-21:00		300	62	362	4.4
20:15-21:15		258	54	312	3.8
20:30-21:30		247	48	295	3.6
20:45-21:45		243	46	289	3.5
21:00-22:00		194	46	240	2.9
21:15-22:15		212	47	259	3.1
21:30-22:30		186	39	225	2.7
21:45-22:45		170	28	198	2.4
22:00-23:00		166	19	185	2.2

歩行者通行量調査表

調査地点：地域社会6 瀬谷中学校前

調査年月日：令和元年 5月14日(火) 天候 雨のち曇り



時間帯	方向 種別	合計 (7+イ+ウ+エ+オ+カ+キ+ク)			時間 係数 (%)
		歩行者 (人)	自転車 (台)	合計 (人・台)	
19:00-19:15		82	18	100	1.2
19:15-19:30		99	14	113	1.4
19:30-19:45		148	18	166	2.0
19:45-20:00		86	17	103	1.3
1時間計		415	67	482	5.8
20:00-20:15		84	14	98	1.2
20:15-20:30		80	22	102	1.2
20:30-20:45		61	17	78	0.9
20:45-21:00		75	9	84	1.0
1時間計		300	62	362	4.4
21:00-21:15		42	6	48	0.6
21:15-21:30		69	16	85	1.0
21:30-21:45		57	15	72	0.9
21:45-22:00		26	9	35	0.4
1時間計		194	46	240	2.9
22:00-22:15		60	7	67	0.8
22:15-22:30		43	8	51	0.6
22:30-22:45		41	4	45	0.5
22:45-23:00		22	0	22	0.3
1時間計		166	19	185	2.2
23:00-23:15		19	1	20	0.2
23:15-23:30		23	0	23	0.3
23:30-23:45		24	3	27	0.3
23:45-24:00		13	1	14	0.2
1時間計		79	5	84	1.0
0:00-0:15		16	0	16	0.2
0:15-0:30		10	2	12	0.1
0:30-0:45		8	2	10	0.1
0:45-1:00		5	0	5	0.1
1時間計		39	4	43	0.5
1:00-1:15		6	2	8	0.1
1:15-1:30		4	1	5	0.1
1:30-1:45		6	2	8	0.1
1:45-2:00		0	1	1	0.0
1時間計		16	6	22	0.3
2:00-2:15		2	0	2	0.0
2:15-2:30		1	2	3	0.0
2:30-2:45		1	0	1	0.0
2:45-3:00		0	0	0	0.0
1時間計		4	2	6	0.1
3:00-3:15		1	2	3	0.0
3:15-3:30		1	0	1	0.0
3:30-3:45		2	0	2	0.0
3:45-4:00		1	1	2	0.0
1時間計		5	3	8	0.1
4:00-4:15		1	0	1	0.0
4:15-4:30		1	2	3	0.0
4:30-4:45		7	0	7	0.1
4:45-5:00		3	1	4	0.0
1時間計		12	3	15	0.2
5:00-5:15		14	1	15	0.2
5:15-5:30		22	6	28	0.3
5:30-5:45		40	6	46	0.6
5:45-6:00		28	4	32	0.4
1時間計		104	17	121	1.5
6:00-6:15		25	8	33	0.4
6:15-6:30		45	15	60	0.7
6:30-6:45		99	15	114	1.4
6:45-7:00		119	17	136	1.7
1時間計		288	55	343	4.2
夜12時間計		1622	289	1911	23.2
全時間合計		7309	931	8240	100.0
昼 夜 率		1.29	1.45	1.30	-

時間帯	方向 種別	合計 (7+イ+ウ+エ+オ+カ+キ+ク)			時間 係数 (%)
		歩行者 (人)	自転車 (台)	合計 (人・台)	
22:15-23:15		125	13	138	1.7
22:30-23:30		105	5	110	1.3
22:45-23:45		88	4	92	1.1
23:00-0:00		79	5	84	1.0
23:15-0:15		76	4	80	1.0
23:30-0:30		63	6	69	0.8
23:45-0:45		47	5	52	0.6
0:00-1:00		39	4	43	0.5
0:15-1:15		29	6	35	0.4
0:30-1:30		23	5	28	0.3
0:45-1:45		21	5	26	0.3
1:00-2:00		16	6	22	0.3
1:15-2:15		12	4	16	0.2
1:30-2:30		9	5	14	0.2
1:45-2:45		4	3	7	0.1
2:00-3:00		4	2	6	0.1
2:15-3:15		3	4	7	0.1
2:30-3:30		3	2	5	0.1
2:45-3:45		4	2	6	0.1
3:00-4:00		5	3	8	0.1
3:15-4:15		5	1	6	0.1
3:30-4:30		5	3	8	0.1
3:45-4:45		10	3	13	0.2
4:00-5:00		12	3	15	0.2
4:15-5:15		25	4	29	0.4
4:30-5:30		46	8	54	0.7
4:45-5:45		79	14	93	1.1
5:00-6:00		104	17	121	1.5
5:15-6:15		115	24	139	1.7
5:30-6:30		138	33	171	2.1
5:45-6:45		197	42	239	2.9
6:00-7:00		288	55	343	4.2
全時間合計		7,309	931	8,240	100.0

歩行者通行量調査表

調査地点：地域社会I 目黒

調査年月日：令和元年 5月11日(土) 天候：晴れ時々曇り

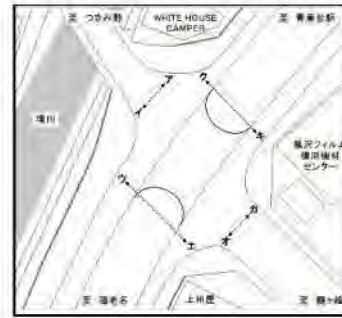

時間帯	種別	ア				イ				合計			
		歩行者 (人)	自転車 (台)	合計 (人・台)	時間 係数 (%)	歩行者 (人)	自転車 (台)	合計 (人・台)	時間 係数 (%)	歩行者 (人)	自転車 (台)	合計 (人・台)	時間 係数 (%)
22:00-22:15		1	0	1	0.3	0	0	0	0.0	1	0	1	0.1
22:15-22:30		1	0	1	0.3	0	1	1	0.3	1	1	2	0.3
22:30-22:45		0	1	1	0.3	0	1	1	0.3	0	2	2	0.3
22:45-23:00		0	4	4	1.3	0	0	0	0.0	0	4	4	0.6
1時間計		2	5	7	2.2	0	2	2	0.5	2	7	9	1.3
23:00-23:15		2	0	2	0.6	0	0	0	0.0	2	0	2	0.3
23:15-23:30		0	1	1	0.3	0	0	0	0.0	0	1	1	0.1
23:30-23:45		0	0	0	0.0	2	0	2	0.5	2	0	2	0.3
23:45-24:00		1	0	1	0.3	0	0	0	0.0	1	0	1	0.1
1時間計		3	1	4	1.3	2	0	2	0.5	5	1	6	0.9
0:00-0:15		0	0	0	0.0	0	0	0	0.0	0	0	0	0.0
0:15-0:30		0	0	0	0.0	0	0	0	0.0	0	0	0	0.0
0:30-0:45		0	0	0	0.0	0	0	0	0.0	0	0	0	0.0
0:45-1:00		0	0	0	0.0	0	0	0	0.0	0	0	0	0.0
1時間計		0	0	0	0.0	0	0	0	0.0	0	0	0	0.0
1:00-1:15		0	0	0	0.0	0	0	0	0.0	0	0	0	0.0
1:15-1:30		0	0	0	0.0	0	0	0	0.0	0	0	0	0.0
1:30-1:45		0	0	0	0.0	0	0	0	0.0	0	0	0	0.0
1:45-2:00		0	0	0	0.0	0	0	0	0.0	0	0	0	0.0
1時間計		0	0	0	0.0	0	0	0	0.0	0	0	0	0.0
2:00-2:15		0	0	0	0.0	0	0	0	0.0	0	0	0	0.0
2:15-2:30		0	0	0	0.0	0	0	0	0.0	0	0	0	0.0
2:30-2:45		0	0	0	0.0	0	0	0	0.0	0	0	0	0.0
2:45-3:00		0	0	0	0.0	0	0	0	0.0	0	0	0	0.0
1時間計		0	0	0	0.0	0	0	0	0.0	0	0	0	0.0
3:00-3:15		0	0	0	0.0	0	0	0	0.0	0	0	0	0.0
3:15-3:30		0	0	0	0.0	0	0	0	0.0	0	0	0	0.0
3:30-3:45		0	0	0	0.0	0	0	0	0.0	0	0	0	0.0
3:45-4:00		0	0	0	0.0	0	0	0	0.0	0	0	0	0.0
1時間計		0	0	0	0.0	0	0	0	0.0	0	0	0	0.0
4:00-4:15		0	0	0	0.0	1	0	1	0.3	1	0	1	0.1
4:15-4:30		0	0	0	0.0	0	0	0	0.0	0	0	0	0.0
4:30-4:45		0	0	0	0.0	0	0	0	0.0	0	0	0	0.0
4:45-5:00		0	0	0	0.0	0	0	0	0.0	0	0	0	0.0
1時間計		0	0	0	0.0	1	0	1	0.3	1	0	1	0.1
5:00-5:15		0	1	1	0.3	0	1	1	0.3	0	2	2	0.3
5:15-5:30		1	0	1	0.3	0	4	4	1.1	1	4	5	0.7
5:30-5:45		2	1	3	1.0	0	1	1	0.3	2	2	4	0.6
5:45-6:00		0	0	0	0.0	0	0	0	0.0	0	0	0	0.0
1時間計		3	2	5	1.6	0	6	6	1.6	3	8	11	1.6

歩行者通行量調査表

調査地点：地域社会1 目黒

調査年月日：令和元年 5月11日(土) 天候：晴れ時々曇り

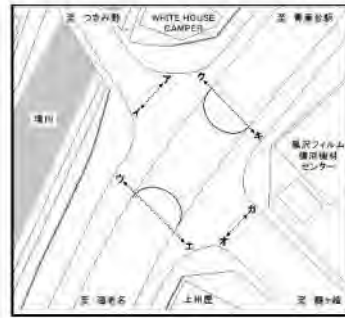

時間帯	7				8				合計			
	歩行者 (人)	自転車 (台)	合計 (人・台)	時間 係数 (%)	歩行者 (人)	自転車 (台)	合計 (人・台)	時間 係数 (%)	歩行者 (人)	自転車 (台)	合計 (人・台)	時間 係数 (%)
6:00-6:15	0	0	0	0.0	0	1	1	0.3	0	1	1	0.1
6:15-6:30	0	0	0	0.0	0	0	0	0.0	0	0	0	0.0
6:30-6:45	0	0	0	0.0	0	0	0	0.0	0	0	0	0.0
6:45-7:00	0	0	0	0.0	0	0	0	0.0	0	0	0	0.0
1時間計	0	0	0	0.0	0	1	1	0.3	0	1	1	0.1
7:00-7:15	0	0	0	0.0	0	0	0	0.0	0	0	0	0.0
7:15-7:30	1	0	1	0.3	1	0	1	0.3	2	0	2	0.3
7:30-7:45	1	2	3	1.0	3	3	6	1.6	4	5	9	1.3
7:45-8:00	0	1	1	0.3	5	1	6	1.6	5	2	7	1.0
1時間計	2	3	5	1.6	9	4	13	3.6	11	7	18	2.7
8:00-8:15	0	4	4	1.3	1	8	9	2.5	1	12	13	1.9
8:15-8:30	1	3	4	1.3	2	7	9	2.5	3	10	13	1.9
8:30-8:45	1	6	7	2.2	3	8	11	3.0	4	14	18	2.7
8:45-9:00	0	2	2	0.6	2	4	6	1.6	2	6	8	1.2
1時間計	2	15	17	5.4	8	27	35	9.6	10	42	52	7.7
9:00-9:15	1	2	3	1.0	5	12	17	4.7	6	14	20	3.0
9:15-9:30	3	3	6	1.9	6	15	21	5.8	9	18	27	4.0
9:30-9:45	0	6	6	1.9	1	3	4	1.1	1	9	10	1.5
9:45-10:00	0	9	9	2.9	5	10	15	4.1	5	19	24	3.5
1時間計	4	20	24	7.7	17	40	57	15.7	21	60	81	12.0
10:00-10:15	2	4	6	1.9	0	8	8	2.2	2	12	14	2.1
10:15-10:30	2	5	7	2.2	1	5	6	1.6	3	10	13	1.9
10:30-10:45	4	4	8	2.6	3	11	14	3.8	7	15	22	3.2
10:45-11:00	1	2	3	1.0	3	3	6	1.6	4	5	9	1.3
1時間計	9	15	24	7.7	7	27	34	9.3	16	42	58	8.6
11:00-11:15	1	7	8	2.6	3	5	8	2.2	4	12	16	2.4
11:15-11:30	4	5	9	2.9	1	0	1	0.3	5	5	10	1.5
11:30-11:45	2	8	10	3.2	3	8	11	3.0	5	16	21	3.1
11:45-12:00	3	5	8	2.6	6	11	17	4.7	9	16	25	3.7
1時間計	10	25	35	11.2	13	24	37	10.2	23	49	72	10.6
12:00-12:15	1	4	5	1.6	18	3	21	5.8	19	7	26	3.8
12:15-12:30	0	0	0	0.0	2	1	3	0.8	2	1	3	0.4
12:30-12:45	0	2	2	0.6	0	2	2	0.5	0	4	4	0.6
12:45-13:00	0	6	6	1.9	0	6	6	1.6	0	12	12	1.8
1時間計	1	12	13	4.2	20	12	32	8.8	21	24	45	6.6
13:00-13:15	0	5	5	1.6	1	3	4	1.1	1	8	9	1.3
13:15-13:30	0	1	1	0.3	1	2	3	0.8	1	3	4	0.6
13:30-13:45	0	2	2	0.6	0	3	3	0.8	0	5	5	0.7
13:45-14:00	0	8	8	2.6	0	1	1	0.3	0	9	9	1.3
1時間計	0	16	16	5.1	2	9	11	3.0	2	25	27	4.0

歩行者通行量調査表

調査地点：地域社会I 目黒

調査年月日：令和元年 5月11日(土) 天候：晴れ時々曇り

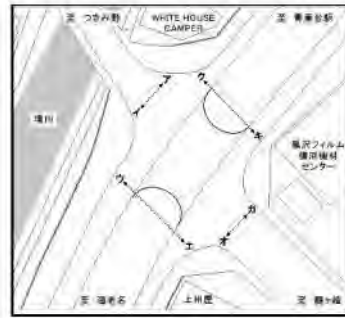

時間帯	ア				イ				合計			
	歩行者 (人)	自転車 (台)	合計 (人・台)	時間 係数 (%)	歩行者 (人)	自転車 (台)	合計 (人・台)	時間 係数 (%)	歩行者 (人)	自転車 (台)	合計 (人・台)	時間 係数 (%)
14:00-14:15	4	14	18	5.8	2	3	5	1.4	6	17	23	3.4
14:15-14:30	1	4	5	1.6	2	9	11	3.0	3	13	16	2.4
14:30-14:45	2	5	7	2.2	1	6	7	1.9	3	11	14	2.1
14:45-15:00	0	5	5	1.6	2	4	6	1.6	2	9	11	1.6
1時間計	7	28	35	11.2	7	22	29	8.0	14	50	64	9.5
15:00-15:15	1	3	4	1.3	2	7	9	2.5	3	10	13	1.9
15:15-15:30	0	2	2	0.6	2	1	3	0.8	2	3	5	0.7
15:30-15:45	1	5	6	1.9	0	3	3	0.8	1	8	9	1.3
15:45-16:00	2	3	5	1.6	1	4	5	1.4	3	7	10	1.5
1時間計	4	13	17	5.4	5	15	20	5.5	9	28	37	5.5
16:00-16:15	1	1	2	0.6	5	2	7	1.9	6	3	9	1.3
16:15-16:30	1	6	7	2.2	7	5	12	3.3	8	11	19	2.8
16:30-16:45	3	20	23	7.3	4	4	8	2.2	7	24	31	4.6
16:45-17:00	5	3	8	2.6	2	1	3	0.8	7	4	11	1.6
1時間計	10	30	40	12.8	18	12	30	8.2	28	42	70	10.3
17:00-17:15	3	12	15	4.8	6	6	12	3.3	9	18	27	4.0
17:15-17:30	3	8	11	3.5	0	5	5	1.4	3	13	16	2.4
17:30-17:45	13	4	17	5.4	1	3	4	1.1	14	7	21	3.1
17:45-18:00	0	3	3	1.0	1	5	6	1.6	1	8	9	1.3
1時間計	19	27	46	14.7	8	19	27	7.4	27	46	73	10.8
18:00-18:15	1	0	1	0.3	1	1	2	0.5	2	1	3	0.4
18:15-18:30	0	1	1	0.3	1	5	6	1.6	1	6	7	1.0
18:30-18:45	4	4	8	2.6	0	4	4	1.1	4	8	12	1.8
18:45-19:00	1	2	3	1.0	0	2	2	0.5	1	4	5	0.7
1時間計	6	7	13	4.2	2	12	14	3.8	8	19	27	4.0
19:00-19:15	0	0	0	0.0	2	0	2	0.5	2	0	2	0.3
19:15-19:30	0	0	0	0.0	0	0	0	0.0	0	0	0	0.0
19:30-19:45	0	1	1	0.3	2	1	3	0.8	2	2	4	0.6
19:45-20:00	3	1	4	1.3	1	0	1	0.3	4	1	5	0.7
1時間計	3	2	5	1.6	5	1	6	1.6	8	3	11	1.6
20:00-20:15	0	0	0	0.0	0	0	0	0.0	0	0	0	0.0
20:15-20:30	0	1	1	0.3	0	1	1	0.3	0	2	2	0.3
20:30-20:45	1	0	1	0.3	0	0	0	0.0	1	0	1	0.1
20:45-21:00	0	0	0	0.0	0	2	2	0.5	0	2	2	0.3
1時間計	1	1	2	0.6	0	3	3	0.8	1	4	5	0.7
21:00-21:15	0	2	2	0.6	0	2	2	0.5	0	4	4	0.6
21:15-21:30	1	1	2	0.6	0	0	0	0.0	1	1	2	0.3
21:30-21:45	0	1	1	0.3	2	0	2	0.5	2	1	3	0.4
21:45-22:00	0	0	0	0.0	0	0	0	0.0	0	0	0	0.0
1時間計	1	4	5	1.6	2	2	4	1.1	3	6	9	1.3
昼12時間計	74	211	285	91.1	116	223	339	93.1	190	434	624	92.2
夜12時間計	13	15	28	8.9	10	15	25	6.9	23	30	53	7.8
全時間合計	87	226	313	100.0	126	238	364	100.0	213	464	677	100.0
昼夜率	1.18	1.07	1.10	-	1.09	1.07	1.07	-	1.12	1.07	1.08	-

歩行者通行量調査表

調査地点：地域社会I 目黒

調査年月日：令和元年 5月11日(土) 天候：晴れ時々曇り

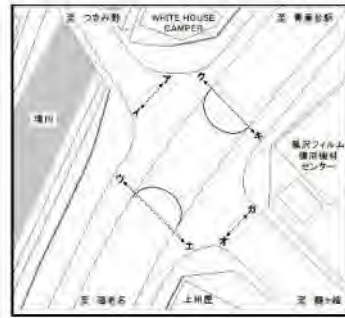

時間帯	ウ				I				合計			
	歩行者 (人)	自転車 (台)	合計 (人・台)	時間 係数 (%)	歩行者 (人)	自転車 (台)	合計 (人・台)	時間 係数 (%)	歩行者 (人)	自転車 (台)	合計 (人・台)	時間 係数 (%)
22:00-22:15	2	3	5	1.5	0	0	0	0.0	2	3	5	0.8
22:15-22:30	1	2	3	0.9	0	0	0	0.0	1	2	3	0.5
22:30-22:45	5	0	5	1.5	2	0	2	0.7	7	0	7	1.1
22:45-23:00	0	1	1	0.3	0	2	2	0.7	0	3	3	0.5
1時間計	8	6	14	4.1	2	2	4	1.4	10	8	18	2.8
23:00-23:15	0	0	0	0.0	3	0	3	1.0	3	0	3	0.5
23:15-23:30	3	0	3	0.9	0	2	2	0.7	3	2	5	0.8
23:30-23:45	0	0	0	0.0	0	0	0	0.0	0	0	0	0.0
23:45-24:00	2	0	2	0.6	0	0	0	0.0	2	0	2	0.3
1時間計	5	0	5	1.5	3	2	5	1.7	8	2	10	1.6
0:00-0:15	0	2	2	0.6	0	0	0	0.0	0	2	2	0.3
0:15-0:30	0	1	1	0.3	0	0	0	0.0	0	1	1	0.2
0:30-0:45	2	0	2	0.6	1	0	1	0.3	3	0	3	0.5
0:45-1:00	2	1	3	0.9	0	0	0	0.0	2	1	3	0.5
1時間計	4	4	8	2.3	1	0	1	0.3	5	4	9	1.4
1:00-1:15	1	0	1	0.3	0	0	0	0.0	1	0	1	0.2
1:15-1:30	1	0	1	0.3	0	0	0	0.0	1	0	1	0.2
1:30-1:45	0	0	0	0.0	0	0	0	0.0	0	0	0	0.0
1:45-2:00	0	0	0	0.0	0	0	0	0.0	0	0	0	0.0
1時間計	2	0	2	0.6	0	0	0	0.0	2	0	2	0.3
2:00-2:15	0	0	0	0.0	0	1	1	0.3	0	1	1	0.2
2:15-2:30	0	0	0	0.0	0	1	1	0.3	0	1	1	0.2
2:30-2:45	0	0	0	0.0	0	0	0	0.0	0	0	0	0.0
2:45-3:00	0	0	0	0.0	1	0	1	0.3	1	0	1	0.2
1時間計	0	0	0	0.0	1	2	3	1.0	1	2	3	0.5
3:00-3:15	0	1	1	0.3	0	0	0	0.0	0	1	1	0.2
3:15-3:30	1	1	2	0.6	0	0	0	0.0	1	1	2	0.3
3:30-3:45	0	0	0	0.0	0	0	0	0.0	0	0	0	0.0
3:45-4:00	0	0	0	0.0	0	0	0	0.0	0	0	0	0.0
1時間計	1	2	3	0.9	0	0	0	0.0	1	2	3	0.5
4:00-4:15	0	0	0	0.0	0	0	0	0.0	0	0	0	0.0
4:15-4:30	0	0	0	0.0	0	0	0	0.0	0	0	0	0.0
4:30-4:45	0	0	0	0.0	0	0	0	0.0	0	0	0	0.0
4:45-5:00	0	0	0	0.0	0	0	0	0.0	0	0	0	0.0
1時間計	0	0	0	0.0	0	0	0	0.0	0	0	0	0.0
5:00-5:15	0	0	0	0.0	0	1	1	0.3	0	1	1	0.2
5:15-5:30	0	2	2	0.6	0	4	4	1.4	0	6	6	0.9
5:30-5:45	0	0	0	0.0	0	1	1	0.3	0	1	1	0.2
5:45-6:00	0	0	0	0.0	0	0	0	0.0	0	0	0	0.0
1時間計	0	2	2	0.6	0	6	6	2.1	0	8	8	1.3

歩行者通行量調査表

調査地点：地域社会1 目黒

調査年月日：令和元年 5月11日(土) 天候：晴れ時々曇り

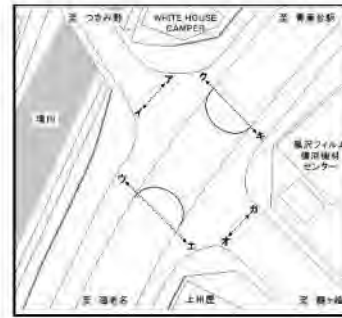

時間帯	種別	ウ				エ				合計			
		歩行者 (人)	自転車 (台)	合計 (人・台)	時間 係数 (%)	歩行者 (人)	自転車 (台)	合計 (人・台)	時間 係数 (%)	歩行者 (人)	自転車 (台)	合計 (人・台)	時間 係数 (%)
6:00-6:15		0	2	2	0.6	2	1	3	1.0	2	3	5	0.8
6:15-6:30		1	2	3	0.9	0	3	3	1.0	1	5	6	0.9
6:30-6:45		1	0	1	0.3	0	3	3	1.0	1	3	4	0.6
6:45-7:00		1	1	2	0.6	0	4	4	1.4	1	5	6	0.9
1時間計		3	5	8	2.3	2	11	13	4.5	5	16	21	3.3
7:00-7:15		0	2	2	0.6	1	0	1	0.3	1	2	3	0.5
7:15-7:30		0	1	1	0.3	0	2	2	0.7	0	3	3	0.5
7:30-7:45		0	1	1	0.3	2	2	4	1.4	2	3	5	0.8
7:45-8:00		1	4	5	1.5	2	2	4	1.4	3	6	9	1.4
1時間計		1	8	9	2.6	5	6	11	3.8	6	14	20	3.2
8:00-8:15		0	5	5	1.5	0	2	2	0.7	0	7	7	1.1
8:15-8:30		0	2	2	0.6	2	5	7	2.4	2	7	9	1.4
8:30-8:45		2	4	6	1.7	1	4	5	1.7	3	8	11	1.7
8:45-9:00		1	1	2	0.6	1	2	3	1.0	2	3	5	0.8
1時間計		3	12	15	4.4	4	13	17	5.9	7	25	32	5.1
9:00-9:15		0	0	0	0.0	1	7	8	2.8	1	7	8	1.3
9:15-9:30		2	0	2	0.6	1	3	4	1.4	3	3	6	0.9
9:30-9:45		1	5	6	1.7	2	2	4	1.4	3	7	10	1.6
9:45-10:00		2	3	5	1.5	1	3	4	1.4	3	6	9	1.4
1時間計		5	8	13	3.8	5	15	20	6.9	10	23	33	5.2
10:00-10:15		0	4	4	1.2	0	3	3	1.0	0	7	7	1.1
10:15-10:30		1	4	5	1.5	0	6	6	2.1	1	10	11	1.7
10:30-10:45		0	2	2	0.6	0	4	4	1.4	0	6	6	0.9
10:45-11:00		0	2	2	0.6	3	5	8	2.8	3	7	10	1.6
1時間計		1	12	13	3.8	3	18	21	7.3	4	30	34	5.4
11:00-11:15		5	4	9	2.6	0	1	1	0.3	5	5	10	1.6
11:15-11:30		0	5	5	1.5	0	1	1	0.3	0	6	6	0.9
11:30-11:45		3	5	8	2.3	1	4	5	1.7	4	9	13	2.1
11:45-12:00		0	2	2	0.6	3	2	5	1.7	3	4	7	1.1
1時間計		8	16	24	7.0	4	8	12	4.2	12	24	36	5.7
12:00-12:15		0	5	5	1.5	12	2	14	4.8	12	7	19	3.0
12:15-12:30		1	1	2	0.6	4	5	9	3.1	5	6	11	1.7
12:30-12:45		1	3	4	1.2	8	7	15	5.2	9	10	19	3.0
12:45-13:00		3	3	6	1.7	1	3	4	1.4	4	6	10	1.6
1時間計		5	12	17	5.0	25	17	42	14.5	30	29	59	9.3
13:00-13:15		4	6	10	2.9	2	0	2	0.7	6	6	12	1.9
13:15-13:30		1	2	3	0.9	1	2	3	1.0	2	4	6	0.9
13:30-13:45		0	0	0	0.0	0	0	0	0.0	0	0	0	0.0
13:45-14:00		2	3	5	1.5	1	4	5	1.7	3	7	10	1.6
1時間計		7	11	18	5.2	4	6	10	3.5	11	17	28	4.4

歩行者通行量調査表

調査地点：地域社会I 目黒

調査年月日：令和元年 5月11日(土) 天候：晴れ時々曇り

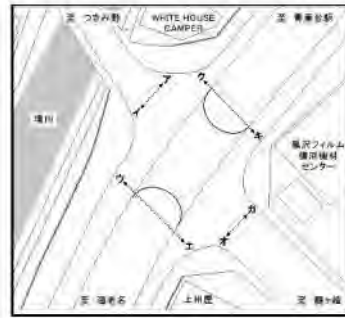

時間帯	ウ				I				合計			
	歩行者 (人)	自転車 (台)	合計 (人・台)	時間 係数 (%)	歩行者 (人)	自転車 (台)	合計 (人・台)	時間 係数 (%)	歩行者 (人)	自転車 (台)	合計 (人・台)	時間 係数 (%)
14:00-14:15	1	3	4	1.2	0	5	5	1.7	1	8	9	1.4
14:15-14:30	2	3	5	1.5	3	0	3	1.0	5	3	8	1.3
14:30-14:45	2	5	7	2.0	3	0	3	1.0	5	5	10	1.6
14:45-15:00	0	4	4	1.2	1	4	5	1.7	1	8	9	1.4
1時間計	5	15	20	5.8	7	9	16	5.5	12	24	36	5.7
15:00-15:15	1	3	4	1.2	6	1	7	2.4	7	4	11	1.7
15:15-15:30	2	1	3	0.9	2	5	7	2.4	4	6	10	1.6
15:30-15:45	0	6	6	1.7	1	3	4	1.4	1	9	10	1.6
15:45-16:00	1	0	1	0.3	1	3	4	1.4	2	3	5	0.8
1時間計	4	10	14	4.1	10	12	22	7.6	14	22	36	5.7
16:00-16:15	10	7	17	5.0	6	2	8	2.8	16	9	25	4.0
16:15-16:30	2	3	5	1.5	3	3	6	2.1	5	6	11	1.7
16:30-16:45	0	3	3	0.9	1	6	7	2.4	1	9	10	1.6
16:45-17:00	8	11	19	5.5	3	1	4	1.4	11	12	23	3.6
1時間計	20	24	44	12.8	13	12	25	8.7	33	36	69	10.9
17:00-17:15	0	5	5	1.5	3	3	6	2.1	3	8	11	1.7
17:15-17:30	3	6	9	2.6	2	3	5	1.7	5	9	14	2.2
17:30-17:45	11	4	15	4.4	0	5	5	1.7	11	9	20	3.2
17:45-18:00	1	2	3	0.9	0	0	0	0.0	1	2	3	0.5
1時間計	15	17	32	9.3	5	11	16	5.5	20	28	48	7.6
18:00-18:15	1	4	5	1.5	3	0	3	1.0	4	4	8	1.3
18:15-18:30	3	3	6	1.7	0	2	2	0.7	3	5	8	1.3
18:30-18:45	4	3	7	2.0	2	2	4	1.4	6	5	11	1.7
18:45-19:00	3	7	10	2.9	0	1	1	0.3	3	8	11	1.7
1時間計	11	17	28	8.2	5	5	10	3.5	16	22	38	6.0
19:00-19:15	2	4	6	1.7	3	3	6	2.1	5	7	12	1.9
19:15-19:30	2	3	5	1.5	1	4	5	1.7	3	7	10	1.6
19:30-19:45	0	4	4	1.2	3	1	4	1.4	3	5	8	1.3
19:45-20:00	4	4	8	2.3	3	3	6	2.1	7	7	14	2.2
1時間計	8	15	23	6.7	10	11	21	7.3	18	26	44	7.0
20:00-20:15	1	0	1	0.3	1	0	1	0.3	2	0	2	0.3
20:15-20:30	2	3	5	1.5	0	2	2	0.7	2	5	7	1.1
20:30-20:45	0	2	2	0.6	0	1	1	0.3	0	3	3	0.5
20:45-21:00	0	2	2	0.6	1	2	3	1.0	1	4	5	0.8
1時間計	3	7	10	2.9	2	5	7	2.4	5	12	17	2.7
21:00-21:15	1	4	5	1.5	1	2	3	1.0	2	6	8	1.3
21:15-21:30	6	3	9	2.6	0	3	3	1.0	6	6	12	1.9
21:30-21:45	1	3	4	1.2	0	1	1	0.3	1	4	5	0.8
21:45-22:00	3	0	3	0.9	0	0	0	0.0	3	0	3	0.5
1時間計	11	10	21	6.1	1	6	7	2.4	12	16	28	4.4
昼12時間計	85	162	247	72.0	90	132	222	76.8	175	294	469	74.2
夜12時間計	45	51	96	28.0	22	45	67	23.2	67	96	163	25.8
全時間合計	130	213	343	100.0	112	177	289	100.0	242	390	632	100.0
昼夜率	1.53	1.31	1.39	-	1.24	1.34	1.30	-	1.38	1.33	1.35	-

歩行者通行量調査表

調査地点：地域社会1 目黒

調査年月日：令和元年 5月11日(土) 天候：晴れ時々曇り

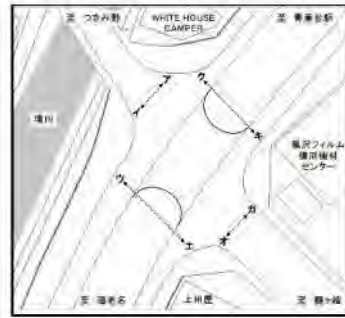

時間帯	方向				合計							
	歩行者 (人)	自転車 (台)	合計 (人・台)	時間係数 (%)	歩行者 (人)	自転車 (台)	合計 (人・台)	時間係数 (%)	歩行者 (人)	自転車 (台)	合計 (人・台)	時間係数 (%)
22:00-22:15	1	1	2	0.6	0	2	2	0.9	1	3	4	0.7
22:15-22:30	1	1	2	0.6	0	1	1	0.4	1	2	3	0.6
22:30-22:45	0	0	0	0.0	0	0	0	0.0	0	0	0	0.0
22:45-23:00	0	0	0	0.0	0	0	0	0.0	0	0	0	0.0
1時間計	2	2	4	1.3	0	3	3	1.3	2	5	7	1.3
23:00-23:15	0	0	0	0.0	0	3	3	1.3	0	3	3	0.6
23:15-23:30	0	0	0	0.0	0	0	0	0.0	0	0	0	0.0
23:30-23:45	0	0	0	0.0	0	0	0	0.0	0	0	0	0.0
23:45-24:00	2	0	2	0.6	0	0	0	0.0	2	0	2	0.4
1時間計	2	0	2	0.6	0	3	3	1.3	2	3	5	0.9
0:00-0:15	0	0	0	0.0	1	1	2	0.9	1	1	2	0.4
0:15-0:30	0	0	0	0.0	0	0	0	0.0	0	0	0	0.0
0:30-0:45	0	0	0	0.0	0	1	1	0.4	0	1	1	0.2
0:45-1:00	0	0	0	0.0	0	0	0	0.0	0	0	0	0.0
1時間計	0	0	0	0.0	1	2	3	1.3	1	2	3	0.6
1:00-1:15	0	0	0	0.0	0	0	0	0.0	0	0	0	0.0
1:15-1:30	0	0	0	0.0	0	0	0	0.0	0	0	0	0.0
1:30-1:45	1	0	1	0.3	0	0	0	0.0	1	0	1	0.2
1:45-2:00	0	0	0	0.0	0	0	0	0.0	0	0	0	0.0
1時間計	1	0	1	0.3	0	0	0	0.0	1	0	1	0.2
2:00-2:15	0	0	0	0.0	0	0	0	0.0	0	0	0	0.0
2:15-2:30	0	2	2	0.6	0	1	1	0.4	0	3	3	0.6
2:30-2:45	0	0	0	0.0	0	0	0	0.0	0	0	0	0.0
2:45-3:00	0	0	0	0.0	0	0	0	0.0	0	0	0	0.0
1時間計	0	2	2	0.6	0	1	1	0.4	0	3	3	0.6
3:00-3:15	1	0	1	0.3	0	0	0	0.0	1	0	1	0.2
3:15-3:30	0	0	0	0.0	0	0	0	0.0	0	0	0	0.0
3:30-3:45	0	0	0	0.0	0	0	0	0.0	0	0	0	0.0
3:45-4:00	0	0	0	0.0	1	0	1	0.4	1	0	1	0.2
1時間計	1	0	1	0.3	1	0	1	0.4	2	0	2	0.4
4:00-4:15	0	0	0	0.0	0	0	0	0.0	0	0	0	0.0
4:15-4:30	0	1	1	0.3	0	0	0	0.0	0	1	1	0.2
4:30-4:45	0	0	0	0.0	0	0	0	0.0	0	0	0	0.0
4:45-5:00	0	0	0	0.0	0	0	0	0.0	0	0	0	0.0
1時間計	0	1	1	0.3	0	0	0	0.0	0	1	1	0.2
5:00-5:15	0	1	1	0.3	0	0	0	0.0	0	1	1	0.2
5:15-5:30	0	1	1	0.3	3	0	3	1.3	3	1	4	0.7
5:30-5:45	0	1	1	0.3	0	0	0	0.0	0	1	1	0.2
5:45-6:00	1	1	2	0.6	1	0	1	0.4	2	1	3	0.6
1時間計	1	4	5	1.6	4	0	4	1.8	5	4	9	1.7

歩行者通行量調査表

調査地点：地域社会1 目黒

調査年月日：令和元年 5月11日(土) 天候：晴れ時々曇り

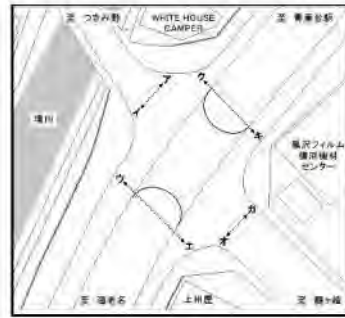

時間帯	方向				合計							
	歩行者 (人)	自転車 (台)	合計 (人・台)	時間 係数 (%)	歩行者 (人)	自転車 (台)	合計 (人・台)	時間 係数 (%)	歩行者 (人)	自転車 (台)	合計 (人・台)	時間 係数 (%)
6:00-6:15	1	1	2	0.6	1	0	1	0.4	2	1	3	0.6
6:15-6:30	0	0	0	0.0	0	0	0	0.0	0	0	0	0.0
6:30-6:45	1	5	6	1.9	1	1	2	0.4	2	6	8	1.3
6:45-7:00	0	1	1	0.3	0	1	1	0.4	0	2	2	0.4
1時間計	2	7	9	2.8	1	2	3	1.3	3	9	12	2.2
7:00-7:15	0	1	1	0.3	1	3	4	1.8	1	4	5	0.9
7:15-7:30	2	2	4	1.3	1	0	1	0.4	3	2	5	0.9
7:30-7:45	4	5	9	2.8	0	5	5	2.2	4	10	14	2.6
7:45-8:00	0	4	4	1.3	2	6	8	3.5	2	10	12	2.2
1時間計	6	12	18	5.7	4	14	18	7.9	10	26	36	6.6
8:00-8:15	2	3	5	1.6	1	1	2	0.9	3	4	7	1.3
8:15-8:30	1	6	7	2.2	0	2	2	0.9	1	8	9	1.7
8:30-8:45	0	12	12	3.8	1	5	6	2.6	1	17	18	3.3
8:45-9:00	2	8	10	3.2	0	0	0	0.0	2	8	10	1.8
1時間計	5	29	34	10.7	2	8	10	4.4	7	37	44	8.1
9:00-9:15	1	3	4	1.3	0	1	1	0.4	1	4	5	0.9
9:15-9:30	4	6	10	3.2	0	2	2	0.9	4	8	12	2.2
9:30-9:45	3	6	9	2.8	0	4	4	1.8	3	10	13	2.4
9:45-10:00	1	7	8	2.5	1	4	5	2.2	2	11	13	2.4
1時間計	9	22	31	9.8	1	11	12	5.3	10	33	43	7.9
10:00-10:15	0	2	2	0.6	0	3	3	1.3	0	5	5	0.9
10:15-10:30	0	2	2	0.6	0	2	2	0.9	0	4	4	0.7
10:30-10:45	1	9	10	3.2	0	0	0	0.0	1	9	10	1.8
10:45-11:00	1	8	9	2.8	0	0	0	0.0	1	8	9	1.7
1時間計	2	21	23	7.3	0	5	5	2.2	2	26	28	5.1
11:00-11:15	0	1	1	0.3	0	1	1	0.4	0	2	2	0.4
11:15-11:30	0	3	3	0.9	0	1	1	0.4	0	4	4	0.7
11:30-11:45	2	1	3	0.9	0	1	1	0.4	2	2	4	0.7
11:45-12:00	4	11	15	4.7	1	2	3	1.3	5	13	18	3.3
1時間計	6	16	22	6.9	1	5	6	2.6	7	21	28	5.1
12:00-12:15	1	3	4	1.3	3	0	3	1.3	4	3	7	1.3
12:15-12:30	3	11	14	4.4	2	6	8	3.5	5	17	22	4.0
12:30-12:45	4	4	8	2.5	0	1	1	0.4	4	5	9	1.7
12:45-13:00	0	1	1	0.3	2	3	5	2.2	2	4	6	1.1
1時間計	8	19	27	8.5	7	10	17	7.5	15	29	44	8.1
13:00-13:15	3	3	6	1.9	0	1	1	0.4	3	4	7	1.3
13:15-13:30	1	3	4	1.3	1	1	2	0.9	2	4	6	1.1
13:30-13:45	0	5	5	1.6	0	3	3	1.3	0	8	8	1.5
13:45-14:00	2	4	6	1.9	2	4	6	2.6	4	8	12	2.2
1時間計	6	15	21	6.6	3	9	12	5.3	9	24	33	6.1

歩行者通行量調査表

調査地点：地域社会I 目黒

調査年月日：令和元年 5月11日(土) 天候：晴れ時々曇り

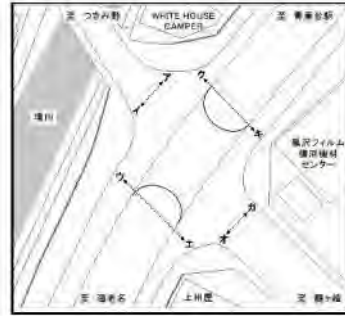

時間帯	方向				合計							
	歩行者 (人)	自転車 (台)	合計 (人・台)	時間 係数 (%)	歩行者 (人)	自転車 (台)	合計 (人・台)	時間 係数 (%)	歩行者 (人)	自転車 (台)	合計 (人・台)	時間 係数 (%)
14:00-14:15	2	1	3	0.9	0	1	1	0.4	2	2	4	0.7
14:15-14:30	3	4	7	2.2	2	2	4	1.8	5	6	11	2.0
14:30-14:45	1	3	4	1.3	0	5	5	2.2	1	8	9	1.7
14:45-15:00	1	9	10	3.2	1	9	10	4.4	2	18	20	3.7
1時間計	7	17	24	7.6	3	17	20	8.8	10	34	44	8.1
15:00-15:15	5	10	15	4.7	4	3	7	3.1	9	13	22	4.0
15:15-15:30	0	5	5	1.6	0	4	4	1.8	0	9	9	1.7
15:30-15:45	1	3	4	1.3	0	3	3	1.3	1	6	7	1.3
15:45-16:00	2	5	7	2.2	1	2	3	1.3	3	7	10	1.8
1時間計	8	23	31	9.8	5	12	17	7.5	13	35	48	8.8
16:00-16:15	0	5	5	1.6	3	3	6	2.6	3	8	11	2.0
16:15-16:30	1	2	3	0.9	2	7	9	4.0	3	9	12	2.2
16:30-16:45	4	2	6	1.9	1	3	4	1.8	5	5	10	1.8
16:45-17:00	5	2	7	2.2	3	7	10	4.4	8	9	17	3.1
1時間計	10	11	21	6.6	9	20	29	12.8	19	31	50	9.2
17:00-17:15	0	1	1	0.3	0	2	2	0.9	0	3	3	0.6
17:15-17:30	0	3	3	0.9	1	4	5	2.2	1	7	8	1.5
17:30-17:45	0	3	3	0.9	14	5	19	8.4	14	8	22	4.0
17:45-18:00	1	1	2	0.6	1	1	2	0.9	2	2	4	0.7
1時間計	1	8	9	2.8	16	12	28	12.3	17	20	37	6.8
18:00-18:15	0	2	2	0.6	2	2	4	1.8	2	4	6	1.1
18:15-18:30	1	3	4	1.3	0	5	5	2.2	1	8	9	1.7
18:30-18:45	2	1	3	0.9	2	0	2	0.9	4	1	5	0.9
18:45-19:00	1	1	2	0.6	0	4	4	1.8	1	5	6	1.1
1時間計	4	7	11	3.5	4	11	15	6.6	8	18	26	4.8
19:00-19:15	0	1	1	0.3	0	2	2	0.9	0	3	3	0.6
19:15-19:30	1	1	2	0.6	1	3	4	1.8	2	4	6	1.1
19:30-19:45	1	1	2	0.6	1	0	1	0.4	2	1	3	0.6
19:45-20:00	0	2	2	0.6	2	1	3	1.3	2	3	5	0.9
1時間計	2	5	7	2.2	4	6	10	4.4	6	11	17	3.1
20:00-20:15	1	1	2	0.6	1	1	2	0.9	2	2	4	0.7
20:15-20:30	1	2	3	0.9	0	1	1	0.4	1	3	4	0.7
20:30-20:45	0	0	0	0.0	0	1	1	0.4	0	1	1	0.2
20:45-21:00	1	0	1	0.3	0	0	0	0.0	1	0	1	0.2
1時間計	3	3	6	1.9	1	3	4	1.8	4	6	10	1.8
21:00-21:15	1	2	3	0.9	0	0	0	0.0	1	2	3	0.6
21:15-21:30	1	0	1	0.3	0	3	3	1.3	1	3	4	0.7
21:30-21:45	0	0	0	0.0	0	1	1	0.4	0	1	1	0.2
21:45-22:00	3	0	3	0.9	1	1	2	0.9	4	1	5	0.9
1時間計	5	2	7	2.2	1	5	6	2.6	6	7	13	2.4
昼12時間計	72	200	272	85.8	55	134	189	83.3	127	334	461	84.7
夜12時間計	19	26	45	14.2	13	25	38	16.7	32	51	83	15.3
全時間合計	91	226	317	100.0	68	159	227	100.0	159	385	544	100.0
昼夜率	1.26	1.13	1.17	-	1.24	1.19	1.20	-	1.25	1.15	1.18	-

歩行者通行量調査表

調査地点：地域社会1 目黒

調査年月日：令和元年 5月11日(土) 天候：晴れ時々曇り

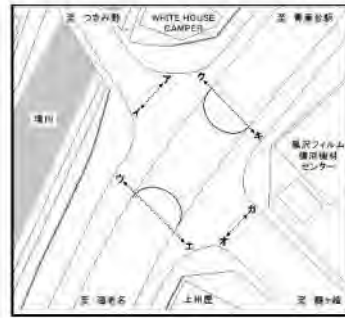

時間帯	キ				ク				合計			
	歩行者 (人)	自転車 (台)	合計 (人・台)	時間 係数 (%)	歩行者 (人)	自転車 (台)	合計 (人・台)	時間 係数 (%)	歩行者 (人)	自転車 (台)	合計 (人・台)	時間 係数 (%)
22:00-22:15	4	3	7	1.4	0	1	1	0.3	4	4	8	0.9
22:15-22:30	1	1	2	0.4	0	0	0	0.0	1	1	2	0.2
22:30-22:45	1	0	1	0.2	0	2	2	0.6	1	2	3	0.4
22:45-23:00	0	2	2	0.4	0	0	0	0.0	0	2	2	0.2
1時間計	6	6	12	2.5	0	3	3	0.8	6	9	15	1.8
23:00-23:15	0	0	0	0.0	0	0	0	0.0	0	0	0	0.0
23:15-23:30	1	1	2	0.4	0	2	2	0.6	1	3	4	0.5
23:30-23:45	0	0	0	0.0	0	0	0	0.0	0	0	0	0.0
23:45-24:00	1	0	1	0.2	0	0	0	0.0	1	0	1	0.1
1時間計	2	1	3	0.6	0	2	2	0.6	2	3	5	0.6
0:00-0:15	2	0	2	0.4	0	1	1	0.3	2	1	3	0.4
0:15-0:30	0	2	2	0.4	0	0	0	0.0	0	2	2	0.2
0:30-0:45	0	2	2	0.4	0	0	0	0.0	0	2	2	0.2
0:45-1:00	0	0	0	0.0	0	0	0	0.0	0	0	0	0.0
1時間計	2	4	6	1.2	0	1	1	0.3	2	5	7	0.8
1:00-1:15	1	0	1	0.2	0	0	0	0.0	1	0	1	0.1
1:15-1:30	0	0	0	0.0	0	0	0	0.0	0	0	0	0.0
1:30-1:45	2	0	2	0.4	0	0	0	0.0	2	0	2	0.2
1:45-2:00	0	0	0	0.0	0	1	1	0.3	0	1	1	0.1
1時間計	3	0	3	0.6	0	1	1	0.3	3	1	4	0.5
2:00-2:15	0	0	0	0.0	0	1	1	0.3	0	1	1	0.1
2:15-2:30	0	0	0	0.0	0	0	0	0.0	0	0	0	0.0
2:30-2:45	0	0	0	0.0	0	0	0	0.0	0	0	0	0.0
2:45-3:00	0	0	0	0.0	0	0	0	0.0	0	0	0	0.0
1時間計	0	0	0	0.0	0	1	1	0.3	0	1	1	0.1
3:00-3:15	0	0	0	0.0	0	0	0	0.0	0	0	0	0.0
3:15-3:30	4	2	6	1.2	0	0	0	0.0	4	2	6	0.7
3:30-3:45	0	0	0	0.0	0	0	0	0.0	0	0	0	0.0
3:45-4:00	0	0	0	0.0	0	0	0	0.0	0	0	0	0.0
1時間計	4	2	6	1.2	0	0	0	0.0	4	2	6	0.7
4:00-4:15	0	0	0	0.0	0	0	0	0.0	0	0	0	0.0
4:15-4:30	0	0	0	0.0	0	0	0	0.0	0	0	0	0.0
4:30-4:45	0	0	0	0.0	0	0	0	0.0	0	0	0	0.0
4:45-5:00	0	1	1	0.2	0	0	0	0.0	0	1	1	0.1
1時間計	0	1	1	0.2	0	0	0	0.0	0	1	1	0.1
5:00-5:15	0	0	0	0.0	0	0	0	0.0	0	0	0	0.0
5:15-5:30	0	1	1	0.2	1	4	5	1.4	1	5	6	0.7
5:30-5:45	2	1	3	0.6	0	0	0	0.0	2	1	3	0.4
5:45-6:00	0	2	2	0.4	2	0	2	0.6	2	2	4	0.5
1時間計	2	4	6	1.2	3	4	7	1.9	5	8	13	1.6

歩行者通行量調査表

調査地点：地域社会1 目黒

調査年月日：令和元年 5月11日(土) 天候：晴れ時々曇り

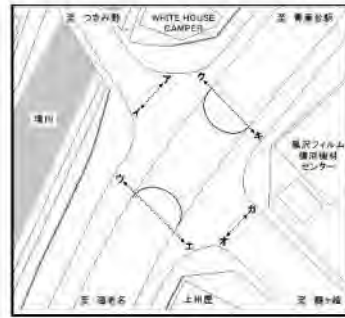

時間帯	キ				ケ				合計			
	歩行者 (人)	自転車 (台)	合計 (人・台)	時間係数 (%)	歩行者 (人)	自転車 (台)	合計 (人・台)	時間係数 (%)	歩行者 (人)	自転車 (台)	合計 (人・台)	時間係数 (%)
6:00-6:15	1	3	4	0.8	0	0	0	0.0	1	3	4	0.5
6:15-6:30	0	0	0	0.0	2	0	2	0.6	2	0	2	0.2
6:30-6:45	2	2	4	0.8	5	1	6	1.7	7	3	10	1.2
6:45-7:00	2	6	8	1.7	6	1	7	1.9	8	7	15	1.8
1時間計	5	11	16	3.3	13	2	15	4.2	18	13	31	3.7
7:00-7:15	3	3	6	1.2	9	2	11	3.0	12	5	17	2.0
7:15-7:30	1	2	3	0.6	2	4	6	1.7	3	6	9	1.1
7:30-7:45	4	6	10	2.1	4	5	9	2.5	8	11	19	2.3
7:45-8:00	6	2	8	1.7	1	4	5	1.4	7	6	13	1.5
1時間計	14	13	27	5.6	16	15	31	8.6	30	28	58	6.9
8:00-8:15	2	6	8	1.7	4	3	7	1.9	6	9	15	1.8
8:15-8:30	5	13	18	3.7	0	2	2	0.6	5	15	20	2.4
8:30-8:45	2	6	8	1.7	1	2	3	0.8	3	8	11	1.3
8:45-9:00	2	6	8	1.7	0	5	5	1.4	2	11	13	1.5
1時間計	11	31	42	8.7	5	12	17	4.7	16	43	59	7.0
9:00-9:15	0	3	3	0.6	0	0	0	0.0	0	3	3	0.4
9:15-9:30	1	5	6	1.2	0	2	2	0.6	1	7	8	0.9
9:30-9:45	2	6	8	1.7	2	0	2	0.6	4	6	10	1.2
9:45-10:00	0	2	2	0.4	2	6	8	2.2	2	8	10	1.2
1時間計	3	16	19	3.9	4	8	12	3.3	7	24	31	3.7
10:00-10:15	0	0	0	0.0	1	1	2	0.6	1	1	2	0.2
10:15-10:30	0	1	1	0.2	0	1	1	0.3	0	2	2	0.2
10:30-10:45	7	5	12	2.5	0	2	2	0.6	7	7	14	1.7
10:45-11:00	2	5	7	1.4	2	5	7	1.9	4	10	14	1.7
1時間計	9	11	20	4.1	3	9	12	3.3	12	20	32	3.8
11:00-11:15	0	3	3	0.6	1	3	4	1.1	1	6	7	0.8
11:15-11:30	3	9	12	2.5	1	7	8	2.2	4	16	20	2.4
11:30-11:45	1	8	9	1.9	3	8	11	3.0	4	16	20	2.4
11:45-12:00	1	8	9	1.9	3	5	8	2.2	4	13	17	2.0
1時間計	5	28	33	6.8	8	23	31	8.6	13	51	64	7.6
12:00-12:15	1	5	6	1.2	4	4	8	2.2	5	9	14	1.7
12:15-12:30	0	7	7	1.4	4	6	10	2.8	4	13	17	2.0
12:30-12:45	2	7	9	1.9	4	2	6	1.7	6	9	15	1.8
12:45-13:00	5	2	7	1.4	0	3	3	0.8	5	5	10	1.2
1時間計	8	21	29	6.0	12	15	27	7.5	20	36	56	6.6
13:00-13:15	3	8	11	2.3	2	3	5	1.4	5	11	16	1.9
13:15-13:30	4	6	10	2.1	4	2	6	1.7	8	8	16	1.9
13:30-13:45	5	6	11	2.3	2	7	9	2.5	7	13	20	2.4
13:45-14:00	1	7	8	1.7	4	9	13	3.6	5	16	21	2.5
1時間計	13	27	40	8.3	12	21	33	9.1	25	48	73	8.6

歩行者通行量調査表

調査地点：地域社会1 目黒

調査年月日：令和元年 5月11日(土) 天候：晴れ時々曇り

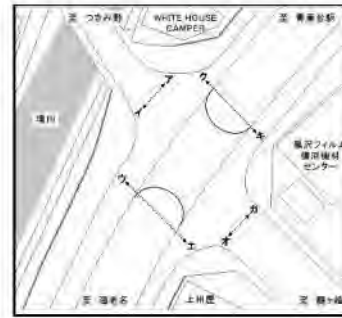

時間帯	キ				ケ				合計			
	歩行者 (人)	自転車 (台)	合計 (人・台)	時間 係数 (%)	歩行者 (人)	自転車 (台)	合計 (人・台)	時間 係数 (%)	歩行者 (人)	自転車 (台)	合計 (人・台)	時間 係数 (%)
14:00-14:15	2	13	15	3.1	2	4	6	1.7	4	17	21	2.5
14:15-14:30	3	6	9	1.9	1	5	6	1.7	4	11	15	1.8
14:30-14:45	2	12	14	2.9	2	4	6	1.7	4	16	20	2.4
14:45-15:00	3	9	12	2.5	3	5	8	2.2	6	14	20	2.4
1時間計	10	40	50	10.4	8	18	26	7.2	18	58	76	9.0
15:00-15:15	4	6	10	2.1	0	1	1	0.3	4	7	11	1.3
15:15-15:30	0	8	8	1.7	8	3	11	3.0	8	11	19	2.3
15:30-15:45	4	4	8	1.7	0	4	4	1.1	4	8	12	1.4
15:45-16:00	2	6	8	1.7	1	3	4	1.1	3	9	12	1.4
1時間計	10	24	34	7.0	9	11	20	5.5	19	35	54	6.4
16:00-16:15	2	6	8	1.7	2	4	6	1.7	4	10	14	1.7
16:15-16:30	2	3	5	1.0	1	4	5	1.4	3	7	10	1.2
16:30-16:45	4	3	7	1.4	5	4	9	2.5	9	7	16	1.9
16:45-17:00	2	6	8	1.7	10	2	12	3.3	12	8	20	2.4
1時間計	10	18	28	5.8	18	14	32	8.9	28	32	60	7.1
17:00-17:15	5	6	11	2.3	5	6	11	3.0	10	12	22	2.6
17:15-17:30	6	7	13	2.7	2	8	10	2.8	8	15	23	2.7
17:30-17:45	7	6	13	2.7	14	4	18	5.0	21	10	31	3.7
17:45-18:00	4	9	13	2.7	3	10	13	3.6	7	19	26	3.1
1時間計	22	28	50	10.4	24	28	52	14.4	46	56	102	12.1
18:00-18:15	1	4	5	1.0	0	0	0	0.0	1	4	5	0.6
18:15-18:30	5	6	11	2.3	3	5	8	2.2	8	11	19	2.3
18:30-18:45	1	3	4	0.8	3	1	4	1.1	4	4	8	0.9
18:45-19:00	2	8	10	2.1	0	3	3	0.8	2	11	13	1.6
1時間計	9	21	30	6.2	6	9	15	4.2	15	30	45	5.3
19:00-19:15	0	5	5	1.0	3	5	8	2.2	3	10	13	1.6
19:15-19:30	1	4	5	1.0	2	9	11	3.0	3	13	16	1.9
19:30-19:45	1	6	7	1.4	3	0	3	0.8	4	6	10	1.2
19:45-20:00	1	1	2	0.4	0	1	1	0.3	1	2	3	0.4
1時間計	3	16	19	3.9	8	15	23	6.4	11	31	42	5.0
20:00-20:15	0	0	0	0.0	0	0	0	0.0	0	0	0	0.0
20:15-20:30	0	0	0	0.0	0	0	0	0.0	0	0	0	0.0
20:30-20:45	0	0	0	0.0	0	0	0	0.0	0	0	0	0.0
20:45-21:00	0	0	0	0.0	0	0	0	0.0	0	0	0	0.0
1時間計	0	0	0	0.0	0	0	0	0.0	0	0	0	0.0
21:00-21:15	1	2	3	0.6	0	0	0	0.0	1	2	3	0.4
21:15-21:30	0	5	5	1.0	0	0	0	0.0	0	5	5	0.6
21:30-21:45	0	1	1	0.2	0	0	0	0.0	0	1	1	0.1
21:45-22:00	0	0	0	0.0	0	0	0	0.0	0	0	0	0.0
1時間計	1	8	9	1.9	0	0	0	0.0	1	8	9	1.1
昼12時間計	124	278	402	83.2	125	183	308	85.3	249	461	710	84.1
夜12時間計	28	53	81	16.8	24	29	53	14.7	52	82	134	15.9
全時間合計	152	331	483	100.0	149	212	361	100.0	301	543	844	100.0
昼夜率	1.23	1.19	1.20	-	1.19	1.16	1.17	-	1.21	1.18	1.19	-

歩行者通行量調査表

調査地点：地域社会) 目黒

調査年月日：令和元年 5月11日(土) 天候：晴れ時々曇り

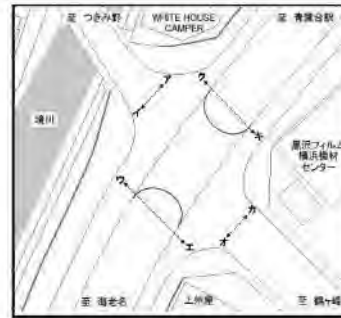

時間帯	種別	合計 (7+イ+ウ+エ+オ+カ+キ+ク)			時間係数 (%)
		歩行者 (人)	自転車 (台)	合計 (人・台)	
22:00-22:15		8	10	18	0.7
22:15-22:30		4	6	10	0.4
22:30-22:45		8	4	12	0.4
22:45-23:00		0	9	9	0.3
1時間計		20	29	49	1.8
23:00-23:15		5	3	8	0.3
23:15-23:30		4	6	10	0.4
23:30-23:45		2	0	2	0.1
23:45-24:00		6	0	6	0.2
1時間計		17	9	26	1.0
0:00-0:15		3	4	7	0.3
0:15-0:30		0	3	3	0.1
0:30-0:45		3	3	6	0.2
0:45-1:00		2	1	3	0.1
1時間計		8	11	19	0.7
1:00-1:15		2	0	2	0.1
1:15-1:30		1	0	1	0.0
1:30-1:45		3	0	3	0.1
1:45-2:00		0	1	1	0.0
1時間計		6	1	7	0.3
2:00-2:15		0	2	2	0.1
2:15-2:30		0	4	4	0.1
2:30-2:45		0	0	0	0.0
2:45-3:00		1	0	1	0.0
1時間計		1	6	7	0.3
3:00-3:15		1	1	2	0.1
3:15-3:30		5	3	8	0.3
3:30-3:45		0	0	0	0.0
3:45-4:00		1	0	1	0.0
1時間計		7	4	11	0.4
4:00-4:15		1	0	1	0.0
4:15-4:30		0	1	1	0.0
4:30-4:45		0	0	0	0.0
4:45-5:00		0	1	1	0.0
1時間計		1	2	3	0.1
5:00-5:15		0	4	4	0.1
5:15-5:30		5	16	21	0.8
5:30-5:45		4	5	9	0.3
5:45-6:00		4	3	7	0.3
1時間計		13	28	41	1.5
6:00-6:15		5	8	13	0.5
6:15-6:30		3	5	8	0.3
6:30-6:45		9	12	21	0.8
6:45-7:00		9	14	23	0.9
1時間計		26	39	65	2.4
7:00-7:15		14	11	25	0.9
7:15-7:30		8	11	19	0.7
7:30-7:45		18	29	47	1.7
7:45-8:00		17	24	41	1.5
1時間計		57	75	132	4.9
8:00-8:15		10	32	42	1.6
8:15-8:30		11	40	51	1.9
8:30-8:45		11	47	58	2.2
8:45-9:00		8	28	36	1.3
1時間計		40	147	187	6.9
9:00-9:15		8	28	36	1.3
9:15-9:30		17	36	53	2.0
9:30-9:45		11	32	43	1.6
9:45-10:00		12	44	56	2.1
1時間計		48	140	188	7.0

時間帯	種別	合計 (7+イ+ウ+エ+オ+カ+キ+ク)			時間係数 (%)
		歩行者 (人)	自転車 (台)	合計 (人・台)	
22:00-23:00		20	29	49	1.8
22:15-23:15		17	22	39	1.4
22:30-23:30		17	22	39	1.4
22:45-23:45		11	18	29	1.1
23:00-0:00		17	9	26	1.0
23:15-0:15		15	10	25	0.9
23:30-0:30		11	7	18	0.7
23:45-0:45		12	10	22	0.8
0:00-1:00		8	11	19	0.7
0:15-1:15		7	7	14	0.5
0:30-1:30		8	4	12	0.4
0:45-1:45		8	1	9	0.3
1:00-2:00		6	1	7	0.3
1:15-2:15		4	3	7	0.3
1:30-2:30		3	7	10	0.4
1:45-2:45		0	7	7	0.3
2:00-3:00		1	6	7	0.3
2:15-3:15		2	5	7	0.3
2:30-3:30		7	4	11	0.4
2:45-3:45		7	4	11	0.4
3:00-4:00		7	4	11	0.4
3:15-4:15		7	3	10	0.4
3:30-4:30		2	1	3	0.1
3:45-4:45		2	1	3	0.1
4:00-5:00		1	2	3	0.1
4:15-5:15		0	6	6	0.2
4:30-5:30		5	21	26	1.0
4:45-5:45		9	26	35	1.3
5:00-6:00		13	28	41	1.5
5:15-6:15		18	32	50	1.9
5:30-6:30		16	21	37	1.4
5:45-6:45		21	28	49	1.8
6:00-7:00		26	39	65	2.4
6:15-7:15		35	42	77	2.9
6:30-7:30		40	48	88	3.3
6:45-7:45		49	65	114	4.2
7:00-8:00		57	75	132	4.9
7:15-8:15		53	96	149	5.5
7:30-8:30		56	125	181	6.7
7:45-8:45		49	143	192	7.1
8:00-9:00		40	147	187	6.9
8:15-9:15		38	143	181	6.7
8:30-9:30		44	139	183	6.8
8:45-9:45		44	124	168	6.2
9:00-10:00		48	140	188	7.0
9:15-10:15		43	137	180	6.7
9:30-10:30		30	127	157	5.8
9:45-10:45		34	132	166	6.2
10:00-11:00		34	118	152	5.6
10:15-11:15		41	118	159	5.9
10:30-11:30		46	123	169	6.3
10:45-11:45		46	129	175	6.5
11:00-12:00		55	145	200	7.4
11:15-12:15		95	146	231	8.6
11:30-12:30		92	152	244	9.0
11:45-12:45		96	137	233	8.6
12:00-13:00		86	118	204	7.6
12:15-13:15		61	121	182	6.7
12:30-13:30		58	103	161	6.0
12:45-13:45		46	101	147	5.5

歩行者通行量調査表

調査地点：地域社会) 目黒

調査年月日：令和元年 5月11日(土) 天候：晴れ時々曇り

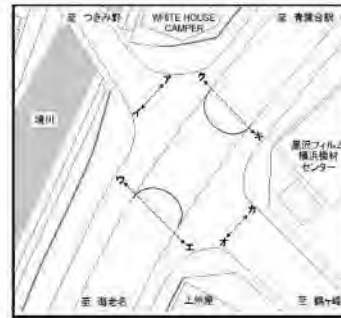

時間帯	種別	合計 (7+イ+ウ+E+オ+カ+キ+ク)			時間係数 (%)
		歩行者 (人)	自転車 (台)	合計 (人・台)	
10:00-10:15		3	25	28	1.0
10:15-10:30		4	26	30	1.1
10:30-10:45		15	37	52	1.9
10:45-11:00		12	30	42	1.6
1時間計		34	118	152	5.6
11:00-11:15		10	25	35	1.3
11:15-11:30		9	31	40	1.5
11:30-11:45		15	43	58	2.2
11:45-12:00		21	46	67	2.5
1時間計		55	145	200	7.4
12:00-12:15		40	26	66	2.4
12:15-12:30		16	37	53	2.0
12:30-12:45		19	28	47	1.7
12:45-13:00		11	27	38	1.4
1時間計		86	118	204	7.6
13:00-13:15		15	29	44	1.6
13:15-13:30		13	19	32	1.2
13:30-13:45		7	26	33	1.2
13:45-14:00		12	40	52	1.9
1時間計		47	114	161	6.0
14:00-14:15		13	44	57	2.1
14:15-14:30		17	33	50	1.9
14:30-14:45		13	40	53	2.0
14:45-15:00		11	49	60	2.2
1時間計		54	166	220	8.2
15:00-15:15		23	34	57	2.1
15:15-15:30		14	29	43	1.6
15:30-15:45		7	31	38	1.4
15:45-16:00		11	26	37	1.4
1時間計		55	120	175	6.5
16:00-16:15		29	30	59	2.2
16:15-16:30		19	33	52	1.9
16:30-16:45		22	45	67	2.5
16:45-17:00		38	33	71	2.6
1時間計		108	141	249	9.2
17:00-17:15		22	41	63	2.3
17:15-17:30		17	44	61	2.3
17:30-17:45		60	34	94	3.5
17:45-18:00		11	31	42	1.6
1時間計		110	150	260	9.6
18:00-18:15		9	13	22	0.8
18:15-18:30		13	30	43	1.6
18:30-18:45		18	18	36	1.3
18:45-19:00		7	28	35	1.3
1時間計		47	89	136	5.0
19:00-19:15		10	20	30	1.1
19:15-19:30		8	24	32	1.2
19:30-19:45		11	14	25	0.9
19:45-20:00		14	13	27	1.0
1時間計		43	71	114	4.2
20:00-20:15		4	2	6	0.2
20:15-20:30		3	10	13	0.5
20:30-20:45		1	4	5	0.2
20:45-21:00		2	6	8	0.3
1時間計		10	22	32	1.2
21:00-21:15		4	14	18	0.7
21:15-21:30		8	15	23	0.9
21:30-21:45		3	7	10	0.4
21:45-22:00		7	1	8	0.3
1時間計		22	37	59	2.2
昼12時間計		741	1523	2264	83.9
夜12時間計		174	259	433	16.1
全時間合計		915	1782	2697	100.0
昼夜率		1.23	1.17	1.19	-

時間帯	種別	合計 (7+イ+ウ+E+オ+カ+キ+ク)			時間係数 (%)
		歩行者 (人)	自転車 (台)	合計 (人・台)	
13:00-14:00		47	114	161	6.0
13:15-14:15		45	129	174	6.5
13:30-14:30		49	143	192	7.1
13:45-14:45		55	157	212	7.9
14:00-15:00		54	166	220	8.2
14:15-15:15		64	156	220	8.2
14:30-15:30		61	152	213	7.9
14:45-15:45		55	143	198	7.3
15:00-16:00		55	120	175	6.5
15:15-16:15		61	116	177	6.6
15:30-16:30		66	120	186	6.9
15:45-16:45		81	134	215	8.0
16:00-17:00		108	141	249	9.2
16:15-17:15		101	152	253	9.4
16:30-17:30		99	163	262	9.7
16:45-17:45		137	152	289	10.7
17:00-18:00		110	150	260	9.6
17:15-18:15		97	122	219	8.1
17:30-18:30		93	108	201	7.5
17:45-18:45		51	92	143	5.3
18:00-19:00		47	89	136	5.0
18:15-19:15		48	96	144	5.3
18:30-19:30		43	90	133	4.9
18:45-19:45		36	86	122	4.5
19:00-20:00		43	71	114	4.2
19:15-20:15		37	53	90	3.3
19:30-20:30		32	39	71	2.6
19:45-20:45		22	29	51	1.9
20:00-21:00		10	22	32	1.2
20:15-21:15		10	34	44	1.6
20:30-21:30		15	39	54	2.0
20:45-21:45		17	42	59	2.2
21:00-22:00		22	37	59	2.2
全時間合計		915	1,782	2,697	100.0

歩行者通行量調査表

調査地点：地域社会2 目黒交番前

調査年月日：令和元年 5月11日(土) 天候：晴れ時々曇り



時間帯	ア				イ				合計			
	歩行者 (人)	自転車 (台)	合計 (人・台)	時間 係数 (%)	歩行者 (人)	自転車 (台)	合計 (人・台)	時間 係数 (%)	歩行者 (人)	自転車 (台)	合計 (人・台)	時間 係数 (%)
22:00-22:15	0	1	1	0.6	0	0	0	0.0	0	1	1	0.4
22:15-22:30	0	0	0	0.0	0	0	0	0.0	0	0	0	0.0
22:30-22:45	0	0	0	0.0	0	0	0	0.0	0	0	0	0.0
22:45-23:00	2	1	3	1.8	0	0	0	0.0	2	1	3	1.2
1時間計	2	2	4	2.4	0	0	0	0.0	2	2	4	1.6
23:00-23:15	0	1	1	0.6	0	0	0	0.0	0	1	1	0.4
23:15-23:30	0	0	0	0.0	0	0	0	0.0	0	0	0	0.0
23:30-23:45	0	0	0	0.0	0	0	0	0.0	0	0	0	0.0
23:45-24:00	0	0	0	0.0	0	1	1	1.1	0	1	1	0.4
1時間計	0	1	1	0.6	0	1	1	1.1	0	2	2	0.8
0:00-0:15	0	0	0	0.0	0	1	1	1.1	0	1	1	0.4
0:15-0:30	0	0	0	0.0	0	0	0	0.0	0	0	0	0.0
0:30-0:45	0	0	0	0.0	0	0	0	0.0	0	0	0	0.0
0:45-1:00	0	0	0	0.0	0	0	0	0.0	0	0	0	0.0
1時間計	0	0	0	0.0	0	1	1	1.1	0	1	1	0.4
1:00-1:15	0	1	1	0.6	0	0	0	0.0	0	1	1	0.4
1:15-1:30	0	1	1	0.6	0	0	0	0.0	0	1	1	0.4
1:30-1:45	0	0	0	0.0	0	0	0	0.0	0	0	0	0.0
1:45-2:00	0	0	0	0.0	0	0	0	0.0	0	0	0	0.0
1時間計	0	2	2	1.2	0	0	0	0.0	0	2	2	0.8
2:00-2:15	0	0	0	0.0	0	0	0	0.0	0	0	0	0.0
2:15-2:30	0	0	0	0.0	0	0	0	0.0	0	0	0	0.0
2:30-2:45	0	1	1	0.6	0	0	0	0.0	0	1	1	0.4
2:45-3:00	0	0	0	0.0	0	0	0	0.0	0	0	0	0.0
1時間計	0	1	1	0.6	0	0	0	0.0	0	1	1	0.4
3:00-3:15	0	0	0	0.0	0	1	1	1.1	0	1	1	0.4
3:15-3:30	2	0	2	1.2	0	0	0	0.0	2	0	2	0.8
3:30-3:45	0	0	0	0.0	0	0	0	0.0	0	0	0	0.0
3:45-4:00	0	0	0	0.0	0	0	0	0.0	0	0	0	0.0
1時間計	2	0	2	1.2	0	1	1	1.1	2	1	3	1.2
4:00-4:15	0	0	0	0.0	0	0	0	0.0	0	0	0	0.0
4:15-4:30	0	0	0	0.0	0	0	0	0.0	0	0	0	0.0
4:30-4:45	0	0	0	0.0	0	0	0	0.0	0	0	0	0.0
4:45-5:00	0	1	1	0.6	0	0	0	0.0	0	1	1	0.4
1時間計	0	1	1	0.6	0	0	0	0.0	0	1	1	0.4
5:00-5:15	0	0	0	0.0	0	0	0	0.0	0	0	0	0.0
5:15-5:30	0	1	1	0.6	0	0	0	0.0	0	1	1	0.4
5:30-5:45	0	0	0	0.0	0	0	0	0.0	0	0	0	0.0
5:45-6:00	0	1	1	0.6	0	0	0	0.0	0	1	1	0.4
1時間計	0	2	2	1.2	0	0	0	0.0	0	2	2	0.8

歩行者通行量調査表

調査地点：地域社会2 目黒交番前

調査年月日：令和元年 5月11日(土) 天候：晴れ時々曇り



時間帯	方向				イ				合計			
	歩行者 (人)	自転車 (台)	合計 (人・台)	時間 係数 (%)	歩行者 (人)	自転車 (台)	合計 (人・台)	時間 係数 (%)	歩行者 (人)	自転車 (台)	合計 (人・台)	時間 係数 (%)
6:00-6:15	0	0	0	0.0	0	0	0	0.0	0	0	0	0.0
6:15-6:30	0	1	1	0.6	0	0	0	0.0	0	1	1	0.4
6:30-6:45	1	4	5	3.0	0	0	0	0.0	1	4	5	1.9
6:45-7:00	0	1	1	0.6	2	1	3	3.3	2	2	4	1.6
1時間計	1	6	7	4.2	2	1	3	3.3	3	7	10	3.9
7:00-7:15	0	2	2	1.2	0	1	1	1.1	0	3	3	1.2
7:15-7:30	0	1	1	0.6	0	0	0	0.0	0	1	1	0.4
7:30-7:45	0	1	1	0.6	0	0	0	0.0	0	1	1	0.4
7:45-8:00	1	1	2	1.2	0	0	0	0.0	1	1	2	0.8
1時間計	1	5	6	3.6	0	1	1	1.1	1	6	7	2.7
8:00-8:15	3	0	3	1.8	0	2	2	2.2	3	2	5	1.9
8:15-8:30	0	4	4	2.4	1	1	2	2.2	1	5	6	2.3
8:30-8:45	0	1	1	0.6	1	3	4	4.4	1	4	5	1.9
8:45-9:00	0	1	1	0.6	1	3	4	4.4	1	4	5	1.9
1時間計	3	6	9	5.4	3	9	12	13.3	6	15	21	8.2
9:00-9:15	0	0	0	0.0	0	2	2	2.2	0	2	2	0.8
9:15-9:30	0	0	0	0.0	0	0	0	0.0	0	0	0	0.0
9:30-9:45	0	1	1	0.6	0	0	0	0.0	0	1	1	0.4
9:45-10:00	0	4	4	2.4	0	2	2	2.2	0	6	6	2.3
1時間計	0	5	5	3.0	0	4	4	4.4	0	9	9	3.5
10:00-10:15	2	2	4	2.4	0	3	3	3.3	2	5	7	2.7
10:15-10:30	0	2	2	1.2	0	1	1	1.1	0	3	3	1.2
10:30-10:45	0	1	1	0.6	0	1	1	1.1	0	2	2	0.8
10:45-11:00	0	2	2	1.2	0	2	2	2.2	0	4	4	1.6
1時間計	2	7	9	5.4	0	7	7	7.8	2	14	16	6.2
11:00-11:15	0	6	6	3.6	0	0	0	0.0	0	6	6	2.3
11:15-11:30	0	2	2	1.2	0	2	2	2.2	0	4	4	1.6
11:30-11:45	0	1	1	0.6	0	1	1	1.1	0	2	2	0.8
11:45-12:00	0	2	2	1.2	0	5	5	5.6	0	7	7	2.7
1時間計	0	11	11	6.6	0	8	8	8.9	0	19	19	7.4
12:00-12:15	1	2	3	1.8	0	1	1	1.1	1	3	4	1.6
12:15-12:30	0	1	1	0.6	2	3	5	5.6	2	4	6	2.3
12:30-12:45	1	0	1	0.6	0	2	2	2.2	1	2	3	1.2
12:45-13:00	0	4	4	2.4	0	0	0	0.0	0	4	4	1.6
1時間計	2	7	9	5.4	2	6	8	8.9	4	13	17	6.6
13:00-13:15	0	4	4	2.4	0	2	2	2.2	0	6	6	2.3
13:15-13:30	0	2	2	1.2	0	0	0	0.0	0	2	2	0.8
13:30-13:45	0	2	2	1.2	0	1	1	1.1	0	3	3	1.2
13:45-14:00	0	0	0	0.0	0	1	1	1.1	0	1	1	0.4
1時間計	0	8	8	4.8	0	4	4	4.4	0	12	12	4.7

歩行者通行量調査表

調査地点：地域社会2 目黒交番前

調査年月日：令和元年 5月11日(土) 天候：晴れ時々曇り



時間帯	ア				イ				合計			
	歩行者 (人)	自転車 (台)	合計 (人・台)	時間 係数 (%)	歩行者 (人)	自転車 (台)	合計 (人・台)	時間 係数 (%)	歩行者 (人)	自転車 (台)	合計 (人・台)	時間 係数 (%)
14:00-14:15	2	5	7	4.2	2	1	3	3.3	4	6	10	3.9
14:15-14:30	0	4	4	2.4	0	0	0	0.0	0	4	4	1.6
14:30-14:45	0	7	7	4.2	0	1	1	1.1	0	8	8	3.1
14:45-15:00	0	5	5	3.0	1	0	1	1.1	1	5	6	2.3
1時間計	2	21	23	13.8	3	2	5	5.6	5	23	28	10.9
15:00-15:15	0	3	3	1.8	0	3	3	3.3	0	6	6	2.3
15:15-15:30	0	8	8	4.8	0	1	1	1.1	0	9	9	3.5
15:30-15:45	0	2	2	1.2	2	4	6	6.7	2	6	8	3.1
15:45-16:00	1	1	2	1.2	0	0	0	0.0	1	1	2	0.8
1時間計	1	14	15	9.0	2	8	10	11.1	3	22	25	9.7
16:00-16:15	0	4	4	2.4	0	1	1	1.1	0	5	5	1.9
16:15-16:30	1	4	5	3.0	1	1	2	2.2	2	5	7	2.7
16:30-16:45	1	0	1	0.6	0	0	0	0.0	1	0	1	0.4
16:45-17:00	0	2	2	1.2	0	1	1	1.1	0	3	3	1.2
1時間計	2	10	12	7.2	1	3	4	4.4	3	13	16	6.2
17:00-17:15	1	1	2	1.2	0	2	2	2.2	1	3	4	1.6
17:15-17:30	0	3	3	1.8	1	0	1	1.1	1	3	4	1.6
17:30-17:45	1	0	1	0.6	0	0	0	0.0	1	0	1	0.4
17:45-18:00	0	1	1	0.6	0	1	1	1.1	0	2	2	0.8
1時間計	2	5	7	4.2	1	3	4	4.4	3	8	11	4.3
18:00-18:15	1	1	2	1.2	1	1	2	2.2	2	2	4	1.6
18:15-18:30	5	1	6	3.6	0	1	1	1.1	5	2	7	2.7
18:30-18:45	1	0	1	0.6	1	0	1	1.1	2	0	2	0.8
18:45-19:00	0	0	0	0.0	0	0	0	0.0	0	0	0	0.0
1時間計	7	2	9	5.4	2	2	4	4.4	9	4	13	5.1
19:00-19:15	0	5	5	3.0	0	2	2	2.2	0	7	7	2.7
19:15-19:30	1	3	4	2.4	1	1	2	2.2	2	4	6	2.3
19:30-19:45	1	2	3	1.8	0	0	0	0.0	1	2	3	1.2
19:45-20:00	0	2	2	1.2	1	1	2	2.2	1	3	4	1.6
1時間計	2	12	14	8.4	2	4	6	6.7	4	16	20	7.8
20:00-20:15	0	1	1	0.6	0	1	1	1.1	0	2	2	0.8
20:15-20:30	1	1	2	1.2	0	1	1	1.1	1	2	3	1.2
20:30-20:45	0	0	0	0.0	0	0	0	0.0	0	0	0	0.0
20:45-21:00	0	1	1	0.6	0	3	3	3.3	0	4	4	1.6
1時間計	1	3	4	2.4	0	5	5	5.6	1	8	9	3.5
21:00-21:15	0	1	1	0.6	0	0	0	0.0	0	1	1	0.4
21:15-21:30	0	1	1	0.6	0	1	1	1.1	0	2	2	0.8
21:30-21:45	0	1	1	0.6	0	1	1	1.1	0	2	2	0.8
21:45-22:00	1	2	3	1.8	0	0	0	0.0	1	2	3	1.2
1時間計	1	5	6	3.6	0	2	2	2.2	1	7	8	3.1
昼12時間計	22	101	123	73.7	14	57	71	78.9	36	158	194	75.5
夜12時間計	9	35	44	26.3	4	15	19	21.1	13	50	63	24.5
全時間合計	31	136	167	100.0	18	72	90	100.0	49	208	257	100.0
昼夜率	1.41	1.35	1.36	-	1.29	1.26	1.27	-	1.36	1.32	1.32	-

歩行者通行量調査表

調査地点：地域社会2 目黒交番前

調査年月日：令和元年 5月11日(土) 天候：晴れ時々曇り



時間帯	ウ				エ				合計			
	歩行者 (人)	自転車 (台)	合計 (人・台)	時間 係数 (%)	歩行者 (人)	自転車 (台)	合計 (人・台)	時間 係数 (%)	歩行者 (人)	自転車 (台)	合計 (人・台)	時間 係数 (%)
22:00-22:15	0	0	0	0.0	0	0	0	0.0	0	0	0	0.0
22:15-22:30	0	0	0	0.0	0	0	0	0.0	0	0	0	0.0
22:30-22:45	0	0	0	0.0	0	0	0	0.0	0	0	0	0.0
22:45-23:00	0	0	0	0.0	0	0	0	0.0	0	0	0	0.0
1時間計	0	0	0	0.0	0	0	0	0.0	0	0	0	0.0
23:00-23:15	1	0	1	1.0	0	0	0	0.0	1	0	1	0.5
23:15-23:30	0	0	0	0.0	0	0	0	0.0	0	0	0	0.0
23:30-23:45	0	1	1	1.0	0	0	0	0.0	0	1	1	0.5
23:45-24:00	1	0	1	1.0	0	1	1	1.2	1	1	2	1.1
1時間計	2	1	3	3.0	0	1	1	1.2	2	2	4	2.2
0:00-0:15	0	0	0	0.0	0	0	0	0.0	0	0	0	0.0
0:15-0:30	0	0	0	0.0	0	0	0	0.0	0	0	0	0.0
0:30-0:45	0	0	0	0.0	0	1	1	1.2	0	1	1	0.5
0:45-1:00	0	0	0	0.0	0	0	0	0.0	0	0	0	0.0
1時間計	0	0	0	0.0	0	1	1	1.2	0	1	1	0.5
1:00-1:15	0	0	0	0.0	0	0	0	0.0	0	0	0	0.0
1:15-1:30	0	0	0	0.0	0	0	0	0.0	0	0	0	0.0
1:30-1:45	0	0	0	0.0	0	0	0	0.0	0	0	0	0.0
1:45-2:00	0	0	0	0.0	0	0	0	0.0	0	0	0	0.0
1時間計	0	0	0	0.0	0	0	0	0.0	0	0	0	0.0
2:00-2:15	0	0	0	0.0	0	0	0	0.0	0	0	0	0.0
2:15-2:30	0	0	0	0.0	0	0	0	0.0	0	0	0	0.0
2:30-2:45	0	0	0	0.0	0	0	0	0.0	0	0	0	0.0
2:45-3:00	0	0	0	0.0	0	0	0	0.0	0	0	0	0.0
1時間計	0	0	0	0.0	0	0	0	0.0	0	0	0	0.0
3:00-3:15	0	0	0	0.0	0	0	0	0.0	0	0	0	0.0
3:15-3:30	0	0	0	0.0	0	0	0	0.0	0	0	0	0.0
3:30-3:45	0	0	0	0.0	0	0	0	0.0	0	0	0	0.0
3:45-4:00	0	0	0	0.0	0	0	0	0.0	0	0	0	0.0
1時間計	0	0	0	0.0	0	0	0	0.0	0	0	0	0.0
4:00-4:15	0	0	0	0.0	0	0	0	0.0	0	0	0	0.0
4:15-4:30	0	0	0	0.0	0	0	0	0.0	0	0	0	0.0
4:30-4:45	0	0	0	0.0	0	0	0	0.0	0	0	0	0.0
4:45-5:00	0	0	0	0.0	0	0	0	0.0	0	0	0	0.0
1時間計	0	0	0	0.0	0	0	0	0.0	0	0	0	0.0
5:00-5:15	0	0	0	0.0	0	0	0	0.0	0	0	0	0.0
5:15-5:30	0	0	0	0.0	0	0	0	0.0	0	0	0	0.0
5:30-5:45	0	0	0	0.0	0	0	0	0.0	0	0	0	0.0
5:45-6:00	0	0	0	0.0	0	0	0	0.0	0	0	0	0.0
1時間計	0	0	0	0.0	0	0	0	0.0	0	0	0	0.0

歩行者通行量調査表

調査地点：地域社会2 目黒交番前

調査年月日：令和元年 5月11日(土) 天候：晴れ時々曇り



時間帯	ウ				エ				合計			
	歩行者 (人)	自転車 (台)	合計 (人・台)	時間 係数 (%)	歩行者 (人)	自転車 (台)	合計 (人・台)	時間 係数 (%)	歩行者 (人)	自転車 (台)	合計 (人・台)	時間 係数 (%)
6:00-6:15	0	0	0	0.0	0	0	0	0.0	0	0	0	0.0
6:15-6:30	0	0	0	0.0	0	0	0	0.0	0	0	0	0.0
6:30-6:45	0	0	0	0.0	0	0	0	0.0	0	0	0	0.0
6:45-7:00	0	1	1	1.0	0	1	1	1.2	0	2	2	1.1
1時間計	0	1	1	1.0	0	1	1	1.2	0	2	2	1.1
7:00-7:15	0	0	0	0.0	1	0	1	1.2	1	0	1	0.5
7:15-7:30	0	1	1	1.0	1	0	1	1.2	1	1	2	1.1
7:30-7:45	0	0	0	0.0	0	0	0	0.0	0	0	0	0.0
7:45-8:00	0	2	2	2.0	0	0	0	0.0	0	2	2	1.1
1時間計	0	3	3	3.0	2	0	2	2.5	2	3	5	2.7
8:00-8:15	1	0	1	1.0	0	0	0	0.0	1	0	1	0.5
8:15-8:30	0	0	0	0.0	0	0	0	0.0	0	0	0	0.0
8:30-8:45	0	1	1	1.0	0	0	0	0.0	0	1	1	0.5
8:45-9:00	0	0	0	0.0	1	3	4	4.9	1	3	4	2.2
1時間計	1	1	2	2.0	1	3	4	4.9	2	4	6	3.3
9:00-9:15	0	1	1	1.0	0	2	2	2.5	0	3	3	1.6
9:15-9:30	1	0	1	1.0	1	0	1	1.2	2	0	2	1.1
9:30-9:45	0	0	0	0.0	0	3	3	3.7	0	3	3	1.6
9:45-10:00	0	0	0	0.0	1	1	2	2.5	1	1	2	1.1
1時間計	1	1	2	2.0	2	6	8	9.9	3	7	10	5.5
10:00-10:15	0	0	0	0.0	0	2	2	2.5	0	2	2	1.1
10:15-10:30	0	0	0	0.0	0	3	3	3.7	0	3	3	1.6
10:30-10:45	1	2	3	3.0	3	1	4	4.9	4	3	7	3.8
10:45-11:00	1	0	1	1.0	0	2	2	2.5	1	2	3	1.6
1時間計	2	2	4	4.0	3	8	11	13.6	5	10	15	8.2
11:00-11:15	0	2	2	2.0	0	0	0	0.0	0	2	2	1.1
11:15-11:30	0	3	3	3.0	0	2	2	2.5	0	5	5	2.7
11:30-11:45	1	0	1	1.0	0	1	1	1.2	1	1	2	1.1
11:45-12:00	0	8	8	7.9	2	6	8	9.9	2	14	16	8.8
1時間計	1	13	14	13.9	2	9	11	13.6	3	22	25	13.7
12:00-12:15	0	1	1	1.0	0	0	0	0.0	0	1	1	0.5
12:15-12:30	0	0	0	0.0	0	1	1	1.2	0	1	1	0.5
12:30-12:45	0	3	3	3.0	0	1	1	1.2	0	4	4	2.2
12:45-13:00	0	3	3	3.0	0	0	0	0.0	0	3	3	1.6
1時間計	0	7	7	6.9	0	2	2	2.5	0	9	9	4.9
13:00-13:15	0	0	0	0.0	0	1	1	1.2	0	1	1	0.5
13:15-13:30	0	3	3	3.0	0	0	0	0.0	0	3	3	1.6
13:30-13:45	0	1	1	1.0	0	1	1	1.2	0	2	2	1.1
13:45-14:00	0	3	3	3.0	0	1	1	1.2	0	4	4	2.2
1時間計	0	7	7	6.9	0	3	3	3.7	0	10	10	5.5

歩行者通行量調査表

調査地点：地域社会2 目黒交番前

調査年月日：令和元年 5月11日(土) 天候：晴れ時々曇り



時間帯	ウ				エ				合計			
	歩行者 (人)	自転車 (台)	合計 (人・台)	時間 係数 (%)	歩行者 (人)	自転車 (台)	合計 (人・台)	時間 係数 (%)	歩行者 (人)	自転車 (台)	合計 (人・台)	時間 係数 (%)
14:00-14:15	0	1	1	1.0	0	0	0	0.0	0	1	1	0.5
14:15-14:30	0	2	2	2.0	1	0	1	1.2	1	2	3	1.6
14:30-14:45	0	6	6	5.9	0	0	0	0.0	0	6	6	3.3
14:45-15:00	0	3	3	3.0	1	0	1	1.2	1	3	4	2.2
1時間計	0	12	12	11.9	2	0	2	2.5	2	12	14	7.7
15:00-15:15	1	3	4	4.0	0	0	0	0.0	1	3	4	2.2
15:15-15:30	0	4	4	4.0	0	1	1	1.2	0	5	5	2.7
15:30-15:45	0	4	4	4.0	2	2	4	4.9	2	6	8	4.4
15:45-16:00	0	0	0	0.0	0	0	0	0.0	0	0	0	0.0
1時間計	1	11	12	11.9	2	3	5	6.2	3	14	17	9.3
16:00-16:15	0	3	3	3.0	0	1	1	1.2	0	4	4	2.2
16:15-16:30	0	2	2	2.0	2	4	6	7.4	2	6	8	4.4
16:30-16:45	0	1	1	1.0	0	0	0	0.0	0	1	1	0.5
16:45-17:00	1	4	5	5.0	0	2	2	2.5	1	6	7	3.8
1時間計	1	10	11	10.9	2	7	9	11.1	3	17	20	11.0
17:00-17:15	1	3	4	4.0	0	3	3	3.7	1	6	7	3.8
17:15-17:30	1	5	6	5.9	1	2	3	3.7	2	7	9	4.9
17:30-17:45	0	1	1	1.0	0	1	1	1.2	0	2	2	1.1
17:45-18:00	0	2	2	2.0	2	1	3	3.7	2	3	5	2.7
1時間計	2	11	13	12.9	3	7	10	12.3	5	18	23	12.6
18:00-18:15	0	0	0	0.0	0	1	1	1.2	0	1	1	0.5
18:15-18:30	0	4	4	4.0	0	0	0	0.0	0	4	4	2.2
18:30-18:45	0	2	2	2.0	0	1	1	1.2	0	3	3	1.6
18:45-19:00	0	1	1	1.0	0	0	0	0.0	0	1	1	0.5
1時間計	0	7	7	6.9	0	2	2	2.5	0	9	9	4.9
19:00-19:15	0	0	0	0.0	0	0	0	0.0	0	0	0	0.0
19:15-19:30	0	0	0	0.0	0	0	0	0.0	0	0	0	0.0
19:30-19:45	0	2	2	2.0	0	0	0	0.0	0	2	2	1.1
19:45-20:00	0	0	0	0.0	0	0	0	0.0	0	0	0	0.0
1時間計	0	2	2	2.0	0	0	0	0.0	0	2	2	1.1
20:00-20:15	0	0	0	0.0	0	1	1	1.2	0	1	1	0.5
20:15-20:30	0	0	0	0.0	0	3	3	3.7	0	3	3	1.6
20:30-20:45	0	0	0	0.0	0	1	1	1.2	0	1	1	0.5
20:45-21:00	0	0	0	0.0	0	2	2	2.5	0	2	2	1.1
1時間計	0	0	0	0.0	0	7	7	8.6	0	7	7	3.8
21:00-21:15	0	1	1	1.0	0	1	1	1.2	0	2	2	1.1
21:15-21:30	0	0	0	0.0	0	0	0	0.0	0	0	0	0.0
21:30-21:45	0	0	0	0.0	0	0	0	0.0	0	0	0	0.0
21:45-22:00	0	0	0	0.0	0	1	1	1.2	0	1	1	0.5
1時間計	0	1	1	1.0	0	2	2	2.5	0	3	3	1.6
昼12時間計	9	85	94	93.1	19	50	69	85.2	28	135	163	89.6
夜12時間計	2	5	7	6.9	0	12	12	14.8	2	17	19	10.4
全時間合計	11	90	101	100.0	19	62	81	100.0	30	152	182	100.0
昼夜率	1.22	1.06	1.07	-	1.00	1.24	1.17	-	1.07	1.13	1.12	-

歩行者通行量調査表

調査地点：地域社会2 目黒交番前

調査年月日：令和元年 5月11日(土) 天候：晴れ時々曇り



時間帯	方向				合計							
	歩行者 (人)	自転車 (台)	合計 (人・台)	時間 係数 (%)	歩行者 (人)	自転車 (台)	合計 (人・台)	時間 係数 (%)	歩行者 (人)	自転車 (台)	合計 (人・台)	時間 係数 (%)
22:00-22:15	0	4	4	3.2	0	0	0	0.0	0	4	4	2.4
22:15-22:30	0	0	0	0.0	0	0	0	0.0	0	0	0	0.0
22:30-22:45	0	1	1	0.8	0	1	1	2.2	0	2	2	1.2
22:45-23:00	0	0	0	0.0	0	0	0	0.0	0	0	0	0.0
1時間計	0	5	5	4.0	0	1	1	2.2	0	6	6	3.6
23:00-23:15	0	0	0	0.0	0	0	0	0.0	0	0	0	0.0
23:15-23:30	0	1	1	0.8	0	0	0	0.0	0	1	1	0.6
23:30-23:45	0	0	0	0.0	0	0	0	0.0	0	0	0	0.0
23:45-24:00	0	0	0	0.0	0	0	0	0.0	0	0	0	0.0
1時間計	0	1	1	0.8	0	0	0	0.0	0	1	1	0.6
0:00-0:15	0	0	0	0.0	0	0	0	0.0	0	0	0	0.0
0:15-0:30	0	0	0	0.0	0	0	0	0.0	0	0	0	0.0
0:30-0:45	0	0	0	0.0	0	0	0	0.0	0	0	0	0.0
0:45-1:00	0	0	0	0.0	0	0	0	0.0	0	0	0	0.0
1時間計	0	0	0	0.0	0	0	0	0.0	0	0	0	0.0
1:00-1:15	1	0	1	0.8	0	0	0	0.0	1	0	1	0.6
1:15-1:30	0	0	0	0.0	0	0	0	0.0	0	0	0	0.0
1:30-1:45	0	0	0	0.0	0	0	0	0.0	0	0	0	0.0
1:45-2:00	0	0	0	0.0	0	0	0	0.0	0	0	0	0.0
1時間計	1	0	1	0.8	0	0	0	0.0	1	0	1	0.6
2:00-2:15	0	0	0	0.0	0	0	0	0.0	0	0	0	0.0
2:15-2:30	0	1	1	0.8	0	1	1	2.2	0	2	2	1.2
2:30-2:45	0	0	0	0.0	0	0	0	0.0	0	0	0	0.0
2:45-3:00	0	0	0	0.0	0	0	0	0.0	0	0	0	0.0
1時間計	0	1	1	0.8	0	1	1	2.2	0	2	2	1.2
3:00-3:15	1	0	1	0.8	0	0	0	0.0	1	0	1	0.6
3:15-3:30	0	0	0	0.0	0	0	0	0.0	0	0	0	0.0
3:30-3:45	0	1	1	0.8	0	0	0	0.0	0	1	1	0.6
3:45-4:00	0	0	0	0.0	0	0	0	0.0	0	0	0	0.0
1時間計	1	1	2	1.6	0	0	0	0.0	1	1	2	1.2
4:00-4:15	1	0	1	0.8	0	0	0	0.0	1	0	1	0.6
4:15-4:30	0	1	1	0.8	0	2	2	4.4	0	3	3	1.8
4:30-4:45	0	1	1	0.8	0	0	0	0.0	0	1	1	0.6
4:45-5:00	0	1	1	0.8	0	0	0	0.0	0	1	1	0.6
1時間計	1	3	4	3.2	0	2	2	4.4	1	5	6	3.6
5:00-5:15	0	0	0	0.0	0	0	0	0.0	0	0	0	0.0
5:15-5:30	0	0	0	0.0	0	0	0	0.0	0	0	0	0.0
5:30-5:45	0	0	0	0.0	0	0	0	0.0	0	0	0	0.0
5:45-6:00	0	0	0	0.0	0	0	0	0.0	0	0	0	0.0
1時間計	0	0	0	0.0	0	0	0	0.0	0	0	0	0.0

歩行者通行量調査表

調査地点：地域社会2 目黒交番前

調査年月日：令和元年 5月11日(土) 天候：晴れ時々曇り



時間帯	種別	方向				合計							
		歩行者 (人)	自転車 (台)	合計 (人・台)	時間 係数 (%)	歩行者 (人)	自転車 (台)	合計 (人・台)	時間 係数 (%)	歩行者 (人)	自転車 (台)	合計 (人・台)	時間 係数 (%)
6:00-6:15		1	1	2	1.6	0	1	1	2.2	1	2	3	1.8
6:15-6:30		0	1	1	0.8	1	1	2	4.4	1	2	3	1.8
6:30-6:45		0	4	4	3.2	0	0	0	0.0	0	4	4	2.4
6:45-7:00		0	0	0	0.0	1	1	2	4.4	1	1	2	1.2
1時間計		1	6	7	5.6	2	3	5	11.1	3	9	12	7.1
7:00-7:15		0	1	1	0.8	0	0	0	0.0	0	1	1	0.6
7:15-7:30		0	4	4	3.2	0	0	0	0.0	0	4	4	2.4
7:30-7:45		1	1	2	1.6	1	0	1	2.2	2	1	3	1.8
7:45-8:00		0	1	1	0.8	0	0	0	0.0	0	1	1	0.6
1時間計		1	7	8	6.5	1	0	1	2.2	2	7	9	5.3
8:00-8:15		0	6	6	4.8	0	1	1	2.2	0	7	7	4.1
8:15-8:30		0	1	1	0.8	0	0	0	0.0	0	1	1	0.6
8:30-8:45		1	5	6	4.8	0	1	1	2.2	1	6	7	4.1
8:45-9:00		0	1	1	0.8	0	0	0	0.0	0	1	1	0.6
1時間計		1	13	14	11.3	0	2	2	4.4	1	15	16	9.5
9:00-9:15		1	0	1	0.8	0	0	0	0.0	1	0	1	0.6
9:15-9:30		1	8	9	7.3	0	0	0	0.0	1	8	9	5.3
9:30-9:45		2	3	5	4.0	0	0	0	0.0	2	3	5	3.0
9:45-10:00		0	6	6	4.8	0	0	0	0.0	0	6	6	3.6
1時間計		4	17	21	16.9	0	0	0	0.0	4	17	21	12.4
10:00-10:15		3	1	4	3.2	2	0	2	4.4	5	1	6	3.6
10:15-10:30		0	3	3	2.4	0	0	0	0.0	0	3	3	1.8
10:30-10:45		1	0	1	0.8	1	1	2	4.4	2	1	3	1.8
10:45-11:00		1	2	3	2.4	1	1	2	4.4	2	3	5	3.0
1時間計		5	6	11	8.9	4	2	6	13.3	9	8	17	10.1
11:00-11:15		0	0	0	0.0	0	0	0	0.0	0	0	0	0.0
11:15-11:30		0	1	1	0.8	0	0	0	0.0	0	1	1	0.6
11:30-11:45		0	0	0	0.0	0	1	1	2.2	0	1	1	0.6
11:45-12:00		1	0	1	0.8	2	3	5	11.1	3	3	6	3.6
1時間計		1	1	2	1.6	2	4	6	13.3	3	5	8	4.7
12:00-12:15		0	0	0	0.0	0	0	0	0.0	0	0	0	0.0
12:15-12:30		0	0	0	0.0	0	0	0	0.0	0	0	0	0.0
12:30-12:45		0	0	0	0.0	0	0	0	0.0	0	0	0	0.0
12:45-13:00		0	1	1	0.8	0	0	0	0.0	0	1	1	0.6
1時間計		0	1	1	0.8	0	0	0	0.0	0	1	1	0.6
13:00-13:15		1	1	2	1.6	0	0	0	0.0	1	1	2	1.2
13:15-13:30		0	0	0	0.0	0	0	0	0.0	0	0	0	0.0
13:30-13:45		1	1	2	1.6	0	3	3	6.7	1	4	5	3.0
13:45-14:00		1	1	2	1.6	0	0	0	0.0	1	1	2	1.2
1時間計		3	3	6	4.8	0	3	3	6.7	3	6	9	5.3

歩行者通行量調査表

調査地点：地域社会2 目黒交番前

調査年月日：令和元年 5月11日(土) 天候：晴れ時々曇り



方向	イ				カ				合計				
	種別	歩行者 (人)	自転車 (台)	合計 (人・台)	時間 係数 (%)	歩行者 (人)	自転車 (台)	合計 (人・台)	時間 係数 (%)	歩行者 (人)	自転車 (台)	合計 (人・台)	時間 係数 (%)
14:00-14:15		0	3	3	2.4	1	0	1	2.2	1	3	4	2.4
14:15-14:30		0	2	2	1.6	1	0	1	2.2	1	2	3	1.8
14:30-14:45		1	1	2	1.6	0	0	0	0.0	1	1	2	1.2
14:45-15:00		0	3	3	2.4	0	0	0	0.0	0	3	3	1.8
1時間計		1	9	10	8.1	2	0	2	4.4	3	9	12	7.1
15:00-15:15		0	0	0	0.0	1	0	1	2.2	1	0	1	0.6
15:15-15:30		0	1	1	0.8	0	2	2	4.4	0	3	3	1.8
15:30-15:45		0	2	2	1.6	0	1	1	2.2	0	3	3	1.8
15:45-16:00		2	1	3	2.4	1	3	4	8.9	3	4	7	4.1
1時間計		2	4	6	4.8	2	6	8	17.8	4	10	14	8.3
16:00-16:15		1	0	1	0.8	0	1	1	2.2	1	1	2	1.2
16:15-16:30		0	0	0	0.0	0	0	0	0.0	0	0	0	0.0
16:30-16:45		0	1	1	0.8	1	0	1	2.2	1	1	2	1.2
16:45-17:00		2	0	2	1.6	1	1	2	4.4	3	1	4	2.4
1時間計		3	1	4	3.2	2	2	4	8.9	5	3	8	4.7
17:00-17:15		0	0	0	0.0	0	0	0	0.0	0	0	0	0.0
17:15-17:30		0	0	0	0.0	0	0	0	0.0	0	0	0	0.0
17:30-17:45		1	1	2	1.6	0	0	0	0.0	1	1	2	1.2
17:45-18:00		1	1	2	1.6	0	0	0	0.0	1	1	2	1.2
1時間計		2	2	4	3.2	0	0	0	0.0	2	2	4	2.4
18:00-18:15		0	0	0	0.0	0	0	0	0.0	0	0	0	0.0
18:15-18:30		1	1	2	1.6	0	0	0	0.0	1	1	2	1.2
18:30-18:45		1	2	3	2.4	1	0	1	2.2	2	2	4	2.4
18:45-19:00		3	2	5	4.0	0	0	0	0.0	3	2	5	3.0
1時間計		5	5	10	8.1	1	0	1	2.2	6	5	11	6.5
19:00-19:15		1	0	1	0.8	0	0	0	0.0	1	0	1	0.6
19:15-19:30		0	0	0	0.0	0	0	0	0.0	0	0	0	0.0
19:30-19:45		0	0	0	0.0	0	0	0	0.0	0	0	0	0.0
19:45-20:00		0	0	0	0.0	0	0	0	0.0	0	0	0	0.0
1時間計		1	0	1	0.8	0	0	0	0.0	1	0	1	0.6
20:00-20:15		0	0	0	0.0	0	0	0	0.0	0	0	0	0.0
20:15-20:30		1	1	2	1.6	0	2	2	4.4	1	3	4	2.4
20:30-20:45		0	0	0	0.0	0	0	0	0.0	0	0	0	0.0
20:45-21:00		0	0	0	0.0	0	0	0	0.0	0	0	0	0.0
1時間計		1	1	2	1.6	0	2	2	4.4	1	3	4	2.4
21:00-21:15		0	1	1	0.8	0	1	1	2.2	0	2	2	1.2
21:15-21:30		1	0	1	0.8	0	0	0	0.0	1	0	1	0.6
21:30-21:45		0	0	0	0.0	0	0	0	0.0	0	0	0	0.0
21:45-22:00		0	1	1	0.8	0	0	0	0.0	0	1	1	0.6
1時間計		1	2	3	2.4	0	1	1	2.2	1	3	4	2.4
昼12時間計		28	69	97	78.2	14	19	33	73.3	42	88	130	76.9
夜12時間計		7	20	27	21.8	2	10	12	26.7	9	30	39	23.1
全時間合計		35	89	124	100.0	16	29	45	100.0	51	118	169	100.0
昼夜率		1.25	1.29	1.28	-	1.14	1.53	1.36	-	1.21	1.34	1.30	-

歩行者通行量調査表

調査地点：地域社会2 目黒交番前

調査年月日：令和元年 5月11日(土) 天候：晴れ時々曇り



時間帯	方向				合計								
	種別	歩行者 (人)	自転車 (台)	合計 (人・台)	時間係数 (%)	歩行者 (人)	自転車 (台)	合計 (人・台)	時間係数 (%)	歩行者 (人)	自転車 (台)	合計 (人・台)	時間係数 (%)
22:00-22:15		0	3	3	2.3	0	1	1	1.4	0	4	4	2.0
22:15-22:30		0	1	1	0.8	0	0	0	0.0	0	1	1	0.5
22:30-22:45		0	1	1	0.8	0	1	1	1.4	0	2	2	1.0
22:45-23:00		0	0	0	0.0	0	0	0	0.0	0	0	0	0.0
1時間計		0	5	5	3.8	0	2	2	2.9	0	7	7	3.5
23:00-23:15		0	1	1	0.8	0	0	0	0.0	0	1	1	0.5
23:15-23:30		0	0	0	0.0	0	0	0	0.0	0	0	0	0.0
23:30-23:45		0	2	2	1.5	0	0	0	0.0	0	2	2	1.0
23:45-24:00		0	0	0	0.0	0	0	0	0.0	0	0	0	0.0
1時間計		0	3	3	2.3	0	0	0	0.0	0	3	3	1.5
0:00-0:15		0	0	0	0.0	0	0	0	0.0	0	0	0	0.0
0:15-0:30		0	0	0	0.0	0	1	1	1.4	0	1	1	0.5
0:30-0:45		0	0	0	0.0	0	0	0	0.0	0	0	0	0.0
0:45-1:00		0	0	0	0.0	0	0	0	0.0	0	0	0	0.0
1時間計		0	0	0	0.0	0	1	1	1.4	0	1	1	0.5
1:00-1:15		0	0	0	0.0	0	0	0	0.0	0	0	0	0.0
1:15-1:30		0	0	0	0.0	0	0	0	0.0	0	0	0	0.0
1:30-1:45		0	0	0	0.0	0	0	0	0.0	0	0	0	0.0
1:45-2:00		0	0	0	0.0	0	0	0	0.0	0	0	0	0.0
1時間計		0	0	0	0.0	0	0	0	0.0	0	0	0	0.0
2:00-2:15		0	0	0	0.0	0	0	0	0.0	0	0	0	0.0
2:15-2:30		0	0	0	0.0	0	0	0	0.0	0	0	0	0.0
2:30-2:45		0	0	0	0.0	0	0	0	0.0	0	0	0	0.0
2:45-3:00		0	0	0	0.0	0	0	0	0.0	0	0	0	0.0
1時間計		0	0	0	0.0	0	0	0	0.0	0	0	0	0.0
3:00-3:15		0	0	0	0.0	0	0	0	0.0	0	0	0	0.0
3:15-3:30		0	0	0	0.0	0	0	0	0.0	0	0	0	0.0
3:30-3:45		0	0	0	0.0	0	0	0	0.0	0	0	0	0.0
3:45-4:00		0	0	0	0.0	0	0	0	0.0	0	0	0	0.0
1時間計		0	0	0	0.0	0	0	0	0.0	0	0	0	0.0
4:00-4:15		0	0	0	0.0	0	0	0	0.0	0	0	0	0.0
4:15-4:30		1	0	1	0.8	1	0	1	1.4	2	0	2	1.0
4:30-4:45		0	0	0	0.0	0	0	0	0.0	0	0	0	0.0
4:45-5:00		0	0	0	0.0	0	0	0	0.0	0	0	0	0.0
1時間計		1	0	1	0.8	1	0	1	1.4	2	0	2	1.0
5:00-5:15		0	0	0	0.0	0	0	0	0.0	0	0	0	0.0
5:15-5:30		0	0	0	0.0	0	0	0	0.0	0	0	0	0.0
5:30-5:45		0	0	0	0.0	0	1	1	1.4	0	1	1	0.5
5:45-6:00		0	0	0	0.0	1	0	1	1.4	1	0	1	0.5
1時間計		0	0	0	0.0	1	1	2	2.9	1	1	2	1.0

歩行者通行量調査表

調査地点：地域社会2 目黒交番前

調査年月日：令和元年 5月11日(土) 天候：晴れ時々曇り



時間帯	種別	キ				ク				合計			
		歩行者 (人)	自転車 (台)	合計 (人・台)	時間 係数 (%)	歩行者 (人)	自転車 (台)	合計 (人・台)	時間 係数 (%)	歩行者 (人)	自転車 (台)	合計 (人・台)	時間 係数 (%)
6:00-6:15		0	1	1	0.8	0	0	0	0.0	0	1	1	0.5
6:15-6:30		0	1	1	0.8	0	1	1	1.4	0	2	2	1.0
6:30-6:45		1	8	9	6.9	0	2	2	2.9	1	10	11	5.5
6:45-7:00		0	2	2	1.5	0	3	3	4.3	0	5	5	2.5
1時間計		1	12	13	10.0	0	6	6	8.6	1	18	19	9.5
7:00-7:15		1	6	7	5.4	0	0	0	0.0	1	6	7	3.5
7:15-7:30		0	6	6	4.6	0	0	0	0.0	0	6	6	3.0
7:30-7:45		0	1	1	0.8	0	0	0	0.0	0	1	1	0.5
7:45-8:00		0	1	1	0.8	0	2	2	2.9	0	3	3	1.5
1時間計		1	14	15	11.5	0	2	2	2.9	1	16	17	8.5
8:00-8:15		2	0	2	1.5	0	0	0	0.0	2	0	2	1.0
8:15-8:30		1	6	7	5.4	1	2	3	4.3	2	8	10	5.0
8:30-8:45		0	7	7	5.4	0	1	1	1.4	0	8	8	4.0
8:45-9:00		0	2	2	1.5	0	1	1	1.4	0	3	3	1.5
1時間計		3	15	18	13.8	1	4	5	7.1	4	19	23	11.5
9:00-9:15		0	0	0	0.0	0	0	0	0.0	0	0	0	0.0
9:15-9:30		0	2	2	1.5	2	2	4	5.7	2	4	6	3.0
9:30-9:45		1	6	7	5.4	0	1	1	1.4	1	7	8	4.0
9:45-10:00		1	6	7	5.4	0	2	2	2.9	1	8	9	4.5
1時間計		2	14	16	12.3	2	5	7	10.0	4	19	23	11.5
10:00-10:15		3	1	4	3.1	3	2	5	7.1	6	3	9	4.5
10:15-10:30		0	1	1	0.8	0	0	0	0.0	0	1	1	0.5
10:30-10:45		1	0	1	0.8	1	1	2	2.9	2	1	3	1.5
10:45-11:00		0	1	1	0.8	0	0	0	0.0	0	1	1	0.5
1時間計		4	3	7	5.4	4	3	7	10.0	8	6	14	7.0
11:00-11:15		1	3	4	3.1	2	0	2	2.9	3	3	6	3.0
11:15-11:30		0	1	1	0.8	1	0	1	1.4	1	1	2	1.0
11:30-11:45		0	1	1	0.8	1	0	1	1.4	1	1	2	1.0
11:45-12:00		1	0	1	0.8	0	0	0	0.0	1	0	1	0.5
1時間計		2	5	7	5.4	4	0	4	5.7	6	5	11	5.5
12:00-12:15		0	2	2	1.5	0	0	0	0.0	0	2	2	1.0
12:15-12:30		0	0	0	0.0	0	0	0	0.0	0	0	0	0.0
12:30-12:45		1	2	3	2.3	0	2	2	2.9	1	4	5	2.5
12:45-13:00		1	3	4	3.1	0	0	0	0.0	1	3	4	2.0
1時間計		2	7	9	6.9	0	2	2	2.9	2	9	11	5.5
13:00-13:15		0	2	2	1.5	0	0	0	0.0	0	2	2	1.0
13:15-13:30		1	1	2	1.5	0	0	0	0.0	1	1	2	1.0
13:30-13:45		1	0	1	0.8	2	5	7	10.0	3	5	8	4.0
13:45-14:00		1	0	1	0.8	0	0	0	0.0	1	0	1	0.5
1時間計		3	3	6	4.6	2	5	7	10.0	5	8	13	6.5

歩行者通行量調査表

調査地点：地域社会2 目黒交番前

調査年月日：令和元年 5月11日(土) 天候：晴れ時々曇り



時間帯	キ				ケ				合計			
	歩行者 (人)	自転車 (台)	合計 (人・台)	時間 係数 (%)	歩行者 (人)	自転車 (台)	合計 (人・台)	時間 係数 (%)	歩行者 (人)	自転車 (台)	合計 (人・台)	時間 係数 (%)
14:00-14:15	0	1	1	0.8	1	0	1	1.4	1	1	2	1.0
14:15-14:30	2	1	3	2.3	2	1	3	4.3	4	2	6	3.0
14:30-14:45	0	1	1	0.8	1	1	2	2.9	1	2	3	1.5
14:45-15:00	0	0	0	0.0	0	0	0	0.0	0	0	0	0.0
1時間計	2	3	5	3.8	4	2	6	8.6	6	5	11	5.5
15:00-15:15	0	0	0	0.0	0	0	0	0.0	0	0	0	0.0
15:15-15:30	0	0	0	0.0	0	0	0	0.0	0	0	0	0.0
15:30-15:45	0	0	0	0.0	0	0	0	0.0	0	0	0	0.0
15:45-16:00	1	0	1	0.8	1	2	3	4.3	2	2	4	2.0
1時間計	1	0	1	0.8	1	2	3	4.3	2	2	4	2.0
16:00-16:15	0	3	3	2.3	0	0	0	0.0	0	3	3	1.5
16:15-16:30	0	0	0	0.0	0	0	0	0.0	0	0	0	0.0
16:30-16:45	0	0	0	0.0	2	1	3	4.3	2	1	3	1.5
16:45-17:00	0	1	1	0.8	0	0	0	0.0	0	1	1	0.5
1時間計	0	4	4	3.1	2	1	3	4.3	2	5	7	3.5
17:00-17:15	1	2	3	2.3	0	0	0	0.0	1	2	3	1.5
17:15-17:30	0	1	1	0.8	0	1	1	1.4	0	2	2	1.0
17:30-17:45	0	2	2	1.5	1	1	2	2.9	1	3	4	2.0
17:45-18:00	1	0	1	0.8	0	0	0	0.0	1	0	1	0.5
1時間計	2	5	7	5.4	1	2	3	4.3	3	7	10	5.0
18:00-18:15	0	2	2	1.5	0	1	1	1.4	0	3	3	1.5
18:15-18:30	1	2	3	2.3	0	0	0	0.0	1	2	3	1.5
18:30-18:45	1	3	4	3.1	0	0	0	0.0	1	3	4	2.0
18:45-19:00	0	0	0	0.0	0	5	5	7.1	0	5	5	2.5
1時間計	2	7	9	6.9	0	6	6	8.6	2	13	15	7.5
19:00-19:15	0	0	0	0.0	0	0	0	0.0	0	0	0	0.0
19:15-19:30	0	0	0	0.0	0	0	0	0.0	0	0	0	0.0
19:30-19:45	0	0	0	0.0	0	0	0	0.0	0	0	0	0.0
19:45-20:00	0	1	1	0.8	1	0	1	1.4	1	1	2	1.0
1時間計	0	1	1	0.8	1	0	1	1.4	1	1	2	1.0
20:00-20:15	0	2	2	1.5	0	0	0	0.0	0	2	2	1.0
20:15-20:30	1	0	1	0.8	0	1	1	1.4	1	1	2	1.0
20:30-20:45	0	0	0	0.0	0	0	0	0.0	0	0	0	0.0
20:45-21:00	0	0	0	0.0	0	1	1	1.4	0	1	1	0.5
1時間計	1	2	3	2.3	0	2	2	2.9	1	4	5	2.5
21:00-21:15	0	0	0	0.0	0	0	0	0.0	0	0	0	0.0
21:15-21:30	0	0	0	0.0	0	0	0	0.0	0	0	0	0.0
21:30-21:45	0	0	0	0.0	0	0	0	0.0	0	0	0	0.0
21:45-22:00	0	0	0	0.0	0	0	0	0.0	0	0	0	0.0
1時間計	0	0	0	0.0	0	0	0	0.0	0	0	0	0.0
昼12時間計	24	80	104	80.0	21	34	55	78.6	45	114	159	79.5
夜12時間計	3	23	26	20.0	3	12	15	21.4	6	35	41	20.5
全時間合計	27	103	130	100.0	24	46	70	100.0	51	149	200	100.0
昼夜率	1.13	1.29	1.25	-	1.14	1.35	1.27	-	1.13	1.31	1.26	-

歩行者通行量調査表

調査地点：地域社会2 目黒交番前

調査年月日：令和元年 5月11日(土) 天候：晴れ時々曇り



方向	合計 (フ+イ+ウ+エ+オ+カ+キ+ク)				
時間帯	種別	歩行者 (人)	自転車 (台)	合計 (人・台)	時間 係数 (%)
22:00-22:15		0	9	9	1.1
22:15-22:30		0	1	1	0.1
22:30-22:45		0	4	4	0.5
22:45-23:00		2	1	3	0.4
1時間計		2	15	17	2.1
23:00-23:15		1	2	3	0.4
23:15-23:30		0	1	1	0.1
23:30-23:45		0	3	3	0.4
23:45-24:00		1	2	3	0.4
1時間計		2	8	10	1.2
0:00-0:15		0	1	1	0.1
0:15-0:30		0	1	1	0.1
0:30-0:45		0	1	1	0.1
0:45-1:00		0	0	0	0.0
1時間計		0	3	3	0.4
1:00-1:15		1	1	2	0.2
1:15-1:30		0	1	1	0.1
1:30-1:45		0	0	0	0.0
1:45-2:00		0	0	0	0.0
1時間計		1	2	3	0.4
2:00-2:15		0	0	0	0.0
2:15-2:30		0	2	2	0.2
2:30-2:45		0	1	1	0.1
2:45-3:00		0	0	0	0.0
1時間計		0	3	3	0.4
3:00-3:15		1	1	2	0.2
3:15-3:30		2	0	2	0.2
3:30-3:45		0	1	1	0.1
3:45-4:00		0	0	0	0.0
1時間計		3	2	5	0.6
4:00-4:15		1	0	1	0.1
4:15-4:30		2	3	5	0.6
4:30-4:45		0	1	1	0.1
4:45-5:00		0	2	2	0.2
1時間計		3	6	9	1.1
5:00-5:15		0	0	0	0.0
5:15-5:30		0	1	1	0.1
5:30-5:45		0	1	1	0.1
5:45-6:00		1	1	2	0.2
1時間計		1	3	4	0.5
6:00-6:15		1	3	4	0.5
6:15-6:30		1	5	6	0.7
6:30-6:45		2	18	20	2.5
6:45-7:00		3	10	13	1.6
1時間計		7	36	43	5.3
7:00-7:15		2	10	12	1.5
7:15-7:30		1	12	13	1.6
7:30-7:45		2	3	5	0.6
7:45-8:00		1	7	8	1.0
1時間計		6	32	38	4.7
8:00-8:15		6	9	15	1.9
8:15-8:30		3	14	17	2.1
8:30-8:45		2	19	21	2.6
8:45-9:00		2	11	13	1.6
1時間計		13	53	66	8.2
9:00-9:15		1	5	6	0.7
9:15-9:30		5	12	17	2.1
9:30-9:45		3	14	17	2.1
9:45-10:00		2	21	23	2.8
1時間計		11	52	63	7.8

方向	合計 (フ+イ+ウ+エ+オ+カ+キ+ク)				
時間帯	種別	歩行者 (人)	自転車 (台)	合計 (人・台)	時間 係数 (%)
22:00-23:00		2	15	17	2.1
22:15-23:15		3	8	11	1.4
22:30-23:30		3	8	11	1.4
22:45-23:45		3	7	10	1.2
23:00-0:00		2	8	10	1.2
23:15-0:15		1	7	8	1.0
23:30-0:30		1	7	8	1.0
23:45-0:45		1	5	6	0.7
0:00-1:00		0	3	3	0.4
0:15-1:15		1	3	4	0.5
0:30-1:30		1	3	4	0.5
0:45-1:45		1	2	3	0.4
1:00-2:00		1	2	3	0.4
1:15-2:15		0	1	1	0.1
1:30-2:30		0	2	2	0.2
1:45-2:45		0	3	3	0.4
2:00-3:00		0	3	3	0.4
2:15-3:15		1	4	5	0.6
2:30-3:30		3	2	5	0.6
2:45-3:45		3	2	5	0.6
3:00-4:00		3	2	5	0.6
3:15-4:15		3	1	4	0.5
3:30-4:30		3	4	7	0.9
3:45-4:45		3	4	7	0.9
4:00-5:00		3	6	9	1.1
4:15-5:15		2	6	8	1.0
4:30-5:30		0	4	4	0.5
4:45-5:45		0	4	4	0.5
5:00-6:00		1	3	4	0.5
5:15-6:15		2	6	8	1.0
5:30-6:30		3	10	13	1.6
5:45-6:45		5	27	32	4.0
6:00-7:00		7	36	43	5.3
6:15-7:15		8	43	51	6.3
6:30-7:30		8	50	58	7.2
6:45-7:45		8	35	43	5.3
7:00-8:00		6	32	38	4.7
7:15-8:15		10	31	41	5.1
7:30-8:30		12	33	45	5.6
7:45-8:45		12	49	61	7.5
8:00-9:00		13	53	66	8.2
8:15-9:15		8	49	57	7.1
8:30-9:30		10	47	57	7.1
8:45-9:45		11	42	53	6.6
9:00-10:00		11	52	63	7.8
9:15-10:15		23	58	81	10.0
9:30-10:30		18	56	74	9.2
9:45-10:45		23	49	72	8.9
10:00-11:00		24	38	62	7.7
10:15-11:15		14	38	52	6.4
10:30-11:30		15	39	54	6.7
10:45-11:45		9	37	46	5.7
11:00-12:00		12	51	63	7.8
11:15-12:15		10	46	56	6.9
11:30-12:30		11	40	51	6.3
11:45-12:45		11	45	56	6.9
12:00-13:00		6	32	38	4.7
12:15-13:15		6	36	42	5.2
12:30-13:30		5	37	42	5.2
12:45-13:45		7	41	48	5.9

歩行者通行量調査表

調査地点：地域社会2 目黒交番前

調査年月日：令和元年 5月11日(土) 天候：晴れ時々曇り



時間帯	種別	合計 (ア+イ+ウ+エ+オ+カ+キ+ク)			時間係数 (%)
		歩行者 (人)	自転車 (台)	合計 (人・台)	
10:00-10:15		13	11	24	3.0
10:15-10:30		0	10	10	1.2
10:30-10:45		8	7	15	1.9
10:45-11:00		3	10	13	1.6
1時間計		24	38	62	7.7
11:00-11:15		3	11	14	1.7
11:15-11:30		1	11	12	1.5
11:30-11:45		2	5	7	0.9
11:45-12:00		6	24	30	3.7
1時間計		12	51	63	7.8
12:00-12:15		1	6	7	0.9
12:15-12:30		2	5	7	0.9
12:30-12:45		2	10	12	1.5
12:45-13:00		1	11	12	1.5
1時間計		6	32	38	4.7
13:00-13:15		1	10	11	1.4
13:15-13:30		1	6	7	0.9
13:30-13:45		4	14	18	2.2
13:45-14:00		2	6	8	1.0
1時間計		8	36	44	5.4
14:00-14:15		6	11	17	2.1
14:15-14:30		6	10	16	2.0
14:30-14:45		2	17	19	2.4
14:45-15:00		2	11	13	1.6
1時間計		16	49	65	8.0
15:00-15:15		2	9	11	1.4
15:15-15:30		0	17	17	2.1
15:30-15:45		4	15	19	2.4
15:45-16:00		6	7	13	1.6
1時間計		12	48	60	7.4
16:00-16:15		1	13	14	1.7
16:15-16:30		4	11	15	1.9
16:30-16:45		4	3	7	0.9
16:45-17:00		4	11	15	1.9
1時間計		13	38	51	6.3
17:00-17:15		3	11	14	1.7
17:15-17:30		3	12	15	1.9
17:30-17:45		3	6	9	1.1
17:45-18:00		4	6	10	1.2
1時間計		13	35	48	5.9
18:00-18:15		2	6	8	1.0
18:15-18:30		7	9	16	2.0
18:30-18:45		5	8	13	1.6
18:45-19:00		3	8	11	1.4
1時間計		17	31	48	5.9
19:00-19:15		1	7	8	1.0
19:15-19:30		2	4	6	0.7
19:30-19:45		1	4	5	0.6
19:45-20:00		2	4	6	0.7
1時間計		6	19	25	3.1
20:00-20:15		0	5	5	0.6
20:15-20:30		3	9	12	1.5
20:30-20:45		0	1	1	0.1
20:45-21:00		0	7	7	0.9
1時間計		3	22	25	3.1
21:00-21:15		0	5	5	0.6
21:15-21:30		1	2	3	0.4
21:30-21:45		0	2	2	0.2
21:45-22:00		1	4	5	0.6
1時間計		2	13	15	1.9
昼12時間計		151	495	646	80.0
夜12時間計		30	132	162	20.0
全時間合計		181	627	808	100.0
昼夜率		1.20	1.27	1.25	-

時間帯	種別	合計 (ア+イ+ウ+エ+オ+カ+キ+ク)			時間係数 (%)
		歩行者 (人)	自転車 (台)	合計 (人・台)	
13:00-13:15		8	36	44	5.4
13:15-13:30		13	37	50	6.2
13:30-13:45		18	41	59	7.3
13:45-14:15		16	44	60	7.4
14:00-15:00		16	49	65	8.0
14:15-15:15		12	47	59	7.3
14:30-15:30		6	54	60	7.4
14:45-15:45		8	52	60	7.4
15:00-16:00		12	48	60	7.4
15:15-16:15		11	52	63	7.8
15:30-16:30		15	46	61	7.5
15:45-16:45		15	34	49	6.1
16:00-17:00		13	38	51	6.3
16:15-17:15		15	36	51	6.3
16:30-17:30		14	37	51	6.3
16:45-17:45		13	40	53	6.6
17:00-18:00		13	35	48	5.9
17:15-18:15		12	30	42	5.2
17:30-18:30		16	27	43	5.3
17:45-18:45		18	29	47	5.8
18:00-19:00		17	31	48	5.9
18:15-19:15		16	32	48	5.9
18:30-19:30		11	27	38	4.7
18:45-19:45		7	23	30	3.7
19:00-20:00		6	19	25	3.1
19:15-20:15		5	17	22	2.7
19:30-20:30		6	22	28	3.5
19:45-20:45		5	19	24	3.0
20:00-21:00		3	22	25	3.1
20:15-21:15		3	22	25	3.1
20:30-21:30		1	15	16	2.0
20:45-21:45		1	16	17	2.1
21:00-22:00		2	13	15	1.9
全時間合計		181	627	808	100.0

歩行者通行量調査表

調査地点：地域社会3 上川井1C

調査年月日：令和元年 5月11日(土) 天候：晴れ時々曇り

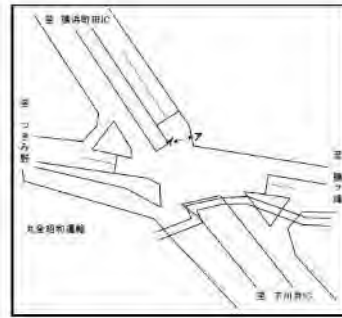

時間帯	方向 7				方向 1				合計 (7+1)			
	歩行者 (人)	自転車 (台)	合計 (人・台)	時間 係数 (%)	歩行者 (人)	自転車 (台)	合計 (人・台)	時間 係数 (%)	歩行者 (人)	自転車 (台)	合計 (人・台)	時間 係数 (%)
22:00-22:15	1	0	1	0.4	0	1	1	0.8	1	1	2	0.6
22:15-22:30	2	0	2	0.9	1	0	1	0.8	3	0	3	0.9
22:30-22:45	1	0	1	0.4	1	0	1	0.8	2	0	2	0.6
22:45-23:00	0	1	1	0.4	1	0	1	0.8	1	1	2	0.6
1時間計	4	1	5	2.2	3	1	4	3.2	7	2	9	2.6
23:00-23:15	0	1	1	0.4	1	0	1	0.8	1	1	2	0.6
23:15-23:30	2	0	2	0.9	1	0	1	0.8	3	0	3	0.9
23:30-23:45	0	0	0	0.0	2	0	2	1.6	2	0	2	0.6
23:45-24:00	1	0	1	0.4	0	1	1	0.8	1	1	2	0.6
1時間計	3	1	4	1.8	4	1	5	4.0	7	2	9	2.6
0:00-0:15	1	0	1	0.4	1	0	1	0.8	2	0	2	0.6
0:15-0:30	0	1	1	0.4	0	0	0	0.0	0	1	1	0.3
0:30-0:45	0	0	0	0.0	1	0	1	0.8	1	0	1	0.3
0:45-1:00	0	0	0	0.0	0	0	0	0.0	0	0	0	0.0
1時間計	1	1	2	0.9	2	0	2	1.6	3	1	4	1.1
1:00-1:15	1	0	1	0.4	0	0	0	0.0	1	0	1	0.3
1:15-1:30	0	2	2	0.9	0	0	0	0.0	0	2	2	0.6
1:30-1:45	0	0	0	0.0	0	0	0	0.0	0	0	0	0.0
1:45-2:00	0	0	0	0.0	1	0	1	0.8	1	0	1	0.3
1時間計	1	2	3	1.3	1	0	1	0.8	2	2	4	1.1
2:00-2:15	0	0	0	0.0	0	0	0	0.0	0	0	0	0.0
2:15-2:30	0	1	1	0.4	0	0	0	0.0	0	1	1	0.3
2:30-2:45	0	0	0	0.0	0	0	0	0.0	0	0	0	0.0
2:45-3:00	0	1	1	0.4	0	0	0	0.0	0	1	1	0.3
1時間計	0	2	2	0.9	0	0	0	0.0	0	2	2	0.6
3:00-3:15	0	0	0	0.0	0	0	0	0.0	0	0	0	0.0
3:15-3:30	0	0	0	0.0	0	1	1	0.8	0	1	1	0.3
3:30-3:45	0	0	0	0.0	0	0	0	0.0	0	0	0	0.0
3:45-4:00	0	0	0	0.0	0	0	0	0.0	0	0	0	0.0
1時間計	0	0	0	0.0	0	1	1	0.8	0	1	1	0.3
4:00-4:15	1	0	1	0.4	0	0	0	0.0	1	0	1	0.3
4:15-4:30	1	0	1	0.4	0	0	0	0.0	1	0	1	0.3
4:30-4:45	0	0	0	0.0	0	0	0	0.0	0	0	0	0.0
4:45-5:00	0	0	0	0.0	1	0	1	0.8	1	0	1	0.3
1時間計	2	0	2	0.9	1	0	1	0.8	3	0	3	0.9
5:00-5:15	0	0	0	0.0	0	0	0	0.0	0	0	0	0.0
5:15-5:30	0	0	0	0.0	0	0	0	0.0	0	0	0	0.0
5:30-5:45	0	0	0	0.0	0	1	1	0.8	0	1	1	0.3
5:45-6:00	0	0	0	0.0	0	1	1	0.8	0	1	1	0.3
1時間計	0	0	0	0.0	0	2	2	1.6	0	2	2	0.6

歩行者通行量調査表

調査地点：地域社会3 上川井1C

調査年月日：令和元年 5月11日(土) 天候：晴れ時々曇り

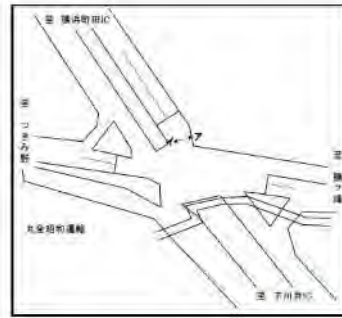

時間帯	方向 7				方向 1				合計 (7+1)			
	歩行者 (人)	自転車 (台)	合計 (人・台)	時間係数 (%)	歩行者 (人)	自転車 (台)	合計 (人・台)	時間係数 (%)	歩行者 (人)	自転車 (台)	合計 (人・台)	時間係数 (%)
6:00-6:15	1	0	1	0.4	1	0	1	0.8	2	0	2	0.6
6:15-6:30	0	1	1	0.4	0	0	0	0.0	0	1	1	0.3
6:30-6:45	0	1	1	0.4	0	0	0	0.0	0	1	1	0.3
6:45-7:00	0	1	1	0.4	2	1	3	2.4	2	2	4	1.1
1時間計	1	3	4	1.8	3	1	4	3.2	4	4	8	2.3
7:00-7:15	1	1	2	0.9	1	0	1	0.8	2	1	3	0.9
7:15-7:30	0	1	1	0.4	2	1	3	2.4	2	2	4	1.1
7:30-7:45	2	1	3	1.3	2	0	2	1.6	4	1	5	1.4
7:45-8:00	0	2	2	0.9	1	3	4	3.2	1	5	6	1.7
1時間計	3	5	8	3.6	6	4	10	8.0	9	9	18	5.2
8:00-8:15	1	1	2	0.9	3	2	5	4.0	4	3	7	2.0
8:15-8:30	2	5	7	3.1	2	3	5	4.0	4	8	12	3.4
8:30-8:45	1	1	2	0.9	1	2	3	2.4	2	3	5	1.4
8:45-9:00	0	3	3	1.3	0	0	0	0.0	0	3	3	0.9
1時間計	4	10	14	6.3	6	7	13	10.4	10	17	27	7.7
9:00-9:15	0	0	0	0.0	1	1	2	1.6	1	1	2	0.6
9:15-9:30	2	0	2	0.9	0	1	1	0.8	2	1	3	0.9
9:30-9:45	2	1	3	1.3	1	0	1	0.8	3	1	4	1.1
9:45-10:00	2	3	5	2.2	0	2	2	1.6	2	5	7	2.0
1時間計	6	4	10	4.5	2	4	6	4.8	8	8	16	4.6
10:00-10:15	5	5	10	4.5	1	4	5	4.0	6	9	15	4.3
10:15-10:30	2	4	6	2.7	0	1	1	0.8	2	5	7	2.0
10:30-10:45	1	1	2	0.9	1	1	2	1.6	2	2	4	1.1
10:45-11:00	2	1	3	1.3	2	1	3	2.4	4	2	6	1.7
1時間計	10	11	21	9.4	4	7	11	8.8	14	18	32	9.2
11:00-11:15	0	3	3	1.3	0	0	0	0.0	0	3	3	0.9
11:15-11:30	0	3	3	1.3	0	0	0	0.0	0	3	3	0.9
11:30-11:45	2	1	3	1.3	2	0	2	1.6	4	1	5	1.4
11:45-12:00	3	2	5	2.2	4	1	5	4.0	7	3	10	2.9
1時間計	5	9	14	6.3	6	1	7	5.6	11	10	21	6.0
12:00-12:15	1	0	1	0.4	1	0	1	0.8	2	0	2	0.6
12:15-12:30	1	2	3	1.3	2	3	5	4.0	3	5	8	2.3
12:30-12:45	0	0	0	0.0	0	4	4	3.2	0	4	4	1.1
12:45-13:00	1	3	4	1.8	1	0	1	0.8	2	3	5	1.4
1時間計	3	5	8	3.6	4	7	11	8.8	7	12	19	5.4
13:00-13:15	1	2	3	1.3	2	0	2	1.6	3	2	5	1.4
13:15-13:30	0	3	3	1.3	0	0	0	0.0	0	3	3	0.9
13:30-13:45	0	2	2	0.9	0	0	0	0.0	0	2	2	0.6
13:45-14:00	1	1	2	0.9	0	1	1	0.8	1	2	3	0.9
1時間計	2	8	10	4.5	2	1	3	2.4	4	9	13	3.7

歩行者通行量調査表

調査地点：地域社会3 上川井1C

調査年月日：令和元年 5月11日(土) 天候：晴れ時々曇り



方向	ア				イ				合計 (ア+イ)			
	歩行者 (人)	自転車 (台)	合計 (人・台)	時間 係数 (%)	歩行者 (人)	自転車 (台)	合計 (人・台)	時間 係数 (%)	歩行者 (人)	自転車 (台)	合計 (人・台)	時間 係数 (%)
14:00-14:15	2	5	7	3.1	0	1	1	0.8	2	6	8	2.3
14:15-14:30	0	5	5	2.2	1	2	3	2.4	1	7	8	2.3
14:30-14:45	2	7	9	4.0	0	0	0	0.0	2	7	9	2.6
14:45-15:00	0	4	4	1.8	0	1	1	0.8	0	5	5	1.4
1時間計	4	21	25	11.2	1	4	5	4.0	5	25	30	8.6
15:00-15:15	0	4	4	1.8	1	1	2	1.6	1	5	6	1.7
15:15-15:30	2	5	7	3.1	4	2	6	4.8	6	7	13	3.7
15:30-15:45	3	10	13	5.8	0	3	3	2.4	3	13	16	4.6
15:45-16:00	0	1	1	0.4	0	0	0	0.0	0	1	1	0.3
1時間計	5	20	25	11.2	5	6	11	8.8	10	26	36	10.3
16:00-16:15	5	1	6	2.7	1	0	1	0.8	6	1	7	2.0
16:15-16:30	3	2	5	2.2	1	1	2	1.6	4	3	7	2.0
16:30-16:45	3	2	5	2.2	0	0	0	0.0	3	2	5	1.4
16:45-17:00	3	2	5	2.2	4	0	4	3.2	7	2	9	2.6
1時間計	14	7	21	9.4	6	1	7	5.6	20	8	28	8.0
17:00-17:15	2	0	2	0.9	1	0	1	0.8	3	0	3	0.9
17:15-17:30	1	2	3	1.3	1	0	1	0.8	2	2	4	1.1
17:30-17:45	2	3	5	2.2	0	1	1	0.8	2	4	6	1.7
17:45-18:00	5	1	6	2.7	0	0	0	0.0	5	1	6	1.7
1時間計	10	6	16	7.1	2	1	3	2.4	12	7	19	5.4
18:00-18:15	0	2	2	0.9	0	1	1	0.8	0	3	3	0.9
18:15-18:30	0	1	1	0.4	0	0	0	0.0	0	1	1	0.3
18:30-18:45	1	3	4	1.8	0	0	0	0.0	1	3	4	1.1
18:45-19:00	2	1	3	1.3	1	0	1	0.8	3	1	4	1.1
1時間計	3	7	10	4.5	1	1	2	1.6	4	8	12	3.4
19:00-19:15	0	4	4	1.8	4	1	5	4.0	4	5	9	2.6
19:15-19:30	1	4	5	2.2	0	1	1	0.8	1	5	6	1.7
19:30-19:45	1	1	2	0.9	1	0	1	0.8	2	1	3	0.9
19:45-20:00	1	1	2	0.9	0	0	0	0.0	1	1	2	0.6
1時間計	3	10	13	5.8	5	2	7	5.6	8	12	20	5.7
20:00-20:15	0	2	2	0.9	1	0	1	0.8	1	2	3	0.9
20:15-20:30	1	0	1	0.4	0	1	1	0.8	1	1	2	0.6
20:30-20:45	0	1	1	0.4	2	2	4	3.2	2	3	5	1.4
20:45-21:00	0	0	0	0.0	1	0	1	0.8	1	0	1	0.3
1時間計	1	3	4	1.8	4	3	7	5.6	5	6	11	3.2
21:00-21:15	0	1	1	0.4	1	0	1	0.8	1	1	2	0.6
21:15-21:30	0	0	0	0.0	0	0	0	0.0	0	0	0	0.0
21:30-21:45	0	0	0	0.0	1	0	1	0.8	1	0	1	0.3
21:45-22:00	2	0	2	0.9	0	0	0	0.0	2	0	2	0.6
1時間計	2	1	3	1.3	2	0	2	1.6	4	1	5	1.4
昼12時間計	69	113	182	81.3	45	44	89	71.2	114	157	271	77.7
夜12時間計	18	24	42	18.8	25	11	36	28.8	43	35	78	22.3
全時間合計	87	137	224	100.0	70	55	125	100.0	157	192	349	100.0
昼夜率	1.26	1.21	1.23	-	1.56	1.25	1.40	-	1.38	1.22	1.29	-

歩行者通行量調査表

調査地点：地域社会3 上川井1C

調査年月日：令和元年 5月11日(土) 天候：晴れ時々曇り



時間帯	方向 種別	合計 (7+4)			時間 係数 (%)
		歩行者 (人)	自転車 (台)	合計 (人・台)	
22:00-22:15		1	1	2	0.6
22:15-22:30		3	0	3	0.9
22:30-22:45		2	0	2	0.6
22:45-23:00		1	1	2	0.6
1時間計		7	2	9	2.6
23:00-23:15		1	1	2	0.6
23:15-23:30		3	0	3	0.9
23:30-23:45		2	0	2	0.6
23:45-24:00		1	1	2	0.6
1時間計		7	2	9	2.6
0:00-0:15		2	0	2	0.6
0:15-0:30		0	1	1	0.3
0:30-0:45		1	0	1	0.3
0:45-1:00		0	0	0	0.0
1時間計		3	1	4	1.1
1:00-1:15		1	0	1	0.3
1:15-1:30		0	2	2	0.6
1:30-1:45		0	0	0	0.0
1:45-2:00		1	0	1	0.3
1時間計		2	2	4	1.1
2:00-2:15		0	0	0	0.0
2:15-2:30		0	1	1	0.3
2:30-2:45		0	0	0	0.0
2:45-3:00		0	1	1	0.3
1時間計		0	2	2	0.6
3:00-3:15		0	0	0	0.0
3:15-3:30		0	1	1	0.3
3:30-3:45		0	0	0	0.0
3:45-4:00		0	0	0	0.0
1時間計		0	1	1	0.3
4:00-4:15		1	0	1	0.3
4:15-4:30		1	0	1	0.3
4:30-4:45		0	0	0	0.0
4:45-5:00		1	0	1	0.3
1時間計		3	0	3	0.9
5:00-5:15		0	0	0	0.0
5:15-5:30		0	0	0	0.0
5:30-5:45		0	1	1	0.3
5:45-6:00		0	1	1	0.3
1時間計		0	2	2	0.6
6:00-6:15		2	0	2	0.6
6:15-6:30		0	1	1	0.3
6:30-6:45		0	1	1	0.3
6:45-7:00		2	2	4	1.1
1時間計		4	4	8	2.3
7:00-7:15		2	1	3	0.9
7:15-7:30		2	2	4	1.1
7:30-7:45		4	1	5	1.4
7:45-8:00		1	5	6	1.7
1時間計		9	9	18	5.2
8:00-8:15		4	3	7	2.0
8:15-8:30		4	8	12	3.4
8:30-8:45		2	3	5	1.4
8:45-9:00		0	3	3	0.9
1時間計		10	17	27	7.7
9:00-9:15		1	1	2	0.6
9:15-9:30		2	1	3	0.9
9:30-9:45		3	1	4	1.1
9:45-10:00		2	5	7	2.0
1時間計		8	8	16	4.6

時間帯	方向 種別	合計 (7+4)			時間 係数 (%)
		歩行者 (人)	自転車 (台)	合計 (人・台)	
22:00-23:00		7	2	9	2.6
22:15-23:15		7	2	9	2.6
22:30-23:30		7	2	9	2.6
22:45-23:45		7	2	9	2.6
23:00-0:00		7	2	9	2.6
23:15-0:15		8	1	9	2.6
23:30-0:30		5	2	7	2.0
23:45-0:45		4	2	6	1.7
0:00-1:00		3	1	4	1.1
0:15-1:15		2	1	3	0.9
0:30-1:30		2	2	4	1.1
0:45-1:45		1	2	3	0.9
1:00-2:00		2	2	4	1.1
1:15-2:15		1	2	3	0.9
1:30-2:30		1	1	2	0.6
1:45-2:45		1	1	2	0.6
2:00-3:00		0	2	2	0.6
2:15-3:15		0	2	2	0.6
2:30-3:30		0	2	2	0.6
2:45-3:45		0	2	2	0.6
3:00-4:00		0	1	1	0.3
3:15-4:15		1	1	2	0.6
3:30-4:30		2	0	2	0.6
3:45-4:45		2	0	2	0.6
4:00-5:00		3	0	3	0.9
4:15-5:15		2	0	2	0.6
4:30-5:30		1	0	1	0.3
4:45-5:45		1	1	2	0.6
5:00-6:00		0	2	2	0.6
5:15-6:15		2	2	4	1.1
5:30-6:30		2	3	5	1.4
5:45-6:45		2	3	5	1.4
6:00-7:00		4	4	8	2.3
6:15-7:15		4	5	9	2.6
6:30-7:30		6	6	12	3.4
6:45-7:45		10	6	16	4.6
7:00-8:00		9	9	18	5.2
7:15-8:15		11	11	22	6.3
7:30-8:30		13	17	30	8.6
7:45-8:45		11	19	30	8.6
8:00-9:00		10	17	27	7.7
8:15-9:15		7	15	22	6.3
8:30-9:30		5	8	13	3.7
8:45-9:45		6	6	12	3.4
9:00-10:00		8	8	16	4.6
9:15-10:15		13	16	29	8.3
9:30-10:30		13	20	33	9.5
9:45-10:45		12	21	33	9.5
10:00-11:00		14	18	32	9.2
10:15-11:15		8	12	20	5.7
10:30-11:30		6	10	16	4.6
10:45-11:45		8	9	17	4.9
11:00-12:00		11	10	21	6.0
11:15-12:15		13	7	20	5.7
11:30-12:30		16	9	25	7.2
11:45-12:45		12	12	24	6.9
12:00-13:00		7	12	19	5.4
12:15-13:15		8	14	22	6.3
12:30-13:30		5	12	17	4.9
12:45-13:45		5	10	15	4.3

歩行者通行量調査表

調査地点：地域社会3 上川井 IC

調査年月日：令和元年 5月11日(土) 天候：晴れ時々曇り



時間帯	種別	合計 (7+1)			時間係数 (%)
		歩行者 (人)	自転車 (台)	合計 (人・台)	
10:00-10:15		6	9	15	4.3
10:15-10:30		2	5	7	2.0
10:30-10:45		2	2	4	1.1
10:45-11:00		4	2	6	1.7
1時間計		14	18	32	9.2
11:00-11:15		0	3	3	0.9
11:15-11:30		0	3	3	0.9
11:30-11:45		4	1	5	1.4
11:45-12:00		7	3	10	2.9
1時間計		11	10	21	6.0
12:00-12:15		2	0	2	0.6
12:15-12:30		3	5	8	2.3
12:30-12:45		0	4	4	1.1
12:45-13:00		2	3	5	1.4
1時間計		7	12	19	5.4
13:00-13:15		3	2	5	1.4
13:15-13:30		0	3	3	0.9
13:30-13:45		0	2	2	0.6
13:45-14:00		1	2	3	0.9
1時間計		4	9	13	3.7
14:00-14:15		2	6	8	2.3
14:15-14:30		1	7	8	2.3
14:30-14:45		2	7	9	2.6
14:45-15:00		0	5	5	1.4
1時間計		5	25	30	8.6
15:00-15:15		1	5	6	1.7
15:15-15:30		6	7	13	3.7
15:30-15:45		3	13	16	4.6
15:45-16:00		0	1	1	0.3
1時間計		10	26	36	10.3
16:00-16:15		6	1	7	2.0
16:15-16:30		4	3	7	2.0
16:30-16:45		3	2	5	1.4
16:45-17:00		7	2	9	2.6
1時間計		20	8	28	8.0
17:00-17:15		3	0	3	0.9
17:15-17:30		2	2	4	1.1
17:30-17:45		2	4	6	1.7
17:45-18:00		5	1	6	1.7
1時間計		12	7	19	5.4
18:00-18:15		0	3	3	0.9
18:15-18:30		0	1	1	0.3
18:30-18:45		1	3	4	1.1
18:45-19:00		3	1	4	1.1
1時間計		4	8	12	3.4
19:00-19:15		4	5	9	2.6
19:15-19:30		1	5	6	1.7
19:30-19:45		2	1	3	0.9
19:45-20:00		1	1	2	0.6
1時間計		8	12	20	5.7
20:00-20:15		1	2	3	0.9
20:15-20:30		1	1	2	0.6
20:30-20:45		2	3	5	1.4
20:45-21:00		1	0	1	0.3
1時間計		5	6	11	3.2
21:00-21:15		1	1	2	0.6
21:15-21:30		0	0	0	0.0
21:30-21:45		1	0	1	0.3
21:45-22:00		2	0	2	0.6
1時間計		4	1	5	1.4
昼12時間計		114	157	271	77.7
夜12時間計		43	35	78	22.3
全時間合計		157	192	349	100.0
昼夜率		1.38	1.22	1.29	-

時間帯	種別	合計 (7+1)			時間係数 (%)
		歩行者 (人)	自転車 (台)	合計 (人・台)	
13:00-14:00		4	9	13	3.7
13:15-14:15		3	13	16	4.6
13:30-14:30		4	17	21	6.0
13:45-14:45		6	22	28	8.0
14:00-15:00		5	25	30	8.6
14:15-15:15		4	24	28	8.0
14:30-15:30		9	24	33	9.5
14:45-15:45		10	30	40	11.5
15:00-16:00		10	26	36	10.3
15:15-16:15		15	22	37	10.6
15:30-16:30		13	18	31	8.9
15:45-16:45		13	7	20	5.7
16:00-17:00		20	8	28	8.0
16:15-17:15		17	7	24	6.9
16:30-17:30		15	6	21	6.0
16:45-17:45		14	8	22	6.3
17:00-18:00		12	7	19	5.4
17:15-18:15		9	10	19	5.4
17:30-18:30		7	9	16	4.6
17:45-18:45		6	8	14	4.0
18:00-19:00		4	8	12	3.4
18:15-19:15		8	10	18	5.2
18:30-19:30		9	14	23	6.6
18:45-19:45		10	12	22	6.3
19:00-20:00		8	12	20	5.7
19:15-20:15		5	9	14	4.0
19:30-20:30		5	5	10	2.9
19:45-20:45		5	7	12	3.4
20:00-21:00		5	6	11	3.2
20:15-21:15		5	5	10	2.9
20:30-21:30		4	4	8	2.3
20:45-21:45		3	1	4	1.1
21:00-22:00		4	1	5	1.4
全時間合計		157	192	349	100.0

歩行者通行量調査表

調査地点：地域社会4 滝沢

調査年月日：令和 2年 9月26日(土) 天候：晴れ一時雨



時間帯	方向 7				方向 1				合計			
	歩行者 (人)	自転車 (台)	合計 (人・台)	時間 係数 (%)	歩行者 (人)	自転車 (台)	合計 (人・台)	時間 係数 (%)	歩行者 (人)	自転車 (台)	合計 (人・台)	時間 係数 (%)
22:00-22:15	0	0	0	0.0	0	0	0	0.0	0	0	0	0.0
22:15-22:30	0	0	0	0.0	0	0	0	0.0	0	0	0	0.0
22:30-22:45	0	0	0	0.0	0	0	0	0.0	0	0	0	0.0
22:45-23:00	0	0	0	0.0	0	0	0	0.0	0	0	0	0.0
1時間計	0	0	0	0.0	0	0	0	0.0	0	0	0	0.0
23:00-23:15	0	0	0	0.0	0	0	0	0.0	0	0	0	0.0
23:15-23:30	0	0	0	0.0	0	0	0	0.0	0	0	0	0.0
23:30-23:45	0	0	0	0.0	0	0	0	0.0	0	0	0	0.0
23:45-24:00	0	0	0	0.0	0	0	0	0.0	0	0	0	0.0
1時間計	0	0	0	0.0	0	0	0	0.0	0	0	0	0.0
0:00-0:15	0	0	0	0.0	0	0	0	0.0	0	0	0	0.0
0:15-0:30	0	0	0	0.0	0	0	0	0.0	0	0	0	0.0
0:30-0:45	0	0	0	0.0	0	0	0	0.0	0	0	0	0.0
0:45-1:00	0	0	0	0.0	0	0	0	0.0	0	0	0	0.0
1時間計	0	0	0	0.0	0	0	0	0.0	0	0	0	0.0
1:00-1:15	0	0	0	0.0	0	0	0	0.0	0	0	0	0.0
1:15-1:30	0	0	0	0.0	0	0	0	0.0	0	0	0	0.0
1:30-1:45	0	0	0	0.0	0	0	0	0.0	0	0	0	0.0
1:45-2:00	0	0	0	0.0	0	0	0	0.0	0	0	0	0.0
1時間計	0	0	0	0.0	0	0	0	0.0	0	0	0	0.0
2:00-2:15	0	0	0	0.0	0	0	0	0.0	0	0	0	0.0
2:15-2:30	0	0	0	0.0	0	0	0	0.0	0	0	0	0.0
2:30-2:45	0	0	0	0.0	0	0	0	0.0	0	0	0	0.0
2:45-3:00	0	0	0	0.0	0	0	0	0.0	0	0	0	0.0
1時間計	0	0	0	0.0	0	0	0	0.0	0	0	0	0.0
3:00-3:15	0	0	0	0.0	0	0	0	0.0	0	0	0	0.0
3:15-3:30	0	0	0	0.0	0	0	0	0.0	0	0	0	0.0
3:30-3:45	0	0	0	0.0	0	0	0	0.0	0	0	0	0.0
3:45-4:00	0	0	0	0.0	0	0	0	0.0	0	0	0	0.0
1時間計	0	0	0	0.0	0	0	0	0.0	0	0	0	0.0
4:00-4:15	0	0	0	0.0	0	0	0	0.0	0	0	0	0.0
4:15-4:30	0	0	0	0.0	0	0	0	0.0	0	0	0	0.0
4:30-4:45	0	0	0	0.0	0	0	0	0.0	0	0	0	0.0
4:45-5:00	0	0	0	0.0	0	0	0	0.0	0	0	0	0.0
1時間計	0	0	0	0.0	0	0	0	0.0	0	0	0	0.0
5:00-5:15	0	0	0	0.0	0	0	0	0.0	0	0	0	0.0
5:15-5:30	1	0	1	7.1	0	0	0	0.0	1	0	1	5.3
5:30-5:45	0	0	0	0.0	0	0	0	0.0	0	0	0	0.0
5:45-6:00	1	0	1	7.1	0	0	0	0.0	1	0	1	5.3
1時間計	2	0	2	14.3	0	0	0	0.0	2	0	2	10.5

歩行者通行量調査表

調査地点：地域社会4 滝沢

調査年月日：令和 2年 9月26日(土) 天候：晴れ一時雨



時間帯	方向 7				方向 1				合計			
	歩行者 (人)	自転車 (台)	合計 (人・台)	時間 係数 (%)	歩行者 (人)	自転車 (台)	合計 (人・台)	時間 係数 (%)	歩行者 (人)	自転車 (台)	合計 (人・台)	時間 係数 (%)
6:00-6:15	0	0	0	0.0	0	0	0	0.0	0	0	0	0.0
6:15-6:30	0	0	0	0.0	0	0	0	0.0	0	0	0	0.0
6:30-6:45	0	0	0	0.0	0	0	0	0.0	0	0	0	0.0
6:45-7:00	0	0	0	0.0	0	0	0	0.0	0	0	0	0.0
1時間計	0	0	0	0.0	0	0	0	0.0	0	0	0	0.0
7:00-7:15	0	0	0	0.0	0	0	0	0.0	0	0	0	0.0
7:15-7:30	0	0	0	0.0	0	0	0	0.0	0	0	0	0.0
7:30-7:45	0	0	0	0.0	0	0	0	0.0	0	0	0	0.0
7:45-8:00	0	0	0	0.0	0	0	0	0.0	0	0	0	0.0
1時間計	0	0	0	0.0	0	0	0	0.0	0	0	0	0.0
8:00-8:15	0	0	0	0.0	1	0	1	20.0	1	0	1	5.3
8:15-8:30	0	0	0	0.0	0	0	0	0.0	0	0	0	0.0
8:30-8:45	0	0	0	0.0	0	0	0	0.0	0	0	0	0.0
8:45-9:00	0	0	0	0.0	0	0	0	0.0	0	0	0	0.0
1時間計	0	0	0	0.0	1	0	1	20.0	1	0	1	5.3
9:00-9:15	0	0	0	0.0	0	0	0	0.0	0	0	0	0.0
9:15-9:30	0	0	0	0.0	0	0	0	0.0	0	0	0	0.0
9:30-9:45	2	0	2	14.3	2	0	2	40.0	4	0	4	21.1
9:45-10:00	0	0	0	0.0	0	0	0	0.0	0	0	0	0.0
1時間計	2	0	2	14.3	2	0	2	40.0	4	0	4	21.1
10:00-10:15	0	1	1	7.1	0	0	0	0.0	0	1	1	5.3
10:15-10:30	0	1	1	7.1	0	0	0	0.0	0	1	1	5.3
10:30-10:45	0	0	0	0.0	0	0	0	0.0	0	0	0	0.0
10:45-11:00	0	0	0	0.0	0	0	0	0.0	0	0	0	0.0
1時間計	0	2	2	14.3	0	0	0	0.0	0	2	2	10.5
11:00-11:15	1	1	2	14.3	0	0	0	0.0	1	1	2	10.5
11:15-11:30	0	0	0	0.0	0	0	0	0.0	0	0	0	0.0
11:30-11:45	0	1	1	7.1	0	0	0	0.0	0	1	1	5.3
11:45-12:00	0	0	0	0.0	0	0	0	0.0	0	0	0	0.0
1時間計	1	2	3	21.4	0	0	0	0.0	1	2	3	15.8
12:00-12:15	0	0	0	0.0	0	0	0	0.0	0	0	0	0.0
12:15-12:30	0	0	0	0.0	0	0	0	0.0	0	0	0	0.0
12:30-12:45	0	0	0	0.0	0	0	0	0.0	0	0	0	0.0
12:45-13:00	0	0	0	0.0	0	0	0	0.0	0	0	0	0.0
1時間計	0	0	0	0.0	0	0	0	0.0	0	0	0	0.0
13:00-13:15	0	0	0	0.0	0	0	0	0.0	0	0	0	0.0
13:15-13:30	0	0	0	0.0	0	0	0	0.0	0	0	0	0.0
13:30-13:45	0	0	0	0.0	0	0	0	0.0	0	0	0	0.0
13:45-14:00	0	0	0	0.0	0	0	0	0.0	0	0	0	0.0
1時間計	0	0	0	0.0	0	0	0	0.0	0	0	0	0.0

歩行者通行量調査表

調査地点：地域社会4 滝沢

調査年月日：令和 2年 9月26日(土) 天候：晴れ一時雨



時間帯	7				イ				合計			
	歩行者 (人)	自転車 (台)	合計 (人・台)	時間 係数 (%)	歩行者 (人)	自転車 (台)	合計 (人・台)	時間 係数 (%)	歩行者 (人)	自転車 (台)	合計 (人・台)	時間 係数 (%)
14:00-14:15	0	0	0	0.0	0	0	0	0.0	0	0	0	0.0
14:15-14:30	0	0	0	0.0	0	0	0	0.0	0	0	0	0.0
14:30-14:45	0	0	0	0.0	0	0	0	0.0	0	0	0	0.0
14:45-15:00	0	0	0	0.0	0	0	0	0.0	0	0	0	0.0
1時間計	0	0	0	0.0	0	0	0	0.0	0	0	0	0.0
15:00-15:15	0	0	0	0.0	0	0	0	0.0	0	0	0	0.0
15:15-15:30	1	0	1	7.1	0	1	1	20.0	1	1	2	10.5
15:30-15:45	0	2	2	14.3	0	0	0	0.0	0	2	2	10.5
15:45-16:00	0	0	0	0.0	0	0	0	0.0	0	0	0	0.0
1時間計	1	2	3	21.4	0	1	1	20.0	1	3	4	21.1
16:00-16:15	0	1	1	7.1	0	0	0	0.0	0	1	1	5.3
16:15-16:30	0	0	0	0.0	0	0	0	0.0	0	0	0	0.0
16:30-16:45	1	0	1	7.1	0	0	0	0.0	1	0	1	5.3
16:45-17:00	0	0	0	0.0	0	0	0	0.0	0	0	0	0.0
1時間計	1	1	2	14.3	0	0	0	0.0	1	1	2	10.5
17:00-17:15	0	0	0	0.0	0	0	0	0.0	0	0	0	0.0
17:15-17:30	0	0	0	0.0	0	0	0	0.0	0	0	0	0.0
17:30-17:45	0	0	0	0.0	0	0	0	0.0	0	0	0	0.0
17:45-18:00	0	0	0	0.0	0	0	0	0.0	0	0	0	0.0
1時間計	0	0	0	0.0	0	0	0	0.0	0	0	0	0.0
18:00-18:15	0	0	0	0.0	0	0	0	0.0	0	0	0	0.0
18:15-18:30	0	0	0	0.0	0	0	0	0.0	0	0	0	0.0
18:30-18:45	0	0	0	0.0	0	1	1	20.0	0	1	1	5.3
18:45-19:00	0	0	0	0.0	0	0	0	0.0	0	0	0	0.0
1時間計	0	0	0	0.0	0	1	1	20.0	0	1	1	5.3
19:00-19:15	0	0	0	0.0	0	0	0	0.0	0	0	0	0.0
19:15-19:30	0	0	0	0.0	0	0	0	0.0	0	0	0	0.0
19:30-19:45	0	0	0	0.0	0	0	0	0.0	0	0	0	0.0
19:45-20:00	0	0	0	0.0	0	0	0	0.0	0	0	0	0.0
1時間計	0	0	0	0.0	0	0	0	0.0	0	0	0	0.0
20:00-20:15	0	0	0	0.0	0	0	0	0.0	0	0	0	0.0
20:15-20:30	0	0	0	0.0	0	0	0	0.0	0	0	0	0.0
20:30-20:45	0	0	0	0.0	0	0	0	0.0	0	0	0	0.0
20:45-21:00	0	0	0	0.0	0	0	0	0.0	0	0	0	0.0
1時間計	0	0	0	0.0	0	0	0	0.0	0	0	0	0.0
21:00-21:15	0	0	0	0.0	0	0	0	0.0	0	0	0	0.0
21:15-21:30	0	0	0	0.0	0	0	0	0.0	0	0	0	0.0
21:30-21:45	0	0	0	0.0	0	0	0	0.0	0	0	0	0.0
21:45-22:00	0	0	0	0.0	0	0	0	0.0	0	0	0	0.0
1時間計	0	0	0	0.0	0	0	0	0.0	0	0	0	0.0
昼12時間計	5	7	12	85.7	3	2	5	100.0	8	9	17	89.5
夜12時間計	2	0	2	14.3	0	0	0	0.0	2	0	2	10.5
全時間合計	7	7	14	100.0	3	2	5	100.0	10	9	19	100.0
昼夜率	1.40	1.00	1.17	-	1.00	1.00	1.00	-	1.25	1.00	1.12	-

歩行者通行量調査表

調査地点：地域社会4 滝沢

調査年月日：令和 2年 9月26日(土) 天候：晴れ一時雨



時間帯	方向				I				合計			
	歩行者 (人)	自転車 (台)	合計 (人・台)	時間 係数 (%)	歩行者 (人)	自転車 (台)	合計 (人・台)	時間 係数 (%)	歩行者 (人)	自転車 (台)	合計 (人・台)	時間 係数 (%)
22:00-22:15	0	1	1	0.5	0	1	1	1.0	0	2	2	0.6
22:15-22:30	0	0	0	0.0	0	0	0	0.0	0	0	0	0.0
22:30-22:45	1	2	3	1.4	0	1	1	1.0	1	3	4	1.3
22:45-23:00	0	0	0	0.0	0	0	0	0.0	0	0	0	0.0
1時間計	1	3	4	1.8	0	2	2	2.0	1	5	6	1.9
23:00-23:15	1	1	2	0.9	0	0	0	0.0	1	1	2	0.6
23:15-23:30	0	0	0	0.0	0	0	0	0.0	0	0	0	0.0
23:30-23:45	0	0	0	0.0	1	0	1	1.0	1	0	1	0.3
23:45-24:00	0	1	1	0.5	0	0	0	0.0	0	1	1	0.3
1時間計	1	2	3	1.4	1	0	1	1.0	2	2	4	1.3
0:00-0:15	0	0	0	0.0	0	0	0	0.0	0	0	0	0.0
0:15-0:30	0	0	0	0.0	1	0	1	1.0	1	0	1	0.3
0:30-0:45	0	0	0	0.0	0	0	0	0.0	0	0	0	0.0
0:45-1:00	0	0	0	0.0	0	0	0	0.0	0	0	0	0.0
1時間計	0	0	0	0.0	1	0	1	1.0	1	0	1	0.3
1:00-1:15	0	0	0	0.0	0	0	0	0.0	0	0	0	0.0
1:15-1:30	0	0	0	0.0	0	0	0	0.0	0	0	0	0.0
1:30-1:45	1	0	1	0.5	0	0	0	0.0	1	0	1	0.3
1:45-2:00	0	0	0	0.0	0	0	0	0.0	0	0	0	0.0
1時間計	1	0	1	0.5	0	0	0	0.0	1	0	1	0.3
2:00-2:15	0	0	0	0.0	0	0	0	0.0	0	0	0	0.0
2:15-2:30	0	0	0	0.0	0	0	0	0.0	0	0	0	0.0
2:30-2:45	0	0	0	0.0	0	0	0	0.0	0	0	0	0.0
2:45-3:00	0	0	0	0.0	0	0	0	0.0	0	0	0	0.0
1時間計	0	0	0	0.0	0	0	0	0.0	0	0	0	0.0
3:00-3:15	0	0	0	0.0	0	0	0	0.0	0	0	0	0.0
3:15-3:30	0	0	0	0.0	0	0	0	0.0	0	0	0	0.0
3:30-3:45	0	0	0	0.0	0	0	0	0.0	0	0	0	0.0
3:45-4:00	0	0	0	0.0	0	0	0	0.0	0	0	0	0.0
1時間計	0	0	0	0.0	0	0	0	0.0	0	0	0	0.0
4:00-4:15	1	0	1	0.5	0	0	0	0.0	1	0	1	0.3
4:15-4:30	0	0	0	0.0	0	0	0	0.0	0	0	0	0.0
4:30-4:45	0	0	0	0.0	2	0	2	2.0	2	0	2	0.6
4:45-5:00	0	0	0	0.0	2	0	2	2.0	2	0	2	0.6
1時間計	1	0	1	0.5	4	0	4	4.0	5	0	5	1.6
5:00-5:15	0	0	0	0.0	0	0	0	0.0	0	0	0	0.0
5:15-5:30	2	0	2	0.9	0	0	0	0.0	2	0	2	0.6
5:30-5:45	1	2	3	1.4	0	0	0	0.0	1	2	3	0.9
5:45-6:00	1	0	1	0.5	1	0	1	1.0	2	0	2	0.6
1時間計	4	2	6	2.8	1	0	1	1.0	5	2	7	2.2

歩行者通行量調査表

調査地点：地域社会4 滝沢

調査年月日：令和 2年 9月26日(土) 天候：晴れ一時雨



時間帯	方向				I				合計				
	種別	歩行者 (人)	自転車 (台)	合計 (人・台)	時間 係数 (%)	歩行者 (人)	自転車 (台)	合計 (人・台)	時間 係数 (%)	歩行者 (人)	自転車 (台)	合計 (人・台)	時間 係数 (%)
6:00-6:15		1	1	2	0.9	0	0	0	0.0	1	1	2	0.6
6:15-6:30		0	0	0	0.0	0	0	0	0.0	0	0	0	0.0
6:30-6:45		3	2	5	2.3	3	0	3	3.0	6	2	8	2.5
6:45-7:00		3	2	5	2.3	0	1	1	1.0	3	3	6	1.9
1時間計		7	5	12	5.5	3	1	4	4.0	10	6	16	5.1
7:00-7:15		1	0	1	0.5	1	0	1	1.0	2	0	2	0.6
7:15-7:30		0	1	1	0.5	2	0	2	2.0	2	1	3	0.9
7:30-7:45		1	7	8	3.7	0	0	0	0.0	1	7	8	2.5
7:45-8:00		0	2	2	0.9	1	0	1	1.0	1	2	3	0.9
1時間計		2	10	12	5.5	4	0	4	4.0	6	10	16	5.1
8:00-8:15		2	4	6	2.8	3	1	4	4.0	5	5	10	3.2
8:15-8:30		0	6	6	2.8	0	0	0	0.0	0	6	6	1.9
8:30-8:45		1	3	4	1.8	0	2	2	2.0	1	5	6	1.9
8:45-9:00		0	3	3	1.4	1	1	2	2.0	1	4	5	1.6
1時間計		3	16	19	8.8	4	4	8	8.1	7	20	27	8.5
9:00-9:15		0	1	1	0.5	3	0	3	3.0	3	1	4	1.3
9:15-9:30		0	3	3	1.4	0	0	0	0.0	0	3	3	0.9
9:30-9:45		0	4	4	1.8	2	1	3	3.0	2	5	7	2.2
9:45-10:00		0	4	4	1.8	0	0	0	0.0	0	4	4	1.3
1時間計		0	12	12	5.5	5	1	6	6.1	5	13	18	5.7
10:00-10:15		0	2	2	0.9	2	0	2	2.0	2	2	4	1.3
10:15-10:30		7	5	12	5.5	0	0	0	0.0	7	5	12	3.8
10:30-10:45		0	8	8	3.7	0	2	2	2.0	0	10	10	3.2
10:45-11:00		5	3	8	3.7	3	0	3	3.0	8	3	11	3.5
1時間計		12	18	30	13.8	5	2	7	7.1	17	20	37	11.7
11:00-11:15		2	4	6	2.8	0	0	0	0.0	2	4	6	1.9
11:15-11:30		0	0	0	0.0	0	0	0	0.0	0	0	0	0.0
11:30-11:45		1	2	3	1.4	1	0	1	1.0	2	2	4	1.3
11:45-12:00		1	1	2	0.9	0	0	0	0.0	1	1	2	0.6
1時間計		4	7	11	5.1	1	0	1	1.0	5	7	12	3.8
12:00-12:15		0	3	3	1.4	0	0	0	0.0	0	3	3	0.9
12:15-12:30		1	1	2	0.9	0	0	0	0.0	1	1	2	0.6
12:30-12:45		0	3	3	1.4	0	0	0	0.0	0	3	3	0.9
12:45-13:00		2	3	5	2.3	3	3	6	6.1	5	6	11	3.5
1時間計		3	10	13	6.0	3	3	6	6.1	6	13	19	6.0
13:00-13:15		0	6	6	2.8	0	1	1	1.0	0	7	7	2.2
13:15-13:30		1	0	1	0.5	0	0	0	0.0	1	0	1	0.3
13:30-13:45		1	6	7	3.2	0	3	3	3.0	1	9	10	3.2
13:45-14:00		1	1	2	0.9	2	0	2	2.0	3	1	4	1.3
1時間計		3	13	16	7.4	2	4	6	6.1	5	17	22	7.0

歩行者通行量調査表

調査地点：地域社会4 滝沢

調査年月日：令和 2年 9月26日(土) 天候：晴れ一時雨



時間帯	方向				I				合計			
	歩行者 (人)	自転車 (台)	合計 (人・台)	時間係数 (%)	歩行者 (人)	自転車 (台)	合計 (人・台)	時間係数 (%)	歩行者 (人)	自転車 (台)	合計 (人・台)	時間係数 (%)
14:00-14:15	1	3	4	1.8	2	0	2	2.0	3	3	6	1.9
14:15-14:30	1	2	3	1.4	0	0	0	0.0	1	2	3	0.9
14:30-14:45	0	5	5	2.3	1	0	1	1.0	1	5	6	1.9
14:45-15:00	2	1	3	1.4	0	0	0	0.0	2	1	3	0.9
1時間計	4	11	15	6.9	3	0	3	3.0	7	11	18	5.7
15:00-15:15	0	1	1	0.5	0	0	0	0.0	0	1	1	0.3
15:15-15:30	1	1	2	0.9	1	2	3	3.0	2	3	5	1.6
15:30-15:45	2	3	5	2.3	2	6	8	8.1	4	9	13	4.1
15:45-16:00	3	0	3	1.4	0	0	0	0.0	3	0	3	0.9
1時間計	6	5	11	5.1	3	8	11	11.1	9	13	22	7.0
16:00-16:15	3	1	4	1.8	0	0	0	0.0	3	1	4	1.3
16:15-16:30	0	3	3	1.4	0	0	0	0.0	0	3	3	0.9
16:30-16:45	1	3	4	1.8	0	0	0	0.0	1	3	4	1.3
16:45-17:00	1	3	4	1.8	2	1	3	3.0	3	4	7	2.2
1時間計	5	10	15	6.9	2	1	3	3.0	7	11	18	5.7
17:00-17:15	1	3	4	1.8	0	0	0	0.0	1	3	4	1.3
17:15-17:30	1	2	3	1.4	1	0	1	1.0	2	2	4	1.3
17:30-17:45	1	7	8	3.7	0	1	1	1.0	1	8	9	2.8
17:45-18:00	0	2	2	0.9	0	2	2	2.0	0	4	4	1.3
1時間計	3	14	17	7.8	1	3	4	4.0	4	17	21	6.6
18:00-18:15	0	2	2	0.9	2	4	6	6.1	2	6	8	2.5
18:15-18:30	0	2	2	0.9	1	1	2	2.0	1	3	4	1.3
18:30-18:45	2	1	3	1.4	1	2	3	3.0	3	3	6	1.9
18:45-19:00	0	2	2	0.9	2	0	2	2.0	2	2	4	1.3
1時間計	2	7	9	4.1	6	7	13	13.1	8	14	22	7.0
19:00-19:15	0	0	0	0.0	0	0	0	0.0	0	0	0	0.0
19:15-19:30	0	0	0	0.0	2	3	5	5.1	2	3	5	1.6
19:30-19:45	2	0	2	0.9	0	3	3	3.0	2	3	5	1.6
19:45-20:00	0	0	0	0.0	1	1	2	2.0	1	1	2	0.6
1時間計	2	0	2	0.9	3	7	10	10.1	5	7	12	3.8
20:00-20:15	1	3	4	1.8	1	0	1	1.0	2	3	5	1.6
20:15-20:30	0	0	0	0.0	0	0	0	0.0	0	0	0	0.0
20:30-20:45	0	2	2	0.9	1	0	1	1.0	1	2	3	0.9
20:45-21:00	0	0	0	0.0	0	0	0	0.0	0	0	0	0.0
1時間計	1	5	6	2.8	2	0	2	2.0	3	5	8	2.5
21:00-21:15	0	0	0	0.0	0	1	1	1.0	0	1	1	0.3
21:15-21:30	0	1	1	0.5	0	0	0	0.0	0	1	1	0.3
21:30-21:45	0	1	1	0.5	0	0	0	0.0	0	1	1	0.3
21:45-22:00	0	0	0	0.0	1	0	1	1.0	1	0	1	0.3
1時間計	0	2	2	0.9	1	1	2	2.0	1	3	4	1.3
昼12時間計	47	133	180	82.9	39	33	72	72.7	86	166	252	79.7
夜12時間計	18	19	37	17.1	16	11	27	27.3	34	30	64	20.3
全時間合計	65	152	217	100.0	55	44	99	100.0	120	196	316	100.0
昼夜率	1.38	1.14	1.21	-	1.41	1.33	1.38	-	1.40	1.18	1.25	-

歩行者通行量調査表

調査地点：地域社会4 滝沢

調査年月日：令和 2年 9月26日(土) 天候：晴れ一時雨



時間帯	種別	方向 合計 (7+I+U+E)			
		歩行者 (人)	自転車 (台)	合計 (人・台)	係数 (%)
22:00-22:15		0	2	2	0.6
22:15-22:30		0	0	0	0.0
22:30-22:45		1	3	4	1.2
22:45-23:00		0	0	0	0.0
1時間計		1	5	6	1.8
23:00-23:15		1	1	2	0.6
23:15-23:30		0	0	0	0.0
23:30-23:45		1	0	1	0.3
23:45-24:00		0	1	1	0.3
1時間計		2	2	4	1.2
0:00-0:15		0	0	0	0.0
0:15-0:30		1	0	1	0.3
0:30-0:45		0	0	0	0.0
0:45-1:00		0	0	0	0.0
1時間計		1	0	1	0.3
1:00-1:15		0	0	0	0.0
1:15-1:30		0	0	0	0.0
1:30-1:45		1	0	1	0.3
1:45-2:00		0	0	0	0.0
1時間計		1	0	1	0.3
2:00-2:15		0	0	0	0.0
2:15-2:30		0	0	0	0.0
2:30-2:45		0	0	0	0.0
2:45-3:00		0	0	0	0.0
1時間計		0	0	0	0.0
3:00-3:15		0	0	0	0.0
3:15-3:30		0	0	0	0.0
3:30-3:45		0	0	0	0.0
3:45-4:00		0	0	0	0.0
1時間計		0	0	0	0.0
4:00-4:15		1	0	1	0.3
4:15-4:30		0	0	0	0.0
4:30-4:45		2	0	2	0.6
4:45-5:00		2	0	2	0.6
1時間計		5	0	5	1.5
5:00-5:15		0	0	0	0.0
5:15-5:30		3	0	3	0.9
5:30-5:45		1	2	3	0.9
5:45-6:00		3	0	3	0.9
1時間計		7	2	9	2.7
6:00-6:15		1	1	2	0.6
6:15-6:30		0	0	0	0.0
6:30-6:45		6	2	8	2.4
6:45-7:00		3	3	6	1.8
1時間計		10	6	16	4.8
7:00-7:15		2	0	2	0.6
7:15-7:30		2	1	3	0.9
7:30-7:45		1	7	8	2.4
7:45-8:00		1	2	3	0.9
1時間計		6	10	16	4.8
8:00-8:15		6	5	11	3.3
8:15-8:30		0	6	6	1.8
8:30-8:45		1	5	6	1.8
8:45-9:00		1	4	5	1.5
1時間計		8	20	28	8.4
9:00-9:15		3	1	4	1.2
9:15-9:30		0	3	3	0.9
9:30-9:45		6	5	11	3.3
9:45-10:00		0	4	4	1.2
1時間計		9	13	22	6.6

時間帯	種別	方向 合計 (7+I+U+E)			
		歩行者 (人)	自転車 (台)	合計 (人・台)	係数 (%)
22:00-23:00		1	5	6	1.8
22:15-23:15		2	4	6	1.8
22:30-23:30		2	4	6	1.8
22:45-23:45		2	1	3	0.9
23:00-0:00		2	2	4	1.2
23:15-0:15		1	1	2	0.6
23:30-0:30		2	1	3	0.9
23:45-0:45		1	1	2	0.6
0:00-1:00		1	0	1	0.3
0:15-1:15		1	0	1	0.3
0:30-1:30		0	0	0	0.0
0:45-1:45		1	0	1	0.3
1:00-2:00		1	0	1	0.3
1:15-2:15		1	0	1	0.3
1:30-2:30		1	0	1	0.3
1:45-2:45		0	0	0	0.0
2:00-3:00		0	0	0	0.0
2:15-3:15		0	0	0	0.0
2:30-3:30		0	0	0	0.0
2:45-3:45		0	0	0	0.0
3:00-4:00		0	0	0	0.0
3:15-4:15		1	0	1	0.3
3:30-4:30		1	0	1	0.3
3:45-4:45		3	0	3	0.9
4:00-5:00		5	0	5	1.5
4:15-5:15		4	0	4	1.2
4:30-5:30		7	0	7	2.1
4:45-5:45		6	2	8	2.4
5:00-6:00		7	2	9	2.7
5:15-6:15		8	3	11	3.3
5:30-6:30		5	3	8	2.4
5:45-6:45		10	3	13	3.9
6:00-7:00		10	6	16	4.8
6:15-7:15		11	5	16	4.8
6:30-7:30		13	6	19	5.7
6:45-7:45		8	11	19	5.7
7:00-8:00		6	10	16	4.8
7:15-8:15		10	15	25	7.5
7:30-8:30		8	20	28	8.4
7:45-8:45		8	18	26	7.8
8:00-9:00		8	20	28	8.4
8:15-9:15		5	16	21	6.3
8:30-9:30		5	13	18	5.4
8:45-9:45		10	13	23	6.9
9:00-10:00		9	13	22	6.6
9:15-10:15		8	15	23	6.9
9:30-10:30		15	18	33	9.9
9:45-10:45		9	23	32	9.6
10:00-11:00		17	22	39	11.6
10:15-11:15		18	24	42	12.5
10:30-11:30		11	18	29	8.7
10:45-11:45		13	11	24	7.2
11:00-12:00		6	9	15	4.5
11:15-12:15		3	7	10	3.0
11:30-12:30		4	8	12	3.6
11:45-12:45		2	8	10	3.0
12:00-13:00		6	13	19	5.7
12:15-13:15		6	17	23	6.9
12:30-13:30		6	16	22	6.6
12:45-13:45		7	22	29	8.7

歩行者通行量調査表

調査地点：地域社会4 滝沢

調査年月日：令和 2年 9月26日(土) 天候：晴れ一時雨



時間帯	種別	合計 (7+I+U+E)			時間係数 (%)
		歩行者 (人)	自転車 (台)	合計 (人・台)	
10:00-10:15		2	3	5	1.5
10:15-10:30		7	6	13	3.9
10:30-10:45		0	10	10	3.0
10:45-11:00		8	2	11	3.3
1時間計		17	22	39	11.6
11:00-11:15		3	5	8	2.4
11:15-11:30		0	0	0	0.0
11:30-11:45		2	3	5	1.5
11:45-12:00		1	1	2	0.6
1時間計		6	9	15	4.5
12:00-12:15		0	3	3	0.9
12:15-12:30		1	1	2	0.6
12:30-12:45		0	3	3	0.9
12:45-13:00		5	6	11	3.3
1時間計		6	13	19	5.7
13:00-13:15		0	7	7	2.1
13:15-13:30		1	0	1	0.3
13:30-13:45		1	9	10	3.0
13:45-14:00		3	1	4	1.2
1時間計		5	17	22	6.6
14:00-14:15		3	3	6	1.8
14:15-14:30		1	2	3	0.9
14:30-14:45		1	5	6	1.8
14:45-15:00		2	1	3	0.9
1時間計		7	11	18	5.4
15:00-15:15		0	1	1	0.3
15:15-15:30		3	4	7	2.1
15:30-15:45		4	11	15	4.5
15:45-16:00		3	0	3	0.9
1時間計		10	16	26	7.8
16:00-16:15		3	2	5	1.5
16:15-16:30		0	3	3	0.9
16:30-16:45		2	3	5	1.5
16:45-17:00		3	4	7	2.1
1時間計		8	12	20	6.0
17:00-17:15		1	3	4	1.2
17:15-17:30		2	2	4	1.2
17:30-17:45		1	8	9	2.7
17:45-18:00		0	4	4	1.2
1時間計		4	17	21	6.3
18:00-18:15		2	6	8	2.4
18:15-18:30		1	3	4	1.2
18:30-18:45		3	4	7	2.1
18:45-19:00		2	2	4	1.2
1時間計		8	15	23	6.9
19:00-19:15		0	0	0	0.0
19:15-19:30		2	3	5	1.5
19:30-19:45		2	3	5	1.5
19:45-20:00		1	1	2	0.6
1時間計		5	7	12	3.6
20:00-20:15		2	3	5	1.5
20:15-20:30		0	0	0	0.0
20:30-20:45		1	2	3	0.9
20:45-21:00		0	0	0	0.0
1時間計		3	5	8	2.4
21:00-21:15		0	1	1	0.3
21:15-21:30		0	1	1	0.3
21:30-21:45		0	1	1	0.3
21:45-22:00		1	0	1	0.3
1時間計		1	3	4	1.2
昼12時間計		94	175	269	80.3
夜12時間計		36	30	66	19.7
全時間合計		130	205	335	100.0
昼夜率		1.38	1.17	1.25	-

時間帯	種別	合計 (7+I+U+E)			時間係数 (%)
		歩行者 (人)	自転車 (台)	合計 (人・台)	
13:00-14:00		5	17	22	6.6
13:15-14:15		8	13	21	6.3
13:30-14:30		8	15	23	6.9
13:45-14:45		8	11	19	5.7
14:00-15:00		7	11	18	5.4
14:15-15:15		4	9	13	3.9
14:30-15:30		6	11	17	5.1
14:45-15:45		9	17	26	7.8
15:00-16:00		10	16	26	7.8
15:15-16:15		13	17	30	9.0
15:30-16:30		10	16	26	7.8
15:45-16:45		8	8	16	4.8
16:00-17:00		8	12	20	6.0
16:15-17:15		6	13	19	5.7
16:30-17:30		8	12	20	6.0
16:45-17:45		7	17	24	7.2
17:00-18:00		4	17	21	6.3
17:15-18:15		5	20	25	7.5
17:30-18:30		4	21	25	7.5
17:45-18:45		6	17	23	6.9
18:00-19:00		8	15	23	6.9
18:15-19:15		6	9	15	4.5
18:30-19:30		7	9	16	4.8
18:45-19:45		6	8	14	4.2
19:00-20:00		5	7	12	3.6
19:15-20:15		7	10	17	5.1
19:30-20:30		5	7	12	3.6
19:45-20:45		4	6	10	3.0
20:00-21:00		3	5	8	2.4
20:15-21:15		1	3	4	1.2
20:30-21:30		1	4	5	1.5
20:45-21:45		0	3	3	0.9
21:00-22:00		1	3	4	1.2
全時間合計		130	205	335	100.0

歩行者通行量調査表

調査地点：地域社会4 瀬谷土橋公園入口

調査年月日：令和2年9月26日(土) 天候：晴れ一時雨



時間帯	ア				イ				合計			
	歩行者 (人)	自転車 (台)	合計 (人・台)	時間 係数 (%)	歩行者 (人)	自転車 (台)	合計 (人・台)	時間 係数 (%)	歩行者 (人)	自転車 (台)	合計 (人・台)	時間 係数 (%)
22:00-22:15	0	0	0	0.0	0	0	0	0.0	0	0	0	0.0
22:15-22:30	0	0	0	0.0	0	0	0	0.0	0	0	0	0.0
22:30-22:45	0	0	0	0.0	0	0	0	0.0	0	0	0	0.0
22:45-23:00	0	0	0	0.0	0	0	0	0.0	0	0	0	0.0
1時間計	0	0	0	0.0	0	0	0	0.0	0	0	0	0.0
23:00-23:15	0	0	0	0.0	1	0	1	5.3	1	0	1	2.5
23:15-23:30	1	0	1	4.8	0	0	0	0.0	1	0	1	2.5
23:30-23:45	1	0	1	4.8	2	0	2	10.5	3	0	3	7.5
23:45-24:00	0	0	0	0.0	0	0	0	0.0	0	0	0	0.0
1時間計	2	0	2	9.5	3	0	3	15.8	5	0	5	12.5
0:00-0:15	0	0	0	0.0	0	0	0	0.0	0	0	0	0.0
0:15-0:30	0	0	0	0.0	0	0	0	0.0	0	0	0	0.0
0:30-0:45	0	0	0	0.0	0	0	0	0.0	0	0	0	0.0
0:45-1:00	1	0	1	4.8	0	0	0	0.0	1	0	1	2.5
1時間計	1	0	1	4.8	0	0	0	0.0	1	0	1	2.5
1:00-1:15	0	0	0	0.0	0	0	0	0.0	0	0	0	0.0
1:15-1:30	0	0	0	0.0	0	0	0	0.0	0	0	0	0.0
1:30-1:45	0	0	0	0.0	0	0	0	0.0	0	0	0	0.0
1:45-2:00	0	0	0	0.0	0	0	0	0.0	0	0	0	0.0
1時間計	0	0	0	0.0	0	0	0	0.0	0	0	0	0.0
2:00-2:15	0	0	0	0.0	0	0	0	0.0	0	0	0	0.0
2:15-2:30	0	0	0	0.0	0	0	0	0.0	0	0	0	0.0
2:30-2:45	0	0	0	0.0	0	0	0	0.0	0	0	0	0.0
2:45-3:00	0	0	0	0.0	0	0	0	0.0	0	0	0	0.0
1時間計	0	0	0	0.0	0	0	0	0.0	0	0	0	0.0
3:00-3:15	0	0	0	0.0	0	0	0	0.0	0	0	0	0.0
3:15-3:30	1	0	1	4.8	0	0	0	0.0	1	0	1	2.5
3:30-3:45	0	0	0	0.0	0	0	0	0.0	0	0	0	0.0
3:45-4:00	0	0	0	0.0	0	0	0	0.0	0	0	0	0.0
1時間計	1	0	1	4.8	0	0	0	0.0	1	0	1	2.5
4:00-4:15	0	0	0	0.0	0	0	0	0.0	0	0	0	0.0
4:15-4:30	0	0	0	0.0	0	0	0	0.0	0	0	0	0.0
4:30-4:45	0	0	0	0.0	0	0	0	0.0	0	0	0	0.0
4:45-5:00	0	0	0	0.0	0	0	0	0.0	0	0	0	0.0
1時間計	0	0	0	0.0	0	0	0	0.0	0	0	0	0.0
5:00-5:15	0	0	0	0.0	1	0	1	5.3	1	0	1	2.5
5:15-5:30	0	0	0	0.0	0	0	0	0.0	0	0	0	0.0
5:30-5:45	0	0	0	0.0	0	0	0	0.0	0	0	0	0.0
5:45-6:00	1	0	1	4.8	1	0	1	5.3	2	0	2	5.0
1時間計	1	0	1	4.8	2	0	2	10.5	3	0	3	7.5

歩行者通行量調査表

調査地点：地域社会4 瀬谷土橋公園入口

調査年月日：令和 2年 9月26日(土) 天候：晴れ一時雨



時間帯	ア				イ				合計			
	歩行者 (人)	自転車 (台)	合計 (人・台)	時間 係数 (%)	歩行者 (人)	自転車 (台)	合計 (人・台)	時間 係数 (%)	歩行者 (人)	自転車 (台)	合計 (人・台)	時間 係数 (%)
6:00-6:15	0	0	0	0.0	0	0	0	0.0	0	0	0	0.0
6:15-6:30	0	0	0	0.0	0	0	0	0.0	0	0	0	0.0
6:30-6:45	0	1	1	4.8	0	0	0	0.0	0	1	1	2.5
6:45-7:00	0	0	0	0.0	0	0	0	0.0	0	0	0	0.0
1時間計	0	1	1	4.8	0	0	0	0.0	0	1	1	2.5
7:00-7:15	0	0	0	0.0	0	0	0	0.0	0	0	0	0.0
7:15-7:30	0	0	0	0.0	0	0	0	0.0	0	0	0	0.0
7:30-7:45	0	0	0	0.0	0	0	0	0.0	0	0	0	0.0
7:45-8:00	0	0	0	0.0	1	0	1	5.3	1	0	1	2.5
1時間計	0	0	0	0.0	1	0	1	5.3	1	0	1	2.5
8:00-8:15	2	0	2	9.5	0	0	0	0.0	2	0	2	5.0
8:15-8:30	0	0	0	0.0	0	0	0	0.0	0	0	0	0.0
8:30-8:45	0	0	0	0.0	0	0	0	0.0	0	0	0	0.0
8:45-9:00	0	0	0	0.0	0	0	0	0.0	0	0	0	0.0
1時間計	2	0	2	9.5	0	0	0	0.0	2	0	2	5.0
9:00-9:15	1	0	1	4.8	0	0	0	0.0	1	0	1	2.5
9:15-9:30	0	0	0	0.0	0	0	0	0.0	0	0	0	0.0
9:30-9:45	0	0	0	0.0	0	0	0	0.0	0	0	0	0.0
9:45-10:00	0	0	0	0.0	0	0	0	0.0	0	0	0	0.0
1時間計	1	0	1	4.8	0	0	0	0.0	1	0	1	2.5
10:00-10:15	0	0	0	0.0	0	0	0	0.0	0	0	0	0.0
10:15-10:30	0	1	1	4.8	1	1	2	10.5	1	2	3	7.5
10:30-10:45	0	0	0	0.0	0	0	0	0.0	0	0	0	0.0
10:45-11:00	0	0	0	0.0	0	0	0	0.0	0	0	0	0.0
1時間計	0	1	1	4.8	1	1	2	10.5	1	2	3	7.5
11:00-11:15	0	0	0	0.0	1	0	1	5.3	1	0	1	2.5
11:15-11:30	0	0	0	0.0	0	0	0	0.0	0	0	0	0.0
11:30-11:45	0	0	0	0.0	0	0	0	0.0	0	0	0	0.0
11:45-12:00	2	0	2	9.5	2	0	2	10.5	4	0	4	10.0
1時間計	2	0	2	9.5	3	0	3	15.8	5	0	5	12.5
12:00-12:15	0	0	0	0.0	0	1	1	5.3	0	1	1	2.5
12:15-12:30	0	0	0	0.0	1	0	1	5.3	1	0	1	2.5
12:30-12:45	2	0	2	9.5	2	0	2	10.5	4	0	4	10.0
12:45-13:00	2	0	2	9.5	1	0	1	5.3	3	0	3	7.5
1時間計	4	0	4	19.0	4	1	5	26.3	8	1	9	22.5
13:00-13:15	0	1	1	4.8	0	0	0	0.0	0	1	1	2.5
13:15-13:30	0	0	0	0.0	0	0	0	0.0	0	0	0	0.0
13:30-13:45	0	0	0	0.0	0	0	0	0.0	0	0	0	0.0
13:45-14:00	0	0	0	0.0	0	0	0	0.0	0	0	0	0.0
1時間計	0	1	1	4.8	0	0	0	0.0	0	1	1	2.5

歩行者通行量調査表

調査地点：地域社会4 瀬谷土橋公園入口

調査年月日：令和 2年 9月26日(土) 天候：晴れ一時雨



時間帯	ア				イ				合計			
	歩行者 (人)	自転車 (台)	合計 (人・台)	時間 係数 (%)	歩行者 (人)	自転車 (台)	合計 (人・台)	時間 係数 (%)	歩行者 (人)	自転車 (台)	合計 (人・台)	時間 係数 (%)
14:00-14:15	0	0	0	0.0	0	0	0	0.0	0	0	0	0.0
14:15-14:30	0	0	0	0.0	0	0	0	0.0	0	0	0	0.0
14:30-14:45	0	0	0	0.0	0	0	0	0.0	0	0	0	0.0
14:45-15:00	1	0	1	4.8	0	0	0	0.0	1	0	1	2.5
1時間計	1	0	1	4.8	0	0	0	0.0	1	0	1	2.5
15:00-15:15	0	0	0	0.0	0	0	0	0.0	0	0	0	0.0
15:15-15:30	0	1	1	4.8	0	0	0	0.0	0	1	1	2.5
15:30-15:45	0	1	1	4.8	0	3	3	15.8	0	4	4	10.0
15:45-16:00	0	0	0	0.0	0	0	0	0.0	0	0	0	0.0
1時間計	0	2	2	9.5	0	3	3	15.8	0	5	5	12.5
16:00-16:15	0	0	0	0.0	0	0	0	0.0	0	0	0	0.0
16:15-16:30	0	0	0	0.0	0	0	0	0.0	0	0	0	0.0
16:30-16:45	0	0	0	0.0	0	0	0	0.0	0	0	0	0.0
16:45-17:00	0	0	0	0.0	0	0	0	0.0	0	0	0	0.0
1時間計	0	0	0	0.0	0	0	0	0.0	0	0	0	0.0
17:00-17:15	0	0	0	0.0	0	0	0	0.0	0	0	0	0.0
17:15-17:30	0	0	0	0.0	0	0	0	0.0	0	0	0	0.0
17:30-17:45	0	0	0	0.0	0	0	0	0.0	0	0	0	0.0
17:45-18:00	0	0	0	0.0	0	0	0	0.0	0	0	0	0.0
1時間計	0	0	0	0.0	0	0	0	0.0	0	0	0	0.0
18:00-18:15	0	0	0	0.0	0	0	0	0.0	0	0	0	0.0
18:15-18:30	1	0	1	4.8	0	0	0	0.0	1	0	1	2.5
18:30-18:45	0	0	0	0.0	0	0	0	0.0	0	0	0	0.0
18:45-19:00	0	0	0	0.0	0	0	0	0.0	0	0	0	0.0
1時間計	1	0	1	4.8	0	0	0	0.0	1	0	1	2.5
19:00-19:15	0	0	0	0.0	0	0	0	0.0	0	0	0	0.0
19:15-19:30	0	0	0	0.0	0	0	0	0.0	0	0	0	0.0
19:30-19:45	0	0	0	0.0	0	0	0	0.0	0	0	0	0.0
19:45-20:00	0	0	0	0.0	0	0	0	0.0	0	0	0	0.0
1時間計	0	0	0	0.0	0	0	0	0.0	0	0	0	0.0
20:00-20:15	0	0	0	0.0	0	0	0	0.0	0	0	0	0.0
20:15-20:30	0	0	0	0.0	0	0	0	0.0	0	0	0	0.0
20:30-20:45	0	0	0	0.0	0	0	0	0.0	0	0	0	0.0
20:45-21:00	0	0	0	0.0	0	0	0	0.0	0	0	0	0.0
1時間計	0	0	0	0.0	0	0	0	0.0	0	0	0	0.0
21:00-21:15	0	0	0	0.0	0	0	0	0.0	0	0	0	0.0
21:15-21:30	0	0	0	0.0	0	0	0	0.0	0	0	0	0.0
21:30-21:45	0	0	0	0.0	0	0	0	0.0	0	0	0	0.0
21:45-22:00	0	0	0	0.0	0	0	0	0.0	0	0	0	0.0
1時間計	0	0	0	0.0	0	0	0	0.0	0	0	0	0.0
昼12時間計	11	4	15	71.4	9	5	14	73.7	20	9	29	72.5
夜12時間計	5	1	6	28.6	5	0	5	26.3	10	1	11	27.5
全時間合計	16	5	21	100.0	14	5	19	100.0	30	10	40	100.0
昼夜率	1.45	1.25	1.40	-	1.56	1.00	1.36	-	1.50	1.11	1.38	-

歩行者通行量調査表

調査地点：地域社会4 瀬谷土橋公園入口

調査年月日：令和 2年 9月26日(土) 天候：晴れ一時雨



方向	ウ				エ				合計				
	種別	歩行者 (人)	自転車 (台)	合計 (人・台)	時間 係数 (%)	歩行者 (人)	自転車 (台)	合計 (人・台)	時間 係数 (%)	歩行者 (人)	自転車 (台)	合計 (人・台)	時間 係数 (%)
22:00-22:15		1	0	1	0.5	0	2	2	3.2	1	2	3	1.2
22:15-22:30		0	0	0	0.0	0	0	0	0.0	0	0	0	0.0
22:30-22:45		1	3	4	2.1	0	0	0	0.0	1	3	4	1.6
22:45-23:00		0	0	0	0.0	0	0	0	0.0	0	0	0	0.0
1時間計		2	3	5	2.6	0	2	2	3.2	2	5	7	2.8
23:00-23:15		0	0	0	0.0	0	0	0	0.0	0	0	0	0.0
23:15-23:30		0	0	0	0.0	0	0	0	0.0	0	0	0	0.0
23:30-23:45		0	0	0	0.0	0	0	0	0.0	0	0	0	0.0
23:45-24:00		0	1	1	0.5	0	0	0	0.0	0	1	1	0.4
1時間計		0	1	1	0.5	0	0	0	0.0	0	1	1	0.4
0:00-0:15		0	0	0	0.0	0	0	0	0.0	0	0	0	0.0
0:15-0:30		0	0	0	0.0	0	0	0	0.0	0	0	0	0.0
0:30-0:45		0	0	0	0.0	0	0	0	0.0	0	0	0	0.0
0:45-1:00		0	0	0	0.0	0	0	0	0.0	0	0	0	0.0
1時間計		0	0	0	0.0	0	0	0	0.0	0	0	0	0.0
1:00-1:15		0	0	0	0.0	0	0	0	0.0	0	0	0	0.0
1:15-1:30		0	0	0	0.0	0	0	0	0.0	0	0	0	0.0
1:30-1:45		0	0	0	0.0	0	0	0	0.0	0	0	0	0.0
1:45-2:00		0	0	0	0.0	0	0	0	0.0	0	0	0	0.0
1時間計		0	0	0	0.0	0	0	0	0.0	0	0	0	0.0
2:00-2:15		0	0	0	0.0	1	0	1	1.6	1	0	1	0.4
2:15-2:30		1	0	1	0.5	0	0	0	0.0	1	0	1	0.4
2:30-2:45		0	0	0	0.0	0	0	0	0.0	0	0	0	0.0
2:45-3:00		0	0	0	0.0	0	0	0	0.0	0	0	0	0.0
1時間計		1	0	1	0.5	1	0	1	1.6	2	0	2	0.8
3:00-3:15		0	0	0	0.0	0	0	0	0.0	0	0	0	0.0
3:15-3:30		0	0	0	0.0	1	0	1	1.6	1	0	1	0.4
3:30-3:45		0	0	0	0.0	0	0	0	0.0	0	0	0	0.0
3:45-4:00		0	0	0	0.0	0	0	0	0.0	0	0	0	0.0
1時間計		0	0	0	0.0	1	0	1	1.6	1	0	1	0.4
4:00-4:15		0	0	0	0.0	0	0	0	0.0	0	0	0	0.0
4:15-4:30		0	0	0	0.0	1	0	1	1.6	1	0	1	0.4
4:30-4:45		0	0	0	0.0	0	0	0	0.0	0	0	0	0.0
4:45-5:00		0	0	0	0.0	0	0	0	0.0	0	0	0	0.0
1時間計		0	0	0	0.0	1	0	1	1.6	1	0	1	0.4
5:00-5:15		0	1	1	0.5	0	0	0	0.0	0	1	1	0.4
5:15-5:30		0	0	0	0.0	0	0	0	0.0	0	0	0	0.0
5:30-5:45		0	1	1	0.5	0	0	0	0.0	0	1	1	0.4
5:45-6:00		1	0	1	0.5	0	0	0	0.0	1	0	1	0.4
1時間計		1	2	3	1.6	0	0	0	0.0	1	2	3	1.2

歩行者通行量調査表

調査地点：地域社会4 瀬谷土橋公園入口

調査年月日：令和 2年 9月26日(土) 天候：晴れ一時雨



時間帯	種別	ウ				エ				合計			
		歩行者 (人)	自転車 (台)	合計 (人・台)	時間 係数 (%)	歩行者 (人)	自転車 (台)	合計 (人・台)	時間 係数 (%)	歩行者 (人)	自転車 (台)	合計 (人・台)	時間 係数 (%)
6:00-6:15		2	0	2	1.1	0	0	0	0.0	2	0	2	0.8
6:15-6:30		0	0	0	0.0	0	0	0	0.0	0	0	0	0.0
6:30-6:45		3	1	4	2.1	2	1	3	4.8	5	2	7	2.8
6:45-7:00		2	2	4	2.1	1	0	1	1.6	3	2	5	2.0
1時間計		7	3	10	5.3	3	1	4	6.3	10	4	14	5.5
7:00-7:15		1	0	1	0.5	0	0	0	0.0	1	0	1	0.4
7:15-7:30		0	1	1	0.5	0	0	0	0.0	0	1	1	0.4
7:30-7:45		1	5	6	3.2	0	0	0	0.0	1	5	6	2.4
7:45-8:00		0	2	2	1.1	1	0	1	1.6	1	2	3	1.2
1時間計		2	8	10	5.3	1	0	1	1.6	3	8	11	4.3
8:00-8:15		0	2	2	1.1	2	0	2	3.2	2	2	4	1.6
8:15-8:30		0	5	5	2.6	0	0	0	0.0	0	5	5	2.0
8:30-8:45		0	8	8	4.2	1	1	2	3.2	1	9	10	4.0
8:45-9:00		1	2	3	1.6	1	0	1	1.6	2	2	4	1.6
1時間計		1	17	18	9.5	4	1	5	7.9	5	18	23	9.1
9:00-9:15		1	2	3	1.6	1	1	2	3.2	2	3	5	2.0
9:15-9:30		0	2	2	1.1	0	0	0	0.0	0	2	2	0.8
9:30-9:45		2	7	9	4.7	1	1	2	3.2	3	8	11	4.3
9:45-10:00		1	3	4	2.1	0	0	0	0.0	1	3	4	1.6
1時間計		4	14	18	9.5	2	2	4	6.3	6	16	22	8.7
10:00-10:15		0	2	2	1.1	2	0	2	3.2	2	2	4	1.6
10:15-10:30		2	4	6	3.2	1	0	1	1.6	3	4	7	2.8
10:30-10:45		3	5	8	4.2	0	3	3	4.8	3	8	11	4.3
10:45-11:00		2	2	4	2.1	2	1	3	4.8	4	3	7	2.8
1時間計		7	13	20	10.5	5	4	9	14.3	12	17	29	11.5
11:00-11:15		1	4	5	2.6	0	0	0	0.0	1	4	5	2.0
11:15-11:30		0	0	0	0.0	0	0	0	0.0	0	0	0	0.0
11:30-11:45		1	1	2	1.1	0	0	0	0.0	1	1	2	0.8
11:45-12:00		0	1	1	0.5	0	0	0	0.0	0	1	1	0.4
1時間計		2	6	8	4.2	0	0	0	0.0	2	6	8	3.2
12:00-12:15		1	3	4	2.1	0	0	0	0.0	1	3	4	1.6
12:15-12:30		0	1	1	0.5	0	0	0	0.0	0	1	1	0.4
12:30-12:45		0	2	2	1.1	0	1	1	1.6	0	3	3	1.2
12:45-13:00		0	3	3	1.6	0	0	0	0.0	0	3	3	1.2
1時間計		1	9	10	5.3	0	1	1	1.6	1	10	11	4.3
13:00-13:15		0	5	5	2.6	1	1	2	3.2	1	6	7	2.8
13:15-13:30		1	2	3	1.6	1	1	2	3.2	2	3	5	2.0
13:30-13:45		0	4	4	2.1	1	1	2	3.2	1	5	6	2.4
13:45-14:00		1	1	2	1.1	0	0	0	0.0	1	1	2	0.8
1時間計		2	12	14	7.4	3	3	6	9.5	5	15	20	7.9

歩行者通行量調査表

調査地点：地域社会4 瀬谷土橋公園入口

調査年月日：令和 2年 9月26日(土) 天候：晴れ一時雨



時間帯	ウ				I				合計			
	歩行者 (人)	自転車 (台)	合計 (人・台)	時間 係数 (%)	歩行者 (人)	自転車 (台)	合計 (人・台)	時間 係数 (%)	歩行者 (人)	自転車 (台)	合計 (人・台)	時間 係数 (%)
14:00-14:15	1	3	4	2.1	1	0	1	1.6	2	3	5	2.0
14:15-14:30	2	5	7	3.7	2	0	2	3.2	4	5	9	3.6
14:30-14:45	2	3	5	2.6	0	0	0	0.0	2	3	5	2.0
14:45-15:00	1	2	3	1.6	0	0	0	0.0	1	2	3	1.2
1時間計	6	13	19	10.0	3	0	3	4.8	9	13	22	8.7
15:00-15:15	0	0	0	0.0	0	0	0	0.0	0	0	0	0.0
15:15-15:30	0	1	1	0.5	0	0	0	0.0	0	1	1	0.4
15:30-15:45	2	3	5	2.6	0	6	6	9.5	2	9	11	4.3
15:45-16:00	2	1	3	1.6	0	0	0	0.0	2	1	3	1.2
1時間計	4	5	9	4.7	0	6	6	9.5	4	11	15	5.9
16:00-16:15	0	0	0	0.0	0	1	1	1.6	0	1	1	0.4
16:15-16:30	0	3	3	1.6	0	0	0	0.0	0	3	3	1.2
16:30-16:45	1	2	3	1.6	0	0	0	0.0	1	2	3	1.2
16:45-17:00	1	2	3	1.6	0	0	0	0.0	1	2	3	1.2
1時間計	2	7	9	4.7	0	1	1	1.6	2	8	10	4.0
17:00-17:15	1	7	8	4.2	1	0	1	1.6	2	7	9	3.6
17:15-17:30	1	3	4	2.1	1	1	2	3.2	2	4	6	2.4
17:30-17:45	1	6	7	3.7	0	0	0	0.0	1	6	7	2.8
17:45-18:00	0	2	2	1.1	0	1	1	1.6	0	3	3	1.2
1時間計	3	18	21	11.1	2	2	4	6.3	5	20	25	9.9
18:00-18:15	0	1	1	0.5	0	0	0	0.0	0	1	1	0.4
18:15-18:30	0	1	1	0.5	0	2	2	3.2	0	3	3	1.2
18:30-18:45	0	0	0	0.0	0	0	0	0.0	0	0	0	0.0
18:45-19:00	1	1	2	1.1	0	0	0	0.0	1	1	2	0.8
1時間計	1	3	4	2.1	0	2	2	3.2	1	5	6	2.4
19:00-19:15	0	0	0	0.0	0	0	0	0.0	0	0	0	0.0
19:15-19:30	0	1	1	0.5	1	4	5	7.9	1	5	6	2.4
19:30-19:45	2	0	2	1.1	0	1	1	1.6	2	1	3	1.2
19:45-20:00	0	0	0	0.0	1	0	1	1.6	1	0	1	0.4
1時間計	2	1	3	1.6	2	5	7	11.1	4	6	10	4.0
20:00-20:15	1	2	3	1.6	0	0	0	0.0	1	2	3	1.2
20:15-20:30	0	1	1	0.5	1	1	2	3.2	1	2	3	1.2
20:30-20:45	0	0	0	0.0	1	0	1	1.6	1	0	1	0.4
20:45-21:00	0	0	0	0.0	0	0	0	0.0	0	0	0	0.0
1時間計	1	3	4	2.1	2	1	3	4.8	3	4	7	2.8
21:00-21:15	0	0	0	0.0	0	0	0	0.0	0	0	0	0.0
21:15-21:30	0	2	2	1.1	0	0	0	0.0	0	2	2	0.8
21:30-21:45	0	1	1	0.5	0	0	0	0.0	0	1	1	0.4
21:45-22:00	0	0	0	0.0	2	0	2	3.2	2	0	2	0.8
1時間計	0	3	3	1.6	2	0	2	3.2	2	3	5	2.0
昼12時間計	35	125	160	84.2	20	22	42	66.7	55	147	202	79.8
夜12時間計	14	16	30	15.8	12	9	21	33.3	26	25	51	20.2
全時間合計	49	141	190	100.0	32	31	63	100.0	81	172	253	100.0
昼夜率	1.40	1.13	1.19	-	1.60	1.41	1.50	-	1.47	1.17	1.25	-

歩行者通行量調査表

調査地点：地域社会4 瀬谷土橋公園入口

調査年月日：令和 2年 9月26日(土) 天候：晴れ一時雨



時間帯	種別	合計 (7+I+U+E)			時間係数 (%)
		歩行者 (人)	自転車 (台)	合計 (人・台)	
22:00-22:15		1	2	3	1.1
22:15-22:30		0	0	0	0.0
22:30-22:45		1	3	4	1.5
22:45-23:00		0	0	0	0.0
1時間計		2	5	7	2.6
23:00-23:15		0	0	0	0.0
23:15-23:30		0	0	0	0.0
23:30-23:45		0	0	0	0.0
23:45-24:00		0	1	1	0.4
1時間計		0	1	1	0.4
0:00-0:15		0	0	0	0.0
0:15-0:30		0	0	0	0.0
0:30-0:45		0	0	0	0.0
0:45-1:00		0	0	0	0.0
1時間計		0	0	0	0.0
1:00-1:15		0	0	0	0.0
1:15-1:30		0	0	0	0.0
1:30-1:45		0	0	0	0.0
1:45-2:00		0	0	0	0.0
1時間計		0	0	0	0.0
2:00-2:15		1	0	1	0.4
2:15-2:30		1	0	1	0.4
2:30-2:45		0	0	0	0.0
2:45-3:00		0	0	0	0.0
1時間計		2	0	2	0.7
3:00-3:15		0	0	0	0.0
3:15-3:30		1	0	1	0.4
3:30-3:45		0	0	0	0.0
3:45-4:00		0	0	0	0.0
1時間計		1	0	1	0.4
4:00-4:15		0	0	0	0.0
4:15-4:30		1	0	1	0.4
4:30-4:45		0	0	0	0.0
4:45-5:00		0	0	0	0.0
1時間計		1	0	1	0.4
5:00-5:15		0	1	1	0.4
5:15-5:30		0	0	0	0.0
5:30-5:45		0	1	1	0.4
5:45-6:00		1	0	1	0.4
1時間計		1	2	3	1.1
6:00-6:15		2	0	2	0.7
6:15-6:30		0	0	0	0.0
6:30-6:45		6	3	9	3.3
6:45-7:00		3	2	5	1.8
1時間計		11	5	16	5.9
7:00-7:15		1	0	1	0.4
7:15-7:30		0	1	1	0.4
7:30-7:45		1	5	6	2.2
7:45-8:00		1	2	3	1.1
1時間計		3	8	11	4.0
8:00-8:15		2	2	4	1.5
8:15-8:30		0	5	5	1.8
8:30-8:45		1	9	10	3.7
8:45-9:00		2	2	4	1.5
1時間計		5	18	23	8.4
9:00-9:15		2	3	5	1.8
9:15-9:30		0	2	2	0.7
9:30-9:45		3	8	11	4.0
9:45-10:00		1	3	4	1.5
1時間計		6	16	22	8.1

時間帯	種別	合計 (7+I+U+E)			時間係数 (%)
		歩行者 (人)	自転車 (台)	合計 (人・台)	
22:00-23:00		2	5	7	2.6
22:15-23:15		1	3	4	1.5
22:30-23:30		1	3	4	1.5
22:45-23:45		0	0	0	0.0
23:00-0:00		0	1	1	0.4
23:15-0:15		0	1	1	0.4
23:30-0:30		0	1	1	0.4
23:45-0:45		0	1	1	0.4
0:00-1:00		0	0	0	0.0
0:15-1:15		0	0	0	0.0
0:30-1:30		0	0	0	0.0
0:45-1:45		0	0	0	0.0
1:00-2:00		0	0	0	0.0
1:15-2:15		1	0	1	0.4
1:30-2:30		2	0	2	0.7
1:45-2:45		2	0	2	0.7
2:00-3:00		2	0	2	0.7
2:15-3:15		1	0	1	0.4
2:30-3:30		1	0	1	0.4
2:45-3:45		1	0	1	0.4
3:00-4:00		1	0	1	0.4
3:15-4:15		1	0	1	0.4
3:30-4:30		1	0	1	0.4
3:45-4:45		1	0	1	0.4
4:00-5:00		1	0	1	0.4
4:15-5:15		1	1	2	0.7
4:30-5:30		0	1	1	0.4
4:45-5:45		0	2	2	0.7
5:00-6:00		1	2	3	1.1
5:15-6:15		3	1	4	1.5
5:30-6:30		3	1	4	1.5
5:45-6:45		9	3	12	4.4
6:00-7:00		11	5	16	5.9
6:15-7:15		10	5	15	5.5
6:30-7:30		10	6	16	5.9
6:45-7:45		5	8	13	4.8
7:00-8:00		3	8	11	4.0
7:15-8:15		4	10	14	5.1
7:30-8:30		4	14	18	6.6
7:45-8:45		4	18	22	8.1
8:00-9:00		5	18	23	8.4
8:15-9:15		5	19	24	8.8
8:30-9:30		5	16	21	7.7
8:45-9:45		7	15	22	8.1
9:00-10:00		6	16	22	8.1
9:15-10:15		6	15	21	7.7
9:30-10:30		11	19	30	11.0
9:45-10:45		11	19	30	11.0
10:00-11:00		14	19	33	12.1
10:15-11:15		13	21	34	12.5
10:30-11:30		8	15	23	8.4
10:45-11:45		6	8	14	5.1
11:00-12:00		2	6	8	2.9
11:15-12:15		3	6	9	3.3
11:30-12:30		3	7	10	3.7
11:45-12:45		2	9	11	4.0
12:00-13:00		2	11	13	4.8
12:15-13:15		2	14	16	5.9
12:30-13:30		4	16	20	7.3
12:45-13:45		5	18	23	8.4

歩行者通行量調査表

調査地点：地域社会4 瀬谷土橋公園入口

調査年月日：令和 2年 9月26日(土) 天候：晴れ一時雨



時間帯	種別	合計 (7+I+U+E)			時間係数 (%)
		歩行者 (人)	自転車 (台)	合計 (人・台)	
10:00-10:15		2	2	4	1.5
10:15-10:30		5	6	11	4.0
10:30-10:45		3	8	11	4.0
10:45-11:00		4	3	7	2.6
1時間計		14	19	33	12.1
11:00-11:15		1	4	5	1.8
11:15-11:30		0	0	0	0.0
11:30-11:45		1	1	2	0.7
11:45-12:00		0	1	1	0.4
1時間計		2	6	8	2.9
12:00-12:15		2	4	6	2.2
12:15-12:30		0	1	1	0.4
12:30-12:45		0	3	3	1.1
12:45-13:00		0	3	3	1.1
1時間計		2	11	13	4.8
13:00-13:15		2	7	9	3.3
13:15-13:30		2	3	5	1.8
13:30-13:45		1	5	6	2.2
13:45-14:00		1	1	2	0.7
1時間計		6	16	22	8.1
14:00-14:15		2	3	5	1.8
14:15-14:30		4	5	9	3.3
14:30-14:45		2	3	5	1.8
14:45-15:00		1	2	3	1.1
1時間計		9	13	22	8.1
15:00-15:15		0	0	0	0.0
15:15-15:30		1	2	3	1.1
15:30-15:45		6	13	19	7.0
15:45-16:00		2	1	3	1.1
1時間計		9	16	25	9.2
16:00-16:15		0	1	1	0.4
16:15-16:30		0	3	3	1.1
16:30-16:45		1	2	3	1.1
16:45-17:00		1	2	3	1.1
1時間計		2	8	10	3.7
17:00-17:15		2	7	9	3.3
17:15-17:30		2	4	6	2.2
17:30-17:45		1	6	7	2.6
17:45-18:00		0	3	3	1.1
1時間計		5	20	25	9.2
18:00-18:15		0	1	1	0.4
18:15-18:30		0	3	3	1.1
18:30-18:45		0	0	0	0.0
18:45-19:00		1	1	2	0.7
1時間計		1	5	6	2.2
19:00-19:15		0	0	0	0.0
19:15-19:30		1	5	6	2.2
19:30-19:45		2	1	3	1.1
19:45-20:00		1	0	1	0.4
1時間計		4	6	10	3.7
20:00-20:15		1	2	3	1.1
20:15-20:30		1	2	3	1.1
20:30-20:45		1	0	1	0.4
20:45-21:00		0	0	0	0.0
1時間計		3	4	7	2.6
21:00-21:15		0	0	0	0.0
21:15-21:30		0	2	2	0.7
21:30-21:45		0	1	1	0.4
21:45-22:00		2	0	2	0.7
1時間計		2	3	5	1.8
昼12時間計		64	156	220	80.6
夜12時間計		27	26	53	19.4
全時間合計		91	182	273	100.0
昼夜率		1.42	1.17	1.24	-

時間帯	種別	合計 (7+I+U+E)			時間係数 (%)
		歩行者 (人)	自転車 (台)	合計 (人・台)	
13:00-14:00		6	16	22	8.1
13:15-14:15		6	12	18	6.6
13:30-14:30		8	14	22	8.1
13:45-14:45		9	12	21	7.7
14:00-15:00		9	13	22	8.1
14:15-15:15		7	10	17	6.2
14:30-15:30		4	7	11	4.0
14:45-15:45		8	17	25	9.2
15:00-16:00		9	16	25	9.2
15:15-16:15		9	17	26	9.5
15:30-16:30		8	18	26	9.5
15:45-16:45		3	7	10	3.7
16:00-17:00		2	8	10	3.7
16:15-17:15		4	14	18	6.6
16:30-17:30		6	15	21	7.7
16:45-17:45		6	19	25	9.2
17:00-18:00		5	20	25	9.2
17:15-18:15		3	14	17	6.2
17:30-18:30		1	13	14	5.1
17:45-18:45		0	7	7	2.6
18:00-19:00		1	5	6	2.2
18:15-19:15		1	4	5	1.8
18:30-19:30		2	6	8	2.9
18:45-19:45		4	7	11	4.0
19:00-20:00		4	6	10	3.7
19:15-20:15		5	8	13	4.8
19:30-20:30		5	5	10	3.7
19:45-20:45		4	4	8	2.9
20:00-21:00		3	4	7	2.6
20:15-21:15		2	2	4	1.5
20:30-21:30		1	2	3	1.1
20:45-21:45		0	3	3	1.1
21:00-22:00		2	3	5	1.8
全時間合計		91	182	273	100.0

歩行者通行量調査表

調査地点：地域社会4 瀬谷土橋公園前

調査年月日：令和 2年 9月26日(土) 天候：晴れ一時雨



時間帯	ア				イ				合計			
	歩行者 (人)	自転車 (台)	合計 (人・台)	時間 係数 (%)	歩行者 (人)	自転車 (台)	合計 (人・台)	時間 係数 (%)	歩行者 (人)	自転車 (台)	合計 (人・台)	時間 係数 (%)
22:00-22:15	0	0	0	0.0	0	0	0	0.0	0	0	0	0.0
22:15-22:30	0	0	0	0.0	0	0	0	0.0	0	0	0	0.0
22:30-22:45	0	0	0	0.0	0	0	0	0.0	0	0	0	0.0
22:45-23:00	0	0	0	0.0	0	0	0	0.0	0	0	0	0.0
1時間計	0	0	0	0.0	0	0	0	0.0	0	0	0	0.0
23:00-23:15	0	0	0	0.0	0	0	0	0.0	0	0	0	0.0
23:15-23:30	0	0	0	0.0	0	0	0	0.0	0	0	0	0.0
23:30-23:45	0	0	0	0.0	0	0	0	0.0	0	0	0	0.0
23:45-24:00	0	0	0	0.0	0	0	0	0.0	0	0	0	0.0
1時間計	0	0	0	0.0	0	0	0	0.0	0	0	0	0.0
0:00-0:15	0	0	0	0.0	0	0	0	0.0	0	0	0	0.0
0:15-0:30	0	0	0	0.0	0	0	0	0.0	0	0	0	0.0
0:30-0:45	0	0	0	0.0	0	0	0	0.0	0	0	0	0.0
0:45-1:00	0	0	0	0.0	0	0	0	0.0	0	0	0	0.0
1時間計	0	0	0	0.0	0	0	0	0.0	0	0	0	0.0
1:00-1:15	0	0	0	0.0	0	0	0	0.0	0	0	0	0.0
1:15-1:30	0	0	0	0.0	0	0	0	0.0	0	0	0	0.0
1:30-1:45	0	0	0	0.0	0	0	0	0.0	0	0	0	0.0
1:45-2:00	0	0	0	0.0	0	0	0	0.0	0	0	0	0.0
1時間計	0	0	0	0.0	0	0	0	0.0	0	0	0	0.0
2:00-2:15	0	0	0	0.0	0	0	0	0.0	0	0	0	0.0
2:15-2:30	0	0	0	0.0	0	0	0	0.0	0	0	0	0.0
2:30-2:45	0	0	0	0.0	0	0	0	0.0	0	0	0	0.0
2:45-3:00	0	0	0	0.0	0	0	0	0.0	0	0	0	0.0
1時間計	0	0	0	0.0	0	0	0	0.0	0	0	0	0.0
3:00-3:15	0	0	0	0.0	0	0	0	0.0	0	0	0	0.0
3:15-3:30	0	0	0	0.0	1	0	1	8.3	1	0	1	3.7
3:30-3:45	0	0	0	0.0	0	0	0	0.0	0	0	0	0.0
3:45-4:00	0	0	0	0.0	0	0	0	0.0	0	0	0	0.0
1時間計	0	0	0	0.0	1	0	1	8.3	1	0	1	3.7
4:00-4:15	0	0	0	0.0	0	0	0	0.0	0	0	0	0.0
4:15-4:30	0	0	0	0.0	0	0	0	0.0	0	0	0	0.0
4:30-4:45	0	0	0	0.0	0	0	0	0.0	0	0	0	0.0
4:45-5:00	0	0	0	0.0	0	0	0	0.0	0	0	0	0.0
1時間計	0	0	0	0.0	0	0	0	0.0	0	0	0	0.0
5:00-5:15	0	1	1	6.7	0	0	0	0.0	0	1	1	3.7
5:15-5:30	0	0	0	0.0	0	0	0	0.0	0	0	0	0.0
5:30-5:45	0	0	0	0.0	0	1	1	8.3	0	1	1	3.7
5:45-6:00	0	0	0	0.0	0	0	0	0.0	0	0	0	0.0
1時間計	0	1	1	6.7	0	1	1	8.3	0	2	2	7.4

歩行者通行量調査表

調査地点：地域社会4 瀬谷土橋公園前

調査年月日：令和 2年 9月26日(土) 天候：晴れ一時雨



時間帯	種別	ア				イ				合計			
		歩行者 (人)	自転車 (台)	合計 (人・台)	時間 係数 (%)	歩行者 (人)	自転車 (台)	合計 (人・台)	時間 係数 (%)	歩行者 (人)	自転車 (台)	合計 (人・台)	時間 係数 (%)
6:00-6:15		0	0	0	0.0	0	0	0	0.0	0	0	0	0.0
6:15-6:30		0	0	0	0.0	0	0	0	0.0	0	0	0	0.0
6:30-6:45		0	0	0	0.0	1	0	1	8.3	1	0	1	3.7
6:45-7:00		0	0	0	0.0	0	0	0	0.0	0	0	0	0.0
1時間計		0	0	0	0.0	1	0	1	8.3	1	0	1	3.7
7:00-7:15		0	0	0	0.0	0	0	0	0.0	0	0	0	0.0
7:15-7:30		0	0	0	0.0	0	0	0	0.0	0	0	0	0.0
7:30-7:45		0	0	0	0.0	1	0	1	8.3	1	0	1	3.7
7:45-8:00		1	0	1	6.7	0	0	0	0.0	1	0	1	3.7
1時間計		1	0	1	6.7	1	0	1	8.3	2	0	2	7.4
8:00-8:15		0	0	0	0.0	0	0	0	0.0	0	0	0	0.0
8:15-8:30		0	0	0	0.0	0	0	0	0.0	0	0	0	0.0
8:30-8:45		0	1	1	6.7	0	0	0	0.0	0	1	1	3.7
8:45-9:00		0	0	0	0.0	0	0	0	0.0	0	0	0	0.0
1時間計		0	1	1	6.7	0	0	0	0.0	0	1	1	3.7
9:00-9:15		0	0	0	0.0	0	0	0	0.0	0	0	0	0.0
9:15-9:30		0	0	0	0.0	0	1	1	8.3	0	1	1	3.7
9:30-9:45		0	0	0	0.0	0	0	0	0.0	0	0	0	0.0
9:45-10:00		0	0	0	0.0	0	0	0	0.0	0	0	0	0.0
1時間計		0	0	0	0.0	0	1	1	8.3	0	1	1	3.7
10:00-10:15		0	0	0	0.0	0	0	0	0.0	0	0	0	0.0
10:15-10:30		0	0	0	0.0	0	0	0	0.0	0	0	0	0.0
10:30-10:45		0	0	0	0.0	0	0	0	0.0	0	0	0	0.0
10:45-11:00		0	0	0	0.0	1	0	1	8.3	1	0	1	3.7
1時間計		0	0	0	0.0	1	0	1	8.3	1	0	1	3.7
11:00-11:15		0	0	0	0.0	0	0	0	0.0	0	0	0	0.0
11:15-11:30		0	0	0	0.0	0	0	0	0.0	0	0	0	0.0
11:30-11:45		0	0	0	0.0	0	0	0	0.0	0	0	0	0.0
11:45-12:00		0	1	1	6.7	0	0	0	0.0	0	1	1	3.7
1時間計		0	1	1	6.7	0	0	0	0.0	0	1	1	3.7
12:00-12:15		0	0	0	0.0	0	0	0	0.0	0	0	0	0.0
12:15-12:30		0	0	0	0.0	0	0	0	0.0	0	0	0	0.0
12:30-12:45		0	0	0	0.0	0	0	0	0.0	0	0	0	0.0
12:45-13:00		0	0	0	0.0	0	0	0	0.0	0	0	0	0.0
1時間計		0	0	0	0.0	0	0	0	0.0	0	0	0	0.0
13:00-13:15		1	0	1	6.7	1	0	1	8.3	2	0	2	7.4
13:15-13:30		0	0	0	0.0	0	0	0	0.0	0	0	0	0.0
13:30-13:45		0	0	0	0.0	0	0	0	0.0	0	0	0	0.0
13:45-14:00		0	0	0	0.0	1	0	1	8.3	1	0	1	3.7
1時間計		1	0	1	6.7	2	0	2	16.7	3	0	3	11.1

歩行者通行量調査表

調査地点：地域社会4 瀬谷土橋公園前

調査年月日：令和 2年 9月26日(土) 天候：晴れ一時雨



方向 種別	ア				イ				合計			
	歩行者 (人)	自転車 (台)	合計 (人・台)	時間 係数 (%)	歩行者 (人)	自転車 (台)	合計 (人・台)	時間 係数 (%)	歩行者 (人)	自転車 (台)	合計 (人・台)	時間 係数 (%)
14:00-14:15	1	1	2	13.3	0	0	0	0.0	1	1	2	7.4
14:15-14:30	0	0	0	0.0	0	0	0	0.0	0	0	0	0.0
14:30-14:45	0	0	0	0.0	0	0	0	0.0	0	0	0	0.0
14:45-15:00	0	0	0	0.0	0	1	1	8.3	0	1	1	3.7
1時間計	1	1	2	13.3	0	1	1	8.3	1	2	3	11.1
15:00-15:15	0	0	0	0.0	0	0	0	0.0	0	0	0	0.0
15:15-15:30	0	0	0	0.0	0	0	0	0.0	0	0	0	0.0
15:30-15:45	1	2	3	20.0	0	0	0	0.0	1	2	3	11.1
15:45-16:00	1	0	1	6.7	0	0	0	0.0	1	0	1	3.7
1時間計	2	2	4	26.7	0	0	0	0.0	2	2	4	14.8
16:00-16:15	0	0	0	0.0	0	1	1	8.3	0	1	1	3.7
16:15-16:30	0	0	0	0.0	0	0	0	0.0	0	0	0	0.0
16:30-16:45	1	0	1	6.7	0	1	1	8.3	1	1	2	7.4
16:45-17:00	0	0	0	0.0	0	0	0	0.0	0	0	0	0.0
1時間計	1	0	1	6.7	0	2	2	16.7	1	2	3	11.1
17:00-17:15	0	0	0	0.0	0	0	0	0.0	0	0	0	0.0
17:15-17:30	0	0	0	0.0	0	0	0	0.0	0	0	0	0.0
17:30-17:45	0	0	0	0.0	0	0	0	0.0	0	0	0	0.0
17:45-18:00	0	0	0	0.0	0	0	0	0.0	0	0	0	0.0
1時間計	0	0	0	0.0	0	0	0	0.0	0	0	0	0.0
18:00-18:15	0	0	0	0.0	0	0	0	0.0	0	0	0	0.0
18:15-18:30	0	0	0	0.0	0	1	1	8.3	0	1	1	3.7
18:30-18:45	0	0	0	0.0	0	0	0	0.0	0	0	0	0.0
18:45-19:00	0	0	0	0.0	0	0	0	0.0	0	0	0	0.0
1時間計	0	0	0	0.0	0	1	1	8.3	0	1	1	3.7
19:00-19:15	0	1	1	6.7	0	0	0	0.0	0	1	1	3.7
19:15-19:30	0	0	0	0.0	0	0	0	0.0	0	0	0	0.0
19:30-19:45	0	0	0	0.0	0	0	0	0.0	0	0	0	0.0
19:45-20:00	1	0	1	6.7	0	0	0	0.0	1	0	1	3.7
1時間計	1	1	2	13.3	0	0	0	0.0	1	1	2	7.4
20:00-20:15	0	0	0	0.0	0	0	0	0.0	0	0	0	0.0
20:15-20:30	0	0	0	0.0	0	0	0	0.0	0	0	0	0.0
20:30-20:45	0	0	0	0.0	0	0	0	0.0	0	0	0	0.0
20:45-21:00	0	0	0	0.0	0	0	0	0.0	0	0	0	0.0
1時間計	0	0	0	0.0	0	0	0	0.0	0	0	0	0.0
21:00-21:15	1	0	1	6.7	0	0	0	0.0	1	0	1	3.7
21:15-21:30	0	0	0	0.0	0	0	0	0.0	0	0	0	0.0
21:30-21:45	0	0	0	0.0	0	0	0	0.0	0	0	0	0.0
21:45-22:00	0	0	0	0.0	0	0	0	0.0	0	0	0	0.0
1時間計	1	0	1	6.7	0	0	0	0.0	1	0	1	3.7
昼12時間計	6	5	11	73.3	4	5	9	75.0	10	10	20	74.1
夜12時間計	2	2	4	26.7	2	1	3	25.0	4	3	7	25.9
全時間合計	8	7	15	100.0	6	6	12	100.0	14	13	27	100.0
昼夜率	1.33	1.40	1.36	-	1.50	1.20	1.33	-	1.40	1.30	1.35	-

歩行者通行量調査表

調査地点：地域社会4 瀬谷土橋公園前

調査年月日：令和 2年 9月26日(土) 天候：晴れ一時雨



時間帯	ウ				エ				合計			
	歩行者 (人)	自転車 (台)	合計 (人・台)	時間 係数 (%)	歩行者 (人)	自転車 (台)	合計 (人・台)	時間 係数 (%)	歩行者 (人)	自転車 (台)	合計 (人・台)	時間 係数 (%)
22:00-22:15	0	0	0	0.0	0	0	0	0.0	0	0	0	0.0
22:15-22:30	0	0	0	0.0	0	0	0	0.0	0	0	0	0.0
22:30-22:45	0	0	0	0.0	0	0	0	0.0	0	0	0	0.0
22:45-23:00	0	1	1	8.3	0	0	0	0.0	0	1	1	5.0
1時間計	0	1	1	8.3	0	0	0	0.0	0	1	1	5.0
23:00-23:15	0	1	1	8.3	0	0	0	0.0	0	1	1	5.0
23:15-23:30	0	0	0	0.0	0	0	0	0.0	0	0	0	0.0
23:30-23:45	0	0	0	0.0	0	0	0	0.0	0	0	0	0.0
23:45-24:00	0	0	0	0.0	0	0	0	0.0	0	0	0	0.0
1時間計	0	1	1	8.3	0	0	0	0.0	0	1	1	5.0
0:00-0:15	0	0	0	0.0	0	0	0	0.0	0	0	0	0.0
0:15-0:30	0	0	0	0.0	0	0	0	0.0	0	0	0	0.0
0:30-0:45	0	0	0	0.0	0	0	0	0.0	0	0	0	0.0
0:45-1:00	0	0	0	0.0	0	0	0	0.0	0	0	0	0.0
1時間計	0	0	0	0.0	0	0	0	0.0	0	0	0	0.0
1:00-1:15	0	0	0	0.0	0	0	0	0.0	0	0	0	0.0
1:15-1:30	0	0	0	0.0	0	0	0	0.0	0	0	0	0.0
1:30-1:45	0	0	0	0.0	0	0	0	0.0	0	0	0	0.0
1:45-2:00	0	0	0	0.0	0	0	0	0.0	0	0	0	0.0
1時間計	0	0	0	0.0	0	0	0	0.0	0	0	0	0.0
2:00-2:15	0	0	0	0.0	0	0	0	0.0	0	0	0	0.0
2:15-2:30	0	0	0	0.0	0	0	0	0.0	0	0	0	0.0
2:30-2:45	0	0	0	0.0	0	0	0	0.0	0	0	0	0.0
2:45-3:00	0	0	0	0.0	0	0	0	0.0	0	0	0	0.0
1時間計	0	0	0	0.0	0	0	0	0.0	0	0	0	0.0
3:00-3:15	0	0	0	0.0	0	0	0	0.0	0	0	0	0.0
3:15-3:30	0	0	0	0.0	0	0	0	0.0	0	0	0	0.0
3:30-3:45	0	0	0	0.0	0	0	0	0.0	0	0	0	0.0
3:45-4:00	0	0	0	0.0	0	0	0	0.0	0	0	0	0.0
1時間計	0	0	0	0.0	0	0	0	0.0	0	0	0	0.0
4:00-4:15	0	0	0	0.0	0	0	0	0.0	0	0	0	0.0
4:15-4:30	0	0	0	0.0	0	0	0	0.0	0	0	0	0.0
4:30-4:45	0	0	0	0.0	0	0	0	0.0	0	0	0	0.0
4:45-5:00	0	0	0	0.0	0	0	0	0.0	0	0	0	0.0
1時間計	0	0	0	0.0	0	0	0	0.0	0	0	0	0.0
5:00-5:15	0	1	1	8.3	0	0	0	0.0	0	1	1	5.0
5:15-5:30	0	0	0	0.0	0	0	0	0.0	0	0	0	0.0
5:30-5:45	0	0	0	0.0	0	0	0	0.0	0	0	0	0.0
5:45-6:00	0	0	0	0.0	0	0	0	0.0	0	0	0	0.0
1時間計	0	1	1	8.3	0	0	0	0.0	0	1	1	5.0

歩行者通行量調査表

調査地点：地域社会4 瀬谷土橋公園前

調査年月日：令和 2年 9月26日(土) 天候：晴れ一時雨



時間帯	種別	ウ				I				合計			
		歩行者 (人)	自転車 (台)	合計 (人・台)	時間 係数 (%)	歩行者 (人)	自転車 (台)	合計 (人・台)	時間 係数 (%)	歩行者 (人)	自転車 (台)	合計 (人・台)	時間 係数 (%)
6:00-6:15		1	0	1	8.3	0	0	0	0.0	1	0	1	5.0
6:15-6:30		0	0	0	0.0	0	0	0	0.0	0	0	0	0.0
6:30-6:45		0	0	0	0.0	0	0	0	0.0	0	0	0	0.0
6:45-7:00		0	0	0	0.0	0	0	0	0.0	0	0	0	0.0
1時間計		1	0	1	8.3	0	0	0	0.0	1	0	1	5.0
7:00-7:15		0	0	0	0.0	0	0	0	0.0	0	0	0	0.0
7:15-7:30		0	0	0	0.0	0	0	0	0.0	0	0	0	0.0
7:30-7:45		0	0	0	0.0	0	0	0	0.0	0	0	0	0.0
7:45-8:00		0	0	0	0.0	1	0	1	12.5	1	0	1	5.0
1時間計		0	0	0	0.0	1	0	1	12.5	1	0	1	5.0
8:00-8:15		0	1	1	8.3	0	0	0	0.0	0	1	1	5.0
8:15-8:30		0	0	0	0.0	0	0	0	0.0	0	0	0	0.0
8:30-8:45		0	0	0	0.0	0	0	0	0.0	0	0	0	0.0
8:45-9:00		0	0	0	0.0	0	0	0	0.0	0	0	0	0.0
1時間計		0	1	1	8.3	0	0	0	0.0	0	1	1	5.0
9:00-9:15		0	0	0	0.0	0	1	1	12.5	0	1	1	5.0
9:15-9:30		0	0	0	0.0	0	0	0	0.0	0	0	0	0.0
9:30-9:45		0	0	0	0.0	0	0	0	0.0	0	0	0	0.0
9:45-10:00		0	0	0	0.0	0	0	0	0.0	0	0	0	0.0
1時間計		0	0	0	0.0	0	1	1	12.5	0	1	1	5.0
10:00-10:15		0	0	0	0.0	0	0	0	0.0	0	0	0	0.0
10:15-10:30		0	0	0	0.0	0	1	1	12.5	0	1	1	5.0
10:30-10:45		0	0	0	0.0	0	0	0	0.0	0	0	0	0.0
10:45-11:00		0	0	0	0.0	0	0	0	0.0	0	0	0	0.0
1時間計		0	0	0	0.0	0	1	1	12.5	0	1	1	5.0
11:00-11:15		0	0	0	0.0	0	0	0	0.0	0	0	0	0.0
11:15-11:30		0	0	0	0.0	0	0	0	0.0	0	0	0	0.0
11:30-11:45		1	0	1	8.3	0	0	0	0.0	1	0	1	5.0
11:45-12:00		0	0	0	0.0	0	0	0	0.0	0	0	0	0.0
1時間計		1	0	1	8.3	0	0	0	0.0	1	0	1	5.0
12:00-12:15		0	0	0	0.0	0	0	0	0.0	0	0	0	0.0
12:15-12:30		0	0	0	0.0	1	0	1	12.5	1	0	1	5.0
12:30-12:45		0	0	0	0.0	0	0	0	0.0	0	0	0	0.0
12:45-13:00		0	0	0	0.0	0	0	0	0.0	0	0	0	0.0
1時間計		0	0	0	0.0	1	0	1	12.5	1	0	1	5.0
13:00-13:15		1	0	1	8.3	1	0	1	12.5	2	0	2	10.0
13:15-13:30		0	0	0	0.0	0	0	0	0.0	0	0	0	0.0
13:30-13:45		0	0	0	0.0	0	0	0	0.0	0	0	0	0.0
13:45-14:00		0	0	0	0.0	0	0	0	0.0	0	0	0	0.0
1時間計		1	0	1	8.3	1	0	1	12.5	2	0	2	10.0

歩行者通行量調査表

調査地点：地域社会4 瀬谷土橋公園前

調査年月日：令和 2年 9月26日(土) 天候：晴れ一時雨



方向	ウ				I				合計				
	種別	歩行者 (人)	自転車 (台)	合計 (人・台)	時間 係数 (%)	歩行者 (人)	自転車 (台)	合計 (人・台)	時間 係数 (%)	歩行者 (人)	自転車 (台)	合計 (人・台)	時間 係数 (%)
14:00-14:15		0	0	0	0.0	0	0	0	0.0	0	0	0	0.0
14:15-14:30		0	0	0	0.0	0	0	0	0.0	0	0	0	0.0
14:30-14:45		1	0	1	8.3	0	0	0	0.0	1	0	1	5.0
14:45-15:00		0	0	0	0.0	0	0	0	0.0	0	0	0	0.0
1時間計		1	0	1	8.3	0	0	0	0.0	1	0	1	5.0
15:00-15:15		0	0	0	0.0	0	0	0	0.0	0	0	0	0.0
15:15-15:30		0	0	0	0.0	0	0	0	0.0	0	0	0	0.0
15:30-15:45		0	0	0	0.0	0	0	0	0.0	0	0	0	0.0
15:45-16:00		1	0	1	8.3	0	0	0	0.0	1	0	1	5.0
1時間計		1	0	1	8.3	0	0	0	0.0	1	0	1	5.0
16:00-16:15		0	1	1	8.3	0	0	0	0.0	0	1	1	5.0
16:15-16:30		0	0	0	0.0	0	0	0	0.0	0	0	0	0.0
16:30-16:45		0	0	0	0.0	0	0	0	0.0	0	0	0	0.0
16:45-17:00		0	1	1	8.3	0	0	0	0.0	0	1	1	5.0
1時間計		0	2	2	16.7	0	0	0	0.0	0	2	2	10.0
17:00-17:15		0	0	0	0.0	0	0	0	0.0	0	0	0	0.0
17:15-17:30		0	0	0	0.0	1	0	1	12.5	1	0	1	5.0
17:30-17:45		0	0	0	0.0	0	0	0	0.0	0	0	0	0.0
17:45-18:00		0	0	0	0.0	0	0	0	0.0	0	0	0	0.0
1時間計		0	0	0	0.0	1	0	1	12.5	1	0	1	5.0
18:00-18:15		0	0	0	0.0	0	0	0	0.0	0	0	0	0.0
18:15-18:30		0	0	0	0.0	0	1	1	12.5	0	1	1	5.0
18:30-18:45		0	0	0	0.0	0	0	0	0.0	0	0	0	0.0
18:45-19:00		0	0	0	0.0	0	0	0	0.0	0	0	0	0.0
1時間計		0	0	0	0.0	0	1	1	12.5	0	1	1	5.0
19:00-19:15		0	0	0	0.0	0	0	0	0.0	0	0	0	0.0
19:15-19:30		0	0	0	0.0	0	0	0	0.0	0	0	0	0.0
19:30-19:45		0	0	0	0.0	0	0	0	0.0	0	0	0	0.0
19:45-20:00		0	0	0	0.0	0	0	0	0.0	0	0	0	0.0
1時間計		0	0	0	0.0	0	0	0	0.0	0	0	0	0.0
20:00-20:15		0	0	0	0.0	0	0	0	0.0	0	0	0	0.0
20:15-20:30		0	0	0	0.0	0	0	0	0.0	0	0	0	0.0
20:30-20:45		0	0	0	0.0	0	0	0	0.0	0	0	0	0.0
20:45-21:00		0	1	1	8.3	0	0	0	0.0	0	1	1	5.0
1時間計		0	1	1	8.3	0	0	0	0.0	0	1	1	5.0
21:00-21:15		0	0	0	0.0	0	0	0	0.0	0	0	0	0.0
21:15-21:30		0	0	0	0.0	0	0	0	0.0	0	0	0	0.0
21:30-21:45		0	0	0	0.0	0	0	0	0.0	0	0	0	0.0
21:45-22:00		0	0	0	0.0	0	1	1	12.5	0	1	1	5.0
1時間計		0	0	0	0.0	0	1	1	12.5	0	1	1	5.0
昼12時間計		4	3	7	58.3	4	3	7	87.5	8	6	14	70.0
夜12時間計		1	4	5	41.7	0	1	1	12.5	1	5	6	30.0
全時間合計		5	7	12	100.0	4	4	8	100.0	9	11	20	100.0
昼夜率		1.25	2.33	1.71	-	1.00	1.33	1.14	-	1.13	1.83	1.43	-

歩行者通行量調査表

調査地点：地域社会4 瀬谷土橋公園前

調査年月日：令和 2年 9月26日(土) 天候：晴れ一時雨



時間帯	種別	合計 (7+I+U+E)			時間係数 (%)
		歩行者 (人)	自転車 (台)	合計 (人・台)	
22:00-22:15		0	0	0	0.0
22:15-22:30		0	0	0	0.0
22:30-22:45		0	0	0	0.0
22:45-23:00		0	1	1	2.1
1時間計		0	1	1	2.1
23:00-23:15		0	1	1	2.1
23:15-23:30		0	0	0	0.0
23:30-23:45		0	0	0	0.0
23:45-24:00		0	0	0	0.0
1時間計		0	1	1	2.1
0:00-0:15		0	0	0	0.0
0:15-0:30		0	0	0	0.0
0:30-0:45		0	0	0	0.0
0:45-1:00		0	0	0	0.0
1時間計		0	0	0	0.0
1:00-1:15		0	0	0	0.0
1:15-1:30		0	0	0	0.0
1:30-1:45		0	0	0	0.0
1:45-2:00		0	0	0	0.0
1時間計		0	0	0	0.0
2:00-2:15		0	0	0	0.0
2:15-2:30		0	0	0	0.0
2:30-2:45		0	0	0	0.0
2:45-3:00		0	0	0	0.0
1時間計		0	0	0	0.0
3:00-3:15		0	0	0	0.0
3:15-3:30		1	0	1	2.1
3:30-3:45		0	0	0	0.0
3:45-4:00		0	0	0	0.0
1時間計		1	0	1	2.1
4:00-4:15		0	0	0	0.0
4:15-4:30		0	0	0	0.0
4:30-4:45		0	0	0	0.0
4:45-5:00		0	0	0	0.0
1時間計		0	0	0	0.0
5:00-5:15		0	2	2	4.3
5:15-5:30		0	0	0	0.0
5:30-5:45		0	1	1	2.1
5:45-6:00		0	0	0	0.0
1時間計		0	3	3	6.4
6:00-6:15		1	0	1	2.1
6:15-6:30		0	0	0	0.0
6:30-6:45		1	0	1	2.1
6:45-7:00		0	0	0	0.0
1時間計		2	0	2	4.3
7:00-7:15		0	0	0	0.0
7:15-7:30		0	0	0	0.0
7:30-7:45		1	0	1	2.1
7:45-8:00		2	0	2	4.3
1時間計		3	0	3	6.4
8:00-8:15		0	1	1	2.1
8:15-8:30		0	0	0	0.0
8:30-8:45		0	1	1	2.1
8:45-9:00		0	0	0	0.0
1時間計		0	2	2	4.3
9:00-9:15		0	1	1	2.1
9:15-9:30		0	1	1	2.1
9:30-9:45		0	0	0	0.0
9:45-10:00		0	0	0	0.0
1時間計		0	2	2	4.3

時間帯	種別	合計 (7+I+U+E)			時間係数 (%)
		歩行者 (人)	自転車 (台)	合計 (人・台)	
22:00-23:00		0	1	1	2.1
22:15-23:15		0	2	2	4.3
22:30-23:30		0	2	2	4.3
22:45-23:45		0	2	2	4.3
23:00-0:00		0	1	1	2.1
23:15-0:15		0	0	0	0.0
23:30-0:30		0	0	0	0.0
23:45-0:45		0	0	0	0.0
0:00-1:00		0	0	0	0.0
0:15-1:15		0	0	0	0.0
0:30-1:30		0	0	0	0.0
0:45-1:45		0	0	0	0.0
1:00-2:00		0	0	0	0.0
1:15-2:15		0	0	0	0.0
1:30-2:30		0	0	0	0.0
1:45-2:45		0	0	0	0.0
2:00-3:00		0	0	0	0.0
2:15-3:15		0	0	0	0.0
2:30-3:30		1	0	1	2.1
2:45-3:45		1	0	1	2.1
3:00-4:00		1	0	1	2.1
3:15-4:15		1	0	1	2.1
3:30-4:30		0	0	0	0.0
3:45-4:45		0	0	0	0.0
4:00-5:00		0	0	0	0.0
4:15-5:15		0	2	2	4.3
4:30-5:30		0	2	2	4.3
4:45-5:45		0	3	3	6.4
5:00-6:00		0	3	3	6.4
5:15-6:15		1	1	2	4.3
5:30-6:30		1	1	2	4.3
5:45-6:45		2	0	2	4.3
6:00-7:00		2	0	2	4.3
6:15-7:15		1	0	1	2.1
6:30-7:30		1	0	1	2.1
6:45-7:45		1	0	1	2.1
7:00-8:00		3	0	3	6.4
7:15-8:15		3	1	4	8.5
7:30-8:30		3	1	4	8.5
7:45-8:45		2	2	4	8.5
8:00-9:00		0	2	2	4.3
8:15-9:15		0	2	2	4.3
8:30-9:30		0	3	3	6.4
8:45-9:45		0	2	2	4.3
9:00-10:00		0	2	2	4.3
9:15-10:15		0	1	1	2.1
9:30-10:30		0	1	1	2.1
9:45-10:45		0	1	1	2.1
10:00-11:00		1	1	2	4.3
10:15-11:15		1	1	2	4.3
10:30-11:30		1	0	1	2.1
10:45-11:45		2	0	2	4.3
11:00-12:00		1	1	2	4.3
11:15-12:15		1	1	2	4.3
11:30-12:30		2	1	3	6.4
11:45-12:45		1	1	2	4.3
12:00-13:00		1	0	1	2.1
12:15-13:15		5	0	5	10.6
12:30-13:30		4	0	4	8.5
12:45-13:45		4	0	4	8.5

歩行者通行量調査表

調査地点：地域社会4 瀬谷土橋公園前

調査年月日：令和 2年 9月26日(土) 天候：晴れ一時雨



時間帯	方向 種別	合計 (7+I+U+E)			時間 係数 (%)
		歩行者 (人)	自転車 (台)	合計 (人・台)	
10:00-10:15		0	0	0	0.0
10:15-10:30		0	1	1	2.1
10:30-10:45		0	0	0	0.0
10:45-11:00		1	0	1	2.1
1時間計		1	1	2	4.3
11:00-11:15		0	0	0	0.0
11:15-11:30		0	0	0	0.0
11:30-11:45		1	0	1	2.1
11:45-12:00		0	1	1	2.1
1時間計		1	1	2	4.3
12:00-12:15		0	0	0	0.0
12:15-12:30		1	0	1	2.1
12:30-12:45		0	0	0	0.0
12:45-13:00		0	0	0	0.0
1時間計		1	0	1	2.1
13:00-13:15		4	0	4	8.5
13:15-13:30		0	0	0	0.0
13:30-13:45		0	0	0	0.0
13:45-14:00		1	0	1	2.1
1時間計		5	0	5	10.6
14:00-14:15		1	1	2	4.3
14:15-14:30		0	0	0	0.0
14:30-14:45		1	0	1	2.1
14:45-15:00		0	1	1	2.1
1時間計		2	2	4	8.5
15:00-15:15		0	0	0	0.0
15:15-15:30		0	0	0	0.0
15:30-15:45		1	2	3	6.4
15:45-16:00		2	0	2	4.3
1時間計		3	2	5	10.6
16:00-16:15		0	2	2	4.3
16:15-16:30		0	0	0	0.0
16:30-16:45		1	1	2	4.3
16:45-17:00		0	1	1	2.1
1時間計		1	4	5	10.6
17:00-17:15		0	0	0	0.0
17:15-17:30		1	0	1	2.1
17:30-17:45		0	0	0	0.0
17:45-18:00		0	0	0	0.0
1時間計		1	0	1	2.1
18:00-18:15		0	0	0	0.0
18:15-18:30		0	2	2	4.3
18:30-18:45		0	0	0	0.0
18:45-19:00		0	0	0	0.0
1時間計		0	2	2	4.3
19:00-19:15		0	1	1	2.1
19:15-19:30		0	0	0	0.0
19:30-19:45		0	0	0	0.0
19:45-20:00		1	0	1	2.1
1時間計		1	1	2	4.3
20:00-20:15		0	0	0	0.0
20:15-20:30		0	0	0	0.0
20:30-20:45		0	0	0	0.0
20:45-21:00		0	1	1	2.1
1時間計		0	1	1	2.1
21:00-21:15		1	0	1	2.1
21:15-21:30		0	0	0	0.0
21:30-21:45		0	0	0	0.0
21:45-22:00		0	1	1	2.1
1時間計		1	1	2	4.3
昼12時間計		18	16	34	72.3
夜12時間計		5	8	13	27.7
全時間合計		23	24	47	100.0
昼夜率		1.28	1.50	1.38	-

時間帯	方向 種別	合計 (7+I+U+E)			時間 係数 (%)
		歩行者 (人)	自転車 (台)	合計 (人・台)	
13:00-14:00		5	0	5	10.6
13:15-14:15		2	1	3	6.4
13:30-14:30		2	1	3	6.4
13:45-14:45		3	1	4	8.5
14:00-15:00		2	2	4	8.5
14:15-15:15		1	1	2	4.3
14:30-15:30		1	1	2	4.3
14:45-15:45		1	3	4	8.5
15:00-16:00		3	2	5	10.6
15:15-16:15		3	4	7	14.9
15:30-16:30		3	4	7	14.9
15:45-16:45		3	3	6	12.8
16:00-17:00		1	4	5	10.6
16:15-17:15		1	2	3	6.4
16:30-17:30		2	2	4	8.5
16:45-17:45		1	1	2	4.3
17:00-18:00		1	0	1	2.1
17:15-18:15		1	0	1	2.1
17:30-18:30		0	2	2	4.3
17:45-18:45		0	2	2	4.3
18:00-19:00		0	2	2	4.3
18:15-19:15		0	3	3	6.4
18:30-19:30		0	1	1	2.1
18:45-19:45		0	1	1	2.1
19:00-20:00		1	1	2	4.3
19:15-20:15		1	0	1	2.1
19:30-20:30		1	0	1	2.1
19:45-20:45		1	0	1	2.1
20:00-21:00		0	1	1	2.1
20:15-21:15		1	1	2	4.3
20:30-21:30		1	1	2	4.3
20:45-21:45		1	1	2	4.3
21:00-22:00		1	1	2	4.3
全時間合計		23	24	47	100.0

歩行者通行量調査表

調査地点：地域社会5

調査年月日：令和元年 5月11日(土) 天候：晴れ時々曇り

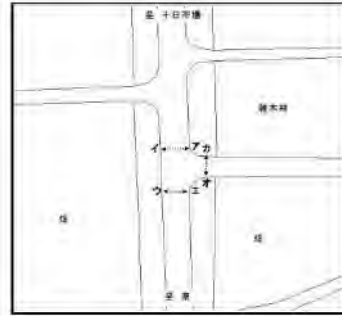

時間帯	ア				イ				合計			
	歩行者 (人)	自転車 (台)	合計 (人・台)	時間 係数 (%)	歩行者 (人)	自転車 (台)	合計 (人・台)	時間 係数 (%)	歩行者 (人)	自転車 (台)	合計 (人・台)	時間 係数 (%)
22:00-22:15	0	0	0	0.0	0	0	0	0.0	0	0	0	0.0
22:15-22:30	0	0	0	0.0	0	0	0	0.0	0	0	0	0.0
22:30-22:45	0	0	0	0.0	0	1	1	2.0	0	1	1	1.2
22:45-23:00	0	0	0	0.0	0	0	0	0.0	0	0	0	0.0
1時間計	0	0	0	0.0	0	1	1	2.0	0	1	1	1.2
23:00-23:15	0	0	0	0.0	0	0	0	0.0	0	0	0	0.0
23:15-23:30	0	0	0	0.0	0	0	0	0.0	0	0	0	0.0
23:30-23:45	0	0	0	0.0	0	0	0	0.0	0	0	0	0.0
23:45-24:00	0	0	0	0.0	0	0	0	0.0	0	0	0	0.0
1時間計	0	0	0	0.0	0	0	0	0.0	0	0	0	0.0
0:00-0:15	0	0	0	0.0	0	0	0	0.0	0	0	0	0.0
0:15-0:30	0	0	0	0.0	0	0	0	0.0	0	0	0	0.0
0:30-0:45	0	0	0	0.0	0	0	0	0.0	0	0	0	0.0
0:45-1:00	0	0	0	0.0	0	0	0	0.0	0	0	0	0.0
1時間計	0	0	0	0.0	0	0	0	0.0	0	0	0	0.0
1:00-1:15	0	0	0	0.0	0	0	0	0.0	0	0	0	0.0
1:15-1:30	0	0	0	0.0	0	0	0	0.0	0	0	0	0.0
1:30-1:45	0	0	0	0.0	0	0	0	0.0	0	0	0	0.0
1:45-2:00	0	0	0	0.0	0	0	0	0.0	0	0	0	0.0
1時間計	0	0	0	0.0	0	0	0	0.0	0	0	0	0.0
2:00-2:15	0	0	0	0.0	0	0	0	0.0	0	0	0	0.0
2:15-2:30	0	0	0	0.0	0	0	0	0.0	0	0	0	0.0
2:30-2:45	0	0	0	0.0	0	0	0	0.0	0	0	0	0.0
2:45-3:00	0	0	0	0.0	0	0	0	0.0	0	0	0	0.0
1時間計	0	0	0	0.0	0	0	0	0.0	0	0	0	0.0
3:00-3:15	0	0	0	0.0	0	0	0	0.0	0	0	0	0.0
3:15-3:30	0	0	0	0.0	0	0	0	0.0	0	0	0	0.0
3:30-3:45	0	0	0	0.0	0	0	0	0.0	0	0	0	0.0
3:45-4:00	0	0	0	0.0	0	0	0	0.0	0	0	0	0.0
1時間計	0	0	0	0.0	0	0	0	0.0	0	0	0	0.0
4:00-4:15	0	0	0	0.0	0	0	0	0.0	0	0	0	0.0
4:15-4:30	0	0	0	0.0	0	0	0	0.0	0	0	0	0.0
4:30-4:45	0	0	0	0.0	0	0	0	0.0	0	0	0	0.0
4:45-5:00	0	0	0	0.0	0	0	0	0.0	0	0	0	0.0
1時間計	0	0	0	0.0	0	0	0	0.0	0	0	0	0.0
5:00-5:15	0	0	0	0.0	0	0	0	0.0	0	0	0	0.0
5:15-5:30	0	0	0	0.0	0	0	0	0.0	0	0	0	0.0
5:30-5:45	0	0	0	0.0	0	0	0	0.0	0	0	0	0.0
5:45-6:00	0	0	0	0.0	0	0	0	0.0	0	0	0	0.0
1時間計	0	0	0	0.0	0	0	0	0.0	0	0	0	0.0

歩行者通行量調査表

調査地点：地域社会5

調査年月日：令和元年 5月11日(土) 天候：晴れ時々曇り

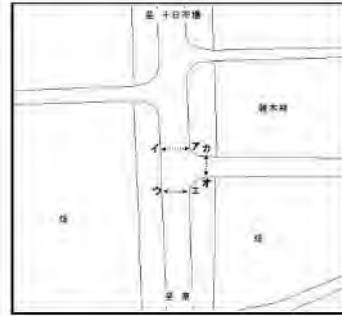

時間帯	ア				イ				合計			
	歩行者 (人)	自転車 (台)	合計 (人・台)	時間 係数 (%)	歩行者 (人)	自転車 (台)	合計 (人・台)	時間 係数 (%)	歩行者 (人)	自転車 (台)	合計 (人・台)	時間 係数 (%)
6:00-6:15	0	0	0	0.0	0	0	0	0.0	0	0	0	0.0
6:15-6:30	0	0	0	0.0	1	0	1	2.0	1	0	1	1.2
6:30-6:45	0	0	0	0.0	0	1	1	2.0	0	1	1	1.2
6:45-7:00	0	0	0	0.0	1	1	2	4.0	1	1	2	2.4
1時間計	0	0	0	0.0	2	2	4	8.0	2	2	4	4.8
7:00-7:15	0	0	0	0.0	1	0	1	2.0	1	0	1	1.2
7:15-7:30	0	0	0	0.0	0	1	1	2.0	0	1	1	1.2
7:30-7:45	0	0	0	0.0	0	0	0	0.0	0	0	0	0.0
7:45-8:00	0	1	1	2.9	0	0	0	0.0	0	1	1	1.2
1時間計	0	1	1	2.9	1	1	2	4.0	1	2	3	3.6
8:00-8:15	0	0	0	0.0	1	1	2	4.0	1	1	2	2.4
8:15-8:30	1	0	1	2.9	1	2	3	6.0	2	2	4	4.8
8:30-8:45	1	0	1	2.9	1	3	4	8.0	2	3	5	6.0
8:45-9:00	1	1	2	5.9	0	0	0	0.0	1	1	2	2.4
1時間計	3	1	4	11.8	3	6	9	18.0	6	7	13	15.5
9:00-9:15	0	0	0	0.0	0	0	0	0.0	0	0	0	0.0
9:15-9:30	0	1	1	2.9	1	1	2	4.0	1	2	3	3.6
9:30-9:45	0	0	0	0.0	0	2	2	4.0	0	2	2	2.4
9:45-10:00	0	0	0	0.0	0	1	1	2.0	0	1	1	1.2
1時間計	0	1	1	2.9	1	4	5	10.0	1	5	6	7.1
10:00-10:15	3	0	3	8.8	1	1	2	4.0	4	1	5	6.0
10:15-10:30	4	1	5	14.7	2	1	3	6.0	6	2	8	9.5
10:30-10:45	1	0	1	2.9	0	0	0	0.0	1	0	1	1.2
10:45-11:00	1	0	1	2.9	0	0	0	0.0	1	0	1	1.2
1時間計	9	1	10	29.4	3	2	5	10.0	12	3	15	17.9
11:00-11:15	0	1	1	2.9	0	0	0	0.0	0	1	1	1.2
11:15-11:30	1	2	3	8.8	0	0	0	0.0	1	2	3	3.6
11:30-11:45	0	0	0	0.0	0	0	0	0.0	0	0	0	0.0
11:45-12:00	0	0	0	0.0	2	1	3	6.0	2	1	3	3.6
1時間計	1	3	4	11.8	2	1	3	6.0	3	4	7	8.3
12:00-12:15	1	0	1	2.9	0	1	1	2.0	1	1	2	2.4
12:15-12:30	0	0	0	0.0	0	0	0	0.0	0	0	0	0.0
12:30-12:45	0	0	0	0.0	0	0	0	0.0	0	0	0	0.0
12:45-13:00	0	0	0	0.0	0	0	0	0.0	0	0	0	0.0
1時間計	1	0	1	2.9	0	1	1	2.0	1	1	2	2.4
13:00-13:15	0	0	0	0.0	1	0	1	2.0	1	0	1	1.2
13:15-13:30	0	0	0	0.0	1	1	2	4.0	1	1	2	2.4
13:30-13:45	0	1	1	2.9	1	0	1	2.0	1	1	2	2.4
13:45-14:00	0	1	1	2.9	1	0	1	2.0	1	1	2	2.4
1時間計	0	2	2	5.9	4	1	5	10.0	4	3	7	8.3

歩行者通行量調査表

調査地点：地域社会5

調査年月日：令和元年 5月11日(土) 天候：晴れ時々曇り



時間帯	方向				イ				エ				合計				
	種別	歩行者 (人)	自転車 (台)	合計 (人・台)	時間 係数 (%)	歩行者 (人)	自転車 (台)	合計 (人・台)	時間 係数 (%)	歩行者 (人)	自転車 (台)	合計 (人・台)	時間 係数 (%)	歩行者 (人)	自転車 (台)	合計 (人・台)	時間 係数 (%)
14:00-14:15		0	0	0	0.0	1	0	1	2.0	1	0	1	1.2	1	0	1	1.2
14:15-14:30		1	0	1	2.9	0	0	0	0.0	1	0	1	1.2	1	0	1	1.2
14:30-14:45		0	1	1	2.9	1	1	2	4.0	1	2	3	3.6	1	2	3	3.6
14:45-15:00		0	0	0	0.0	0	1	1	2.0	0	1	1	1.2	0	1	1	1.2
1時間計		1	1	2	5.9	2	2	4	8.0	3	3	6	7.1	1	1	2	5.9
15:00-15:15		0	0	0	0.0	0	2	2	4.0	0	2	2	2.4	0	2	2	2.4
15:15-15:30		0	0	0	0.0	0	0	0	0.0	0	0	0	0.0	0	0	0	0.0
15:30-15:45		0	0	0	0.0	0	1	1	2.0	0	1	1	1.2	0	1	1	1.2
15:45-16:00		0	0	0	0.0	0	0	0	0.0	0	0	0	0.0	0	0	0	0.0
1時間計		0	0	0	0.0	0	3	3	6.0	0	3	3	3.6	0	3	3	3.6
16:00-16:15		2	2	4	11.8	0	0	0	0.0	2	2	4	4.8	2	2	4	4.8
16:15-16:30		0	0	0	0.0	0	1	1	2.0	0	1	1	1.2	0	1	1	1.2
16:30-16:45		0	3	3	8.8	0	0	0	0.0	0	3	3	3.6	0	3	3	3.6
16:45-17:00		0	0	0	0.0	0	1	1	2.0	0	1	1	1.2	0	1	1	1.2
1時間計		2	5	7	20.6	0	2	2	4.0	2	7	9	10.7	2	7	9	10.7
17:00-17:15		0	0	0	0.0	0	0	0	0.0	0	0	0	0.0	0	0	0	0.0
17:15-17:30		0	0	0	0.0	0	0	0	0.0	0	0	0	0.0	0	0	0	0.0
17:30-17:45		0	0	0	0.0	0	0	0	0.0	0	0	0	0.0	0	0	0	0.0
17:45-18:00		0	0	0	0.0	0	0	0	0.0	0	0	0	0.0	0	0	0	0.0
1時間計		0	0	0	0.0	0	0	0	0.0	0	0	0	0.0	0	0	0	0.0
18:00-18:15		0	0	0	0.0	0	1	1	2.0	0	1	1	1.2	0	1	1	1.2
18:15-18:30		0	0	0	0.0	0	0	0	0.0	0	0	0	0.0	0	0	0	0.0
18:30-18:45		0	1	1	2.9	1	0	1	2.0	1	1	2	2.4	1	1	2	2.4
18:45-19:00		0	0	0	0.0	0	0	0	0.0	0	0	0	0.0	0	0	0	0.0
1時間計		0	1	1	2.9	1	1	2	4.0	1	2	3	3.6	1	2	3	3.6
19:00-19:15		0	0	0	0.0	0	2	2	4.0	0	2	2	2.4	0	2	2	2.4
19:15-19:30		0	0	0	0.0	0	0	0	0.0	0	0	0	0.0	0	0	0	0.0
19:30-19:45		0	0	0	0.0	0	0	0	0.0	0	0	0	0.0	0	0	0	0.0
19:45-20:00		0	1	1	2.9	0	0	0	0.0	0	1	1	1.2	0	1	1	1.2
1時間計		0	1	1	2.9	0	2	2	4.0	0	3	3	3.6	0	3	3	3.6
20:00-20:15		0	0	0	0.0	0	1	1	2.0	0	1	1	1.2	0	1	1	1.2
20:15-20:30		0	0	0	0.0	0	0	0	0.0	0	0	0	0.0	0	0	0	0.0
20:30-20:45		0	0	0	0.0	0	0	0	0.0	0	0	0	0.0	0	0	0	0.0
20:45-21:00		0	0	0	0.0	0	0	0	0.0	0	0	0	0.0	0	0	0	0.0
1時間計		0	0	0	0.0	0	1	1	2.0	0	1	1	1.2	0	1	1	1.2
21:00-21:15		0	0	0	0.0	0	0	0	0.0	0	0	0	0.0	0	0	0	0.0
21:15-21:30		0	0	0	0.0	0	1	1	2.0	0	1	1	1.2	0	1	1	1.2
21:30-21:45		0	0	0	0.0	0	0	0	0.0	0	0	0	0.0	0	0	0	0.0
21:45-22:00		0	0	0	0.0	0	0	0	0.0	0	0	0	0.0	0	0	0	0.0
1時間計		0	0	0	0.0	0	1	1	2.0	0	1	1	1.2	0	1	1	1.2
昼12時間計		17	16	33	97.1	17	24	41	82.0	34	40	74	88.1	17	16	33	97.1
夜12時間計		0	1	1	2.9	2	7	9	18.0	2	8	10	11.9	0	1	1	2.9
全時間合計		17	17	34	100.0	19	31	50	100.0	36	48	84	100.0	17	17	34	100.0
昼夜率		1.00	1.06	1.03	-	1.12	1.29	1.22	-	1.06	1.20	1.14	-	1.00	1.06	1.03	-

歩行者通行量調査表

調査地点：地域社会5

調査年月日：令和元年 5月11日(土) 天候：晴れ時々曇り

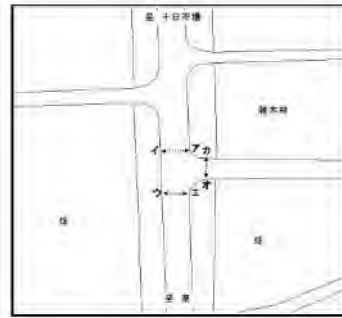

時間帯	ウ				I				合計			
	歩行者 (人)	自転車 (台)	合計 (人・台)	時間 係数 (%)	歩行者 (人)	自転車 (台)	合計 (人・台)	時間 係数 (%)	歩行者 (人)	自転車 (台)	合計 (人・台)	時間 係数 (%)
22:00-22:15	0	3	3	3.2	0	0	0	0.0	0	3	3	2.0
22:15-22:30	0	0	0	0.0	0	0	0	0.0	0	0	0	0.0
22:30-22:45	0	0	0	0.0	0	0	0	0.0	0	0	0	0.0
22:45-23:00	0	0	0	0.0	0	0	0	0.0	0	0	0	0.0
1時間計	0	3	3	3.2	0	0	0	0.0	0	3	3	2.0
23:00-23:15	0	0	0	0.0	0	1	1	1.7	0	1	1	0.7
23:15-23:30	0	0	0	0.0	0	0	0	0.0	0	0	0	0.0
23:30-23:45	0	0	0	0.0	0	0	0	0.0	0	0	0	0.0
23:45-24:00	0	0	0	0.0	0	1	1	1.7	0	1	1	0.7
1時間計	0	0	0	0.0	0	2	2	3.4	0	2	2	1.3
0:00-0:15	0	0	0	0.0	0	0	0	0.0	0	0	0	0.0
0:15-0:30	0	0	0	0.0	0	0	0	0.0	0	0	0	0.0
0:30-0:45	0	0	0	0.0	0	0	0	0.0	0	0	0	0.0
0:45-1:00	0	0	0	0.0	0	0	0	0.0	0	0	0	0.0
1時間計	0	0	0	0.0	0	0	0	0.0	0	0	0	0.0
1:00-1:15	0	0	0	0.0	0	0	0	0.0	0	0	0	0.0
1:15-1:30	0	0	0	0.0	0	0	0	0.0	0	0	0	0.0
1:30-1:45	0	0	0	0.0	0	0	0	0.0	0	0	0	0.0
1:45-2:00	0	0	0	0.0	0	0	0	0.0	0	0	0	0.0
1時間計	0	0	0	0.0	0	0	0	0.0	0	0	0	0.0
2:00-2:15	0	0	0	0.0	0	0	0	0.0	0	0	0	0.0
2:15-2:30	0	0	0	0.0	0	0	0	0.0	0	0	0	0.0
2:30-2:45	1	0	1	1.1	0	0	0	0.0	1	0	1	0.7
2:45-3:00	0	0	0	0.0	0	0	0	0.0	0	0	0	0.0
1時間計	1	0	1	1.1	0	0	0	0.0	1	0	1	0.7
3:00-3:15	0	0	0	0.0	0	0	0	0.0	0	0	0	0.0
3:15-3:30	0	0	0	0.0	0	0	0	0.0	0	0	0	0.0
3:30-3:45	0	0	0	0.0	0	0	0	0.0	0	0	0	0.0
3:45-4:00	0	0	0	0.0	0	0	0	0.0	0	0	0	0.0
1時間計	0	0	0	0.0	0	0	0	0.0	0	0	0	0.0
4:00-4:15	0	0	0	0.0	0	0	0	0.0	0	0	0	0.0
4:15-4:30	0	0	0	0.0	0	0	0	0.0	0	0	0	0.0
4:30-4:45	0	0	0	0.0	0	0	0	0.0	0	0	0	0.0
4:45-5:00	0	0	0	0.0	0	0	0	0.0	0	0	0	0.0
1時間計	0	0	0	0.0	0	0	0	0.0	0	0	0	0.0
5:00-5:15	0	0	0	0.0	0	0	0	0.0	0	0	0	0.0
5:15-5:30	1	0	1	1.1	0	2	2	3.4	1	2	3	2.0
5:30-5:45	0	0	0	0.0	0	0	0	0.0	0	0	0	0.0
5:45-6:00	0	0	0	0.0	0	0	0	0.0	0	0	0	0.0
1時間計	1	0	1	1.1	0	2	2	3.4	1	2	3	2.0

歩行者通行量調査表

調査地点：地域社会5

調査年月日：令和元年 5月11日(土) 天候：晴れ時々曇り

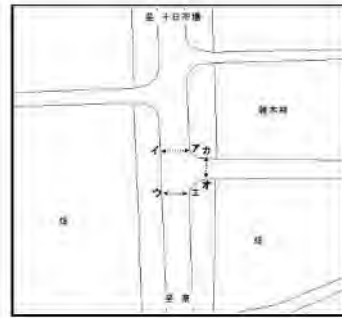

時間帯	ウ				I				合計			
	歩行者 (人)	自転車 (台)	合計 (人・台)	時間 係数 (%)	歩行者 (人)	自転車 (台)	合計 (人・台)	時間 係数 (%)	歩行者 (人)	自転車 (台)	合計 (人・台)	時間 係数 (%)
6:00-6:15	0	0	0	0.0	0	0	0	0.0	0	0	0	0.0
6:15-6:30	1	1	2	2.2	1	2	3	5.1	2	3	5	3.3
6:30-6:45	0	0	0	0.0	0	3	3	5.1	0	3	3	2.0
6:45-7:00	1	0	1	1.1	1	0	1	1.7	2	0	2	1.3
1時間計	2	1	3	3.2	2	5	7	11.9	4	6	10	6.6
7:00-7:15	0	0	0	0.0	1	0	1	1.7	1	0	1	0.7
7:15-7:30	4	1	5	5.4	1	1	2	3.4	5	2	7	4.6
7:30-7:45	2	0	2	2.2	0	0	0	0.0	2	0	2	1.3
7:45-8:00	0	1	1	1.1	1	1	2	3.4	1	2	3	2.0
1時間計	6	2	8	8.6	3	2	5	8.5	9	4	13	8.6
8:00-8:15	0	0	0	0.0	0	0	0	0.0	0	0	0	0.0
8:15-8:30	1	3	4	4.3	0	1	1	1.7	1	4	5	3.3
8:30-8:45	0	0	0	0.0	0	1	1	1.7	0	1	1	0.7
8:45-9:00	0	0	0	0.0	0	0	0	0.0	0	0	0	0.0
1時間計	1	3	4	4.3	0	2	2	3.4	1	5	6	3.9
9:00-9:15	0	2	2	2.2	0	0	0	0.0	0	2	2	1.3
9:15-9:30	2	1	3	3.2	0	0	0	0.0	2	1	3	2.0
9:30-9:45	0	1	1	1.1	0	0	0	0.0	0	1	1	0.7
9:45-10:00	2	2	4	4.3	0	1	1	1.7	2	3	5	3.3
1時間計	4	6	10	10.8	0	1	1	1.7	4	7	11	7.2
10:00-10:15	2	1	3	3.2	3	0	3	5.1	5	1	6	3.9
10:15-10:30	2	2	4	4.3	4	1	5	8.5	6	3	9	5.9
10:30-10:45	2	0	2	2.2	3	0	3	5.1	5	0	5	3.3
10:45-11:00	0	0	0	0.0	0	1	1	1.7	0	1	1	0.7
1時間計	6	3	9	9.7	10	2	12	20.3	16	5	21	13.8
11:00-11:15	0	0	0	0.0	1	2	3	5.1	1	2	3	2.0
11:15-11:30	1	0	1	1.1	1	1	2	3.4	2	1	3	2.0
11:30-11:45	0	0	0	0.0	0	0	0	0.0	0	0	0	0.0
11:45-12:00	1	0	1	1.1	0	0	0	0.0	1	0	1	0.7
1時間計	2	0	2	2.2	2	3	5	8.5	4	3	7	4.6
12:00-12:15	0	1	1	1.1	0	0	0	0.0	0	1	1	0.7
12:15-12:30	0	2	2	2.2	0	2	2	3.4	0	4	4	2.6
12:30-12:45	0	2	2	2.2	0	4	4	6.8	0	6	6	3.9
12:45-13:00	0	0	0	0.0	0	0	0	0.0	0	0	0	0.0
1時間計	0	5	5	5.4	0	6	6	10.2	0	11	11	7.2
13:00-13:15	0	0	0	0.0	0	0	0	0.0	0	0	0	0.0
13:15-13:30	0	4	4	4.3	0	1	1	1.7	0	5	5	3.3
13:30-13:45	0	2	2	2.2	0	0	0	0.0	0	2	2	1.3
13:45-14:00	0	3	3	3.2	0	0	0	0.0	0	3	3	2.0
1時間計	0	9	9	9.7	0	1	1	1.7	0	10	10	6.6

歩行者通行量調査表

調査地点：地域社会5

調査年月日：令和元年 5月11日(土) 天候：晴れ時々曇り



時間帯	ウ				I				合計			
	歩行者 (人)	自転車 (台)	合計 (人・台)	時間 係数 (%)	歩行者 (人)	自転車 (台)	合計 (人・台)	時間 係数 (%)	歩行者 (人)	自転車 (台)	合計 (人・台)	時間 係数 (%)
14:00-14:15	0	2	2	2.2	0	0	0	0.0	0	2	2	1.3
14:15-14:30	0	3	3	3.2	0	0	0	0.0	0	3	3	2.0
14:30-14:45	0	1	1	1.1	0	0	0	0.0	0	1	1	0.7
14:45-15:00	0	0	0	0.0	0	0	0	0.0	0	0	0	0.0
1時間計	0	6	6	6.5	0	0	0	0.0	0	6	6	3.9
15:00-15:15	0	0	0	0.0	0	0	0	0.0	0	0	0	0.0
15:15-15:30	0	0	0	0.0	0	0	0	0.0	0	0	0	0.0
15:30-15:45	0	0	0	0.0	0	0	0	0.0	0	0	0	0.0
15:45-16:00	1	3	4	4.3	1	0	1	1.7	2	3	5	3.3
1時間計	1	3	4	4.3	1	0	1	1.7	2	3	5	3.3
16:00-16:15	0	1	1	1.1	0	1	1	1.7	0	2	2	1.3
16:15-16:30	2	2	4	4.3	1	2	3	5.1	3	4	7	4.6
16:30-16:45	0	1	1	1.1	0	0	0	0.0	0	1	1	0.7
16:45-17:00	4	3	7	7.5	1	1	2	3.4	5	4	9	5.9
1時間計	6	7	13	14.0	2	4	6	10.2	8	11	19	12.5
17:00-17:15	0	1	1	1.1	1	2	3	5.1	1	3	4	2.6
17:15-17:30	1	0	1	1.1	0	0	0	0.0	1	0	1	0.7
17:30-17:45	0	2	2	2.2	0	1	1	1.7	0	3	3	2.0
17:45-18:00	0	1	1	1.1	1	0	1	1.7	1	1	2	1.3
1時間計	1	4	5	5.4	2	3	5	8.5	3	7	10	6.6
18:00-18:15	0	1	1	1.1	0	1	1	1.7	0	2	2	1.3
18:15-18:30	0	4	4	4.3	0	0	0	0.0	0	4	4	2.6
18:30-18:45	0	0	0	0.0	0	1	1	1.7	0	1	1	0.7
18:45-19:00	1	2	3	3.2	0	0	0	0.0	1	2	3	2.0
1時間計	1	7	8	8.6	0	2	2	3.4	1	9	10	6.6
19:00-19:15	0	0	0	0.0	0	0	0	0.0	0	0	0	0.0
19:15-19:30	0	0	0	0.0	0	0	0	0.0	0	0	0	0.0
19:30-19:45	0	0	0	0.0	0	0	0	0.0	0	0	0	0.0
19:45-20:00	0	0	0	0.0	0	0	0	0.0	0	0	0	0.0
1時間計	0	0	0	0.0	0	0	0	0.0	0	0	0	0.0
20:00-20:15	0	0	0	0.0	2	0	2	3.4	2	0	2	1.3
20:15-20:30	0	0	0	0.0	0	0	0	0.0	0	0	0	0.0
20:30-20:45	0	1	1	1.1	0	0	0	0.0	0	1	1	0.7
20:45-21:00	0	0	0	0.0	0	0	0	0.0	0	0	0	0.0
1時間計	0	1	1	1.1	2	0	2	3.4	2	1	3	2.0
21:00-21:15	0	0	0	0.0	0	0	0	0.0	0	0	0	0.0
21:15-21:30	0	0	0	0.0	0	0	0	0.0	0	0	0	0.0
21:30-21:45	0	1	1	1.1	0	0	0	0.0	0	1	1	0.7
21:45-22:00	0	0	0	0.0	0	0	0	0.0	0	0	0	0.0
1時間計	0	1	1	1.1	0	0	0	0.0	0	1	1	0.7
昼12時間計	28	55	83	89.2	20	26	46	78.0	48	81	129	84.9
夜12時間計	4	6	10	10.8	4	9	13	22.0	8	15	23	15.1
全時間合計	32	61	93	100.0	24	35	59	100.0	56	96	152	100.0
昼夜率	1.14	1.11	1.12	-	1.20	1.35	1.28	-	1.17	1.19	1.18	-

歩行者通行量調査表

調査地点：地域社会5

調査年月日：令和元年 5月11日(土) 天候：晴れ時々曇り

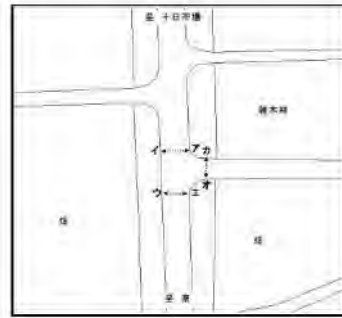

時間帯	方向				合計							
	歩行者 (人)	自転車 (台)	合計 (人・台)	時間 係数 (%)	歩行者 (人)	自転車 (台)	合計 (人・台)	時間 係数 (%)	歩行者 (人)	自転車 (台)	合計 (人・台)	時間 係数 (%)
22:00-22:15	3	3	6	1.8	0	0	0	0.0	3	3	6	1.1
22:15-22:30	0	1	1	0.3	0	0	0	0.0	0	1	1	0.2
22:30-22:45	0	0	0	0.0	0	0	0	0.0	0	0	0	0.0
22:45-23:00	0	0	0	0.0	0	1	1	0.5	0	1	1	0.2
1時間計	3	4	7	2.1	0	1	1	0.5	3	5	8	1.5
23:00-23:15	1	2	3	0.9	2	0	2	1.0	3	2	5	0.9
23:15-23:30	0	0	0	0.0	0	2	2	1.0	0	2	2	0.4
23:30-23:45	1	0	1	0.3	0	1	1	0.5	1	1	2	0.4
23:45-24:00	0	2	2	0.6	0	0	0	0.0	0	2	2	0.4
1時間計	2	4	6	1.8	2	3	5	2.4	4	7	11	2.0
0:00-0:15	0	0	0	0.0	0	0	0	0.0	0	0	0	0.0
0:15-0:30	0	2	2	0.6	0	0	0	0.0	0	2	2	0.4
0:30-0:45	0	0	0	0.0	0	0	0	0.0	0	0	0	0.0
0:45-1:00	0	0	0	0.0	0	0	0	0.0	0	0	0	0.0
1時間計	0	2	2	0.6	0	0	0	0.0	0	2	2	0.4
1:00-1:15	0	0	0	0.0	0	0	0	0.0	0	0	0	0.0
1:15-1:30	0	1	1	0.3	0	0	0	0.0	0	1	1	0.2
1:30-1:45	0	0	0	0.0	0	0	0	0.0	0	0	0	0.0
1:45-2:00	0	0	0	0.0	0	0	0	0.0	0	0	0	0.0
1時間計	0	1	1	0.3	0	0	0	0.0	0	1	1	0.2
2:00-2:15	0	0	0	0.0	0	0	0	0.0	0	0	0	0.0
2:15-2:30	0	0	0	0.0	0	0	0	0.0	0	0	0	0.0
2:30-2:45	0	0	0	0.0	0	0	0	0.0	0	0	0	0.0
2:45-3:00	0	0	0	0.0	0	0	0	0.0	0	0	0	0.0
1時間計	0	0	0	0.0	0	0	0	0.0	0	0	0	0.0
3:00-3:15	0	0	0	0.0	0	0	0	0.0	0	0	0	0.0
3:15-3:30	0	0	0	0.0	0	0	0	0.0	0	0	0	0.0
3:30-3:45	0	0	0	0.0	0	0	0	0.0	0	0	0	0.0
3:45-4:00	0	0	0	0.0	1	0	1	0.5	1	0	1	0.2
1時間計	0	0	0	0.0	1	0	1	0.5	1	0	1	0.2
4:00-4:15	0	0	0	0.0	1	0	1	0.5	1	0	1	0.2
4:15-4:30	0	1	1	0.3	2	0	2	1.0	2	1	3	0.6
4:30-4:45	2	0	2	0.6	0	0	0	0.0	2	0	2	0.4
4:45-5:00	0	2	2	0.6	2	0	2	1.0	2	2	4	0.7
1時間計	2	3	5	1.5	5	0	5	2.4	7	3	10	1.8
5:00-5:15	2	1	3	0.9	1	0	1	0.5	3	1	4	0.7
5:15-5:30	1	1	2	0.6	2	0	2	1.0	3	1	4	0.7
5:30-5:45	2	0	2	0.6	1	2	3	1.5	3	2	5	0.9
5:45-6:00	2	2	4	1.2	5	1	6	2.9	7	3	10	1.8
1時間計	7	4	11	3.3	9	3	12	5.9	16	7	23	4.2

歩行者通行量調査表

調査地点：地域社会5

調査年月日：令和元年 5月11日(土) 天候：晴れ時々曇り

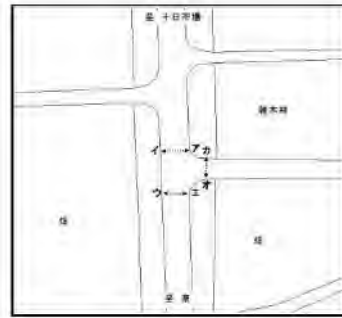

時間帯	方向				合計							
	歩行者 (人)	自転車 (台)	合計 (人・台)	時間 係数 (%)	歩行者 (人)	自転車 (台)	合計 (人・台)	時間 係数 (%)	歩行者 (人)	自転車 (台)	合計 (人・台)	時間 係数 (%)
6:00-6:15	0	4	4	1.2	3	0	3	1.5	3	4	7	1.3
6:15-6:30	1	1	2	0.6	7	5	12	5.9	8	6	14	2.6
6:30-6:45	3	5	8	2.4	6	4	10	4.9	9	9	18	3.3
6:45-7:00	1	5	6	1.8	3	0	3	1.5	4	5	9	1.7
1時間計	5	15	20	5.9	19	9	28	13.7	24	24	48	8.9
7:00-7:15	5	8	13	3.9	1	0	1	0.5	6	8	14	2.6
7:15-7:30	2	8	10	3.0	1	0	1	0.5	3	8	11	2.0
7:30-7:45	3	1	4	1.2	0	1	1	0.5	3	2	5	0.9
7:45-8:00	5	2	7	2.1	5	0	5	2.4	10	2	12	2.2
1時間計	15	19	34	10.1	7	1	8	3.9	22	20	42	7.7
8:00-8:15	0	0	0	0.0	0	0	0	0.0	0	0	0	0.0
8:15-8:30	3	5	8	2.4	2	2	4	2.0	5	7	12	2.2
8:30-8:45	1	1	2	0.6	0	0	0	0.0	1	1	2	0.4
8:45-9:00	0	0	0	0.0	0	0	0	0.0	0	0	0	0.0
1時間計	4	6	10	3.0	2	2	4	2.0	6	8	14	2.6
9:00-9:15	0	1	1	0.3	1	0	1	0.5	1	1	2	0.4
9:15-9:30	1	1	2	0.6	1	1	2	1.0	2	2	4	0.7
9:30-9:45	1	3	4	1.2	1	4	5	2.4	2	7	9	1.7
9:45-10:00	1	3	4	1.2	2	1	3	1.5	3	4	7	1.3
1時間計	3	8	11	3.3	5	6	11	5.4	8	14	22	4.1
10:00-10:15	4	4	8	2.4	1	0	1	0.5	5	4	9	1.7
10:15-10:30	2	5	7	2.1	2	0	2	1.0	4	5	9	1.7
10:30-10:45	4	6	10	3.0	4	1	5	2.4	8	7	15	2.8
10:45-11:00	1	3	4	1.2	3	1	4	2.0	4	4	8	1.5
1時間計	11	18	29	8.6	10	2	12	5.9	21	20	41	7.6
11:00-11:15	4	1	5	1.5	3	1	4	2.0	7	2	9	1.7
11:15-11:30	2	8	10	3.0	0	2	2	1.0	2	10	12	2.2
11:30-11:45	2	1	3	0.9	1	0	1	0.5	3	1	4	0.7
11:45-12:00	1	2	3	0.9	1	0	1	0.5	2	2	4	0.7
1時間計	9	12	21	6.2	5	3	8	3.9	14	15	29	5.4
12:00-12:15	2	3	5	1.5	1	4	5	2.4	3	7	10	1.8
12:15-12:30	2	2	4	1.2	1	0	1	0.5	3	2	5	0.9
12:30-12:45	2	3	5	1.5	2	1	3	1.5	4	4	8	1.5
12:45-13:00	2	6	8	2.4	1	0	1	0.5	3	6	9	1.7
1時間計	8	14	22	6.5	5	5	10	4.9	13	19	32	5.9
13:00-13:15	1	1	2	0.6	0	0	0	0.0	1	1	2	0.4
13:15-13:30	2	2	4	1.2	3	3	6	2.9	5	5	10	1.8
13:30-13:45	0	1	1	0.3	0	0	0	0.0	0	1	1	0.2
13:45-14:00	1	2	3	0.9	0	1	1	0.5	1	3	4	0.7
1時間計	4	6	10	3.0	3	4	7	3.4	7	10	17	3.1

歩行者通行量調査表

調査地点：地域社会5

調査年月日：令和元年 5月11日(土) 天候：晴れ時々曇り

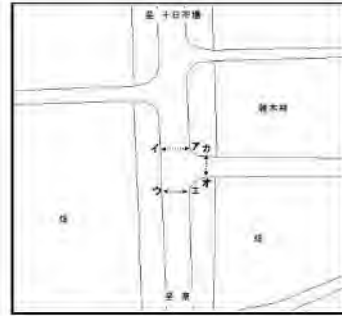

時間帯	方向				合計							
	歩行者 (人)	自転車 (台)	合計 (人・台)	時間 係数 (%)	歩行者 (人)	自転車 (台)	合計 (人・台)	時間 係数 (%)	歩行者 (人)	自転車 (台)	合計 (人・台)	時間 係数 (%)
14:00-14:15	4	1	5	1.5	3	0	3	1.5	7	1	8	1.5
14:15-14:30	4	5	9	2.7	4	2	6	2.9	8	7	15	2.8
14:30-14:45	1	3	4	1.2	4	2	6	2.9	5	5	10	1.8
14:45-15:00	1	2	3	0.9	1	0	1	0.5	2	2	4	0.7
1時間計	10	11	21	6.2	12	4	16	7.8	22	15	37	6.8
15:00-15:15	1	2	3	0.9	1	1	2	1.0	2	3	5	0.9
15:15-15:30	2	4	6	1.8	3	2	5	2.4	5	6	11	2.0
15:30-15:45	0	2	2	0.6	1	0	1	0.5	1	2	3	0.6
15:45-16:00	3	2	5	1.5	1	2	3	1.5	4	4	8	1.5
1時間計	6	10	16	4.7	6	5	11	5.4	12	15	27	5.0
16:00-16:15	5	6	11	3.3	3	0	3	1.5	8	6	14	2.6
16:15-16:30	4	2	6	1.8	3	3	6	2.9	7	5	12	2.2
16:30-16:45	2	1	3	0.9	5	2	7	3.4	7	3	10	1.8
16:45-17:00	7	1	8	2.4	4	2	6	2.9	11	3	14	2.6
1時間計	18	10	28	8.3	15	7	22	10.7	33	17	50	9.2
17:00-17:15	3	7	10	3.0	1	3	4	2.0	4	10	14	2.6
17:15-17:30	7	7	14	4.2	2	0	2	1.0	9	7	16	3.0
17:30-17:45	4	4	8	2.4	5	2	7	3.4	9	6	15	2.8
17:45-18:00	4	4	8	2.4	1	2	3	1.5	5	6	11	2.0
1時間計	18	22	40	11.9	9	7	16	7.8	27	29	56	10.3
18:00-18:15	3	1	4	1.2	1	1	2	1.0	4	2	6	1.1
18:15-18:30	1	2	3	0.9	0	3	3	1.5	1	5	6	1.1
18:30-18:45	2	6	8	2.4	2	2	4	2.0	4	8	12	2.2
18:45-19:00	3	3	6	1.8	0	0	0	0.0	3	3	6	1.1
1時間計	9	12	21	6.2	3	6	9	4.4	12	18	30	5.5
19:00-19:15	0	1	1	0.3	1	2	3	1.5	1	3	4	0.7
19:15-19:30	0	2	2	0.6	0	2	2	1.0	0	4	4	0.7
19:30-19:45	1	1	2	0.6	1	1	2	1.0	2	2	4	0.7
19:45-20:00	0	2	2	0.6	0	0	0	0.0	0	2	2	0.4
1時間計	1	6	7	2.1	2	5	7	3.4	3	11	14	2.6
20:00-20:15	1	4	5	1.5	0	0	0	0.0	1	4	5	0.9
20:15-20:30	0	3	3	0.9	0	1	1	0.5	0	4	4	0.7
20:30-20:45	0	0	0	0.0	0	3	3	1.5	0	3	3	0.6
20:45-21:00	1	1	2	0.6	0	1	1	0.5	1	2	3	0.6
1時間計	2	8	10	3.0	0	5	5	2.4	2	13	15	2.8
21:00-21:15	0	0	0	0.0	0	2	2	1.0	0	2	2	0.4
21:15-21:30	0	0	0	0.0	1	1	2	1.0	1	1	2	0.4
21:30-21:45	0	4	4	1.2	2	1	3	1.5	2	5	7	1.3
21:45-22:00	0	1	1	0.3	0	0	0	0.0	0	1	1	0.2
1時間計	0	5	5	1.5	3	4	7	3.4	3	9	12	2.2
昼12時間計	115	148	263	78.0	82	52	134	65.4	197	200	397	73.2
夜12時間計	22	52	74	22.0	41	30	71	34.6	63	82	145	26.8
全時間合計	137	200	337	100.0	123	82	205	100.0	260	282	542	100.0
昼夜率	1.19	1.35	1.28	-	1.50	1.58	1.53	-	1.32	1.41	1.37	-

歩行者通行量調査表

調査地点 : 地域社会5

調査年月日 : 令和元年 5月11日(土) 天候: 晴れ時々曇り

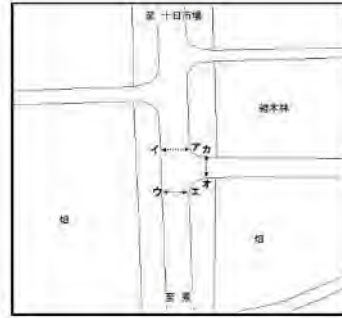

時間帯	方向 種別	合計 (7+1+4+1+4+4)			時間 係数 (%)
		歩行者 (人)	自転車 (台)	合計 (人・台)	
22:00-22:15		3	6	9	1.2
22:15-22:30		0	1	1	0.1
22:30-22:45		0	1	1	0.1
22:45-23:00		0	1	1	0.1
1時間計		3	9	12	1.5
23:00-23:15		3	3	6	0.8
23:15-23:30		0	2	2	0.3
23:30-23:45		1	1	2	0.3
23:45-24:00		0	3	3	0.4
1時間計		4	9	13	1.7
0:00-0:15		0	0	0	0.0
0:15-0:30		0	2	2	0.3
0:30-0:45		0	0	0	0.0
0:45-1:00		0	0	0	0.0
1時間計		0	2	2	0.3
1:00-1:15		0	0	0	0.0
1:15-1:30		0	1	1	0.1
1:30-1:45		0	0	0	0.0
1:45-2:00		0	0	0	0.0
1時間計		0	1	1	0.1
2:00-2:15		0	0	0	0.0
2:15-2:30		0	0	0	0.0
2:30-2:45		1	0	1	0.1
2:45-3:00		0	0	0	0.0
1時間計		1	0	1	0.1
3:00-3:15		0	0	0	0.0
3:15-3:30		0	0	0	0.0
3:30-3:45		0	0	0	0.0
3:45-4:00		1	0	1	0.1
1時間計		1	0	1	0.1
4:00-4:15		1	0	1	0.1
4:15-4:30		2	1	3	0.4
4:30-4:45		2	0	2	0.3
4:45-5:00		2	2	4	0.5
1時間計		7	3	10	1.3
5:00-5:15		3	1	4	0.5
5:15-5:30		4	3	7	0.9
5:30-5:45		3	2	5	0.6
5:45-6:00		7	3	10	1.3
1時間計		17	9	26	3.3
6:00-6:15		3	4	7	0.9
6:15-6:30		11	9	20	2.6
6:30-6:45		9	13	22	2.8
6:45-7:00		7	6	13	1.7
1時間計		30	32	62	8.0
7:00-7:15		8	8	16	2.1
7:15-7:30		8	11	19	2.4
7:30-7:45		5	2	7	0.9
7:45-8:00		11	5	16	2.1
1時間計		32	26	58	7.5
8:00-8:15		1	1	2	0.3
8:15-8:30		8	13	21	2.7
8:30-8:45		3	5	8	1.0
8:45-9:00		1	1	2	0.3
1時間計		13	20	33	4.2
9:00-9:15		1	3	4	0.5
9:15-9:30		5	5	10	1.3
9:30-9:45		2	10	12	1.5
9:45-10:00		5	8	13	1.7
1時間計		13	26	39	5.0

時間帯	方向 種別	合計 (7+1+4+1+4+4)			時間 係数 (%)
		歩行者 (人)	自転車 (台)	合計 (人・台)	
22:00-23:00		3	9	12	1.5
22:15-23:15		3	6	9	1.2
22:30-23:30		3	7	10	1.3
22:45-23:45		4	7	11	1.4
23:00-0:00		4	9	13	1.7
23:15-0:15		1	6	7	0.9
23:30-0:30		1	6	7	0.9
23:45-0:45		0	5	5	0.6
0:00-1:00		0	2	2	0.3
0:15-1:15		0	2	2	0.3
0:30-1:30		0	1	1	0.1
0:45-1:45		0	1	1	0.1
1:00-2:00		0	1	1	0.1
1:15-2:15		0	1	1	0.1
1:30-2:30		0	0	0	0.0
1:45-2:45		1	0	1	0.1
2:00-3:00		1	0	1	0.1
2:15-3:15		1	0	1	0.1
2:30-3:30		1	0	1	0.1
2:45-3:45		0	0	0	0.0
3:00-4:00		1	0	1	0.1
3:15-4:15		2	0	2	0.3
3:30-4:30		4	1	5	0.6
3:45-4:45		6	1	7	0.9
4:00-5:00		7	3	10	1.3
4:15-5:15		9	4	13	1.7
4:30-5:30		11	6	17	2.2
4:45-5:45		12	8	20	2.6
5:00-6:00		17	9	26	3.3
5:15-6:15		17	12	29	3.7
5:30-6:30		24	18	42	5.4
5:45-6:45		30	29	59	7.6
6:00-7:00		30	32	62	8.0
6:15-7:15		35	36	71	9.1
6:30-7:30		32	38	70	9.0
6:45-7:45		28	27	55	7.1
7:00-8:00		32	26	58	7.5
7:15-8:15		25	19	44	5.7
7:30-8:30		25	21	46	5.9
7:45-8:45		23	24	47	6.0
8:00-9:00		13	20	33	4.2
8:15-9:15		13	22	35	4.5
8:30-9:30		10	14	24	3.1
8:45-9:45		9	19	28	3.6
9:00-10:00		13	26	39	5.0
9:15-10:15		26	29	55	7.1
9:30-10:30		37	34	71	9.1
9:45-10:45		49	31	80	10.3
10:00-11:00		49	28	77	9.9
10:15-11:15		43	27	70	9.0
10:30-11:30		32	30	62	8.0
10:45-11:45		21	24	45	5.8
11:00-12:00		21	22	43	5.5
11:15-12:15		17	26	43	5.5
11:30-12:30		15	19	34	4.4
11:45-12:45		16	28	44	5.7
12:00-13:00		14	31	45	5.8
12:15-13:15		12	23	35	4.5
12:30-13:30		15	28	43	5.5
12:45-13:45		12	22	34	4.4

歩行者通行量調査表

調査地点 : 地域社会5

調査年月日 : 令和元年 5月11日(土) 天候:晴れ時々曇り

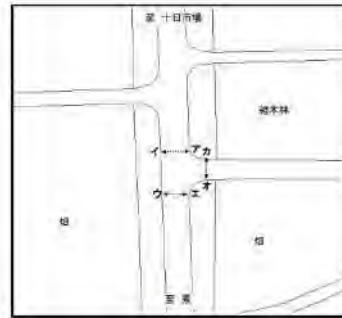

時間帯	種別	合計 (7+10+17+10)			時間係数 (%)
		歩行者 (人)	自転車 (台)	合 計 (人・台)	
10:00-10:15		14	6	20	2.6
10:15-10:30		16	10	26	3.3
10:30-10:45		14	7	21	2.7
10:45-11:00		5	5	10	1.3
1時間計		49	28	77	9.9
11:00-11:15		8	5	13	1.7
11:15-11:30		5	13	18	2.3
11:30-11:45		3	1	4	0.5
11:45-12:00		5	3	8	1.0
1時間計		21	22	43	5.5
12:00-12:15		4	9	13	1.7
12:15-12:30		3	6	9	1.2
12:30-12:45		4	10	14	1.8
12:45-13:00		3	6	9	1.2
1時間計		14	31	45	5.8
13:00-13:15		2	1	3	0.4
13:15-13:30		6	11	17	2.2
13:30-13:45		1	4	5	0.6
13:45-14:00		2	7	9	1.2
1時間計		11	23	34	4.4
14:00-14:15		8	3	11	1.4
14:15-14:30		9	10	19	2.4
14:30-14:45		6	8	14	1.8
14:45-15:00		2	3	5	0.6
1時間計		25	24	49	6.3
15:00-15:15		2	5	7	0.9
15:15-15:30		5	6	11	1.4
15:30-15:45		1	3	4	0.5
15:45-16:00		6	7	13	1.7
1時間計		14	21	35	4.5
16:00-16:15		10	10	20	2.6
16:15-16:30		10	10	20	2.6
16:30-16:45		7	7	14	1.8
16:45-17:00		16	8	24	3.1
1時間計		43	35	78	10.0
17:00-17:15		5	13	18	2.3
17:15-17:30		10	7	17	2.2
17:30-17:45		9	9	18	2.3
17:45-18:00		6	7	13	1.7
1時間計		30	36	66	8.5
18:00-18:15		4	5	9	1.2
18:15-18:30		1	9	10	1.3
18:30-18:45		5	10	15	1.9
18:45-19:00		4	5	9	1.2
1時間計		14	29	43	5.5
19:00-19:15		1	5	6	0.8
19:15-19:30		0	4	4	0.5
19:30-19:45		2	2	4	0.5
19:45-20:00		0	3	3	0.4
1時間計		3	14	17	2.2
20:00-20:15		3	5	8	1.0
20:15-20:30		0	4	4	0.5
20:30-20:45		0	4	4	0.5
20:45-21:00		1	2	3	0.4
1時間計		4	15	19	2.4
21:00-21:15		0	2	2	0.3
21:15-21:30		1	2	3	0.4
21:30-21:45		2	6	8	1.0
21:45-22:00		0	1	1	0.1
1時間計		3	11	14	1.8
昼12時間計		279	321	600	77.1
夜12時間計		73	105	178	22.9
全時間合計		352	426	778	100.0
昼 夜 率		1.26	1.33	1.30	-

時間帯	種別	合計 (7+10+17+10)			時間係数 (%)
		歩行者 (人)	自転車 (台)	合 計 (人・台)	
13:00-14:00		11	23	34	4.4
13:15-14:15		17	25	42	5.4
13:30-14:30		20	24	44	5.7
13:45-14:45		25	28	53	6.8
14:00-15:00		25	24	49	6.3
14:15-15:15		19	26	45	5.8
14:30-15:30		15	22	37	4.8
14:45-15:45		10	17	27	3.5
15:00-16:00		14	21	35	4.5
15:15-16:15		22	26	48	6.2
15:30-16:30		27	30	57	7.3
15:45-16:45		33	34	67	8.6
16:00-17:00		43	35	78	10.0
16:15-17:15		38	38	76	9.8
16:30-17:30		38	35	73	9.4
16:45-17:45		40	37	77	9.9
17:00-18:00		30	36	66	8.5
17:15-18:15		29	28	57	7.3
17:30-18:30		20	30	50	6.4
17:45-18:45		16	31	47	6.0
18:00-19:00		14	29	43	5.5
18:15-19:15		11	29	40	5.1
18:30-19:30		10	24	34	4.4
18:45-19:45		7	16	23	3.0
19:00-20:00		3	14	17	2.2
19:15-20:15		5	14	19	2.4
19:30-20:30		5	14	19	2.4
19:45-20:45		3	16	19	2.4
20:00-21:00		4	15	19	2.4
20:15-21:15		1	12	13	1.7
20:30-21:30		2	10	12	1.5
20:45-21:45		4	12	16	2.1
21:00-22:00		3	11	14	1.8
全時間合計		352	426	778	100.0

歩行者通行量調査表

調査地点：地域社会6 瀬谷中学校前

調査年月日：令和元年 5月11日(土) 天候：晴れ時々曇り



時間帯	ア				イ				合計			
	歩行者 (人)	自転車 (台)	合計 (人・台)	時間 係数 (%)	歩行者 (人)	自転車 (台)	合計 (人・台)	時間 係数 (%)	歩行者 (人)	自転車 (台)	合計 (人・台)	時間 係数 (%)
22:00-22:15	1	1	2	0.3	13	1	14	1.6	14	2	16	1.1
22:15-22:30	6	0	6	1.0	16	5	21	2.3	22	5	27	1.8
22:30-22:45	0	0	0	0.0	7	0	7	0.8	7	0	7	0.5
22:45-23:00	1	0	1	0.2	9	1	10	1.1	10	1	11	0.7
1時間計	8	1	9	1.6	45	7	52	5.8	53	8	61	4.1
23:00-23:15	0	0	0	0.0	7	0	7	0.8	7	0	7	0.5
23:15-23:30	0	0	0	0.0	8	1	9	1.0	8	1	9	0.6
23:30-23:45	1	0	1	0.2	3	1	4	0.4	4	1	5	0.3
23:45-24:00	2	0	2	0.3	6	2	8	0.9	8	2	10	0.7
1時間計	3	0	3	0.5	24	4	28	3.1	27	4	31	2.1
0:00-0:15	1	0	1	0.2	5	0	5	0.6	6	0	6	0.4
0:15-0:30	0	0	0	0.0	8	0	8	0.9	8	0	8	0.5
0:30-0:45	0	0	0	0.0	5	0	5	0.6	5	0	5	0.3
0:45-1:00	1	0	1	0.2	7	2	9	1.0	8	2	10	0.7
1時間計	2	0	2	0.3	25	2	27	3.0	27	2	29	2.0
1:00-1:15	2	0	2	0.3	2	0	2	0.2	4	0	4	0.3
1:15-1:30	0	0	0	0.0	2	2	4	0.4	2	2	4	0.3
1:30-1:45	2	0	2	0.3	1	0	1	0.1	3	0	3	0.2
1:45-2:00	0	0	0	0.0	2	0	2	0.2	2	0	2	0.1
1時間計	4	0	4	0.7	7	2	9	1.0	11	2	13	0.9
2:00-2:15	0	1	1	0.2	1	0	1	0.1	1	1	2	0.1
2:15-2:30	1	0	1	0.2	0	0	0	0.0	1	0	1	0.1
2:30-2:45	0	0	0	0.0	0	0	0	0.0	0	0	0	0.0
2:45-3:00	0	0	0	0.0	3	0	3	0.3	3	0	3	0.2
1時間計	1	1	2	0.3	4	0	4	0.4	5	1	6	0.4
3:00-3:15	0	0	0	0.0	0	0	0	0.0	0	0	0	0.0
3:15-3:30	0	0	0	0.0	0	0	0	0.0	0	0	0	0.0
3:30-3:45	1	0	1	0.2	0	0	0	0.0	1	0	1	0.1
3:45-4:00	0	0	0	0.0	0	0	0	0.0	0	0	0	0.0
1時間計	1	0	1	0.2	0	0	0	0.0	1	0	1	0.1
4:00-4:15	0	0	0	0.0	0	0	0	0.0	0	0	0	0.0
4:15-4:30	0	1	1	0.2	1	0	1	0.1	1	1	2	0.1
4:30-4:45	0	0	0	0.0	0	0	0	0.0	0	0	0	0.0
4:45-5:00	0	0	0	0.0	0	0	0	0.0	0	0	0	0.0
1時間計	0	1	1	0.2	1	0	1	0.1	1	1	2	0.1
5:00-5:15	0	0	0	0.0	0	0	0	0.0	0	0	0	0.0
5:15-5:30	1	0	1	0.2	1	0	1	0.1	2	0	2	0.1
5:30-5:45	0	0	0	0.0	0	0	0	0.0	0	0	0	0.0
5:45-6:00	4	0	4	0.7	0	1	1	0.1	4	1	5	0.3
1時間計	5	0	5	0.9	1	1	2	0.2	6	1	7	0.5

歩行者通行量調査表

調査地点：地域社会6 瀬谷中学校前

調査年月日：令和元年 5月11日(土) 天候：晴れ時々曇り



時間帯	種別	ア				イ				合計			
		歩行者 (人)	自転車 (台)	合計 (人・台)	時間 係数 (%)	歩行者 (人)	自転車 (台)	合計 (人・台)	時間 係数 (%)	歩行者 (人)	自転車 (台)	合計 (人・台)	時間 係数 (%)
6:00-6:15		1	0	1	0.2	2	0	2	0.2	3	0	3	0.2
6:15-6:30		2	1	3	0.5	1	2	3	0.3	3	3	6	0.4
6:30-6:45		1	3	4	0.7	1	2	3	0.3	2	5	7	0.5
6:45-7:00		3	2	5	0.9	4	0	4	0.4	7	2	9	0.6
1時間計		7	6	13	2.3	8	4	12	1.3	15	10	25	1.7
7:00-7:15		4	0	4	0.7	7	1	8	0.9	11	1	12	0.8
7:15-7:30		2	1	3	0.5	8	1	9	1.0	10	2	12	0.8
7:30-7:45		2	4	6	1.0	0	1	1	0.1	2	5	7	0.5
7:45-8:00		3	5	8	1.4	5	0	5	0.6	8	5	13	0.9
1時間計		11	10	21	3.7	20	3	23	2.5	31	13	44	3.0
8:00-8:15		11	1	12	2.1	4	0	4	0.4	15	1	16	1.1
8:15-8:30		4	2	6	1.0	3	0	3	0.3	7	2	9	0.6
8:30-8:45		0	3	3	0.5	4	1	5	0.6	4	4	8	0.5
8:45-9:00		3	4	7	1.2	2	1	3	0.3	5	5	10	0.7
1時間計		18	10	28	4.9	13	2	15	1.7	31	12	43	2.9
9:00-9:15		4	6	10	1.7	1	3	4	0.4	5	9	14	0.9
9:15-9:30		14	7	21	3.7	8	3	11	1.2	22	10	32	2.2
9:30-9:45		5	4	9	1.6	3	0	3	0.3	8	4	12	0.8
9:45-10:00		3	5	8	1.4	4	6	10	1.1	7	11	18	1.2
1時間計		26	22	48	8.4	16	12	28	3.1	42	34	76	5.1
10:00-10:15		7	7	14	2.4	6	2	8	0.9	13	9	22	1.5
10:15-10:30		7	1	8	1.4	8	7	15	1.7	15	8	23	1.6
10:30-10:45		13	6	19	3.3	18	2	20	2.2	31	8	39	2.6
10:45-11:00		9	3	12	2.1	13	6	19	2.1	22	9	31	2.1
1時間計		36	17	53	9.2	45	17	62	6.9	81	34	115	7.8
11:00-11:15		7	3	10	1.7	5	1	6	0.7	12	4	16	1.1
11:15-11:30		13	0	13	2.3	7	3	10	1.1	20	3	23	1.6
11:30-11:45		9	7	16	2.8	8	11	19	2.1	17	18	35	2.4
11:45-12:00		9	3	12	2.1	15	5	20	2.2	24	8	32	2.2
1時間計		38	13	51	8.9	35	20	55	6.1	73	33	106	7.2
12:00-12:15		5	10	15	2.6	32	4	36	4.0	37	14	51	3.5
12:15-12:30		4	2	6	1.0	10	15	25	2.8	14	17	31	2.1
12:30-12:45		5	2	7	1.2	10	4	14	1.6	15	6	21	1.4
12:45-13:00		5	0	5	0.9	12	0	12	1.3	17	0	17	1.2
1時間計		19	14	33	5.7	64	23	87	9.6	83	37	120	8.1
13:00-13:15		11	1	12	2.1	8	5	13	1.4	19	6	25	1.7
13:15-13:30		4	1	5	0.9	14	4	18	2.0	18	5	23	1.6
13:30-13:45		10	3	13	2.3	11	0	11	1.2	21	3	24	1.6
13:45-14:00		20	15	35	6.1	8	3	11	1.2	28	18	46	3.1
1時間計		45	20	65	11.3	41	12	53	5.9	86	32	118	8.0

歩行者通行量調査表

調査地点：地域社会6 瀬谷中学校前

調査年月日：令和元年 5月11日(土) 天候：晴れ時々曇り



時間帯	ア				イ				合計			
	歩行者 (人)	自転車 (台)	合計 (人・台)	時間 係数 (%)	歩行者 (人)	自転車 (台)	合計 (人・台)	時間 係数 (%)	歩行者 (人)	自転車 (台)	合計 (人・台)	時間 係数 (%)
14:00-14:15	8	2	10	1.7	6	1	7	0.8	14	3	17	1.2
14:15-14:30	7	1	8	1.4	8	7	15	1.7	15	8	23	1.6
14:30-14:45	5	0	5	0.9	17	2	19	2.1	22	2	24	1.6
14:45-15:00	8	1	9	1.6	6	0	6	0.7	14	1	15	1.0
1時間計	28	4	32	5.6	37	10	47	5.2	65	14	79	5.3
15:00-15:15	10	2	12	2.1	12	8	20	2.2	22	10	32	2.2
15:15-15:30	9	1	10	1.7	11	6	17	1.9	20	7	27	1.8
15:30-15:45	10	3	13	2.3	12	5	17	1.9	22	8	30	2.0
15:45-16:00	4	3	7	1.2	7	3	10	1.1	11	6	17	1.2
1時間計	33	9	42	7.3	42	22	64	7.1	75	31	106	7.2
16:00-16:15	8	9	17	3.0	7	7	14	1.6	15	16	31	2.1
16:15-16:30	8	8	16	2.8	11	7	18	2.0	19	15	34	2.3
16:30-16:45	7	4	11	1.9	11	4	15	1.7	18	8	26	1.8
16:45-17:00	10	4	14	2.4	18	9	27	3.0	28	13	41	2.8
1時間計	33	25	58	10.1	47	27	74	8.2	80	52	132	8.9
17:00-17:15	11	2	13	2.3	19	2	21	2.3	30	4	34	2.3
17:15-17:30	1	0	1	0.2	20	2	22	2.4	21	2	23	1.6
17:30-17:45	2	1	3	0.5	16	6	22	2.4	18	7	25	1.7
17:45-18:00	6	0	6	1.0	13	4	17	1.9	19	4	23	1.6
1時間計	20	3	23	4.0	68	14	82	9.1	88	17	105	7.1
18:00-18:15	3	0	3	0.5	11	5	16	1.8	14	5	19	1.3
18:15-18:30	20	2	22	3.8	14	2	16	1.8	34	4	38	2.6
18:30-18:45	2	8	10	1.7	17	1	18	2.0	19	9	28	1.9
18:45-19:00	10	2	12	2.1	11	11	22	2.4	21	13	34	2.3
1時間計	35	12	47	8.2	53	19	72	8.0	88	31	119	8.1
19:00-19:15	5	2	7	1.2	13	2	15	1.7	18	4	22	1.5
19:15-19:30	1	2	3	0.5	15	5	20	2.2	16	7	23	1.6
19:30-19:45	2	1	3	0.5	6	0	6	0.7	8	1	9	0.6
19:45-20:00	6	2	8	1.4	8	0	8	0.9	14	2	16	1.1
1時間計	14	7	21	3.7	42	7	49	5.4	56	14	70	4.7
20:00-20:15	3	0	3	0.5	14	3	17	1.9	17	3	20	1.4
20:15-20:30	0	2	2	0.3	4	0	4	0.4	4	2	6	0.4
20:30-20:45	1	0	1	0.2	5	5	10	1.1	6	5	11	0.7
20:45-21:00	4	0	4	0.7	2	0	2	0.2	6	0	6	0.4
1時間計	8	2	10	1.7	25	8	33	3.7	33	10	43	2.9
21:00-21:15	0	1	1	0.2	7	1	8	0.9	7	2	9	0.6
21:15-21:30	0	0	0	0.0	2	1	3	0.3	2	1	3	0.2
21:30-21:45	1	0	1	0.2	3	1	4	0.4	4	1	5	0.3
21:45-22:00	0	0	0	0.0	9	0	9	1.0	9	0	9	0.6
1時間計	1	1	2	0.3	21	3	24	2.7	22	4	26	1.8
昼12時間計	342	159	501	87.3	481	181	662	73.3	823	340	1163	78.7
夜12時間計	54	19	73	12.7	203	38	241	26.7	257	57	314	21.3
全時間合計	396	178	574	100.0	684	219	903	100.0	1080	397	1477	100.0
昼夜率	1.16	1.12	1.15	-	1.42	1.21	1.36	-	1.31	1.17	1.27	-

歩行者通行量調査表

調査地点：地域社会6 瀬谷中学校前

調査年月日：令和元年 5月11日(土) 天候：晴れ時々曇り



時間帯	ウ				エ				合計			
	歩行者 (人)	自転車 (台)	合計 (人・台)	時間 係数 (%)	歩行者 (人)	自転車 (台)	合計 (人・台)	時間 係数 (%)	歩行者 (人)	自転車 (台)	合計 (人・台)	時間 係数 (%)
22:00-22:15	2	2	4	0.6	2	0	2	0.4	4	2	6	0.5
22:15-22:30	5	1	6	0.9	1	2	3	0.6	6	3	9	0.8
22:30-22:45	2	4	6	0.9	3	0	3	0.6	5	4	9	0.8
22:45-23:00	3	3	6	0.9	0	0	0	0.0	3	3	6	0.5
1時間計	12	10	22	3.4	6	2	8	1.5	18	12	30	2.5
23:00-23:15	6	1	7	1.1	0	0	0	0.0	6	1	7	0.6
23:15-23:30	3	6	9	1.4	1	1	2	0.4	4	7	11	0.9
23:30-23:45	4	3	7	1.1	1	0	1	0.2	5	3	8	0.7
23:45-24:00	2	0	2	0.3	0	0	0	0.0	2	0	2	0.2
1時間計	15	10	25	3.8	2	1	3	0.6	17	11	28	2.3
0:00-0:15	1	0	1	0.2	0	0	0	0.0	1	0	1	0.1
0:15-0:30	2	1	3	0.5	0	0	0	0.0	2	1	3	0.3
0:30-0:45	0	4	4	0.6	0	1	1	0.2	0	5	5	0.4
0:45-1:00	0	1	1	0.2	0	0	0	0.0	0	1	1	0.1
1時間計	3	6	9	1.4	0	1	1	0.2	3	7	10	0.8
1:00-1:15	0	1	1	0.2	0	0	0	0.0	0	1	1	0.1
1:15-1:30	0	0	0	0.0	0	0	0	0.0	0	0	0	0.0
1:30-1:45	0	0	0	0.0	0	0	0	0.0	0	0	0	0.0
1:45-2:00	0	0	0	0.0	2	0	2	0.4	2	0	2	0.2
1時間計	0	1	1	0.2	2	0	2	0.4	2	1	3	0.3
2:00-2:15	0	0	0	0.0	0	0	0	0.0	0	0	0	0.0
2:15-2:30	0	0	0	0.0	0	1	1	0.2	0	1	1	0.1
2:30-2:45	1	0	1	0.2	0	0	0	0.0	1	0	1	0.1
2:45-3:00	0	0	0	0.0	0	0	0	0.0	0	0	0	0.0
1時間計	1	0	1	0.2	0	1	1	0.2	1	1	2	0.2
3:00-3:15	0	0	0	0.0	0	0	0	0.0	0	0	0	0.0
3:15-3:30	0	0	0	0.0	0	0	0	0.0	0	0	0	0.0
3:30-3:45	0	0	0	0.0	0	0	0	0.0	0	0	0	0.0
3:45-4:00	1	0	1	0.2	0	0	0	0.0	1	0	1	0.1
1時間計	1	0	1	0.2	0	0	0	0.0	1	0	1	0.1
4:00-4:15	0	1	1	0.2	0	0	0	0.0	0	1	1	0.1
4:15-4:30	0	0	0	0.0	0	0	0	0.0	0	0	0	0.0
4:30-4:45	0	0	0	0.0	2	0	2	0.4	2	0	2	0.2
4:45-5:00	2	0	2	0.3	0	0	0	0.0	2	0	2	0.2
1時間計	2	1	3	0.5	2	0	2	0.4	4	1	5	0.4
5:00-5:15	2	0	2	0.3	2	0	2	0.4	4	0	4	0.3
5:15-5:30	1	2	3	0.5	1	0	1	0.2	2	2	4	0.3
5:30-5:45	1	0	1	0.2	1	0	1	0.2	2	0	2	0.2
5:45-6:00	1	0	1	0.2	1	0	1	0.2	2	0	2	0.2
1時間計	5	2	7	1.1	5	0	5	0.9	10	2	12	1.0

歩行者通行量調査表

調査地点：地域社会6 瀬谷中学校前

調査年月日：令和元年 5月11日(土) 天候：晴れ時々曇り



時間帯	ウ				I				合計			
	歩行者 (人)	自転車 (台)	合計 (人・台)	時間 係数 (%)	歩行者 (人)	自転車 (台)	合計 (人・台)	時間 係数 (%)	歩行者 (人)	自転車 (台)	合計 (人・台)	時間 係数 (%)
6:00-6:15	1	0	1	0.2	4	1	5	0.9	5	1	6	0.5
6:15-6:30	0	4	4	0.6	2	1	3	0.6	2	5	7	0.6
6:30-6:45	1	3	4	0.6	2	2	4	0.7	3	5	8	0.7
6:45-7:00	1	0	1	0.2	1	0	1	0.2	2	0	2	0.2
1時間計	3	7	10	1.5	9	4	13	2.4	12	11	23	1.9
7:00-7:15	4	3	7	1.1	3	0	3	0.6	7	3	10	0.8
7:15-7:30	0	0	0	0.0	3	0	3	0.6	3	0	3	0.3
7:30-7:45	4	1	5	0.8	5	0	5	0.9	9	1	10	0.8
7:45-8:00	0	3	3	0.5	2	3	5	0.9	2	6	8	0.7
1時間計	8	7	15	2.3	13	3	16	2.9	21	10	31	2.6
8:00-8:15	4	4	8	1.2	4	1	5	0.9	8	5	13	1.1
8:15-8:30	1	3	4	0.6	6	0	6	1.1	7	3	10	0.8
8:30-8:45	0	7	7	1.1	2	2	4	0.7	2	9	11	0.9
8:45-9:00	1	1	2	0.3	5	1	6	1.1	6	2	8	0.7
1時間計	6	15	21	3.2	17	4	21	3.9	23	19	42	3.5
9:00-9:15	4	3	7	1.1	5	4	9	1.7	9	7	16	1.3
9:15-9:30	7	6	13	2.0	6	3	9	1.7	13	9	22	1.8
9:30-9:45	1	1	2	0.3	15	1	16	2.9	16	2	18	1.5
9:45-10:00	5	6	11	1.7	6	4	10	1.8	11	10	21	1.8
1時間計	17	16	33	5.1	32	12	44	8.1	49	28	77	6.4
10:00-10:15	0	7	7	1.1	4	2	6	1.1	4	9	13	1.1
10:15-10:30	5	5	10	1.5	10	5	15	2.8	15	10	25	2.1
10:30-10:45	5	4	9	1.4	11	2	13	2.4	16	6	22	1.8
10:45-11:00	3	4	7	1.1	11	6	17	3.1	14	10	24	2.0
1時間計	13	20	33	5.1	36	15	51	9.4	49	35	84	7.0
11:00-11:15	6	7	13	2.0	4	5	9	1.7	10	12	22	1.8
11:15-11:30	1	4	5	0.8	1	4	5	0.9	2	8	10	0.8
11:30-11:45	3	7	10	1.5	8	12	20	3.7	11	19	30	2.5
11:45-12:00	0	2	2	0.3	6	1	7	1.3	6	3	9	0.8
1時間計	10	20	30	4.6	19	22	41	7.5	29	42	71	5.9
12:00-12:15	6	5	11	1.7	13	5	18	3.3	19	10	29	2.4
12:15-12:30	1	1	2	0.3	8	8	16	2.9	9	9	18	1.5
12:30-12:45	7	9	16	2.5	8	2	10	1.8	15	11	26	2.2
12:45-13:00	10	7	17	2.6	7	5	12	2.2	17	12	29	2.4
1時間計	24	22	46	7.1	36	20	56	10.3	60	42	102	8.5
13:00-13:15	16	7	23	3.5	10	7	17	3.1	26	14	40	3.3
13:15-13:30	12	11	23	3.5	5	6	11	2.0	17	17	34	2.8
13:30-13:45	10	9	19	2.9	5	2	7	1.3	15	11	26	2.2
13:45-14:00	8	1	9	1.4	8	4	12	2.2	16	5	21	1.8
1時間計	46	28	74	11.4	28	19	47	8.6	74	47	121	10.1

歩行者通行量調査表

調査地点：地域社会6 瀬谷中学校前

調査年月日：令和元年 5月11日(土) 天候：晴れ時々曇り



時間帯	ウ				I				合計			
	歩行者 (人)	自転車 (台)	合計 (人・台)	時間 係数 (%)	歩行者 (人)	自転車 (台)	合計 (人・台)	時間 係数 (%)	歩行者 (人)	自転車 (台)	合計 (人・台)	時間 係数 (%)
14:00-14:15	9	4	13	2.0	5	3	8	1.5	14	7	21	1.8
14:15-14:30	7	6	13	2.0	4	2	6	1.1	11	8	19	1.6
14:30-14:45	7	9	16	2.5	4	3	7	1.3	11	12	23	1.9
14:45-15:00	10	3	13	2.0	4	2	6	1.1	14	5	19	1.6
1時間計	33	22	55	8.4	17	10	27	5.0	50	32	82	6.9
15:00-15:15	10	0	10	1.5	9	2	11	2.0	19	2	21	1.8
15:15-15:30	10	11	21	3.2	6	8	14	2.6	16	19	35	2.9
15:30-15:45	8	1	9	1.4	1	0	1	0.2	9	1	10	0.8
15:45-16:00	9	8	17	2.6	2	4	6	1.1	11	12	23	1.9
1時間計	37	20	57	8.8	18	14	32	5.9	55	34	89	7.4
16:00-16:15	4	7	11	1.7	4	3	7	1.3	8	10	18	1.5
16:15-16:30	2	2	4	0.6	6	7	13	2.4	8	9	17	1.4
16:30-16:45	8	5	13	2.0	12	8	20	3.7	20	13	33	2.8
16:45-17:00	5	6	11	1.7	10	9	19	3.5	15	15	30	2.5
1時間計	19	20	39	6.0	32	27	59	10.8	51	47	98	8.2
17:00-17:15	4	4	8	1.2	17	7	24	4.4	21	11	32	2.7
17:15-17:30	4	7	11	1.7	11	5	16	2.9	15	12	27	2.3
17:30-17:45	8	1	9	1.4	3	3	6	1.1	11	4	15	1.3
17:45-18:00	8	5	13	2.0	13	5	18	3.3	21	10	31	2.6
1時間計	24	17	41	6.3	44	20	64	11.8	68	37	105	8.8
18:00-18:15	7	15	22	3.4	6	1	7	1.3	13	16	29	2.4
18:15-18:30	9	4	13	2.0	2	1	3	0.6	11	5	16	1.3
18:30-18:45	7	11	18	2.8	2	1	3	0.6	9	12	21	1.8
18:45-19:00	11	6	17	2.6	5	2	7	1.3	16	8	24	2.0
1時間計	34	36	70	10.8	15	5	20	3.7	49	41	90	7.5
19:00-19:15	7	4	11	1.7	2	2	4	0.7	9	6	15	1.3
19:15-19:30	7	5	12	1.8	9	0	9	1.7	16	5	21	1.8
19:30-19:45	7	4	11	1.7	4	1	5	0.9	11	5	16	1.3
19:45-20:00	3	4	7	1.1	3	2	5	0.9	6	6	12	1.0
1時間計	24	17	41	6.3	18	5	23	4.2	42	22	64	5.4
20:00-20:15	0	1	1	0.2	1	1	2	0.4	1	2	3	0.3
20:15-20:30	0	1	1	0.2	0	0	0	0.0	0	1	1	0.1
20:30-20:45	0	1	1	0.2	2	1	3	0.6	2	2	4	0.3
20:45-21:00	4	0	4	0.6	1	0	1	0.2	5	0	5	0.4
1時間計	4	3	7	1.1	4	2	6	1.1	8	5	13	1.1
21:00-21:15	1	4	5	0.8	0	0	0	0.0	1	4	5	0.4
21:15-21:30	1	1	2	0.3	2	0	2	0.4	3	1	4	0.3
21:30-21:45	0	0	0	0.0	0	0	0	0.0	0	0	0	0.0
21:45-22:00	3	0	3	0.5	0	0	0	0.0	3	0	3	0.3
1時間計	5	5	10	1.5	2	0	2	0.4	7	5	12	1.0
昼12時間計	271	243	514	79.0	307	171	478	87.9	578	414	992	83.0
夜12時間計	75	62	137	21.0	50	16	66	12.1	125	78	203	17.0
全時間合計	346	305	651	100.0	357	187	544	100.0	703	492	1195	100.0
昼夜率	1.28	1.26	1.27	-	1.16	1.09	1.14	-	1.22	1.19	1.20	-

歩行者通行量調査表

調査地点：地域社会6 瀬谷中学校前

調査年月日：令和元年 5月11日(土) 天候：晴れ時々曇り



時間帯	種別	ア				カ				合計			
		歩行者 (人)	自転車 (台)	合計 (人・台)	時間 係数 (%)	歩行者 (人)	自転車 (台)	合計 (人・台)	時間 係数 (%)	歩行者 (人)	自転車 (台)	合計 (人・台)	時間 係数 (%)
22:00-22:15		5	4	9	0.9	2	0	2	0.2	7	4	11	0.5
22:15-22:30		12	1	13	1.3	2	2	4	0.4	14	3	17	0.8
22:30-22:45		3	4	7	0.7	4	0	4	0.4	7	4	11	0.5
22:45-23:00		7	1	8	0.8	3	1	4	0.4	10	2	12	0.6
1時間計		27	10	37	3.8	11	3	14	1.3	38	13	51	2.5
23:00-23:15		5	0	5	0.5	3	2	5	0.5	8	2	10	0.5
23:15-23:30		4	1	5	0.5	1	0	1	0.1	5	1	6	0.3
23:30-23:45		5	2	7	0.7	2	1	3	0.3	7	3	10	0.5
23:45-24:00		9	2	11	1.1	1	0	1	0.1	10	2	12	0.6
1時間計		23	5	28	2.9	7	3	10	0.9	30	8	38	1.9
0:00-0:15		5	1	6	0.6	1	1	2	0.2	6	2	8	0.4
0:15-0:30		4	2	6	0.6	1	0	1	0.1	5	2	7	0.3
0:30-0:45		3	3	6	0.6	3	0	3	0.3	6	3	9	0.4
0:45-1:00		2	1	3	0.3	0	0	0	0.0	2	1	3	0.1
1時間計		14	7	21	2.1	5	1	6	0.6	19	8	27	1.3
1:00-1:15		0	0	0	0.0	2	0	2	0.2	2	0	2	0.1
1:15-1:30		0	0	0	0.0	0	0	0	0.0	0	0	0	0.0
1:30-1:45		2	1	3	0.3	1	0	1	0.1	3	1	4	0.2
1:45-2:00		0	0	0	0.0	2	0	2	0.2	2	0	2	0.1
1時間計		2	1	3	0.3	5	0	5	0.5	7	1	8	0.4
2:00-2:15		0	0	0	0.0	0	0	0	0.0	0	0	0	0.0
2:15-2:30		0	0	0	0.0	0	0	0	0.0	0	0	0	0.0
2:30-2:45		0	0	0	0.0	0	0	0	0.0	0	0	0	0.0
2:45-3:00		0	0	0	0.0	0	0	0	0.0	0	0	0	0.0
1時間計		0	0	0	0.0	0	0	0	0.0	0	0	0	0.0
3:00-3:15		1	0	1	0.1	0	0	0	0.0	1	0	1	0.0
3:15-3:30		0	0	0	0.0	0	0	0	0.0	0	0	0	0.0
3:30-3:45		0	0	0	0.0	0	0	0	0.0	0	0	0	0.0
3:45-4:00		0	0	0	0.0	0	0	0	0.0	0	0	0	0.0
1時間計		1	0	1	0.1	0	0	0	0.0	1	0	1	0.0
4:00-4:15		0	0	0	0.0	0	0	0	0.0	0	0	0	0.0
4:15-4:30		0	0	0	0.0	0	0	0	0.0	0	0	0	0.0
4:30-4:45		0	0	0	0.0	1	0	1	0.1	1	0	1	0.0
4:45-5:00		0	0	0	0.0	1	0	1	0.1	1	0	1	0.0
1時間計		0	0	0	0.0	2	0	2	0.2	2	0	2	0.1
5:00-5:15		0	0	0	0.0	0	0	0	0.0	0	0	0	0.0
5:15-5:30		0	0	0	0.0	2	0	2	0.2	2	0	2	0.1
5:30-5:45		0	0	0	0.0	4	0	4	0.4	4	0	4	0.2
5:45-6:00		1	0	1	0.1	1	0	1	0.1	2	0	2	0.1
1時間計		1	0	1	0.1	7	0	7	0.7	8	0	8	0.4

歩行者通行量調査表

調査地点：地域社会6 瀬谷中学校前

調査年月日：令和元年 5月11日(土) 天候：晴れ時々曇り



時間帯	方向				合計							
	歩行者 (人)	自転車 (台)	合計 (人・台)	時間 係数 (%)	歩行者 (人)	自転車 (台)	合計 (人・台)	時間 係数 (%)	歩行者 (人)	自転車 (台)	合計 (人・台)	時間 係数 (%)
6:00-6:15	1	0	1	0.1	6	4	10	0.9	7	4	11	0.5
6:15-6:30	3	0	3	0.3	4	1	5	0.5	7	1	8	0.4
6:30-6:45	0	1	1	0.1	5	0	5	0.5	5	1	6	0.3
6:45-7:00	0	1	1	0.1	1	0	1	0.1	1	1	2	0.1
1時間計	4	2	6	0.6	16	5	21	2.0	20	7	27	1.3
7:00-7:15	1	0	1	0.1	3	0	3	0.3	4	0	4	0.2
7:15-7:30	3	2	5	0.5	4	0	4	0.4	7	2	9	0.4
7:30-7:45	5	0	5	0.5	7	0	7	0.7	12	0	12	0.6
7:45-8:00	1	0	1	0.1	10	4	14	1.3	11	4	15	0.7
1時間計	10	2	12	1.2	24	4	28	2.6	34	6	40	1.9
8:00-8:15	1	0	1	0.1	6	5	11	1.0	7	5	12	0.6
8:15-8:30	0	1	1	0.1	15	3	18	1.7	15	4	19	0.9
8:30-8:45	1	4	5	0.5	12	3	15	1.4	13	7	20	1.0
8:45-9:00	0	0	0	0.0	10	6	16	1.5	10	6	16	0.8
1時間計	2	5	7	0.7	43	17	60	5.6	45	22	67	3.3
9:00-9:15	4	5	9	0.9	11	9	20	1.9	15	14	29	1.4
9:15-9:30	9	6	15	1.5	12	10	22	2.1	21	16	37	1.8
9:30-9:45	9	5	14	1.4	23	7	30	2.8	32	12	44	2.1
9:45-10:00	17	7	24	2.4	23	8	31	2.9	40	15	55	2.7
1時間計	39	23	62	6.3	69	34	103	9.6	108	57	165	8.0
10:00-10:15	12	4	16	1.6	17	7	24	2.2	29	11	40	1.9
10:15-10:30	10	11	21	2.1	20	8	28	2.6	30	19	49	2.4
10:30-10:45	11	10	21	2.1	17	6	23	2.1	28	16	44	2.1
10:45-11:00	10	6	16	1.6	18	11	29	2.7	28	17	45	2.2
1時間計	43	31	74	7.5	72	32	104	9.7	115	63	178	8.7
11:00-11:15	12	4	16	1.6	24	11	35	3.3	36	15	51	2.5
11:15-11:30	10	4	14	1.4	16	11	27	2.5	26	15	41	2.0
11:30-11:45	13	9	22	2.2	13	2	15	1.4	26	11	37	1.8
11:45-12:00	12	4	16	1.6	31	5	36	3.4	43	9	52	2.5
1時間計	47	21	68	6.9	84	29	113	10.6	131	50	181	8.8
12:00-12:15	9	4	13	1.3	18	4	22	2.1	27	8	35	1.7
12:15-12:30	9	8	17	1.7	14	4	18	1.7	23	12	35	1.7
12:30-12:45	15	4	19	1.9	16	4	20	1.9	31	8	39	1.9
12:45-13:00	16	5	21	2.1	7	4	11	1.0	23	9	32	1.6
1時間計	49	21	70	7.1	55	16	71	6.6	104	37	141	6.9
13:00-13:15	12	5	17	1.7	19	1	20	1.9	31	6	37	1.8
13:15-13:30	20	2	22	2.2	13	7	20	1.9	33	9	42	2.0
13:30-13:45	10	2	12	1.2	15	4	19	1.8	25	6	31	1.5
13:45-14:00	7	4	11	1.1	19	5	24	2.2	26	9	35	1.7
1時間計	49	13	62	6.3	66	17	83	7.7	115	30	145	7.1

歩行者通行量調査表

調査地点：地域社会6 瀬谷中学校前

調査年月日：令和元年 5月11日(土) 天候：晴れ時々曇り



時間帯	ア				カ				合計			
	歩行者 (人)	自転車 (台)	合計 (人・台)	時間 係数 (%)	歩行者 (人)	自転車 (台)	合計 (人・台)	時間 係数 (%)	歩行者 (人)	自転車 (台)	合計 (人・台)	時間 係数 (%)
14:00-14:15	12	5	17	1.7	10	1	11	1.0	22	6	28	1.4
14:15-14:30	13	3	16	1.6	13	3	16	1.5	26	6	32	1.6
14:30-14:45	14	8	22	2.2	14	4	18	1.7	28	12	40	1.9
14:45-15:00	11	7	18	1.8	8	7	15	1.4	19	14	33	1.6
1時間計	50	23	73	7.4	45	15	60	5.6	95	38	133	6.5
15:00-15:15	19	4	23	2.3	22	5	27	2.5	41	9	50	2.4
15:15-15:30	14	6	20	2.0	27	6	33	3.1	41	12	53	2.6
15:30-15:45	14	2	16	1.6	15	12	27	2.5	29	14	43	2.1
15:45-16:00	16	6	22	2.2	13	8	21	2.0	29	14	43	2.1
1時間計	63	18	81	8.3	77	31	108	10.1	140	49	189	9.2
16:00-16:15	13	5	18	1.8	10	6	16	1.5	23	11	34	1.7
16:15-16:30	21	9	30	3.1	17	9	26	2.4	38	18	56	2.7
16:30-16:45	17	16	33	3.4	23	6	29	2.7	40	22	62	3.0
16:45-17:00	11	7	18	1.8	13	6	19	1.8	24	13	37	1.8
1時間計	62	37	99	10.1	63	27	90	8.4	125	64	189	9.2
17:00-17:15	18	9	27	2.8	16	8	24	2.2	34	17	51	2.5
17:15-17:30	11	4	15	1.5	8	4	12	1.1	19	8	27	1.3
17:30-17:45	15	4	19	1.9	14	3	17	1.6	29	7	36	1.8
17:45-18:00	32	8	40	4.1	15	4	19	1.8	47	12	59	2.9
1時間計	76	25	101	10.3	53	19	72	6.7	129	44	173	8.4
18:00-18:15	11	11	22	2.2	11	1	12	1.1	22	12	34	1.7
18:15-18:30	22	4	26	2.7	8	2	10	0.9	30	6	36	1.8
18:30-18:45	13	4	17	1.7	5	0	5	0.5	18	4	22	1.1
18:45-19:00	10	3	13	1.3	11	0	11	1.0	21	3	24	1.2
1時間計	56	22	78	8.0	35	3	38	3.5	91	25	116	5.7
19:00-19:15	8	1	9	0.9	9	2	11	1.0	17	3	20	1.0
19:15-19:30	6	4	10	1.0	6	1	7	0.7	12	5	17	0.8
19:30-19:45	10	4	14	1.4	3	3	6	0.6	13	7	20	1.0
19:45-20:00	6	2	8	0.8	3	1	4	0.4	9	3	12	0.6
1時間計	30	11	41	4.2	21	7	28	2.6	51	18	69	3.4
20:00-20:15	5	4	9	0.9	10	5	15	1.4	15	9	24	1.2
20:15-20:30	2	0	2	0.2	4	0	4	0.4	6	0	6	0.3
20:30-20:45	2	1	3	0.3	2	1	3	0.3	4	2	6	0.3
20:45-21:00	9	1	10	1.0	4	6	10	0.9	13	7	20	1.0
1時間計	18	6	24	2.4	20	12	32	3.0	38	18	56	2.7
21:00-21:15	6	5	11	1.1	6	3	9	0.8	12	8	20	1.0
21:15-21:30	5	1	6	0.6	2	0	2	0.2	7	1	8	0.4
21:30-21:45	8	1	9	0.9	3	0	3	0.3	11	1	12	0.6
21:45-22:00	6	0	6	0.6	1	1	2	0.2	7	1	8	0.4
1時間計	25	7	32	3.3	12	4	16	1.5	37	11	48	2.3
昼12時間計	546	241	787	80.2	686	244	930	86.8	1232	485	1717	83.7
夜12時間計	145	49	194	19.8	106	35	141	13.2	251	84	335	16.3
全時間合計	691	290	981	100.0	792	279	1071	100.0	1483	569	2052	100.0
昼夜率	1.27	1.20	1.25	-	1.15	1.14	1.15	-	1.20	1.17	1.20	-

歩行者通行量調査表

調査地点：地域社会6 瀬谷中学校前

調査年月日：令和元年 5月11日(土) 天候：晴れ時々曇り



時間帯	キ				ク				合計			
	歩行者 (人)	自転車 (台)	合計 (人・台)	時間係数 (%)	歩行者 (人)	自転車 (台)	合計 (人・台)	時間係数 (%)	歩行者 (人)	自転車 (台)	合計 (人・台)	時間係数 (%)
22:00-22:15	1	1	2	0.2	0	0	0	0.0	1	1	2	0.1
22:15-22:30	2	1	3	0.3	2	4	6	0.8	4	5	9	0.5
22:30-22:45	0	3	3	0.3	0	0	0	0.0	0	3	3	0.2
22:45-23:00	0	0	0	0.0	10	2	12	1.6	10	2	12	0.6
1時間計	3	5	8	0.7	12	6	18	2.4	15	11	26	1.4
23:00-23:15	0	0	0	0.0	2	2	4	0.5	2	2	4	0.2
23:15-23:30	3	1	4	0.3	1	0	1	0.1	4	1	5	0.3
23:30-23:45	1	0	1	0.1	0	3	3	0.4	1	3	4	0.2
23:45-24:00	1	0	1	0.1	5	1	6	0.8	6	1	7	0.4
1時間計	5	1	6	0.5	8	6	14	1.8	13	7	20	1.0
0:00-0:15	1	0	1	0.1	2	1	3	0.4	3	1	4	0.2
0:15-0:30	1	0	1	0.1	4	0	4	0.5	5	0	5	0.3
0:30-0:45	0	0	0	0.0	1	1	2	0.3	1	1	2	0.1
0:45-1:00	0	0	0	0.0	3	1	4	0.5	3	1	4	0.2
1時間計	2	0	2	0.2	10	3	13	1.7	12	3	15	0.8
1:00-1:15	2	0	2	0.2	5	0	5	0.7	7	0	7	0.4
1:15-1:30	3	0	3	0.3	2	0	2	0.3	5	0	5	0.3
1:30-1:45	1	1	2	0.2	0	1	1	0.1	1	2	3	0.2
1:45-2:00	0	0	0	0.0	0	0	0	0.0	0	0	0	0.0
1時間計	6	1	7	0.6	7	1	8	1.1	13	2	15	0.8
2:00-2:15	0	0	0	0.0	1	0	1	0.1	1	0	1	0.1
2:15-2:30	0	0	0	0.0	0	0	0	0.0	0	0	0	0.0
2:30-2:45	0	0	0	0.0	0	0	0	0.0	0	0	0	0.0
2:45-3:00	0	0	0	0.0	1	0	1	0.1	1	0	1	0.1
1時間計	0	0	0	0.0	2	0	2	0.3	2	0	2	0.1
3:00-3:15	0	0	0	0.0	0	0	0	0.0	0	0	0	0.0
3:15-3:30	0	0	0	0.0	0	0	0	0.0	0	0	0	0.0
3:30-3:45	0	0	0	0.0	0	0	0	0.0	0	0	0	0.0
3:45-4:00	0	0	0	0.0	0	0	0	0.0	0	0	0	0.0
1時間計	0	0	0	0.0	0	0	0	0.0	0	0	0	0.0
4:00-4:15	0	0	0	0.0	0	0	0	0.0	0	0	0	0.0
4:15-4:30	0	0	0	0.0	0	0	0	0.0	0	0	0	0.0
4:30-4:45	0	0	0	0.0	0	0	0	0.0	0	0	0	0.0
4:45-5:00	0	0	0	0.0	1	0	1	0.1	1	0	1	0.1
1時間計	0	0	0	0.0	1	0	1	0.1	1	0	1	0.1
5:00-5:15	0	4	4	0.3	2	0	2	0.3	2	4	6	0.3
5:15-5:30	3	0	3	0.3	1	0	1	0.1	4	0	4	0.2
5:30-5:45	0	0	0	0.0	0	0	0	0.0	0	0	0	0.0
5:45-6:00	0	1	1	0.1	2	3	5	0.7	2	4	6	0.3
1時間計	3	5	8	0.7	5	3	8	1.1	8	8	16	0.8

歩行者通行量調査表

調査地点：地域社会6 瀬谷中学校前

調査年月日：令和元年 5月11日(土) 天候：晴れ時々曇り



時間帯	種別	キ				ク				合計			
		歩行者 (人)	自転車 (台)	合計 (人・台)	時間 係数 (%)	歩行者 (人)	自転車 (台)	合計 (人・台)	時間 係数 (%)	歩行者 (人)	自転車 (台)	合計 (人・台)	時間 係数 (%)
6:00-6:15		0	3	3	0.3	1	4	5	0.7	1	7	8	0.4
6:15-6:30		4	2	6	0.5	2	5	7	0.9	6	7	13	0.7
6:30-6:45		9	5	14	1.2	4	1	5	0.7	13	6	19	1.0
6:45-7:00		10	18	28	2.4	5	2	7	0.9	15	20	35	1.8
1時間計		23	28	51	4.4	12	12	24	3.2	35	40	75	3.9
7:00-7:15		12	4	16	1.4	9	3	12	1.6	21	7	28	1.5
7:15-7:30		10	8	18	1.6	15	2	17	2.2	25	10	35	1.8
7:30-7:45		8	14	22	1.9	7	1	8	1.1	15	15	30	1.6
7:45-8:00		8	6	14	1.2	5	3	8	1.1	13	9	22	1.1
1時間計		38	32	70	6.0	36	9	45	5.9	74	41	115	6.0
8:00-8:15		8	3	11	0.9	3	7	10	1.3	11	10	21	1.1
8:15-8:30		11	5	16	1.4	2	4	6	0.8	13	9	22	1.1
8:30-8:45		11	12	23	2.0	6	7	13	1.7	17	19	36	1.9
8:45-9:00		4	10	14	1.2	1	4	5	0.7	5	14	19	1.0
1時間計		34	30	64	5.5	12	22	34	4.5	46	52	98	5.1
9:00-9:15		12	20	32	2.8	7	3	10	1.3	19	23	42	2.2
9:15-9:30		16	10	26	2.2	3	3	6	0.8	19	13	32	1.7
9:30-9:45		12	17	29	2.5	4	6	10	1.3	16	23	39	2.0
9:45-10:00		16	14	30	2.6	5	2	7	0.9	21	16	37	1.9
1時間計		56	61	117	10.1	19	14	33	4.3	75	75	150	7.8
10:00-10:15		7	10	17	1.5	4	1	5	0.7	11	11	22	1.1
10:15-10:30		18	14	32	2.8	9	6	15	2.0	27	20	47	2.5
10:30-10:45		7	9	16	1.4	3	3	6	0.8	10	12	22	1.1
10:45-11:00		14	1	15	1.3	3	3	6	0.8	17	4	21	1.1
1時間計		46	34	80	6.9	19	13	32	4.2	65	47	112	5.8
11:00-11:15		13	11	24	2.1	11	7	18	2.4	24	18	42	2.2
11:15-11:30		15	6	21	1.8	3	1	4	0.5	18	7	25	1.3
11:30-11:45		11	3	14	1.2	6	7	13	1.7	17	10	27	1.4
11:45-12:00		22	8	30	2.6	10	8	18	2.4	32	16	48	2.5
1時間計		61	28	89	7.7	30	23	53	7.0	91	51	142	7.4
12:00-12:15		8	8	16	1.4	17	4	21	2.8	25	12	37	1.9
12:15-12:30		18	12	30	2.6	7	5	12	1.6	25	17	42	2.2
12:30-12:45		17	4	21	1.8	6	1	7	0.9	23	5	28	1.5
12:45-13:00		15	5	20	1.7	7	2	9	1.2	22	7	29	1.5
1時間計		58	29	87	7.5	37	12	49	6.5	95	41	136	7.1
13:00-13:15		22	5	27	2.3	8	11	19	2.5	30	16	46	2.4
13:15-13:30		28	5	33	2.8	7	5	12	1.6	35	10	45	2.3
13:30-13:45		26	5	31	2.7	4	3	7	0.9	30	8	38	2.0
13:45-14:00		16	1	17	1.5	8	7	15	2.0	24	8	32	1.7
1時間計		92	16	108	9.3	27	26	53	7.0	119	42	161	8.4

歩行者通行量調査表

調査地点：地域社会6 瀬谷中学校前

調査年月日：令和元年 5月11日(土) 天候：晴れ時々曇り



時間帯	方向	キ				ク				合計			
		歩行者 (人)	自転車 (台)	合計 (人・台)	時間 係数 (%)	歩行者 (人)	自転車 (台)	合計 (人・台)	時間 係数 (%)	歩行者 (人)	自転車 (台)	合計 (人・台)	時間 係数 (%)
14:00-14:15		28	6	34	2.9	4	3	7	0.9	32	9	41	2.1
14:15-14:30		15	7	22	1.9	5	3	8	1.1	20	10	30	1.6
14:30-14:45		12	8	20	1.7	10	3	13	1.7	22	11	33	1.7
14:45-15:00		11	7	18	1.6	3	14	17	2.2	14	21	35	1.8
1時間計		66	28	94	8.1	22	23	45	5.9	88	51	139	7.3
15:00-15:15		7	3	10	0.9	7	8	15	2.0	14	11	25	1.3
15:15-15:30		15	11	26	2.2	11	4	15	2.0	26	15	41	2.1
15:30-15:45		7	4	11	0.9	7	2	9	1.2	14	6	20	1.0
15:45-16:00		7	10	17	1.5	9	9	18	2.4	16	19	35	1.8
1時間計		36	28	64	5.5	34	23	57	7.5	70	51	121	6.3
16:00-16:15		8	9	17	1.5	9	9	18	2.4	17	18	35	1.8
16:15-16:30		6	17	23	2.0	8	9	17	2.2	14	26	40	2.1
16:30-16:45		7	8	15	1.3	6	8	14	1.8	13	16	29	1.5
16:45-17:00		9	4	13	1.1	8	8	16	2.1	17	12	29	1.5
1時間計		30	38	68	5.9	31	34	65	8.6	61	72	133	6.9
17:00-17:15		21	12	33	2.8	26	8	34	4.5	47	20	67	3.5
17:15-17:30		14	8	22	1.9	8	5	13	1.7	22	13	35	1.8
17:30-17:45		14	5	19	1.6	11	3	14	1.8	25	8	33	1.7
17:45-18:00		7	2	9	0.8	5	4	9	1.2	12	6	18	0.9
1時間計		56	27	83	7.2	50	20	70	9.2	106	47	153	8.0
18:00-18:15		10	13	23	2.0	7	11	18	2.4	17	24	41	2.1
18:15-18:30		30	3	33	2.8	4	9	13	1.7	34	12	46	2.4
18:30-18:45		4	5	9	0.8	6	2	8	1.1	10	7	17	0.9
18:45-19:00		6	10	16	1.4	7	7	14	1.8	13	17	30	1.6
1時間計		60	31	91	7.0	24	29	53	7.0	74	60	134	7.0
19:00-19:15		29	5	34	2.9	12	2	14	1.8	41	7	48	2.5
19:15-19:30		4	4	8	0.7	8	3	11	1.4	12	7	19	1.0
19:30-19:45		3	5	8	0.7	7	7	14	1.8	10	12	22	1.1
19:45-20:00		1	1	2	0.2	3	5	8	1.1	4	6	10	0.5
1時間計		37	15	52	4.5	30	17	47	6.2	67	32	99	5.2
20:00-20:15		1	1	2	0.2	1	2	3	0.4	2	3	5	0.3
20:15-20:30		5	2	7	0.6	2	2	4	0.5	7	4	11	0.6
20:30-20:45		3	0	3	0.3	3	4	7	0.9	6	4	10	0.5
20:45-21:00		1	0	1	0.1	7	4	11	1.4	8	4	12	0.6
1時間計		10	3	13	1.1	13	12	25	3.3	23	15	38	2.0
21:00-21:15		1	0	1	0.1	1	2	3	0.4	2	2	4	0.2
21:15-21:30		2	0	2	0.2	1	1	2	0.3	3	1	4	0.2
21:30-21:45		1	1	2	0.2	1	0	1	0.1	2	1	3	0.2
21:45-22:00		1	0	1	0.1	3	1	4	0.5	4	1	5	0.3
1時間計		5	1	6	0.5	6	4	10	1.3	11	5	16	0.8
昼12時間計		623	382	1005	86.8	341	248	589	77.6	964	630	1594	83.2
夜12時間計		94	59	153	13.2	106	64	170	22.4	200	123	323	16.8
全時間合計		717	441	1158	100.0	447	312	759	100.0	1164	753	1917	100.0
昼夜率		1.15	1.15	1.15	-	1.31	1.26	1.29	-	1.21	1.20	1.20	-

歩行者通行量調査表

調査地点：地域社会6 瀬谷中学校前

調査年月日：令和元年 5月11日(土) 天候：晴れ時々曇り



時間帯	方向	合計 (7+イ+ウ+エ+オ+カ+キ+ク)			時間係数 (%)
		歩行者 (人)	自転車 (台)	合計 (人・台)	
22:00-22:15		26	9	35	0.5
22:15-22:30		46	16	62	0.9
22:30-22:45		19	11	30	0.5
22:45-23:00		33	8	41	0.6
1時間計		124	44	168	2.5
23:00-23:15		23	5	28	0.4
23:15-23:30		21	10	31	0.5
23:30-23:45		17	10	27	0.4
23:45-24:00		26	5	31	0.5
1時間計		87	30	117	1.8
0:00-0:15		16	3	19	0.3
0:15-0:30		20	3	23	0.3
0:30-0:45		12	9	21	0.3
0:45-1:00		13	5	18	0.3
1時間計		61	20	81	1.2
1:00-1:15		13	1	14	0.2
1:15-1:30		7	2	9	0.1
1:30-1:45		7	3	10	0.2
1:45-2:00		6	0	6	0.1
1時間計		33	6	39	0.6
2:00-2:15		2	1	3	0.0
2:15-2:30		1	1	2	0.0
2:30-2:45		1	0	1	0.0
2:45-3:00		4	0	4	0.1
1時間計		8	2	10	0.2
3:00-3:15		1	0	1	0.0
3:15-3:30		0	0	0	0.0
3:30-3:45		1	0	1	0.0
3:45-4:00		1	0	1	0.0
1時間計		3	0	3	0.0
4:00-4:15		0	1	1	0.0
4:15-4:30		1	1	2	0.0
4:30-4:45		3	0	3	0.0
4:45-5:00		4	0	4	0.1
1時間計		8	2	10	0.2
5:00-5:15		6	4	10	0.2
5:15-5:30		10	2	12	0.2
5:30-5:45		6	0	6	0.1
5:45-6:00		10	5	15	0.2
1時間計		32	11	43	0.6
6:00-6:15		16	12	28	0.4
6:15-6:30		18	16	34	0.5
6:30-6:45		23	17	40	0.6
6:45-7:00		25	23	48	0.7
1時間計		82	68	150	2.3
7:00-7:15		43	11	54	0.8
7:15-7:30		45	14	59	0.9
7:30-7:45		38	21	59	0.9
7:45-8:00		34	24	58	0.9
1時間計		160	70	230	3.5
8:00-8:15		41	21	62	0.9
8:15-8:30		42	18	60	0.9
8:30-8:45		36	39	75	1.1
8:45-9:00		26	27	53	0.8
1時間計		145	105	250	3.8
9:00-9:15		48	53	101	1.5
9:15-9:30		75	48	123	1.9
9:30-9:45		72	41	113	1.7
9:45-10:00		79	52	131	2.0
1時間計		274	194	468	7.0

時間帯	方向	合計 (7+イ+ウ+エ+オ+カ+キ+ク)			時間係数 (%)
		歩行者 (人)	自転車 (台)	合計 (人・台)	
22:00-23:00		124	44	168	2.5
22:15-23:15		121	40	161	2.4
22:30-23:30		96	34	130	2.0
22:45-23:45		94	33	127	1.9
23:00-0:00		87	30	117	1.8
23:15-0:15		80	28	108	1.6
23:30-0:30		79	21	100	1.5
23:45-0:45		74	20	94	1.4
0:00-1:00		61	20	81	1.2
0:15-1:15		58	18	76	1.1
0:30-1:30		45	17	62	0.9
0:45-1:45		40	11	51	0.8
1:00-2:00		33	6	39	0.6
1:15-2:15		22	6	28	0.4
1:30-2:30		16	5	21	0.3
1:45-2:45		10	2	12	0.2
2:00-3:00		8	2	10	0.2
2:15-3:15		7	1	8	0.1
2:30-3:30		6	0	6	0.1
2:45-3:45		6	0	6	0.1
3:00-4:00		3	0	3	0.0
3:15-4:15		2	1	3	0.0
3:30-4:30		3	2	5	0.1
3:45-4:45		5	2	7	0.1
4:00-5:00		8	2	10	0.2
4:15-5:15		14	5	19	0.3
4:30-5:30		23	6	29	0.4
4:45-5:45		26	6	32	0.5
5:00-6:00		32	11	43	0.6
5:15-6:15		42	19	61	0.9
5:30-6:30		50	33	83	1.2
5:45-6:45		67	50	117	1.8
6:00-7:00		82	68	150	2.3
6:15-7:15		109	67	176	2.7
6:30-7:30		136	65	201	3.0
6:45-7:45		151	69	220	3.3
7:00-8:00		160	70	230	3.5
7:15-8:15		158	80	238	3.6
7:30-8:30		155	84	239	3.6
7:45-8:45		153	102	255	3.8
8:00-9:00		145	105	250	3.8
8:15-9:15		152	137	289	4.4
8:30-9:30		185	167	352	5.3
8:45-9:45		221	169	390	5.9
9:00-10:00		274	194	468	7.0
9:15-10:15		283	181	464	7.0
9:30-10:30		295	190	485	7.3
9:45-10:45		308	191	499	7.5
10:00-11:00		310	179	489	7.4
10:15-11:15		335	188	523	7.9
10:30-11:30		314	164	478	7.2
10:45-11:45		300	180	480	7.2
11:00-12:00		324	176	500	7.5
11:15-12:15		350	171	521	7.8
11:30-12:30		355	193	548	8.3
11:45-12:45		368	165	533	8.0
12:00-13:00		342	157	499	7.5
12:15-13:15		340	155	495	7.5
12:30-13:30		372	141	513	7.7
12:45-13:45		379	139	518	7.8

歩行者通行量調査表

調査地点：地域社会6 瀬谷中学校前

調査年月日：令和元年 5月11日(土) 天候：晴れ時々曇り



時間帯	種別	合計 (7+イ+ウ+エ+オ+カ+キ+ク)			時間係数 (%)
		歩行者 (人)	自転車 (台)	合計 (人・台)	
10:00-10:15		57	40	97	1.5
10:15-10:30		87	57	144	2.2
10:30-10:45		85	42	127	1.9
10:45-11:00		81	40	121	1.8
1時間計		310	179	489	7.4
11:00-11:15		82	49	131	2.0
11:15-11:30		66	33	99	1.5
11:30-11:45		71	58	129	1.9
11:45-12:00		105	36	141	2.1
1時間計		324	178	500	7.5
12:00-12:15		108	44	152	2.3
12:15-12:30		71	55	126	1.9
12:30-12:45		84	30	114	1.7
12:45-13:00		79	28	107	1.6
1時間計		342	157	499	7.5
13:00-13:15		106	42	148	2.2
13:15-13:30		103	41	144	2.2
13:30-13:45		91	28	119	1.8
13:45-14:00		94	40	134	2.0
1時間計		394	151	545	8.2
14:00-14:15		82	25	107	1.6
14:15-14:30		72	32	104	1.6
14:30-14:45		83	37	120	1.8
14:45-15:00		61	41	102	1.5
1時間計		298	135	433	6.5
15:00-15:15		96	32	128	1.9
15:15-15:30		103	53	156	2.3
15:30-15:45		74	29	103	1.6
15:45-16:00		67	51	118	1.8
1時間計		340	165	505	7.6
16:00-16:15		63	55	118	1.8
16:15-16:30		79	68	147	2.2
16:30-16:45		91	59	150	2.3
16:45-17:00		84	53	137	2.1
1時間計		317	235	552	8.3
17:00-17:15		132	52	184	2.8
17:15-17:30		77	35	112	1.7
17:30-17:45		83	26	109	1.6
17:45-18:00		99	32	131	2.0
1時間計		391	145	536	8.1
18:00-18:15		66	57	123	1.9
18:15-18:30		109	27	136	2.0
18:30-18:45		56	32	88	1.3
18:45-19:00		71	41	112	1.7
1時間計		302	157	459	6.9
19:00-19:15		85	20	105	1.6
19:15-19:30		56	24	80	1.2
19:30-19:45		42	25	67	1.0
19:45-20:00		33	17	50	0.8
1時間計		216	86	302	4.5
20:00-20:15		35	17	52	0.8
20:15-20:30		17	7	24	0.4
20:30-20:45		18	13	31	0.5
20:45-21:00		32	11	43	0.6
1時間計		102	48	150	2.3
21:00-21:15		22	16	38	0.6
21:15-21:30		15	4	19	0.3
21:30-21:45		17	3	20	0.3
21:45-22:00		23	2	25	0.4
1時間計		77	25	102	1.5
昼12時間計		3597	1869	5466	82.3
夜12時間計		833	342	1175	17.7
全時間合計		4430	2211	6641	100.0
昼夜率		1.23	1.18	1.21	-

時間帯	種別	合計 (7+イ+ウ+エ+オ+カ+キ+ク)			時間係数 (%)
		歩行者 (人)	自転車 (台)	合計 (人・台)	
13:00-14:00		394	151	545	8.2
13:15-14:15		370	134	504	7.6
13:30-14:30		339	125	464	7.0
13:45-14:45		331	134	465	7.0
14:00-15:00		298	135	433	6.5
14:15-15:15		312	142	454	6.8
14:30-15:30		343	163	506	7.6
14:45-15:45		334	155	489	7.4
15:00-16:00		340	165	505	7.6
15:15-16:15		307	188	495	7.5
15:30-16:30		283	203	486	7.3
15:45-16:45		300	233	533	8.0
16:00-17:00		317	235	552	8.3
16:15-17:15		386	232	618	9.3
16:30-17:30		384	199	583	8.8
16:45-17:45		376	166	542	8.2
17:00-18:00		391	145	536	8.1
17:15-18:15		325	150	475	7.2
17:30-18:30		357	142	499	7.5
17:45-18:45		330	148	478	7.2
18:00-19:00		302	157	459	6.9
18:15-19:15		321	120	441	6.6
18:30-19:30		268	117	385	5.8
18:45-19:45		254	110	364	5.5
19:00-20:00		216	86	302	4.5
19:15-20:15		166	83	249	3.7
19:30-20:30		127	66	193	2.9
19:45-20:45		103	54	157	2.4
20:00-21:00		102	48	150	2.3
20:15-21:15		89	47	136	2.0
20:30-21:30		87	44	131	2.0
20:45-21:45		86	34	120	1.8
21:00-22:00		77	25	102	1.5
全時間合計		4,430	2,211	6,641	100.0

歩行者通行量調査表

調査地点：地域社会1 目黒

調査年月日：令和元年10月13日(日) 天候：曇りのち雨

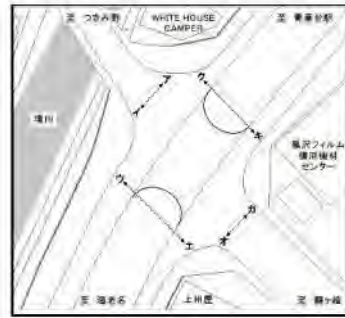

時間帯	ア				イ				合計			
	歩行者 (人)	自転車 (台)	合計 (人・台)	時間 係数 (%)	歩行者 (人)	自転車 (台)	合計 (人・台)	時間 係数 (%)	歩行者 (人)	自転車 (台)	合計 (人・台)	時間 係数 (%)
22:00-22:15	0	0	0	0.0	1	0	1	0.8	1	0	1	0.4
22:15-22:30	0	0	0	0.0	0	0	0	0.0	0	0	0	0.0
22:30-22:45	0	0	0	0.0	0	0	0	0.0	0	0	0	0.0
22:45-23:00	0	0	0	0.0	0	0	0	0.0	0	0	0	0.0
1時間計	0	0	0	0.0	1	0	1	0.8	1	0	1	0.4
23:00-23:15	0	1	1	0.7	0	0	0	0.0	0	1	1	0.4
23:15-23:30	2	0	2	1.4	1	0	1	0.8	3	0	3	1.1
23:30-23:45	0	0	0	0.0	0	1	1	0.8	0	1	1	0.4
23:45-24:00	0	3	3	2.0	1	0	1	0.8	1	3	4	1.5
1時間計	2	4	6	4.1	2	1	3	2.4	4	5	9	3.3
0:00-0:15	1	0	1	0.7	3	0	3	2.4	4	0	4	1.5
0:15-0:30	0	1	1	0.7	0	0	0	0.0	0	1	1	0.4
0:30-0:45	0	0	0	0.0	0	0	0	0.0	0	0	0	0.0
0:45-1:00	0	0	0	0.0	0	0	0	0.0	0	0	0	0.0
1時間計	1	1	2	1.4	3	0	3	2.4	4	1	5	1.8
1:00-1:15	0	0	0	0.0	0	0	0	0.0	0	0	0	0.0
1:15-1:30	0	0	0	0.0	0	0	0	0.0	0	0	0	0.0
1:30-1:45	0	0	0	0.0	0	1	1	0.8	0	1	1	0.4
1:45-2:00	0	0	0	0.0	0	0	0	0.0	0	0	0	0.0
1時間計	0	0	0	0.0	0	1	1	0.8	0	1	1	0.4
2:00-2:15	0	0	0	0.0	0	0	0	0.0	0	0	0	0.0
2:15-2:30	1	0	1	0.7	0	0	0	0.0	1	0	1	0.4
2:30-2:45	0	0	0	0.0	0	1	1	0.8	0	1	1	0.4
2:45-3:00	0	1	1	0.7	0	0	0	0.0	0	1	1	0.4
1時間計	1	1	2	1.4	0	1	1	0.8	1	2	3	1.1
3:00-3:15	0	0	0	0.0	0	0	0	0.0	0	0	0	0.0
3:15-3:30	0	1	1	0.7	0	0	0	0.0	0	1	1	0.4
3:30-3:45	0	0	0	0.0	0	0	0	0.0	0	0	0	0.0
3:45-4:00	0	0	0	0.0	0	0	0	0.0	0	0	0	0.0
1時間計	0	1	1	0.7	0	0	0	0.0	0	1	1	0.4
4:00-4:15	0	0	0	0.0	0	0	0	0.0	0	0	0	0.0
4:15-4:30	0	0	0	0.0	0	1	1	0.8	0	1	1	0.4
4:30-4:45	0	0	0	0.0	0	1	1	0.8	0	1	1	0.4
4:45-5:00	0	0	0	0.0	0	2	2	1.6	0	2	2	0.7
1時間計	0	0	0	0.0	0	4	4	3.2	0	4	4	1.5
5:00-5:15	0	0	0	0.0	0	1	1	0.8	0	1	1	0.4
5:15-5:30	0	1	1	0.7	0	0	0	0.0	0	1	1	0.4
5:30-5:45	3	0	3	2.0	1	1	2	1.6	4	1	5	1.8
5:45-6:00	0	0	0	0.0	1	1	2	1.6	1	1	2	0.7
1時間計	3	1	4	2.7	2	3	5	4.0	5	4	9	3.3

歩行者通行量調査表

調査地点：地域社会1 目黒

調査年月日：令和元年10月13日(日) 天候：曇りのち雨

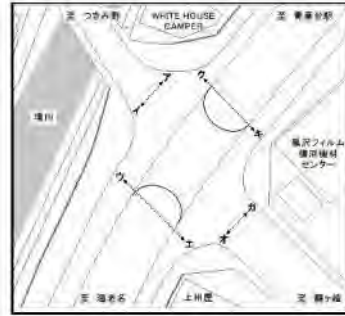

時間帯	ア				イ				合計			
	歩行者 (人)	自転車 (台)	合計 (人・台)	時間 係数 (%)	歩行者 (人)	自転車 (台)	合計 (人・台)	時間 係数 (%)	歩行者 (人)	自転車 (台)	合計 (人・台)	時間 係数 (%)
6:00-6:15	1	0	1	0.7	0	0	0	0.0	1	0	1	0.4
6:15-6:30	0	0	0	0.0	0	0	0	0.0	0	0	0	0.0
6:30-6:45	0	1	1	0.7	1	0	1	0.8	1	1	2	0.7
6:45-7:00	1	5	6	4.1	1	3	4	3.2	2	8	10	3.7
1時間計	2	6	8	5.4	2	3	5	4.0	4	9	13	4.8
7:00-7:15	1	1	2	1.4	1	5	6	4.8	2	6	8	3.0
7:15-7:30	0	0	0	0.0	2	0	2	1.6	2	0	2	0.7
7:30-7:45	0	3	3	2.0	0	2	2	1.6	0	5	5	1.8
7:45-8:00	3	0	3	2.0	2	0	2	1.6	5	0	5	1.8
1時間計	4	4	8	5.4	5	7	12	9.7	9	11	20	7.4
8:00-8:15	1	1	2	1.4	2	1	3	2.4	3	2	5	1.8
8:15-8:30	3	1	4	2.7	5	3	8	6.5	8	4	12	4.4
8:30-8:45	2	2	4	2.7	0	0	0	0.0	2	2	4	1.5
8:45-9:00	1	5	6	4.1	4	5	9	7.3	5	10	15	5.5
1時間計	7	9	16	10.9	11	9	20	16.1	18	18	36	13.3
9:00-9:15	2	1	3	2.0	1	0	1	0.8	3	1	4	1.5
9:15-9:30	0	1	1	0.7	0	1	1	0.8	0	2	2	0.7
9:30-9:45	1	5	6	4.1	1	0	1	0.8	2	5	7	2.6
9:45-10:00	0	0	0	0.0	0	2	2	1.6	0	2	2	0.7
1時間計	3	7	10	6.8	2	3	5	4.0	5	10	15	5.5
10:00-10:15	1	0	1	0.7	1	0	1	0.8	2	0	2	0.7
10:15-10:30	1	0	1	0.7	0	1	1	0.8	1	1	2	0.7
10:30-10:45	0	0	0	0.0	2	2	4	3.2	2	2	4	1.5
10:45-11:00	3	0	3	2.0	0	0	0	0.0	3	0	3	1.1
1時間計	5	0	5	3.4	3	3	6	4.8	8	3	11	4.1
11:00-11:15	0	0	0	0.0	0	0	0	0.0	0	0	0	0.0
11:15-11:30	1	3	4	2.7	1	0	1	0.8	2	3	5	1.8
11:30-11:45	1	1	2	1.4	3	1	4	3.2	4	2	6	2.2
11:45-12:00	2	2	4	2.7	0	2	2	1.6	2	4	6	2.2
1時間計	4	6	10	6.8	4	3	7	5.6	8	9	17	6.3
12:00-12:15	0	1	1	0.7	0	1	1	0.8	0	2	2	0.7
12:15-12:30	1	0	1	0.7	0	0	0	0.0	1	0	1	0.4
12:30-12:45	1	0	1	0.7	0	0	0	0.0	1	0	1	0.4
12:45-13:00	1	0	1	0.7	2	1	3	2.4	3	1	4	1.5
1時間計	3	1	4	2.7	2	2	4	3.2	5	3	8	3.0
13:00-13:15	0	1	1	0.7	1	0	1	0.8	1	1	2	0.7
13:15-13:30	2	3	5	3.4	1	1	2	1.6	3	4	7	2.6
13:30-13:45	1	2	3	2.0	0	1	1	0.8	1	3	4	1.5
13:45-14:00	2	4	6	4.1	0	0	0	0.0	2	4	6	2.2
1時間計	5	10	15	10.2	2	2	4	3.2	7	12	19	7.0

歩行者通行量調査表

調査地点：地域社会1 目黒

調査年月日：令和元年10月13日(日) 天候：曇りのち雨

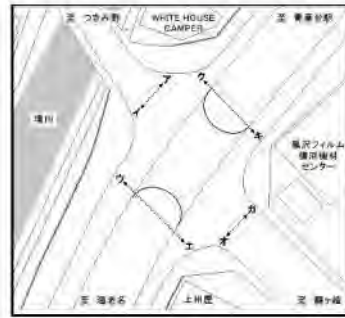

時間帯	ア				イ				合計			
	歩行者 (人)	自転車 (台)	合計 (人・台)	時間 係数 (%)	歩行者 (人)	自転車 (台)	合計 (人・台)	時間 係数 (%)	歩行者 (人)	自転車 (台)	合計 (人・台)	時間 係数 (%)
14:00-14:15	0	0	0	0.0	0	0	0	0.0	0	0	0	0.0
14:15-14:30	3	0	3	2.0	1	0	1	0.8	4	0	4	1.5
14:30-14:45	1	0	1	0.7	0	0	0	0.0	1	0	1	0.4
14:45-15:00	1	1	2	1.4	1	0	1	0.8	2	1	3	1.1
1時間計	5	1	6	4.1	2	0	2	1.6	7	1	8	3.0
15:00-15:15	1	4	5	3.4	0	1	1	0.8	1	5	6	2.2
15:15-15:30	0	0	0	0.0	0	0	0	0.0	0	0	0	0.0
15:30-15:45	0	1	1	0.7	0	0	0	0.0	0	1	1	0.4
15:45-16:00	1	3	4	2.7	1	1	2	1.6	2	4	6	2.2
1時間計	2	8	10	6.8	1	2	3	2.4	3	10	13	4.8
16:00-16:15	0	0	0	0.0	2	1	3	2.4	2	1	3	1.1
16:15-16:30	0	0	0	0.0	0	0	0	0.0	0	0	0	0.0
16:30-16:45	2	2	4	2.7	0	0	0	0.0	2	2	4	1.5
16:45-17:00	5	2	7	4.8	2	2	4	3.2	7	4	11	4.1
1時間計	7	4	11	7.5	4	3	7	5.6	11	7	18	6.6
17:00-17:15	0	0	0	0.0	2	4	6	4.8	2	4	6	2.2
17:15-17:30	2	1	3	2.0	0	1	1	0.8	2	2	4	1.5
17:30-17:45	0	0	0	0.0	1	0	1	0.8	1	0	1	0.4
17:45-18:00	1	1	2	1.4	0	2	2	1.6	1	3	4	1.5
1時間計	3	2	5	3.4	3	7	10	8.1	6	9	15	5.5
18:00-18:15	2	1	3	2.0	3	3	6	4.8	5	4	9	3.3
18:15-18:30	1	0	1	0.7	0	2	2	1.6	1	2	3	1.1
18:30-18:45	0	2	2	1.4	1	0	1	0.8	1	2	3	1.1
18:45-19:00	1	0	1	0.7	0	0	0	0.0	1	0	1	0.4
1時間計	4	3	7	4.8	4	5	9	7.3	8	8	16	5.9
19:00-19:15	3	0	3	2.0	2	0	2	1.6	5	0	5	1.8
19:15-19:30	1	0	1	0.7	0	0	0	0.0	1	0	1	0.4
19:30-19:45	0	1	1	0.7	1	1	2	1.6	1	2	3	1.1
19:45-20:00	1	0	1	0.7	1	1	2	1.6	2	1	3	1.1
1時間計	5	1	6	4.1	4	2	6	4.8	9	3	12	4.4
20:00-20:15	0	1	1	0.7	0	0	0	0.0	0	1	1	0.4
20:15-20:30	0	0	0	0.0	1	1	2	1.6	1	1	2	0.7
20:30-20:45	1	1	2	1.4	0	0	0	0.0	1	1	2	0.7
20:45-21:00	0	1	1	0.7	0	1	1	0.8	0	2	2	0.7
1時間計	1	3	4	2.7	1	2	3	2.4	2	5	7	2.6
21:00-21:15	1	0	1	0.7	0	0	0	0.0	1	0	1	0.4
21:15-21:30	2	2	4	2.7	1	1	2	1.6	3	3	6	2.2
21:30-21:45	2	0	2	1.4	1	0	1	0.8	3	0	3	1.1
21:45-22:00	0	0	0	0.0	0	0	0	0.0	0	0	0	0.0
1時間計	5	2	7	4.8	2	1	3	2.4	7	3	10	3.7
昼12時間計	52	55	107	72.8	43	46	89	71.8	95	101	196	72.3
夜12時間計	20	20	40	27.2	17	18	35	28.2	37	38	75	27.7
全時間合計	72	75	147	100.0	60	64	124	100.0	132	139	271	100.0
昼夜率	1.38	1.36	1.37	-	1.40	1.39	1.39	-	1.39	1.38	1.38	-

歩行者通行量調査表

調査地点：地域社会1 目黒

調査年月日：令和元年10月13日(日) 天候：曇りのち雨

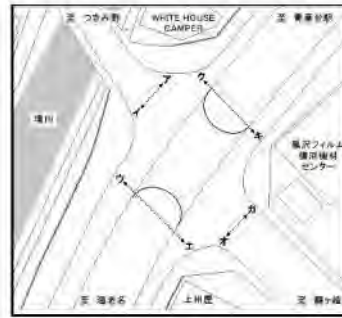

時間帯	ウ				エ				合計			
	歩行者 (人)	自転車 (台)	合計 (人・台)	時間 係数 (%)	歩行者 (人)	自転車 (台)	合計 (人・台)	時間 係数 (%)	歩行者 (人)	自転車 (台)	合計 (人・台)	時間 係数 (%)
22:00-22:15	1	1	2	1.7	1	2	3	2.5	2	3	5	2.1
22:15-22:30	1	3	4	3.4	1	0	1	0.8	2	3	5	2.1
22:30-22:45	0	1	1	0.9	0	0	0	0.0	0	1	1	0.4
22:45-23:00	0	4	4	3.4	0	0	0	0.0	0	4	4	1.7
1時間計	2	9	11	9.4	2	2	4	3.4	4	11	15	6.4
23:00-23:15	0	0	0	0.0	1	1	2	1.7	1	1	2	0.8
23:15-23:30	0	0	0	0.0	1	1	2	1.7	1	1	2	0.8
23:30-23:45	0	1	1	0.9	0	0	0	0.0	0	1	1	0.4
23:45-24:00	0	0	0	0.0	0	0	0	0.0	0	0	0	0.0
1時間計	0	1	1	0.9	2	2	4	3.4	2	3	5	2.1
0:00-0:15	0	0	0	0.0	0	0	0	0.0	0	0	0	0.0
0:15-0:30	0	0	0	0.0	0	0	0	0.0	0	0	0	0.0
0:30-0:45	0	0	0	0.0	0	0	0	0.0	0	0	0	0.0
0:45-1:00	0	0	0	0.0	0	0	0	0.0	0	0	0	0.0
1時間計	0	0	0	0.0	0	0	0	0.0	0	0	0	0.0
1:00-1:15	0	0	0	0.0	0	0	0	0.0	0	0	0	0.0
1:15-1:30	0	0	0	0.0	0	0	0	0.0	0	0	0	0.0
1:30-1:45	0	0	0	0.0	0	0	0	0.0	0	0	0	0.0
1:45-2:00	0	0	0	0.0	0	0	0	0.0	0	0	0	0.0
1時間計	0	0	0	0.0	0	0	0	0.0	0	0	0	0.0
2:00-2:15	0	0	0	0.0	0	0	0	0.0	0	0	0	0.0
2:15-2:30	0	1	1	0.9	1	0	1	0.8	1	1	2	0.8
2:30-2:45	0	0	0	0.0	0	0	0	0.0	0	0	0	0.0
2:45-3:00	0	0	0	0.0	0	0	0	0.0	0	0	0	0.0
1時間計	0	1	1	0.9	1	0	1	0.8	1	1	2	0.8
3:00-3:15	0	0	0	0.0	0	0	0	0.0	0	0	0	0.0
3:15-3:30	1	0	1	0.9	0	0	0	0.0	1	0	1	0.4
3:30-3:45	0	0	0	0.0	0	0	0	0.0	0	0	0	0.0
3:45-4:00	0	0	0	0.0	0	0	0	0.0	0	0	0	0.0
1時間計	1	0	1	0.9	0	0	0	0.0	1	0	1	0.4
4:00-4:15	0	0	0	0.0	0	0	0	0.0	0	0	0	0.0
4:15-4:30	1	0	1	0.9	0	1	1	0.8	1	1	2	0.8
4:30-4:45	0	1	1	0.9	0	0	0	0.0	0	1	1	0.4
4:45-5:00	0	0	0	0.0	0	1	1	0.8	0	1	1	0.4
1時間計	1	1	2	1.7	0	2	2	1.7	1	3	4	1.7
5:00-5:15	0	1	1	0.9	0	3	3	2.5	0	4	4	1.7
5:15-5:30	0	0	0	0.0	0	0	0	0.0	0	0	0	0.0
5:30-5:45	1	1	2	1.7	1	1	2	1.7	2	2	4	1.7
5:45-6:00	0	1	1	0.9	0	1	1	0.8	0	2	2	0.8
1時間計	1	3	4	3.4	1	5	6	5.0	2	8	10	4.2

歩行者通行量調査表

調査地点：地域社会1 目黒

調査年月日：令和元年10月13日(日) 天候：曇りのち雨

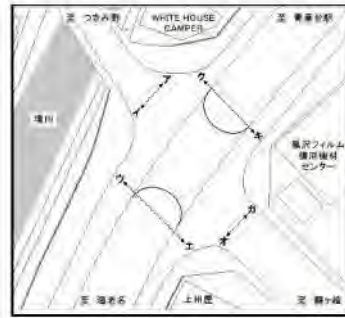

時間帯	ウ				エ				合計			
	歩行者 (人)	自転車 (台)	合計 (人・台)	時間 係数 (%)	歩行者 (人)	自転車 (台)	合計 (人・台)	時間 係数 (%)	歩行者 (人)	自転車 (台)	合計 (人・台)	時間 係数 (%)
6:00-6:15	1	2	3	2.6	1	1	2	1.7	2	3	5	2.1
6:15-6:30	2	0	2	1.7	0	0	0	0.0	2	0	2	0.8
6:30-6:45	1	3	4	3.4	1	3	4	3.4	2	6	8	3.4
6:45-7:00	0	0	0	0.0	2	1	3	2.5	2	1	3	1.3
1時間計	4	5	9	7.7	4	5	9	7.6	8	10	18	7.6
7:00-7:15	1	0	1	0.9	5	3	8	6.7	6	3	9	3.8
7:15-7:30	1	0	1	0.9	1	4	5	4.2	2	4	6	2.5
7:30-7:45	0	1	1	0.9	3	3	6	5.0	3	4	7	3.0
7:45-8:00	0	0	0	0.0	2	2	4	3.4	2	2	4	1.7
1時間計	2	1	3	2.6	11	12	23	19.3	13	13	26	11.0
8:00-8:15	2	0	2	1.7	1	2	3	2.5	3	2	5	2.1
8:15-8:30	0	3	3	2.6	2	1	3	2.5	2	4	6	2.5
8:30-8:45	1	1	2	1.7	1	3	4	3.4	2	4	6	2.5
8:45-9:00	1	0	1	0.9	4	1	5	4.2	5	1	6	2.5
1時間計	4	4	8	6.8	8	7	15	12.6	12	11	23	9.7
9:00-9:15	0	1	1	0.9	1	5	6	5.0	1	6	7	3.0
9:15-9:30	0	1	1	0.9	2	1	3	2.5	2	2	4	1.7
9:30-9:45	0	3	3	2.6	0	2	2	1.7	0	5	5	2.1
9:45-10:00	0	1	1	0.9	0	0	0	0.0	0	1	1	0.4
1時間計	0	6	6	5.1	3	8	11	9.2	3	14	17	7.2
10:00-10:15	0	0	0	0.0	0	1	1	0.8	0	1	1	0.4
10:15-10:30	0	0	0	0.0	0	1	1	0.8	0	1	1	0.4
10:30-10:45	0	3	3	2.6	2	0	2	1.7	2	3	5	2.1
10:45-11:00	1	0	1	0.9	0	0	0	0.0	1	0	1	0.4
1時間計	1	3	4	3.4	2	2	4	3.4	3	5	8	3.4
11:00-11:15	0	2	2	1.7	0	1	1	0.8	0	3	3	1.3
11:15-11:30	1	0	1	0.9	1	1	2	1.7	2	1	3	1.3
11:30-11:45	1	0	1	0.9	1	2	3	2.5	2	2	4	1.7
11:45-12:00	2	0	2	1.7	2	2	4	3.4	4	2	6	2.5
1時間計	4	2	6	5.1	4	6	10	8.4	8	8	16	6.8
12:00-12:15	2	0	2	1.7	2	2	4	3.4	4	2	6	2.5
12:15-12:30	0	1	1	0.9	0	0	0	0.0	0	1	1	0.4
12:30-12:45	0	0	0	0.0	0	0	0	0.0	0	0	0	0.0
12:45-13:00	0	0	0	0.0	0	0	0	0.0	0	0	0	0.0
1時間計	2	1	3	2.6	2	2	4	3.4	4	3	7	3.0
13:00-13:15	0	0	0	0.0	1	1	2	1.7	1	1	2	0.8
13:15-13:30	0	0	0	0.0	0	0	0	0.0	0	0	0	0.0
13:30-13:45	0	0	0	0.0	0	0	0	0.0	0	0	0	0.0
13:45-14:00	0	0	0	0.0	0	0	0	0.0	0	0	0	0.0
1時間計	0	0	0	0.0	1	1	2	1.7	1	1	2	0.8

歩行者通行量調査表

調査地点：地域社会1 目黒

調査年月日：令和元年10月13日(日) 天候：曇りのち雨

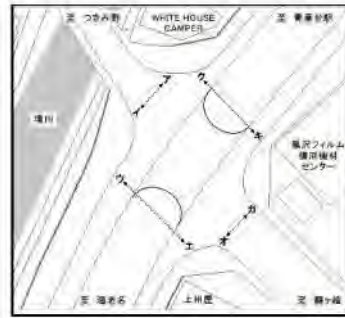

時間帯	ウ				エ				合計			
	歩行者 (人)	自転車 (台)	合計 (人・台)	時間 係数 (%)	歩行者 (人)	自転車 (台)	合計 (人・台)	時間 係数 (%)	歩行者 (人)	自転車 (台)	合計 (人・台)	時間 係数 (%)
14:00-14:15	0	0	0	0.0	0	0	0	0.0	0	0	0	0.0
14:15-14:30	0	0	0	0.0	0	1	1	0.8	0	1	1	0.4
14:30-14:45	1	0	1	0.9	0	0	0	0.0	1	0	1	0.4
14:45-15:00	2	0	2	1.7	1	1	2	1.7	3	1	4	1.7
1時間計	3	0	3	2.6	1	2	3	2.5	4	2	6	2.5
15:00-15:15	1	1	2	1.7	1	0	1	0.8	2	1	3	1.3
15:15-15:30	0	0	0	0.0	0	0	0	0.0	0	0	0	0.0
15:30-15:45	0	0	0	0.0	0	0	0	0.0	0	0	0	0.0
15:45-16:00	0	2	2	1.7	0	2	2	1.7	0	4	4	1.7
1時間計	1	3	4	3.4	1	2	3	2.5	2	5	7	3.0
16:00-16:15	0	4	4	3.4	1	1	2	1.7	1	5	6	2.5
16:15-16:30	2	1	3	2.6	1	1	2	1.7	3	2	5	2.1
16:30-16:45	0	0	0	0.0	0	1	1	0.8	0	1	1	0.4
16:45-17:00	0	0	0	0.0	0	0	0	0.0	0	0	0	0.0
1時間計	2	5	7	6.0	2	3	5	4.2	4	8	12	5.1
17:00-17:15	0	0	0	0.0	0	0	0	0.0	0	0	0	0.0
17:15-17:30	2	2	4	3.4	2	0	2	1.7	4	2	6	2.5
17:30-17:45	2	3	5	4.3	2	3	5	4.2	4	6	10	4.2
17:45-18:00	0	0	0	0.0	0	0	0	0.0	0	0	0	0.0
1時間計	4	5	9	7.7	4	3	7	5.9	8	8	16	6.8
18:00-18:15	1	0	1	0.9	0	0	0	0.0	1	0	1	0.4
18:15-18:30	0	1	1	0.9	0	1	1	0.8	0	2	2	0.8
18:30-18:45	1	0	1	0.9	0	0	0	0.0	1	0	1	0.4
18:45-19:00	0	0	0	0.0	0	0	0	0.0	0	0	0	0.0
1時間計	2	1	3	2.6	0	1	1	0.8	2	2	4	1.7
19:00-19:15	6	2	8	6.8	0	0	0	0.0	6	2	8	3.4
19:15-19:30	3	1	4	3.4	0	0	0	0.0	3	1	4	1.7
19:30-19:45	3	0	3	2.6	0	2	2	1.7	3	2	5	2.1
19:45-20:00	1	0	1	0.9	0	0	0	0.0	1	0	1	0.4
1時間計	13	3	16	13.7	0	2	2	1.7	13	5	18	7.6
20:00-20:15	1	1	2	1.7	0	0	0	0.0	1	1	2	0.8
20:15-20:30	1	0	1	0.9	0	0	0	0.0	1	0	1	0.4
20:30-20:45	0	0	0	0.0	1	0	1	0.8	1	0	1	0.4
20:45-21:00	1	0	1	0.9	0	0	0	0.0	1	0	1	0.4
1時間計	3	1	4	3.4	1	0	1	0.8	4	1	5	2.1
21:00-21:15	2	2	4	3.4	0	0	0	0.0	2	2	4	1.7
21:15-21:30	4	2	6	5.1	1	0	1	0.8	5	2	7	3.0
21:30-21:45	2	0	2	1.7	1	0	1	0.8	3	0	3	1.3
21:45-22:00	0	0	0	0.0	0	0	0	0.0	0	0	0	0.0
1時間計	8	4	12	10.3	2	0	2	1.7	10	4	14	5.9
昼12時間計	25	31	56	47.9	39	49	88	73.9	64	80	144	61.0
夜12時間計	33	28	61	52.1	13	18	31	26.1	46	46	92	39.0
全時間合計	58	59	117	100.0	52	67	119	100.0	110	126	236	100.0
昼夜率	2.32	1.90	2.09	-	1.33	1.37	1.35	-	1.72	1.58	1.64	-

歩行者通行量調査表

調査地点：地域社会1 目黒

調査年月日：令和元年10月13日(日) 天候：曇りのち雨

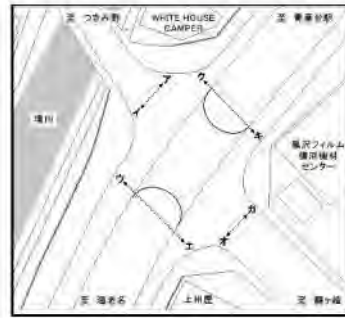

時間帯	方向				合計							
	歩行者 (人)	自転車 (台)	合計 (人・台)	時間 係数 (%)	歩行者 (人)	自転車 (台)	合計 (人・台)	時間 係数 (%)	歩行者 (人)	自転車 (台)	合計 (人・台)	時間 係数 (%)
22:00-22:15	0	0	0	0.0	0	0	0	0.0	0	0	0	0.0
22:15-22:30	0	0	0	0.0	0	1	1	1.1	0	1	1	0.4
22:30-22:45	0	0	0	0.0	0	0	0	0.0	0	0	0	0.0
22:45-23:00	0	0	0	0.0	0	0	0	0.0	0	0	0	0.0
1時間計	0	0	0	0.0	0	1	1	1.1	0	1	1	0.4
23:00-23:15	0	0	0	0.0	0	0	0	0.0	0	0	0	0.0
23:15-23:30	0	0	0	0.0	1	1	2	2.1	1	1	2	0.9
23:30-23:45	0	0	0	0.0	0	0	0	0.0	0	0	0	0.0
23:45-24:00	0	0	0	0.0	0	0	0	0.0	0	0	0	0.0
1時間計	0	0	0	0.0	1	1	2	2.1	1	1	2	0.9
0:00-0:15	1	0	1	0.7	0	0	0	0.0	1	0	1	0.4
0:15-0:30	0	1	1	0.7	0	0	0	0.0	0	1	1	0.4
0:30-0:45	0	0	0	0.0	0	1	1	1.1	0	1	1	0.4
0:45-1:00	0	0	0	0.0	1	0	1	1.1	1	0	1	0.4
1時間計	1	1	2	1.4	1	1	2	2.1	2	2	4	1.7
1:00-1:15	1	1	2	1.4	0	0	0	0.0	1	1	2	0.9
1:15-1:30	0	0	0	0.0	0	0	0	0.0	0	0	0	0.0
1:30-1:45	0	0	0	0.0	0	0	0	0.0	0	0	0	0.0
1:45-2:00	0	0	0	0.0	0	0	0	0.0	0	0	0	0.0
1時間計	1	1	2	1.4	0	0	0	0.0	1	1	2	0.9
2:00-2:15	0	0	0	0.0	0	0	0	0.0	0	0	0	0.0
2:15-2:30	0	0	0	0.0	0	0	0	0.0	0	0	0	0.0
2:30-2:45	0	0	0	0.0	0	0	0	0.0	0	0	0	0.0
2:45-3:00	0	1	1	0.7	0	0	0	0.0	0	1	1	0.4
1時間計	0	1	1	0.7	0	0	0	0.0	0	1	1	0.4
3:00-3:15	0	0	0	0.0	0	0	0	0.0	0	0	0	0.0
3:15-3:30	0	0	0	0.0	0	0	0	0.0	0	0	0	0.0
3:30-3:45	0	0	0	0.0	0	0	0	0.0	0	0	0	0.0
3:45-4:00	0	0	0	0.0	0	1	1	1.1	0	1	1	0.4
1時間計	0	0	0	0.0	0	1	1	1.1	0	1	1	0.4
4:00-4:15	0	0	0	0.0	0	0	0	0.0	0	0	0	0.0
4:15-4:30	0	0	0	0.0	0	0	0	0.0	0	0	0	0.0
4:30-4:45	0	0	0	0.0	0	0	0	0.0	0	0	0	0.0
4:45-5:00	0	0	0	0.0	2	0	2	2.1	2	0	2	0.9
1時間計	0	0	0	0.0	2	0	2	2.1	2	0	2	0.9
5:00-5:15	0	0	0	0.0	0	2	2	2.1	0	2	2	0.9
5:15-5:30	1	1	2	1.4	0	2	2	2.1	1	3	4	1.7
5:30-5:45	1	0	1	0.7	0	0	0	0.0	1	0	1	0.4
5:45-6:00	1	0	1	0.7	0	0	0	0.0	1	0	1	0.4
1時間計	3	1	4	2.9	0	4	4	4.2	3	5	8	3.4

歩行者通行量調査表

調査地点：地域社会1 目黒

調査年月日：令和元年10月13日(日) 天候：曇りのち雨

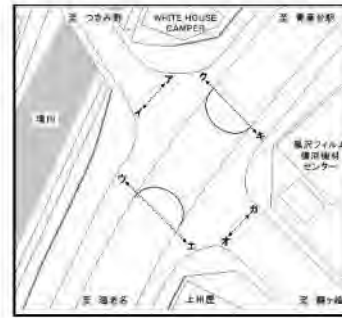

時間帯	方向				合計							
	歩行者 (人)	自転車 (台)	合計 (人・台)	時間 係数 (%)	歩行者 (人)	自転車 (台)	合計 (人・台)	時間 係数 (%)	歩行者 (人)	自転車 (台)	合計 (人・台)	時間 係数 (%)
6:00-6:15	3	7	10	7.2	0	1	1	1.1	3	8	11	4.7
6:15-6:30	0	0	0	0.0	1	0	1	1.1	1	0	1	0.4
6:30-6:45	1	0	1	0.7	0	1	1	1.1	1	1	2	0.9
6:45-7:00	4	4	8	5.8	0	0	0	0.0	4	4	8	3.4
1時間計	8	11	19	13.8	1	2	3	3.2	9	13	22	9.4
7:00-7:15	0	0	0	0.0	0	0	0	0.0	0	0	0	0.0
7:15-7:30	0	0	0	0.0	0	1	1	1.1	0	1	1	0.4
7:30-7:45	0	0	0	0.0	1	1	2	2.1	1	1	2	0.9
7:45-8:00	2	0	2	1.4	2	0	2	2.1	4	0	4	1.7
1時間計	2	0	2	1.4	3	2	5	5.3	5	2	7	3.0
8:00-8:15	2	1	3	2.2	0	2	2	2.1	2	3	5	2.1
8:15-8:30	2	6	8	5.8	0	3	3	3.2	2	9	11	4.7
8:30-8:45	3	7	10	7.2	0	3	3	3.2	3	10	13	5.6
8:45-9:00	5	7	12	8.7	0	4	4	4.2	5	11	16	6.9
1時間計	12	21	33	23.9	0	12	12	12.6	12	33	45	19.3
9:00-9:15	0	1	1	0.7	1	1	2	2.1	1	2	3	1.3
9:15-9:30	0	3	3	2.2	2	2	4	4.2	2	5	7	3.0
9:30-9:45	1	6	7	5.1	0	1	1	1.1	1	7	8	3.4
9:45-10:00	1	6	7	5.1	0	3	3	3.2	1	9	10	4.3
1時間計	2	16	18	13.0	3	7	10	10.5	5	23	28	12.0
10:00-10:15	0	0	0	0.0	0	1	1	1.1	0	1	1	0.4
10:15-10:30	0	0	0	0.0	0	0	0	0.0	0	0	0	0.0
10:30-10:45	2	4	6	4.3	1	4	5	5.3	3	8	11	4.7
10:45-11:00	0	1	1	0.7	0	0	0	0.0	0	1	1	0.4
1時間計	2	5	7	5.1	1	5	6	6.3	3	10	13	5.6
11:00-11:15	0	1	1	0.7	0	1	1	1.1	0	2	2	0.9
11:15-11:30	1	4	5	3.6	0	1	1	1.1	1	5	6	2.6
11:30-11:45	0	1	1	0.7	0	1	1	1.1	0	2	2	0.9
11:45-12:00	0	0	0	0.0	3	0	3	3.2	3	0	3	1.3
1時間計	1	6	7	5.1	3	3	6	6.3	4	9	13	5.6
12:00-12:15	0	1	1	0.7	3	0	3	3.2	3	1	4	1.7
12:15-12:30	0	0	0	0.0	3	0	3	3.2	3	0	3	1.3
12:30-12:45	0	0	0	0.0	0	1	1	1.1	0	1	1	0.4
12:45-13:00	1	4	5	3.6	0	0	0	0.0	1	4	5	2.1
1時間計	1	5	6	4.3	6	1	7	7.4	7	6	13	5.6
13:00-13:15	0	2	2	1.4	0	0	0	0.0	0	2	2	0.9
13:15-13:30	0	0	0	0.0	0	0	0	0.0	0	0	0	0.0
13:30-13:45	0	0	0	0.0	0	0	0	0.0	0	0	0	0.0
13:45-14:00	0	0	0	0.0	0	0	0	0.0	0	0	0	0.0
1時間計	0	2	2	1.4	0	0	0	0.0	0	2	2	0.9

歩行者通行量調査表

調査地点：地域社会1 目黒

調査年月日：令和元年10月13日(日) 天候：曇りのち雨

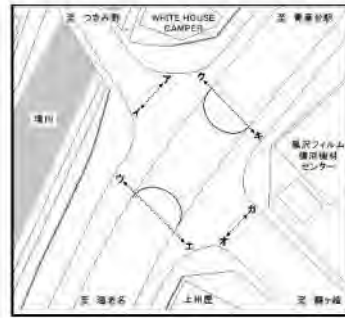

時間帯	方向				合計							
	歩行者 (人)	自転車 (台)	合計 (人・台)	時間 係数 (%)	歩行者 (人)	自転車 (台)	合計 (人・台)	時間 係数 (%)	歩行者 (人)	自転車 (台)	合計 (人・台)	時間 係数 (%)
14:00-14:15	1	0	1	0.7	0	0	0	0.0	1	0	1	0.4
14:15-14:30	2	0	2	1.4	0	2	2	2.1	2	2	4	1.7
14:30-14:45	1	0	1	0.7	1	1	2	2.1	2	1	3	1.3
14:45-15:00	0	0	0	0.0	0	0	0	0.0	0	0	0	0.0
1時間計	4	0	4	2.9	1	3	4	4.2	5	3	8	3.4
15:00-15:15	0	0	0	0.0	1	0	1	1.1	1	0	1	0.4
15:15-15:30	1	0	1	0.7	4	0	4	4.2	5	0	5	2.1
15:30-15:45	0	0	0	0.0	1	0	1	1.1	1	0	1	0.4
15:45-16:00	0	1	1	0.7	1	0	1	1.1	1	1	2	0.9
1時間計	1	1	2	1.4	7	0	7	7.4	8	1	9	3.9
16:00-16:15	0	0	0	0.0	0	0	0	0.0	0	0	0	0.0
16:15-16:30	1	1	2	1.4	0	0	0	0.0	1	1	2	0.9
16:30-16:45	2	0	2	1.4	0	0	0	0.0	2	0	2	0.9
16:45-17:00	1	2	3	2.2	0	0	0	0.0	1	2	3	1.3
1時間計	4	3	7	5.1	0	0	0	0.0	4	3	7	3.0
17:00-17:15	1	2	3	2.2	1	1	2	2.1	2	3	5	2.1
17:15-17:30	1	1	2	1.4	0	0	0	0.0	1	1	2	0.9
17:30-17:45	0	1	1	0.7	0	1	1	1.1	0	2	2	0.9
17:45-18:00	0	2	2	1.4	3	0	3	3.2	3	2	5	2.1
1時間計	2	6	8	5.8	4	2	6	6.3	6	8	14	6.0
18:00-18:15	3	2	5	3.6	2	0	2	2.1	5	2	7	3.0
18:15-18:30	0	2	2	1.4	0	2	2	2.1	0	4	4	1.7
18:30-18:45	0	2	2	1.4	1	1	2	2.1	1	3	4	1.7
18:45-19:00	0	2	2	1.4	1	0	1	1.1	1	2	3	1.3
1時間計	3	8	11	8.0	4	3	7	7.4	7	11	18	7.7
19:00-19:15	0	0	0	0.0	0	2	2	2.1	0	2	2	0.9
19:15-19:30	0	0	0	0.0	0	0	0	0.0	0	0	0	0.0
19:30-19:45	0	0	0	0.0	0	3	3	3.2	0	3	3	1.3
19:45-20:00	0	0	0	0.0	0	0	0	0.0	0	0	0	0.0
1時間計	0	0	0	0.0	0	5	5	5.3	0	5	5	2.1
20:00-20:15	0	0	0	0.0	0	0	0	0.0	0	0	0	0.0
20:15-20:30	1	1	2	1.4	1	2	3	3.2	2	3	5	2.1
20:30-20:45	0	0	0	0.0	0	0	0	0.0	0	0	0	0.0
20:45-21:00	0	0	0	0.0	0	0	0	0.0	0	0	0	0.0
1時間計	1	1	2	1.4	1	2	3	3.2	2	3	5	2.1
21:00-21:15	0	1	1	0.7	0	1	1	1.1	0	2	2	0.9
21:15-21:30	0	0	0	0.0	0	1	1	1.1	0	1	1	0.4
21:30-21:45	0	0	0	0.0	0	0	0	0.0	0	0	0	0.0
21:45-22:00	0	0	0	0.0	0	0	0	0.0	0	0	0	0.0
1時間計	0	1	1	0.7	0	2	2	2.1	0	3	3	1.3
昼12時間計	34	73	107	77.5	32	38	70	73.7	66	111	177	76.0
夜12時間計	14	17	31	22.5	6	19	25	26.3	20	36	56	24.0
全時間合計	48	90	138	100.0	38	57	95	100.0	86	147	233	100.0
昼夜率	1.41	1.23	1.29	-	1.19	1.50	1.36	-	1.30	1.32	1.32	-

歩行者通行量調査表

調査地点：地域社会1 目黒

調査年月日：令和元年10月13日(日) 天候：曇りのち雨

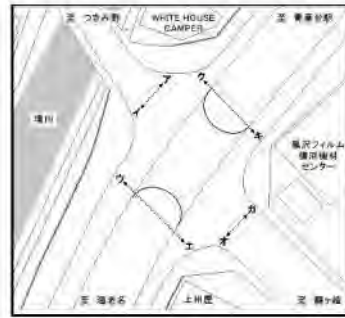

時間帯	キ				ケ				合計			
	歩行者 (人)	自転車 (台)	合計 (人・台)	時間 係数 (%)	歩行者 (人)	自転車 (台)	合計 (人・台)	時間 係数 (%)	歩行者 (人)	自転車 (台)	合計 (人・台)	時間 係数 (%)
22:00-22:15	1	1	2	0.8	1	0	1	0.5	2	1	3	0.7
22:15-22:30	1	2	3	1.2	0	2	2	1.1	1	4	5	1.2
22:30-22:45	0	5	5	2.0	1	0	1	0.5	1	5	6	1.4
22:45-23:00	0	1	1	0.4	0	3	3	1.6	0	4	4	0.9
1時間計	2	9	11	4.4	2	5	7	3.8	4	14	18	4.2
23:00-23:15	0	0	0	0.0	0	1	1	0.5	0	1	1	0.2
23:15-23:30	1	1	2	0.8	0	0	0	0.0	1	1	2	0.5
23:30-23:45	4	0	4	1.6	4	0	4	2.2	8	0	8	1.9
23:45-24:00	0	1	1	0.4	1	0	1	0.5	1	1	2	0.5
1時間計	5	2	7	2.8	5	1	6	3.3	10	3	13	3.0
0:00-0:15	0	0	0	0.0	0	0	0	0.0	0	0	0	0.0
0:15-0:30	0	1	1	0.4	0	1	1	0.5	0	2	2	0.5
0:30-0:45	0	0	0	0.0	0	0	0	0.0	0	0	0	0.0
0:45-1:00	0	0	0	0.0	0	0	0	0.0	0	0	0	0.0
1時間計	0	1	1	0.4	0	1	1	0.5	0	2	2	0.5
1:00-1:15	1	0	1	0.4	0	0	0	0.0	1	0	1	0.2
1:15-1:30	1	0	1	0.4	0	0	0	0.0	1	0	1	0.2
1:30-1:45	0	1	1	0.4	0	0	0	0.0	0	1	1	0.2
1:45-2:00	0	0	0	0.0	1	0	1	0.5	1	0	1	0.2
1時間計	2	1	3	1.2	1	0	1	0.5	3	1	4	0.9
2:00-2:15	0	0	0	0.0	0	0	0	0.0	0	0	0	0.0
2:15-2:30	0	1	1	0.4	0	0	0	0.0	0	1	1	0.2
2:30-2:45	0	0	0	0.0	0	1	1	0.5	0	1	1	0.2
2:45-3:00	0	1	1	0.4	0	0	0	0.0	0	1	1	0.2
1時間計	0	2	2	0.8	0	1	1	0.5	0	3	3	0.7
3:00-3:15	0	0	0	0.0	0	1	1	0.5	0	1	1	0.2
3:15-3:30	0	0	0	0.0	0	0	0	0.0	0	0	0	0.0
3:30-3:45	0	0	0	0.0	0	0	0	0.0	0	0	0	0.0
3:45-4:00	0	0	0	0.0	0	2	2	1.1	0	2	2	0.5
1時間計	0	0	0	0.0	0	3	3	1.6	0	3	3	0.7
4:00-4:15	0	0	0	0.0	0	0	0	0.0	0	0	0	0.0
4:15-4:30	0	0	0	0.0	0	0	0	0.0	0	0	0	0.0
4:30-4:45	0	0	0	0.0	0	0	0	0.0	0	0	0	0.0
4:45-5:00	0	2	2	0.8	0	1	1	0.5	0	3	3	0.7
1時間計	0	2	2	0.8	0	1	1	0.5	0	3	3	0.7
5:00-5:15	1	0	1	0.4	1	1	2	1.1	2	1	3	0.7
5:15-5:30	1	3	4	1.6	3	0	3	1.6	4	3	7	1.6
5:30-5:45	1	2	3	1.2	2	0	2	1.1	3	2	5	1.2
5:45-6:00	1	2	3	1.2	0	0	0	0.0	1	2	3	0.7
1時間計	4	7	11	4.4	6	1	7	3.8	10	8	18	4.2

歩行者通行量調査表

調査地点：地域社会1 目黒

調査年月日：令和元年10月13日(日) 天候：曇りのち雨

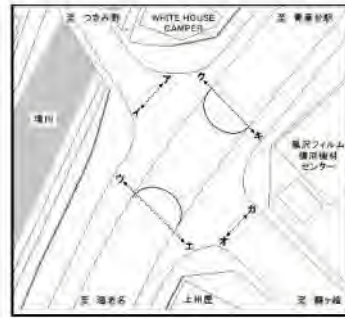

時間帯	種別	キ				ク				合計			
		歩行者 (人)	自転車 (台)	合計 (人・台)	時間 係数 (%)	歩行者 (人)	自転車 (台)	合計 (人・台)	時間 係数 (%)	歩行者 (人)	自転車 (台)	合計 (人・台)	時間 係数 (%)
6:00-6:15		1	3	4	1.6	1	1	2	1.1	2	4	6	1.4
6:15-6:30		1	2	3	1.2	1	0	1	0.5	2	2	4	0.9
6:30-6:45		2	1	3	1.2	1	0	1	0.5	3	1	4	0.9
6:45-7:00		3	5	8	3.2	2	2	4	2.2	5	7	12	2.8
1時間計		7	11	18	7.2	5	3	8	4.4	12	14	26	6.0
7:00-7:15		4	1	5	2.0	3	0	3	1.6	7	1	8	1.9
7:15-7:30		6	6	12	4.8	5	2	7	3.8	11	8	19	4.4
7:30-7:45		1	10	11	4.4	3	1	4	2.2	4	11	15	3.5
7:45-8:00		5	3	8	3.2	1	3	4	2.2	6	6	12	2.8
1時間計		16	20	36	14.5	12	6	18	9.8	28	26	54	12.5
8:00-8:15		0	0	0	0.0	1	0	1	0.5	1	0	1	0.2
8:15-8:30		4	7	11	4.4	4	2	6	3.3	8	9	17	3.9
8:30-8:45		6	11	17	6.8	4	2	6	3.3	10	13	23	5.3
8:45-9:00		2	5	7	2.8	7	1	8	4.4	9	6	15	3.5
1時間計		12	23	35	14.1	16	5	21	11.5	28	28	56	13.0
9:00-9:15		4	2	6	2.4	0	0	0	0.0	4	2	6	1.4
9:15-9:30		1	1	2	0.8	0	1	1	0.5	1	2	3	0.7
9:30-9:45		1	4	5	2.0	2	2	4	2.2	3	6	9	2.1
9:45-10:00		1	1	2	0.8	3	5	8	4.4	4	6	10	2.3
1時間計		7	8	15	6.0	5	8	13	7.1	12	16	28	6.5
10:00-10:15		0	0	0	0.0	0	2	2	1.1	0	2	2	0.5
10:15-10:30		0	0	0	0.0	0	2	2	1.1	0	2	2	0.5
10:30-10:45		1	0	1	0.4	4	1	5	2.7	5	1	6	1.4
10:45-11:00		3	2	5	2.0	2	1	3	1.6	5	3	8	1.9
1時間計		4	2	6	2.4	6	6	12	6.6	10	8	18	4.2
11:00-11:15		0	0	0	0.0	0	1	1	0.5	0	1	1	0.2
11:15-11:30		1	1	2	0.8	1	1	2	1.1	2	2	4	0.9
11:30-11:45		2	1	3	1.2	3	0	3	1.6	5	1	6	1.4
11:45-12:00		0	1	1	0.4	12	2	14	7.7	12	3	15	3.5
1時間計		3	3	6	2.4	16	4	20	10.9	19	7	26	6.0
12:00-12:15		3	2	5	2.0	4	2	6	3.3	7	4	11	2.5
12:15-12:30		2	3	5	2.0	2	1	3	1.6	4	4	8	1.9
12:30-12:45		1	1	2	0.8	0	0	0	0.0	1	1	2	0.5
12:45-13:00		1	1	2	0.8	0	0	0	0.0	1	1	2	0.5
1時間計		7	7	14	5.6	6	3	9	4.9	13	10	23	5.3
13:00-13:15		0	3	3	1.2	1	0	1	0.5	1	3	4	0.9
13:15-13:30		0	1	1	0.4	1	0	1	0.5	1	1	2	0.5
13:30-13:45		2	2	4	1.6	1	3	4	2.2	3	5	8	1.9
13:45-14:00		1	1	2	0.8	0	0	0	0.0	1	1	2	0.5
1時間計		3	7	10	4.0	3	3	6	3.3	6	10	16	3.7

歩行者通行量調査表

調査地点：地域社会1 目黒

調査年月日：令和元年10月13日(日) 天候：曇りのち雨

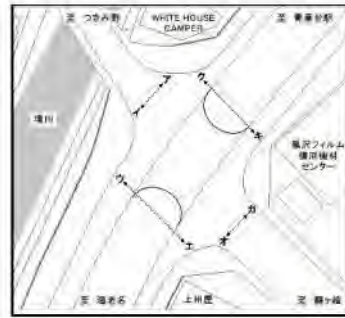

時間帯	キ				ケ				合計			
	歩行者 (人)	自転車 (台)	合計 (人・台)	時間係数 (%)	歩行者 (人)	自転車 (台)	合計 (人・台)	時間係数 (%)	歩行者 (人)	自転車 (台)	合計 (人・台)	時間係数 (%)
14:00-14:15	3	3	6	2.4	0	2	2	1.1	3	5	8	1.9
14:15-14:30	3	0	3	1.2	2	0	2	1.1	5	0	5	1.2
14:30-14:45	0	1	1	0.4	0	0	0	0.0	0	1	1	0.2
14:45-15:00	1	1	2	0.8	0	1	1	0.5	1	2	3	0.7
1時間計	7	5	12	4.8	2	3	5	2.7	9	8	17	3.9
15:00-15:15	5	2	7	2.8	1	0	1	0.5	6	2	8	1.9
15:15-15:30	2	1	3	1.2	2	0	2	1.1	4	1	5	1.2
15:30-15:45	0	1	1	0.4	0	2	2	1.1	0	3	3	0.7
15:45-16:00	4	2	6	2.4	0	1	1	0.5	4	3	7	1.6
1時間計	11	6	17	6.8	3	3	6	3.3	14	9	23	5.3
16:00-16:15	5	1	6	2.4	1	1	2	1.1	6	2	8	1.9
16:15-16:30	1	0	1	0.4	0	1	1	0.5	1	1	2	0.5
16:30-16:45	2	0	2	0.8	1	0	1	0.5	3	0	3	0.7
16:45-17:00	2	2	4	1.6	0	0	0	0.0	2	2	4	0.9
1時間計	10	3	13	5.2	2	2	4	2.2	12	5	17	3.9
17:00-17:15	2	1	3	1.2	1	2	3	1.6	3	3	6	1.4
17:15-17:30	4	0	4	1.6	2	4	6	3.3	6	4	10	2.3
17:30-17:45	1	0	1	0.4	1	1	2	1.1	2	1	3	0.7
17:45-18:00	0	0	0	0.0	1	1	2	1.1	1	1	2	0.5
1時間計	7	1	8	3.2	5	8	13	7.1	12	9	21	4.9
18:00-18:15	0	2	2	0.8	1	3	4	2.2	1	5	6	1.4
18:15-18:30	1	2	3	1.2	1	1	2	1.1	2	3	5	1.2
18:30-18:45	0	2	2	0.8	0	2	2	1.1	0	4	4	0.9
18:45-19:00	1	0	1	0.4	0	1	1	0.5	1	1	2	0.5
1時間計	2	6	8	3.2	2	7	9	4.9	4	13	17	3.9
19:00-19:15	1	1	2	0.8	2	3	5	2.7	3	4	7	1.6
19:15-19:30	1	2	3	1.2	1	0	1	0.5	2	2	4	0.9
19:30-19:45	0	2	2	0.8	1	1	2	1.1	1	3	4	0.9
19:45-20:00	0	0	0	0.0	0	0	0	0.0	0	0	0	0.0
1時間計	2	5	7	2.8	4	4	8	4.4	6	9	15	3.5
20:00-20:15	0	0	0	0.0	0	0	0	0.0	0	0	0	0.0
20:15-20:30	1	0	1	0.4	0	0	0	0.0	1	0	1	0.2
20:30-20:45	1	0	1	0.4	0	3	3	1.6	1	3	4	0.9
20:45-21:00	0	1	1	0.4	1	0	1	0.5	1	1	2	0.5
1時間計	2	1	3	1.2	1	3	4	2.2	3	4	7	1.6
21:00-21:15	1	0	1	0.4	0	0	0	0.0	1	0	1	0.2
21:15-21:30	0	0	0	0.0	0	0	0	0.0	0	0	0	0.0
21:30-21:45	1	2	3	1.2	0	0	0	0.0	1	2	3	0.7
21:45-22:00	0	0	0	0.0	0	0	0	0.0	0	0	0	0.0
1時間計	2	2	4	1.6	0	0	0	0.0	2	2	4	0.9
昼12時間計	89	91	180	72.3	78	58	136	74.3	167	149	316	73.1
夜12時間計	26	43	69	27.7	24	23	47	25.7	50	66	116	26.9
全時間合計	115	134	249	100.0	102	81	183	100.0	217	215	432	100.0
昼夜率	1.29	1.47	1.38	-	1.31	1.40	1.35	-	1.30	1.44	1.37	-

歩行者通行量調査表

調査地点：地域社会1 目黒

調査年月日：令和元年10月13日(日) 天候：曇りのち雨

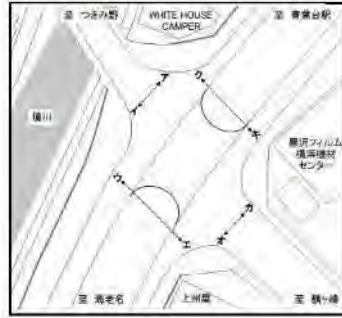

時間帯	種別	合計 (7+イ+ウ+エ+オ+カ+キ+ク)			時間係数 (%)
		歩行者 (人)	自転車 (台)	合計 (人・台)	
22:00-22:15		5	4	9	0.8
22:15-22:30		3	8	11	0.9
22:30-22:45		1	6	7	0.6
22:45-23:00		0	8	8	0.7
1時間計		9	26	35	3.0
23:00-23:15		1	3	4	0.3
23:15-23:30		6	3	9	0.8
23:30-23:45		8	2	10	0.9
23:45-24:00		2	4	6	0.5
1時間計		17	12	29	2.5
0:00-0:15		5	0	5	0.4
0:15-0:30		0	4	4	0.3
0:30-0:45		0	1	1	0.1
0:45-1:00		1	0	1	0.1
1時間計		6	5	11	0.9
1:00-1:15		2	1	3	0.3
1:15-1:30		1	0	1	0.1
1:30-1:45		0	2	2	0.2
1:45-2:00		1	0	1	0.1
1時間計		4	3	7	0.6
2:00-2:15		0	0	0	0.0
2:15-2:30		2	2	4	0.3
2:30-2:45		0	2	2	0.2
2:45-3:00		0	3	3	0.3
1時間計		2	7	9	0.8
3:00-3:15		0	1	1	0.1
3:15-3:30		1	1	2	0.2
3:30-3:45		0	0	0	0.0
3:45-4:00		0	3	3	0.3
1時間計		1	5	6	0.5
4:00-4:15		0	0	0	0.0
4:15-4:30		1	2	3	0.3
4:30-4:45		0	2	2	0.2
4:45-5:00		2	6	8	0.7
1時間計		3	10	13	1.1
5:00-5:15		2	8	10	0.9
5:15-5:30		5	7	12	1.0
5:30-5:45		10	5	15	1.3
5:45-6:00		3	5	8	0.7
1時間計		20	25	45	3.8
6:00-6:15		8	15	23	2.0
6:15-6:30		5	2	7	0.6
6:30-6:45		7	9	16	1.4
6:45-7:00		13	20	33	2.8
1時間計		33	46	79	6.7
7:00-7:15		15	10	25	2.1
7:15-7:30		15	13	28	2.4
7:30-7:45		8	21	29	2.5
7:45-8:00		17	8	25	2.1
1時間計		55	52	107	9.1
8:00-8:15		9	7	16	1.4
8:15-8:30		20	26	46	3.9
8:30-8:45		17	29	46	3.9
8:45-9:00		24	28	52	4.4
1時間計		70	90	160	13.7
9:00-9:15		9	11	20	1.7
9:15-9:30		5	11	16	1.4
9:30-9:45		6	23	29	2.5
9:45-10:00		5	18	23	2.0
1時間計		25	63	88	7.5

時間帯	種別	合計 (7+イ+ウ+エ+オ+カ+キ+ク)			時間係数 (%)
		歩行者 (人)	自転車 (台)	合計 (人・台)	
22:00-23:00		9	26	35	3.0
22:15-23:15		5	25	30	2.6
22:30-23:30		8	20	28	2.4
22:45-23:45		15	16	31	2.6
23:00-0:00		17	12	29	2.5
23:15-0:15		21	9	30	2.6
23:30-0:30		15	10	25	2.1
23:45-0:45		7	9	16	1.4
0:00-1:00		6	5	11	0.9
0:15-1:15		3	6	9	0.8
0:30-1:30		4	2	6	0.5
0:45-1:45		4	3	7	0.6
1:00-2:00		4	3	7	0.6
1:15-2:15		2	2	4	0.3
1:30-2:30		3	4	7	0.6
1:45-2:45		3	4	7	0.6
2:00-3:00		2	7	9	0.8
2:15-3:15		2	8	10	0.9
2:30-3:30		1	7	8	0.7
2:45-3:45		1	5	6	0.5
3:00-4:00		1	5	6	0.5
3:15-4:15		1	4	5	0.4
3:30-4:30		1	5	6	0.5
3:45-4:45		1	7	8	0.7
4:00-5:00		3	10	13	1.1
4:15-5:15		5	18	23	2.0
4:30-5:30		9	23	32	2.7
4:45-5:45		19	26	45	3.8
5:00-6:00		20	25	45	3.8
5:15-6:15		26	32	58	4.9
5:30-6:30		26	27	53	4.5
5:45-6:45		23	31	54	4.6
6:00-7:00		33	46	79	6.7
6:15-7:15		40	41	81	6.9
6:30-7:30		50	52	102	8.7
6:45-7:45		51	64	115	9.8
7:00-8:00		55	52	107	9.1
7:15-8:15		49	49	98	8.4
7:30-8:30		54	62	116	9.9
7:45-8:45		63	70	133	11.3
8:00-9:00		70	90	160	13.7
8:15-9:15		70	94	164	14.0
8:30-9:30		55	79	134	11.4
8:45-9:45		44	73	117	10.0
9:00-10:00		25	63	88	7.5
9:15-10:15		18	56	74	6.3
9:30-10:30		14	49	63	5.4
9:45-10:45		20	40	60	5.1
10:00-11:00		24	26	50	4.3
10:15-11:15		22	28	50	4.3
10:30-11:30		28	35	63	5.4
10:45-11:45		27	28	55	4.7
11:00-12:00		39	33	72	6.1
11:15-12:15		53	36	89	7.6
11:30-12:30		54	30	84	7.2
11:45-12:45		45	25	70	6.0
12:00-13:00		29	22	51	4.4
12:15-13:15		18	20	38	3.2
12:30-13:30		14	20	34	2.9
12:45-13:45		16	26	42	3.6

歩行者通行量調査表

調査地点：地域社会1 目黒

調査年月日：令和元年10月13日(日) 天候：曇りのち雨

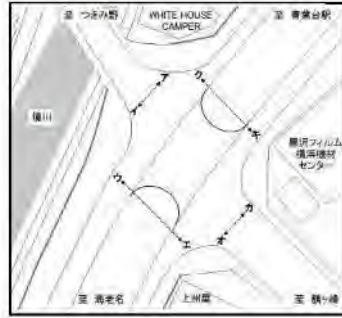

時間帯	種別	合計 (7+イ+ウ+エ+オ+カ+キ+ク)			時間係数 (%)
		歩行者 (人)	自転車 (台)	合計 (人・台)	
22:00-22:15		5	4	9	0.8
22:15-22:30		3	8	11	0.9
10:00-10:15		2	4	6	0.5
10:15-10:30		1	4	5	0.4
10:30-10:45		12	14	26	2.2
10:45-11:00		9	4	13	1.1
1時間計		24	26	50	4.3
11:00-11:15		0	6	6	0.5
11:15-11:30		7	11	18	1.5
11:30-11:45		11	7	18	1.5
11:45-12:00		21	9	30	2.6
1時間計		39	33	72	6.1
12:00-12:15		14	9	23	2.0
12:15-12:30		8	5	13	1.1
12:30-12:45		2	2	4	0.3
12:45-13:00		5	6	11	0.9
1時間計		29	22	51	4.4
13:00-13:15		3	7	10	0.9
13:15-13:30		4	5	9	0.8
13:30-13:45		4	8	12	1.0
13:45-14:00		3	5	8	0.7
1時間計		14	25	39	3.3
14:00-14:15		4	5	9	0.8
14:15-14:30		11	3	14	1.2
14:30-14:45		4	2	6	0.5
14:45-15:00		6	4	10	0.9
1時間計		25	14	39	3.3
15:00-15:15		10	8	18	1.5
15:15-15:30		9	1	10	0.9
15:30-15:45		1	4	5	0.4
15:45-16:00		7	12	19	1.6
1時間計		27	25	52	4.4
16:00-16:15		9	8	17	1.5
16:15-16:30		5	4	9	0.8
16:30-16:45		7	3	10	0.9
16:45-17:00		10	8	18	1.5
1時間計		31	23	54	4.6
17:00-17:15		7	10	17	1.5
17:15-17:30		13	9	22	1.9
17:30-17:45		7	9	16	1.4
17:45-18:00		5	6	11	0.9
1時間計		32	34	66	5.6
18:00-18:15		12	11	23	2.0
18:15-18:30		3	11	14	1.2
18:30-18:45		3	9	12	1.0
18:45-19:00		3	3	6	0.5
1時間計		21	34	55	4.7
19:00-19:15		14	8	22	1.9
19:15-19:30		6	3	9	0.8
19:30-19:45		5	10	15	1.3
19:45-20:00		3	1	4	0.3
1時間計		28	22	50	4.3
20:00-20:15		1	2	3	0.3
20:15-20:30		5	4	9	0.8
20:30-20:45		3	4	7	0.6
20:45-21:00		2	3	5	0.4
1時間計		11	13	24	2.0
21:00-21:15		4	4	8	0.7
21:15-21:30		8	6	14	1.2
21:30-21:45		7	2	9	0.8
21:45-22:00		0	0	0	0.0
1時間計		19	12	31	2.6
昼12時間計		392	441	833	71.1
夜12時間計		153	186	339	28.9
全時間合計		545	627	1172	100.0
昼夜率		1.39	1.42	1.41	-

時間帯	種別	合計 (7+イ+ウ+エ+オ+カ+キ+ク)			時間係数 (%)
		歩行者 (人)	自転車 (台)	合計 (人・台)	
22:00-23:00		9	26	35	3.0
22:15-23:15		5	25	30	2.6
13:00-14:00		14	25	39	3.3
13:15-14:15		15	23	38	3.2
13:30-14:30		22	21	43	3.7
13:45-14:45		22	15	37	3.2
14:00-15:00		25	14	39	3.3
14:15-15:15		31	17	48	4.1
14:30-15:30		29	15	44	3.8
14:45-15:45		26	17	43	3.7
15:00-16:00		27	25	52	4.4
15:15-16:15		26	25	51	4.4
15:30-16:30		22	28	50	4.3
15:45-16:45		28	27	55	4.7
16:00-17:00		31	23	54	4.6
16:15-17:15		29	25	54	4.6
16:30-17:30		37	30	67	5.7
16:45-17:45		37	36	73	6.2
17:00-18:00		32	34	66	5.6
17:15-18:15		37	35	72	6.1
17:30-18:30		27	37	64	5.5
17:45-18:45		23	37	60	5.1
18:00-19:00		21	34	55	4.7
18:15-19:15		23	31	54	4.6
18:30-19:30		26	23	49	4.2
18:45-19:45		28	24	52	4.4
19:00-20:00		28	22	50	4.3
19:15-20:15		15	16	31	2.6
19:30-20:30		14	17	31	2.6
19:45-20:45		12	11	23	2.0
20:00-21:00		11	13	24	2.0
20:15-21:15		14	15	29	2.5
20:30-21:30		17	17	34	2.9
20:45-21:45		21	15	36	3.1
21:00-22:00		19	12	31	2.6
全時間合計		545	627	1,172	100.0

歩行者通行量調査表

調査地点：地域社会2 目黒交番前

調査年月日：令和元年10月13日(日) 天候：曇りのち雨



時間帯	ア				イ				合計			
	歩行者 (人)	自転車 (台)	合計 (人・台)	時間 係数 (%)	歩行者 (人)	自転車 (台)	合計 (人・台)	時間 係数 (%)	歩行者 (人)	自転車 (台)	合計 (人・台)	時間 係数 (%)
22:00-22:15	0	0	0	0.0	0	0	0	0.0	0	0	0	0.0
22:15-22:30	0	1	1	1.3	0	1	1	2.1	0	2	2	1.6
22:30-22:45	0	0	0	0.0	0	2	2	4.2	0	2	2	1.6
22:45-23:00	0	2	2	2.7	0	0	0	0.0	0	2	2	1.6
1時間計	0	3	3	4.0	0	3	3	6.3	0	6	6	4.9
23:00-23:15	0	1	1	1.3	0	0	0	0.0	0	1	1	0.8
23:15-23:30	0	2	2	2.7	0	0	0	0.0	0	2	2	1.6
23:30-23:45	0	0	0	0.0	0	1	1	2.1	0	1	1	0.8
23:45-24:00	0	1	1	1.3	0	2	2	4.2	0	3	3	2.4
1時間計	0	4	4	5.3	0	3	3	6.3	0	7	7	5.7
0:00-0:15	0	0	0	0.0	0	0	0	0.0	0	0	0	0.0
0:15-0:30	1	0	1	1.3	0	0	0	0.0	1	0	1	0.8
0:30-0:45	0	0	0	0.0	0	1	1	2.1	0	1	1	0.8
0:45-1:00	1	0	1	1.3	0	0	0	0.0	1	0	1	0.8
1時間計	2	0	2	2.7	0	1	1	2.1	2	1	3	2.4
1:00-1:15	0	0	0	0.0	0	0	0	0.0	0	0	0	0.0
1:15-1:30	0	0	0	0.0	0	0	0	0.0	0	0	0	0.0
1:30-1:45	0	0	0	0.0	0	0	0	0.0	0	0	0	0.0
1:45-2:00	0	0	0	0.0	0	0	0	0.0	0	0	0	0.0
1時間計	0	0	0	0.0	0	0	0	0.0	0	0	0	0.0
2:00-2:15	0	0	0	0.0	0	0	0	0.0	0	0	0	0.0
2:15-2:30	0	0	0	0.0	0	0	0	0.0	0	0	0	0.0
2:30-2:45	0	0	0	0.0	0	0	0	0.0	0	0	0	0.0
2:45-3:00	0	0	0	0.0	0	0	0	0.0	0	0	0	0.0
1時間計	0	0	0	0.0	0	0	0	0.0	0	0	0	0.0
3:00-3:15	0	0	0	0.0	1	0	1	2.1	1	0	1	0.8
3:15-3:30	0	0	0	0.0	1	0	1	2.1	1	0	1	0.8
3:30-3:45	0	0	0	0.0	0	0	0	0.0	0	0	0	0.0
3:45-4:00	0	0	0	0.0	0	0	0	0.0	0	0	0	0.0
1時間計	0	0	0	0.0	2	0	2	4.2	2	0	2	1.6
4:00-4:15	0	0	0	0.0	1	0	1	2.1	1	0	1	0.8
4:15-4:30	0	0	0	0.0	0	0	0	0.0	0	0	0	0.0
4:30-4:45	0	2	2	2.7	0	0	0	0.0	0	2	2	1.6
4:45-5:00	0	0	0	0.0	0	0	0	0.0	0	0	0	0.0
1時間計	0	2	2	2.7	1	0	1	2.1	1	2	3	2.4
5:00-5:15	0	3	3	4.0	0	0	0	0.0	0	3	3	2.4
5:15-5:30	0	1	1	1.3	0	0	0	0.0	0	1	1	0.8
5:30-5:45	0	2	2	2.7	0	0	0	0.0	0	2	2	1.6
5:45-6:00	0	0	0	0.0	0	0	0	0.0	0	0	0	0.0
1時間計	0	6	6	8.0	0	0	0	0.0	0	6	6	4.9

歩行者通行量調査表

調査地点：地域社会2 目黒交番前

調査年月日：令和元年10月13日(日) 天候：曇りのち雨



時間帯	ア				イ				合計			
	歩行者 (人)	自転車 (台)	合計 (人・台)	時間 係数 (%)	歩行者 (人)	自転車 (台)	合計 (人・台)	時間 係数 (%)	歩行者 (人)	自転車 (台)	合計 (人・台)	時間 係数 (%)
6:00-6:15	1	0	1	1.3	0	1	1	2.1	1	1	2	1.6
6:15-6:30	0	0	0	0.0	0	0	0	0.0	0	0	0	0.0
6:30-6:45	1	1	2	2.7	0	0	0	0.0	1	1	2	1.6
6:45-7:00	0	3	3	4.0	0	0	0	0.0	0	3	3	2.4
1時間計	2	4	6	8.0	0	1	1	2.1	2	5	7	5.7
7:00-7:15	1	1	2	2.7	0	0	0	0.0	1	1	2	1.6
7:15-7:30	1	1	2	2.7	0	2	2	4.2	1	3	4	3.3
7:30-7:45	0	1	1	1.3	0	0	0	0.0	0	1	1	0.8
7:45-8:00	0	2	2	2.7	0	0	0	0.0	0	2	2	1.6
1時間計	2	5	7	9.3	0	2	2	4.2	2	7	9	7.3
8:00-8:15	0	0	0	0.0	0	0	0	0.0	0	0	0	0.0
8:15-8:30	1	2	3	4.0	1	1	2	4.2	2	3	5	4.1
8:30-8:45	0	3	3	4.0	1	4	5	10.4	1	7	8	6.5
8:45-9:00	1	3	4	5.3	1	0	1	2.1	2	3	5	4.1
1時間計	2	8	10	13.3	3	5	8	16.7	5	13	18	14.6
9:00-9:15	0	0	0	0.0	1	1	2	4.2	1	1	2	1.6
9:15-9:30	0	0	0	0.0	0	0	0	0.0	0	0	0	0.0
9:30-9:45	1	1	2	2.7	0	0	0	0.0	1	1	2	1.6
9:45-10:00	1	0	1	1.3	1	1	2	4.2	2	1	3	2.4
1時間計	2	1	3	4.0	2	2	4	8.3	4	3	7	5.7
10:00-10:15	0	0	0	0.0	0	0	0	0.0	0	0	0	0.0
10:15-10:30	0	0	0	0.0	0	0	0	0.0	0	0	0	0.0
10:30-10:45	0	1	1	1.3	0	0	0	0.0	0	1	1	0.8
10:45-11:00	0	1	1	1.3	0	0	0	0.0	0	1	1	0.8
1時間計	0	2	2	2.7	0	0	0	0.0	0	2	2	1.6
11:00-11:15	0	0	0	0.0	0	0	0	0.0	0	0	0	0.0
11:15-11:30	0	0	0	0.0	0	0	0	0.0	0	0	0	0.0
11:30-11:45	0	0	0	0.0	0	0	0	0.0	0	0	0	0.0
11:45-12:00	0	0	0	0.0	0	0	0	0.0	0	0	0	0.0
1時間計	0	0	0	0.0	0	0	0	0.0	0	0	0	0.0
12:00-12:15	0	0	0	0.0	0	1	1	2.1	0	1	1	0.8
12:15-12:30	1	2	3	4.0	0	1	1	2.1	1	3	4	3.3
12:30-12:45	0	1	1	1.3	0	2	2	4.2	0	3	3	2.4
12:45-13:00	1	0	1	1.3	0	0	0	0.0	1	0	1	0.8
1時間計	2	3	5	6.7	0	4	4	8.3	2	7	9	7.3
13:00-13:15	0	0	0	0.0	0	0	0	0.0	0	0	0	0.0
13:15-13:30	1	2	3	4.0	0	1	1	2.1	1	3	4	3.3
13:30-13:45	2	0	2	2.7	0	1	1	2.1	2	1	3	2.4
13:45-14:00	0	0	0	0.0	0	0	0	0.0	0	0	0	0.0
1時間計	3	2	5	6.7	0	2	2	4.2	3	4	7	5.7

歩行者通行量調査表

調査地点：地域社会2 目黒交番前

調査年月日：令和元年10月13日(日) 天候：曇りのち雨



方向	ア				イ				合計			
	歩行者 (人)	自転車 (台)	合計 (人・台)	時間 係数 (%)	歩行者 (人)	自転車 (台)	合計 (人・台)	時間 係数 (%)	歩行者 (人)	自転車 (台)	合計 (人・台)	時間 係数 (%)
14:00-14:15	0	0	0	0.0	1	0	1	2.1	1	0	1	0.8
14:15-14:30	0	0	0	0.0	0	0	0	0.0	0	0	0	0.0
14:30-14:45	0	0	0	0.0	0	0	0	0.0	0	0	0	0.0
14:45-15:00	0	0	0	0.0	0	0	0	0.0	0	0	0	0.0
1時間計	0	0	0	0.0	1	0	1	2.1	1	0	1	0.8
15:00-15:15	1	0	1	1.3	0	0	0	0.0	1	0	1	0.8
15:15-15:30	0	0	0	0.0	0	1	1	2.1	0	1	1	0.8
15:30-15:45	0	0	0	0.0	1	0	1	2.1	1	0	1	0.8
15:45-16:00	0	1	1	1.3	0	0	0	0.0	0	1	1	0.8
1時間計	1	1	2	2.7	1	1	2	4.2	2	2	4	3.3
16:00-16:15	0	0	0	0.0	0	0	0	0.0	0	0	0	0.0
16:15-16:30	0	0	0	0.0	0	0	0	0.0	0	0	0	0.0
16:30-16:45	0	0	0	0.0	0	0	0	0.0	0	0	0	0.0
16:45-17:00	0	0	0	0.0	0	0	0	0.0	0	0	0	0.0
1時間計	0	0	0	0.0	0	0	0	0.0	0	0	0	0.0
17:00-17:15	0	0	0	0.0	0	0	0	0.0	0	0	0	0.0
17:15-17:30	1	0	1	1.3	1	2	3	6.3	2	2	4	3.3
17:30-17:45	0	0	0	0.0	0	0	0	0.0	0	0	0	0.0
17:45-18:00	1	0	1	1.3	1	3	4	8.3	2	3	5	4.1
1時間計	2	0	2	2.7	2	5	7	14.6	4	5	9	7.3
18:00-18:15	1	0	1	1.3	0	1	1	2.1	1	1	2	1.6
18:15-18:30	1	2	3	4.0	0	1	1	2.1	1	3	4	3.3
18:30-18:45	0	2	2	2.7	0	0	0	0.0	0	2	2	1.6
18:45-19:00	0	0	0	0.0	0	0	0	0.0	0	0	0	0.0
1時間計	2	4	6	8.0	0	2	2	4.2	2	6	8	6.5
19:00-19:15	0	0	0	0.0	0	1	1	2.1	0	1	1	0.8
19:15-19:30	0	0	0	0.0	0	1	1	2.1	0	1	1	0.8
19:30-19:45	0	0	0	0.0	0	0	0	0.0	0	0	0	0.0
19:45-20:00	1	0	1	1.3	0	0	0	0.0	1	0	1	0.8
1時間計	1	0	1	1.3	0	2	2	4.2	1	2	3	2.4
20:00-20:15	0	0	0	0.0	0	1	1	2.1	0	1	1	0.8
20:15-20:30	1	0	1	1.3	0	0	0	0.0	1	0	1	0.8
20:30-20:45	1	0	1	1.3	0	1	1	2.1	1	1	2	1.6
20:45-21:00	0	2	2	2.7	0	0	0	0.0	0	2	2	1.6
1時間計	2	2	4	5.3	0	2	2	4.2	2	4	6	4.9
21:00-21:15	1	3	4	5.3	0	0	0	0.0	1	3	4	3.3
21:15-21:30	0	0	0	0.0	0	0	0	0.0	0	0	0	0.0
21:30-21:45	1	0	1	1.3	0	0	0	0.0	1	0	1	0.8
21:45-22:00	0	0	0	0.0	0	1	1	2.1	0	1	1	0.8
1時間計	2	3	5	6.7	0	1	1	2.1	2	4	6	4.9
昼12時間計	16	26	42	56.0	9	23	32	66.7	25	49	74	60.2
夜12時間計	9	24	33	44.0	3	13	16	33.3	12	37	49	39.8
全時間合計	25	50	75	100.0	12	36	48	100.0	37	86	123	100.0
昼夜率	1.56	1.92	1.79	-	1.33	1.57	1.50	-	1.48	1.76	1.66	-

歩行者通行量調査表

調査地点：地域社会2 目黒交番前

調査年月日：令和元年10月13日(日) 天候：曇りのち雨



時間帯	ウ				エ				合計			
	歩行者 (人)	自転車 (台)	合計 (人・台)	時間 係数 (%)	歩行者 (人)	自転車 (台)	合計 (人・台)	時間 係数 (%)	歩行者 (人)	自転車 (台)	合計 (人・台)	時間 係数 (%)
22:00-22:15	0	0	0	0.0	0	0	0	0.0	0	0	0	0.0
22:15-22:30	0	0	0	0.0	0	0	0	0.0	0	0	0	0.0
22:30-22:45	0	0	0	0.0	0	2	2	6.1	0	2	2	4.1
22:45-23:00	0	1	1	6.3	0	0	0	0.0	0	1	1	2.0
1時間計	0	1	1	6.3	0	2	2	6.1	0	3	3	6.1
23:00-23:15	0	0	0	0.0	0	0	0	0.0	0	0	0	0.0
23:15-23:30	0	0	0	0.0	0	0	0	0.0	0	0	0	0.0
23:30-23:45	0	0	0	0.0	0	0	0	0.0	0	0	0	0.0
23:45-24:00	0	1	1	6.3	0	0	0	0.0	0	1	1	2.0
1時間計	0	1	1	6.3	0	0	0	0.0	0	1	1	2.0
0:00-0:15	0	0	0	0.0	0	0	0	0.0	0	0	0	0.0
0:15-0:30	0	0	0	0.0	0	0	0	0.0	0	0	0	0.0
0:30-0:45	0	0	0	0.0	2	1	3	9.1	2	1	3	6.1
0:45-1:00	0	0	0	0.0	0	0	0	0.0	0	0	0	0.0
1時間計	0	0	0	0.0	2	1	3	9.1	2	1	3	6.1
1:00-1:15	0	0	0	0.0	0	0	0	0.0	0	0	0	0.0
1:15-1:30	0	0	0	0.0	0	0	0	0.0	0	0	0	0.0
1:30-1:45	0	0	0	0.0	0	0	0	0.0	0	0	0	0.0
1:45-2:00	0	0	0	0.0	0	0	0	0.0	0	0	0	0.0
1時間計	0	0	0	0.0	0	0	0	0.0	0	0	0	0.0
2:00-2:15	0	0	0	0.0	0	0	0	0.0	0	0	0	0.0
2:15-2:30	0	0	0	0.0	0	0	0	0.0	0	0	0	0.0
2:30-2:45	0	0	0	0.0	0	0	0	0.0	0	0	0	0.0
2:45-3:00	0	0	0	0.0	0	0	0	0.0	0	0	0	0.0
1時間計	0	0	0	0.0	0	0	0	0.0	0	0	0	0.0
3:00-3:15	0	0	0	0.0	1	0	1	3.0	1	0	1	2.0
3:15-3:30	0	0	0	0.0	0	0	0	0.0	0	0	0	0.0
3:30-3:45	0	0	0	0.0	0	0	0	0.0	0	0	0	0.0
3:45-4:00	0	0	0	0.0	0	0	0	0.0	0	0	0	0.0
1時間計	0	0	0	0.0	1	0	1	3.0	1	0	1	2.0
4:00-4:15	0	0	0	0.0	0	0	0	0.0	0	0	0	0.0
4:15-4:30	0	0	0	0.0	0	0	0	0.0	0	0	0	0.0
4:30-4:45	0	0	0	0.0	0	0	0	0.0	0	0	0	0.0
4:45-5:00	0	0	0	0.0	0	0	0	0.0	0	0	0	0.0
1時間計	0	0	0	0.0	0	0	0	0.0	0	0	0	0.0
5:00-5:15	0	0	0	0.0	0	0	0	0.0	0	0	0	0.0
5:15-5:30	0	0	0	0.0	0	0	0	0.0	0	0	0	0.0
5:30-5:45	0	0	0	0.0	1	0	1	3.0	1	0	1	2.0
5:45-6:00	0	0	0	0.0	0	0	0	0.0	0	0	0	0.0
1時間計	0	0	0	0.0	1	0	1	3.0	1	0	1	2.0

歩行者通行量調査表

調査地点：地域社会2 目黒交番前

調査年月日：令和元年10月13日(日) 天候：曇りのち雨



時間帯	ウ				エ				合計			
	歩行者 (人)	自転車 (台)	合計 (人・台)	時間 係数 (%)	歩行者 (人)	自転車 (台)	合計 (人・台)	時間 係数 (%)	歩行者 (人)	自転車 (台)	合計 (人・台)	時間 係数 (%)
6:00-6:15	0	0	0	0.0	0	0	0	0.0	0	0	0	0.0
6:15-6:30	0	0	0	0.0	0	0	0	0.0	0	0	0	0.0
6:30-6:45	0	1	1	6.3	0	0	0	0.0	0	1	1	2.0
6:45-7:00	0	0	0	0.0	0	0	0	0.0	0	0	0	0.0
1時間計	0	1	1	6.3	0	0	0	0.0	0	1	1	2.0
7:00-7:15	0	0	0	0.0	0	0	0	0.0	0	0	0	0.0
7:15-7:30	0	0	0	0.0	0	2	2	6.1	0	2	2	4.1
7:30-7:45	1	0	1	6.3	0	0	0	0.0	1	0	1	2.0
7:45-8:00	1	1	2	12.5	1	0	1	3.0	2	1	3	6.1
1時間計	2	1	3	18.8	1	2	3	9.1	3	3	6	12.2
8:00-8:15	1	0	1	6.3	1	0	1	3.0	2	0	2	4.1
8:15-8:30	1	1	2	12.5	1	1	2	6.1	2	2	4	8.2
8:30-8:45	1	1	2	12.5	2	1	3	9.1	3	2	5	10.2
8:45-9:00	0	0	0	0.0	2	0	2	6.1	2	0	2	4.1
1時間計	3	2	5	31.3	6	2	8	24.2	9	4	13	26.5
9:00-9:15	0	0	0	0.0	0	0	0	0.0	0	0	0	0.0
9:15-9:30	0	0	0	0.0	0	0	0	0.0	0	0	0	0.0
9:30-9:45	0	0	0	0.0	0	0	0	0.0	0	0	0	0.0
9:45-10:00	0	0	0	0.0	0	0	0	0.0	0	0	0	0.0
1時間計	0	0	0	0.0	0	0	0	0.0	0	0	0	0.0
10:00-10:15	0	0	0	0.0	1	0	1	3.0	1	0	1	2.0
10:15-10:30	0	1	1	6.3	0	0	0	0.0	0	1	1	2.0
10:30-10:45	0	0	0	0.0	0	1	1	3.0	0	1	1	2.0
10:45-11:00	0	0	0	0.0	0	0	0	0.0	0	0	0	0.0
1時間計	0	1	1	6.3	1	1	2	6.1	1	2	3	6.1
11:00-11:15	2	0	2	12.5	0	0	0	0.0	2	0	2	4.1
11:15-11:30	0	0	0	0.0	0	0	0	0.0	0	0	0	0.0
11:30-11:45	0	0	0	0.0	0	0	0	0.0	0	0	0	0.0
11:45-12:00	1	0	1	6.3	0	0	0	0.0	1	0	1	2.0
1時間計	3	0	3	18.8	0	0	0	0.0	3	0	3	6.1
12:00-12:15	0	0	0	0.0	0	0	0	0.0	0	0	0	0.0
12:15-12:30	0	1	1	6.3	0	0	0	0.0	0	1	1	2.0
12:30-12:45	0	0	0	0.0	0	1	1	3.0	0	1	1	2.0
12:45-13:00	0	0	0	0.0	0	0	0	0.0	0	0	0	0.0
1時間計	0	1	1	6.3	0	1	1	3.0	0	2	2	4.1
13:00-13:15	0	0	0	0.0	0	0	0	0.0	0	0	0	0.0
13:15-13:30	0	0	0	0.0	0	0	0	0.0	0	0	0	0.0
13:30-13:45	0	0	0	0.0	0	0	0	0.0	0	0	0	0.0
13:45-14:00	0	0	0	0.0	0	0	0	0.0	0	0	0	0.0
1時間計	0	0	0	0.0	0	0	0	0.0	0	0	0	0.0

歩行者通行量調査表

調査地点：地域社会2 目黒交番前

調査年月日：令和元年10月13日(日) 天候：曇りのち雨



時間帯	ウ				エ				合計			
	歩行者 (人)	自転車 (台)	合計 (人・台)	時間 係数 (%)	歩行者 (人)	自転車 (台)	合計 (人・台)	時間 係数 (%)	歩行者 (人)	自転車 (台)	合計 (人・台)	時間 係数 (%)
14:00-14:15	0	0	0	0.0	0	0	0	0.0	0	0	0	0.0
14:15-14:30	0	0	0	0.0	0	0	0	0.0	0	0	0	0.0
14:30-14:45	0	0	0	0.0	0	0	0	0.0	0	0	0	0.0
14:45-15:00	0	0	0	0.0	0	0	0	0.0	0	0	0	0.0
1時間計	0	0	0	0.0	0	0	0	0.0	0	0	0	0.0
15:00-15:15	0	0	0	0.0	0	0	0	0.0	0	0	0	0.0
15:15-15:30	0	0	0	0.0	1	0	1	3.0	1	0	1	2.0
15:30-15:45	0	0	0	0.0	2	2	4	12.1	2	2	4	8.2
15:45-16:00	0	0	0	0.0	0	1	1	3.0	0	1	1	2.0
1時間計	0	0	0	0.0	3	3	6	18.2	3	3	6	12.2
16:00-16:15	0	0	0	0.0	0	0	0	0.0	0	0	0	0.0
16:15-16:30	0	0	0	0.0	0	0	0	0.0	0	0	0	0.0
16:30-16:45	0	0	0	0.0	0	3	3	9.1	0	3	3	6.1
16:45-17:00	0	0	0	0.0	0	0	0	0.0	0	0	0	0.0
1時間計	0	0	0	0.0	0	3	3	9.1	0	3	3	6.1
17:00-17:15	0	0	0	0.0	0	0	0	0.0	0	0	0	0.0
17:15-17:30	0	0	0	0.0	0	0	0	0.0	0	0	0	0.0
17:30-17:45	0	0	0	0.0	0	0	0	0.0	0	0	0	0.0
17:45-18:00	0	0	0	0.0	0	0	0	0.0	0	0	0	0.0
1時間計	0	0	0	0.0	0	0	0	0.0	0	0	0	0.0
18:00-18:15	0	0	0	0.0	0	0	0	0.0	0	0	0	0.0
18:15-18:30	0	0	0	0.0	1	0	1	3.0	1	0	1	2.0
18:30-18:45	0	0	0	0.0	0	0	0	0.0	0	0	0	0.0
18:45-19:00	0	0	0	0.0	0	0	0	0.0	0	0	0	0.0
1時間計	0	0	0	0.0	1	0	1	3.0	1	0	1	2.0
19:00-19:15	0	0	0	0.0	0	0	0	0.0	0	0	0	0.0
19:15-19:30	0	0	0	0.0	0	0	0	0.0	0	0	0	0.0
19:30-19:45	0	0	0	0.0	0	0	0	0.0	0	0	0	0.0
19:45-20:00	0	0	0	0.0	0	0	0	0.0	0	0	0	0.0
1時間計	0	0	0	0.0	0	0	0	0.0	0	0	0	0.0
20:00-20:15	0	0	0	0.0	0	0	0	0.0	0	0	0	0.0
20:15-20:30	0	0	0	0.0	0	0	0	0.0	0	0	0	0.0
20:30-20:45	0	0	0	0.0	0	0	0	0.0	0	0	0	0.0
20:45-21:00	0	0	0	0.0	0	0	0	0.0	0	0	0	0.0
1時間計	0	0	0	0.0	0	0	0	0.0	0	0	0	0.0
21:00-21:15	0	0	0	0.0	0	0	0	0.0	0	0	0	0.0
21:15-21:30	0	0	0	0.0	0	1	1	3.0	0	1	1	2.0
21:30-21:45	0	0	0	0.0	0	0	0	0.0	0	0	0	0.0
21:45-22:00	0	0	0	0.0	0	1	1	3.0	0	1	1	2.0
1時間計	0	0	0	0.0	0	2	2	6.1	0	2	2	4.1
昼12時間計	8	5	13	81.3	12	12	24	72.7	20	17	37	75.5
夜12時間計	0	3	3	18.8	4	5	9	27.3	4	8	12	24.5
全時間合計	8	8	16	100.0	16	17	33	100.0	24	25	49	100.0
昼夜率	1.00	1.60	1.23	-	1.33	1.42	1.38	-	1.20	1.47	1.32	-

歩行者通行量調査表

調査地点：地域社会2 目黒交番前

調査年月日：令和元年10月13日(日) 天候：曇りのち雨



時間帯	方向				合計							
	歩行者 (人)	自転車 (台)	合計 (人・台)	時間 係数 (%)	歩行者 (人)	自転車 (台)	合計 (人・台)	時間 係数 (%)	歩行者 (人)	自転車 (台)	合計 (人・台)	時間 係数 (%)
22:00-22:15	0	0	0	0.0	0	0	0	0.0	0	0	0	0.0
22:15-22:30	0	2	2	3.9	0	0	0	0.0	0	2	2	2.2
22:30-22:45	0	0	0	0.0	0	1	1	2.6	0	1	1	1.1
22:45-23:00	0	0	0	0.0	0	0	0	0.0	0	0	0	0.0
1時間計	0	2	2	3.9	0	1	1	2.6	0	3	3	3.3
23:00-23:15	0	1	1	2.0	0	0	0	0.0	0	1	1	1.1
23:15-23:30	0	0	0	0.0	0	0	0	0.0	0	0	0	0.0
23:30-23:45	0	1	1	2.0	0	0	0	0.0	0	1	1	1.1
23:45-24:00	0	0	0	0.0	0	0	0	0.0	0	0	0	0.0
1時間計	0	2	2	3.9	0	0	0	0.0	0	2	2	2.2
0:00-0:15	0	0	0	0.0	0	0	0	0.0	0	0	0	0.0
0:15-0:30	0	1	1	2.0	0	0	0	0.0	0	1	1	1.1
0:30-0:45	0	0	0	0.0	0	0	0	0.0	0	0	0	0.0
0:45-1:00	0	0	0	0.0	0	0	0	0.0	0	0	0	0.0
1時間計	0	1	1	2.0	0	0	0	0.0	0	1	1	1.1
1:00-1:15	0	0	0	0.0	0	0	0	0.0	0	0	0	0.0
1:15-1:30	0	0	0	0.0	0	0	0	0.0	0	0	0	0.0
1:30-1:45	0	0	0	0.0	0	0	0	0.0	0	0	0	0.0
1:45-2:00	0	0	0	0.0	0	0	0	0.0	0	0	0	0.0
1時間計	0	0	0	0.0	0	0	0	0.0	0	0	0	0.0
2:00-2:15	0	0	0	0.0	0	0	0	0.0	0	0	0	0.0
2:15-2:30	0	0	0	0.0	0	0	0	0.0	0	0	0	0.0
2:30-2:45	0	0	0	0.0	0	0	0	0.0	0	0	0	0.0
2:45-3:00	0	0	0	0.0	1	0	1	2.6	1	0	1	1.1
1時間計	0	0	0	0.0	1	0	1	2.6	1	0	1	1.1
3:00-3:15	0	0	0	0.0	0	0	0	0.0	0	0	0	0.0
3:15-3:30	0	0	0	0.0	0	0	0	0.0	0	0	0	0.0
3:30-3:45	0	0	0	0.0	0	0	0	0.0	0	0	0	0.0
3:45-4:00	0	1	1	2.0	0	0	0	0.0	0	1	1	1.1
1時間計	0	1	1	2.0	0	0	0	0.0	0	1	1	1.1
4:00-4:15	0	1	1	2.0	1	0	1	2.6	1	1	2	2.2
4:15-4:30	0	0	0	0.0	0	0	0	0.0	0	0	0	0.0
4:30-4:45	0	0	0	0.0	0	0	0	0.0	0	0	0	0.0
4:45-5:00	0	0	0	0.0	0	0	0	0.0	0	0	0	0.0
1時間計	0	1	1	2.0	1	0	1	2.6	1	1	2	2.2
5:00-5:15	0	0	0	0.0	1	0	1	2.6	1	0	1	1.1
5:15-5:30	1	0	1	2.0	0	0	0	0.0	1	0	1	1.1
5:30-5:45	0	0	0	0.0	0	0	0	0.0	0	0	0	0.0
5:45-6:00	0	0	0	0.0	0	1	1	2.6	0	1	1	1.1
1時間計	1	0	1	2.0	1	1	2	5.1	2	1	3	3.3

歩行者通行量調査表

調査地点：地域社会2 目黒交番前

調査年月日：令和元年10月13日(日) 天候：曇りのち雨



時間帯	方向				合計							
	歩行者 (人)	自転車 (台)	合計 (人・台)	時間係数 (%)	歩行者 (人)	自転車 (台)	合計 (人・台)	時間係数 (%)	歩行者 (人)	自転車 (台)	合計 (人・台)	時間係数 (%)
6:00-6:15	0	2	2	3.9	0	0	0	0.0	0	2	2	2.2
6:15-6:30	2	1	3	5.9	1	1	2	5.1	3	2	5	5.6
6:30-6:45	2	0	2	3.9	0	0	0	0.0	2	0	2	2.2
6:45-7:00	0	0	0	0.0	2	0	2	5.1	2	0	2	2.2
1時間計	4	3	7	13.7	3	1	4	10.3	7	4	11	12.2
7:00-7:15	0	0	0	0.0	0	0	0	0.0	0	0	0	0.0
7:15-7:30	2	0	2	3.9	0	1	1	2.6	2	1	3	3.3
7:30-7:45	0	0	0	0.0	0	0	0	0.0	0	0	0	0.0
7:45-8:00	1	0	1	2.0	0	0	0	0.0	1	0	1	1.1
1時間計	3	0	3	5.9	0	1	1	2.6	3	1	4	4.4
8:00-8:15	0	1	1	2.0	1	2	3	7.7	1	3	4	4.4
8:15-8:30	1	0	1	2.0	2	1	3	7.7	3	1	4	4.4
8:30-8:45	0	0	0	0.0	0	1	1	2.6	0	1	1	1.1
8:45-9:00	0	0	0	0.0	0	0	0	0.0	0	0	0	0.0
1時間計	1	1	2	3.9	3	4	7	17.9	4	5	9	10.0
9:00-9:15	0	0	0	0.0	0	1	1	2.6	0	1	1	1.1
9:15-9:30	0	0	0	0.0	0	0	0	0.0	0	0	0	0.0
9:30-9:45	0	0	0	0.0	0	0	0	0.0	0	0	0	0.0
9:45-10:00	0	0	0	0.0	0	0	0	0.0	0	0	0	0.0
1時間計	0	0	0	0.0	0	1	1	2.6	0	1	1	1.1
10:00-10:15	0	0	0	0.0	1	0	1	2.6	1	0	1	1.1
10:15-10:30	0	1	1	2.0	0	0	0	0.0	0	1	1	1.1
10:30-10:45	1	0	1	2.0	0	0	0	0.0	1	0	1	1.1
10:45-11:00	0	1	1	2.0	0	0	0	0.0	0	1	1	1.1
1時間計	1	2	3	5.9	1	0	1	2.6	2	2	4	4.4
11:00-11:15	0	1	1	2.0	0	0	0	0.0	0	1	1	1.1
11:15-11:30	0	0	0	0.0	0	0	0	0.0	0	0	0	0.0
11:30-11:45	0	1	1	2.0	0	1	1	2.6	0	2	2	2.2
11:45-12:00	0	0	0	0.0	0	1	1	2.6	0	1	1	1.1
1時間計	0	2	2	3.9	0	2	2	5.1	0	4	4	4.4
12:00-12:15	2	0	2	3.9	0	1	1	2.6	2	1	3	3.3
12:15-12:30	1	0	1	2.0	0	0	0	0.0	1	0	1	1.1
12:30-12:45	0	0	0	0.0	0	0	0	0.0	0	0	0	0.0
12:45-13:00	0	1	1	2.0	0	0	0	0.0	0	1	1	1.1
1時間計	3	1	4	7.8	0	1	1	2.6	3	2	5	5.6
13:00-13:15	0	0	0	0.0	0	0	0	0.0	0	0	0	0.0
13:15-13:30	0	0	0	0.0	0	0	0	0.0	0	0	0	0.0
13:30-13:45	0	0	0	0.0	0	0	0	0.0	0	0	0	0.0
13:45-14:00	0	0	0	0.0	0	0	0	0.0	0	0	0	0.0
1時間計	0	0	0	0.0	0	0	0	0.0	0	0	0	0.0

歩行者通行量調査表

調査地点：地域社会2 目黒交番前

調査年月日：令和元年10月13日(日) 天候：曇りのち雨



方向	ア				カ				合計			
	歩行者 (人)	自転車 (台)	合計 (人・台)	時間 係数 (%)	歩行者 (人)	自転車 (台)	合計 (人・台)	時間 係数 (%)	歩行者 (人)	自転車 (台)	合計 (人・台)	時間 係数 (%)
14:00-14:15	0	0	0	0.0	0	0	0	0.0	0	0	0	0.0
14:15-14:30	0	0	0	0.0	0	0	0	0.0	0	0	0	0.0
14:30-14:45	0	0	0	0.0	0	0	0	0.0	0	0	0	0.0
14:45-15:00	0	0	0	0.0	0	0	0	0.0	0	0	0	0.0
1時間計	0	0	0	0.0	0	0	0	0.0	0	0	0	0.0
15:00-15:15	0	2	2	3.9	2	4	10.3	6.7	2	4	6	6.7
15:15-15:30	0	0	0	0.0	0	1	2.6	1.1	0	1	1	1.1
15:30-15:45	0	1	1	2.0	2	0	2	5.1	2	1	3	3.3
15:45-16:00	1	0	1	2.0	0	0	0	0.0	1	0	1	1.1
1時間計	1	3	4	7.8	4	3	7	17.9	5	6	11	12.2
16:00-16:15	0	1	1	2.0	0	1	2.6	0	2	2	2	2.2
16:15-16:30	2	0	2	3.9	0	0	0	0.0	2	0	2	2.2
16:30-16:45	0	0	0	0.0	0	5	12.8	5.6	0	5	5	5.6
16:45-17:00	0	0	0	0.0	0	0	0	0.0	0	0	0	0.0
1時間計	2	1	3	5.9	0	6	15.4	10.0	2	7	9	10.0
17:00-17:15	0	1	1	2.0	0	0	0	0.0	0	1	1	1.1
17:15-17:30	1	1	2	3.9	0	0	0	0.0	1	1	2	2.2
17:30-17:45	1	0	1	2.0	0	1	2.6	1.1	1	1	2	2.2
17:45-18:00	1	0	1	2.0	2	0	2	5.1	3	0	3	3.3
1時間計	3	2	5	9.8	2	1	3	7.7	5	3	8	8.9
18:00-18:15	0	2	2	3.9	0	0	0	0.0	0	2	2	2.2
18:15-18:30	1	1	2	3.9	0	0	0	0.0	1	1	2	2.2
18:30-18:45	0	0	0	0.0	0	0	0	0.0	0	0	0	0.0
18:45-19:00	0	1	1	2.0	0	0	0	0.0	0	1	1	1.1
1時間計	1	4	5	9.8	0	0	0	0.0	1	4	5	5.6
19:00-19:15	0	0	0	0.0	0	0	0	0.0	0	0	0	0.0
19:15-19:30	0	0	0	0.0	0	0	0	0.0	0	0	0	0.0
19:30-19:45	0	0	0	0.0	0	0	0	0.0	0	0	0	0.0
19:45-20:00	0	0	0	0.0	0	0	0	0.0	0	0	0	0.0
1時間計	0	0	0	0.0	0	0	0	0.0	0	0	0	0.0
20:00-20:15	0	0	0	0.0	0	0	0	0.0	0	0	0	0.0
20:15-20:30	0	0	0	0.0	0	0	0	0.0	0	0	0	0.0
20:30-20:45	2	1	3	5.9	0	0	0	0.0	2	1	3	3.3
20:45-21:00	0	0	0	0.0	0	0	0	0.0	0	0	0	0.0
1時間計	2	1	3	5.9	0	0	0	0.0	2	1	3	3.3
21:00-21:15	1	1	2	3.9	0	0	0	0.0	1	1	2	2.2
21:15-21:30	0	0	0	0.0	0	0	0	0.0	0	0	0	0.0
21:30-21:45	0	0	0	0.0	0	1	2.6	1.1	0	1	1	1.1
21:45-22:00	0	0	0	0.0	0	0	0	0.0	0	0	0	0.0
1時間計	1	1	2	3.9	0	1	2.6	1.1	1	2	3	3.3
昼12時間計	15	16	31	60.8	10	19	29	74.4	25	35	60	66.7
夜12時間計	8	12	20	39.2	6	4	10	25.6	14	16	30	33.3
全時間合計	23	28	51	100.0	16	23	39	100.0	39	51	90	100.0
昼夜率	1.53	1.75	1.65	-	1.60	1.21	1.34	-	1.56	1.46	1.50	-

歩行者通行量調査表

調査地点：地域社会2 目黒交番前

調査年月日：令和元年10月13日(日) 天候：曇りのち雨



時間帯	キ				ケ				合計			
	歩行者 (人)	自転車 (台)	合計 (人・台)	時間 係数 (%)	歩行者 (人)	自転車 (台)	合計 (人・台)	時間 係数 (%)	歩行者 (人)	自転車 (台)	合計 (人・台)	時間 係数 (%)
22:00-22:15	0	1	1	2.2	0	0	0	0.0	0	1	1	1.2
22:15-22:30	0	0	0	0.0	1	0	1	2.9	1	0	1	1.2
22:30-22:45	0	1	1	2.2	0	0	0	0.0	0	1	1	1.2
22:45-23:00	0	0	0	0.0	0	1	1	2.9	0	1	1	1.2
1時間計	0	2	2	4.3	1	1	2	5.7	1	3	4	4.9
23:00-23:15	0	1	1	2.2	0	0	0	0.0	0	1	1	1.2
23:15-23:30	0	0	0	0.0	0	0	0	0.0	0	0	0	0.0
23:30-23:45	0	0	0	0.0	0	0	0	0.0	0	0	0	0.0
23:45-24:00	0	1	1	2.2	0	0	0	0.0	0	1	1	1.2
1時間計	0	2	2	4.3	0	0	0	0.0	0	2	2	2.5
0:00-0:15	0	0	0	0.0	0	0	0	0.0	0	0	0	0.0
0:15-0:30	0	0	0	0.0	1	1	2	5.7	1	1	2	2.5
0:30-0:45	1	1	2	4.3	0	0	0	0.0	1	1	2	2.5
0:45-1:00	0	0	0	0.0	0	0	0	0.0	0	0	0	0.0
1時間計	1	1	2	4.3	1	1	2	5.7	2	2	4	4.9
1:00-1:15	0	0	0	0.0	0	0	0	0.0	0	0	0	0.0
1:15-1:30	0	0	0	0.0	0	0	0	0.0	0	0	0	0.0
1:30-1:45	0	0	0	0.0	0	0	0	0.0	0	0	0	0.0
1:45-2:00	0	0	0	0.0	0	0	0	0.0	0	0	0	0.0
1時間計	0	0	0	0.0	0	0	0	0.0	0	0	0	0.0
2:00-2:15	0	1	1	2.2	0	0	0	0.0	0	1	1	1.2
2:15-2:30	0	0	0	0.0	0	0	0	0.0	0	0	0	0.0
2:30-2:45	0	0	0	0.0	0	0	0	0.0	0	0	0	0.0
2:45-3:00	0	0	0	0.0	1	0	1	2.9	1	0	1	1.2
1時間計	0	1	1	2.2	1	0	1	2.9	1	1	2	2.5
3:00-3:15	0	0	0	0.0	1	0	1	2.9	1	0	1	1.2
3:15-3:30	0	1	1	2.2	0	0	0	0.0	0	1	1	1.2
3:30-3:45	0	0	0	0.0	0	0	0	0.0	0	0	0	0.0
3:45-4:00	0	0	0	0.0	0	0	0	0.0	0	0	0	0.0
1時間計	0	1	1	2.2	1	0	1	2.9	1	1	2	2.5
4:00-4:15	0	0	0	0.0	0	0	0	0.0	0	0	0	0.0
4:15-4:30	0	0	0	0.0	0	0	0	0.0	0	0	0	0.0
4:30-4:45	0	0	0	0.0	0	0	0	0.0	0	0	0	0.0
4:45-5:00	0	0	0	0.0	0	0	0	0.0	0	0	0	0.0
1時間計	0	0	0	0.0	0	0	0	0.0	0	0	0	0.0
5:00-5:15	0	1	1	2.2	1	0	1	2.9	1	1	2	2.5
5:15-5:30	0	0	0	0.0	0	0	0	0.0	0	0	0	0.0
5:30-5:45	1	0	1	2.2	0	0	0	0.0	1	0	1	1.2
5:45-6:00	0	0	0	0.0	0	0	0	0.0	0	0	0	0.0
1時間計	1	1	2	4.3	1	0	1	2.9	2	1	3	3.7

歩行者通行量調査表

調査地点：地域社会2 目黒交番前

調査年月日：令和元年10月13日(日) 天候：曇りのち雨



時間帯	キ				ケ				合計			
	歩行者 (人)	自転車 (台)	合計 (人・台)	時間 係数 (%)	歩行者 (人)	自転車 (台)	合計 (人・台)	時間 係数 (%)	歩行者 (人)	自転車 (台)	合計 (人・台)	時間 係数 (%)
6:00-6:15	0	0	0	0.0	0	0	0	0.0	0	0	0	0.0
6:15-6:30	0	1	1	2.2	1	0	1	2.9	1	1	2	2.5
6:30-6:45	0	0	0	0.0	0	0	0	0.0	0	0	0	0.0
6:45-7:00	0	5	5	10.9	0	3	3	8.6	0	8	8	9.9
1時間計	0	6	6	13.0	1	3	4	11.4	1	9	10	12.3
7:00-7:15	0	1	1	2.2	0	0	0	0.0	0	1	1	1.2
7:15-7:30	2	1	3	6.5	0	0	0	0.0	2	1	3	3.7
7:30-7:45	0	1	1	2.2	0	1	1	2.9	0	2	2	2.5
7:45-8:00	1	0	1	2.2	0	1	1	2.9	1	1	2	2.5
1時間計	3	3	6	13.0	0	2	2	5.7	3	5	8	9.9
8:00-8:15	0	0	0	0.0	1	1	2	5.7	1	1	2	2.5
8:15-8:30	0	0	0	0.0	0	1	1	2.9	0	1	1	1.2
8:30-8:45	0	1	1	2.2	0	1	1	2.9	0	2	2	2.5
8:45-9:00	0	0	0	0.0	0	2	2	5.7	0	2	2	2.5
1時間計	0	1	1	2.2	1	5	6	17.1	1	6	7	8.6
9:00-9:15	0	0	0	0.0	0	0	0	0.0	0	0	0	0.0
9:15-9:30	0	0	0	0.0	0	1	1	2.9	0	1	1	1.2
9:30-9:45	0	0	0	0.0	0	0	0	0.0	0	0	0	0.0
9:45-10:00	0	0	0	0.0	0	0	0	0.0	0	0	0	0.0
1時間計	0	0	0	0.0	0	1	1	2.9	0	1	1	1.2
10:00-10:15	0	0	0	0.0	0	0	0	0.0	0	0	0	0.0
10:15-10:30	0	0	0	0.0	0	0	0	0.0	0	0	0	0.0
10:30-10:45	0	1	1	2.2	1	0	1	2.9	1	1	2	2.5
10:45-11:00	0	1	1	2.2	0	0	0	0.0	0	1	1	1.2
1時間計	0	2	2	4.3	1	0	1	2.9	1	2	3	3.7
11:00-11:15	0	1	1	2.2	0	0	0	0.0	0	1	1	1.2
11:15-11:30	0	0	0	0.0	0	0	0	0.0	0	0	0	0.0
11:30-11:45	0	1	1	2.2	0	1	1	2.9	0	2	2	2.5
11:45-12:00	0	0	0	0.0	1	0	1	2.9	1	0	1	1.2
1時間計	0	2	2	4.3	1	1	2	5.7	1	3	4	4.9
12:00-12:15	0	0	0	0.0	1	0	1	2.9	1	0	1	1.2
12:15-12:30	0	0	0	0.0	0	0	0	0.0	0	0	0	0.0
12:30-12:45	2	0	2	4.3	0	0	0	0.0	2	0	2	2.5
12:45-13:00	0	1	1	2.2	0	1	1	2.9	0	2	2	2.5
1時間計	2	1	3	6.5	1	1	2	5.7	3	2	5	6.2
13:00-13:15	0	0	0	0.0	0	0	0	0.0	0	0	0	0.0
13:15-13:30	0	0	0	0.0	1	0	1	2.9	1	0	1	1.2
13:30-13:45	0	0	0	0.0	0	0	0	0.0	0	0	0	0.0
13:45-14:00	1	0	1	2.2	0	0	0	0.0	1	0	1	1.2
1時間計	1	0	1	2.2	1	0	1	2.9	2	0	2	2.5

歩行者通行量調査表

調査地点：地域社会2 目黒交番前

調査年月日：令和元年10月13日(日) 天候：曇りのち雨



時間帯	キ				ク				合計			
	歩行者 (人)	自転車 (台)	合計 (人・台)	時間 係数 (%)	歩行者 (人)	自転車 (台)	合計 (人・台)	時間 係数 (%)	歩行者 (人)	自転車 (台)	合計 (人・台)	時間 係数 (%)
14:00-14:15	0	0	0	0.0	0	0	0	0.0	0	0	0	0.0
14:15-14:30	0	0	0	0.0	0	0	0	0.0	0	0	0	0.0
14:30-14:45	1	0	1	2.2	0	0	0	0.0	1	0	1	1.2
14:45-15:00	0	0	0	0.0	0	0	0	0.0	0	0	0	0.0
1時間計	1	0	1	2.2	0	0	0	0.0	1	0	1	1.2
15:00-15:15	0	1	1	2.2	0	0	0	0.0	0	1	1	1.2
15:15-15:30	0	1	1	2.2	0	0	0	0.0	0	1	1	1.2
15:30-15:45	0	0	0	0.0	0	0	0	0.0	0	0	0	0.0
15:45-16:00	0	0	0	0.0	0	0	0	0.0	0	0	0	0.0
1時間計	0	2	2	4.3	0	0	0	0.0	0	2	2	2.5
16:00-16:15	0	0	0	0.0	0	0	0	0.0	0	0	0	0.0
16:15-16:30	0	0	0	0.0	0	0	0	0.0	0	0	0	0.0
16:30-16:45	0	0	0	0.0	0	5	5	14.3	0	5	5	6.2
16:45-17:00	0	0	0	0.0	0	0	0	0.0	0	0	0	0.0
1時間計	0	0	0	0.0	0	5	5	14.3	0	5	5	6.2
17:00-17:15	1	2	3	6.5	0	1	1	2.9	1	3	4	4.9
17:15-17:30	0	1	1	2.2	0	0	0	0.0	0	1	1	1.2
17:30-17:45	0	0	0	0.0	1	0	1	2.9	1	0	1	1.2
17:45-18:00	0	0	0	0.0	0	0	0	0.0	0	0	0	0.0
1時間計	1	3	4	8.7	1	1	2	5.7	2	4	6	7.4
18:00-18:15	0	1	1	2.2	0	0	0	0.0	0	1	1	1.2
18:15-18:30	1	1	2	4.3	0	0	0	0.0	1	1	2	2.5
18:30-18:45	0	0	0	0.0	0	0	0	0.0	0	0	0	0.0
18:45-19:00	0	0	0	0.0	0	0	0	0.0	0	0	0	0.0
1時間計	1	2	3	6.5	0	0	0	0.0	1	2	3	3.7
19:00-19:15	0	0	0	0.0	0	0	0	0.0	0	0	0	0.0
19:15-19:30	0	0	0	0.0	0	0	0	0.0	0	0	0	0.0
19:30-19:45	0	0	0	0.0	0	0	0	0.0	0	0	0	0.0
19:45-20:00	0	0	0	0.0	0	0	0	0.0	0	0	0	0.0
1時間計	0	0	0	0.0	0	0	0	0.0	0	0	0	0.0
20:00-20:15	0	2	2	4.3	0	0	0	0.0	0	2	2	2.5
20:15-20:30	0	1	1	2.2	0	0	0	0.0	0	1	1	1.2
20:30-20:45	0	0	0	0.0	0	0	0	0.0	0	0	0	0.0
20:45-21:00	0	0	0	0.0	0	0	0	0.0	0	0	0	0.0
1時間計	0	3	3	6.5	0	0	0	0.0	0	3	3	3.7
21:00-21:15	0	0	0	0.0	0	0	0	0.0	0	0	0	0.0
21:15-21:30	0	2	2	4.3	0	0	0	0.0	0	2	2	2.5
21:30-21:45	0	0	0	0.0	0	2	2	5.7	0	2	2	2.5
21:45-22:00	0	0	0	0.0	0	0	0	0.0	0	0	0	0.0
1時間計	0	2	2	4.3	0	2	2	5.7	0	4	4	4.9
昼12時間計	9	16	25	54.3	6	16	22	62.9	15	32	47	58.0
夜12時間計	2	19	21	45.7	6	7	13	37.1	8	26	34	42.0
全時間合計	11	35	46	100.0	12	23	35	100.0	23	58	81	100.0
昼夜率	1.22	2.19	1.84	-	2.00	1.44	1.59	-	1.53	1.81	1.72	-

歩行者通行量調査表

調査地点：地域社会2 目黒交番前

調査年月日：令和元年10月13日(日) 天候：曇りのち雨



時間帯	種別	合計 (7+イ+ウ+エ+オ+カ+キ+ク)			時間係数 (%)
		歩行者 (人)	自転車 (台)	合計 (人・台)	
22:00-22:15		0	1	1	0.3
22:15-22:30		1	4	5	1.5
22:30-22:45		0	6	6	1.7
22:45-23:00		0	4	4	1.2
1時間計		1	15	16	4.7
23:00-23:15		0	3	3	0.9
23:15-23:30		0	2	2	0.6
23:30-23:45		0	2	2	0.6
23:45-24:00		0	5	5	1.5
1時間計		0	12	12	3.5
0:00-0:15		0	0	0	0.0
0:15-0:30		2	2	4	1.2
0:30-0:45		3	3	6	1.7
0:45-1:00		1	0	1	0.3
1時間計		6	5	11	3.2
1:00-1:15		0	0	0	0.0
1:15-1:30		0	0	0	0.0
1:30-1:45		0	0	0	0.0
1:45-2:00		0	0	0	0.0
1時間計		0	0	0	0.0
2:00-2:15		0	1	1	0.3
2:15-2:30		0	0	0	0.0
2:30-2:45		0	0	0	0.0
2:45-3:00		2	0	2	0.6
1時間計		2	1	3	0.9
3:00-3:15		3	0	3	0.9
3:15-3:30		1	1	2	0.6
3:30-3:45		0	0	0	0.0
3:45-4:00		0	1	1	0.3
1時間計		4	2	6	1.7
4:00-4:15		2	1	3	0.9
4:15-4:30		0	0	0	0.0
4:30-4:45		0	2	2	0.6
4:45-5:00		0	0	0	0.0
1時間計		2	3	5	1.5
5:00-5:15		2	4	6	1.7
5:15-5:30		1	1	2	0.6
5:30-5:45		2	2	4	1.2
5:45-6:00		0	1	1	0.3
1時間計		5	8	13	3.8
6:00-6:15		1	3	4	1.2
6:15-6:30		4	3	7	2.0
6:30-6:45		3	2	5	1.5
6:45-7:00		2	11	13	3.8
1時間計		10	19	29	8.5
7:00-7:15		1	2	3	0.9
7:15-7:30		5	7	12	3.5
7:30-7:45		1	3	4	1.2
7:45-8:00		4	4	8	2.3
1時間計		11	16	27	7.9
8:00-8:15		4	4	8	2.3
8:15-8:30		7	7	14	4.1
8:30-8:45		4	12	16	4.7
8:45-9:00		4	5	9	2.6
1時間計		19	28	47	13.7
9:00-9:15		1	2	3	0.9
9:15-9:30		0	1	1	0.3
9:30-9:45		1	1	2	0.6
9:45-10:00		2	1	3	0.9
1時間計		4	5	9	2.6

時間帯	種別	合計 (7+イ+ウ+エ+オ+カ+キ+ク)			時間係数 (%)
		歩行者 (人)	自転車 (台)	合計 (人・台)	
22:00-23:00		1	15	16	4.7
22:15-23:15		1	17	18	5.2
22:30-23:30		0	15	15	4.4
22:45-23:45		0	11	11	3.2
23:00-0:00		0	12	12	3.5
23:15-0:15		0	9	9	2.6
23:30-0:30		2	9	11	3.2
23:45-0:45		5	10	15	4.4
0:00-1:00		6	5	11	3.2
0:15-1:15		6	5	11	3.2
0:30-1:30		4	3	7	2.0
0:45-1:45		1	0	1	0.3
1:00-2:00		0	0	0	0.0
1:15-2:15		0	1	1	0.3
1:30-2:30		0	1	1	0.3
1:45-2:45		0	1	1	0.3
2:00-3:00		2	1	3	0.9
2:15-3:15		5	0	5	1.5
2:30-3:30		6	1	7	2.0
2:45-3:45		6	1	7	2.0
3:00-4:00		4	2	6	1.7
3:15-4:15		3	3	6	1.7
3:30-4:30		2	2	4	1.2
3:45-4:45		2	4	6	1.7
4:00-5:00		2	3	5	1.5
4:15-5:15		2	6	8	2.3
4:30-5:30		3	7	10	2.9
4:45-5:45		5	7	12	3.5
5:00-6:00		5	8	13	3.8
5:15-6:15		4	7	11	3.2
5:30-6:30		7	9	16	4.7
5:45-6:45		8	9	17	5.0
6:00-7:00		10	19	29	8.5
6:15-7:15		10	18	28	8.2
6:30-7:30		11	22	33	9.6
6:45-7:45		9	23	32	9.3
7:00-8:00		11	16	27	7.9
7:15-8:15		14	18	32	9.3
7:30-8:30		16	18	34	9.9
7:45-8:45		19	27	46	13.4
8:00-9:00		19	28	47	13.7
8:15-9:15		16	26	42	12.2
8:30-9:30		9	20	29	8.5
8:45-9:45		6	9	15	4.4
9:00-10:00		4	5	9	2.6
9:15-10:15		5	3	8	2.3
9:30-10:30		5	4	9	2.6
9:45-10:45		6	6	12	3.5
10:00-11:00		4	8	12	3.5
10:15-11:15		4	10	14	4.1
10:30-11:30		4	8	12	3.5
10:45-11:45		2	9	11	3.2
11:00-12:00		4	7	11	3.2
11:15-12:15		5	7	12	3.5
11:30-12:30		7	11	18	5.2
11:45-12:45		9	11	20	5.8
12:00-13:00		8	13	21	6.1
12:15-13:15		5	11	16	4.7
12:30-13:30		5	10	15	4.4
12:45-13:45		5	7	12	3.5

歩行者通行量調査表

調査地点：地域社会2 目黒交番前

調査年月日：令和元年10月13日(日) 天候：曇りのち雨



時間帯	種別	合計 (ア+イ+ウ+エ+オ+カ+キ+ク)			時間係数 (%)
		歩行者 (人)	自転車 (台)	合計 (人・台)	
22:00-22:15		0	1	1	0.3
22:15-22:30		1	4	5	1.5
10:00-10:15		2	0	2	0.6
10:15-10:30		0	2	2	0.6
10:30-10:45		2	3	5	1.5
10:45-11:00		0	3	3	0.9
1時間計		4	8	12	3.5
11:00-11:15		2	2	4	1.2
11:15-11:30		0	0	0	0.0
11:30-11:45		0	4	4	1.2
11:45-12:00		2	1	3	0.9
1時間計		4	7	11	3.2
12:00-12:15		3	2	5	1.5
12:15-12:30		2	4	6	1.7
12:30-12:45		2	4	6	1.7
12:45-13:00		1	3	4	1.2
1時間計		8	13	21	6.1
13:00-13:15		0	0	0	0.0
13:15-13:30		2	3	5	1.5
13:30-13:45		2	1	3	0.9
13:45-14:00		1	0	1	0.3
1時間計		5	4	9	2.6
14:00-14:15		1	0	1	0.3
14:15-14:30		0	0	0	0.0
14:30-14:45		1	0	1	0.3
14:45-15:00		0	0	0	0.0
1時間計		2	0	2	0.6
15:00-15:15		3	5	8	2.3
15:15-15:30		1	3	4	1.2
15:30-15:45		5	3	8	2.3
15:45-16:00		1	2	3	0.9
1時間計		10	13	23	6.7
16:00-16:15		0	2	2	0.6
16:15-16:30		2	0	2	0.6
16:30-16:45		0	13	13	3.8
16:45-17:00		0	0	0	0.0
1時間計		2	15	17	5.0
17:00-17:15		1	4	5	1.5
17:15-17:30		3	4	7	2.0
17:30-17:45		2	1	3	0.9
17:45-18:00		5	3	8	2.3
1時間計		11	12	23	6.7
18:00-18:15		1	4	5	1.5
18:15-18:30		4	5	9	2.6
18:30-18:45		0	2	2	0.6
18:45-19:00		0	1	1	0.3
1時間計		5	12	17	5.0
19:00-19:15		0	1	1	0.3
19:15-19:30		0	1	1	0.3
19:30-19:45		0	0	0	0.0
19:45-20:00		1	0	1	0.3
1時間計		1	2	3	0.9
20:00-20:15		0	3	3	0.9
20:15-20:30		1	1	2	0.6
20:30-20:45		3	2	5	1.5
20:45-21:00		0	2	2	0.6
1時間計		4	8	12	3.5
21:00-21:15		2	4	6	1.7
21:15-21:30		0	3	3	0.9
21:30-21:45		1	3	4	1.2
21:45-22:00		0	2	2	0.6
1時間計		3	12	15	4.4
昼12時間計		85	133	218	63.6
夜12時間計		38	87	125	36.4
全時間合計		123	220	343	100.0
昼夜率		1.45	1.65	1.57	-

時間帯	種別	合計 (ア+イ+ウ+エ+オ+カ+キ+ク)			時間係数 (%)
		歩行者 (人)	自転車 (台)	合計 (人・台)	
22:00-23:00		1	15	16	4.7
22:15-23:15		1	17	18	5.2
13:00-14:00		5	4	9	2.6
13:15-14:15		6	4	10	2.9
13:30-14:30		4	1	5	1.5
13:45-14:45		3	0	3	0.9
14:00-15:00		2	0	2	0.6
14:15-15:15		4	5	9	2.6
14:30-15:30		5	8	13	3.8
14:45-15:45		9	11	20	5.8
15:00-16:00		10	13	23	6.7
15:15-16:15		7	10	17	5.0
15:30-16:30		8	7	15	4.4
15:45-16:45		3	17	20	5.8
16:00-17:00		2	15	17	5.0
16:15-17:15		3	17	20	5.8
16:30-17:30		4	21	25	7.3
16:45-17:45		6	9	15	4.4
17:00-18:00		11	12	23	6.7
17:15-18:15		11	12	23	6.7
17:30-18:30		12	13	25	7.3
17:45-18:45		10	14	24	7.0
18:00-19:00		5	12	17	5.0
18:15-19:15		4	9	13	3.8
18:30-19:30		0	5	5	1.5
18:45-19:45		0	3	3	0.9
19:00-20:00		1	2	3	0.9
19:15-20:15		1	4	5	1.5
19:30-20:30		2	4	6	1.7
19:45-20:45		5	6	11	3.2
20:00-21:00		4	8	12	3.5
20:15-21:15		6	9	15	4.4
20:30-21:30		5	11	16	4.7
20:45-21:45		3	12	15	4.4
21:00-22:00		3	12	15	4.4
全時間合計		123	220	343	100.0

歩行者通行量調査表

調査地点：地域社会3 上川井IC

調査年月日：令和元年10月13日(日) 天候：曇りのち雨

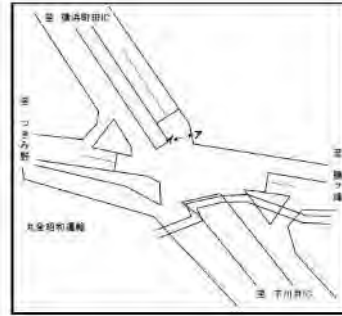

時間帯	ア				イ				合計			
	歩行者 (人)	自転車 (台)	合計 (人・台)	時間 係数 (%)	歩行者 (人)	自転車 (台)	合計 (人・台)	時間 係数 (%)	歩行者 (人)	自転車 (台)	合計 (人・台)	時間 係数 (%)
22:00-22:15	0	0	0	0.0	0	1	1	0.8	0	1	1	0.4
22:15-22:30	0	0	0	0.0	0	1	1	0.8	0	1	1	0.4
22:30-22:45	0	0	0	0.0	0	0	0	0.0	0	0	0	0.0
22:45-23:00	0	0	0	0.0	1	0	1	0.8	1	0	1	0.4
1時間計	0	0	0	0.0	1	2	3	2.4	1	2	3	1.3
23:00-23:15	0	0	0	0.0	0	1	1	0.8	0	1	1	0.4
23:15-23:30	0	2	2	1.8	0	0	0	0.0	0	2	2	0.9
23:30-23:45	1	0	1	0.9	0	1	1	0.8	1	1	2	0.9
23:45-24:00	0	0	0	0.0	0	0	0	0.0	0	0	0	0.0
1時間計	1	2	3	2.7	0	2	2	1.6	1	4	5	2.1
0:00-0:15	0	0	0	0.0	0	0	0	0.0	0	0	0	0.0
0:15-0:30	0	1	1	0.9	0	0	0	0.0	0	1	1	0.4
0:30-0:45	0	0	0	0.0	0	1	1	0.8	0	1	1	0.4
0:45-1:00	0	0	0	0.0	0	0	0	0.0	0	0	0	0.0
1時間計	0	1	1	0.9	0	1	1	0.8	0	2	2	0.9
1:00-1:15	0	0	0	0.0	0	0	0	0.0	0	0	0	0.0
1:15-1:30	0	0	0	0.0	0	0	0	0.0	0	0	0	0.0
1:30-1:45	0	0	0	0.0	0	0	0	0.0	0	0	0	0.0
1:45-2:00	0	0	0	0.0	0	0	0	0.0	0	0	0	0.0
1時間計	0	0	0	0.0	0	0	0	0.0	0	0	0	0.0
2:00-2:15	0	0	0	0.0	0	0	0	0.0	0	0	0	0.0
2:15-2:30	0	0	0	0.0	0	0	0	0.0	0	0	0	0.0
2:30-2:45	0	0	0	0.0	1	0	1	0.8	1	0	1	0.4
2:45-3:00	0	0	0	0.0	0	0	0	0.0	0	0	0	0.0
1時間計	0	0	0	0.0	1	0	1	0.8	1	0	1	0.4
3:00-3:15	0	0	0	0.0	0	0	0	0.0	0	0	0	0.0
3:15-3:30	0	0	0	0.0	0	0	0	0.0	0	0	0	0.0
3:30-3:45	0	0	0	0.0	0	0	0	0.0	0	0	0	0.0
3:45-4:00	0	0	0	0.0	0	1	1	0.8	0	1	1	0.4
1時間計	0	0	0	0.0	0	1	1	0.8	0	1	1	0.4
4:00-4:15	0	0	0	0.0	0	0	0	0.0	0	0	0	0.0
4:15-4:30	0	0	0	0.0	0	0	0	0.0	0	0	0	0.0
4:30-4:45	1	1	2	1.8	1	0	1	0.8	2	1	3	1.3
4:45-5:00	0	0	0	0.0	0	0	0	0.0	0	0	0	0.0
1時間計	1	1	2	1.8	1	0	1	0.8	2	1	3	1.3
5:00-5:15	0	0	0	0.0	0	0	0	0.0	0	0	0	0.0
5:15-5:30	0	0	0	0.0	0	1	1	0.8	0	1	1	0.4
5:30-5:45	0	0	0	0.0	0	0	0	0.0	0	0	0	0.0
5:45-6:00	2	0	2	1.8	0	0	0	0.0	2	0	2	0.9
1時間計	2	0	2	1.8	0	1	1	0.8	2	1	3	1.3

歩行者通行量調査表

調査地点：地域社会3 上川井IC

調査年月日：令和元年10月13日(日) 天候：曇りのち雨

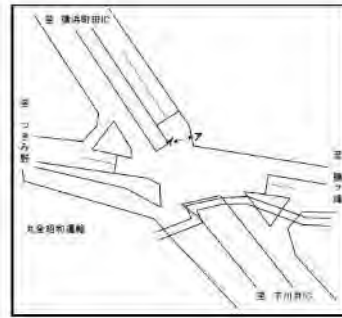

時間帯	ア				イ				合計			
	歩行者 (人)	自転車 (台)	合計 (人・台)	時間係数 (%)	歩行者 (人)	自転車 (台)	合計 (人・台)	時間係数 (%)	歩行者 (人)	自転車 (台)	合計 (人・台)	時間係数 (%)
6:00-6:15	1	0	1	0.9	1	0	1	0.8	2	0	2	0.9
6:15-6:30	4	0	4	3.6	0	3	3	2.4	4	3	7	3.0
6:30-6:45	1	4	5	4.5	1	0	1	0.8	2	4	6	2.6
6:45-7:00	1	1	2	1.8	3	0	3	2.4	4	1	5	2.1
1時間計	7	5	12	10.9	5	3	8	6.5	12	8	20	8.6
7:00-7:15	2	1	3	2.7	0	0	0	0.0	2	1	3	1.3
7:15-7:30	1	1	2	1.8	9	3	12	9.8	10	4	14	6.0
7:30-7:45	1	1	2	1.8	8	4	12	9.8	9	5	14	6.0
7:45-8:00	0	1	1	0.9	3	0	3	2.4	3	1	4	1.7
1時間計	4	4	8	7.3	20	7	27	22.0	24	11	35	15.0
8:00-8:15	1	2	3	2.7	2	1	3	2.4	3	3	6	2.6
8:15-8:30	2	1	3	2.7	2	1	3	2.4	4	2	6	2.6
8:30-8:45	1	0	1	0.9	2	2	4	3.3	3	2	5	2.1
8:45-9:00	2	1	3	2.7	2	2	4	3.3	4	3	7	3.0
1時間計	6	4	10	9.1	8	6	14	11.4	14	10	24	10.3
9:00-9:15	2	0	2	1.8	2	1	3	2.4	4	1	5	2.1
9:15-9:30	1	1	2	1.8	1	0	1	0.8	2	1	3	1.3
9:30-9:45	2	1	3	2.7	0	0	0	0.0	2	1	3	1.3
9:45-10:00	1	0	1	0.9	0	0	0	0.0	1	0	1	0.4
1時間計	6	2	8	7.3	3	1	4	3.3	9	3	12	5.2
10:00-10:15	0	0	0	0.0	0	0	0	0.0	0	0	0	0.0
10:15-10:30	1	0	1	0.9	1	0	1	0.8	2	0	2	0.9
10:30-10:45	0	1	1	0.9	1	0	1	0.8	1	1	2	0.9
10:45-11:00	2	0	2	1.8	1	0	1	0.8	3	0	3	1.3
1時間計	3	1	4	3.6	3	0	3	2.4	6	1	7	3.0
11:00-11:15	1	0	1	0.9	0	0	0	0.0	1	0	1	0.4
11:15-11:30	0	0	0	0.0	0	0	0	0.0	0	0	0	0.0
11:30-11:45	3	0	3	2.7	0	0	0	0.0	3	0	3	1.3
11:45-12:00	0	0	0	0.0	1	0	1	0.8	1	0	1	0.4
1時間計	4	0	4	3.6	1	0	1	0.8	5	0	5	2.1
12:00-12:15	3	0	3	2.7	2	0	2	1.6	5	0	5	2.1
12:15-12:30	0	0	0	0.0	1	0	1	0.8	1	0	1	0.4
12:30-12:45	0	1	1	0.9	0	0	0	0.0	0	1	1	0.4
12:45-13:00	0	0	0	0.0	5	0	5	4.1	5	0	5	2.1
1時間計	3	1	4	3.6	8	0	8	6.5	11	1	12	5.2
13:00-13:15	0	0	0	0.0	1	1	2	1.6	1	1	2	0.9
13:15-13:30	2	0	2	1.8	0	0	0	0.0	2	0	2	0.9
13:30-13:45	1	0	1	0.9	0	0	0	0.0	1	0	1	0.4
13:45-14:00	1	2	3	2.7	0	0	0	0.0	1	2	3	1.3
1時間計	4	2	6	5.5	1	1	2	1.6	5	3	8	3.4

歩行者通行量調査表

調査地点：地域社会3 上川井IC

調査年月日：令和元年10月13日(日) 天候：曇りのち雨



時間帯	ア				イ				合計			
	歩行者 (人)	自転車 (台)	合計 (人・台)	時間 係数 (%)	歩行者 (人)	自転車 (台)	合計 (人・台)	時間 係数 (%)	歩行者 (人)	自転車 (台)	合計 (人・台)	時間 係数 (%)
14:00-14:15	0	0	0	0.0	0	0	0	0.0	0	0	0	0.0
14:15-14:30	0	1	1	0.9	2	0	2	1.6	2	1	3	1.3
14:30-14:45	0	0	0	0.0	3	0	3	2.4	3	0	3	1.3
14:45-15:00	1	0	1	0.9	1	1	2	1.6	2	1	3	1.3
1時間計	1	1	2	1.8	6	1	7	5.7	7	2	9	3.9
15:00-15:15	3	0	3	2.7	1	0	1	0.8	4	0	4	1.7
15:15-15:30	3	0	3	2.7	1	0	1	0.8	4	0	4	1.7
15:30-15:45	0	0	0	0.0	2	0	2	1.6	2	0	2	0.9
15:45-16:00	2	3	5	4.5	0	0	0	0.0	2	3	5	2.1
1時間計	8	3	11	10.0	4	0	4	3.3	12	3	15	6.4
16:00-16:15	1	0	1	0.9	1	0	1	0.8	2	0	2	0.9
16:15-16:30	1	0	1	0.9	1	1	2	1.6	2	1	3	1.3
16:30-16:45	0	0	0	0.0	1	0	1	0.8	1	0	1	0.4
16:45-17:00	1	5	6	5.5	2	0	2	1.6	3	5	8	3.4
1時間計	3	5	8	7.3	5	1	6	4.9	8	6	14	6.0
17:00-17:15	0	0	0	0.0	0	2	2	1.6	0	2	2	0.9
17:15-17:30	1	0	1	0.9	6	0	6	4.9	7	0	7	3.0
17:30-17:45	1	0	1	0.9	0	0	0	0.0	1	0	1	0.4
17:45-18:00	2	0	2	1.8	1	1	2	1.6	3	1	4	1.7
1時間計	4	0	4	3.6	7	3	10	8.1	11	3	14	6.0
18:00-18:15	1	0	1	0.9	1	0	1	0.8	2	0	2	0.9
18:15-18:30	0	5	5	4.5	1	0	1	0.8	1	5	6	2.6
18:30-18:45	2	2	4	3.6	0	0	0	0.0	2	2	4	1.7
18:45-19:00	2	2	4	3.6	0	1	1	0.8	2	3	5	2.1
1時間計	5	9	14	12.7	2	1	3	2.4	7	10	17	7.3
19:00-19:15	0	0	0	0.0	6	0	6	4.9	6	0	6	2.6
19:15-19:30	0	0	0	0.0	0	0	0	0.0	0	0	0	0.0
19:30-19:45	0	1	1	0.9	0	0	0	0.0	0	1	1	0.4
19:45-20:00	0	0	0	0.0	0	1	1	0.8	0	1	1	0.4
1時間計	0	1	1	0.9	6	1	7	5.7	6	2	8	3.4
20:00-20:15	0	0	0	0.0	2	0	2	1.6	2	0	2	0.9
20:15-20:30	0	0	0	0.0	0	0	0	0.0	0	0	0	0.0
20:30-20:45	0	0	0	0.0	0	0	0	0.0	0	0	0	0.0
20:45-21:00	1	1	2	1.8	2	0	2	1.6	3	1	4	1.7
1時間計	1	1	2	1.8	4	0	4	3.3	5	1	6	2.6
21:00-21:15	0	1	1	0.9	1	0	1	0.8	1	1	2	0.9
21:15-21:30	0	0	0	0.0	2	0	2	1.6	2	0	2	0.9
21:30-21:45	0	1	1	0.9	2	0	2	1.6	2	1	3	1.3
21:45-22:00	1	1	2	1.8	0	0	0	0.0	1	1	2	0.9
1時間計	1	3	4	3.6	5	0	5	4.1	6	3	9	3.9
昼12時間計	51	32	83	75.5	68	21	89	72.4	119	53	172	73.8
夜12時間計	13	14	27	24.5	23	11	34	27.6	36	25	61	26.2
全時間合計	64	46	110	100.0	91	32	123	100.0	155	78	233	100.0
昼夜率	1.25	1.44	1.33	-	1.34	1.52	1.38	-	1.30	1.47	1.35	-

歩行者通行量調査表

調査地点：地域社会3 上川井1C

調査年月日：令和元年10月13日(日) 天候：曇りのち雨

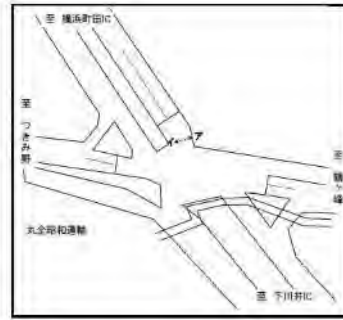

時間帯	方向 種別	合計 (7+4)			時間 係数 (%)
		歩行者 (人)	自転車 (台)	合計 (人・台)	
22:00-22:15		0	1	1	0.4
22:15-22:30		0	1	1	0.4
22:30-22:45		0	0	0	0.0
22:45-23:00		1	0	1	0.4
1時間計		1	2	3	1.3
23:00-23:15		0	1	1	0.4
23:15-23:30		0	2	2	0.9
23:30-23:45		1	1	2	0.9
23:45-24:00		0	0	0	0.0
1時間計		1	4	5	2.1
0:00-0:15		0	0	0	0.0
0:15-0:30		0	1	1	0.4
0:30-0:45		0	1	1	0.4
0:45-1:00		0	0	0	0.0
1時間計		0	2	2	0.9
1:00-1:15		0	0	0	0.0
1:15-1:30		0	0	0	0.0
1:30-1:45		0	0	0	0.0
1:45-2:00		0	0	0	0.0
1時間計		0	0	0	0.0
2:00-2:15		0	0	0	0.0
2:15-2:30		0	0	0	0.0
2:30-2:45		1	0	1	0.4
2:45-3:00		0	0	0	0.0
1時間計		1	0	1	0.4
3:00-3:15		0	0	0	0.0
3:15-3:30		0	0	0	0.0
3:30-3:45		0	0	0	0.0
3:45-4:00		0	1	1	0.4
1時間計		0	1	1	0.4
4:00-4:15		0	0	0	0.0
4:15-4:30		0	0	0	0.0
4:30-4:45		2	1	3	1.3
4:45-5:00		0	0	0	0.0
1時間計		2	1	3	1.3
5:00-5:15		0	0	0	0.0
5:15-5:30		0	1	1	0.4
5:30-5:45		0	0	0	0.0
5:45-6:00		2	0	2	0.9
1時間計		2	1	3	1.3
6:00-6:15		2	0	2	0.9
6:15-6:30		4	3	7	3.0
6:30-6:45		2	4	6	2.6
6:45-7:00		4	1	5	2.1
1時間計		12	8	20	8.6
7:00-7:15		2	1	3	1.3
7:15-7:30		10	4	14	6.0
7:30-7:45		9	5	14	6.0
7:45-8:00		3	1	4	1.7
1時間計		24	11	35	15.0
8:00-8:15		3	3	6	2.6
8:15-8:30		4	2	6	2.6
8:30-8:45		3	2	5	2.1
8:45-9:00		4	3	7	3.0
1時間計		14	10	24	10.3
9:00-9:15		4	1	5	2.1
9:15-9:30		2	1	3	1.3
9:30-9:45		2	1	3	1.3
9:45-10:00		1	0	1	0.4
1時間計		9	3	12	5.2

時間帯	方向 種別	合計 (7+4)			時間 係数 (%)
		歩行者 (人)	自転車 (台)	合計 (人・台)	
22:00-23:00		1	2	3	1.3
22:15-23:15		1	2	3	1.3
22:30-23:30		1	3	4	1.7
22:45-23:45		2	4	6	2.6
23:00-0:00		1	4	5	2.1
23:15-0:15		1	3	4	1.7
23:30-0:30		1	2	3	1.3
23:45-0:45		0	2	2	0.9
0:00-1:00		0	2	2	0.9
0:15-1:15		0	2	2	0.9
0:30-1:30		0	1	1	0.4
0:45-1:45		0	0	0	0.0
1:00-2:00		0	0	0	0.0
1:15-2:15		0	0	0	0.0
1:30-2:30		0	0	0	0.0
1:45-2:45		1	0	1	0.4
2:00-3:00		1	0	1	0.4
2:15-3:15		1	0	1	0.4
2:30-3:30		1	0	1	0.4
2:45-3:45		0	0	0	0.0
3:00-4:00		0	1	1	0.4
3:15-4:15		0	1	1	0.4
3:30-4:30		0	1	1	0.4
3:45-4:45		2	2	4	1.7
4:00-5:00		2	1	3	1.3
4:15-5:15		2	1	3	1.3
4:30-5:30		2	2	4	1.7
4:45-5:45		0	1	1	0.4
5:00-6:00		2	1	3	1.3
5:15-6:15		4	1	5	2.1
5:30-6:30		8	3	11	4.7
5:45-6:45		10	7	17	7.3
6:00-7:00		12	8	20	8.6
6:15-7:15		12	9	21	9.0
6:30-7:30		18	10	28	12.0
6:45-7:45		25	11	36	15.5
7:00-8:00		24	11	35	15.0
7:15-8:15		25	13	38	16.3
7:30-8:30		19	11	30	12.9
7:45-8:45		13	8	21	9.0
8:00-9:00		14	10	24	10.3
8:15-9:15		15	8	23	9.9
8:30-9:30		13	7	20	8.6
8:45-9:45		12	6	18	7.7
9:00-10:00		9	3	12	5.2
9:15-10:15		5	2	7	3.0
9:30-10:30		5	1	6	2.6
9:45-10:45		4	1	5	2.1
10:00-11:00		6	1	7	3.0
10:15-11:15		7	1	8	3.4
10:30-11:30		5	1	6	2.6
10:45-11:45		7	0	7	3.0
11:00-12:00		5	0	5	2.1
11:15-12:15		9	0	9	3.9
11:30-12:30		10	0	10	4.3
11:45-12:45		7	1	8	3.4
12:00-13:00		11	1	12	5.2
12:15-13:15		7	2	9	3.9
12:30-13:30		8	2	10	4.3
12:45-13:45		9	1	10	4.3

歩行者通行量調査表

調査地点：地域社会3 上川井IC

調査年月日：令和元年10月13日(日) 天候：曇りのち雨

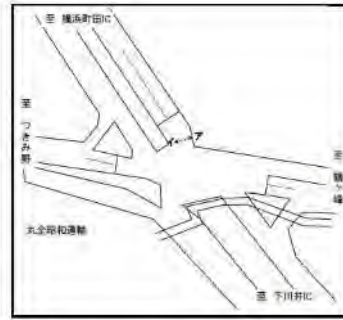

時間帯	方向 種別	合計 (7+4)			時間 係数 (%)
		歩行者 (人)	自転車 (台)	合計 (人・台)	
22:00-22:15		0	1	1	0.4
22:15-22:30		0	1	1	0.4
10:00-10:15		0	0	0	0.0
10:15-10:30		2	0	2	0.9
10:30-10:45		1	1	2	0.9
10:45-11:00		3	0	3	1.3
1時間計		6	1	7	3.0
11:00-11:15		1	0	1	0.4
11:15-11:30		0	0	0	0.0
11:30-11:45		3	0	3	1.3
11:45-12:00		1	0	1	0.4
1時間計		5	0	5	2.1
12:00-12:15		5	0	5	2.1
12:15-12:30		1	0	1	0.4
12:30-12:45		0	1	1	0.4
12:45-13:00		5	0	5	2.1
1時間計		11	1	12	5.2
13:00-13:15		1	1	2	0.9
13:15-13:30		2	0	2	0.9
13:30-13:45		1	0	1	0.4
13:45-14:00		1	2	3	1.3
1時間計		5	3	8	3.4
14:00-14:15		0	0	0	0.0
14:15-14:30		2	1	3	1.3
14:30-14:45		3	0	3	1.3
14:45-15:00		2	1	3	1.3
1時間計		7	2	9	3.9
15:00-15:15		4	0	4	1.7
15:15-15:30		4	0	4	1.7
15:30-15:45		2	0	2	0.9
15:45-16:00		2	3	5	2.1
1時間計		12	3	15	6.4
16:00-16:15		2	0	2	0.9
16:15-16:30		2	1	3	1.3
16:30-16:45		1	0	1	0.4
16:45-17:00		3	5	8	3.4
1時間計		8	6	14	6.0
17:00-17:15		0	2	2	0.9
17:15-17:30		7	0	7	3.0
17:30-17:45		1	0	1	0.4
17:45-18:00		3	1	4	1.7
1時間計		11	3	14	6.0
18:00-18:15		2	0	2	0.9
18:15-18:30		1	5	6	2.6
18:30-18:45		2	2	4	1.7
18:45-19:00		2	3	5	2.1
1時間計		7	10	17	7.3
19:00-19:15		6	0	6	2.6
19:15-19:30		0	0	0	0.0
19:30-19:45		0	1	1	0.4
19:45-20:00		0	1	1	0.4
1時間計		6	2	8	3.4
20:00-20:15		2	0	2	0.9
20:15-20:30		0	0	0	0.0
20:30-20:45		0	0	0	0.0
20:45-21:00		3	1	4	1.7
1時間計		5	1	6	2.6
21:00-21:15		1	1	2	0.9
21:15-21:30		2	0	2	0.9
21:30-21:45		2	1	3	1.3
21:45-22:00		1	1	2	0.9
1時間計		6	3	9	3.9
昼12時間計		119	53	172	73.8
夜12時間計		36	25	61	26.2
全時間合計		155	78	233	100.0
昼・夜率		1.30	1.47	1.35	-

時間帯	方向 種別	合計 (7+4)			時間 係数 (%)
		歩行者 (人)	自転車 (台)	合計 (人・台)	
22:00-23:00		1	2	3	1.3
22:15-23:15		1	2	3	1.3
13:00-14:00		5	3	8	3.4
13:15-14:15		4	2	6	2.6
13:30-14:30		4	3	7	3.0
13:45-14:45		6	3	9	3.9
14:00-15:00		7	2	9	3.9
14:15-15:15		11	2	13	5.6
14:30-15:30		13	1	14	6.0
14:45-15:45		12	1	13	5.6
15:00-16:00		12	3	15	6.4
15:15-16:15		10	3	13	5.6
15:30-16:30		8	4	12	5.2
15:45-16:45		7	4	11	4.7
16:00-17:00		8	6	14	6.0
16:15-17:15		6	8	14	6.0
16:30-17:30		11	7	18	7.7
16:45-17:45		11	7	18	7.7
17:00-18:00		11	3	14	6.0
17:15-18:15		13	1	14	6.0
17:30-18:30		7	6	13	5.6
17:45-18:45		8	8	16	6.9
18:00-19:00		7	10	17	7.3
18:15-19:15		11	10	21	9.0
18:30-19:30		10	5	15	6.4
18:45-19:45		8	4	12	5.2
19:00-20:00		6	2	8	3.4
19:15-20:15		2	2	4	1.7
19:30-20:30		2	2	4	1.7
19:45-20:45		2	1	3	1.3
20:00-21:00		5	1	6	2.6
20:15-21:15		4	2	6	2.6
20:30-21:30		6	2	8	3.4
20:45-21:45		8	3	11	4.7
21:00-22:00		6	3	9	3.9
全時間合計		155	78	233	100.0

歩行者通行量調査表

調査地点：地域社会4 滝沢

調査年月日：令和 2年 9月21日(月・祝) 天候：曇りのち晴れ



時間帯	ア				イ				合計			
	歩行者 (人)	自転車 (台)	合計 (人・台)	時間 係数 (%)	歩行者 (人)	自転車 (台)	合計 (人・台)	時間 係数 (%)	歩行者 (人)	自転車 (台)	合計 (人・台)	時間 係数 (%)
7:00-7:15	0	0	0	0.0	1	0	1	7.7	1	0	1	2.9
7:15-7:30	0	0	0	0.0	0	0	0	0.0	0	0	0	0.0
7:30-7:45	0	0	0	0.0	0	0	0	0.0	0	0	0	0.0
7:45-8:00	1	1	2	9.5	0	0	0	0.0	1	1	2	5.9
1時間計	1	1	2	9.5	1	0	1	7.7	2	1	3	8.8
8:00-8:15	0	0	0	0.0	0	0	0	0.0	0	0	0	0.0
8:15-8:30	0	1	1	4.8	0	0	0	0.0	0	1	1	2.9
8:30-8:45	0	0	0	0.0	0	0	0	0.0	0	0	0	0.0
8:45-9:00	0	0	0	0.0	0	0	0	0.0	0	0	0	0.0
1時間計	0	1	1	4.8	0	0	0	0.0	0	1	1	2.9
9:00-9:15	1	0	1	4.8	0	0	0	0.0	1	0	1	2.9
9:15-9:30	1	0	1	4.8	0	0	0	0.0	1	0	1	2.9
9:30-9:45	0	0	0	0.0	0	0	0	0.0	0	0	0	0.0
9:45-10:00	0	0	0	0.0	0	0	0	0.0	0	0	0	0.0
1時間計	2	0	2	9.5	0	0	0	0.0	2	0	2	5.9
10:00-10:15	0	0	0	0.0	0	0	0	0.0	0	0	0	0.0
10:15-10:30	0	0	0	0.0	0	0	0	0.0	0	0	0	0.0
10:30-10:45	0	0	0	0.0	0	0	0	0.0	0	0	0	0.0
10:45-11:00	0	0	0	0.0	0	0	0	0.0	0	0	0	0.0
1時間計	0	0	0	0.0	0	0	0	0.0	0	0	0	0.0
11:00-11:15	0	0	0	0.0	0	0	0	0.0	0	0	0	0.0
11:15-11:30	1	0	1	4.8	0	0	0	0.0	1	0	1	2.9
11:30-11:45	0	0	0	0.0	0	0	0	0.0	0	0	0	0.0
11:45-12:00	0	0	0	0.0	0	0	0	0.0	0	0	0	0.0
1時間計	1	0	1	4.8	0	0	0	0.0	1	0	1	2.9
12:00-12:15	1	4	5	23.8	1	1	2	15.4	2	5	7	20.6
12:15-12:30	0	0	0	0.0	2	0	2	15.4	2	0	2	5.9
12:30-12:45	0	0	0	0.0	0	0	0	0.0	0	0	0	0.0
12:45-13:00	0	2	2	9.5	1	0	1	7.7	1	2	3	8.8
1時間計	1	6	7	33.3	4	1	5	38.5	5	7	12	35.3
13:00-13:15	0	0	0	0.0	0	0	0	0.0	0	0	0	0.0
13:15-13:30	0	0	0	0.0	0	0	0	0.0	0	0	0	0.0
13:30-13:45	0	0	0	0.0	0	0	0	0.0	0	0	0	0.0
13:45-14:00	4	0	4	19.0	1	0	1	7.7	5	0	5	14.7
1時間計	4	0	4	19.0	1	0	1	7.7	5	0	5	14.7
14:00-14:15	0	0	0	0.0	1	0	1	7.7	1	0	1	2.9
14:15-14:30	0	0	0	0.0	1	0	1	7.7	1	0	1	2.9
14:30-14:45	0	0	0	0.0	0	0	0	0.0	0	0	0	0.0
14:45-15:00	0	0	0	0.0	0	0	0	0.0	0	0	0	0.0
1時間計	0	0	0	0.0	2	0	2	15.4	2	0	2	5.9

歩行者通行量調査表

調査地点：地域社会4 滝沢

調査年月日：令和 2年 9月21日(月・祝) 天候：曇りのち晴れ



時間帯	ア				イ				合計			
	歩行者 (人)	自転車 (台)	合計 (人・台)	時間 係数 (%)	歩行者 (人)	自転車 (台)	合計 (人・台)	時間 係数 (%)	歩行者 (人)	自転車 (台)	合計 (人・台)	時間 係数 (%)
15:00-15:15	0	0	0	0.0	0	0	0	0.0	0	0	0	0.0
15:15-15:30	0	0	0	0.0	0	0	0	0.0	0	0	0	0.0
15:30-15:45	0	0	0	0.0	0	0	0	0.0	0	0	0	0.0
15:45-16:00	0	0	0	0.0	0	0	0	0.0	0	0	0	0.0
1時間計	0	0	0	0.0	0	0	0	0.0	0	0	0	0.0
16:00-16:15	0	0	0	0.0	0	0	0	0.0	0	0	0	0.0
16:15-16:30	0	0	0	0.0	0	0	0	0.0	0	0	0	0.0
16:30-16:45	0	0	0	0.0	0	0	0	0.0	0	0	0	0.0
16:45-17:00	0	0	0	0.0	1	0	1	7.7	1	0	1	2.9
1時間計	0	0	0	0.0	1	0	1	7.7	1	0	1	2.9
17:00-17:15	0	0	0	0.0	2	0	2	15.4	2	0	2	5.9
17:15-17:30	0	0	0	0.0	0	0	0	0.0	0	0	0	0.0
17:30-17:45	0	0	0	0.0	0	1	1	7.7	0	1	1	2.9
17:45-18:00	0	0	0	0.0	0	0	0	0.0	0	0	0	0.0
1時間計	0	0	0	0.0	2	1	3	23.1	2	1	3	8.8
18:00-18:15	1	1	2	9.5	0	0	0	0.0	1	1	2	5.9
18:15-18:30	0	0	0	0.0	0	0	0	0.0	0	0	0	0.0
18:30-18:45	0	0	0	0.0	0	0	0	0.0	0	0	0	0.0
18:45-19:00	0	0	0	0.0	0	0	0	0.0	0	0	0	0.0
1時間計	1	1	2	9.5	0	0	0	0.0	1	1	2	5.9
昼12時間計	10	9	19	90.5	11	2	13	100.0	21	11	32	94.1
19:00-19:15	0	0	0	0.0	0	0	0	0.0	0	0	0	0.0
19:15-19:30	0	0	0	0.0	0	0	0	0.0	0	0	0	0.0
19:30-19:45	0	0	0	0.0	0	0	0	0.0	0	0	0	0.0
19:45-20:00	0	0	0	0.0	0	0	0	0.0	0	0	0	0.0
1時間計	0	0	0	0.0	0	0	0	0.0	0	0	0	0.0
20:00-20:15	0	0	0	0.0	0	0	0	0.0	0	0	0	0.0
20:15-20:30	0	0	0	0.0	0	0	0	0.0	0	0	0	0.0
20:30-20:45	1	0	1	4.8	0	0	0	0.0	1	0	1	2.9
20:45-21:00	0	0	0	0.0	0	0	0	0.0	0	0	0	0.0
1時間計	1	0	1	4.8	0	0	0	0.0	1	0	1	2.9
21:00-21:15	0	0	0	0.0	0	0	0	0.0	0	0	0	0.0
21:15-21:30	0	0	0	0.0	0	0	0	0.0	0	0	0	0.0
21:30-21:45	0	0	0	0.0	0	0	0	0.0	0	0	0	0.0
21:45-22:00	0	0	0	0.0	0	0	0	0.0	0	0	0	0.0
1時間計	0	0	0	0.0	0	0	0	0.0	0	0	0	0.0
22:00-22:15	0	0	0	0.0	0	0	0	0.0	0	0	0	0.0
22:15-22:30	0	0	0	0.0	0	0	0	0.0	0	0	0	0.0
22:30-22:45	0	0	0	0.0	0	0	0	0.0	0	0	0	0.0
22:45-23:00	0	0	0	0.0	0	0	0	0.0	0	0	0	0.0
1時間計	0	0	0	0.0	0	0	0	0.0	0	0	0	0.0

歩行者通行量調査表

調査地点：地域社会4 滝沢

調査年月日：令和 2年 9月21日(月・祝) 天候：曇りのち晴れ



方向	ア				イ				合計			
	歩行者 (人)	自転車 (台)	合計 (人・台)	時間 係数 (%)	歩行者 (人)	自転車 (台)	合計 (人・台)	時間 係数 (%)	歩行者 (人)	自転車 (台)	合計 (人・台)	時間 係数 (%)
23:00-23:15	0	0	0	0.0	0	0	0	0.0	0	0	0	0.0
23:15-23:30	0	0	0	0.0	0	0	0	0.0	0	0	0	0.0
23:30-23:45	0	0	0	0.0	0	0	0	0.0	0	0	0	0.0
23:45-24:00	0	0	0	0.0	0	0	0	0.0	0	0	0	0.0
1時間計	0	0	0	0.0	0	0	0	0.0	0	0	0	0.0
0:00-0:15	0	0	0	0.0	0	0	0	0.0	0	0	0	0.0
0:15-0:30	0	0	0	0.0	0	0	0	0.0	0	0	0	0.0
0:30-0:45	0	0	0	0.0	0	0	0	0.0	0	0	0	0.0
0:45-1:00	0	0	0	0.0	0	0	0	0.0	0	0	0	0.0
1時間計	0	0	0	0.0	0	0	0	0.0	0	0	0	0.0
1:00-1:15	0	0	0	0.0	0	0	0	0.0	0	0	0	0.0
1:15-1:30	0	0	0	0.0	0	0	0	0.0	0	0	0	0.0
1:30-1:45	0	0	0	0.0	0	0	0	0.0	0	0	0	0.0
1:45-2:00	0	0	0	0.0	0	0	0	0.0	0	0	0	0.0
1時間計	0	0	0	0.0	0	0	0	0.0	0	0	0	0.0
2:00-2:15	0	0	0	0.0	0	0	0	0.0	0	0	0	0.0
2:15-2:30	0	0	0	0.0	0	0	0	0.0	0	0	0	0.0
2:30-2:45	0	0	0	0.0	0	0	0	0.0	0	0	0	0.0
2:45-3:00	0	0	0	0.0	0	0	0	0.0	0	0	0	0.0
1時間計	0	0	0	0.0	0	0	0	0.0	0	0	0	0.0
3:00-3:15	0	0	0	0.0	0	0	0	0.0	0	0	0	0.0
3:15-3:30	0	0	0	0.0	0	0	0	0.0	0	0	0	0.0
3:30-3:45	0	0	0	0.0	0	0	0	0.0	0	0	0	0.0
3:45-4:00	0	0	0	0.0	0	0	0	0.0	0	0	0	0.0
1時間計	0	0	0	0.0	0	0	0	0.0	0	0	0	0.0
4:00-4:15	0	0	0	0.0	0	0	0	0.0	0	0	0	0.0
4:15-4:30	0	0	0	0.0	0	0	0	0.0	0	0	0	0.0
4:30-4:45	0	0	0	0.0	0	0	0	0.0	0	0	0	0.0
4:45-5:00	0	0	0	0.0	0	0	0	0.0	0	0	0	0.0
1時間計	0	0	0	0.0	0	0	0	0.0	0	0	0	0.0
5:00-5:15	0	0	0	0.0	0	0	0	0.0	0	0	0	0.0
5:15-5:30	0	0	0	0.0	0	0	0	0.0	0	0	0	0.0
5:30-5:45	0	0	0	0.0	0	0	0	0.0	0	0	0	0.0
5:45-6:00	0	0	0	0.0	0	0	0	0.0	0	0	0	0.0
1時間計	0	0	0	0.0	0	0	0	0.0	0	0	0	0.0
6:00-6:15	0	0	0	0.0	0	0	0	0.0	0	0	0	0.0
6:15-6:30	0	1	1	4.8	0	0	0	0.0	0	1	1	2.9
6:30-6:45	0	0	0	0.0	0	0	0	0.0	0	0	0	0.0
6:45-7:00	0	0	0	0.0	0	0	0	0.0	0	0	0	0.0
1時間計	0	1	1	4.8	0	0	0	0.0	0	1	1	2.9
夜12時間計	1	1	2	9.5	0	0	0	0.0	1	1	2	5.9
全時間合計	11	10	21	100.0	11	2	13	100.0	22	12	34	100.0
昼夜率	1.10	1.11	1.11	-	1.00	1.00	1.00	-	1.05	1.09	1.06	-

歩行者通行量調査表

調査地点：地域社会4 滝沢

調査年月日：令和 2年 9月21日(月・祝) 天候：曇りのち晴れ



時間帯	ウ				I				合計			
	歩行者 (人)	自転車 (台)	合計 (人・台)	時間 係数 (%)	歩行者 (人)	自転車 (台)	合計 (人・台)	時間 係数 (%)	歩行者 (人)	自転車 (台)	合計 (人・台)	時間 係数 (%)
7:00-7:15	1	5	6	1.9	0	5	5	4.3	1	10	11	2.6
7:15-7:30	1	4	5	1.6	0	0	0	0.0	1	4	5	1.2
7:30-7:45	0	7	7	2.2	0	0	0	0.0	0	7	7	1.6
7:45-8:00	1	14	15	4.8	0	0	0	0.0	1	14	15	3.5
1時間計	3	30	33	10.5	0	5	5	4.3	3	35	38	8.9
8:00-8:15	7	18	25	8.0	0	1	1	0.9	7	19	26	6.1
8:15-8:30	0	6	6	1.9	0	0	0	0.0	0	6	6	1.4
8:30-8:45	1	2	3	1.0	0	0	0	0.0	1	2	3	0.7
8:45-9:00	2	3	5	1.6	0	0	0	0.0	2	3	5	1.2
1時間計	10	29	39	12.5	0	1	1	0.9	10	30	40	9.3
9:00-9:15	3	3	6	1.9	0	0	0	0.0	3	3	6	1.4
9:15-9:30	0	0	0	0.0	0	0	0	0.0	0	0	0	0.0
9:30-9:45	3	10	13	4.2	1	1	2	1.7	4	11	15	3.5
9:45-10:00	1	6	7	2.2	0	1	1	0.9	1	7	8	1.9
1時間計	7	19	26	8.3	1	2	3	2.6	8	21	29	6.8
10:00-10:15	1	6	7	2.2	0	0	0	0.0	1	6	7	1.6
10:15-10:30	4	4	8	2.6	0	0	0	0.0	4	4	8	1.9
10:30-10:45	3	8	11	3.5	0	0	0	0.0	3	8	11	2.6
10:45-11:00	2	6	8	2.6	0	0	0	0.0	2	6	8	1.9
1時間計	10	24	34	10.9	0	0	0	0.0	10	24	34	7.9
11:00-11:15	1	9	10	3.2	6	1	7	6.1	7	10	17	4.0
11:15-11:30	0	3	3	1.0	2	2	4	3.5	2	5	7	1.6
11:30-11:45	1	4	5	1.6	5	1	6	5.2	6	5	11	2.6
11:45-12:00	2	2	4	1.3	0	0	0	0.0	2	2	4	0.9
1時間計	4	18	22	7.0	13	4	17	14.8	17	22	39	9.1
12:00-12:15	0	2	2	0.6	2	0	2	1.7	2	2	4	0.9
12:15-12:30	4	1	5	1.6	1	1	2	1.7	5	2	7	1.6
12:30-12:45	0	3	3	1.0	0	0	0	0.0	0	3	3	0.7
12:45-13:00	0	4	4	1.3	0	0	0	0.0	0	4	4	0.9
1時間計	4	10	14	4.5	3	1	4	3.5	7	11	18	4.2
13:00-13:15	1	6	7	2.2	2	0	2	1.7	3	6	9	2.1
13:15-13:30	2	5	7	2.2	1	5	6	5.2	3	10	13	3.0
13:30-13:45	1	7	8	2.6	1	3	4	3.5	2	10	12	2.8
13:45-14:00	0	6	6	1.9	0	0	0	0.0	0	6	6	1.4
1時間計	4	24	28	8.9	4	8	12	10.4	8	32	40	9.3
14:00-14:15	3	2	5	1.6	0	0	0	0.0	3	2	5	1.2
14:15-14:30	0	2	2	0.6	0	0	0	0.0	0	2	2	0.5
14:30-14:45	2	8	10	3.2	4	0	4	3.5	6	8	14	3.3
14:45-15:00	0	0	0	0.0	0	0	0	0.0	0	0	0	0.0
1時間計	5	12	17	5.4	4	0	4	3.5	9	12	21	4.9

歩行者通行量調査表

調査地点：地域社会4 滝沢

調査年月日：令和 2年 9月21日(月・祝) 天候：曇りのち晴れ



時間帯	ウ				I				合計			
	歩行者 (人)	自転車 (台)	合計 (人・台)	時間 係数 (%)	歩行者 (人)	自転車 (台)	合計 (人・台)	時間 係数 (%)	歩行者 (人)	自転車 (台)	合計 (人・台)	時間 係数 (%)
15:00-15:15	3	3	6	1.9	0	0	0	0.0	3	3	6	1.4
15:15-15:30	1	4	5	1.6	0	4	4	3.5	1	8	9	2.1
15:30-15:45	0	3	3	1.0	0	6	6	5.2	0	9	9	2.1
15:45-16:00	4	1	5	1.6	1	2	3	2.6	5	3	8	1.9
1時間計	8	11	19	6.1	1	12	13	11.3	9	23	32	7.5
16:00-16:15	3	2	5	1.6	2	1	3	2.6	5	3	8	1.9
16:15-16:30	1	4	5	1.6	3	3	6	5.2	4	7	11	2.6
16:30-16:45	3	3	6	1.9	0	1	1	0.9	3	4	7	1.6
16:45-17:00	1	5	6	1.9	1	0	1	0.9	2	5	7	1.6
1時間計	8	14	22	7.0	6	5	11	9.6	14	19	33	7.7
17:00-17:15	0	1	1	0.3	1	0	1	0.9	1	1	2	0.5
17:15-17:30	0	0	0	0.0	2	1	3	2.6	2	1	3	0.7
17:30-17:45	3	0	3	1.0	3	2	5	4.3	6	2	8	1.9
17:45-18:00	1	0	1	0.3	2	1	3	2.6	3	1	4	0.9
1時間計	4	1	5	1.6	8	4	12	10.4	12	5	17	4.0
18:00-18:15	1	7	8	2.6	0	3	3	2.6	1	10	11	2.6
18:15-18:30	0	2	2	0.6	1	0	1	0.9	1	2	3	0.7
18:30-18:45	0	0	0	0.0	0	1	1	0.9	0	1	1	0.2
18:45-19:00	0	1	1	0.3	4	0	4	3.5	4	1	5	1.2
1時間計	1	10	11	3.5	5	4	9	7.8	6	14	20	4.7
昼12時間計	68	202	270	86.3	45	46	91	79.1	113	248	361	84.3
19:00-19:15	0	2	2	0.6	0	0	0	0.0	0	2	2	0.5
19:15-19:30	0	0	0	0.0	1	0	1	0.9	1	0	1	0.2
19:30-19:45	0	0	0	0.0	1	1	2	1.7	1	1	2	0.5
19:45-20:00	2	1	3	1.0	2	0	2	1.7	4	1	5	1.2
1時間計	2	3	5	1.6	4	1	5	4.3	6	4	10	2.3
20:00-20:15	0	0	0	0.0	0	0	0	0.0	0	0	0	0.0
20:15-20:30	0	2	2	0.6	1	2	3	2.6	1	4	5	1.2
20:30-20:45	0	1	1	0.3	0	3	3	2.6	0	4	4	0.9
20:45-21:00	0	1	1	0.3	2	1	3	2.6	2	2	4	0.9
1時間計	0	4	4	1.3	3	6	9	7.8	3	10	13	3.0
21:00-21:15	1	1	2	0.6	0	2	2	1.7	1	3	4	0.9
21:15-21:30	0	1	1	0.3	0	0	0	0.0	0	1	1	0.2
21:30-21:45	0	0	0	0.0	0	1	1	0.9	0	1	1	0.2
21:45-22:00	0	8	8	2.6	0	0	0	0.0	0	8	8	1.9
1時間計	1	10	11	3.5	0	3	3	2.6	1	13	14	3.3
22:00-22:15	0	0	0	0.0	0	0	0	0.0	0	0	0	0.0
22:15-22:30	1	0	1	0.3	0	0	0	0.0	1	0	1	0.2
22:30-22:45	0	0	0	0.0	1	2	3	2.6	1	2	3	0.7
22:45-23:00	0	0	0	0.0	0	0	0	0.0	0	0	0	0.0
1時間計	1	0	1	0.3	1	2	3	2.6	2	2	4	0.9

歩行者通行量調査表

調査地点：地域社会4 滝沢

調査年月日：令和 2年 9月21日(月・祝) 天候：曇りのち晴れ



時間帯	ウ				I				合計			
	歩行者 (人)	自転車 (台)	合計 (人・台)	時間 係数 (%)	歩行者 (人)	自転車 (台)	合計 (人・台)	時間 係数 (%)	歩行者 (人)	自転車 (台)	合計 (人・台)	時間 係数 (%)
23:00-23:15	0	2	2	0.6	0	0	0	0.0	0	2	2	0.5
23:15-23:30	0	1	1	0.3	0	0	0	0.0	0	1	1	0.2
23:30-23:45	0	0	0	0.0	0	0	0	0.0	0	0	0	0.0
23:45-24:00	0	0	0	0.0	0	0	0	0.0	0	0	0	0.0
1時間計	0	3	3	1.0	0	0	0	0.0	0	3	3	0.7
0:00-0:15	0	0	0	0.0	0	0	0	0.0	0	0	0	0.0
0:15-0:30	0	0	0	0.0	0	0	0	0.0	0	0	0	0.0
0:30-0:45	0	0	0	0.0	0	0	0	0.0	0	0	0	0.0
0:45-1:00	0	0	0	0.0	0	0	0	0.0	0	0	0	0.0
1時間計	0	0	0	0.0	0	0	0	0.0	0	0	0	0.0
1:00-1:15	0	0	0	0.0	0	0	0	0.0	0	0	0	0.0
1:15-1:30	0	0	0	0.0	0	1	1	0.9	0	1	1	0.2
1:30-1:45	0	0	0	0.0	0	0	0	0.0	0	0	0	0.0
1:45-2:00	0	0	0	0.0	0	0	0	0.0	0	0	0	0.0
1時間計	0	0	0	0.0	0	1	1	0.9	0	1	1	0.2
2:00-2:15	0	0	0	0.0	1	0	1	0.9	1	0	1	0.2
2:15-2:30	0	0	0	0.0	0	0	0	0.0	0	0	0	0.0
2:30-2:45	0	0	0	0.0	0	0	0	0.0	0	0	0	0.0
2:45-3:00	0	0	0	0.0	0	0	0	0.0	0	0	0	0.0
1時間計	0	0	0	0.0	1	0	1	0.9	1	0	1	0.2
3:00-3:15	0	1	1	0.3	0	0	0	0.0	0	1	1	0.2
3:15-3:30	0	0	0	0.0	0	0	0	0.0	0	0	0	0.0
3:30-3:45	0	0	0	0.0	0	0	0	0.0	0	0	0	0.0
3:45-4:00	0	0	0	0.0	0	0	0	0.0	0	0	0	0.0
1時間計	0	1	1	0.3	0	0	0	0.0	0	1	1	0.2
4:00-4:15	0	0	0	0.0	0	0	0	0.0	0	0	0	0.0
4:15-4:30	0	0	0	0.0	0	0	0	0.0	0	0	0	0.0
4:30-4:45	0	0	0	0.0	0	0	0	0.0	0	0	0	0.0
4:45-5:00	0	1	1	0.3	0	0	0	0.0	0	1	1	0.2
1時間計	0	1	1	0.3	0	0	0	0.0	0	1	1	0.2
5:00-5:15	0	0	0	0.0	0	0	0	0.0	0	0	0	0.0
5:15-5:30	0	1	1	0.3	0	0	0	0.0	0	1	1	0.2
5:30-5:45	0	0	0	0.0	0	0	0	0.0	0	0	0	0.0
5:45-6:00	0	2	2	0.6	0	0	0	0.0	0	2	2	0.5
1時間計	0	3	3	1.0	0	0	0	0.0	0	3	3	0.7
6:00-6:15	1	0	1	0.3	0	0	0	0.0	1	0	1	0.2
6:15-6:30	2	1	3	1.0	1	0	1	0.9	3	1	4	0.9
6:30-6:45	1	0	1	0.3	0	0	0	0.0	1	0	1	0.2
6:45-7:00	0	9	9	2.9	1	0	1	0.9	1	9	10	2.3
1時間計	4	10	14	4.5	2	0	2	1.7	6	10	16	3.7
夜12時間計	8	35	43	13.7	11	13	24	20.9	19	48	67	15.7
全時間合計	76	237	313	100.0	56	59	115	100.0	132	296	428	100.0
昼夜率	1.12	1.17	1.16	-	1.24	1.28	1.26	-	1.17	1.19	1.19	-

歩行者通行量調査表

調査地点：地域社会4 滝沢

調査年月日：令和 2年 9月21日(月・祝) 天候:曇りのち晴れ



時間帯	種別	合計 (7+イ+ウ+エ)			時間係数 (%)
		歩行者 (人)	自転車 (台)	合計 (人・台)	
7:00-7:15		2	10	12	2.6
7:15-7:30		1	4	5	1.1
7:30-7:45		0	7	7	1.5
7:45-8:00		2	15	17	3.7
1時間計		5	36	41	8.9
8:00-8:15		7	19	26	5.6
8:15-8:30		0	7	7	1.5
8:30-8:45		1	2	3	0.6
8:45-9:00		2	3	5	1.1
1時間計		10	31	41	8.9
9:00-9:15		4	3	7	1.5
9:15-9:30		1	0	1	0.2
9:30-9:45		4	11	15	3.2
9:45-10:00		1	7	8	1.7
1時間計		10	21	31	6.7
10:00-10:15		1	6	7	1.5
10:15-10:30		4	4	8	1.7
10:30-10:45		3	8	11	2.4
10:45-11:00		2	6	8	1.7
1時間計		10	24	34	7.4
11:00-11:15		7	10	17	3.7
11:15-11:30		3	5	8	1.7
11:30-11:45		6	5	11	2.4
11:45-12:00		2	2	4	0.9
1時間計		18	22	40	8.7
12:00-12:15		4	7	11	2.4
12:15-12:30		7	2	9	1.9
12:30-12:45		0	3	3	0.6
12:45-13:00		1	6	7	1.5
1時間計		12	18	30	6.5
13:00-13:15		3	6	9	1.9
13:15-13:30		3	10	13	2.8
13:30-13:45		2	10	12	2.6
13:45-14:00		5	6	11	2.4
1時間計		13	32	45	9.7
14:00-14:15		4	2	6	1.3
14:15-14:30		1	2	3	0.6
14:30-14:45		6	8	14	3.0
14:45-15:00		0	0	0	0.0
1時間計		11	12	23	5.0
15:00-15:15		3	3	6	1.3
15:15-15:30		1	8	9	1.9
15:30-15:45		0	9	9	1.9
15:45-16:00		5	3	8	1.7
1時間計		9	23	32	6.9
16:00-16:15		5	3	8	1.7
16:15-16:30		4	7	11	2.4
16:30-16:45		3	4	7	1.5
16:45-17:00		3	5	8	1.7
1時間計		15	19	34	7.4
17:00-17:15		3	1	4	0.9
17:15-17:30		2	1	3	0.6
17:30-17:45		6	3	9	1.9
17:45-18:00		3	1	4	0.9
1時間計		14	6	20	4.3
18:00-18:15		2	11	13	2.8
18:15-18:30		1	2	3	0.6
18:30-18:45		0	1	1	0.2
18:45-19:00		4	1	5	1.1
1時間計		7	15	22	4.8
昼12時間計		134	259	393	85.1

時間帯	種別	合計 (7+イ+ウ+エ)			時間係数 (%)
		歩行者 (人)	自転車 (台)	合計 (人・台)	
7:00-8:00		5	36	41	8.9
7:15-8:15		10	45	55	11.9
7:30-8:30		9	48	57	12.3
7:45-8:45		10	43	53	11.5
8:00-9:00		10	31	41	8.9
8:15-9:15		7	15	22	4.8
8:30-9:30		8	8	16	3.5
8:45-9:45		11	17	28	6.1
9:00-10:00		10	21	31	6.7
9:15-10:15		7	24	31	6.7
9:30-10:30		10	28	38	8.2
9:45-10:45		9	25	34	7.4
10:00-11:00		10	24	34	7.4
10:15-11:15		16	28	44	9.5
10:30-11:30		15	29	44	9.5
10:45-11:45		18	26	44	9.5
11:00-12:00		18	22	40	8.7
11:15-12:15		15	19	34	7.4
11:30-12:30		19	16	35	7.6
11:45-12:45		13	14	27	5.8
12:00-13:00		12	18	30	6.5
12:15-13:15		11	17	28	6.1
12:30-13:30		7	25	32	6.9
12:45-13:45		9	32	41	8.9
13:00-14:00		13	32	45	9.7
13:15-14:15		14	28	42	9.1
13:30-14:30		12	20	32	6.9
13:45-14:45		16	18	34	7.4
14:00-15:00		11	12	23	5.0
14:15-15:15		10	13	23	5.0
14:30-15:30		10	19	29	6.3
14:45-15:45		4	20	24	5.2
15:00-16:00		9	23	32	6.9
15:15-16:15		11	23	34	7.4
15:30-16:30		14	22	36	7.8
15:45-16:45		17	17	34	7.4
16:00-17:00		15	19	34	7.4
16:15-17:15		13	17	30	6.5
16:30-17:30		11	11	22	4.8
16:45-17:45		14	10	24	5.2
17:00-18:00		14	6	20	4.3
17:15-18:15		13	16	29	6.3
17:30-18:30		12	17	29	6.3
17:45-18:45		6	15	21	4.5
18:00-19:00		7	15	22	4.8
18:15-19:15		5	6	11	2.4
18:30-19:30		5	4	9	1.9
18:45-19:45		6	4	10	2.2
19:00-20:00		6	4	10	2.2
19:15-20:15		6	2	8	1.7
19:30-20:30		6	6	12	2.6
19:45-20:45		6	9	15	3.2
20:00-21:00		4	10	14	3.0
20:15-21:15		5	13	18	3.9
20:30-21:30		4	10	14	3.0
20:45-21:45		3	7	10	2.2
21:00-22:00		1	13	14	3.0
21:15-22:15		0	10	10	2.2
21:30-22:30		1	9	10	2.2
21:45-22:45		2	10	12	2.6
22:00-23:00		2	2	4	0.9

歩行者通行量調査表

調査地点：地域社会4 滝沢

調査年月日：令和 2年 9月21日(月・祝) 天候:曇りのち晴れ



時間帯	種別	合計 (7+イ+ウ+E)			時間係数 (%)
		歩行者 (人)	自転車 (台)	合計 (人・台)	
19:00-19:15		0	2	2	0.4
19:15-19:30		1	0	1	0.2
19:30-19:45		1	1	2	0.4
19:45-20:00		4	1	5	1.1
1時間計		6	4	10	2.2
20:00-20:15		0	0	0	0.0
20:15-20:30		1	4	5	1.1
20:30-20:45		1	4	5	1.1
20:45-21:00		2	2	4	0.9
1時間計		4	10	14	3.0
21:00-21:15		1	3	4	0.9
21:15-21:30		0	1	1	0.2
21:30-21:45		0	1	1	0.2
21:45-22:00		0	8	8	1.7
1時間計		1	13	14	3.0
22:00-22:15		0	0	0	0.0
22:15-22:30		1	0	1	0.2
22:30-22:45		1	2	3	0.6
22:45-23:00		0	0	0	0.0
1時間計		2	2	4	0.9
23:00-23:15		0	2	2	0.4
23:15-23:30		0	1	1	0.2
23:30-23:45		0	0	0	0.0
23:45-24:00		0	0	0	0.0
1時間計		0	3	3	0.6
0:00-0:15		0	0	0	0.0
0:15-0:30		0	0	0	0.0
0:30-0:45		0	0	0	0.0
0:45-1:00		0	0	0	0.0
1時間計		0	0	0	0.0
1:00-1:15		0	0	0	0.0
1:15-1:30		0	1	1	0.2
1:30-1:45		0	0	0	0.0
1:45-2:00		0	0	0	0.0
1時間計		0	1	1	0.2
2:00-2:15		1	0	1	0.2
2:15-2:30		0	0	0	0.0
2:30-2:45		0	0	0	0.0
2:45-3:00		0	0	0	0.0
1時間計		1	0	1	0.2
3:00-3:15		0	1	1	0.2
3:15-3:30		0	0	0	0.0
3:30-3:45		0	0	0	0.0
3:45-4:00		0	0	0	0.0
1時間計		0	1	1	0.2
4:00-4:15		0	0	0	0.0
4:15-4:30		0	0	0	0.0
4:30-4:45		0	0	0	0.0
4:45-5:00		0	1	1	0.2
1時間計		0	1	1	0.2
5:00-5:15		0	0	0	0.0
5:15-5:30		0	1	1	0.2
5:30-5:45		0	0	0	0.0
5:45-6:00		0	2	2	0.4
1時間計		0	3	3	0.6
6:00-6:15		1	0	1	0.2
6:15-6:30		3	2	5	1.1
6:30-6:45		1	0	1	0.2
6:45-7:00		1	9	10	2.2
1時間計		6	11	17	3.7
夜12時間計		20	49	69	14.9
全時間合計		154	308	462	100.0
昼夜率		1.15	1.19	1.18	-

時間帯	種別	合計 (7+イ+ウ+E)			時間係数 (%)
		歩行者 (人)	自転車 (台)	合計 (人・台)	
22:15-23:15		2	4	6	1.3
22:30-23:30		1	5	6	1.3
22:45-23:45		0	3	3	0.6
23:00-0:00		0	3	3	0.6
23:15-0:15		0	1	1	0.2
23:30-0:30		0	0	0	0.0
23:45-0:45		0	0	0	0.0
0:00-1:00		0	0	0	0.0
0:15-1:15		0	0	0	0.0
0:30-1:30		0	1	1	0.2
0:45-1:45		0	1	1	0.2
1:00-2:00		0	1	1	0.2
1:15-2:15		1	1	2	0.4
1:30-2:30		1	0	1	0.2
1:45-2:45		1	0	1	0.2
2:00-3:00		1	0	1	0.2
2:15-3:15		0	1	1	0.2
2:30-3:30		0	1	1	0.2
2:45-3:45		0	1	1	0.2
3:00-4:00		0	1	1	0.2
3:15-4:15		0	0	0	0.0
3:30-4:30		0	0	0	0.0
3:45-4:45		0	0	0	0.0
4:00-5:00		0	1	1	0.2
4:15-5:15		0	1	1	0.2
4:30-5:30		0	2	2	0.4
4:45-5:45		0	2	2	0.4
5:00-6:00		0	3	3	0.6
5:15-6:15		1	3	4	0.9
5:30-6:30		4	4	8	1.7
5:45-6:45		5	4	9	1.9
6:00-7:00		6	11	17	3.7
全時間合計		154	308	462	100.0

歩行者通行量調査表

調査地点：地域社会4 瀬谷土橋公園入口

調査年月日：令和 2年 9月21日(月・祝) 天候：曇りのち晴れ



時間帯	ア				イ				合計			
	歩行者 (人)	自転車 (台)	合計 (人・台)	時間 係数 (%)	歩行者 (人)	自転車 (台)	合計 (人・台)	時間 係数 (%)	歩行者 (人)	自転車 (台)	合計 (人・台)	時間 係数 (%)
7:00-7:15	0	0	0	0.0	1	0	1	2.9	1	0	1	1.5
7:15-7:30	2	0	2	5.9	0	0	0	0.0	2	0	2	2.9
7:30-7:45	2	0	2	5.9	3	0	3	8.8	5	0	5	7.4
7:45-8:00	1	0	1	2.9	1	0	1	2.9	2	0	2	2.9
1時間計	5	0	5	14.7	5	0	5	14.7	10	0	10	14.7
8:00-8:15	1	0	1	2.9	1	0	1	2.9	2	0	2	2.9
8:15-8:30	1	0	1	2.9	1	0	1	2.9	2	0	2	2.9
8:30-8:45	0	0	0	0.0	0	2	2	5.9	0	2	2	2.9
8:45-9:00	1	0	1	2.9	0	1	1	2.9	1	1	2	2.9
1時間計	3	0	3	8.8	2	3	5	14.7	5	3	8	11.8
9:00-9:15	0	0	0	0.0	0	0	0	0.0	0	0	0	0.0
9:15-9:30	0	0	0	0.0	0	1	1	2.9	0	1	1	1.5
9:30-9:45	0	1	1	2.9	0	0	0	0.0	0	1	1	1.5
9:45-10:00	0	0	0	0.0	0	2	2	5.9	0	2	2	2.9
1時間計	0	1	1	2.9	0	3	3	8.8	0	4	4	5.9
10:00-10:15	0	0	0	0.0	0	0	0	0.0	0	0	0	0.0
10:15-10:30	0	0	0	0.0	0	0	0	0.0	0	0	0	0.0
10:30-10:45	0	0	0	0.0	0	0	0	0.0	0	0	0	0.0
10:45-11:00	0	0	0	0.0	1	0	1	2.9	1	0	1	1.5
1時間計	0	0	0	0.0	1	0	1	2.9	1	0	1	1.5
11:00-11:15	1	0	1	2.9	0	0	0	0.0	1	0	1	1.5
11:15-11:30	1	0	1	2.9	0	0	0	0.0	1	0	1	1.5
11:30-11:45	0	0	0	0.0	0	0	0	0.0	0	0	0	0.0
11:45-12:00	0	0	0	0.0	0	0	0	0.0	0	0	0	0.0
1時間計	2	0	2	5.9	0	0	0	0.0	2	0	2	2.9
12:00-12:15	0	0	0	0.0	3	0	3	8.8	3	0	3	4.4
12:15-12:30	0	0	0	0.0	0	0	0	0.0	0	0	0	0.0
12:30-12:45	0	0	0	0.0	0	0	0	0.0	0	0	0	0.0
12:45-13:00	0	0	0	0.0	0	0	0	0.0	0	0	0	0.0
1時間計	0	0	0	0.0	3	0	3	8.8	3	0	3	4.4
13:00-13:15	2	0	2	5.9	0	0	0	0.0	2	0	2	2.9
13:15-13:30	0	0	0	0.0	0	0	0	0.0	0	0	0	0.0
13:30-13:45	1	0	1	2.9	0	0	0	0.0	1	0	1	1.5
13:45-14:00	0	0	0	0.0	0	0	0	0.0	0	0	0	0.0
1時間計	3	0	3	8.8	0	0	0	0.0	3	0	3	4.4
14:00-14:15	1	0	1	2.9	2	0	2	5.9	3	0	3	4.4
14:15-14:30	0	0	0	0.0	1	1	2	5.9	1	1	2	2.9
14:30-14:45	0	0	0	0.0	0	0	0	0.0	0	0	0	0.0
14:45-15:00	1	0	1	2.9	0	0	0	0.0	1	0	1	1.5
1時間計	2	0	2	5.9	3	1	4	11.8	5	1	6	8.8

歩行者通行量調査表

調査地点：地域社会4 瀬谷土橋公園入口

調査年月日：令和 2年 9月21日(月・祝) 天候：曇りのち晴れ



方向	ア				イ				合計			
	歩行者 (人)	自転車 (台)	合計 (人・台)	時間 係数 (%)	歩行者 (人)	自転車 (台)	合計 (人・台)	時間 係数 (%)	歩行者 (人)	自転車 (台)	合計 (人・台)	時間 係数 (%)
15:00-15:15	0	0	0	0.0	0	0	0	0.0	0	0	0	0.0
15:15-15:30	1	1	2	5.9	2	0	2	5.9	3	1	4	5.9
15:30-15:45	0	0	0	0.0	0	0	0	0.0	0	0	0	0.0
15:45-16:00	0	0	0	0.0	0	0	0	0.0	0	0	0	0.0
1時間計	1	1	2	5.9	2	0	2	5.9	3	1	4	5.9
16:00-16:15	0	0	0	0.0	0	0	0	0.0	0	0	0	0.0
16:15-16:30	0	1	1	2.9	0	1	1	2.9	0	2	2	2.9
16:30-16:45	0	3	3	8.8	0	0	0	0.0	0	3	3	4.4
16:45-17:00	0	2	2	5.9	0	0	0	0.0	0	2	2	2.9
1時間計	0	6	6	17.6	0	1	1	2.9	0	7	7	10.3
17:00-17:15	0	0	0	0.0	0	0	0	0.0	0	0	0	0.0
17:15-17:30	0	0	0	0.0	0	0	0	0.0	0	0	0	0.0
17:30-17:45	0	0	0	0.0	0	0	0	0.0	0	0	0	0.0
17:45-18:00	1	1	2	5.9	0	0	0	0.0	1	1	2	2.9
1時間計	1	1	2	5.9	0	0	0	0.0	1	1	2	2.9
18:00-18:15	0	0	0	0.0	0	0	0	0.0	0	0	0	0.0
18:15-18:30	0	0	0	0.0	0	0	0	0.0	0	0	0	0.0
18:30-18:45	0	0	0	0.0	0	0	0	0.0	0	0	0	0.0
18:45-19:00	0	0	0	0.0	0	0	0	0.0	0	0	0	0.0
1時間計	0	0	0	0.0	0	0	0	0.0	0	0	0	0.0
昼12時間計	17	9	26	76.5	16	8	24	70.6	33	17	50	73.5
19:00-19:15	0	0	0	0.0	0	0	0	0.0	0	0	0	0.0
19:15-19:30	0	0	0	0.0	0	0	0	0.0	0	0	0	0.0
19:30-19:45	1	0	1	2.9	0	0	0	0.0	1	0	1	1.5
19:45-20:00	0	0	0	0.0	1	0	1	2.9	1	0	1	1.5
1時間計	1	0	1	2.9	1	0	1	2.9	2	0	2	2.9
20:00-20:15	1	0	1	2.9	0	2	2	5.9	1	2	3	4.4
20:15-20:30	1	0	1	2.9	1	2	3	8.8	2	2	4	5.9
20:30-20:45	0	0	0	0.0	0	0	0	0.0	0	0	0	0.0
20:45-21:00	1	0	1	2.9	0	0	0	0.0	1	0	1	1.5
1時間計	3	0	3	8.8	1	4	5	14.7	4	4	8	11.8
21:00-21:15	0	0	0	0.0	0	0	0	0.0	0	0	0	0.0
21:15-21:30	0	0	0	0.0	0	0	0	0.0	0	0	0	0.0
21:30-21:45	0	0	0	0.0	0	0	0	0.0	0	0	0	0.0
21:45-22:00	0	0	0	0.0	0	0	0	0.0	0	0	0	0.0
1時間計	0	0	0	0.0	0	0	0	0.0	0	0	0	0.0
22:00-22:15	0	0	0	0.0	0	0	0	0.0	0	0	0	0.0
22:15-22:30	0	0	0	0.0	0	0	0	0.0	0	0	0	0.0
22:30-22:45	0	0	0	0.0	0	0	0	0.0	0	0	0	0.0
22:45-23:00	0	0	0	0.0	0	0	0	0.0	0	0	0	0.0
1時間計	0	0	0	0.0	0	0	0	0.0	0	0	0	0.0

歩行者通行量調査表

調査地点：地域社会4 瀬谷土橋公園入口

調査年月日：令和2年9月21日(月・祝) 天候：曇りのち晴れ



方向 種別	ア				イ				合計			
	歩行者 (人)	自転車 (台)	合計 (人・台)	時間 係数 (%)	歩行者 (人)	自転車 (台)	合計 (人・台)	時間 係数 (%)	歩行者 (人)	自転車 (台)	合計 (人・台)	時間 係数 (%)
23:00-23:15	0	0	0	0.0	0	0	0	0.0	0	0	0	0.0
23:15-23:30	0	0	0	0.0	0	0	0	0.0	0	0	0	0.0
23:30-23:45	0	0	0	0.0	0	0	0	0.0	0	0	0	0.0
23:45-24:00	0	0	0	0.0	0	1	1	2.9	0	1	1	1.5
1時間計	0	0	0	0.0	0	1	1	2.9	0	1	1	1.5
0:00-0:15	0	0	0	0.0	0	0	0	0.0	0	0	0	0.0
0:15-0:30	0	0	0	0.0	0	0	0	0.0	0	0	0	0.0
0:30-0:45	0	0	0	0.0	0	0	0	0.0	0	0	0	0.0
0:45-1:00	0	0	0	0.0	0	0	0	0.0	0	0	0	0.0
1時間計	0	0	0	0.0	0	0	0	0.0	0	0	0	0.0
1:00-1:15	0	0	0	0.0	0	0	0	0.0	0	0	0	0.0
1:15-1:30	0	0	0	0.0	0	0	0	0.0	0	0	0	0.0
1:30-1:45	0	0	0	0.0	0	0	0	0.0	0	0	0	0.0
1:45-2:00	0	0	0	0.0	0	0	0	0.0	0	0	0	0.0
1時間計	0	0	0	0.0	0	0	0	0.0	0	0	0	0.0
2:00-2:15	1	0	1	2.9	1	0	1	2.9	2	0	2	2.9
2:15-2:30	0	0	0	0.0	0	0	0	0.0	0	0	0	0.0
2:30-2:45	0	0	0	0.0	0	0	0	0.0	0	0	0	0.0
2:45-3:00	1	0	1	2.9	0	0	0	0.0	1	0	1	1.5
1時間計	2	0	2	5.9	1	0	1	2.9	3	0	3	4.4
3:00-3:15	0	0	0	0.0	0	0	0	0.0	0	0	0	0.0
3:15-3:30	0	0	0	0.0	0	0	0	0.0	0	0	0	0.0
3:30-3:45	0	0	0	0.0	0	0	0	0.0	0	0	0	0.0
3:45-4:00	0	0	0	0.0	0	0	0	0.0	0	0	0	0.0
1時間計	0	0	0	0.0	0	0	0	0.0	0	0	0	0.0
4:00-4:15	0	0	0	0.0	0	0	0	0.0	0	0	0	0.0
4:15-4:30	0	0	0	0.0	0	0	0	0.0	0	0	0	0.0
4:30-4:45	0	0	0	0.0	0	0	0	0.0	0	0	0	0.0
4:45-5:00	0	0	0	0.0	0	0	0	0.0	0	0	0	0.0
1時間計	0	0	0	0.0	0	0	0	0.0	0	0	0	0.0
5:00-5:15	0	0	0	0.0	0	0	0	0.0	0	0	0	0.0
5:15-5:30	1	0	1	2.9	0	0	0	0.0	1	0	1	1.5
5:30-5:45	1	0	1	2.9	0	0	0	0.0	1	0	1	1.5
5:45-6:00	0	0	0	0.0	0	0	0	0.0	0	0	0	0.0
1時間計	2	0	2	5.9	0	0	0	0.0	2	0	2	2.9
6:00-6:15	0	0	0	0.0	1	0	1	2.9	1	0	1	1.5
6:15-6:30	0	0	0	0.0	0	0	0	0.0	0	0	0	0.0
6:30-6:45	0	0	0	0.0	0	0	0	0.0	0	0	0	0.0
6:45-7:00	0	0	0	0.0	1	0	1	2.9	1	0	1	1.5
1時間計	0	0	0	0.0	2	0	2	5.9	2	0	2	2.9
夜12時間計	8	0	8	23.5	5	5	10	29.4	13	5	18	26.5
全時間合計	25	9	34	100.0	21	13	34	100.0	46	22	68	100.0
昼夜率	1.47	1.00	1.31	-	1.31	1.63	1.42	-	1.39	1.29	1.36	-

歩行者通行量調査表

調査地点：地域社会4 瀬谷土橋公園入口

調査年月日：令和 2年 9月21日(月・祝) 天候：曇りのち晴れ



時間帯	種別	ウ				エ				合計			
		歩行者 (人)	自転車 (台)	合計 (人・台)	時間 係数 (%)	歩行者 (人)	自転車 (台)	合計 (人・台)	時間 係数 (%)	歩行者 (人)	自転車 (台)	合計 (人・台)	時間 係数 (%)
7:00-7:15		0	1	1	0.4	1	5	6	5.6	1	6	7	1.9
7:15-7:30		1	5	6	2.2	0	0	0	0.0	1	5	6	1.6
7:30-7:45		0	8	8	3.0	0	0	0	0.0	0	8	8	2.1
7:45-8:00		1	0	1	0.4	5	0	5	4.7	6	0	6	1.6
1時間計		2	14	16	5.9	6	5	11	10.3	8	19	27	7.2
8:00-8:15		0	3	3	1.1	2	1	3	2.8	2	4	6	1.6
8:15-8:30		4	0	4	1.5	0	1	1	0.9	4	1	5	1.3
8:30-8:45		2	3	5	1.9	0	0	0	0.0	2	3	5	1.3
8:45-9:00		4	2	6	2.2	0	0	0	0.0	4	2	6	1.6
1時間計		10	8	18	6.7	2	2	4	3.7	12	10	22	5.9
9:00-9:15		0	4	4	1.5	1	0	1	0.9	1	4	5	1.3
9:15-9:30		0	0	0	0.0	0	0	0	0.0	0	0	0	0.0
9:30-9:45		5	6	11	4.1	0	1	1	0.9	5	7	12	3.2
9:45-10:00		9	0	9	3.3	0	0	0	0.0	9	0	9	2.4
1時間計		14	10	24	8.9	1	1	2	1.9	15	11	26	6.9
10:00-10:15		0	6	6	2.2	1	0	1	0.9	1	6	7	1.9
10:15-10:30		2	3	5	1.9	0	0	0	0.0	2	3	5	1.3
10:30-10:45		2	2	4	1.5	0	0	0	0.0	2	2	4	1.1
10:45-11:00		3	9	12	4.5	1	0	1	0.9	4	9	13	3.5
1時間計		7	20	27	10.0	2	0	2	1.9	9	20	29	7.7
11:00-11:15		12	10	22	8.2	8	1	9	8.4	20	11	31	8.2
11:15-11:30		1	2	3	1.1	1	0	1	0.9	2	2	4	1.1
11:30-11:45		3	0	3	1.1	2	1	3	2.8	5	1	6	1.6
11:45-12:00		2	3	5	1.9	3	2	5	4.7	5	5	10	2.7
1時間計		18	15	33	12.3	14	4	18	16.8	32	19	51	13.6
12:00-12:15		0	2	2	0.7	0	2	2	1.9	0	4	4	1.1
12:15-12:30		0	2	2	0.7	0	0	0	0.0	0	2	2	0.5
12:30-12:45		2	2	4	1.5	0	0	0	0.0	2	2	4	1.1
12:45-13:00		2	5	7	2.6	0	1	1	0.9	2	6	8	2.1
1時間計		4	11	15	5.6	0	3	3	2.8	4	14	18	4.8
13:00-13:15		0	1	1	0.4	0	4	4	3.7	0	5	5	1.3
13:15-13:30		0	7	7	2.6	1	3	4	3.7	1	10	11	2.9
13:30-13:45		0	8	8	3.0	0	1	1	0.9	0	9	9	2.4
13:45-14:00		0	6	6	2.2	0	2	2	1.9	0	8	8	2.1
1時間計		0	22	22	8.2	1	10	11	10.3	1	32	33	8.8
14:00-14:15		0	2	2	0.7	0	2	2	1.9	0	4	4	1.1
14:15-14:30		2	0	2	0.7	0	0	0	0.0	2	0	2	0.5
14:30-14:45		1	5	6	2.2	1	1	2	1.9	2	6	8	2.1
14:45-15:00		1	4	5	1.9	0	0	0	0.0	1	4	5	1.3
1時間計		4	11	15	5.6	1	3	4	3.7	5	14	19	5.1

歩行者通行量調査表

調査地点：地域社会4 瀬谷土橋公園入口

調査年月日：令和 2年 9月21日(月・祝) 天候：曇りのち晴れ



時間帯	ウ				I				合計			
	歩行者 (人)	自転車 (台)	合計 (人・台)	時間 係数 (%)	歩行者 (人)	自転車 (台)	合計 (人・台)	時間 係数 (%)	歩行者 (人)	自転車 (台)	合計 (人・台)	時間 係数 (%)
15:00-15:15	2	4	6	2.2	0	2	2	1.9	2	6	8	2.1
15:15-15:30	2	3	5	1.9	2	6	8	7.5	4	9	13	3.5
15:30-15:45	0	2	2	0.7	1	1	2	1.9	1	3	4	1.1
15:45-16:00	1	1	2	0.7	1	1	2	1.9	2	2	4	1.1
1時間計	5	10	15	5.6	4	10	14	13.1	9	20	29	7.7
16:00-16:15	2	2	4	1.5	0	0	0	0.0	2	2	4	1.1
16:15-16:30	0	1	1	0.4	2	2	4	3.7	2	3	5	1.3
16:30-16:45	1	3	4	1.5	1	2	3	2.8	2	5	7	1.9
16:45-17:00	1	8	9	3.3	0	0	0	0.0	1	8	9	2.4
1時間計	4	14	18	6.7	3	4	7	6.5	7	18	25	6.6
17:00-17:15	0	1	1	0.4	0	0	0	0.0	0	1	1	0.3
17:15-17:30	1	1	2	0.7	0	0	0	0.0	1	1	2	0.5
17:30-17:45	0	2	2	0.7	1	2	3	2.8	1	4	5	1.3
17:45-18:00	3	0	3	1.1	0	1	1	0.9	3	1	4	1.1
1時間計	4	4	8	3.0	1	3	4	3.7	5	7	12	3.2
18:00-18:15	0	7	7	2.6	0	2	2	1.9	0	9	9	2.4
18:15-18:30	0	2	2	0.7	0	1	1	0.9	0	3	3	0.8
18:30-18:45	3	0	3	1.1	0	2	2	1.9	3	2	5	1.3
18:45-19:00	1	1	2	0.7	0	0	0	0.0	1	1	2	0.5
1時間計	4	10	14	5.2	0	5	5	4.7	4	15	19	5.1
昼12時間計	76	149	225	83.6	35	50	85	79.4	111	199	310	82.4
19:00-19:15	0	1	1	0.4	0	0	0	0.0	0	1	1	0.3
19:15-19:30	0	0	0	0.0	1	0	1	0.9	1	0	1	0.3
19:30-19:45	0	1	1	0.4	0	0	0	0.0	0	1	1	0.3
19:45-20:00	0	1	1	0.4	0	1	1	0.9	0	2	2	0.5
1時間計	0	3	3	1.1	1	1	2	1.9	1	4	5	1.3
20:00-20:15	0	0	0	0.0	0	2	2	1.9	0	2	2	0.5
20:15-20:30	0	1	1	0.4	0	2	2	1.9	0	3	3	0.8
20:30-20:45	0	2	2	0.7	0	0	0	0.0	0	2	2	0.5
20:45-21:00	1	2	3	1.1	0	0	0	0.0	1	2	3	0.8
1時間計	1	5	6	2.2	0	4	4	3.7	1	9	10	2.7
21:00-21:15	0	1	1	0.4	0	2	2	1.9	0	3	3	0.8
21:15-21:30	0	1	1	0.4	0	1	1	0.9	0	2	2	0.5
21:30-21:45	0	1	1	0.4	0	0	0	0.0	0	1	1	0.3
21:45-22:00	0	6	6	2.2	0	0	0	0.0	0	6	6	1.6
1時間計	0	9	9	3.3	0	3	3	2.8	0	12	12	3.2
22:00-22:15	0	0	0	0.0	0	0	0	0.0	0	0	0	0.0
22:15-22:30	0	0	0	0.0	0	0	0	0.0	0	0	0	0.0
22:30-22:45	0	0	0	0.0	0	1	1	0.9	0	1	1	0.3
22:45-23:00	0	0	0	0.0	3	0	3	2.8	3	0	3	0.8
1時間計	0	0	0	0.0	3	1	4	3.7	3	1	4	1.1

歩行者通行量調査表

調査地点：地域社会4 瀬谷土橋公園入口

調査年月日：令和 2年 9月21日(月・祝) 天候：曇りのち晴れ



時間帯	ウ				エ				合計			
	歩行者 (人)	自転車 (台)	合計 (人・台)	時間 係数 (%)	歩行者 (人)	自転車 (台)	合計 (人・台)	時間 係数 (%)	歩行者 (人)	自転車 (台)	合計 (人・台)	時間 係数 (%)
23:00-23:15	1	2	3	1.1	0	0	0	0.0	1	2	3	0.8
23:15-23:30	0	0	0	0.0	0	0	0	0.0	0	0	0	0.0
23:30-23:45	1	0	1	0.4	0	0	0	0.0	1	0	1	0.3
23:45-24:00	0	0	0	0.0	0	0	0	0.0	0	0	0	0.0
1時間計	2	2	4	1.5	0	0	0	0.0	2	2	4	1.1
0:00-0:15	0	0	0	0.0	0	0	0	0.0	0	0	0	0.0
0:15-0:30	0	0	0	0.0	0	0	0	0.0	0	0	0	0.0
0:30-0:45	0	0	0	0.0	0	0	0	0.0	0	0	0	0.0
0:45-1:00	0	0	0	0.0	0	0	0	0.0	0	0	0	0.0
1時間計	0	0	0	0.0	0	0	0	0.0	0	0	0	0.0
1:00-1:15	0	0	0	0.0	0	0	0	0.0	0	0	0	0.0
1:15-1:30	0	0	0	0.0	0	0	0	0.0	0	0	0	0.0
1:30-1:45	0	0	0	0.0	0	0	0	0.0	0	0	0	0.0
1:45-2:00	0	0	0	0.0	0	0	0	0.0	0	0	0	0.0
1時間計	0	0	0	0.0	0	0	0	0.0	0	0	0	0.0
2:00-2:15	0	0	0	0.0	0	0	0	0.0	0	0	0	0.0
2:15-2:30	0	0	0	0.0	0	0	0	0.0	0	0	0	0.0
2:30-2:45	0	0	0	0.0	0	0	0	0.0	0	0	0	0.0
2:45-3:00	0	0	0	0.0	0	0	0	0.0	0	0	0	0.0
1時間計	0	0	0	0.0	0	0	0	0.0	0	0	0	0.0
3:00-3:15	0	1	1	0.4	0	0	0	0.0	0	1	1	0.3
3:15-3:30	0	0	0	0.0	0	0	0	0.0	0	0	0	0.0
3:30-3:45	0	0	0	0.0	0	0	0	0.0	0	0	0	0.0
3:45-4:00	0	0	0	0.0	0	0	0	0.0	0	0	0	0.0
1時間計	0	1	1	0.4	0	0	0	0.0	0	1	1	0.3
4:00-4:15	0	0	0	0.0	0	1	1	0.9	0	1	1	0.3
4:15-4:30	0	0	0	0.0	0	0	0	0.0	0	0	0	0.0
4:30-4:45	1	0	1	0.4	0	0	0	0.0	1	0	1	0.3
4:45-5:00	1	0	1	0.4	1	0	1	0.9	2	0	2	0.5
1時間計	2	0	2	0.7	1	1	2	1.9	3	1	4	1.1
5:00-5:15	2	0	2	0.7	2	0	2	1.9	4	0	4	1.1
5:15-5:30	1	0	1	0.4	1	0	1	0.9	2	0	2	0.5
5:30-5:45	3	0	3	1.1	1	0	1	0.9	4	0	4	1.1
5:45-6:00	0	1	1	0.4	1	0	1	0.9	1	1	2	0.5
1時間計	6	1	7	2.6	5	0	5	4.7	11	1	12	3.2
6:00-6:15	0	0	0	0.0	1	0	1	0.9	1	0	1	0.3
6:15-6:30	2	1	3	1.1	0	0	0	0.0	2	1	3	0.8
6:30-6:45	0	0	0	0.0	0	0	0	0.0	0	0	0	0.0
6:45-7:00	1	8	9	3.3	1	0	1	0.9	2	8	10	2.7
1時間計	3	9	12	4.5	2	0	2	1.9	5	9	14	3.7
夜12時間計	14	30	44	16.4	12	10	22	20.6	26	40	66	17.6
全時間合計	90	179	269	100.0	47	60	107	100.0	137	239	376	100.0
昼夜率	1.18	1.20	1.20	-	1.34	1.20	1.26	-	1.23	1.20	1.21	-

歩行者通行量調査表

調査地点：地域社会4 瀬谷土橋公園入口

調査年月日：令和2年9月21日(月・祝) 天候：曇りのち晴れ



時間帯	方向 種別	合計 (7+イ+ウ+E)			時間 係数 (%)
		歩行者 (人)	自転車 (台)	合計 (人・台)	
7:00-7:15		2	6	8	1.8
7:15-7:30		3	5	8	1.8
7:30-7:45		5	8	13	2.9
7:45-8:00		8	0	8	1.8
1時間計		18	19	37	8.3
8:00-8:15		4	4	8	1.8
8:15-8:30		6	1	7	1.6
8:30-8:45		2	5	7	1.6
8:45-9:00		5	3	8	1.8
1時間計		17	13	30	6.8
9:00-9:15		1	4	5	1.1
9:15-9:30		0	1	1	0.2
9:30-9:45		5	8	13	2.9
9:45-10:00		9	2	11	2.5
1時間計		15	15	30	6.8
10:00-10:15		1	6	7	1.6
10:15-10:30		2	3	5	1.1
10:30-10:45		2	2	4	0.9
10:45-11:00		5	9	14	3.2
1時間計		10	20	30	6.8
11:00-11:15		21	11	32	7.2
11:15-11:30		3	2	5	1.1
11:30-11:45		5	1	6	1.4
11:45-12:00		5	5	10	2.3
1時間計		34	19	53	11.9
12:00-12:15		3	4	7	1.6
12:15-12:30		0	2	2	0.5
12:30-12:45		2	2	4	0.9
12:45-13:00		2	6	8	1.8
1時間計		7	14	21	4.7
13:00-13:15		2	5	7	1.6
13:15-13:30		1	10	11	2.5
13:30-13:45		1	9	10	2.3
13:45-14:00		0	8	8	1.8
1時間計		4	32	36	8.1
14:00-14:15		3	4	7	1.6
14:15-14:30		3	1	4	0.9
14:30-14:45		2	6	8	1.8
14:45-15:00		2	4	6	1.4
1時間計		10	15	25	5.6
15:00-15:15		2	6	8	1.8
15:15-15:30		7	10	17	3.8
15:30-15:45		1	3	4	0.9
15:45-16:00		2	2	4	0.9
1時間計		12	21	33	7.4
16:00-16:15		2	2	4	0.9
16:15-16:30		2	5	7	1.6
16:30-16:45		2	8	10	2.3
16:45-17:00		1	10	11	2.5
1時間計		7	25	32	7.2
17:00-17:15		0	1	1	0.2
17:15-17:30		1	1	2	0.5
17:30-17:45		1	4	5	1.1
17:45-18:00		4	2	6	1.4
1時間計		6	8	14	3.2
18:00-18:15		0	9	9	2.0
18:15-18:30		0	3	3	0.7
18:30-18:45		3	2	5	1.1
18:45-19:00		1	1	2	0.5
1時間計		4	15	19	4.3
昼12時間計		144	216	360	81.1

時間帯	方向 種別	合計 (7+イ+ウ+E)			時間 係数 (%)
		歩行者 (人)	自転車 (台)	合計 (人・台)	
7:00-8:00		18	19	37	8.3
7:15-8:15		20	17	37	8.3
7:30-8:30		23	13	36	8.1
7:45-8:45		20	10	30	6.8
8:00-9:00		17	13	30	6.8
8:15-9:15		14	13	27	6.1
8:30-9:30		8	13	21	4.7
8:45-9:45		11	16	27	6.1
9:00-10:00		15	15	30	6.8
9:15-10:15		15	17	32	7.2
9:30-10:30		17	19	36	8.1
9:45-10:45		14	13	27	6.1
10:00-11:00		10	20	30	6.8
10:15-11:15		30	25	55	12.4
10:30-11:30		31	24	55	12.4
10:45-11:45		34	23	57	12.8
11:00-12:00		34	19	53	11.9
11:15-12:15		16	12	28	6.3
11:30-12:30		13	12	25	5.6
11:45-12:45		10	13	23	5.2
12:00-13:00		7	14	21	4.7
12:15-13:15		6	15	21	4.7
12:30-13:30		7	23	30	6.8
12:45-13:45		6	30	36	8.1
13:00-14:00		4	32	36	8.1
13:15-14:15		5	31	36	8.1
13:30-14:30		7	22	29	6.5
13:45-14:45		8	19	27	6.1
14:00-15:00		10	15	25	5.6
14:15-15:15		9	17	26	5.9
14:30-15:30		13	26	39	8.8
14:45-15:45		12	23	35	7.9
15:00-16:00		12	21	33	7.4
15:15-16:15		12	17	29	6.5
15:30-16:30		7	12	19	4.3
15:45-16:45		8	17	25	5.6
16:00-17:00		7	25	32	7.2
16:15-17:15		5	24	29	6.5
16:30-17:30		4	20	24	5.4
16:45-17:45		3	16	19	4.3
17:00-18:00		6	8	14	3.2
17:15-18:15		6	16	22	5.0
17:30-18:30		5	18	23	5.2
17:45-18:45		7	16	23	5.2
18:00-19:00		4	15	19	4.3
18:15-19:15		4	7	11	2.5
18:30-19:30		5	4	9	2.0
18:45-19:45		3	3	6	1.4
19:00-20:00		3	4	7	1.6
19:15-20:15		4	7	11	2.5
19:30-20:30		5	12	17	3.8
19:45-20:45		4	13	17	3.8
20:00-21:00		5	13	18	4.1
20:15-21:15		4	12	16	3.6
20:30-21:30		2	9	11	2.5
20:45-21:45		2	8	10	2.3
21:00-22:00		0	12	12	2.7
21:15-22:15		0	9	9	2.0
21:30-22:30		0	7	7	1.6
21:45-22:45		0	7	7	1.6
22:00-23:00		3	1	4	0.9

歩行者通行量調査表

調査地点：地域社会4 瀬谷土橋公園入口

調査年月日：令和 2年 9月21日(月・祝) 天候:曇りのち晴れ



時間帯	種別	合計 (7+イ+ウ+E)			時間係数 (%)
		歩行者 (人)	自転車 (台)	合計 (人・台)	
19:00-19:15		0	1	1	0.2
19:15-19:30		1	0	1	0.2
19:30-19:45		1	1	2	0.5
19:45-20:00		1	2	3	0.7
1時間計		3	4	7	1.6
20:00-20:15		1	4	5	1.1
20:15-20:30		2	5	7	1.6
20:30-20:45		0	2	2	0.5
20:45-21:00		2	2	4	0.9
1時間計		5	13	18	4.1
21:00-21:15		0	3	3	0.7
21:15-21:30		0	2	2	0.5
21:30-21:45		0	1	1	0.2
21:45-22:00		0	6	6	1.4
1時間計		0	12	12	2.7
22:00-22:15		0	0	0	0.0
22:15-22:30		0	0	0	0.0
22:30-22:45		0	1	1	0.2
22:45-23:00		3	0	3	0.7
1時間計		3	1	4	0.9
23:00-23:15		1	2	3	0.7
23:15-23:30		0	0	0	0.0
23:30-23:45		1	0	1	0.2
23:45-24:00		0	1	1	0.2
1時間計		2	3	5	1.1
0:00-0:15		0	0	0	0.0
0:15-0:30		0	0	0	0.0
0:30-0:45		0	0	0	0.0
0:45-1:00		0	0	0	0.0
1時間計		0	0	0	0.0
1:00-1:15		0	0	0	0.0
1:15-1:30		0	0	0	0.0
1:30-1:45		0	0	0	0.0
1:45-2:00		0	0	0	0.0
1時間計		0	0	0	0.0
2:00-2:15		2	0	2	0.5
2:15-2:30		0	0	0	0.0
2:30-2:45		0	0	0	0.0
2:45-3:00		1	0	1	0.2
1時間計		3	0	3	0.7
3:00-3:15		0	1	1	0.2
3:15-3:30		0	0	0	0.0
3:30-3:45		0	0	0	0.0
3:45-4:00		0	0	0	0.0
1時間計		0	1	1	0.2
4:00-4:15		0	1	1	0.2
4:15-4:30		0	0	0	0.0
4:30-4:45		1	0	1	0.2
4:45-5:00		2	0	2	0.5
1時間計		3	1	4	0.9
5:00-5:15		4	0	4	0.9
5:15-5:30		3	0	3	0.7
5:30-5:45		5	0	5	1.1
5:45-6:00		1	1	2	0.5
1時間計		13	1	14	3.2
6:00-6:15		2	0	2	0.5
6:15-6:30		2	1	3	0.7
6:30-6:45		0	0	0	0.0
6:45-7:00		3	8	11	2.5
1時間計		7	9	16	3.6
夜12時間計		39	45	84	18.9
全時間合計		183	261	444	100.0
昼夜率		1.27	1.21	1.23	-

時間帯	種別	合計 (7+イ+ウ+E)			時間係数 (%)
		歩行者 (人)	自転車 (台)	合計 (人・台)	
22:15-23:15		4	3	7	1.6
22:30-23:30		4	3	7	1.6
22:45-23:45		5	2	7	1.6
23:00-0:00		2	3	5	1.1
23:15-0:15		1	1	2	0.5
23:30-0:30		1	1	2	0.5
23:45-0:45		0	1	1	0.2
0:00-1:00		0	0	0	0.0
0:15-1:15		0	0	0	0.0
0:30-1:30		0	0	0	0.0
0:45-1:45		0	0	0	0.0
1:00-2:00		0	0	0	0.0
1:15-2:15		2	0	2	0.5
1:30-2:30		2	0	2	0.5
1:45-2:45		2	0	2	0.5
2:00-3:00		3	0	3	0.7
2:15-3:15		1	1	2	0.5
2:30-3:30		1	1	2	0.5
2:45-3:45		1	1	2	0.5
3:00-4:00		0	1	1	0.2
3:15-4:15		0	1	1	0.2
3:30-4:30		0	1	1	0.2
3:45-4:45		1	1	2	0.5
4:00-5:00		3	1	4	0.9
4:15-5:15		7	0	7	1.6
4:30-5:30		10	0	10	2.3
4:45-5:45		14	0	14	3.2
5:00-6:00		13	1	14	3.2
5:15-6:15		11	1	12	2.7
5:30-6:30		10	2	12	2.7
5:45-6:45		5	2	7	1.6
6:00-7:00		7	9	16	3.6
全時間合計		183	261	444	100.0

歩行者通行量調査表

調査地点：地域社会4 瀬谷土橋公園前

調査年月日：令和 2年 9月21日(月・祝) 天候：曇りのち晴れ



時間帯	ア				イ				合計			
	歩行者 (人)	自転車 (台)	合計 (人・台)	時間 係数 (%)	歩行者 (人)	自転車 (台)	合計 (人・台)	時間 係数 (%)	歩行者 (人)	自転車 (台)	合計 (人・台)	時間 係数 (%)
7:00-7:15	0	1	1	4.2	1	0	1	3.2	1	1	2	3.6
7:15-7:30	0	0	0	0.0	0	0	0	0.0	0	0	0	0.0
7:30-7:45	0	0	0	0.0	0	0	0	0.0	0	0	0	0.0
7:45-8:00	0	0	0	0.0	0	0	0	0.0	0	0	0	0.0
1時間計	0	1	1	4.2	1	0	1	3.2	1	1	2	3.6
8:00-8:15	0	0	0	0.0	1	0	1	3.2	1	0	1	1.8
8:15-8:30	0	0	0	0.0	0	1	1	3.2	0	1	1	1.8
8:30-8:45	0	0	0	0.0	0	1	1	3.2	0	1	1	1.8
8:45-9:00	0	0	0	0.0	0	0	0	0.0	0	0	0	0.0
1時間計	0	0	0	0.0	1	2	3	9.7	1	2	3	5.5
9:00-9:15	0	0	0	0.0	0	0	0	0.0	0	0	0	0.0
9:15-9:30	0	1	1	4.2	3	2	5	16.1	3	3	6	10.9
9:30-9:45	0	0	0	0.0	1	0	1	3.2	1	0	1	1.8
9:45-10:00	0	2	2	8.3	0	0	0	0.0	0	2	2	3.6
1時間計	0	3	3	12.5	4	2	6	19.4	4	5	9	16.4
10:00-10:15	0	0	0	0.0	0	0	0	0.0	0	0	0	0.0
10:15-10:30	0	0	0	0.0	0	0	0	0.0	0	0	0	0.0
10:30-10:45	0	0	0	0.0	0	0	0	0.0	0	0	0	0.0
10:45-11:00	0	0	0	0.0	1	0	1	3.2	1	0	1	1.8
1時間計	0	0	0	0.0	1	0	1	3.2	1	0	1	1.8
11:00-11:15	0	0	0	0.0	0	0	0	0.0	0	0	0	0.0
11:15-11:30	0	0	0	0.0	0	0	0	0.0	0	0	0	0.0
11:30-11:45	1	1	2	8.3	2	2	4	12.9	3	3	6	10.9
11:45-12:00	0	0	0	0.0	0	0	0	0.0	0	0	0	0.0
1時間計	1	1	2	8.3	2	2	4	12.9	3	3	6	10.9
12:00-12:15	2	0	2	8.3	2	0	2	6.5	4	0	4	7.3
12:15-12:30	2	0	2	8.3	2	1	3	9.7	4	1	5	9.1
12:30-12:45	2	0	2	8.3	2	0	2	6.5	4	0	4	7.3
12:45-13:00	0	0	0	0.0	0	0	0	0.0	0	0	0	0.0
1時間計	6	0	6	25.0	6	1	7	22.6	12	1	13	23.6
13:00-13:15	0	0	0	0.0	0	0	0	0.0	0	0	0	0.0
13:15-13:30	1	0	1	4.2	0	0	0	0.0	1	0	1	1.8
13:30-13:45	0	1	1	4.2	0	0	0	0.0	1	1	2	3.6
13:45-14:00	0	0	0	0.0	0	0	0	0.0	0	0	0	0.0
1時間計	1	1	2	8.3	0	0	0	0.0	1	1	2	3.6
14:00-14:15	0	0	0	0.0	0	0	0	0.0	0	0	0	0.0
14:15-14:30	0	0	0	0.0	0	0	0	0.0	0	0	0	0.0
14:30-14:45	0	0	0	0.0	0	0	0	0.0	0	0	0	0.0
14:45-15:00	0	0	0	0.0	0	0	0	0.0	0	0	0	0.0
1時間計	0	0	0	0.0	0	0	0	0.0	0	0	0	0.0

歩行者通行量調査表

調査地点：地域社会4 瀬谷土橋公園前

調査年月日：令和 2年 9月21日(月・祝) 天候：曇りのち晴れ



時間帯	ア				イ				合計			
	歩行者 (人)	自転車 (台)	合計 (人・台)	時間 係数 (%)	歩行者 (人)	自転車 (台)	合計 (人・台)	時間 係数 (%)	歩行者 (人)	自転車 (台)	合計 (人・台)	時間 係数 (%)
15:00-15:15	0	0	0	0.0	0	0	0	0.0	0	0	0	0.0
15:15-15:30	0	0	0	0.0	1	1	2	6.5	1	1	2	3.6
15:30-15:45	0	0	0	0.0	0	0	0	0.0	0	0	0	0.0
15:45-16:00	0	0	0	0.0	0	0	0	0.0	0	0	0	0.0
1時間計	0	0	0	0.0	1	1	2	6.5	1	1	2	3.6
16:00-16:15	0	0	0	0.0	0	0	0	0.0	0	0	0	0.0
16:15-16:30	0	1	1	4.2	0	0	0	0.0	0	1	1	1.8
16:30-16:45	0	0	0	0.0	0	0	0	0.0	0	0	0	0.0
16:45-17:00	0	0	0	0.0	0	1	1	3.2	0	1	1	1.8
1時間計	0	1	1	4.2	0	1	1	3.2	0	2	2	3.6
17:00-17:15	0	1	1	4.2	0	0	0	0.0	0	1	1	1.8
17:15-17:30	0	1	1	4.2	0	0	0	0.0	0	1	1	1.8
17:30-17:45	0	0	0	0.0	0	0	0	0.0	0	0	0	0.0
17:45-18:00	0	0	0	0.0	0	0	0	0.0	0	0	0	0.0
1時間計	0	2	2	8.3	0	0	0	0.0	0	2	2	3.6
18:00-18:15	0	0	0	0.0	0	1	1	3.2	0	1	1	1.8
18:15-18:30	0	0	0	0.0	0	0	0	0.0	0	0	0	0.0
18:30-18:45	1	1	2	8.3	0	1	1	3.2	1	2	3	5.5
18:45-19:00	0	0	0	0.0	0	0	0	0.0	0	0	0	0.0
1時間計	1	1	2	8.3	0	2	2	6.5	1	3	4	7.3
昼12時間計	9	10	19	79.2	16	11	27	87.1	25	21	46	83.6
19:00-19:15	0	0	0	0.0	0	0	0	0.0	0	0	0	0.0
19:15-19:30	0	0	0	0.0	0	0	0	0.0	0	0	0	0.0
19:30-19:45	0	0	0	0.0	0	0	0	0.0	0	0	0	0.0
19:45-20:00	0	0	0	0.0	0	0	0	0.0	0	0	0	0.0
1時間計	0	0	0	0.0	0	0	0	0.0	0	0	0	0.0
20:00-20:15	0	1	1	4.2	0	0	0	0.0	0	1	1	1.8
20:15-20:30	0	0	0	0.0	0	0	0	0.0	0	0	0	0.0
20:30-20:45	0	0	0	0.0	0	0	0	0.0	0	0	0	0.0
20:45-21:00	0	0	0	0.0	0	0	0	0.0	0	0	0	0.0
1時間計	0	1	1	4.2	0	0	0	0.0	0	1	1	1.8
21:00-21:15	0	0	0	0.0	0	0	0	0.0	0	0	0	0.0
21:15-21:30	0	0	0	0.0	0	0	0	0.0	0	0	0	0.0
21:30-21:45	0	0	0	0.0	0	0	0	0.0	0	0	0	0.0
21:45-22:00	0	0	0	0.0	0	0	0	0.0	0	0	0	0.0
1時間計	0	0	0	0.0	0	0	0	0.0	0	0	0	0.0
22:00-22:15	0	0	0	0.0	0	0	0	0.0	0	0	0	0.0
22:15-22:30	0	0	0	0.0	0	1	1	3.2	0	1	1	1.8
22:30-22:45	0	0	0	0.0	0	0	0	0.0	0	0	0	0.0
22:45-23:00	0	0	0	0.0	0	0	0	0.0	0	0	0	0.0
1時間計	0	0	0	0.0	0	1	1	3.2	0	1	1	1.8

歩行者通行量調査表

調査地点：地域社会4 瀬谷土橋公園前

調査年月日：令和 2年 9月21日(月・祝) 天候：曇りのち晴れ



方向	ア				イ				合計				
	種別	歩行者 (人)	自転車 (台)	合計 (人・台)	時間 係数 (%)	歩行者 (人)	自転車 (台)	合計 (人・台)	時間 係数 (%)	歩行者 (人)	自転車 (台)	合計 (人・台)	時間 係数 (%)
23:00-23:15		0	0	0	0.0	0	0	0	0.0	0	0	0	0.0
23:15-23:30		0	0	0	0.0	0	0	0	0.0	0	0	0	0.0
23:30-23:45		0	0	0	0.0	0	0	0	0.0	0	0	0	0.0
23:45-24:00		0	0	0	0.0	0	0	0	0.0	0	0	0	0.0
1時間計		0	0	0	0.0	0	0	0	0.0	0	0	0	0.0
0:00-0:15		0	0	0	0.0	0	0	0	0.0	0	0	0	0.0
0:15-0:30		0	0	0	0.0	0	0	0	0.0	0	0	0	0.0
0:30-0:45		1	0	1	4.2	0	0	0	0.0	1	0	1	1.8
0:45-1:00		0	0	0	0.0	1	0	1	3.2	1	0	1	1.8
1時間計		1	0	1	4.2	1	0	1	3.2	2	0	2	3.6
1:00-1:15		0	0	0	0.0	0	0	0	0.0	0	0	0	0.0
1:15-1:30		0	0	0	0.0	0	0	0	0.0	0	0	0	0.0
1:30-1:45		0	0	0	0.0	0	0	0	0.0	0	0	0	0.0
1:45-2:00		0	0	0	0.0	0	0	0	0.0	0	0	0	0.0
1時間計		0	0	0	0.0	0	0	0	0.0	0	0	0	0.0
2:00-2:15		0	0	0	0.0	1	0	1	3.2	1	0	1	1.8
2:15-2:30		0	0	0	0.0	0	0	0	0.0	0	0	0	0.0
2:30-2:45		0	0	0	0.0	0	0	0	0.0	0	0	0	0.0
2:45-3:00		0	0	0	0.0	0	0	0	0.0	0	0	0	0.0
1時間計		0	0	0	0.0	1	0	1	3.2	1	0	1	1.8
3:00-3:15		0	0	0	0.0	0	0	0	0.0	0	0	0	0.0
3:15-3:30		0	0	0	0.0	0	0	0	0.0	0	0	0	0.0
3:30-3:45		0	0	0	0.0	0	0	0	0.0	0	0	0	0.0
3:45-4:00		0	0	0	0.0	0	0	0	0.0	0	0	0	0.0
1時間計		0	0	0	0.0	0	0	0	0.0	0	0	0	0.0
4:00-4:15		0	0	0	0.0	0	0	0	0.0	0	0	0	0.0
4:15-4:30		0	0	0	0.0	0	0	0	0.0	0	0	0	0.0
4:30-4:45		0	0	0	0.0	0	0	0	0.0	0	0	0	0.0
4:45-5:00		0	0	0	0.0	0	1	1	3.2	0	1	1	1.8
1時間計		0	0	0	0.0	0	1	1	3.2	0	1	1	1.8
5:00-5:15		0	0	0	0.0	0	0	0	0.0	0	0	0	0.0
5:15-5:30		0	1	1	4.2	0	0	0	0.0	0	1	1	1.8
5:30-5:45		0	0	0	0.0	0	0	0	0.0	0	0	0	0.0
5:45-6:00		0	0	0	0.0	0	0	0	0.0	0	0	0	0.0
1時間計		0	1	1	4.2	0	0	0	0.0	0	1	1	1.8
6:00-6:15		1	0	1	4.2	0	0	0	0.0	1	0	1	1.8
6:15-6:30		0	0	0	0.0	0	0	0	0.0	0	0	0	0.0
6:30-6:45		0	0	0	0.0	0	0	0	0.0	0	0	0	0.0
6:45-7:00		1	0	1	4.2	0	0	0	0.0	1	0	1	1.8
1時間計		2	0	2	8.3	0	0	0	0.0	2	0	2	3.6
夜12時間計		3	2	5	20.8	2	2	4	12.9	5	4	9	16.4
全時間合計		12	12	24	100.0	18	13	31	100.0	30	25	55	100.0
昼夜率		1.33	1.20	1.25	-	1.13	1.18	1.15	-	1.20	1.19	1.20	-

歩行者通行量調査表

調査地点：地域社会4 瀬谷土橋公園前

調査年月日：令和 2年 9月21日(月・祝) 天候：曇りのち晴れ



時間帯	方向	ウ				I				合計			
		歩行者 (人)	自転車 (台)	合計 (人・台)	時間 係数 (%)	歩行者 (人)	自転車 (台)	合計 (人・台)	時間 係数 (%)	歩行者 (人)	自転車 (台)	合計 (人・台)	時間 係数 (%)
7:00-7:15		0	0	0	0.0	0	0	0	0.0	0	0	0	0.0
7:15-7:30		0	0	0	0.0	1	0	1	3.7	1	0	1	2.0
7:30-7:45		0	0	0	0.0	1	0	1	3.7	1	0	1	2.0
7:45-8:00		0	0	0	0.0	0	0	0	0.0	0	0	0	0.0
1時間計		0	0	0	0.0	2	0	2	7.4	2	0	2	4.0
8:00-8:15		0	0	0	0.0	0	0	0	0.0	0	0	0	0.0
8:15-8:30		0	0	0	0.0	0	0	0	0.0	0	0	0	0.0
8:30-8:45		0	0	0	0.0	0	3	3	11.1	0	3	3	6.0
8:45-9:00		0	0	0	0.0	0	0	0	0.0	0	0	0	0.0
1時間計		0	0	0	0.0	0	3	3	11.1	0	3	3	6.0
9:00-9:15		0	0	0	0.0	0	1	1	3.7	0	1	1	2.0
9:15-9:30		1	0	1	4.3	0	2	2	7.4	1	2	3	6.0
9:30-9:45		0	0	0	0.0	0	0	0	0.0	0	0	0	0.0
9:45-10:00		0	0	0	0.0	1	0	1	3.7	1	0	1	2.0
1時間計		1	0	1	4.3	1	3	4	14.8	2	3	5	10.0
10:00-10:15		0	0	0	0.0	0	0	0	0.0	0	0	0	0.0
10:15-10:30		0	0	0	0.0	0	1	1	3.7	0	1	1	2.0
10:30-10:45		0	0	0	0.0	0	0	0	0.0	0	0	0	0.0
10:45-11:00		0	1	1	4.3	1	0	1	3.7	1	1	2	4.0
1時間計		0	1	1	4.3	1	1	2	7.4	1	2	3	6.0
11:00-11:15		0	1	1	4.3	0	0	0	0.0	0	1	1	2.0
11:15-11:30		0	1	1	4.3	0	0	0	0.0	0	1	1	2.0
11:30-11:45		0	1	1	4.3	1	0	1	3.7	1	1	2	4.0
11:45-12:00		0	1	1	4.3	0	0	0	0.0	0	1	1	2.0
1時間計		0	4	4	17.4	1	0	1	3.7	1	4	5	10.0
12:00-12:15		0	0	0	0.0	2	2	4	14.8	2	2	4	8.0
12:15-12:30		0	0	0	0.0	1	2	3	11.1	1	2	3	6.0
12:30-12:45		0	0	0	0.0	3	0	3	11.1	3	0	3	6.0
12:45-13:00		0	0	0	0.0	0	0	0	0.0	0	0	0	0.0
1時間計		0	0	0	0.0	6	4	10	37.0	6	4	10	20.0
13:00-13:15		2	0	2	8.7	0	0	0	0.0	2	0	2	4.0
13:15-13:30		0	0	0	0.0	1	0	1	3.7	1	0	1	2.0
13:30-13:45		0	0	0	0.0	0	0	0	0.0	0	0	0	0.0
13:45-14:00		0	0	0	0.0	0	0	0	0.0	0	0	0	0.0
1時間計		2	0	2	8.7	1	0	1	3.7	3	0	3	6.0
14:00-14:15		0	0	0	0.0	2	0	2	7.4	2	0	2	4.0
14:15-14:30		0	0	0	0.0	0	0	0	0.0	0	0	0	0.0
14:30-14:45		0	0	0	0.0	0	0	0	0.0	0	0	0	0.0
14:45-15:00		2	0	2	8.7	0	0	0	0.0	2	0	2	4.0
1時間計		2	0	2	8.7	2	0	2	7.4	4	0	4	8.0

歩行者通行量調査表

調査地点：地域社会4 瀬谷土橋公園前

調査年月日：令和 2年 9月21日(月・祝) 天候：曇りのち晴れ



時間帯	ウ				エ				合計			
	歩行者 (人)	自転車 (台)	合計 (人・台)	時間 係数 (%)	歩行者 (人)	自転車 (台)	合計 (人・台)	時間 係数 (%)	歩行者 (人)	自転車 (台)	合計 (人・台)	時間 係数 (%)
15:00-15:15	0	0	0	0.0	0	0	0	0.0	0	0	0	0.0
15:15-15:30	0	0	0	0.0	0	0	0	0.0	0	0	0	0.0
15:30-15:45	0	0	0	0.0	0	0	0	0.0	0	0	0	0.0
15:45-16:00	0	0	0	0.0	0	0	0	0.0	0	0	0	0.0
1時間計	0	0	0	0.0	0	0	0	0.0	0	0	0	0.0
16:00-16:15	0	0	0	0.0	1	1	1	3.7	0	1	1	2.0
16:15-16:30	0	1	1	4.3	0	0	0	0.0	0	1	1	2.0
16:30-16:45	0	0	0	0.0	0	0	0	0.0	0	0	0	0.0
16:45-17:00	0	0	0	0.0	0	0	0	0.0	0	0	0	0.0
1時間計	0	1	1	4.3	0	1	1	3.7	0	2	2	4.0
17:00-17:15	0	1	1	4.3	0	0	0	0.0	0	1	1	2.0
17:15-17:30	0	0	0	0.0	0	0	0	0.0	0	0	0	0.0
17:30-17:45	0	0	0	0.0	0	0	0	0.0	0	0	0	0.0
17:45-18:00	0	0	0	0.0	0	0	0	0.0	0	0	0	0.0
1時間計	0	1	1	4.3	0	0	0	0.0	0	1	1	2.0
18:00-18:15	0	1	1	4.3	0	0	0	0.0	0	1	1	2.0
18:15-18:30	0	0	0	0.0	0	0	0	0.0	0	0	0	0.0
18:30-18:45	0	0	0	0.0	0	0	0	0.0	0	0	0	0.0
18:45-19:00	0	0	0	0.0	0	0	0	0.0	0	0	0	0.0
1時間計	0	1	1	4.3	0	0	0	0.0	0	1	1	2.0
昼12時間計	5	8	13	56.5	14	12	26	96.3	19	20	39	78.0
19:00-19:15	0	0	0	0.0	0	0	0	0.0	0	0	0	0.0
19:15-19:30	0	1	1	4.3	0	0	0	0.0	0	1	1	2.0
19:30-19:45	1	0	1	4.3	0	0	0	0.0	1	0	1	2.0
19:45-20:00	0	0	0	0.0	0	0	0	0.0	0	0	0	0.0
1時間計	1	1	2	8.7	0	0	0	0.0	1	1	2	4.0
20:00-20:15	0	0	0	0.0	0	0	0	0.0	0	0	0	0.0
20:15-20:30	0	0	0	0.0	0	0	0	0.0	0	0	0	0.0
20:30-20:45	0	0	0	0.0	0	0	0	0.0	0	0	0	0.0
20:45-21:00	0	0	0	0.0	0	0	0	0.0	0	0	0	0.0
1時間計	0	0	0	0.0	0	0	0	0.0	0	0	0	0.0
21:00-21:15	0	0	0	0.0	0	0	0	0.0	0	0	0	0.0
21:15-21:30	0	0	0	0.0	0	0	0	0.0	0	0	0	0.0
21:30-21:45	0	0	0	0.0	0	0	0	0.0	0	0	0	0.0
21:45-22:00	2	1	3	13.0	0	0	0	0.0	2	1	3	6.0
1時間計	2	1	3	13.0	0	0	0	0.0	2	1	3	6.0
22:00-22:15	0	0	0	0.0	0	0	0	0.0	0	0	0	0.0
22:15-22:30	0	0	0	0.0	0	0	0	0.0	0	0	0	0.0
22:30-22:45	0	0	0	0.0	0	0	0	0.0	0	0	0	0.0
22:45-23:00	0	1	1	4.3	0	0	0	0.0	0	1	1	2.0
1時間計	0	1	1	4.3	0	0	0	0.0	0	1	1	2.0

歩行者通行量調査表

調査地点：地域社会4 瀬谷土橋公園前

調査年月日：令和 2年 9月21日(月・祝) 天候：曇りのち晴れ



時間帯	ウ				エ				合計			
	歩行者 (人)	自転車 (台)	合計 (人・台)	時間 係数 (%)	歩行者 (人)	自転車 (台)	合計 (人・台)	時間 係数 (%)	歩行者 (人)	自転車 (台)	合計 (人・台)	時間 係数 (%)
23:00-23:15	0	1	1	4.3	0	0	0	0.0	0	1	1	2.0
23:15-23:30	0	0	0	0.0	0	0	0	0.0	0	0	0	0.0
23:30-23:45	0	0	0	0.0	0	0	0	0.0	0	0	0	0.0
23:45-24:00	0	0	0	0.0	0	0	0	0.0	0	0	0	0.0
1時間計	0	1	1	4.3	0	0	0	0.0	0	1	1	2.0
0:00-0:15	0	0	0	0.0	0	0	0	0.0	0	0	0	0.0
0:15-0:30	0	0	0	0.0	0	0	0	0.0	0	0	0	0.0
0:30-0:45	0	0	0	0.0	0	0	0	0.0	0	0	0	0.0
0:45-1:00	0	0	0	0.0	0	0	0	0.0	0	0	0	0.0
1時間計	0	0	0	0.0	0	0	0	0.0	0	0	0	0.0
1:00-1:15	0	0	0	0.0	0	0	0	0.0	0	0	0	0.0
1:15-1:30	0	0	0	0.0	0	0	0	0.0	0	0	0	0.0
1:30-1:45	0	0	0	0.0	0	0	0	0.0	0	0	0	0.0
1:45-2:00	0	0	0	0.0	0	0	0	0.0	0	0	0	0.0
1時間計	0	0	0	0.0	0	0	0	0.0	0	0	0	0.0
2:00-2:15	0	0	0	0.0	0	0	0	0.0	0	0	0	0.0
2:15-2:30	0	0	0	0.0	0	0	0	0.0	0	0	0	0.0
2:30-2:45	0	0	0	0.0	0	0	0	0.0	0	0	0	0.0
2:45-3:00	0	1	1	4.3	0	0	0	0.0	0	1	1	2.0
1時間計	0	1	1	4.3	0	0	0	0.0	0	1	1	2.0
3:00-3:15	0	0	0	0.0	0	0	0	0.0	0	0	0	0.0
3:15-3:30	0	0	0	0.0	0	0	0	0.0	0	0	0	0.0
3:30-3:45	0	0	0	0.0	0	0	0	0.0	0	0	0	0.0
3:45-4:00	0	1	1	4.3	0	0	0	0.0	0	1	1	2.0
1時間計	0	1	1	4.3	0	0	0	0.0	0	1	1	2.0
4:00-4:15	0	0	0	0.0	0	0	0	0.0	0	0	0	0.0
4:15-4:30	0	0	0	0.0	0	0	0	0.0	0	0	0	0.0
4:30-4:45	0	0	0	0.0	0	0	0	0.0	0	0	0	0.0
4:45-5:00	0	0	0	0.0	1	0	1	3.7	1	0	1	2.0
1時間計	0	0	0	0.0	1	0	1	3.7	1	0	1	2.0
5:00-5:15	0	1	1	4.3	0	0	0	0.0	0	1	1	2.0
5:15-5:30	0	0	0	0.0	0	0	0	0.0	0	0	0	0.0
5:30-5:45	0	0	0	0.0	0	0	0	0.0	0	0	0	0.0
5:45-6:00	0	0	0	0.0	0	0	0	0.0	0	0	0	0.0
1時間計	0	1	1	4.3	0	0	0	0.0	0	1	1	2.0
6:00-6:15	0	0	0	0.0	0	0	0	0.0	0	0	0	0.0
6:15-6:30	0	0	0	0.0	0	0	0	0.0	0	0	0	0.0
6:30-6:45	0	0	0	0.0	0	0	0	0.0	0	0	0	0.0
6:45-7:00	0	0	0	0.0	0	0	0	0.0	0	0	0	0.0
1時間計	0	0	0	0.0	0	0	0	0.0	0	0	0	0.0
夜12時間計	3	7	10	43.5	1	0	1	3.7	4	7	11	22.0
全時間合計	3	15	23	100.0	15	12	27	100.0	23	27	50	100.0
昼夜率	1.60	1.88	1.77	-	1.07	1.00	1.04	-	1.21	1.35	1.28	-

歩行者通行量調査表

調査地点：地域社会4 瀬谷土橋公園前

調査年月日：令和2年9月21日(月・祝) 天候：曇りのち晴れ



時間帯	方向 種別	合計 (7+イ+ウ+E)			時間 係数 (%)
		歩行者 (人)	自転車 (台)	合計 (人・台)	
7:00-7:15		1	1	2	1.9
7:15-7:30		1	0	1	1.0
7:30-7:45		1	0	1	1.0
7:45-8:00		0	0	0	0.0
1時間計		3	1	4	3.8
8:00-8:15		1	0	1	1.0
8:15-8:30		0	1	1	1.0
8:30-8:45		0	4	4	3.8
8:45-9:00		0	0	0	0.0
1時間計		1	5	6	5.7
9:00-9:15		0	1	1	1.0
9:15-9:30		4	5	9	8.6
9:30-9:45		1	0	1	1.0
9:45-10:00		1	2	3	2.9
1時間計		6	8	14	13.3
10:00-10:15		0	0	0	0.0
10:15-10:30		0	1	1	1.0
10:30-10:45		0	0	0	0.0
10:45-11:00		2	1	3	2.9
1時間計		2	2	4	3.8
11:00-11:15		0	1	1	1.0
11:15-11:30		0	1	1	1.0
11:30-11:45		4	4	8	7.6
11:45-12:00		0	1	1	1.0
1時間計		4	7	11	10.5
12:00-12:15		6	2	8	7.6
12:15-12:30		5	3	8	7.6
12:30-12:45		7	0	7	6.7
12:45-13:00		0	0	0	0.0
1時間計		18	5	23	21.9
13:00-13:15		2	0	2	1.9
13:15-13:30		2	0	2	1.9
13:30-13:45		0	1	1	1.0
13:45-14:00		0	0	0	0.0
1時間計		4	1	5	4.8
14:00-14:15		2	0	2	1.9
14:15-14:30		0	0	0	0.0
14:30-14:45		0	0	0	0.0
14:45-15:00		2	0	2	1.9
1時間計		4	0	4	3.8
15:00-15:15		0	0	0	0.0
15:15-15:30		1	1	2	1.9
15:30-15:45		0	0	0	0.0
15:45-16:00		0	0	0	0.0
1時間計		1	1	2	1.9
16:00-16:15		0	1	1	1.0
16:15-16:30		0	2	2	1.9
16:30-16:45		0	0	0	0.0
16:45-17:00		0	1	1	1.0
1時間計		0	4	4	3.8
17:00-17:15		0	2	2	1.9
17:15-17:30		0	1	1	1.0
17:30-17:45		0	0	0	0.0
17:45-18:00		0	0	0	0.0
1時間計		0	3	3	2.9
18:00-18:15		0	2	2	1.9
18:15-18:30		0	0	0	0.0
18:30-18:45		1	2	3	2.9
18:45-19:00		0	0	0	0.0
1時間計		1	4	5	4.8
昼12時間計		44	41	85	81.0

時間帯	方向 種別	合計 (7+イ+ウ+E)			時間 係数 (%)
		歩行者 (人)	自転車 (台)	合計 (人・台)	
7:00-8:00		3	1	4	3.8
7:15-8:15		3	0	3	2.9
7:30-8:30		2	1	3	2.9
7:45-8:45		1	5	6	5.7
8:00-9:00		1	5	6	5.7
8:15-9:15		0	6	6	5.7
8:30-9:30		4	10	14	13.3
8:45-9:45		5	6	11	10.5
9:00-10:00		6	8	14	13.3
9:15-10:15		6	7	13	12.4
9:30-10:30		2	3	5	4.8
9:45-10:45		1	3	4	3.8
10:00-11:00		2	2	4	3.8
10:15-11:15		2	3	5	4.8
10:30-11:30		2	3	5	4.8
10:45-11:45		6	7	13	12.4
11:00-12:00		4	7	11	10.5
11:15-12:15		10	8	18	17.1
11:30-12:30		19	10	29	27.6
11:45-12:45		23	6	29	27.6
12:00-13:00		18	5	23	21.9
12:15-13:15		14	3	17	16.2
12:30-13:30		11	0	11	10.5
12:45-13:45		4	1	5	4.8
13:00-14:00		4	1	5	4.8
13:15-14:15		4	1	5	4.8
13:30-14:30		2	1	3	2.9
13:45-14:45		2	0	2	1.9
14:00-15:00		4	0	4	3.8
14:15-15:15		2	0	2	1.9
14:30-15:30		3	1	4	3.8
14:45-15:45		3	2	5	4.8
15:00-16:00		1	1	2	1.9
15:15-16:15		1	2	3	2.9
15:30-16:30		0	3	3	2.9
15:45-16:45		0	3	3	2.9
16:00-17:00		0	4	4	3.8
16:15-17:15		0	5	5	4.8
16:30-17:30		0	4	4	3.8
16:45-17:45		0	4	4	3.8
17:00-18:00		0	3	3	2.9
17:15-18:15		0	3	3	2.9
17:30-18:30		0	2	2	1.9
17:45-18:45		1	4	5	4.8
18:00-19:00		1	4	5	4.8
18:15-19:15		1	2	3	2.9
18:30-19:30		1	3	4	3.8
18:45-19:45		1	1	2	1.9
19:00-20:00		1	1	2	1.9
19:15-20:15		1	2	3	2.9
19:30-20:30		1	1	2	1.9
19:45-20:45		0	1	1	1.0
20:00-21:00		0	1	1	1.0
20:15-21:15		0	0	0	0.0
20:30-21:30		0	0	0	0.0
20:45-21:45		0	0	0	0.0
21:00-22:00		2	1	3	2.9
21:15-22:15		2	1	3	2.9
21:30-22:30		2	2	4	3.8
21:45-22:45		2	2	4	3.8
22:00-23:00		0	2	2	1.9

歩行者通行量調査表

調査地点：地域社会4 瀬谷土橋公園前

調査年月日：令和 2年 9月21日(月・祝) 天候：曇りのち晴れ



時間帯	種別	合計 (7+イ+ウ+E)			時間係数 (%)
		歩行者 (人)	自転車 (台)	合計 (人・台)	
19:00-19:15		0	0	0	0.0
19:15-19:30		0	1	1	1.0
19:30-19:45		1	0	1	1.0
19:45-20:00		0	0	0	0.0
1時間計		1	1	2	1.9
20:00-20:15		0	1	1	1.0
20:15-20:30		0	0	0	0.0
20:30-20:45		0	0	0	0.0
20:45-21:00		0	0	0	0.0
1時間計		0	1	1	1.0
21:00-21:15		0	0	0	0.0
21:15-21:30		0	0	0	0.0
21:30-21:45		0	0	0	0.0
21:45-22:00		2	1	3	2.9
1時間計		2	1	3	2.9
22:00-22:15		0	0	0	0.0
22:15-22:30		0	1	1	1.0
22:30-22:45		0	0	0	0.0
22:45-23:00		0	1	1	1.0
1時間計		0	2	2	1.9
23:00-23:15		0	1	1	1.0
23:15-23:30		0	0	0	0.0
23:30-23:45		0	0	0	0.0
23:45-24:00		0	0	0	0.0
1時間計		0	1	1	1.0
0:00-0:15		0	0	0	0.0
0:15-0:30		0	0	0	0.0
0:30-0:45		1	0	1	1.0
0:45-1:00		1	0	1	1.0
1時間計		2	0	2	1.9
1:00-1:15		0	0	0	0.0
1:15-1:30		0	0	0	0.0
1:30-1:45		0	0	0	0.0
1:45-2:00		0	0	0	0.0
1時間計		0	0	0	0.0
2:00-2:15		1	0	1	1.0
2:15-2:30		0	0	0	0.0
2:30-2:45		0	0	0	0.0
2:45-3:00		0	1	1	1.0
1時間計		1	1	2	1.9
3:00-3:15		0	0	0	0.0
3:15-3:30		0	0	0	0.0
3:30-3:45		0	0	0	0.0
3:45-4:00		0	1	1	1.0
1時間計		0	1	1	1.0
4:00-4:15		0	0	0	0.0
4:15-4:30		0	0	0	0.0
4:30-4:45		0	0	0	0.0
4:45-5:00		1	1	2	1.9
1時間計		1	1	2	1.9
5:00-5:15		0	1	1	1.0
5:15-5:30		0	1	1	1.0
5:30-5:45		0	0	0	0.0
5:45-6:00		0	0	0	0.0
1時間計		0	2	2	1.9
6:00-6:15		1	0	1	1.0
6:15-6:30		0	0	0	0.0
6:30-6:45		0	0	0	0.0
6:45-7:00		1	0	1	1.0
1時間計		2	0	2	1.9
夜12時間計		9	11	20	19.0
全時間合計		53	52	105	100.0
昼夜率		1.20	1.27	1.24	-

時間帯	種別	合計 (7+イ+ウ+E)			時間係数 (%)
		歩行者 (人)	自転車 (台)	合計 (人・台)	
22:15-23:15		0	3	3	2.9
22:30-23:30		0	2	2	1.9
22:45-23:45		0	2	2	1.9
23:00-0:00		0	1	1	1.0
23:15-0:15		0	0	0	0.0
23:30-0:30		0	0	0	0.0
23:45-0:45		1	0	1	1.0
0:00-1:00		2	0	2	1.9
0:15-1:15		2	0	2	1.9
0:30-1:30		2	0	2	1.9
0:45-1:45		1	0	1	1.0
1:00-2:00		0	0	0	0.0
1:15-2:15		1	0	1	1.0
1:30-2:30		1	0	1	1.0
1:45-2:45		1	0	1	1.0
2:00-3:00		1	1	2	1.9
2:15-3:15		0	1	1	1.0
2:30-3:30		0	1	1	1.0
2:45-3:45		0	1	1	1.0
3:00-4:00		0	1	1	1.0
3:15-4:15		0	1	1	1.0
3:30-4:30		0	1	1	1.0
3:45-4:45		0	1	1	1.0
4:00-5:00		1	1	2	1.9
4:15-5:15		1	2	3	2.9
4:30-5:30		1	3	4	3.8
4:45-5:45		1	3	4	3.8
5:00-6:00		0	2	2	1.9
5:15-6:15		1	1	2	1.9
5:30-6:30		1	0	1	1.0
5:45-6:45		1	0	1	1.0
6:00-7:00		2	0	2	1.9
全時間合計		53	52	105	100.0

歩行者通行量調査表

調査地点：地域社会5

調査年月日：令和元年10月13日(日) 天候：曇りのち雨

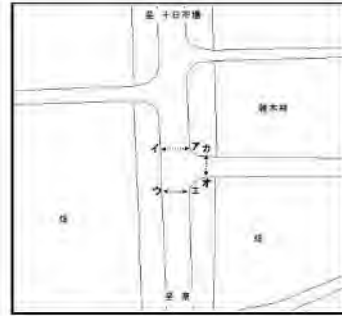

時間帯	ア				イ				合計			
	歩行者 (人)	自転車 (台)	合計 (人・台)	時間 係数 (%)	歩行者 (人)	自転車 (台)	合計 (人・台)	時間 係数 (%)	歩行者 (人)	自転車 (台)	合計 (人・台)	時間 係数 (%)
22:00-22:15	0	0	0	0.0	0	0	0	0.0	0	0	0	0.0
22:15-22:30	0	0	0	0.0	0	0	0	0.0	0	0	0	0.0
22:30-22:45	0	0	0	0.0	0	0	0	0.0	0	0	0	0.0
22:45-23:00	0	0	0	0.0	0	0	0	0.0	0	0	0	0.0
1時間計	0	0	0	0.0	0	0	0	0.0	0	0	0	0.0
23:00-23:15	0	0	0	0.0	0	0	0	0.0	0	0	0	0.0
23:15-23:30	0	0	0	0.0	0	0	0	0.0	0	0	0	0.0
23:30-23:45	0	0	0	0.0	0	0	0	0.0	0	0	0	0.0
23:45-24:00	0	0	0	0.0	0	0	0	0.0	0	0	0	0.0
1時間計	0	0	0	0.0	0	0	0	0.0	0	0	0	0.0
0:00-0:15	0	0	0	0.0	0	0	0	0.0	0	0	0	0.0
0:15-0:30	0	0	0	0.0	0	0	0	0.0	0	0	0	0.0
0:30-0:45	0	0	0	0.0	0	0	0	0.0	0	0	0	0.0
0:45-1:00	0	0	0	0.0	0	0	0	0.0	0	0	0	0.0
1時間計	0	0	0	0.0	0	0	0	0.0	0	0	0	0.0
1:00-1:15	0	0	0	0.0	0	0	0	0.0	0	0	0	0.0
1:15-1:30	0	0	0	0.0	0	0	0	0.0	0	0	0	0.0
1:30-1:45	0	0	0	0.0	0	0	0	0.0	0	0	0	0.0
1:45-2:00	0	0	0	0.0	0	0	0	0.0	0	0	0	0.0
1時間計	0	0	0	0.0	0	0	0	0.0	0	0	0	0.0
2:00-2:15	0	0	0	0.0	0	0	0	0.0	0	0	0	0.0
2:15-2:30	0	0	0	0.0	0	0	0	0.0	0	0	0	0.0
2:30-2:45	0	0	0	0.0	0	0	0	0.0	0	0	0	0.0
2:45-3:00	0	0	0	0.0	0	0	0	0.0	0	0	0	0.0
1時間計	0	0	0	0.0	0	0	0	0.0	0	0	0	0.0
3:00-3:15	0	0	0	0.0	0	0	0	0.0	0	0	0	0.0
3:15-3:30	0	0	0	0.0	0	0	0	0.0	0	0	0	0.0
3:30-3:45	0	0	0	0.0	0	0	0	0.0	0	0	0	0.0
3:45-4:00	0	0	0	0.0	0	0	0	0.0	0	0	0	0.0
1時間計	0	0	0	0.0	0	0	0	0.0	0	0	0	0.0
4:00-4:15	0	0	0	0.0	0	0	0	0.0	0	0	0	0.0
4:15-4:30	0	0	0	0.0	0	0	0	0.0	0	0	0	0.0
4:30-4:45	0	0	0	0.0	0	0	0	0.0	0	0	0	0.0
4:45-5:00	0	0	0	0.0	0	0	0	0.0	0	0	0	0.0
1時間計	0	0	0	0.0	0	0	0	0.0	0	0	0	0.0
5:00-5:15	0	0	0	0.0	0	0	0	0.0	0	0	0	0.0
5:15-5:30	0	0	0	0.0	0	0	0	0.0	0	0	0	0.0
5:30-5:45	0	0	0	0.0	0	0	0	0.0	0	0	0	0.0
5:45-6:00	0	0	0	0.0	0	0	0	0.0	0	0	0	0.0
1時間計	0	0	0	0.0	0	0	0	0.0	0	0	0	0.0

歩行者通行量調査表

調査地点：地域社会5

調査年月日：令和元年10月13日(日) 天候：曇りのち雨



時間帯	ア				イ				合計			
	歩行者 (人)	自転車 (台)	合計 (人・台)	時間 係数 (%)	歩行者 (人)	自転車 (台)	合計 (人・台)	時間 係数 (%)	歩行者 (人)	自転車 (台)	合計 (人・台)	時間 係数 (%)
6:00-6:15	0	0	0	0.0	0	0	0	0.0	0	0	0	0.0
6:15-6:30	0	0	0	0.0	0	0	0	0.0	0	0	0	0.0
6:30-6:45	0	0	0	0.0	0	0	0	0.0	0	0	0	0.0
6:45-7:00	0	0	0	0.0	0	0	0	0.0	0	0	0	0.0
1時間計	0	0	0	0.0	0	0	0	0.0	0	0	0	0.0
7:00-7:15	0	1	1	9.1	0	0	0	0.0	0	1	1	4.8
7:15-7:30	0	2	2	18.2	0	0	0	0.0	0	2	2	9.5
7:30-7:45	0	0	0	0.0	0	0	0	0.0	0	0	0	0.0
7:45-8:00	0	0	0	0.0	0	0	0	0.0	0	0	0	0.0
1時間計	0	3	3	27.3	0	0	0	0.0	0	3	3	14.3
8:00-8:15	0	0	0	0.0	1	0	1	10.0	1	0	1	4.8
8:15-8:30	0	0	0	0.0	0	0	0	0.0	0	0	0	0.0
8:30-8:45	0	0	0	0.0	0	0	0	0.0	0	0	0	0.0
8:45-9:00	0	0	0	0.0	0	0	0	0.0	0	0	0	0.0
1時間計	0	0	0	0.0	1	0	1	10.0	1	0	1	4.8
9:00-9:15	0	0	0	0.0	0	0	0	0.0	0	0	0	0.0
9:15-9:30	1	0	1	9.1	0	0	0	0.0	1	0	1	4.8
9:30-9:45	0	0	0	0.0	0	0	0	0.0	0	0	0	0.0
9:45-10:00	0	0	0	0.0	0	0	0	0.0	0	0	0	0.0
1時間計	1	0	1	9.1	0	0	0	0.0	1	0	1	4.8
10:00-10:15	1	0	1	9.1	0	0	0	0.0	1	0	1	4.8
10:15-10:30	1	0	1	9.1	1	0	1	10.0	2	0	2	9.5
10:30-10:45	0	0	0	0.0	0	0	0	0.0	0	0	0	0.0
10:45-11:00	0	0	0	0.0	1	0	1	10.0	1	0	1	4.8
1時間計	2	0	2	18.2	2	0	2	20.0	4	0	4	19.0
11:00-11:15	0	0	0	0.0	0	0	0	0.0	0	0	0	0.0
11:15-11:30	0	0	0	0.0	1	1	2	20.0	1	1	2	9.5
11:30-11:45	0	0	0	0.0	0	0	0	0.0	0	0	0	0.0
11:45-12:00	0	0	0	0.0	0	0	0	0.0	0	0	0	0.0
1時間計	0	0	0	0.0	1	1	2	20.0	1	1	2	9.5
12:00-12:15	1	0	1	9.1	0	0	0	0.0	1	0	1	4.8
12:15-12:30	0	0	0	0.0	0	0	0	0.0	0	0	0	0.0
12:30-12:45	0	0	0	0.0	0	1	1	10.0	0	1	1	4.8
12:45-13:00	0	0	0	0.0	0	0	0	0.0	0	0	0	0.0
1時間計	1	0	1	9.1	0	1	1	10.0	1	1	2	9.5
13:00-13:15	0	0	0	0.0	0	0	0	0.0	0	0	0	0.0
13:15-13:30	0	0	0	0.0	0	0	0	0.0	0	0	0	0.0
13:30-13:45	0	0	0	0.0	0	0	0	0.0	0	0	0	0.0
13:45-14:00	0	0	0	0.0	0	0	0	0.0	0	0	0	0.0
1時間計	0	0	0	0.0	0	0	0	0.0	0	0	0	0.0

歩行者通行量調査表

調査地点：地域社会5

調査年月日：令和元年10月13日(日) 天候：曇りのち雨

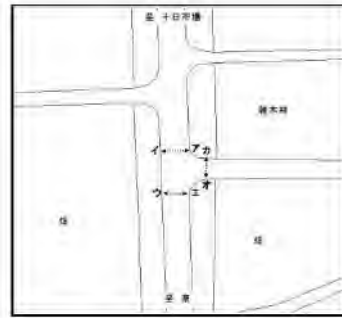

時間帯	ア				イ				合計			
	歩行者 (人)	自転車 (台)	合計 (人・台)	時間 係数 (%)	歩行者 (人)	自転車 (台)	合計 (人・台)	時間 係数 (%)	歩行者 (人)	自転車 (台)	合計 (人・台)	時間 係数 (%)
14:00-14:15	0	0	0	0.0	0	0	0	0.0	0	0	0	0.0
14:15-14:30	0	1	1	9.1	0	0	0	0.0	0	1	1	4.8
14:30-14:45	0	1	1	9.1	0	0	0	0.0	0	1	1	4.8
14:45-15:00	0	0	0	0.0	0	0	0	0.0	0	0	0	0.0
1時間計	0	2	2	18.2	0	0	0	0.0	0	2	2	9.5
15:00-15:15	0	0	0	0.0	0	0	0	0.0	0	0	0	0.0
15:15-15:30	0	0	0	0.0	0	0	0	0.0	0	0	0	0.0
15:30-15:45	0	0	0	0.0	0	0	0	0.0	0	0	0	0.0
15:45-16:00	0	0	0	0.0	0	0	0	0.0	0	0	0	0.0
1時間計	0	0	0	0.0	0	0	0	0.0	0	0	0	0.0
16:00-16:15	0	0	0	0.0	0	0	0	0.0	0	0	0	0.0
16:15-16:30	0	0	0	0.0	0	0	0	0.0	0	0	0	0.0
16:30-16:45	0	0	0	0.0	0	0	0	0.0	0	0	0	0.0
16:45-17:00	0	0	0	0.0	0	0	0	0.0	0	0	0	0.0
1時間計	0	0	0	0.0	0	0	0	0.0	0	0	0	0.0
17:00-17:15	0	0	0	0.0	0	0	0	0.0	0	0	0	0.0
17:15-17:30	0	0	0	0.0	0	0	0	0.0	0	0	0	0.0
17:30-17:45	0	0	0	0.0	0	0	0	0.0	0	0	0	0.0
17:45-18:00	0	2	2	18.2	0	0	0	0.0	0	2	2	9.5
1時間計	0	2	2	18.2	0	0	0	0.0	0	2	2	9.5
18:00-18:15	0	0	0	0.0	1	1	2	20.0	1	1	2	9.5
18:15-18:30	0	0	0	0.0	0	0	0	0.0	0	0	0	0.0
18:30-18:45	0	0	0	0.0	0	0	0	0.0	0	0	0	0.0
18:45-19:00	0	0	0	0.0	1	0	1	10.0	1	0	1	4.8
1時間計	0	0	0	0.0	2	1	3	30.0	2	1	3	14.3
19:00-19:15	0	0	0	0.0	0	0	0	0.0	0	0	0	0.0
19:15-19:30	0	0	0	0.0	0	1	1	10.0	0	1	1	4.8
19:30-19:45	0	0	0	0.0	0	0	0	0.0	0	0	0	0.0
19:45-20:00	0	0	0	0.0	0	0	0	0.0	0	0	0	0.0
1時間計	0	0	0	0.0	0	1	1	10.0	0	1	1	4.8
20:00-20:15	0	0	0	0.0	0	0	0	0.0	0	0	0	0.0
20:15-20:30	0	0	0	0.0	0	0	0	0.0	0	0	0	0.0
20:30-20:45	0	0	0	0.0	0	0	0	0.0	0	0	0	0.0
20:45-21:00	0	0	0	0.0	0	0	0	0.0	0	0	0	0.0
1時間計	0	0	0	0.0	0	0	0	0.0	0	0	0	0.0
21:00-21:15	0	0	0	0.0	0	0	0	0.0	0	0	0	0.0
21:15-21:30	0	0	0	0.0	0	0	0	0.0	0	0	0	0.0
21:30-21:45	0	0	0	0.0	0	0	0	0.0	0	0	0	0.0
21:45-22:00	0	0	0	0.0	0	0	0	0.0	0	0	0	0.0
1時間計	0	0	0	0.0	0	0	0	0.0	0	0	0	0.0
昼12時間計	4	7	11	100.0	6	3	9	90.0	10	10	20	95.2
夜12時間計	0	0	0	0.0	0	1	1	10.0	0	1	1	4.8
全時間合計	4	7	11	100.0	6	4	10	100.0	10	11	21	100.0
昼夜率	1.00	1.00	1.00	-	1.00	1.33	1.11	-	1.00	1.10	1.05	-

歩行者通行量調査表

調査地点：地域社会5

調査年月日：令和元年10月13日(日) 天候：曇りのち雨



時間帯	ウ				I				合計			
	歩行者 (人)	自転車 (台)	合計 (人・台)	時間 係数 (%)	歩行者 (人)	自転車 (台)	合計 (人・台)	時間 係数 (%)	歩行者 (人)	自転車 (台)	合計 (人・台)	時間 係数 (%)
22:00-22:15	0	0	0	0.0	0	0	0	0.0	0	0	0	0.0
22:15-22:30	0	0	0	0.0	0	1	1	4.3	0	1	1	1.7
22:30-22:45	0	0	0	0.0	0	1	1	4.3	0	1	1	1.7
22:45-23:00	0	0	0	0.0	0	0	0	0.0	0	0	0	0.0
1時間計	0	0	0	0.0	0	2	2	8.7	0	2	2	3.4
23:00-23:15	0	0	0	0.0	0	0	0	0.0	0	0	0	0.0
23:15-23:30	0	0	0	0.0	0	2	2	8.7	0	2	2	3.4
23:30-23:45	2	0	2	5.7	0	0	0	0.0	2	0	2	3.4
23:45-24:00	2	0	2	5.7	0	0	0	0.0	2	0	2	3.4
1時間計	4	0	4	11.4	0	2	2	8.7	4	2	6	10.3
0:00-0:15	0	0	0	0.0	0	0	0	0.0	0	0	0	0.0
0:15-0:30	0	0	0	0.0	0	0	0	0.0	0	0	0	0.0
0:30-0:45	0	0	0	0.0	0	0	0	0.0	0	0	0	0.0
0:45-1:00	0	0	0	0.0	0	0	0	0.0	0	0	0	0.0
1時間計	0	0	0	0.0	0	0	0	0.0	0	0	0	0.0
1:00-1:15	0	0	0	0.0	0	0	0	0.0	0	0	0	0.0
1:15-1:30	0	0	0	0.0	0	0	0	0.0	0	0	0	0.0
1:30-1:45	0	0	0	0.0	0	0	0	0.0	0	0	0	0.0
1:45-2:00	0	0	0	0.0	0	0	0	0.0	0	0	0	0.0
1時間計	0	0	0	0.0	0	0	0	0.0	0	0	0	0.0
2:00-2:15	0	0	0	0.0	0	0	0	0.0	0	0	0	0.0
2:15-2:30	0	0	0	0.0	0	0	0	0.0	0	0	0	0.0
2:30-2:45	0	0	0	0.0	0	0	0	0.0	0	0	0	0.0
2:45-3:00	0	0	0	0.0	0	0	0	0.0	0	0	0	0.0
1時間計	0	0	0	0.0	0	0	0	0.0	0	0	0	0.0
3:00-3:15	0	0	0	0.0	0	0	0	0.0	0	0	0	0.0
3:15-3:30	0	0	0	0.0	0	0	0	0.0	0	0	0	0.0
3:30-3:45	0	0	0	0.0	0	0	0	0.0	0	0	0	0.0
3:45-4:00	0	0	0	0.0	0	0	0	0.0	0	0	0	0.0
1時間計	0	0	0	0.0	0	0	0	0.0	0	0	0	0.0
4:00-4:15	0	0	0	0.0	0	0	0	0.0	0	0	0	0.0
4:15-4:30	0	0	0	0.0	0	0	0	0.0	0	0	0	0.0
4:30-4:45	0	1	1	2.9	0	0	0	0.0	0	1	1	1.7
4:45-5:00	0	0	0	0.0	0	1	1	4.3	0	1	1	1.7
1時間計	0	1	1	2.9	0	1	1	4.3	0	2	2	3.4
5:00-5:15	0	0	0	0.0	0	0	0	0.0	0	0	0	0.0
5:15-5:30	0	0	0	0.0	0	0	0	0.0	0	0	0	0.0
5:30-5:45	0	0	0	0.0	1	0	1	4.3	1	0	1	1.7
5:45-6:00	0	0	0	0.0	1	0	1	4.3	1	0	1	1.7
1時間計	0	0	0	0.0	2	0	2	8.7	2	0	2	3.4

歩行者通行量調査表

調査地点：地域社会5

調査年月日：令和元年10月13日(日) 天候：曇りのち雨

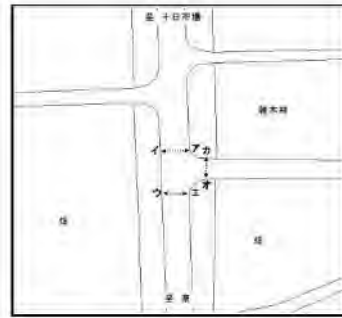

時間帯	ウ				エ				合計			
	歩行者 (人)	自転車 (台)	合計 (人・台)	時間係数 (%)	歩行者 (人)	自転車 (台)	合計 (人・台)	時間係数 (%)	歩行者 (人)	自転車 (台)	合計 (人・台)	時間係数 (%)
6:00-6:15	1	0	1	2.9	1	1	2	8.7	2	1	3	5.2
6:15-6:30	0	0	0	0.0	0	0	0	0.0	0	0	0	0.0
6:30-6:45	0	1	1	2.9	0	1	1	4.3	0	2	2	3.4
6:45-7:00	1	0	1	2.9	0	0	0	0.0	1	0	1	1.7
1時間計	2	1	3	8.6	1	2	3	13.0	3	3	6	10.3
7:00-7:15	0	0	0	0.0	0	0	0	0.0	0	0	0	0.0
7:15-7:30	1	1	2	5.7	0	1	1	4.3	1	2	3	5.2
7:30-7:45	0	0	0	0.0	0	1	1	4.3	0	1	1	1.7
7:45-8:00	0	0	0	0.0	0	0	0	0.0	0	0	0	0.0
1時間計	1	1	2	5.7	0	2	2	8.7	1	3	4	6.9
8:00-8:15	0	1	1	2.9	0	0	0	0.0	0	1	1	1.7
8:15-8:30	0	2	2	5.7	0	0	0	0.0	0	2	2	3.4
8:30-8:45	0	1	1	2.9	0	1	1	4.3	0	2	2	3.4
8:45-9:00	0	2	2	5.7	0	1	1	4.3	0	3	3	5.2
1時間計	0	6	6	17.1	0	2	2	8.7	0	8	8	13.8
9:00-9:15	0	0	0	0.0	0	0	0	0.0	0	0	0	0.0
9:15-9:30	0	1	1	2.9	2	0	2	8.7	2	1	3	5.2
9:30-9:45	0	0	0	0.0	0	0	0	0.0	0	0	0	0.0
9:45-10:00	0	1	1	2.9	0	0	0	0.0	0	1	1	1.7
1時間計	0	2	2	5.7	2	0	2	8.7	2	2	4	6.9
10:00-10:15	0	0	0	0.0	0	0	0	0.0	0	0	0	0.0
10:15-10:30	0	1	1	2.9	0	1	1	4.3	0	2	2	3.4
10:30-10:45	0	0	0	0.0	0	0	0	0.0	0	0	0	0.0
10:45-11:00	0	0	0	0.0	0	0	0	0.0	0	0	0	0.0
1時間計	0	1	1	2.9	0	1	1	4.3	0	2	2	3.4
11:00-11:15	0	1	1	2.9	0	0	0	0.0	0	1	1	1.7
11:15-11:30	0	0	0	0.0	0	0	0	0.0	0	0	0	0.0
11:30-11:45	0	0	0	0.0	0	2	2	8.7	0	2	2	3.4
11:45-12:00	0	0	0	0.0	0	0	0	0.0	0	0	0	0.0
1時間計	0	1	1	2.9	0	2	2	8.7	0	3	3	5.2
12:00-12:15	0	0	0	0.0	0	0	0	0.0	0	0	0	0.0
12:15-12:30	0	0	0	0.0	0	0	0	0.0	0	0	0	0.0
12:30-12:45	0	0	0	0.0	0	0	0	0.0	0	0	0	0.0
12:45-13:00	0	0	0	0.0	1	0	1	4.3	1	0	1	1.7
1時間計	0	0	0	0.0	1	0	1	4.3	1	0	1	1.7
13:00-13:15	0	0	0	0.0	0	0	0	0.0	0	0	0	0.0
13:15-13:30	0	0	0	0.0	0	0	0	0.0	0	0	0	0.0
13:30-13:45	0	0	0	0.0	0	0	0	0.0	0	0	0	0.0
13:45-14:00	0	0	0	0.0	0	0	0	0.0	0	0	0	0.0
1時間計	0	0	0	0.0	0	0	0	0.0	0	0	0	0.0

歩行者通行量調査表

調査地点：地域社会5

調査年月日：令和元年10月13日(日) 天候：曇りのち雨

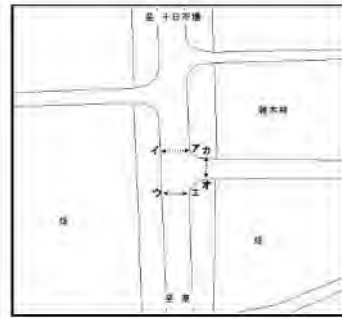

時間帯	ウ				I				合計			
	歩行者 (人)	自転車 (台)	合計 (人・台)	時間 係数 (%)	歩行者 (人)	自転車 (台)	合計 (人・台)	時間 係数 (%)	歩行者 (人)	自転車 (台)	合計 (人・台)	時間 係数 (%)
14:00-14:15	0	0	0	0.0	0	0	0	0.0	0	0	0	0.0
14:15-14:30	0	0	0	0.0	0	0	0	0.0	0	0	0	0.0
14:30-14:45	0	0	0	0.0	0	0	0	0.0	0	0	0	0.0
14:45-15:00	0	0	0	0.0	0	0	0	0.0	0	0	0	0.0
1時間計	0	0	0	0.0	0	0	0	0.0	0	0	0	0.0
15:00-15:15	0	0	0	0.0	0	0	0	0.0	0	0	0	0.0
15:15-15:30	0	0	0	0.0	0	0	0	0.0	0	0	0	0.0
15:30-15:45	0	0	0	0.0	0	0	0	0.0	0	0	0	0.0
15:45-16:00	0	0	0	0.0	0	0	0	0.0	0	0	0	0.0
1時間計	0	0	0	0.0	0	0	0	0.0	0	0	0	0.0
16:00-16:15	0	0	0	0.0	0	0	0	0.0	0	0	0	0.0
16:15-16:30	0	1	1	2.9	0	0	0	0.0	0	1	1	1.7
16:30-16:45	0	2	2	5.7	0	1	1	4.3	0	3	3	5.2
16:45-17:00	0	2	2	5.7	0	1	1	4.3	0	3	3	5.2
1時間計	0	5	5	14.3	0	2	2	8.7	0	7	7	12.1
17:00-17:15	0	0	0	0.0	0	0	0	0.0	0	0	0	0.0
17:15-17:30	0	0	0	0.0	0	0	0	0.0	0	0	0	0.0
17:30-17:45	0	0	0	0.0	0	0	0	0.0	0	0	0	0.0
17:45-18:00	0	0	0	0.0	0	0	0	0.0	0	0	0	0.0
1時間計	0	0	0	0.0	0	0	0	0.0	0	0	0	0.0
18:00-18:15	0	0	0	0.0	0	0	0	0.0	0	0	0	0.0
18:15-18:30	0	0	0	0.0	0	0	0	0.0	0	0	0	0.0
18:30-18:45	1	0	1	2.9	0	0	0	0.0	1	0	1	1.7
18:45-19:00	0	0	0	0.0	0	0	0	0.0	0	0	0	0.0
1時間計	1	0	1	2.9	0	0	0	0.0	1	0	1	1.7
19:00-19:15	1	1	2	5.7	0	1	1	4.3	1	2	3	5.2
19:15-19:30	0	1	1	2.9	0	0	0	0.0	0	1	1	1.7
19:30-19:45	0	0	0	0.0	0	0	0	0.0	0	0	0	0.0
19:45-20:00	0	0	0	0.0	0	0	0	0.0	0	0	0	0.0
1時間計	1	2	3	8.6	0	1	1	4.3	1	3	4	6.9
20:00-20:15	0	1	1	2.9	0	0	0	0.0	0	1	1	1.7
20:15-20:30	0	1	1	2.9	0	0	0	0.0	0	1	1	1.7
20:30-20:45	0	0	0	0.0	0	0	0	0.0	0	0	0	0.0
20:45-21:00	0	3	3	8.6	0	0	0	0.0	0	3	3	5.2
1時間計	0	5	5	14.3	0	0	0	0.0	0	5	5	8.6
21:00-21:15	0	0	0	0.0	0	0	0	0.0	0	0	0	0.0
21:15-21:30	1	0	1	2.9	0	0	0	0.0	1	0	1	1.7
21:30-21:45	0	0	0	0.0	0	0	0	0.0	0	0	0	0.0
21:45-22:00	0	0	0	0.0	0	0	0	0.0	0	0	0	0.0
1時間計	1	0	1	2.9	0	0	0	0.0	1	0	1	1.7
昼12時間計	2	16	18	51.4	3	9	12	52.2	5	25	30	51.7
夜12時間計	8	9	17	48.6	3	8	11	47.8	11	17	28	48.3
全時間合計	10	25	35	100.0	6	17	23	100.0	16	42	58	100.0
昼夜率	5.00	1.56	1.94	-	2.00	1.89	1.92	-	3.20	1.68	1.93	-

歩行者通行量調査表

調査地点：地域社会5

調査年月日：令和元年10月13日(日) 天候：曇りのち雨

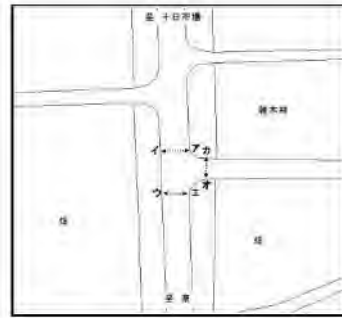

時間帯	あ				か				合計			
	歩行者 (人)	自転車 (台)	合計 (人・台)	時間 係数 (%)	歩行者 (人)	自転車 (台)	合計 (人・台)	時間 係数 (%)	歩行者 (人)	自転車 (台)	合計 (人・台)	時間 係数 (%)
22:00-22:15	0	3	3	1.8	0	0	0	0.0	0	3	3	1.1
22:15-22:30	1	1	2	1.2	0	1	1	1.0	1	2	3	1.1
22:30-22:45	1	2	3	1.8	0	1	1	1.0	1	3	4	1.5
22:45-23:00	1	1	2	1.2	0	0	0	0.0	1	1	2	0.7
1時間計	3	7	10	6.0	0	2	2	1.9	3	9	12	4.4
23:00-23:15	0	1	1	0.6	1	0	1	1.0	1	1	2	0.7
23:15-23:30	0	3	3	1.8	0	0	0	0.0	0	3	3	1.1
23:30-23:45	0	0	0	0.0	0	1	1	1.0	0	1	1	0.4
23:45-24:00	0	0	0	0.0	0	0	0	0.0	0	0	0	0.0
1時間計	0	4	4	2.4	1	1	2	1.9	1	5	6	2.2
0:00-0:15	0	2	2	1.2	1	3	4	3.8	1	5	6	2.2
0:15-0:30	1	1	2	1.2	0	2	2	1.9	1	3	4	1.5
0:30-0:45	1	1	2	1.2	0	0	0	0.0	1	1	2	0.7
0:45-1:00	0	0	0	0.0	0	0	0	0.0	0	0	0	0.0
1時間計	2	4	6	3.6	1	5	6	5.8	3	9	12	4.4
1:00-1:15	0	0	0	0.0	0	0	0	0.0	0	0	0	0.0
1:15-1:30	0	0	0	0.0	0	0	0	0.0	0	0	0	0.0
1:30-1:45	0	0	0	0.0	0	0	0	0.0	0	0	0	0.0
1:45-2:00	0	0	0	0.0	0	0	0	0.0	0	0	0	0.0
1時間計	0	0	0	0.0	0	0	0	0.0	0	0	0	0.0
2:00-2:15	0	0	0	0.0	0	0	0	0.0	0	0	0	0.0
2:15-2:30	0	0	0	0.0	0	0	0	0.0	0	0	0	0.0
2:30-2:45	0	0	0	0.0	0	0	0	0.0	0	0	0	0.0
2:45-3:00	0	0	0	0.0	0	0	0	0.0	0	0	0	0.0
1時間計	0	0	0	0.0	0	0	0	0.0	0	0	0	0.0
3:00-3:15	0	0	0	0.0	0	0	0	0.0	0	0	0	0.0
3:15-3:30	0	2	2	1.2	0	0	0	0.0	0	2	2	0.7
3:30-3:45	0	0	0	0.0	0	0	0	0.0	0	0	0	0.0
3:45-4:00	0	0	0	0.0	0	0	0	0.0	0	0	0	0.0
1時間計	0	2	2	1.2	0	0	0	0.0	0	2	2	0.7
4:00-4:15	0	0	0	0.0	0	0	0	0.0	0	0	0	0.0
4:15-4:30	0	0	0	0.0	2	0	2	1.9	2	0	2	0.7
4:30-4:45	2	0	2	1.2	2	0	2	1.9	4	0	4	1.5
4:45-5:00	2	1	3	1.8	4	0	4	3.8	6	1	7	2.6
1時間計	4	1	5	3.0	8	0	8	7.7	12	1	13	4.8
5:00-5:15	3	1	4	2.4	5	0	5	4.8	8	1	9	3.3
5:15-5:30	0	0	0	0.0	0	1	1	1.0	0	1	1	0.4
5:30-5:45	3	4	7	4.2	4	1	5	4.8	7	5	12	4.4
5:45-6:00	2	0	2	1.2	1	0	1	1.0	3	0	3	1.1
1時間計	8	5	13	7.8	10	2	12	11.5	18	7	25	9.3

歩行者通行量調査表

調査地点：地域社会5

調査年月日：令和元年10月13日(日) 天候：曇りのち雨

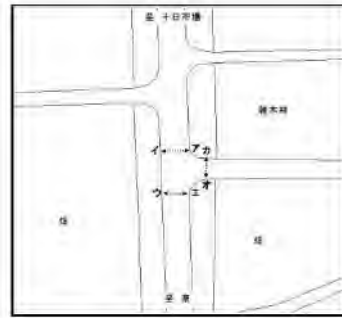

時間帯	方向				合計							
	歩行者 (人)	自転車 (台)	合計 (人・台)	時間 係数 (%)	歩行者 (人)	自転車 (台)	合計 (人・台)	時間 係数 (%)	歩行者 (人)	自転車 (台)	合計 (人・台)	時間 係数 (%)
6:00-6:15	0	1	1	0.6	3	1	4	3.8	3	2	5	1.9
6:15-6:30	1	3	4	2.4	1	1	2	1.9	2	4	6	2.2
6:30-6:45	6	3	9	5.4	0	2	2	1.9	6	5	11	4.1
6:45-7:00	7	2	9	5.4	2	2	4	3.8	9	4	13	4.8
1時間計	14	9	23	13.9	6	6	12	11.5	20	15	35	13.0
7:00-7:15	3	3	6	3.6	0	11	11	10.6	3	14	17	6.3
7:15-7:30	1	1	2	1.2	0	2	2	1.9	1	3	4	1.5
7:30-7:45	0	7	7	4.2	0	1	1	1.0	0	8	8	3.0
7:45-8:00	2	12	14	8.4	3	3	6	5.8	5	15	20	7.4
1時間計	6	23	29	17.5	3	17	20	19.2	9	40	49	18.1
8:00-8:15	0	0	0	0.0	0	0	0	0.0	0	0	0	0.0
8:15-8:30	0	0	0	0.0	1	6	7	6.7	1	6	7	2.6
8:30-8:45	0	1	1	0.6	0	0	0	0.0	0	1	1	0.4
8:45-9:00	0	1	1	0.6	0	0	0	0.0	0	1	1	0.4
1時間計	0	2	2	1.2	1	6	7	6.7	1	8	9	3.3
9:00-9:15	0	1	1	0.6	0	1	1	1.0	0	2	2	0.7
9:15-9:30	3	0	3	1.8	1	1	2	1.9	4	1	5	1.9
9:30-9:45	0	1	1	0.6	0	0	0	0.0	0	1	1	0.4
9:45-10:00	3	0	3	1.8	0	0	0	0.0	3	0	3	1.1
1時間計	6	2	8	4.8	1	2	3	2.9	7	4	11	4.1
10:00-10:15	0	0	0	0.0	0	0	0	0.0	0	0	0	0.0
10:15-10:30	0	0	0	0.0	0	1	1	1.0	0	1	1	0.4
10:30-10:45	0	0	0	0.0	0	1	1	1.0	0	1	1	0.4
10:45-11:00	0	0	0	0.0	0	0	0	0.0	0	0	0	0.0
1時間計	0	0	0	0.0	0	2	2	1.9	0	2	2	0.7
11:00-11:15	0	0	0	0.0	0	0	0	0.0	0	0	0	0.0
11:15-11:30	2	0	2	1.2	2	0	2	1.9	4	0	4	1.5
11:30-11:45	0	1	1	0.6	0	0	0	0.0	0	1	1	0.4
11:45-12:00	0	0	0	0.0	0	0	0	0.0	0	0	0	0.0
1時間計	2	1	3	1.8	2	0	2	1.9	4	1	5	1.9
12:00-12:15	0	1	1	0.6	0	0	0	0.0	0	1	1	0.4
12:15-12:30	0	1	1	0.6	0	2	2	1.9	0	3	3	1.1
12:30-12:45	0	0	0	0.0	0	2	2	1.9	0	2	2	0.7
12:45-13:00	1	0	1	0.6	1	2	3	2.9	2	2	4	1.5
1時間計	1	2	3	1.8	1	6	7	6.7	2	8	10	3.7
13:00-13:15	3	0	3	1.8	0	0	0	0.0	3	0	3	1.1
13:15-13:30	0	0	0	0.0	0	0	0	0.0	0	0	0	0.0
13:30-13:45	0	0	0	0.0	0	0	0	0.0	0	0	0	0.0
13:45-14:00	0	0	0	0.0	1	0	1	1.0	1	0	1	0.4
1時間計	3	0	3	1.8	1	0	1	1.0	4	0	4	1.5

歩行者通行量調査表

調査地点：地域社会5

調査年月日：令和元年10月13日(日) 天候：曇りのち雨

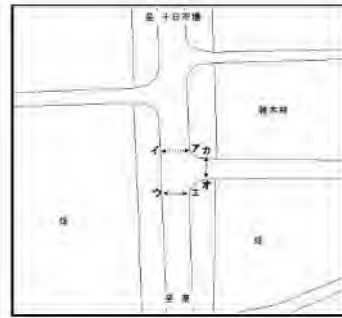

時間帯	方向				合計							
	歩行者 (人)	自転車 (台)	合計 (人・台)	時間 係数 (%)	歩行者 (人)	自転車 (台)	合計 (人・台)	時間 係数 (%)	歩行者 (人)	自転車 (台)	合計 (人・台)	時間 係数 (%)
14:00-14:15	0	0	0	0.0	0	0	0	0.0	0	0	0	0.0
14:15-14:30	0	1	1	0.6	0	0	0	0.0	0	1	1	0.4
14:30-14:45	0	2	2	1.2	1	0	1	1.0	1	2	3	1.1
14:45-15:00	1	0	1	0.6	0	0	0	0.0	1	0	1	0.4
1時間計	1	3	4	2.4	1	0	1	1.0	2	3	5	1.9
15:00-15:15	0	0	0	0.0	0	0	0	0.0	0	0	0	0.0
15:15-15:30	3	2	5	3.0	0	0	0	0.0	3	2	5	1.9
15:30-15:45	1	1	2	1.2	0	1	1	1.0	1	2	3	1.1
15:45-16:00	1	1	2	1.2	0	1	1	1.0	1	2	3	1.1
1時間計	5	4	9	5.4	0	2	2	1.9	5	6	11	4.1
16:00-16:15	0	0	0	0.0	0	0	0	0.0	0	0	0	0.0
16:15-16:30	0	2	2	1.2	0	0	0	0.0	0	2	2	0.7
16:30-16:45	0	0	0	0.0	0	0	0	0.0	0	0	0	0.0
16:45-17:00	0	2	2	1.2	0	0	0	0.0	0	2	2	0.7
1時間計	0	4	4	2.4	0	0	0	0.0	0	4	4	1.5
17:00-17:15	1	1	2	1.2	2	0	2	1.9	3	1	4	1.5
17:15-17:30	2	6	8	4.8	3	0	3	2.9	5	6	11	4.1
17:30-17:45	0	1	1	0.6	0	0	0	0.0	0	1	1	0.4
17:45-18:00	0	3	3	1.8	0	0	0	0.0	0	3	3	1.1
1時間計	3	11	14	8.4	5	0	5	4.8	8	11	19	7.0
18:00-18:15	1	0	1	0.6	0	7	7	6.7	1	7	8	3.0
18:15-18:30	0	0	0	0.0	0	0	0	0.0	0	0	0	0.0
18:30-18:45	0	2	2	1.2	0	0	0	0.0	0	2	2	0.7
18:45-19:00	1	3	4	2.4	1	2	3	2.9	2	5	7	2.6
1時間計	2	5	7	4.2	1	9	10	9.6	3	14	17	6.3
19:00-19:15	0	3	3	1.8	0	1	1	1.0	0	4	4	1.5
19:15-19:30	2	1	3	1.8	0	1	1	1.0	2	2	4	1.5
19:30-19:45	1	0	1	0.6	0	0	0	0.0	1	0	1	0.4
19:45-20:00	0	2	2	1.2	0	0	0	0.0	0	2	2	0.7
1時間計	3	6	9	5.4	0	2	2	1.9	3	8	11	4.1
20:00-20:15	0	0	0	0.0	0	0	0	0.0	0	0	0	0.0
20:15-20:30	0	1	1	0.6	0	0	0	0.0	0	1	1	0.4
20:30-20:45	0	0	0	0.0	0	0	0	0.0	0	0	0	0.0
20:45-21:00	0	2	2	1.2	0	0	0	0.0	0	2	2	0.7
1時間計	0	3	3	1.8	0	0	0	0.0	0	3	3	1.1
21:00-21:15	0	0	0	0.0	0	0	0	0.0	0	0	0	0.0
21:15-21:30	0	1	1	0.6	0	0	0	0.0	0	1	1	0.4
21:30-21:45	0	3	3	1.8	0	0	0	0.0	0	3	3	1.1
21:45-22:00	0	1	1	0.6	0	0	0	0.0	0	1	1	0.4
1時間計	0	5	5	3.0	0	0	0	0.0	0	5	5	1.9
昼12時間計	29	57	86	51.8	16	44	60	57.7	45	101	146	54.1
夜12時間計	34	46	80	48.2	26	18	44	42.3	60	64	124	45.9
全時間合計	63	103	166	100.0	42	62	104	100.0	105	165	270	100.0
昼夜率	2.17	1.81	1.93	-	2.63	1.41	1.73	-	2.33	1.63	1.85	-

歩行者通行量調査表

調査地点：地域社会5

調査年月日：令和元年10月13日(日) 天候：曇りのち雨



時間帯	種別	合計 (7+イ+ウ+エ+オ)			時間係数 (%)
		歩行者 (人)	自転車 (台)	合計 (人・台)	
22:00-22:15		0	3	3	0.9
22:15-22:30		1	3	4	1.1
22:30-22:45		1	4	5	1.4
22:45-23:00		1	1	2	0.6
1時間計		3	11	14	4.0
23:00-23:15		1	1	2	0.6
23:15-23:30		0	5	5	1.4
23:30-23:45		2	1	3	0.9
23:45-24:00		2	0	2	0.6
1時間計		5	7	12	3.4
0:00-0:15		1	5	6	1.7
0:15-0:30		1	3	4	1.1
0:30-0:45		1	1	2	0.6
0:45-1:00		0	0	0	0.0
1時間計		3	9	12	3.4
1:00-1:15		0	0	0	0.0
1:15-1:30		0	0	0	0.0
1:30-1:45		0	0	0	0.0
1:45-2:00		0	0	0	0.0
1時間計		0	0	0	0.0
2:00-2:15		0	0	0	0.0
2:15-2:30		0	0	0	0.0
2:30-2:45		0	0	0	0.0
2:45-3:00		0	0	0	0.0
1時間計		0	0	0	0.0
3:00-3:15		0	0	0	0.0
3:15-3:30		0	2	2	0.6
3:30-3:45		0	0	0	0.0
3:45-4:00		0	0	0	0.0
1時間計		0	2	2	0.6
4:00-4:15		0	0	0	0.0
4:15-4:30		2	0	2	0.6
4:30-4:45		4	1	5	1.4
4:45-5:00		6	2	8	2.3
1時間計		12	3	15	4.3
5:00-5:15		8	1	9	2.6
5:15-5:30		0	1	1	0.3
5:30-5:45		8	5	13	3.7
5:45-6:00		4	0	4	1.1
1時間計		20	7	27	7.7
6:00-6:15		5	3	8	2.3
6:15-6:30		2	4	6	1.7
6:30-6:45		6	7	13	3.7
6:45-7:00		10	4	14	4.0
1時間計		23	18	41	11.7
7:00-7:15		3	15	18	5.2
7:15-7:30		2	7	9	2.6
7:30-7:45		0	9	9	2.6
7:45-8:00		5	15	20	5.7
1時間計		10	46	56	16.0
8:00-8:15		1	1	2	0.6
8:15-8:30		1	8	9	2.6
8:30-8:45		0	3	3	0.9
8:45-9:00		0	4	4	1.1
1時間計		2	16	18	5.2
9:00-9:15		0	2	2	0.6
9:15-9:30		7	2	9	2.6
9:30-9:45		0	1	1	0.3
9:45-10:00		3	1	4	1.1
1時間計		10	6	16	4.6

時間帯	種別	合計 (7+イ+ウ+エ+オ)			時間係数 (%)
		歩行者 (人)	自転車 (台)	合計 (人・台)	
22:00-23:00		3	11	14	4.0
22:15-23:15		4	9	13	3.7
22:30-23:30		3	11	14	4.0
22:45-23:45		4	8	12	3.4
23:00-0:00		5	7	12	3.4
23:15-0:15		5	11	16	4.6
23:30-0:30		6	9	15	4.3
23:45-0:45		5	9	14	4.0
0:00-1:00		3	9	12	3.4
0:15-1:15		2	4	6	1.7
0:30-1:30		1	1	2	0.6
0:45-1:45		0	0	0	0.0
1:00-2:00		0	0	0	0.0
1:15-2:15		0	0	0	0.0
1:30-2:30		0	0	0	0.0
1:45-2:45		0	0	0	0.0
2:00-3:00		0	0	0	0.0
2:15-3:15		0	0	0	0.0
2:30-3:30		0	2	2	0.6
2:45-3:45		0	2	2	0.6
3:00-4:00		0	2	2	0.6
3:15-4:15		0	2	2	0.6
3:30-4:30		2	0	2	0.6
3:45-4:45		6	1	7	2.0
4:00-5:00		12	3	15	4.3
4:15-5:15		20	4	24	6.9
4:30-5:30		18	5	23	6.6
4:45-5:45		22	9	31	8.9
5:00-6:00		20	7	27	7.7
5:15-6:15		17	9	26	7.4
5:30-6:30		19	12	31	8.9
5:45-6:45		17	14	31	8.9
6:00-7:00		23	18	41	11.7
6:15-7:15		21	30	51	14.6
6:30-7:30		21	33	54	15.5
6:45-7:45		15	35	50	14.3
7:00-8:00		10	46	56	16.0
7:15-8:15		8	32	40	11.5
7:30-8:30		7	33	40	11.5
7:45-8:45		7	27	34	9.7
8:00-9:00		2	16	18	5.2
8:15-9:15		1	17	18	5.2
8:30-9:30		7	11	18	5.2
8:45-9:45		7	9	16	4.6
9:00-10:00		10	6	16	4.6
9:15-10:15		11	4	15	4.3
9:30-10:30		6	5	11	3.2
9:45-10:45		6	5	11	3.2
10:00-11:00		4	4	8	2.3
10:15-11:15		3	5	8	2.3
10:30-11:30		6	3	9	2.6
10:45-11:45		6	5	11	3.2
11:00-12:00		5	5	10	2.9
11:15-12:15		6	5	11	3.2
11:30-12:30		1	7	8	2.3
11:45-12:45		1	7	8	2.3
12:00-13:00		4	9	13	3.7
12:15-13:15		6	8	14	4.0
12:30-13:30		6	5	11	3.2
12:45-13:45		6	2	8	2.3

歩行者通行量調査表

調査地点：地域社会5

調査年月日：令和元年10月13日(日) 天候：曇りのち雨



時間帯	種別	合計 (7+イ+ウ+エ+オ)			時間係数 (%)
		歩行者 (人)	自転車 (台)	合計 (人・台)	
22:00-22:15		0	3	3	0.9
22:15-22:30		1	3	4	1.1
10:00-10:15		1	0	1	0.3
10:15-10:30		2	3	5	1.4
10:30-10:45		0	1	1	0.3
10:45-11:00		1	0	1	0.3
1時間計		4	4	8	2.3
11:00-11:15		0	1	1	0.3
11:15-11:30		5	1	6	1.7
11:30-11:45		0	3	3	0.9
11:45-12:00		0	0	0	0.0
1時間計		5	5	10	2.9
12:00-12:15		1	1	2	0.6
12:15-12:30		0	3	3	0.9
12:30-12:45		0	3	3	0.9
12:45-13:00		3	2	5	1.4
1時間計		4	9	13	3.7
13:00-13:15		3	0	3	0.9
13:15-13:30		0	0	0	0.0
13:30-13:45		0	0	0	0.0
13:45-14:00		1	0	1	0.3
1時間計		4	0	4	1.1
14:00-14:15		0	0	0	0.0
14:15-14:30		0	2	2	0.6
14:30-14:45		1	3	4	1.1
14:45-15:00		1	0	1	0.3
1時間計		2	5	7	2.0
15:00-15:15		0	0	0	0.0
15:15-15:30		3	2	5	1.4
15:30-15:45		1	2	3	0.9
15:45-16:00		1	2	3	0.9
1時間計		5	6	11	3.2
16:00-16:15		0	0	0	0.0
16:15-16:30		0	3	3	0.9
16:30-16:45		0	3	3	0.9
16:45-17:00		0	5	5	1.4
1時間計		0	11	11	3.2
17:00-17:15		3	1	4	1.1
17:15-17:30		5	6	11	3.2
17:30-17:45		0	1	1	0.3
17:45-18:00		0	5	5	1.4
1時間計		8	13	21	6.0
18:00-18:15		2	8	10	2.9
18:15-18:30		0	0	0	0.0
18:30-18:45		1	2	3	0.9
18:45-19:00		3	5	8	2.3
1時間計		6	15	21	6.0
19:00-19:15		1	6	7	2.0
19:15-19:30		2	4	6	1.7
19:30-19:45		1	0	1	0.3
19:45-20:00		0	2	2	0.6
1時間計		4	12	16	4.6
20:00-20:15		0	1	1	0.3
20:15-20:30		0	2	2	0.6
20:30-20:45		0	0	0	0.0
20:45-21:00		0	5	5	1.4
1時間計		0	8	8	2.3
21:00-21:15		0	0	0	0.0
21:15-21:30		1	1	2	0.6
21:30-21:45		0	3	3	0.9
21:45-22:00		0	1	1	0.3
1時間計		1	5	6	1.7
昼12時間計		60	136	196	56.2
夜12時間計		71	82	153	43.8
全時間合計		131	218	349	100.0
昼・夜率		2.18	1.60	1.78	-

時間帯	種別	合計 (7+イ+ウ+エ+オ)			時間係数 (%)
		歩行者 (人)	自転車 (台)	合計 (人・台)	
22:00-23:00		3	11	14	4.0
22:15-23:15		4	9	13	3.7
13:00-14:00		4	0	4	1.1
13:15-14:15		1	0	1	0.3
13:30-14:30		1	2	3	0.9
13:45-14:45		2	5	7	2.0
14:00-15:00		2	5	7	2.0
14:15-15:15		2	5	7	2.0
14:30-15:30		5	5	10	2.9
14:45-15:45		5	4	9	2.6
15:00-16:00		5	6	11	3.2
15:15-16:15		5	6	11	3.2
15:30-16:30		2	7	9	2.6
15:45-16:45		1	8	9	2.6
16:00-17:00		0	11	11	3.2
16:15-17:15		3	12	15	4.3
16:30-17:30		8	15	23	6.6
16:45-17:45		8	13	21	6.0
17:00-18:00		8	13	21	6.0
17:15-18:15		7	20	27	7.7
17:30-18:30		2	14	16	4.6
17:45-18:45		3	15	18	5.2
18:00-19:00		6	15	21	6.0
18:15-19:15		5	13	18	5.2
18:30-19:30		7	17	24	6.9
18:45-19:45		7	15	22	6.3
19:00-20:00		4	12	16	4.6
19:15-20:15		3	7	10	2.9
19:30-20:30		1	5	6	1.7
19:45-20:45		0	5	5	1.4
20:00-21:00		0	8	8	2.3
20:15-21:15		0	7	7	2.0
20:30-21:30		1	6	7	2.0
20:45-21:45		1	9	10	2.9
21:00-22:00		1	5	6	1.7
全時間合計		131	218	349	100.0

歩行者通行量調査表

調査地点：地域社会6 瀬谷中学校前

調査年月日：令和元年10月13日(日) 天候：曇りのち雨



方向	ア				イ				合計			
	歩行者 (人)	自転車 (台)	合計 (人・台)	時間 係数 (%)	歩行者 (人)	自転車 (台)	合計 (人・台)	時間 係数 (%)	歩行者 (人)	自転車 (台)	合計 (人・台)	時間 係数 (%)
22:00-22:15	6	0	6	1.3	10	1	11	1.5	16	1	17	1.4
22:15-22:30	3	1	4	0.9	16	1	17	2.3	19	2	21	1.7
22:30-22:45	3	1	4	0.9	6	6	12	1.6	9	7	16	1.3
22:45-23:00	3	0	3	0.7	9	3	12	1.6	12	3	15	1.2
1時間計	15	2	17	3.7	41	11	52	6.9	56	13	69	5.7
23:00-23:15	1	0	1	0.2	8	1	9	1.2	9	1	10	0.8
23:15-23:30	1	0	1	0.2	4	0	4	0.5	5	0	5	0.4
23:30-23:45	3	1	4	0.9	7	1	8	1.1	10	2	12	1.0
23:45-24:00	0	1	1	0.2	6	1	7	0.9	6	2	8	0.7
1時間計	5	2	7	1.5	25	3	28	3.7	30	5	35	2.9
0:00-0:15	1	0	1	0.2	12	0	12	1.6	13	0	13	1.1
0:15-0:30	0	0	0	0.0	2	0	2	0.3	2	0	2	0.2
0:30-0:45	0	0	0	0.0	1	0	1	0.1	1	0	1	0.1
0:45-1:00	0	0	0	0.0	3	1	4	0.5	3	1	4	0.3
1時間計	1	0	1	0.2	18	1	19	2.5	19	1	20	1.6
1:00-1:15	2	0	2	0.4	4	0	4	0.5	6	0	6	0.5
1:15-1:30	0	0	0	0.0	1	0	1	0.1	1	0	1	0.1
1:30-1:45	2	0	2	0.4	3	2	5	0.7	5	2	7	0.6
1:45-2:00	1	0	1	0.2	3	0	3	0.4	4	0	4	0.3
1時間計	5	0	5	1.1	11	2	13	1.7	16	2	18	1.5
2:00-2:15	0	0	0	0.0	2	0	2	0.3	2	0	2	0.2
2:15-2:30	6	0	6	1.3	0	0	0	0.0	6	0	6	0.5
2:30-2:45	0	0	0	0.0	3	0	3	0.4	3	0	3	0.2
2:45-3:00	0	0	0	0.0	0	0	0	0.0	0	0	0	0.0
1時間計	6	0	6	1.3	5	0	5	0.7	11	0	11	0.9
3:00-3:15	0	0	0	0.0	0	0	0	0.0	0	0	0	0.0
3:15-3:30	0	0	0	0.0	0	0	0	0.0	0	0	0	0.0
3:30-3:45	0	0	0	0.0	0	0	0	0.0	0	0	0	0.0
3:45-4:00	0	0	0	0.0	0	0	0	0.0	0	0	0	0.0
1時間計	0	0	0	0.0	0	0	0	0.0	0	0	0	0.0
4:00-4:15	0	0	0	0.0	1	0	1	0.1	1	0	1	0.1
4:15-4:30	2	0	2	0.4	0	0	0	0.0	2	0	2	0.2
4:30-4:45	0	1	1	0.2	0	0	0	0.0	0	1	1	0.1
4:45-5:00	0	0	0	0.0	0	0	0	0.0	0	0	0	0.0
1時間計	2	1	3	0.7	1	0	1	0.1	3	1	4	0.3
5:00-5:15	0	0	0	0.0	0	0	0	0.0	0	0	0	0.0
5:15-5:30	2	0	2	0.4	2	0	2	0.3	4	0	4	0.3
5:30-5:45	2	1	3	0.7	3	0	3	0.4	5	1	6	0.5
5:45-6:00	3	1	4	0.9	1	1	2	0.3	4	2	6	0.5
1時間計	7	2	9	2.0	6	1	7	0.9	13	3	16	1.3

歩行者通行量調査表

調査地点：地域社会6 瀬谷中学校前

調査年月日：令和元年10月13日(日) 天候：曇りのち雨



時間帯	ア				イ				合計			
	歩行者 (人)	自転車 (台)	合計 (人・台)	時間 係数 (%)	歩行者 (人)	自転車 (台)	合計 (人・台)	時間 係数 (%)	歩行者 (人)	自転車 (台)	合計 (人・台)	時間 係数 (%)
6:00-6:15	7	1	8	1.7	1	0	1	0.1	8	1	9	0.7
6:15-6:30	4	1	5	1.1	7	0	7	0.9	11	1	12	1.0
6:30-6:45	3	0	3	0.7	1	1	2	0.3	4	1	5	0.4
6:45-7:00	4	1	5	1.1	2	0	2	0.3	6	1	7	0.6
1時間計	18	3	21	4.6	11	1	12	1.6	29	4	33	2.7
7:00-7:15	5	1	6	1.3	2	0	2	0.3	7	1	8	0.7
7:15-7:30	4	0	4	0.9	5	0	5	0.7	9	0	9	0.7
7:30-7:45	9	1	10	2.2	15	2	17	2.3	24	3	27	2.2
7:45-8:00	9	0	9	2.0	4	0	4	0.5	13	0	13	1.1
1時間計	27	2	29	6.3	26	2	28	3.7	53	4	57	4.7
8:00-8:15	10	2	12	2.6	6	1	7	0.9	16	3	19	1.6
8:15-8:30	9	1	10	2.2	3	1	4	0.5	12	2	14	1.2
8:30-8:45	5	0	5	1.1	1	0	1	0.1	6	0	6	0.5
8:45-9:00	5	2	7	1.5	6	1	7	0.9	11	3	14	1.2
1時間計	29	5	34	7.4	16	3	19	2.5	45	8	53	4.4
9:00-9:15	16	1	17	3.7	7	0	7	0.9	23	1	24	2.0
9:15-9:30	4	1	5	1.1	4	0	4	0.5	8	1	9	0.7
9:30-9:45	13	3	16	3.5	8	0	8	1.1	21	3	24	2.0
9:45-10:00	8	0	8	1.7	9	0	9	1.2	17	0	17	1.4
1時間計	41	5	46	10.0	28	0	28	3.7	69	5	74	6.1
10:00-10:15	9	1	10	2.2	6	3	9	1.2	15	4	19	1.6
10:15-10:30	2	3	5	1.1	4	1	5	0.7	6	4	10	0.8
10:30-10:45	6	1	7	1.5	6	0	6	0.8	12	1	13	1.1
10:45-11:00	1	1	2	0.4	9	0	9	1.2	10	1	11	0.9
1時間計	18	6	24	5.2	25	4	29	3.8	43	10	53	4.4
11:00-11:15	10	1	11	2.4	8	0	8	1.1	18	1	19	1.6
11:15-11:30	13	1	14	3.1	5	1	6	0.8	18	2	20	1.6
11:30-11:45	9	1	10	2.2	10	1	11	1.5	19	2	21	1.7
11:45-12:00	18	1	19	4.1	9	2	11	1.5	27	3	30	2.5
1時間計	50	4	54	11.8	32	4	36	4.8	82	8	90	7.4
12:00-12:15	3	0	3	0.7	11	0	11	1.5	14	0	14	1.2
12:15-12:30	7	0	7	1.5	10	1	11	1.5	17	1	18	1.5
12:30-12:45	6	1	7	1.5	2	1	3	0.4	8	2	10	0.8
12:45-13:00	10	1	11	2.4	12	3	15	2.0	22	4	26	2.1
1時間計	26	2	28	6.1	35	5	40	5.3	61	7	68	5.6
13:00-13:15	0	0	0	0.0	12	0	12	1.6	12	0	12	1.0
13:15-13:30	6	1	7	1.5	6	1	7	0.9	12	2	14	1.2
13:30-13:45	7	0	7	1.5	3	1	4	0.5	10	1	11	0.9
13:45-14:00	5	3	8	1.7	17	0	17	2.3	22	3	25	2.1
1時間計	18	4	22	4.8	38	2	40	5.3	56	6	62	5.1

歩行者通行量調査表

調査地点：地域社会6 瀬谷中学校前

調査年月日：令和元年10月13日(日) 天候：曇りのち雨



時間帯	ア				イ				合計			
	歩行者 (人)	自転車 (台)	合計 (人・台)	時間 係数 (%)	歩行者 (人)	自転車 (台)	合計 (人・台)	時間 係数 (%)	歩行者 (人)	自転車 (台)	合計 (人・台)	時間 係数 (%)
14:00-14:15	14	0	14	3.1	20	2	22	2.9	34	2	36	3.0
14:15-14:30	6	1	7	1.5	17	1	18	2.4	23	2	25	2.1
14:30-14:45	2	0	2	0.4	7	2	9	1.2	9	2	11	0.9
14:45-15:00	6	0	6	1.3	8	0	8	1.1	14	0	14	1.2
1時間計	28	1	29	6.3	52	5	57	7.6	80	6	86	7.1
15:00-15:15	2	0	2	0.4	11	1	12	1.6	13	1	14	1.2
15:15-15:30	2	0	2	0.4	9	0	9	1.2	11	0	11	0.9
15:30-15:45	5	0	5	1.1	12	1	13	1.7	17	1	18	1.5
15:45-16:00	5	0	5	1.1	8	1	9	1.2	13	1	14	1.2
1時間計	14	0	14	3.1	40	3	43	5.7	54	3	57	4.7
16:00-16:15	5	3	8	1.7	2	1	3	0.4	7	4	11	0.9
16:15-16:30	10	0	10	2.2	8	1	9	1.2	18	1	19	1.6
16:30-16:45	12	5	17	3.7	14	0	14	1.9	26	5	31	2.6
16:45-17:00	5	2	7	1.5	29	4	33	4.4	34	6	40	3.3
1時間計	32	10	42	9.2	53	6	59	7.8	85	16	101	8.3
17:00-17:15	4	0	4	0.9	17	1	18	2.4	21	1	22	1.8
17:15-17:30	7	0	7	1.5	21	1	22	2.9	28	1	29	2.4
17:30-17:45	3	2	5	1.1	9	1	10	1.3	12	3	15	1.2
17:45-18:00	4	1	5	1.1	18	3	21	2.8	22	4	26	2.1
1時間計	18	3	21	4.6	65	6	71	9.4	83	9	92	7.6
18:00-18:15	2	0	2	0.4	9	2	11	1.5	11	2	13	1.1
18:15-18:30	5	1	6	1.3	18	2	20	2.7	23	3	26	2.1
18:30-18:45	6	0	6	1.3	22	0	22	2.9	28	0	28	2.3
18:45-19:00	7	0	7	1.5	8	2	10	1.3	15	2	17	1.4
1時間計	20	1	21	4.6	57	6	63	8.4	77	7	84	6.9
19:00-19:15	4	0	4	0.9	12	4	16	2.1	16	4	20	1.6
19:15-19:30	0	0	0	0.0	11	2	13	1.7	11	2	13	1.1
19:30-19:45	0	0	0	0.0	10	0	10	1.3	10	0	10	0.8
19:45-20:00	2	1	3	0.7	6	0	6	0.8	8	1	9	0.7
1時間計	6	1	7	1.5	39	6	45	6.0	45	7	52	4.3
20:00-20:15	2	0	2	0.4	10	0	10	1.3	12	0	12	1.0
20:15-20:30	4	0	4	0.9	3	0	3	0.4	7	0	7	0.6
20:30-20:45	2	2	4	0.9	4	1	5	0.7	6	3	9	0.7
20:45-21:00	0	0	0	0.0	7	0	7	0.9	7	0	7	0.6
1時間計	8	2	10	2.2	24	1	25	3.3	32	3	35	2.9
21:00-21:15	4	0	4	0.9	11	0	11	1.5	15	0	15	1.2
21:15-21:30	2	0	2	0.4	10	1	11	1.5	12	1	13	1.1
21:30-21:45	0	1	1	0.2	4	5	9	1.2	4	6	10	0.8
21:45-22:00	2	0	2	0.4	3	0	3	0.4	5	0	5	0.4
1時間計	8	1	9	2.0	28	6	34	4.5	36	7	43	3.5
昼12時間計	321	43	364	79.3	467	46	513	68.0	788	89	877	72.3
夜12時間計	81	14	95	20.7	209	32	241	32.0	290	46	336	27.7
全時間合計	402	57	459	100.0	676	78	754	100.0	1078	135	1213	100.0
昼夜率	1.25	1.33	1.26	-	1.45	1.70	1.47	-	1.37	1.52	1.38	-

歩行者通行量調査表

調査地点：地域社会6 瀬谷中学校前

調査年月日：令和元年10月13日(日) 天候：曇りのち雨



時間帯	ウ				イ				合計			
	歩行者 (人)	自転車 (台)	合計 (人・台)	時間 係数 (%)	歩行者 (人)	自転車 (台)	合計 (人・台)	時間 係数 (%)	歩行者 (人)	自転車 (台)	合計 (人・台)	時間 係数 (%)
22:00-22:15	5	0	5	1.4	2	0	2	0.5	7	0	7	1.0
22:15-22:30	2	2	4	1.1	1	0	1	0.3	3	2	5	0.7
22:30-22:45	0	2	2	0.6	3	1	4	1.1	3	3	6	0.8
22:45-23:00	3	2	5	1.4	0	0	0	0.0	3	2	5	0.7
1時間計	10	6	16	4.4	6	1	7	1.9	16	7	23	3.2
23:00-23:15	2	2	4	1.1	3	0	3	0.8	5	2	7	1.0
23:15-23:30	1	1	2	0.6	0	0	0	0.0	1	1	2	0.3
23:30-23:45	2	1	3	0.8	1	0	1	0.3	3	1	4	0.5
23:45-24:00	2	1	3	0.8	4	1	5	1.4	6	2	8	1.1
1時間計	7	5	12	3.3	8	1	9	2.4	15	6	21	2.9
0:00-0:15	2	2	4	1.1	1	0	1	0.3	3	2	5	0.7
0:15-0:30	1	0	1	0.3	0	0	0	0.0	1	0	1	0.1
0:30-0:45	0	1	1	0.3	0	0	0	0.0	0	1	1	0.1
0:45-1:00	0	1	1	0.3	1	0	1	0.3	1	1	2	0.3
1時間計	3	4	7	1.9	2	0	2	0.5	5	4	9	1.2
1:00-1:15	1	0	1	0.3	0	0	0	0.0	1	0	1	0.1
1:15-1:30	1	1	2	0.6	1	0	1	0.3	2	1	3	0.4
1:30-1:45	0	0	0	0.0	0	0	0	0.0	0	0	0	0.0
1:45-2:00	1	0	1	0.3	0	0	0	0.0	1	0	1	0.1
1時間計	3	1	4	1.1	1	0	1	0.3	4	1	5	0.7
2:00-2:15	0	0	0	0.0	1	0	1	0.3	1	0	1	0.1
2:15-2:30	0	0	0	0.0	3	1	4	1.1	3	1	4	0.5
2:30-2:45	1	1	2	0.6	0	0	0	0.0	1	1	2	0.3
2:45-3:00	0	0	0	0.0	0	0	0	0.0	0	0	0	0.0
1時間計	1	1	2	0.6	4	1	5	1.4	5	2	7	1.0
3:00-3:15	0	0	0	0.0	0	0	0	0.0	0	0	0	0.0
3:15-3:30	0	0	0	0.0	0	0	0	0.0	0	0	0	0.0
3:30-3:45	1	0	1	0.3	0	0	0	0.0	1	0	1	0.1
3:45-4:00	0	0	0	0.0	2	0	2	0.5	2	0	2	0.3
1時間計	1	0	1	0.3	2	0	2	0.5	3	0	3	0.4
4:00-4:15	0	1	1	0.3	1	0	1	0.3	1	1	2	0.3
4:15-4:30	0	0	0	0.0	0	0	0	0.0	0	0	0	0.0
4:30-4:45	0	0	0	0.0	1	0	1	0.3	1	0	1	0.1
4:45-5:00	0	0	0	0.0	1	0	1	0.3	1	0	1	0.1
1時間計	0	1	1	0.3	3	0	3	0.8	3	1	4	0.5
5:00-5:15	0	0	0	0.0	1	0	1	0.3	1	0	1	0.1
5:15-5:30	1	0	1	0.3	1	0	1	0.3	2	0	2	0.3
5:30-5:45	0	1	1	0.3	3	0	3	0.8	3	1	4	0.5
5:45-6:00	0	0	0	0.0	3	0	3	0.8	3	0	3	0.4
1時間計	1	1	2	0.6	8	0	8	2.2	9	1	10	1.4

歩行者通行量調査表

調査地点：地域社会6 瀬谷中学校前

調査年月日：令和元年10月13日(日) 天候：曇りのち雨



時間帯	ウ				エ				合計			
	歩行者 (人)	自転車 (台)	合計 (人・台)	時間 係数 (%)	歩行者 (人)	自転車 (台)	合計 (人・台)	時間 係数 (%)	歩行者 (人)	自転車 (台)	合計 (人・台)	時間 係数 (%)
6:00-6:15	0	1	1	0.3	2	1	3	0.8	2	2	4	0.5
6:15-6:30	2	0	2	0.6	3	1	4	1.1	5	1	6	0.8
6:30-6:45	0	2	2	0.6	2	4	2	1.1	2	4	6	0.8
6:45-7:00	0	1	1	0.3	2	0	2	0.5	2	1	3	0.4
1時間計	2	4	6	1.7	9	4	13	3.5	11	8	19	2.6
7:00-7:15	1	3	4	1.1	7	1	8	2.2	8	4	12	1.6
7:15-7:30	1	0	1	0.3	6	2	8	2.2	7	2	9	1.2
7:30-7:45	1	1	2	0.6	2	1	3	0.8	3	2	5	0.7
7:45-8:00	1	2	3	0.8	5	1	6	1.6	6	3	9	1.2
1時間計	4	6	10	2.8	20	5	25	6.8	24	11	35	4.8
8:00-8:15	1	3	4	1.1	5	0	5	1.4	6	3	9	1.2
8:15-8:30	3	2	5	1.4	4	2	6	1.6	7	4	11	1.5
8:30-8:45	6	4	10	2.8	6	2	8	2.2	12	6	18	2.5
8:45-9:00	0	2	2	0.6	3	4	7	1.9	3	6	9	1.2
1時間計	10	11	21	5.8	18	8	26	7.1	28	19	47	6.5
9:00-9:15	2	0	2	0.6	7	2	9	2.4	9	2	11	1.5
9:15-9:30	2	7	9	2.5	8	0	8	2.2	10	7	17	2.3
9:30-9:45	4	2	6	1.7	10	3	13	3.5	14	5	19	2.6
9:45-10:00	2	0	2	0.6	2	0	2	0.5	4	0	4	0.5
1時間計	10	9	19	5.3	27	5	32	8.7	37	14	51	7.0
10:00-10:15	3	1	4	1.1	10	4	14	3.8	13	5	18	2.5
10:15-10:30	3	2	5	1.4	9	3	12	3.3	12	5	17	2.3
10:30-10:45	2	0	2	0.6	4	2	6	1.6	6	2	8	1.1
10:45-11:00	0	0	0	0.0	2	0	2	0.5	2	0	2	0.3
1時間計	8	3	11	3.1	25	9	34	9.2	33	12	45	6.2
11:00-11:15	5	1	6	1.7	5	0	5	1.4	10	1	11	1.5
11:15-11:30	3	2	5	1.4	12	1	13	3.5	15	3	18	2.5
11:30-11:45	9	1	10	2.8	8	1	9	2.4	17	2	19	2.6
11:45-12:00	4	3	7	1.9	5	2	7	1.9	9	5	14	1.9
1時間計	21	7	28	7.8	30	4	34	9.2	51	11	62	8.5
12:00-12:15	1	2	3	0.8	1	2	3	0.8	2	4	6	0.8
12:15-12:30	3	3	6	1.7	6	3	9	2.4	9	6	15	2.1
12:30-12:45	4	4	8	2.2	6	1	7	1.9	10	5	15	2.1
12:45-13:00	2	0	2	0.6	9	1	10	2.7	11	1	12	1.6
1時間計	10	9	19	5.3	22	7	29	7.9	32	16	48	6.6
13:00-13:15	1	0	1	0.3	5	0	5	1.4	6	0	6	0.8
13:15-13:30	9	3	12	3.3	1	1	2	0.5	10	4	14	1.9
13:30-13:45	5	1	6	1.7	4	0	4	1.1	9	1	10	1.4
13:45-14:00	1	1	2	0.6	4	0	4	1.1	5	1	6	0.8
1時間計	16	5	21	5.8	14	1	15	4.1	30	6	36	4.9

歩行者通行量調査表

調査地点：地域社会6 瀬谷中学校前

調査年月日：令和元年10月13日(日) 天候：曇りのち雨



時間帯	ウ				I				合計			
	歩行者 (人)	自転車 (台)	合計 (人・台)	時間 係数 (%)	歩行者 (人)	自転車 (台)	合計 (人・台)	時間 係数 (%)	歩行者 (人)	自転車 (台)	合計 (人・台)	時間 係数 (%)
14:00-14:15	5	0	5	1.4	5	0	5	1.4	10	0	10	1.4
14:15-14:30	3	1	4	1.1	5	0	5	1.4	8	1	9	1.2
14:30-14:45	4	1	5	1.4	3	0	3	0.8	7	1	8	1.1
14:45-15:00	1	0	1	0.3	3	0	3	0.8	4	0	4	0.5
1時間計	13	2	15	4.2	16	0	16	4.3	29	2	31	4.3
15:00-15:15	2	1	3	0.8	4	0	4	1.1	6	1	7	1.0
15:15-15:30	2	0	2	0.6	8	3	11	3.0	10	3	13	1.8
15:30-15:45	2	4	6	1.7	3	2	5	1.4	5	6	11	1.5
15:45-16:00	6	0	6	1.7	0	1	1	0.3	6	1	7	1.0
1時間計	12	5	17	4.7	15	6	21	5.7	27	11	38	5.2
16:00-16:15	7	5	12	3.3	0	1	1	0.3	7	6	13	1.8
16:15-16:30	9	0	9	2.5	5	2	7	1.9	14	2	16	2.2
16:30-16:45	7	3	10	2.8	8	3	11	3.0	15	6	21	2.9
16:45-17:00	5	7	12	3.3	4	1	5	1.4	9	8	17	2.3
1時間計	28	15	43	11.9	17	7	24	6.5	45	22	67	9.2
17:00-17:15	6	2	8	2.2	9	1	10	2.7	15	3	18	2.5
17:15-17:30	11	2	13	3.6	8	3	11	3.0	19	5	24	3.3
17:30-17:45	2	2	4	1.1	3	2	5	1.4	5	4	9	1.2
17:45-18:00	4	2	6	1.7	2	1	3	0.8	6	3	9	1.2
1時間計	23	8	31	8.6	22	7	29	7.9	45	15	60	8.2
18:00-18:15	3	4	7	1.9	6	2	8	2.2	9	6	15	2.1
18:15-18:30	6	3	9	2.5	2	0	2	0.5	8	3	11	1.5
18:30-18:45	5	4	9	2.5	3	1	4	1.1	8	5	13	1.8
18:45-19:00	3	2	5	1.4	4	2	6	1.6	7	4	11	1.5
1時間計	17	13	30	8.3	15	5	20	5.4	32	18	50	6.9
19:00-19:15	3	0	3	0.8	2	1	3	0.8	5	1	6	0.8
19:15-19:30	7	1	8	2.2	1	2	3	0.8	8	3	11	1.5
19:30-19:45	2	2	4	1.1	0	0	0	0.0	2	2	4	0.5
19:45-20:00	8	1	9	2.5	0	0	0	0.0	8	1	9	1.2
1時間計	20	4	24	6.7	3	3	6	1.6	23	7	30	4.1
20:00-20:15	0	0	0	0.0	1	0	1	0.3	1	0	1	0.1
20:15-20:30	3	1	4	1.1	0	0	0	0.0	3	1	4	0.5
20:30-20:45	0	2	2	0.6	1	1	2	0.5	1	3	4	0.5
20:45-21:00	4	1	5	1.4	0	2	2	0.5	4	3	7	1.0
1時間計	7	4	11	3.1	2	3	5	1.4	9	7	16	2.2
21:00-21:15	2	0	2	0.6	2	0	2	0.5	4	0	4	0.5
21:15-21:30	2	0	2	0.6	0	0	0	0.0	2	0	2	0.3
21:30-21:45	1	1	2	0.6	0	0	0	0.0	1	1	2	0.3
21:45-22:00	2	1	3	0.8	0	0	0	0.0	2	1	3	0.4
1時間計	7	2	9	2.5	2	0	2	0.5	9	2	11	1.5
昼12時間計	172	93	265	73.6	241	64	305	82.9	413	157	570	78.3
夜12時間計	62	33	95	26.4	50	13	63	17.1	112	46	158	21.7
全時間合計	234	126	360	100.0	291	77	368	100.0	525	203	728	100.0
昼夜率	1.36	1.35	1.36	-	1.21	1.20	1.21	-	1.27	1.29	1.28	-

歩行者通行量調査表

調査地点：地域社会6 瀬谷中学校前

調査年月日：令和元年10月13日(日) 天候：曇りのち雨



時間帯	種別	ア				カ				合計			
		歩行者 (人)	自転車 (台)	合計 (人・台)	時間 係数 (%)	歩行者 (人)	自転車 (台)	合計 (人・台)	時間 係数 (%)	歩行者 (人)	自転車 (台)	合計 (人・台)	時間 係数 (%)
22:00-22:15		0	0	0	0.0	4	1	5	0.8	4	1	5	0.4
22:15-22:30		5	1	6	1.1	5	2	7	1.1	10	3	13	1.1
22:30-22:45		2	2	4	0.7	4	0	4	0.6	6	2	8	0.7
22:45-23:00		5	0	5	0.9	2	0	2	0.3	7	0	7	0.6
1時間計		12	3	15	2.7	15	3	18	2.8	27	6	33	2.7
23:00-23:15		2	0	2	0.4	7	0	7	1.1	9	0	9	0.7
23:15-23:30		5	0	5	0.9	2	0	2	0.3	7	0	7	0.6
23:30-23:45		3	0	3	0.5	0	0	0	0.0	3	0	3	0.2
23:45-24:00		2	1	3	0.5	1	0	1	0.2	3	1	4	0.3
1時間計		12	1	13	2.3	10	0	10	1.5	22	1	23	1.9
0:00-0:15		3	0	3	0.5	1	0	1	0.2	4	0	4	0.3
0:15-0:30		2	0	2	0.4	0	0	0	0.0	2	0	2	0.2
0:30-0:45		6	0	6	1.1	3	0	3	0.5	9	0	9	0.7
0:45-1:00		0	0	0	0.0	2	0	2	0.3	2	0	2	0.2
1時間計		11	0	11	2.0	6	0	6	0.9	17	0	17	1.4
1:00-1:15		1	1	2	0.4	1	0	1	0.2	2	1	3	0.2
1:15-1:30		0	0	0	0.0	0	0	0	0.0	0	0	0	0.0
1:30-1:45		0	1	1	0.2	0	0	0	0.0	0	1	1	0.1
1:45-2:00		0	0	0	0.0	0	0	0	0.0	0	0	0	0.0
1時間計		1	2	3	0.5	1	0	1	0.2	2	2	4	0.3
2:00-2:15		0	0	0	0.0	0	0	0	0.0	0	0	0	0.0
2:15-2:30		0	0	0	0.0	1	0	1	0.2	1	0	1	0.1
2:30-2:45		0	0	0	0.0	0	0	0	0.0	0	0	0	0.0
2:45-3:00		0	0	0	0.0	0	0	0	0.0	0	0	0	0.0
1時間計		0	0	0	0.0	1	0	1	0.2	1	0	1	0.1
3:00-3:15		0	0	0	0.0	0	0	0	0.0	0	0	0	0.0
3:15-3:30		0	0	0	0.0	0	0	0	0.0	0	0	0	0.0
3:30-3:45		0	0	0	0.0	0	0	0	0.0	0	0	0	0.0
3:45-4:00		0	0	0	0.0	0	0	0	0.0	0	0	0	0.0
1時間計		0	0	0	0.0	0	0	0	0.0	0	0	0	0.0
4:00-4:15		0	0	0	0.0	0	0	0	0.0	0	0	0	0.0
4:15-4:30		0	0	0	0.0	0	0	0	0.0	0	0	0	0.0
4:30-4:45		0	0	0	0.0	0	0	0	0.0	0	0	0	0.0
4:45-5:00		0	0	0	0.0	0	0	0	0.0	0	0	0	0.0
1時間計		0	0	0	0.0	0	0	0	0.0	0	0	0	0.0
5:00-5:15		0	0	0	0.0	2	1	3	0.5	2	1	3	0.2
5:15-5:30		0	0	0	0.0	1	0	1	0.2	1	0	1	0.1
5:30-5:45		0	0	0	0.0	4	0	4	0.6	4	0	4	0.3
5:45-6:00		0	0	0	0.0	1	1	2	0.3	1	1	2	0.2
1時間計		0	0	0	0.0	8	2	10	1.5	8	2	10	0.8

歩行者通行量調査表

調査地点：地域社会6 瀬谷中学校前

調査年月日：令和元年10月13日(日) 天候：曇りのち雨



時間帯	イ				カ				合計			
	歩行者 (人)	自転車 (台)	合計 (人・台)	時間 係数 (%)	歩行者 (人)	自転車 (台)	合計 (人・台)	時間 係数 (%)	歩行者 (人)	自転車 (台)	合計 (人・台)	時間 係数 (%)
6:00-6:15	2	1	3	0.5	4	1	5	0.8	6	2	8	0.7
6:15-6:30	0	0	0	0.0	8	1	9	1.4	8	1	9	0.7
6:30-6:45	2	0	2	0.4	6	0	6	0.9	8	0	8	0.7
6:45-7:00	1	0	1	0.2	7	0	7	1.1	8	0	8	0.7
1時間計	5	1	6	1.1	25	2	27	4.1	30	3	33	2.7
7:00-7:15	0	0	0	0.0	1	0	1	0.2	1	0	1	0.1
7:15-7:30	0	0	0	0.0	5	0	5	0.8	5	0	5	0.4
7:30-7:45	1	0	1	0.2	11	1	12	1.8	12	1	13	1.1
7:45-8:00	2	0	2	0.4	11	0	11	1.7	13	0	13	1.1
1時間計	3	0	3	0.5	28	1	29	4.4	31	1	32	2.6
8:00-8:15	5	0	5	0.9	17	1	18	2.8	22	1	23	1.9
8:15-8:30	4	0	4	0.7	4	2	6	0.9	8	2	10	0.8
8:30-8:45	4	0	4	0.7	13	2	15	2.3	17	2	19	1.6
8:45-9:00	4	2	6	1.1	20	3	23	3.5	24	5	29	2.4
1時間計	17	2	19	3.4	54	8	62	9.5	71	10	81	6.7
9:00-9:15	9	4	13	2.3	13	3	16	2.4	22	7	29	2.4
9:15-9:30	4	4	8	1.4	19	2	21	3.2	23	6	29	2.4
9:30-9:45	12	1	13	2.3	22	5	27	4.1	34	6	40	3.3
9:45-10:00	4	2	6	1.1	10	1	11	1.7	14	3	17	1.4
1時間計	29	11	40	7.2	64	11	75	11.5	93	22	115	9.5
10:00-10:15	7	4	11	2.0	18	0	18	2.8	25	4	29	2.4
10:15-10:30	9	1	10	1.8	18	1	19	2.9	27	2	29	2.4
10:30-10:45	3	0	3	0.5	13	1	14	2.1	16	1	17	1.4
10:45-11:00	1	0	1	0.2	2	0	2	0.3	3	0	3	0.2
1時間計	20	5	25	4.5	51	2	53	8.1	71	7	78	6.4
11:00-11:15	13	2	15	2.7	9	1	10	1.5	22	3	25	2.1
11:15-11:30	16	4	20	3.6	20	2	22	3.4	36	6	42	3.5
11:30-11:45	20	1	21	3.8	10	0	10	1.5	30	1	31	2.6
11:45-12:00	9	2	11	2.0	12	0	12	1.8	21	2	23	1.9
1時間計	58	9	67	12.0	51	3	54	8.3	109	12	121	10.0
12:00-12:15	22	0	22	3.9	7	1	8	1.2	29	1	30	2.5
12:15-12:30	5	2	7	1.3	11	1	12	1.8	16	3	19	1.6
12:30-12:45	16	1	17	3.0	25	1	26	4.0	41	2	43	3.5
12:45-13:00	7	1	8	1.4	15	1	16	2.4	22	2	24	2.0
1時間計	50	4	54	9.7	58	4	62	9.5	108	8	116	9.6
13:00-13:15	6	0	6	1.1	5	0	5	0.8	11	0	11	0.9
13:15-13:30	4	0	4	0.7	5	0	5	0.8	9	0	9	0.7
13:30-13:45	4	0	4	0.7	14	0	14	2.1	18	0	18	1.5
13:45-14:00	8	1	9	1.6	3	0	3	0.5	11	1	12	1.0
1時間計	22	1	23	4.1	27	0	27	4.1	49	1	50	4.1

歩行者通行量調査表

調査地点：地域社会6 瀬谷中学校前

調査年月日：令和元年10月13日(日) 天候：曇りのち雨



時間帯	方向	ま				か				合計			
		歩行者 (人)	自転車 (台)	合計 (人・台)	時間 係数 (%)	歩行者 (人)	自転車 (台)	合計 (人・台)	時間 係数 (%)	歩行者 (人)	自転車 (台)	合計 (人・台)	時間 係数 (%)
14:00-14:15		12	1	13	2.3	10	1	11	1.7	22	2	24	2.0
14:15-14:30		18	3	21	3.8	21	2	23	3.5	39	5	44	3.6
14:30-14:45		12	0	12	2.1	11	0	11	1.7	23	0	23	1.9
14:45-15:00		4	0	4	0.7	7	1	8	1.2	11	1	12	1.0
1時間計		46	4	50	8.9	49	4	53	8.1	95	8	103	8.5
15:00-15:15		5	0	5	0.9	9	0	9	1.4	14	0	14	1.2
15:15-15:30		6	1	7	1.3	9	3	12	1.8	15	4	19	1.6
15:30-15:45		8	1	9	1.6	10	3	13	2.0	18	4	22	1.8
15:45-16:00		1	1	2	0.4	5	2	7	1.1	6	3	9	0.7
1時間計		20	3	23	4.1	33	8	41	6.3	53	11	64	5.3
16:00-16:15		7	3	10	1.8	14	1	15	2.3	21	4	25	2.1
16:15-16:30		14	2	16	2.9	8	1	9	1.4	22	3	25	2.1
16:30-16:45		16	2	18	3.2	11	6	17	2.6	27	8	35	2.9
16:45-17:00		10	0	10	1.8	9	0	9	1.4	19	0	19	1.6
1時間計		47	7	54	9.7	42	8	50	7.6	89	15	104	8.6
17:00-17:15		11	2	13	2.3	4	3	7	1.1	15	5	20	1.6
17:15-17:30		9	2	11	2.0	9	1	10	1.5	18	3	21	1.7
17:30-17:45		16	2	18	3.2	5	2	7	1.1	21	4	25	2.1
17:45-18:00		8	0	8	1.4	2	2	4	0.6	10	2	12	1.0
1時間計		44	6	50	8.9	20	8	28	4.3	64	14	78	6.4
18:00-18:15		16	0	16	2.9	3	0	3	0.5	19	0	19	1.6
18:15-18:30		10	3	13	2.3	5	1	6	0.9	15	4	19	1.6
18:30-18:45		13	3	16	2.9	7	1	8	1.2	20	4	24	2.0
18:45-19:00		11	0	11	2.0	4	1	5	0.8	15	1	16	1.3
1時間計		50	6	56	10.0	19	3	22	3.4	69	9	78	6.4
19:00-19:15		1	0	1	0.2	2	0	2	0.3	3	0	3	0.2
19:15-19:30		0	1	1	0.2	1	0	1	0.2	1	1	2	0.2
19:30-19:45		1	0	1	0.2	2	0	2	0.3	3	0	3	0.2
19:45-20:00		9	0	9	1.6	2	0	2	0.3	11	0	11	0.9
1時間計		11	1	12	2.1	7	0	7	1.1	18	1	19	1.6
20:00-20:15		6	1	7	1.3	4	0	4	0.6	10	1	11	0.9
20:15-20:30		8	1	9	1.6	0	1	1	0.2	8	2	10	0.8
20:30-20:45		5	0	5	0.9	4	0	4	0.6	9	0	9	0.7
20:45-21:00		5	1	6	1.1	2	1	3	0.5	7	2	9	0.7
1時間計		24	3	27	4.8	10	2	12	1.8	34	5	39	3.2
21:00-21:15		1	0	1	0.2	1	0	1	0.2	2	0	2	0.2
21:15-21:30		5	0	5	0.9	1	0	1	0.2	6	0	6	0.5
21:30-21:45		1	0	1	0.2	3	0	3	0.5	4	0	4	0.3
21:45-22:00		1	0	1	0.2	1	0	1	0.2	2	0	2	0.2
1時間計		8	0	8	1.4	6	0	6	0.9	14	0	14	1.2
昼12時間計		406	58	464	83.0	496	60	556	85.0	902	118	1020	84.1
夜12時間計		84	11	95	17.0	89	9	98	15.0	173	20	193	15.9
全時間合計		490	69	559	100.0	585	69	654	100.0	1075	138	1213	100.0
昼夜率		1.21	1.19	1.20	-	1.18	1.15	1.18	-	1.19	1.17	1.19	-

歩行者通行量調査表

調査地点：地域社会6 瀬谷中学校前

調査年月日：令和元年10月13日(日) 天候：曇りのち雨



時間帯	種別	キ				ク				合計			
		歩行者 (人)	自転車 (台)	合計 (人・台)	時間 係数 (%)	歩行者 (人)	自転車 (台)	合計 (人・台)	時間 係数 (%)	歩行者 (人)	自転車 (台)	合計 (人・台)	時間 係数 (%)
22:00-22:15		3	0	3	0.5	4	2	6	1.6	7	2	9	0.9
22:15-22:30		1	3	4	0.7	4	0	4	1.1	5	3	8	0.8
22:30-22:45		3	0	3	0.5	1	0	1	0.3	4	0	4	0.4
22:45-23:00		7	0	7	1.2	2	0	2	0.5	9	0	9	0.9
1時間計		14	3	17	2.9	11	2	13	3.5	25	5	30	3.1
23:00-23:15		3	0	3	0.5	5	2	7	1.9	8	2	10	1.0
23:15-23:30		1	2	3	0.5	0	0	0	0.0	1	2	3	0.3
23:30-23:45		1	0	1	0.2	4	5	9	2.4	5	5	10	1.0
23:45-24:00		0	0	0	0.0	1	0	1	0.3	1	0	1	0.1
1時間計		5	2	7	1.2	10	7	17	4.5	15	9	24	2.5
0:00-0:15		0	0	0	0.0	1	2	3	0.8	1	2	3	0.3
0:15-0:30		0	0	0	0.0	1	0	1	0.3	1	0	1	0.1
0:30-0:45		2	0	2	0.3	0	0	0	0.0	2	0	2	0.2
0:45-1:00		1	0	1	0.2	0	0	0	0.0	1	0	1	0.1
1時間計		3	0	3	0.5	2	2	4	1.1	5	2	7	0.7
1:00-1:15		0	0	0	0.0	1	2	3	0.8	1	2	3	0.3
1:15-1:30		1	0	1	0.2	1	1	2	0.5	2	1	3	0.3
1:30-1:45		0	2	2	0.3	0	1	1	0.3	0	3	3	0.3
1:45-2:00		0	0	0	0.0	0	0	0	0.0	0	0	0	0.0
1時間計		1	2	3	0.5	2	4	6	1.6	3	6	9	0.9
2:00-2:15		0	0	0	0.0	0	0	0	0.0	0	0	0	0.0
2:15-2:30		0	2	2	0.3	0	0	0	0.0	0	2	2	0.2
2:30-2:45		1	0	1	0.2	0	0	0	0.0	1	0	1	0.1
2:45-3:00		0	0	0	0.0	0	0	0	0.0	0	0	0	0.0
1時間計		1	2	3	0.5	0	0	0	0.0	1	2	3	0.3
3:00-3:15		0	0	0	0.0	0	0	0	0.0	0	0	0	0.0
3:15-3:30		0	1	1	0.2	0	0	0	0.0	0	1	1	0.1
3:30-3:45		0	0	0	0.0	0	0	0	0.0	0	0	0	0.0
3:45-4:00		0	0	0	0.0	0	0	0	0.0	0	0	0	0.0
1時間計		0	1	1	0.2	0	0	0	0.0	0	1	1	0.1
4:00-4:15		0	0	0	0.0	0	0	0	0.0	0	0	0	0.0
4:15-4:30		0	0	0	0.0	0	0	0	0.0	0	0	0	0.0
4:30-4:45		0	0	0	0.0	0	0	0	0.0	0	0	0	0.0
4:45-5:00		1	0	1	0.2	0	0	0	0.0	1	0	1	0.1
1時間計		1	0	1	0.2	0	0	0	0.0	1	0	1	0.1
5:00-5:15		3	0	3	0.5	0	1	1	0.3	3	1	4	0.4
5:15-5:30		2	0	2	0.3	2	1	3	0.8	4	1	5	0.5
5:30-5:45		1	3	4	0.7	0	0	0	0.0	1	3	4	0.4
5:45-6:00		5	3	8	1.3	1	0	1	0.3	6	3	9	0.9
1時間計		11	6	17	2.9	3	2	5	1.3	14	8	22	2.3

歩行者通行量調査表

調査地点：地域社会6 瀬谷中学校前

調査年月日：令和元年10月13日(日) 天候：曇りのち雨



時間帯	方向	キ				ク				合計			
		歩行者 (人)	自転車 (台)	合計 (人・台)	時間 係数 (%)	歩行者 (人)	自転車 (台)	合計 (人・台)	時間 係数 (%)	歩行者 (人)	自転車 (台)	合計 (人・台)	時間 係数 (%)
6:00-6:15		3	1	4	0.7	0	0	0	0.0	3	1	4	0.4
6:15-6:30		1	0	1	0.2	0	1	1	0.3	1	1	2	0.2
6:30-6:45		3	1	4	0.7	0	1	1	0.3	3	2	5	0.5
6:45-7:00		4	2	6	1.0	0	0	0	0.0	4	2	6	0.6
1時間計		11	4	15	2.5	0	2	2	0.5	11	6	17	1.8
7:00-7:15		7	2	9	1.5	0	0	0	0.0	7	2	9	0.9
7:15-7:30		2	1	3	0.5	1	3	4	1.1	3	4	7	0.7
7:30-7:45		2	1	3	0.5	1	1	2	0.5	3	2	5	0.5
7:45-8:00		15	3	18	3.0	7	6	13	3.5	22	9	31	3.2
1時間計		26	7	33	5.5	9	10	19	5.1	35	17	52	5.4
8:00-8:15		7	2	9	1.5	4	3	7	1.9	11	5	16	1.7
8:15-8:30		9	0	9	1.5	0	7	7	1.9	9	7	16	1.7
8:30-8:45		9	14	23	3.9	8	0	8	2.1	17	14	31	3.2
8:45-9:00		13	4	17	2.9	4	2	6	1.6	17	6	23	2.4
1時間計		38	20	58	9.7	16	12	28	7.5	54	32	86	8.9
9:00-9:15		9	3	12	2.0	3	0	3	0.8	12	3	15	1.5
9:15-9:30		7	1	8	1.3	4	1	5	1.3	11	2	13	1.3
9:30-9:45		26	3	29	4.9	4	2	6	1.6	30	5	35	3.6
9:45-10:00		9	1	10	1.7	4	4	8	2.1	13	5	18	1.9
1時間計		51	8	59	9.9	15	7	22	5.9	66	15	81	8.4
10:00-10:15		2	0	2	0.3	3	2	5	1.3	5	2	7	0.7
10:15-10:30		10	0	10	1.7	0	0	0	0.0	10	0	10	1.0
10:30-10:45		10	4	14	2.4	3	0	3	0.8	13	4	17	1.8
10:45-11:00		10	2	12	2.0	5	3	8	2.1	15	5	20	2.1
1時間計		32	6	38	6.4	11	5	16	4.3	43	11	54	5.6
11:00-11:15		10	0	10	1.7	2	1	3	0.8	12	1	13	1.3
11:15-11:30		13	2	15	2.5	9	0	9	2.4	22	2	24	2.5
11:30-11:45		4	1	5	0.8	9	2	11	2.9	13	3	16	1.7
11:45-12:00		5	0	5	0.8	5	1	6	1.6	10	1	11	1.1
1時間計		32	3	35	5.9	25	4	29	7.8	57	7	64	6.6
12:00-12:15		9	0	9	1.5	4	1	5	1.3	13	1	14	1.4
12:15-12:30		13	5	18	3.0	7	5	12	3.2	20	10	30	3.1
12:30-12:45		10	0	10	1.7	4	1	5	1.3	14	1	15	1.5
12:45-13:00		3	0	3	0.5	7	2	9	2.4	10	2	12	1.2
1時間計		35	5	40	6.7	22	9	31	8.3	57	14	71	7.3
13:00-13:15		4	1	5	0.8	3	1	4	1.1	7	2	9	0.9
13:15-13:30		6	0	6	1.0	2	0	2	0.5	8	0	8	0.8
13:30-13:45		2	2	4	0.7	1	1	2	0.5	3	3	6	0.6
13:45-14:00		3	0	3	0.5	2	0	2	0.5	5	0	5	0.5
1時間計		15	3	18	3.0	8	2	10	2.7	23	5	28	2.9

歩行者通行量調査表

調査地点：地域社会6 瀬谷中学校前

調査年月日：令和元年10月13日(日) 天候：曇りのち雨



時間帯	方向	キ				ク				合計			
		歩行者 (人)	自転車 (台)	合計 (人・台)	時間 係数 (%)	歩行者 (人)	自転車 (台)	合計 (人・台)	時間 係数 (%)	歩行者 (人)	自転車 (台)	合計 (人・台)	時間 係数 (%)
14:00-14:15		10	3	13	2.2	13	0	13	3.5	23	3	26	2.7
14:15-14:30		10	3	13	2.2	4	1	5	1.3	14	4	18	1.9
14:30-14:45		10	0	10	1.7	4	0	4	1.1	14	0	14	1.4
14:45-15:00		6	0	6	1.0	5	1	6	1.6	11	1	12	1.2
1時間計		36	6	42	7.1	26	2	28	7.5	62	8	70	7.2
15:00-15:15		4	4	8	1.3	12	1	13	3.5	16	5	21	2.2
15:15-15:30		17	1	18	3.0	3	2	5	1.3	20	3	23	2.4
15:30-15:45		13	2	15	2.5	2	5	7	1.9	15	7	22	2.3
15:45-16:00		15	1	16	2.7	3	2	5	1.3	18	3	21	2.2
1時間計		49	8	57	9.6	20	10	30	8.0	69	18	87	9.0
16:00-16:15		2	2	4	0.7	3	0	3	0.8	5	2	7	0.7
16:15-16:30		11	1	12	2.0	3	5	8	2.1	14	6	20	2.1
16:30-16:45		8	15	23	3.9	8	2	10	2.7	16	17	33	3.4
16:45-17:00		2	2	4	0.7	5	2	7	1.9	7	4	11	1.1
1時間計		23	20	43	7.2	19	9	28	7.5	42	29	71	7.3
17:00-17:15		4	3	7	1.2	10	1	11	2.9	14	4	18	1.9
17:15-17:30		13	3	16	2.7	10	2	12	3.2	23	5	28	2.9
17:30-17:45		3	0	3	0.5	0	0	0	0.0	3	0	3	0.3
17:45-18:00		2	2	4	0.7	0	0	0	0.0	2	2	4	0.4
1時間計		22	8	30	5.0	20	3	23	6.1	42	11	53	5.5
18:00-18:15		2	0	2	0.3	0	0	0	0.0	2	0	2	0.2
18:15-18:30		1	0	1	0.2	2	1	3	0.8	3	1	4	0.4
18:30-18:45		10	3	13	2.2	8	1	9	2.4	18	4	22	2.3
18:45-19:00		20	3	23	3.9	13	6	19	5.1	33	9	42	4.3
1時間計		33	6	39	6.6	23	8	31	8.3	56	14	70	7.2
19:00-19:15		2	0	2	0.3	5	0	5	1.3	7	0	7	0.7
19:15-19:30		0	2	2	0.3	0	0	0	0.0	0	2	2	0.2
19:30-19:45		3	4	7	1.2	0	3	3	0.8	3	7	10	1.0
19:45-20:00		0	0	0	0.0	0	0	0	0.0	0	0	0	0.0
1時間計		5	6	11	1.8	5	3	8	2.1	10	9	19	2.0
20:00-20:15		0	0	0	0.0	1	0	1	0.3	1	0	1	0.1
20:15-20:30		6	3	9	1.5	2	0	2	0.5	8	3	11	1.1
20:30-20:45		1	1	2	0.3	1	0	1	0.3	2	1	3	0.3
20:45-21:00		2	2	4	0.7	2	0	2	0.5	4	2	6	0.6
1時間計		9	6	15	2.5	6	0	6	1.6	15	6	21	2.2
21:00-21:15		1	1	2	0.3	5	0	5	1.3	6	1	7	0.7
21:15-21:30		1	0	1	0.2	5	1	6	1.6	6	1	7	0.7
21:30-21:45		5	1	6	1.0	4	1	5	1.3	9	2	11	1.1
21:45-22:00		1	0	1	0.2	1	1	2	0.5	2	1	3	0.3
1時間計		8	2	10	1.7	15	3	18	4.8	23	5	28	2.9
昼12時間計		392	100	492	82.7	214	81	295	78.9	606	181	787	81.2
夜12時間計		69	34	103	17.3	54	25	79	21.1	123	59	182	18.8
全時間合計		461	134	595	100.0	268	106	374	100.0	729	240	969	100.0
昼夜率		1.18	1.34	1.21	-	1.25	1.31	1.27	-	1.20	1.33	1.23	-

歩行者通行量調査表

調査地点：地域社会6 瀬谷中学校前

調査年月日：令和元年10月13日(日) 天候：曇りのち雨



時間帯	方向	合計 (ア+イ+ウ+エ+オ+カ+キ+ク)			時間係数 (%)
		歩行者 (人)	自転車 (台)	合計 (人・台)	
22:00-22:15		34	4	38	0.9
22:15-22:30		37	10	47	1.1
22:30-22:45		22	12	34	0.8
22:45-23:00		31	5	36	0.9
1時間計		124	31	155	3.8
23:00-23:15		31	5	36	0.9
23:15-23:30		14	3	17	0.4
23:30-23:45		21	8	29	0.7
23:45-24:00		16	5	21	0.5
1時間計		82	21	103	2.5
0:00-0:15		21	4	25	0.6
0:15-0:30		6	0	6	0.1
0:30-0:45		12	1	13	0.3
0:45-1:00		7	2	9	0.2
1時間計		46	7	53	1.3
1:00-1:15		10	3	13	0.3
1:15-1:30		5	2	7	0.2
1:30-1:45		5	6	11	0.3
1:45-2:00		5	0	5	0.1
1時間計		25	11	36	0.9
2:00-2:15		3	0	3	0.1
2:15-2:30		10	3	13	0.3
2:30-2:45		5	1	6	0.1
2:45-3:00		0	0	0	0.0
1時間計		18	4	22	0.5
3:00-3:15		0	0	0	0.0
3:15-3:30		0	1	1	0.0
3:30-3:45		1	0	1	0.0
3:45-4:00		2	0	2	0.0
1時間計		3	1	4	0.1
4:00-4:15		2	1	3	0.1
4:15-4:30		2	0	2	0.0
4:30-4:45		1	1	2	0.0
4:45-5:00		2	0	2	0.0
1時間計		7	2	9	0.2
5:00-5:15		6	2	8	0.2
5:15-5:30		11	1	12	0.3
5:30-5:45		13	5	18	0.4
5:45-6:00		14	6	20	0.5
1時間計		44	14	58	1.4
6:00-6:15		19	6	25	0.6
6:15-6:30		25	4	29	0.7
6:30-6:45		17	7	24	0.6
6:45-7:00		20	4	24	0.6
1時間計		81	21	102	2.5
7:00-7:15		23	7	30	0.7
7:15-7:30		24	6	30	0.7
7:30-7:45		42	8	50	1.2
7:45-8:00		54	12	66	1.6
1時間計		143	33	176	4.3
8:00-8:15		55	12	67	1.6
8:15-8:30		36	15	51	1.2
8:30-8:45		52	22	74	1.8
8:45-9:00		55	20	75	1.8
1時間計		198	69	267	6.5
9:00-9:15		66	13	79	1.9
9:15-9:30		52	16	68	1.6
9:30-9:45		99	19	118	2.9
9:45-10:00		48	8	56	1.4
1時間計		265	56	321	7.8

時間帯	方向	合計 (ア+イ+ウ+エ+オ+カ+キ+ク)			時間係数 (%)
		歩行者 (人)	自転車 (台)	合計 (人・台)	
22:00-23:00		124	31	155	3.8
22:15-23:15		121	32	153	3.7
22:30-23:30		98	25	123	3.0
22:45-23:45		97	21	118	2.9
23:00-0:00		82	21	103	2.5
23:15-0:15		72	20	92	2.2
23:30-0:30		64	17	81	2.0
23:45-0:45		55	10	65	1.6
0:00-1:00		46	7	53	1.3
0:15-1:15		35	6	41	1.0
0:30-1:30		34	8	42	1.0
0:45-1:45		27	13	40	1.0
1:00-2:00		25	11	36	0.9
1:15-2:15		18	8	26	0.6
1:30-2:30		23	9	32	0.8
1:45-2:45		23	4	27	0.7
2:00-3:00		18	4	22	0.5
2:15-3:15		15	4	19	0.5
2:30-3:30		5	2	7	0.2
2:45-3:45		1	1	2	0.0
3:00-4:00		3	1	4	0.1
3:15-4:15		5	2	7	0.2
3:30-4:30		7	1	8	0.2
3:45-4:45		7	2	9	0.2
4:00-5:00		7	2	9	0.2
4:15-5:15		11	3	14	0.3
4:30-5:30		20	4	24	0.6
4:45-5:45		32	8	40	1.0
5:00-6:00		44	14	58	1.4
5:15-6:15		57	18	75	1.8
5:30-6:30		71	21	92	2.2
5:45-6:45		75	23	98	2.4
6:00-7:00		81	21	102	2.5
6:15-7:15		85	22	107	2.6
6:30-7:30		84	24	108	2.6
6:45-7:45		109	25	134	3.3
7:00-8:00		143	33	176	4.3
7:15-8:15		175	38	213	5.2
7:30-8:30		187	47	234	5.7
7:45-8:45		197	61	258	6.3
8:00-9:00		198	69	267	6.5
8:15-9:15		209	70	279	6.8
8:30-9:30		225	71	296	7.2
8:45-9:45		272	68	340	8.2
9:00-10:00		265	56	321	7.8
9:15-10:15		257	58	315	7.6
9:30-10:30		260	53	313	7.6
9:45-10:45		208	42	250	6.1
10:00-11:00		190	40	230	5.6
10:15-11:15		194	31	225	5.5
10:30-11:30		230	33	263	6.4
10:45-11:45		262	33	295	7.2
11:00-12:00		299	38	337	8.2
11:15-12:15		295	38	333	8.1
11:30-12:30		266	45	311	7.5
11:45-12:45		260	47	307	7.4
12:00-13:00		258	45	303	7.3
12:15-13:15		236	41	277	6.7
12:30-13:30		213	27	240	5.8
12:45-13:45		180	22	202	4.9

歩行者通行量調査表

調査地点：地域社会6 瀬谷中学校前

調査年月日：令和元年10月13日(日) 天候：曇りのち雨



時間帯	種別	合計 (フ+イ+ウ+エ+オ+カ+キ+ク)			時間係数 (%)
		歩行者 (人)	自転車 (台)	合計 (人・台)	
22:00-22:15		34	4	38	0.9
22:15-22:30		37	10	47	1.1
10:00-10:15		58	15	73	1.8
10:15-10:30		55	11	66	1.6
10:30-10:45		47	8	55	1.3
10:45-11:00		30	6	36	0.9
1時間計		190	40	230	5.6
11:00-11:15		62	6	68	1.6
11:15-11:30		91	13	104	2.5
11:30-11:45		79	8	87	2.1
11:45-12:00		67	11	78	1.9
1時間計		299	38	337	8.2
12:00-12:15		58	6	64	1.6
12:15-12:30		62	20	82	2.0
12:30-12:45		73	10	83	2.0
12:45-13:00		65	9	74	1.8
1時間計		258	45	303	7.3
13:00-13:15		36	2	38	0.9
13:15-13:30		39	6	45	1.1
13:30-13:45		40	5	45	1.1
13:45-14:00		43	5	48	1.2
1時間計		158	18	176	4.3
14:00-14:15		89	7	96	2.3
14:15-14:30		84	12	96	2.3
14:30-14:45		53	3	56	1.4
14:45-15:00		40	2	42	1.0
1時間計		266	24	290	7.0
15:00-15:15		49	7	56	1.4
15:15-15:30		56	10	66	1.6
15:30-15:45		55	18	73	1.8
15:45-16:00		43	8	51	1.2
1時間計		203	43	246	6.0
16:00-16:15		40	16	56	1.4
16:15-16:30		68	12	80	1.9
16:30-16:45		84	36	120	2.9
16:45-17:00		69	18	87	2.1
1時間計		261	82	343	8.3
17:00-17:15		65	13	78	1.9
17:15-17:30		88	14	102	2.5
17:30-17:45		41	11	52	1.3
17:45-18:00		40	11	51	1.2
1時間計		234	49	283	6.9
18:00-18:15		41	8	49	1.2
18:15-18:30		49	11	60	1.5
18:30-18:45		74	13	87	2.1
18:45-19:00		70	16	86	2.1
1時間計		234	48	282	6.8
19:00-19:15		31	5	36	0.9
19:15-19:30		20	8	28	0.7
19:30-19:45		18	9	27	0.7
19:45-20:00		27	2	29	0.7
1時間計		96	24	120	2.9
20:00-20:15		24	1	25	0.6
20:15-20:30		26	6	32	0.8
20:30-20:45		18	7	25	0.6
20:45-21:00		22	7	29	0.7
1時間計		90	21	111	2.7
21:00-21:15		27	1	28	0.7
21:15-21:30		26	2	28	0.7
21:30-21:45		18	9	27	0.7
21:45-22:00		11	2	13	0.3
1時間計		82	14	96	2.3
昼12時間計		2709	545	3254	78.9
夜12時間計		698	171	869	21.1
全時間合計		3407	716	4123	100.0
昼夜率		1.26	1.31	1.27	-

時間帯	種別	合計 (フ+イ+ウ+エ+オ+カ+キ+ク)			時間係数 (%)
		歩行者 (人)	自転車 (台)	合計 (人・台)	
22:00-23:00		124	31	155	3.8
22:15-23:15		121	32	153	3.7
13:00-14:00		158	18	176	4.3
13:15-14:15		211	23	234	5.7
13:30-14:30		256	29	285	6.9
13:45-14:45		269	27	296	7.2
14:00-15:00		266	24	290	7.0
14:15-15:15		226	24	250	6.1
14:30-15:30		198	22	220	5.3
14:45-15:45		200	37	237	5.7
15:00-16:00		203	43	246	6.0
15:15-16:15		194	52	246	6.0
15:30-16:30		206	54	260	6.3
15:45-16:45		235	72	307	7.4
16:00-17:00		261	82	343	8.3
16:15-17:15		286	79	365	8.9
16:30-17:30		306	81	387	9.4
16:45-17:45		263	56	319	7.7
17:00-18:00		234	49	283	6.9
17:15-18:15		210	44	254	6.2
17:30-18:30		171	41	212	5.1
17:45-18:45		204	43	247	6.0
18:00-19:00		234	48	282	6.8
18:15-19:15		224	45	269	6.5
18:30-19:30		195	42	237	5.7
18:45-19:45		139	38	177	4.3
19:00-20:00		96	24	120	2.9
19:15-20:15		89	20	109	2.6
19:30-20:30		95	18	113	2.7
19:45-20:45		95	16	111	2.7
20:00-21:00		90	21	111	2.7
20:15-21:15		93	21	114	2.8
20:30-21:30		93	17	110	2.7
20:45-21:45		93	19	112	2.7
21:00-22:00		82	14	96	2.3
全時間合計		3,407	716	4,123	100.0

9.17-3 渋滞長調査結果

対象事業実施区域周辺の主要交差点（7交差点）において、平日・休日・混雑時に実施した調査結果は、平日はP.資料 地域-847～860、休日はP.資料 地域-861～874、混雑時はP.資料 地域-875～888 に示すとおりです。

滞留長・渋滞長調査表

調査地点：地域社会1 目黒

調査年月日：令和元年 5月14日(火) 天候：雨のち曇り



1：車線減少	2：信号現示不遵	3：踏切	4：橋梁	5：右折、対向直進	6：左折車
7：大型車	8：二輪車	9：歩行者	10：駐車車両	11：バス停、バスレーン	12：工事、事故
13：沿道出入車両	14：道路線形	15：交差点形状	16：先詰まり	17：その他	

方向 観測時間	方向 a			方向 b			方向 c			方向 d		
	滞留長 (m)	渋滞長 (m)	渋滞 原因	滞留長 (m)	渋滞長 (m)	渋滞 原因	滞留長 (m)	渋滞長 (m)	渋滞 原因	滞留長 (m)	渋滞長 (m)	渋滞 原因
7:00-7:15	560	370	7	90	0		70	0		50	0	
7:15-7:30	510	340	7	70	0		60	0		30	0	
7:30-7:45	600	430	7	70	0		50	0		50	0	
7:45-8:00	680	450	7	80	0		50	0		60	0	
8:00-8:15	510	320	7	70	0		30	0		50	0	
8:15-8:30	470	300	7	100	10	7	30	0		120	30	2, 5, 13
8:30-8:45	340	250	7	70	0		70	0		60	0	
8:45-9:00	230	0		70	0		60	0		100	10	2
9:00-9:15	170	0		90	10	7	40	0		100	20	2, 5, 13
9:15-9:30	190	0		110	20	7	50	0		100	10	2
9:30-9:45	200	0		80	0		60	0		110	20	2
9:45-10:00	220	0		90	0		110	0		100	10	2
10:00-10:15	170	0		90	10	7	60	0		130	50	2, 5, 13
10:15-10:30	150	0		90	40	16	130	0		150	130	5, 13, 16
10:30-10:45	250	120	7	90	10	16	290	160	16	160	100	5, 13, 16
10:45-11:00	330	100	7	90	10	7	60	0		130	20	2, 5, 13
11:00-11:15	450	200	7	170	50	7	50	0		60	0	
11:15-11:30	580	350	7	100	20	16	220	0		60	0	
11:30-11:45	480	170	7	70	0		80	0		130	50	2, 13, 16
11:45-12:00	150	0		70	0		270	120	7, 16	50	0	
12:00-12:15	160	0		100	20	7	260	170	7, 16	140	110	2, 5, 13
12:15-12:30	180	0		140	40	7	130	20	7, 16	100	10	2
12:30-12:45	120	0		200	100	7	120	0		100	20	2, 5, 13
12:45-13:00	150	0		130	20	7	30	0		50	0	
13:00-13:15	80	0		150	80	7	30	0		50	0	
13:15-13:30	110	0		110	20	7	80	0		70	0	
13:30-13:45	110	0		100	20	7	50	0		60	0	
13:45-14:00	150	0		90	10	7	50	0		40	0	
14:00-14:15	150	0		110	30	7	100	0		100	20	2, 5, 13
14:15-14:30	220	0		110	20	7	60	0		110	20	2
14:30-14:45	120	0		70	0		60	0		110	20	2, 5
14:45-15:00	120	0		90	0		70	0		110	20	2, 13
15:00-15:15	140	0		90	20	7	70	0		130	40	2, 5, 13
15:15-15:30	130	0		90	0		100	0		120	20	2
15:30-15:45	150	0		70	0		50	0		40	20	16
15:45-16:00	130	0		50	0		60	0		60	0	
16:00-16:15	150	0		60	0		60	0		50	0	
16:15-16:30	250	20	13	70	0		60	0		100	10	2, 5
16:30-16:45	120	0		170	70	7	50	0		50	0	
16:45-17:00	120	0		110	40	7	70	0		100	10	2, 5
17:00-17:15	120	0		50	0		60	0		120	20	2
17:15-17:30	150	0		70	0		40	0		110	20	2, 5, 13
17:30-17:45	210	0		50	0		70	0		30	0	
17:45-18:00	160	0		120	40	7	60	0		100	10	2
18:00-18:15	100	0		70	0		70	0		100	10	2
18:15-18:30	80	0		60	0		60	0		110	50	2, 5, 13
18:30-18:45	120	0		80	0		90	0		120	30	2
18:45-19:00	150	0		50	0		40	0		110	20	2

滞留長・渋滞長調査表

調査地点：地域社会1 目黒

調査年月日：令和元年 5月14日(火) 天候：雨のち曇り



1：車線減少	2：信号現示不遵	3：踏切	4：橋梁	5：右折、対向直進	6：左折車
7：大型車	8：二輪車	9：歩行者	10：駐車車両	11：バス停、バスレーン	12：工事、事故
13：沿道出入車両	14：道路線形	15：交差点形状	16：先詰まり	17：その他	

観測時間	方向 a			方向 b			方向 c			方向 d		
	滞留長 (m)	渋滞長 (m)	渋滞 原因	滞留長 (m)	渋滞長 (m)	渋滞 原因	滞留長 (m)	渋滞長 (m)	渋滞 原因	滞留長 (m)	渋滞長 (m)	渋滞 原因
19:00-19:15	130	0		50	0		80	0		100	30	2, 5, 13
19:15-19:30	70	0		40	0		40	0		100	30	2, 5, 13
19:30-19:45	80	0		60	0		40	0		50	0	
19:45-20:00	110	0		40	0		10	0		100	10	2
20:00-20:15	100	0		60	0		30	0		40	0	
20:15-20:30	70	0		80	0		20	0		30	0	
20:30-20:45	80	0		0	0		60	0		100	10	2, 7
20:45-21:00	50	0		40	0		50	0		100	10	2, 5
21:00-21:15	60	0		50	0		20	0		60	0	
21:15-21:30	50	0		50	0		30	0		100	10	2
21:30-21:45	40	0		30	0		20	0		20	0	
21:45-22:00	50	0		50	0		10	0		10	0	
22:00-22:15	40	0		50	0		30	0		30	0	
22:15-22:30	30	0		30	0		50	0		20	0	
22:30-22:45	30	0		40	0		40	0		20	0	
22:45-23:00	30	0		50	0		20	0		20	0	
23:00-23:15	30	0		50	0		30	0		30	0	
23:15-23:30	20	0		20	0		40	0		20	0	
23:30-23:45	30	0		40	0		30	0		10	0	
23:45-24:00	20	0		30	0		20	0		30	0	
0:00-0:15	20	0		40	0		20	0		10	0	
0:15-0:30	30	0		20	0		20	0		10	0	
0:30-0:45	40	0		30	0		20	0		20	0	
0:45-1:00	20	0		20	0		20	0		20	0	
1:00-1:15	30	0		50	10	7	40	0		10	0	
1:15-1:30	20	0		50	0		20	0		10	0	
1:30-1:45	20	0		20	0		30	0		10	0	
1:45-2:00	10	0		20	0		20	0		10	0	
2:00-2:15	10	0		30	0		10	0		30	0	
2:15-2:30	20	0		40	20	7	40	0		20	0	
2:30-2:45	30	0		70	30	7	20	0		20	0	
2:45-3:00	30	0		20	0		10	0		30	0	
3:00-3:15	20	0		40	0		10	0		30	0	
3:15-3:30	40	0		30	0		30	0		20	0	
3:30-3:45	20	0		50	0		20	0		10	0	
3:45-4:00	20	0		50	0		20	0		20	0	
4:00-4:15	20	0		50	0		30	0		30	0	
4:15-4:30	30	0		30	0		30	0		20	0	
4:30-4:45	20	0		50	0		30	0		20	0	
4:45-5:00	10	0		70	0		70	0		20	0	
5:00-5:15	40	0		60	0		20	0		20	0	
5:15-5:30	110	0		70	0		20	0		30	0	
5:30-5:45	130	0		90	0		30	0		20	0	
5:45-6:00	160	0		70	0		40	0		50	0	
6:00-6:15	120	0		80	0		60	0		20	0	
6:15-6:30	200	20	7	70	0		50	0		110	20	2, 5, 13
6:30-6:45	450	150	7	90	0		50	0		110	20	2, 5, 13
6:45-7:00	480	170	7	120	10	7	30	0		100	10	2, 5

滞留長・渋滞長調査表

調査地点：地域社会2 目黒交番前

調査年月日：令和元年 5月14日(火) 天候：雨のち曇り



滞留原因凡例	1：車線減少	2：信号現示不遵	3：踏切	4：橋梁	5：右折、対向直進	6：左折車
	7：大型車	8：二輪車	9：歩行者	10：駐車車両	11：バス停、バスレーン	12：工事、事故
	13：沿道出入車両	14：道路線形	15：交差点形状	16：先詰まり	17：その他	

方向 観測時間	方向 a			方向 b			方向 c			方向 d		
	滞留長 (m)	渋滞長 (m)	渋滞 原因	滞留長 (m)	渋滞長 (m)	渋滞 原因	滞留長 (m)	渋滞長 (m)	渋滞 原因	滞留長 (m)	渋滞長 (m)	渋滞 原因
7:00-7:15	80	20	2,7	90	0		70	0		190	0	
7:15-7:30	70	10	2	40	0		120	20	2	260	50	7,16
7:30-7:45	100	40	2	40	0		130	60	2	310	30	7,16
7:45-8:00	110	50	2	60	0		240	90	2	240	0	
8:00-8:15	100	50	2	30	0		270	110	2	200	0	
8:15-8:30	80	30	2	40	0		140	30	2	190	0	
8:30-8:45	100	40	2	80	0		120	20	2	230	0	
8:45-9:00	70	20	2	30	0		70	30	2	260	0	
9:00-9:15	70	10	2	50	0		160	40	2	280	0	
9:15-9:30	80	20	2	40	0		120	40	2	330	60	7,13
9:30-9:45	100	40	2	30	0		80	0		300	50	7,13
9:45-10:00	60	0		40	0		70	0		390	180	7,13
10:00-10:15	70	20	2,7	30	0		50	0		450	220	7,13
10:15-10:30	70	10	2,7	40	0		80	0		400	180	7,13
10:30-10:45	60	10	2,7	30	0		80	0		360	150	7,13
10:45-11:00	70	20	2,7	60	0		90	10	2	220	0	
11:00-11:15	90	30	2	50	0		90	0		200	0	
11:15-11:30	70	20	2	30	0		60	0		230	0	
11:30-11:45	60	20	2,7	30	0		120	20	2	280	0	
11:45-12:00	100	40	2,7	20	0		90	20	2	250	0	
12:00-12:15	40	0		80	0		30	0		450	350	7,16
12:15-12:30	80	30	2,7	30	0		40	0		420	270	7,16
12:30-12:45	40	10	2,7	50	0		40	0		370	180	7,16
12:45-13:00	30	0		80	0		60	0		170	0	
13:00-13:15	110	60	2,7	20	0		40	0		290	0	
13:15-13:30	100	40	2	40	0		70	0		350	190	7,16
13:30-13:45	50	0		30	0		60	0		410	260	7,16
13:45-14:00	40	0		70	0		30	0		470	300	7,16
14:00-14:15	80	0		50	0		40	0		220	0	
14:15-14:30	50	0		40	0		60	0		150	0	
14:30-14:45	40	0		40	0		70	0		370	200	7
14:45-15:00	60	20	2,7	70	0		40	0		170	0	
15:00-15:15	90	40	2	30	0		90	20	2	280	30	7
15:15-15:30	50	0		40	0		60	10	2	70	0	
15:30-15:45	50	0		30	0		70	0		170	0	
15:45-16:00	90	0		90	0		30	0		250	0	
16:00-16:15	110	40	2,7	90	0		50	0		500	330	7,16
16:15-16:30	130	90	2,7	20	0		60	0		180	0	
16:30-16:45	110	50	2,7	30	0		50	0		160	0	
16:45-17:00	100	50	2	20	0		80	0		190	0	
17:00-17:15	50	0		20	0		20	0		140	0	
17:15-17:30	50	10	2,7	30	0		60	0		550	250	7,16
17:30-17:45	70	20	2	50	0		60	0		370	60	7,16
17:45-18:00	60	20	2	40	0		90	0		400	50	7
18:00-18:15	100	50	2	20	0		100	0		260	0	
18:15-18:30	120	70	2,7	50	0		70	0		270	0	
18:30-18:45	120	60	2	20	0		50	0		260	0	
18:45-19:00	130	30	2	30	0		50	0		70	0	

滞留長・渋滞長調査表

調査地点：地域社会2 目黒交番前

調査年月日：令和元年 5月14日(火) 天候：雨のち曇り



滞留原因凡例	1：車線減少	2：信号現示不遵	3：踏切	4：橋梁	5：右折、対向直進	6：左折車
	7：大型車	8：二輪車	9：歩行者	10：駐車車両	11：バス停、バスレーン	12：工事、事故
	13：沿道出入車両	14：道路線形	15：交差点形状	16：先詰まり	17：その他	

方向 観測時間	方向 a			方向 b			方向 c			方向 d		
	滞留長 (m)	渋滞長 (m)	渋滞 原因	滞留長 (m)	渋滞長 (m)	渋滞 原因	滞留長 (m)	渋滞長 (m)	渋滞 原因	滞留長 (m)	渋滞長 (m)	渋滞 原因
19:00-19:15	60	10	2	40	0		70	0		150	0	
19:15-19:30	90	40	2	50	0		50	0		160	0	
19:30-19:45	110	50	2	30	0		20	0		70	0	
19:45-20:00	30	0		20	0		30	0		30	0	
20:00-20:15	40	0		30	0		20	0		50	0	
20:15-20:30	50	20	2	20	0		20	0		50	0	
20:30-20:45	40	0		10	0		20	0		120	0	
20:45-21:00	50	0		30	0		20	0		60	0	
21:00-21:15	30	0		40	0		10	0		60	0	
21:15-21:30	20	0		30	0		10	0		100	0	
21:30-21:45	50	0		50	0		10	0		30	0	
21:45-22:00	20	0		20	0		20	0		50	0	
22:00-22:15	40	0		40	0		10	0		50	0	
22:15-22:30	10	0		20	0		10	0		70	0	
22:30-22:45	10	0		50	0		30	0		20	0	
22:45-23:00	20	0		40	0		20	0		70	0	
23:00-23:15	20	0		20	0		10	0		20	0	
23:15-23:30	20	0		20	0		20	0		60	0	
23:30-23:45	10	0		20	0		10	0		40	0	
23:45-24:00	10	0		20	0		20	0		30	0	
0:00-0:15	10	0		10	0		10	0		60	0	
0:15-0:30	10	0		10	0		10	0		20	0	
0:30-0:45	20	0		60	0		10	0		30	0	
0:45-1:00	10	0		10	0		10	0		40	0	
1:00-1:15	10	0		60	0		10	0		30	0	
1:15-1:30	10	0		40	0		10	0		30	0	
1:30-1:45	10	0		20	0		10	0		60	0	
1:45-2:00	10	0		20	0		10	0		30	0	
2:00-2:15	10	0		40	0		10	0		20	0	
2:15-2:30	10	0		50	0		10	0		20	0	
2:30-2:45	10	0		20	0		10	0		30	0	
2:45-3:00	10	0		70	0		10	0		50	0	
3:00-3:15	10	0		10	0		10	0		80	0	
3:15-3:30	10	0		10	0		20	0		50	0	
3:30-3:45	10	0		30	0		10	0		30	0	
3:45-4:00	10	0		10	0		10	0		10	0	
4:00-4:15	10	0		40	0		10	0		20	0	
4:15-4:30	10	0		20	0		10	0		50	0	
4:30-4:45	10	0		20	0		10	0		30	0	
4:45-5:00	10	0		40	0		10	0		40	0	
5:00-5:15	10	0		20	0		10	0		70	0	
5:15-5:30	10	0		80	0		20	0		170	0	
5:30-5:45	10	0		70	0		30	0		120	0	
5:45-6:00	20	0		70	0		60	0		190	0	
6:00-6:15	20	0		30	0		90	0		20	0	
6:15-6:30	70	0		20	0		80	0		300	40	7
6:30-6:45	20	0		40	0		120	10	2	260	0	
6:45-7:00	60	0		30	0		150	30	2	120	0	

滞留長・渋滞長調査表

調査地点：地域社会3 上川井IC

調査年月日：令和元年 5月14日(火) 天候：雨のち曇り



滞滯原因凡例	1：車線減少	2：信号現示不遵	3：踏切	4：橋梁	5：右折、対向直進	6：左折車
	7：大型車	8：二輪車	9：歩行者	10：駐車車両	11：バス停、バスレーン	12：工事、事故
	13：沿道出入車両	14：道路線形	15：交差点形状	16：先詰まり	17：その他	

観測時間	方向 a			方向 b			方向 c			方向 d		
	滞留長 (m)	渋滞長 (m)	渋滞原因	滞留長 (m)	渋滞長 (m)	渋滞原因	滞留長 (m)	渋滞長 (m)	渋滞原因	滞留長 (m)	渋滞長 (m)	渋滞原因
7:00-7:15	30	0		90	0		140	0		50	0	
7:15-7:30	20	0		110	60	7	160	0		60	0	
7:30-7:45	20	0		40	0		140	0		40	0	
7:45-8:00	10	0		60	0		30	0		50	0	
8:00-8:15	10	0		80	0		50	0		150	20	2
8:15-8:30	40	0		70	0		70	20	5	100	0	
8:30-8:45	60	0		120	0		20	0		110	10	2
8:45-9:00	60	0		130	0		10	0		40	0	
9:00-9:15	10	0		50	0		30	0		30	0	
9:15-9:30	50	0		80	0		140	0		40	0	
9:30-9:45	20	0		90	0		150	0		70	0	
9:45-10:00	80	0		160	0		130	0		60	0	
10:00-10:15	90	0		100	0		70	30	5	40	0	
10:15-10:30	20	0		120	0		10	0		50	0	
10:30-10:45	110	10	6	80	0		20	0		40	0	
10:45-11:00	80	0		100	0		20	0		20	0	
11:00-11:15	20	0		110	0		10	0		70	0	
11:15-11:30	40	0		130	0		20	0		30	0	
11:30-11:45	10	0		90	0		10	0		60	0	
11:45-12:00	20	0		80	0		10	0		30	0	
12:00-12:15	20	0		100	40	7	20	0		50	0	
12:15-12:30	20	0		120	0		30	0		60	0	
12:30-12:45	10	0		120	0		10	0		30	0	
12:45-13:00	20	0		80	0		10	0		40	0	
13:00-13:15	30	0		150	0		30	0		70	0	
13:15-13:30	10	0		130	0		40	0		40	0	
13:30-13:45	20	0		120	0		30	0		30	0	
13:45-14:00	90	0		100	0		20	0		30	0	
14:00-14:15	10	0		70	0		30	0		40	0	
14:15-14:30	10	0		130	0		40	0		30	0	
14:30-14:45	20	0		130	0		30	0		60	0	
14:45-15:00	10	0		120	0		30	0		60	0	
15:00-15:15	30	0		140	40	7	20	0		30	0	
15:15-15:30	10	0		130	0		30	0		40	0	
15:30-15:45	30	0		120	0		10	0		40	0	
15:45-16:00	10	0		70	10	7	20	0		30	0	
16:00-16:15	20	0		120	0		10	0		40	0	
16:15-16:30	50	0		100	0		60	0		40	0	
16:30-16:45	20	0		60	0		80	20	5	30	0	
16:45-17:00	20	0		70	0		50	10	5	20	0	
17:00-17:15	60	0		120	0		30	10	5	50	0	
17:15-17:30	40	0		120	0		30	0		40	0	
17:30-17:45	10	0		110	0		20	0		60	0	
17:45-18:00	10	0		130	0		20	0		40	0	
18:00-18:15	130	20	6	150	0		20	0		50	0	
18:15-18:30	10	0		220	30	5,7	30	0		30	0	
18:30-18:45	10	0		120	0		10	0		40	0	
18:45-19:00	20	0		180	10	5,7	10	0		30	0	

滞留長・渋滞長調査表

調査地点：地域社会3 上川井IC

調査年月日：令和元年 5月14日(火) 天候：雨のち曇り



滞滯原因凡例	1：車線減少	2：信号現示不遵	3：踏切	4：橋梁	5：右折、対向直進	6：左折車
	7：大型車	8：二輪車	9：歩行者	10：駐車車両	11：バス停、バスレーン	12：工事、事故
	13：沿道出入車両	14：道路線形	15：交差点形状	16：先詰まり	17：その他	

観測時間	方向 a			方向 b			方向 c			方向 d		
	滞留長 (m)	渋滞長 (m)	渋滞原因	滞留長 (m)	渋滞長 (m)	渋滞原因	滞留長 (m)	渋滞長 (m)	渋滞原因	滞留長 (m)	渋滞長 (m)	渋滞原因
19:00-19:15	10	0		120	0		10	0		30	0	
19:15-19:30	10	0		120	0		20	0		60	0	
19:30-19:45	10	0		50	0		20	0		30	0	
19:45-20:00	20	0		60	0		30	0		30	0	
20:00-20:15	10	0		110	0		10	0		40	0	
20:15-20:30	10	0		40	0		10	0		20	0	
20:30-20:45	10	0		60	10	7	30	0		60	0	
20:45-21:00	10	0		50	0		20	0		20	0	
21:00-21:15	10	0		20	0		10	0		20	0	
21:15-21:30	10	0		20	0		10	0		20	0	
21:30-21:45	10	0		20	0		10	0		10	0	
21:45-22:00	10	0		70	0		10	0		10	0	
22:00-22:15	10	0		30	0		10	0		20	0	
22:15-22:30	20	0		40	0		20	0		20	0	
22:30-22:45	10	0		80	0		10	0		20	0	
22:45-23:00	10	0		140	10	7	10	0		10	0	
23:00-23:15	10	0		60	0		10	0		10	0	
23:15-23:30	20	0		30	0		10	0		10	0	
23:30-23:45	10	0		20	0		10	0		10	0	
23:45-24:00	10	0		30	0		10	0		10	0	
0:00-0:15	10	0		30	0		10	0		10	0	
0:15-0:30	20	0		30	0		10	0		30	0	
0:30-0:45	10	0		60	0		10	0		20	0	
0:45-1:00	10	0		50	0		10	0		10	0	
1:00-1:15	10	0		30	0		10	0		10	0	
1:15-1:30	10	0		10	0		10	0		10	0	
1:30-1:45	10	0		20	0		10	0		10	0	
1:45-2:00	10	0		60	0		10	0		10	0	
2:00-2:15	10	0		10	0		10	0		10	0	
2:15-2:30	30	0		20	0		10	0		10	0	
2:30-2:45	50	0		80	0		10	0		10	0	
2:45-3:00	30	0		50	0		10	0		10	0	
3:00-3:15	20	0		40	0		10	0		20	0	
3:15-3:30	10	0		50	0		10	0		10	0	
3:30-3:45	10	0		30	0		10	0		10	0	
3:45-4:00	10	0		60	0		10	0		30	0	
4:00-4:15	30	0		40	0		10	0		30	0	
4:15-4:30	20	0		80	0		10	0		40	0	
4:30-4:45	40	0		90	0		10	0		30	0	
4:45-5:00	20	0		70	0		10	0		20	0	
5:00-5:15	10	0		80	0		10	0		20	0	
5:15-5:30	30	0		70	0		10	0		20	0	
5:30-5:45	20	0		160	0		10	0		30	0	
5:45-6:00	10	0		130	0		10	0		20	0	
6:00-6:15	20	0		380	190	5.7	10	0		30	0	
6:15-6:30	40	0		170	30	5.7	10	0		30	0	
6:30-6:45	130	30	6	100	0		30	0		60	0	
6:45-7:00	40	0		140	50	5.16	30	0		70	0	

滞留長・渋滞長調査表

調査地点：地域社会4 滝沢

調査年月日：令和 2年 9月29日(火) 天候：曇りのち晴れ



滞滯原因凡例	1：車線減少	2：信号現示不遵	3：踏切	4：橋梁	5：右折、対向直進	6：左折車
	7：大型車	8：二輪車	9：歩行者	10：駐車車両	11：バス停、バスレーン	12：工事、事故
	13：沿道出入車両	14：道路線形	15：交差点形状	16：先詰まり	17：その他	

方向 観測時間	方向 a			方向 b			方向 c			滞留長 (m)	渋滞長 (m)	渋滞 原因
	滞留長 (m)	渋滞長 (m)	渋滞 原因	滞留長 (m)	渋滞長 (m)	渋滞 原因	滞留長 (m)	渋滞長 (m)	渋滞 原因			
7:00-7:15	30	0		70	0		90	0				
7:15-7:30	30	0		80	0		70	0				
7:30-7:45	50	0		110	0		40	0				
7:45-8:00	40	0		90	0		60	0				
8:00-8:15	50	0		70	0		40	0				
8:15-8:30	40	0		100	0		70	0				
8:30-8:45	50	0		100	0		110	0				
8:45-9:00	30	0		60	0		100	0				
9:00-9:15	40	0		80	0		60	0				
9:15-9:30	20	0		50	0		40	0				
9:30-9:45	30	0		100	0		50	0				
9:45-10:00	30	0		70	0		100	0				
10:00-10:15	30	0		40	0		70	0				
10:15-10:30	20	0		60	0		60	0				
10:30-10:45	20	0		50	0		40	0				
10:45-11:00	20	0		60	0		70	0				
11:00-11:15	40	0		70	0		60	0				
11:15-11:30	20	0		40	0		30	0				
11:30-11:45	10	0		60	0		40	0				
11:45-12:00	20	0		70	0		100	0				
12:00-12:15	20	0		50	0		50	0				
12:15-12:30	10	0		80	0		30	0				
12:30-12:45	30	0		70	0		40	0				
12:45-13:00	20	0		30	0		40	0				
13:00-13:15	20	0		40	0		40	0				
13:15-13:30	20	0		20	0		100	0				
13:30-13:45	30	0		30	0		40	0				
13:45-14:00	30	0		50	0		60	0				
14:00-14:15	20	0		60	0		90	0				
14:15-14:30	20	0		50	0		110	0				
14:30-14:45	20	0		120	0		60	0				
14:45-15:00	30	0		30	0		40	0				
15:00-15:15	30	0		40	0		30	0				
15:15-15:30	40	0		30	0		60	0				
15:30-15:45	40	0		40	0		70	0				
15:45-16:00	30	0		60	0		40	0				
16:00-16:15	30	0		100	0		40	0				
16:15-16:30	20	0		70	0		50	0				
16:30-16:45	20	0		80	0		90	0				
16:45-17:00	30	0		100	0		50	0				
17:00-17:15	30	0		60	0		110	0				
17:15-17:30	70	0		70	0		120	0				
17:30-17:45	50	0		90	0		70	0				
17:45-18:00	60	0		60	0		100	0				
18:00-18:15	60	0		80	0		120	0				
18:15-18:30	50	0		80	0		110	0				
18:30-18:45	60	0		90	0		440	100	7.16			
18:45-19:00	80	0		110	0		480	130	16			

滞留長・渋滞長調査表

調査地点：地域社会4 滝沢

調査年月日：令和 2年 9月29日(火) 天候：曇りのち晴れ



滞滯原因凡例	1：車線減少	2：信号現示不遵	3：踏切	4：橋梁	5：右折、対向直進	6：左折車
	7：大型車	8：二輪車	9：歩行者	10：駐車車両	11：バス停、バスレーン	12：工事、事故
	13：沿道出入車両	14：道路線形	15：交差点形状	16：先詰まり	17：その他	

方向 観測時間	方向 a			方向 b			方向 c			滞留長 (m)	渋滞長 (m)	渋滞原因
	滞留長 (m)	渋滞長 (m)	渋滞原因	滞留長 (m)	渋滞長 (m)	渋滞原因	滞留長 (m)	渋滞長 (m)	渋滞原因			
19:00-19:15	70	0		90	0		600	400	16			
19:15-19:30	40	0		100	0		130	10	16			
19:30-19:45	30	0		80	0		60	0				
19:45-20:00	40	0		50	0		60	0				
20:00-20:15	30	0		30	0		100	0				
20:15-20:30	20	0		60	0		40	0				
20:30-20:45	10	0		70	0		60	0				
20:45-21:00	10	0		30	0		20	0				
21:00-21:15	20	0		40	0		20	0				
21:15-21:30	10	0		70	0		20	0				
21:30-21:45	10	0		60	0		10	0				
21:45-22:00	10	0		10	0		10	0				
22:00-22:15	10	0		20	0		20	0				
22:15-22:30	10	0		10	0		10	0				
22:30-22:45	10	0		40	0		20	0				
22:45-23:00	20	0		10	0		20	0				
23:00-23:15	10	0		20	0		10	0				
23:15-23:30	10	0		10	0		10	0				
23:30-23:45	10	0		10	0		20	0				
23:45-24:00	10	0		30	0		20	0				
0:00-0:15	10	0		10	0		10	0				
0:15-0:30	10	0		10	0		60	0				
0:30-0:45	10	0		10	0		40	0				
0:45-1:00	10	0		10	0		60	0				
1:00-1:15	10	0		10	0		20	0				
1:15-1:30	10	0		10	0		20	0				
1:30-1:45	10	0		10	0		20	0				
1:45-2:00	10	0		10	0		10	0				
2:00-2:15	20	0		10	0		20	0				
2:15-2:30	10	0		20	0		20	0				
2:30-2:45	10	0		10	0		20	0				
2:45-3:00	10	0		10	0		20	0				
3:00-3:15	10	0		10	0		70	0				
3:15-3:30	10	0		10	0		40	0				
3:30-3:45	10	0		10	0		30	0				
3:45-4:00	10	0		20	0		20	0				
4:00-4:15	10	0		10	0		20	0				
4:15-4:30	10	0		10	0		20	0				
4:30-4:45	10	0		10	0		20	0				
4:45-5:00	10	0		30	0		20	0				
5:00-5:15	20	0		20	0		20	0				
5:15-5:30	10	0		40	0		10	0				
5:30-5:45	10	0		10	0		30	0				
5:45-6:00	10	0		10	0		30	0				
6:00-6:15	10	0		100	0		30	0				
6:15-6:30	10	0		60	0		20	0				
6:30-6:45	10	0		50	0		30	0				
6:45-7:00	20	0		90	0		30	0				

滞留長・渋滞長調査表

調査地点：地域社会4 瀬谷土橋公園入口

調査年月日：令和 2年 9月29日(火) 天候：曇りのち晴れ



渋滞原因凡例	1：車線減少	2：信号現示不遵	3：踏切	4：橋梁	5：右折、対向直進	6：左折車
	7：大型車	8：二輪車	9：歩行者	10：駐車車両	11：バス停、バスレーン	12：工事、事故
	13：沿道出入車両	14：道路線形	15：交差点形状	16：先詰まり	17：その他	

方向 観測時間	方向 a			方向 b			方向 c			滞留長 (m)	渋滞長 (m)	渋滞原因
	滞留長 (m)	渋滞長 (m)	渋滞原因	滞留長 (m)	渋滞長 (m)	渋滞原因	滞留長 (m)	渋滞長 (m)	渋滞原因			
7:00-7:15	100	0		100	0		60	0				
7:15-7:30	70	0		70	0		100	0				
7:30-7:45	60	0		60	0		60	0				
7:45-8:00	110	0		130	0		90	0				
8:00-8:15	100	0		150	0		40	0				
8:15-8:30	210	30	6, 13, 16	80	0		90	0				
8:30-8:45	110	0		50	0		50	0				
8:45-9:00	70	0		20	0		70	0				
9:00-9:15	40	0		100	0		20	0				
9:15-9:30	60	0		120	0		50	0				
9:30-9:45	70	0		20	0		50	0				
9:45-10:00	90	0		30	0		70	0				
10:00-10:15	50	0		20	0		50	0				
10:15-10:30	160	0		20	0		20	0				
10:30-10:45	50	0		30	0		100	0				
10:45-11:00	60	0		20	0		30	0				
11:00-11:15	80	0		20	0		40	0				
11:15-11:30	40	0		50	0		30	0				
11:30-11:45	50	0		60	0		20	0				
11:45-12:00	130	0		40	0		50	0				
12:00-12:15	50	0		20	0		50	0				
12:15-12:30	120	0		20	0		50	0				
12:30-12:45	60	0		60	10	5, 7	60	0				
12:45-13:00	120	0		10	0		70	0				
13:00-13:15	50	0		40	0		50	0				
13:15-13:30	100	0		20	0		40	0				
13:30-13:45	60	0		20	0		80	0				
13:45-14:00	120	0		50	0		50	0				
14:00-14:15	60	0		20	0		60	0				
14:15-14:30	80	0		30	0		30	0				
14:30-14:45	70	0		50	0		50	0				
14:45-15:00	70	0		40	0		60	0				
15:00-15:15	60	0		20	0		40	0				
15:15-15:30	30	0		20	0		50	0				
15:30-15:45	140	20	7, 13	30	0		20	0				
15:45-16:00	100	0		20	0		20	0				
16:00-16:15	90	0		40	0		70	0				
16:15-16:30	100	0		20	0		60	0				
16:30-16:45	70	0		60	0		110	0				
16:45-17:00	60	0		50	0		20	0				
17:00-17:15	70	0		20	0		30	0				
17:15-17:30	160	40	13, 16	70	0		40	0				
17:30-17:45	200	30	6, 16	40	0		60	0				
17:45-18:00	160	40	7, 16	40	0		70	0				
18:00-18:15	350	180	6, 13, 16	110	0		60	0				
18:15-18:30	350	250	6, 13, 16	60	0		100	0				
18:30-18:45	200	180	7, 16	140	0		150	20	7, 16			
18:45-19:00	350	250	7, 13, 16	30	0		120	0				

滞留長・渋滞長調査表

調査地点：地域社会4 瀬谷土橋公園入口

調査年月日：令和 2年 9月29日(火) 天候：曇りのち晴れ



滞留原因凡例	1：車線減少	2：信号現示不遵	3：踏切	4：橋梁	5：右折、対向直進	6：左折車
	7：大型車	8：二輪車	9：歩行者	10：駐車車両	11：バス停、バスレーン	12：工事、事故
	13：沿道出入車両	14：道路線形	15：交差点形状	16：先詰まり	17：その他	

観測時間	方向 a			方向 b			方向 c			滞留長 (m)	渋滞長 (m)	渋滞原因
	滞留長 (m)	渋滞長 (m)	渋滞原因	滞留長 (m)	渋滞長 (m)	渋滞原因	滞留長 (m)	渋滞長 (m)	渋滞原因			
19:00-19:15	350	220	6, 13, 16	10	0		70	0				
19:15-19:30	150	30	6, 13, 16	20	0		40	0				
19:30-19:45	60	0		30	0		30	0				
19:45-20:00	40	0		20	0		70	0				
20:00-20:15	60	0		20	0		50	0				
20:15-20:30	60	0		40	0		60	0				
20:30-20:45	50	0		20	0		50	0				
20:45-21:00	30	0		50	0		30	0				
21:00-21:15	20	0		20	0		20	0				
21:15-21:30	30	0		20	0		30	0				
21:30-21:45	30	0		10	0		20	0				
21:45-22:00	20	0		20	0		30	0				
22:00-22:15	40	0		20	0		10	0				
22:15-22:30	10	0		30	0		10	0				
22:30-22:45	20	0		20	0		20	0				
22:45-23:00	10	0		10	0		20	0				
23:00-23:15	30	0		20	0		10	0				
23:15-23:30	20	0		10	0		10	0				
23:30-23:45	20	0		10	0		20	0				
23:45-24:00	10	0		10	0		10	0				
0:00-0:15	20	0		20	0		10	0				
0:15-0:30	10	0		10	0		10	0				
0:30-0:45	30	0		10	0		10	0				
0:45-1:00	20	0		10	0		10	0				
1:00-1:15	20	0		10	0		20	0				
1:15-1:30	20	0		20	0		30	0				
1:30-1:45	20	0		10	0		10	0				
1:45-2:00	10	0		10	0		10	0				
2:00-2:15	20	0		10	0		10	0				
2:15-2:30	20	0		10	0		20	0				
2:30-2:45	10	0		10	0		10	0				
2:45-3:00	20	0		10	0		10	0				
3:00-3:15	10	0		10	0		10	0				
3:15-3:30	10	0		10	0		10	0				
3:30-3:45	10	0		10	0		10	0				
3:45-4:00	10	0		10	0		20	0				
4:00-4:15	10	0		10	0		10	0				
4:15-4:30	20	0		20	0		10	0				
4:30-4:45	20	0		10	0		10	0				
4:45-5:00	10	0		20	0		10	0				
5:00-5:15	10	0		30	0		20	0				
5:15-5:30	30	0		30	0		20	0				
5:30-5:45	20	0		40	0		10	0				
5:45-6:00	30	0		20	0		10	0				
6:00-6:15	50	0		50	20	5, 7	20	0				
6:15-6:30	20	0		130	0		20	0				
6:30-6:45	70	0		90	0		10	0				
6:45-7:00	120	0		60	20	5, 7	30	0				

滞留長・渋滞長調査表

調査地点：地域社会5

調査年月日：令和元年 5月14日(火) 天候：雨のち曇り



1：車線減少	2：信号現示不遵	3：踏切	4：橋梁	5：右折、対向直進	6：左折車
7：大型車	8：二輪車	9：歩行者	10：駐車車両	11：バス停、バスレーン	12：工事、事故
13：沿道出入車両	14：道路線形	15：交差点形状	16：先詰まり	17：その他	

方向 観測時間	方向 a			方向 b			方向 c			滞留長 (m)	渋滞長 (m)	渋滞 原因
	滞留長 (m)	渋滞長 (m)	渋滞 原因	滞留長 (m)	渋滞長 (m)	渋滞 原因	滞留長 (m)	渋滞長 (m)	渋滞 原因			
7:00-7:15	160	50	6	180	90	5.16	40	0				
7:15-7:30	60	0		140	30	5.16	40	0				
7:30-7:45	50	0		350	150	5.16	50	0				
7:45-8:00	540	440	2.6	350	300	5.16	40	0				
8:00-8:15	530	480	2.6	320	270	5.16	70	0				
8:15-8:30	510	410	2.6	230	80	5.16	40	0				
8:30-8:45	500	390	2.6	340	300	5.16	60	0				
8:45-9:00	440	320	2.6	400	300	5.16	60	0				
9:00-9:15	50	0		120	20	5.13	50	0				
9:15-9:30	70	0		40	0		10	0				
9:30-9:45	130	30	6	80	0		20	0				
9:45-10:00	80	0		60	0		20	0				
10:00-10:15	50	0		90	0		20	0				
10:15-10:30	80	0		70	0		10	0				
10:30-10:45	50	0		40	0		10	0				
10:45-11:00	70	0		40	0		30	0				
11:00-11:15	60	0		20	0		20	0				
11:15-11:30	80	0		10	0		40	0				
11:30-11:45	50	0		40	0		50	0				
11:45-12:00	60	0		50	0		30	0				
12:00-12:15	80	0		130	0		40	0				
12:15-12:30	70	0		70	0		40	0				
12:30-12:45	80	0		60	0		20	0				
12:45-13:00	90	0		50	0		20	0				
13:00-13:15	80	0		20	0		20	0				
13:15-13:30	60	0		60	0		20	0				
13:30-13:45	50	0		50	0		40	0				
13:45-14:00	50	0		20	0		20	0				
14:00-14:15	80	0		40	0		40	0				
14:15-14:30	50	0		20	0		40	0				
14:30-14:45	40	0		30	0		20	0				
14:45-15:00	30	0		50	0		10	0				
15:00-15:15	60	0		40	0		70	20	2			
15:15-15:30	60	0		60	0		30	0				
15:30-15:45	20	0		110	0		10	0				
15:45-16:00	30	0		130	0		10	0				
16:00-16:15	140	20	6	20	0		30	0				
16:15-16:30	140	10	7	30	0		30	0				
16:30-16:45	100	0		40	0		20	0				
16:45-17:00	30	0		40	0		10	0				
17:00-17:15	120	0		80	0		60	0				
17:15-17:30	170	50	2	110	0		40	0				
17:30-17:45	140	30	2	80	0		40	0				
17:45-18:00	200	100	6	110	0		30	0				
18:00-18:15	60	0		30	0		40	0				
18:15-18:30	90	0		130	0		30	0				
18:30-18:45	70	0		70	0		30	0				
18:45-19:00	70	0		30	0		50	0				

滞留長・渋滞長調査表

調査地点：地域社会5

調査年月日：令和元年 5月14日(火) 天候：雨のち曇り



滞滯原因凡例	1：車線減少	2：信号現示不遵	3：踏切	4：橋梁	5：右折、対向直進	6：左折車
	7：大型車	8：二輪車	9：歩行者	10：駐車車両	11：バス停、バスレーン	12：工事、事故
	13：沿道出入車両	14：道路線形	15：交差点形状	16：先詰まり	17：その他	

観測時間	方向 a			方向 b			方向 c			滞留長 (m)	渋滞長 (m)	渋滞原因
	滞留長 (m)	渋滞長 (m)	渋滞原因	滞留長 (m)	渋滞長 (m)	渋滞原因	滞留長 (m)	渋滞長 (m)	渋滞原因			
19:00-19:15	40	0		70	0		10	0				
19:15-19:30	50	0		100	0		20	0				
19:30-19:45	80	0		30	0		20	0				
19:45-20:00	80	0		20	0		20	0				
20:00-20:15	60	0		20	0		30	0				
20:15-20:30	70	0		20	0		10	0				
20:30-20:45	120	20	6	30	0		20	0				
20:45-21:00	40	0		70	0		20	0				
21:00-21:15	60	0		30	0		10	0				
21:15-21:30	50	0		20	0		10	0				
21:30-21:45	30	0		60	0		10	0				
21:45-22:00	30	0		50	0		10	0				
22:00-22:15	30	0		20	0		10	0				
22:15-22:30	40	0		20	0		10	0				
22:30-22:45	20	0		20	0		10	0				
22:45-23:00	20	0		10	0		20	0				
23:00-23:15	20	0		20	0		10	0				
23:15-23:30	20	0		10	0		10	0				
23:30-23:45	10	0		10	0		10	0				
23:45-24:00	10	0		10	0		10	0				
0:00-0:15	10	0		10	0		10	0				
0:15-0:30	10	0		10	0		10	0				
0:30-0:45	10	0		10	0		10	0				
0:45-1:00	10	0		10	0		10	0				
1:00-1:15	20	0		10	0		10	0				
1:15-1:30	20	0		10	0		10	0				
1:30-1:45	30	0		10	0		10	0				
1:45-2:00	10	0		10	0		10	0				
2:00-2:15	10	0		10	0		10	0				
2:15-2:30	10	0		10	0		10	0				
2:30-2:45	10	0		10	0		10	0				
2:45-3:00	10	0		10	0		10	0				
3:00-3:15	10	0		10	0		10	0				
3:15-3:30	10	0		10	0		10	0				
3:30-3:45	10	0		10	0		10	0				
3:45-4:00	10	0		10	0		10	0				
4:00-4:15	20	0		10	0		10	0				
4:15-4:30	50	0		10	0		10	0				
4:30-4:45	10	0		10	0		10	0				
4:45-5:00	30	0		30	0		10	0				
5:00-5:15	50	0		40	0		10	0				
5:15-5:30	40	0		40	0		10	0				
5:30-5:45	50	0		80	0		10	0				
5:45-6:00	10	0		30	0		10	0				
6:00-6:15	10	0		70	0		20	0				
6:15-6:30	10	0		40	0		40	0				
6:30-6:45	40	0		70	0		30	0				
6:45-7:00	30	0		50	0		10	0				

滞留長・渋滞長調査表

調査地点：地域社会6 瀬谷中学校前

調査年月日：令和元年 5月14日(火) 天候：雨のち曇り



滞留原因凡例	1：車線減少	2：信号現示不遵	3：踏切	4：橋梁	5：右折、対向直進	6：左折車
	7：大型車	8：二輪車	9：歩行者	10：駐車車両	11：バス停、バスレーン	12：工事、事故
	13：沿道出入車両	14：道路線形	15：交差点形状	16：先詰まり	17：その他	

方向 観測時間	方向 a			方向 b			方向 c			方向 d		
	滞留長 (m)	渋滞長 (m)	渋滞 原因	滞留長 (m)	渋滞長 (m)	渋滞 原因	滞留長 (m)	渋滞長 (m)	渋滞 原因	滞留長 (m)	渋滞長 (m)	渋滞 原因
7:00-7:15	50	0		80	0		130	30	2	100	20	13
7:15-7:30	60	0		90	0		150	90	2	110	20	13
7:30-7:45	110	20	2	130	30	5	150	50	2	120	20	13
7:45-8:00	90	0		140	30	7	150	70	2	100	0	
8:00-8:15	70	0		140	50	5	150	70	2	100	20	13
8:15-8:30	60	0		100	0		150	90	2	150	50	13
8:30-8:45	50	0		120	40	5	150	90	2	160	60	13
8:45-9:00	80	0		60	0		150	50	2	100	0	
9:00-9:15	80	0		50	0		100	0		60	0	
9:15-9:30	80	0		60	0		150	70	2	50	0	
9:30-9:45	120	10	2	50	0		90	0		40	0	
9:45-10:00	140	30	2	40	0		80	0		40	0	
10:00-10:15	160	60	2	50	0		120	30	2	40	0	
10:15-10:30	110	10	2	40	0		100	20	2	30	0	
10:30-10:45	110	10	2	30	0		120	30	2	100	20	13
10:45-11:00	120	20	2	40	0		90	0		110	30	13
11:00-11:15	140	20	2	50	0		140	80	2	30	0	
11:15-11:30	130	10	2	60	0		60	0		40	0	
11:30-11:45	100	0		30	0		30	0		60	0	
11:45-12:00	160	50	2	40	0		30	0		50	0	
12:00-12:15	200	90	2	30	0		70	0		40	0	
12:15-12:30	120	20	2	20	0		80	0		110	0	
12:30-12:45	80	0		30	0		130	40	2	60	0	
12:45-13:00	50	0		20	0		120	20	2	60	0	
13:00-13:15	120	10	2	40	0		50	0		50	0	
13:15-13:30	70	0		30	0		100	20	2	80	0	
13:30-13:45	50	0		20	0		130	50	2	50	0	
13:45-14:00	50	0		30	0		60	0		70	0	
14:00-14:15	70	0		60	0		50	0		20	0	
14:15-14:30	100	0		30	0		100	0		40	0	
14:30-14:45	80	20	2	30	0		80	0		30	0	
14:45-15:00	140	40	2	40	0		70	0		50	0	
15:00-15:15	100	30	2	20	0		60	0		30	0	
15:15-15:30	90	0		40	0		100	0		30	0	
15:30-15:45	140	50	2	40	0		50	0		20	0	
15:45-16:00	100	0		40	0		90	0		40	0	
16:00-16:15	130	50	2	40	0		110	10	2	40	0	
16:15-16:30	50	0		100	0		110	30	2	80	0	
16:30-16:45	150	50	2	30	0		60	0		70	0	
16:45-17:00	80	0		70	0		120	10	2	60	0	
17:00-17:15	50	0		120	20	7	80	0		120	50	6
17:15-17:30	50	0		70	0		110	10	2	140	60	7
17:30-17:45	150	50	2	70	0		80	0		130	50	5
17:45-18:00	70	0		60	0		150	20	2	50	0	
18:00-18:15	130	50	2	40	0		150	30	2	130	60	5
18:15-18:30	110	20	2	50	0		110	10	2	130	30	5
18:30-18:45	150	50	2	60	0		100	0		120	20	7
18:45-19:00	100	0		40	0		100	0		120	20	6

滞留長・渋滞長調査表

調査地点：地域社会6 瀬谷中学校前

調査年月日：令和元年 5月14日(火) 天候:雨のち曇り



滞滯原因凡例	1: 車線減少	2: 信号現示不遵	3: 踏切	4: 橋梁	5: 右折、対向直進	6: 左折車
	7: 大型車	8: 二輪車	9: 歩行者	10: 駐車車両	11: バス停、バスレーン	12: 工事、事故
	13: 沿道出入車両	14: 道路線形	15: 交差点形状	16: 先詰まり	17: その他	

観測時間	方向 a			方向 b			方向 c			方向 d		
	滞留長 (m)	渋滞長 (m)	渋滞原因	滞留長 (m)	渋滞長 (m)	渋滞原因	滞留長 (m)	渋滞長 (m)	渋滞原因	滞留長 (m)	渋滞長 (m)	渋滞原因
19:00-19:15	60	0		50	0		40	0		130	70	5
19:15-19:30	100	0		40	0		100	0		50	0	
19:30-19:45	70	0		60	0		80	0		70	0	
19:45-20:00	50	0		50	0		40	0		60	0	
20:00-20:15	30	0		40	0		100	0		40	0	
20:15-20:30	40	0		40	0		70	0		30	0	
20:30-20:45	60	0		20	0		60	0		50	0	
20:45-21:00	50	0		30	0		40	0		30	0	
21:00-21:15	60	0		20	0		30	0		20	0	
21:15-21:30	50	0		10	0		20	0		10	0	
21:30-21:45	60	0		40	0		30	0		30	0	
21:45-22:00	50	0		20	0		50	0		40	0	
22:00-22:15	80	0		20	0		20	0		20	0	
22:15-22:30	70	0		30	0		30	0		20	0	
22:30-22:45	40	0		20	0		20	0		20	0	
22:45-23:00	30	0		20	0		20	0		30	0	
23:00-23:15	30	0		10	0		10	0		10	0	
23:15-23:30	30	0		20	0		10	0		10	0	
23:30-23:45	50	0		20	0		30	0		10	0	
23:45-24:00	30	0		10	0		10	0		10	0	
0:00-0:15	20	0		10	0		20	0		20	0	
0:15-0:30	20	0		20	0		10	0		20	0	
0:30-0:45	30	0		20	0		10	0		10	0	
0:45-1:00	20	0		10	0		20	0		10	0	
1:00-1:15	10	0		20	0		10	0		10	0	
1:15-1:30	10	0		0	0		30	0		10	0	
1:30-1:45	10	0		10	0		10	0		10	0	
1:45-2:00	10	0		10	0		20	0		10	0	
2:00-2:15	10	0		0	0		20	0		10	0	
2:15-2:30	10	0		0	0		30	0		0	0	
2:30-2:45	10	0		0	0		20	0		10	0	
2:45-3:00	30	0		0	0		10	0		0	0	
3:00-3:15	40	0		0	0		20	0		10	0	
3:15-3:30	20	0		0	0		30	0		20	0	
3:30-3:45	10	0		0	0		40	0		0	0	
3:45-4:00	10	0		10	0		20	0		10	0	
4:00-4:15	10	0		10	0		10	0		10	0	
4:15-4:30	30	0		20	0		20	0		10	0	
4:30-4:45	20	0		10	0		30	0		10	0	
4:45-5:00	30	0		10	0		60	0		10	0	
5:00-5:15	30	0		0	0		70	0		20	0	
5:15-5:30	20	0		0	0		40	0		30	0	
5:30-5:45	10	0		0	0		60	0		20	0	
5:45-6:00	40	0		20	0		50	0		40	0	
6:00-6:15	20	0		10	0		90	0		10	0	
6:15-6:30	40	0		50	0		130	40	2	30	0	
6:30-6:45	70	0		30	0		150	50	2	30	0	
6:45-7:00	50	0		40	0		150	90	2	50	0	

滞留長・渋滞長調査表

調査地点：地域社会1 目黒

調査年月日：令和元年 5月11日(土) 天候：晴れ時々曇り



滞留原因凡例	1：車線減少	2：信号現示不遵	3：踏切	4：橋梁	5：右折、対向直進	6：左折車
	7：大型車	8：二輪車	9：歩行者	10：駐車車両	11：バス停、バスレーン	12：工事、事故
	13：沿道出入車両	14：道路線形	15：交差点形状	16：先詰まり	17：その他	

方向 観測時間	方向 a			方向 b			方向 c			方向 d		
	滞留長 (m)	渋滞長 (m)	渋滞 原因	滞留長 (m)	渋滞長 (m)	渋滞 原因	滞留長 (m)	渋滞長 (m)	渋滞 原因	滞留長 (m)	渋滞長 (m)	渋滞 原因
22:00-22:15	70	0		50	0		30	0		30	0	
22:15-22:30	50	0		40	0		40	0		30	0	
22:30-22:45	40	0		70	0		30	0		30	0	
22:45-23:00	50	0		50	0		40	0		20	0	
23:00-23:15	40	0		50	0		30	0		20	0	
23:15-23:30	30	0		40	0		30	0		10	0	
23:30-23:45	50	0		30	0		50	0		10	0	
23:45-24:00	10	0		30	0		30	0		20	0	
0:00-0:15	30	0		60	0		20	0		20	0	
0:15-0:30	20	0		30	0		20	0		40	0	
0:30-0:45	20	0		40	0		20	0		20	0	
0:45-1:00	20	0		40	0		10	0		20	0	
1:00-1:15	20	0		30	0		20	0		20	0	
1:15-1:30	20	0		40	0		10	0		10	0	
1:30-1:45	10	0		30	0		10	0		10	0	
1:45-2:00	10	0		30	0		10	0		10	0	
2:00-2:15	10	0		20	0		20	0		20	0	
2:15-2:30	10	0		30	0		30	0		10	0	
2:30-2:45	10	0		40	0		10	0		20	0	
2:45-3:00	20	0		50	10	7	20	0		10	0	
3:00-3:15	10	0		50	0		10	0		10	0	
3:15-3:30	10	0		10	0		20	0		20	0	
3:30-3:45	20	0		40	0		10	0		40	0	
3:45-4:00	10	0		20	0		10	0		10	0	
4:00-4:15	20	0		20	0		20	0		10	0	
4:15-4:30	10	0		40	0		10	0		10	0	
4:30-4:45	20	0		30	0		10	0		10	0	
4:45-5:00	10	0		40	20	7	10	0		10	0	
5:00-5:15	20	0		20	0		20	0		20	0	
5:15-5:30	20	0		40	20	7	20	0		20	0	
5:30-5:45	20	0		40	0		40	0		30	0	
5:45-6:00	30	0		30	0		10	0		10	0	
6:00-6:15	20	0		60	0		20	0		10	0	
6:15-6:30	30	0		40	0		20	0		20	0	
6:30-6:45	20	0		50	0		30	0		50	0	
6:45-7:00	30	0		50	0		30	0		10	0	
7:00-7:15	30	0		60	0		50	0		30	0	
7:15-7:30	50	0		70	0		20	0		20	0	
7:30-7:45	50	0		50	0		40	0		50	0	
7:45-8:00	70	0		70	0		30	0		20	0	
8:00-8:15	110	0		60	0		60	0		130	20	2
8:15-8:30	80	0		60	0		40	0		40	0	
8:30-8:45	70	0		60	0		20	0		50	0	
8:45-9:00	80	0		80	0		20	0		60	0	
9:00-9:15	60	0		60	0		30	0		40	0	
9:15-9:30	90	0		50	0		50	0		40	0	
9:30-9:45	100	0		80	0		20	0		100	10	2
9:45-10:00	120	0		90	0		70	0		70	0	

滞留長・渋滞長調査表

調査地点：地域社会1 目黒

調査年月日：令和元年 5月11日(土) 天候：晴れ時々曇り



1：車線減少	2：信号現示不遵	3：踏切	4：橋梁	5：右折、対向直進	6：左折車
7：大型車	8：二輪車	9：歩行者	10：駐車車両	11：バス停、バスレーン	12：工事、事故
13：沿道出入車両	14：道路線形	15：交差点形状	16：先詰まり	17：その他	

方向 観測時間	方向 a			方向 b			方向 c			方向 d		
	滞留長 (m)	渋滞長 (m)	渋滞 原因	滞留長 (m)	渋滞長 (m)	渋滞 原因	滞留長 (m)	渋滞長 (m)	渋滞 原因	滞留長 (m)	渋滞長 (m)	渋滞 原因
10:00-10:15	120	0		70	0		90	0		30	0	
10:15-10:30	150	0		130	70	7	110	0		120	30	2, 5
10:30-10:45	180	0		70	0		70	0		100	10	2, 5
10:45-11:00	150	0		60	0		60	0		100	10	2, 5
11:00-11:15	60	0		70	0		60	0		40	0	
11:15-11:30	90	0		100	0		80	0		50	0	
11:30-11:45	120	0		100	20	7	70	0		110	20	2
11:45-12:00	70	0		90	0		60	0		100	10	2
12:00-12:15	110	0		70	0		40	0		130	80	2, 5, 13
12:15-12:30	120	0		80	0		50	0		100	20	2, 5, 13
12:30-12:45	140	0		60	0		80	0		120	30	2, 5
12:45-13:00	150	20	13	80	0		60	0		100	10	2
13:00-13:15	130	0		50	0		30	0		110	30	2, 5, 13
13:15-13:30	120	0		80	0		30	0		100	20	2, 5, 13
13:30-13:45	100	0		110	20	5	40	0		110	20	2, 5, 13
13:45-14:00	140	20	13	70	0		50	0		120	20	2
14:00-14:15	120	0		50	0		50	0		110	30	2, 5
14:15-14:30	130	0		80	0		60	0		40	0	
14:30-14:45	80	0		50	0		40	0		100	10	2, 5
14:45-15:00	140	0		70	0		30	0		140	40	2, 5
15:00-15:15	80	0		60	0		30	0		100	20	2, 5
15:15-15:30	50	0		70	0		40	0		40	0	
15:30-15:45	50	0		60	0		30	0		30	0	
15:45-16:00	80	0		80	0		90	0		50	0	
16:00-16:15	70	0		50	0		20	0		50	0	
16:15-16:30	100	0		40	0		40	0		50	0	
16:30-16:45	190	0		50	0		40	0		60	0	
16:45-17:00	160	30	7	50	0		20	0		110	20	2, 5
17:00-17:15	130	20	6, 9	60	0		40	0		100	10	2
17:15-17:30	150	0		70	0		30	0		50	0	
17:30-17:45	130	0		90	10	7	20	0		130	100	2, 5, 13
17:45-18:00	80	0		60	0		40	0		150	110	2, 5, 13
18:00-18:15	150	0		60	0		40	0		120	30	2, 5
18:15-18:30	120	0		70	0		30	0		50	0	
18:30-18:45	170	20	5	80	0		50	0		110	10	2, 5
18:45-19:00	80	0		60	0		60	0		120	30	2, 5
19:00-19:15	60	0		50	0		50	0		100	10	2, 5
19:15-19:30	70	0		70	0		80	0		100	10	2, 5
19:30-19:45	150	0		70	0		30	0		100	10	2, 5
19:45-20:00	50	0		50	0		30	0		110	40	2, 5, 13
20:00-20:15	100	0		80	0		20	0		50	0	
20:15-20:30	90	0		70	0		30	0		50	0	
20:30-20:45	60	0		80	0		20	0		100	10	2
20:45-21:00	70	0		80	0		30	0		30	0	
21:00-21:15	90	0		50	0		40	0		50	0	
21:15-21:30	100	0		50	0		30	0		50	0	
21:30-21:45	70	0		40	0		80	0		20	0	
21:45-22:00	70	0		60	10	7	20	0		40	0	

滞留長・渋滞長調査表

調査地点：地域社会2 目黒交番前

調査年月日：令和元年 5月11日(土) 天候：晴れ時々曇り



滞留原因凡例	1：車線減少	2：信号現示不遵	3：踏切	4：橋梁	5：右折、対向直進	6：左折車
	7：大型車	8：二輪車	9：歩行者	10：駐車車両	11：バス停、バスレーン	12：工事、事故
	13：沿道出入車両	14：道路線形	15：交差点形状	16：先詰まり	17：その他	

方向 観測時間	方向 a			方向 b			方向 c			方向 d		
	滞留長 (m)	渋滞長 (m)	渋滞 原因	滞留長 (m)	渋滞長 (m)	渋滞 原因	滞留長 (m)	渋滞長 (m)	渋滞 原因	滞留長 (m)	渋滞長 (m)	渋滞 原因
22:00-22:15	10	0		30	0		10	0		60	0	
22:15-22:30	20	0		30	0		10	0		30	0	
22:30-22:45	20	0		10	0		10	0		30	0	
22:45-23:00	20	0		70	0		10	0		30	0	
23:00-23:15	20	0		20	0		10	0		70	0	
23:15-23:30	10	0		10	0		20	0		70	0	
23:30-23:45	20	0		10	0		10	0		10	0	
23:45-24:00	10	0		20	0		10	0		20	0	
0:00-0:15	10	0		30	0		10	0		30	0	
0:15-0:30	10	0		30	0		10	0		10	0	
0:30-0:45	20	0		20	0		10	0		50	0	
0:45-1:00	10	0		30	0		10	0		40	0	
1:00-1:15	10	0		20	0		20	0		50	0	
1:15-1:30	10	0		20	0		10	0		50	0	
1:30-1:45	10	0		30	0		10	0		20	0	
1:45-2:00	10	0		20	0		10	0		30	0	
2:00-2:15	20	0		10	0		20	0		10	0	
2:15-2:30	10	0		20	0		10	0		10	0	
2:30-2:45	30	0		20	0		10	0		10	0	
2:45-3:00	10	0		20	0		10	0		10	0	
3:00-3:15	10	0		10	0		10	0		60	0	
3:15-3:30	10	0		10	0		10	0		10	0	
3:30-3:45	20	0		10	0		10	0		20	0	
3:45-4:00	10	0		10	0		10	0		10	0	
4:00-4:15	10	0		20	0		10	0		10	0	
4:15-4:30	10	0		10	0		10	0		30	0	
4:30-4:45	10	0		10	0		10	0		20	0	
4:45-5:00	10	0		10	0		20	0		10	0	
5:00-5:15	10	0		10	0		30	0		40	0	
5:15-5:30	10	0		30	0		30	0		20	0	
5:30-5:45	10	0		20	0		20	0		50	0	
5:45-6:00	20	0		60	0		20	0		10	0	
6:00-6:15	10	0		10	0		10	0		10	0	
6:15-6:30	20	0		20	0		10	0		10	0	
6:30-6:45	10	0		20	0		10	0		50	0	
6:45-7:00	20	0		50	0		10	0		30	0	
7:00-7:15	20	0		30	0		20	0		30	0	
7:15-7:30	30	0		20	0		20	0		20	0	
7:30-7:45	30	0		50	0		40	0		30	0	
7:45-8:00	60	30	2,7	40	0		20	0		20	0	
8:00-8:15	40	10	2	50	0		20	0		50	0	
8:15-8:30	50	20	2	50	0		30	0		130	0	
8:30-8:45	60	20	2	60	0		30	0		50	0	
8:45-9:00	70	20	2	40	0		50	0		90	0	
9:00-9:15	30	0		90	0		50	0		60	0	
9:15-9:30	30	0		40	0		40	0		20	0	
9:30-9:45	20	0		40	0		40	0		50	0	
9:45-10:00	60	10	2	30	0		30	0		100	0	

滞留長・渋滞長調査表

調査地点：地域社会2 目黒交番前

調査年月日：令和元年 5月11日(土) 天候：晴れ時々曇り



滞留原因凡例	1：車線減少	2：信号現示不遵	3：踏切	4：橋梁	5：右折、対向直進	6：左折車
	7：大型車	8：二輪車	9：歩行者	10：駐車車両	11：バス停、バスレーン	12：工事、事故
	13：沿道出入車両	14：道路線形	15：交差点形状	16：先詰まり	17：その他	

観測時間	方向 a			方向 b			方向 c			方向 d		
	滞留長 (m)	渋滞長 (m)	渋滞 原因	滞留長 (m)	渋滞長 (m)	渋滞 原因	滞留長 (m)	渋滞長 (m)	渋滞 原因	滞留長 (m)	渋滞長 (m)	渋滞 原因
10:00-10:15	50	0		50	0		40	0		100	0	
10:15-10:30	40	10	2	30	0		50	0		50	0	
10:30-10:45	30	0		30	0		30	0		150	0	
10:45-11:00	30	0		40	0		30	0		70	0	
11:00-11:15	30	0		30	0		40	0		60	0	
11:15-11:30	40	0		30	0		20	0		70	0	
11:30-11:45	50	10	2	40	0		50	0		30	0	
11:45-12:00	60	0		20	0		40	0		50	0	
12:00-12:15	80	20	2	50	0		50	0		20	0	
12:15-12:30	80	0		50	0		60	0		100	0	
12:30-12:45	60	10	2,7	30	0		60	0		40	0	
12:45-13:00	110	60	2,7	40	0		30	0		50	0	
13:00-13:15	110	50	2	30	0		20	0		60	0	
13:15-13:30	40	0		20	0		50	0		40	0	
13:30-13:45	50	0		30	0		50	0		40	0	
13:45-14:00	80	30	2	50	0		30	0		110	0	
14:00-14:15	30	0		20	0		40	0		40	0	
14:15-14:30	50	0		20	0		20	0		50	0	
14:30-14:45	40	0		30	0		40	0		30	0	
14:45-15:00	90	40	2	30	0		20	0		60	0	
15:00-15:15	40	0		20	0		50	0		120	0	
15:15-15:30	60	10	2	60	0		50	0		70	0	
15:30-15:45	70	10	2	20	0		30	0		60	0	
15:45-16:00	60	0		40	0		30	0		10	0	
16:00-16:15	80	0		30	0		40	0		30	0	
16:15-16:30	30	0		20	0		10	0		90	0	
16:30-16:45	40	0		50	0		70	0		70	0	
16:45-17:00	30	0		40	0		30	0		130	0	
17:00-17:15	40	0		30	0		60	0		180	0	
17:15-17:30	70	0		50	0		50	0		200	0	
17:30-17:45	90	0		90	0		40	0		50	0	
17:45-18:00	60	10	2	30	0		60	0		30	0	
18:00-18:15	70	0		80	0		40	0		50	0	
18:15-18:30	50	10	2	80	0		30	0		150	0	
18:30-18:45	40	0		20	0		40	0		70	0	
18:45-19:00	30	0		20	0		70	0		40	0	
19:00-19:15	20	0		60	0		30	0		40	0	
19:15-19:30	40	0		30	0		30	0		160	0	
19:30-19:45	30	0		10	0		20	0		40	0	
19:45-20:00	30	0		20	0		20	0		30	0	
20:00-20:15	30	0		60	0		40	0		20	0	
20:15-20:30	50	0		20	0		20	0		20	0	
20:30-20:45	50	0		10	0		20	0		60	0	
20:45-21:00	20	0		20	0		30	0		30	0	
21:00-21:15	30	0		20	0		40	0		60	0	
21:15-21:30	30	0		30	0		20	0		50	0	
21:30-21:45	30	0		50	0		20	0		20	0	
21:45-22:00	20	0		40	0		30	0		60	0	

滞留長・渋滞長調査表

調査地点：地域社会3 上川井IC

調査年月日：令和元年 5月11日(土) 天候：晴れ時々曇り



渋滞原因凡例	1：車線減少	2：信号現示不遵	3：踏切	4：橋梁	5：右折、対向直進	6：左折車
	7：大型車	8：二輪車	9：歩行者	10：駐車車両	11：バス停、バスレーン	12：工事、事故
	13：沿道出入車両	14：道路線形	15：交差点形状	16：先詰まり	17：その他	

方向 観測時間	方向 a			方向 b			方向 c			方向 d		
	滞留長 (m)	渋滞長 (m)	渋滞 原因	滞留長 (m)	渋滞長 (m)	渋滞 原因	滞留長 (m)	渋滞長 (m)	渋滞 原因	滞留長 (m)	渋滞長 (m)	渋滞 原因
22:00-22:15	10	0		20	0		10	0		10	0	
22:15-22:30	10	0		40	0		10	0		10	0	
22:30-22:45	10	0		20	0		10	0		30	0	
22:45-23:00	10	0		60	0		10	0		20	0	
23:00-23:15	10	0		30	0		10	0		20	0	
23:15-23:30	10	0		40	0		10	0		40	0	
23:30-23:45	10	0		30	0		10	0		10	0	
23:45-24:00	10	0		20	0		10	0		10	0	
0:00-0:15	20	0		40	0		10	0		10	0	
0:15-0:30	10	0		50	0		10	0		10	0	
0:30-0:45	10	0		20	0		10	0		10	0	
0:45-1:00	20	0		40	0		10	0		10	0	
1:00-1:15	10	0		40	0		10	0		10	0	
1:15-1:30	10	0		20	0		10	0		10	0	
1:30-1:45	10	0		10	0		10	0		10	0	
1:45-2:00	10	0		20	0		10	0		10	0	
2:00-2:15	10	0		10	0		10	0		10	0	
2:15-2:30	10	0		30	0		10	0		10	0	
2:30-2:45	10	0		20	0		10	0		20	0	
2:45-3:00	10	0		40	0		10	0		10	0	
3:00-3:15	10	0		30	0		10	0		10	0	
3:15-3:30	10	0		20	0		20	0		10	0	
3:30-3:45	10	0		30	0		10	0		10	0	
3:45-4:00	10	0		20	0		10	0		10	0	
4:00-4:15	10	0		20	0		10	0		20	0	
4:15-4:30	20	0		30	0		20	0		10	0	
4:30-4:45	10	0		20	0		10	0		10	0	
4:45-5:00	10	0		40	0		0	0		10	0	
5:00-5:15	10	0		40	0		10	0		10	0	
5:15-5:30	10	0		20	0		10	0		10	0	
5:30-5:45	10	0		30	0		10	0		20	0	
5:45-6:00	10	0		10	0		10	0		10	0	
6:00-6:15	10	0		30	0		10	0		10	0	
6:15-6:30	10	0		40	0		10	0		10	0	
6:30-6:45	10	0		30	0		10	0		20	0	
6:45-7:00	10	0		60	0		10	0		20	0	
7:00-7:15	10	0		60	0		10	0		30	0	
7:15-7:30	10	0		80	0		10	0		20	0	
7:30-7:45	20	0		110	0		10	0		20	0	
7:45-8:00	10	0		60	0		10	0		10	0	
8:00-8:15	20	0		50	0		30	0		30	0	
8:15-8:30	20	0		80	0		10	0		30	0	
8:30-8:45	20	0		130	0		10	0		10	0	
8:45-9:00	10	0		120	0		20	0		10	0	
9:00-9:15	20	0		110	0		20	0		70	0	
9:15-9:30	20	0		60	0		10	0		40	0	
9:30-9:45	30	0		70	0		20	0		50	0	
9:45-10:00	20	0		70	0		20	0		60	0	

滞留長・渋滞長調査表

調査地点：地域社会3 上川井IC

調査年月日：令和元年 5月11日(土) 天候：晴れ時々曇り



滞滯原因凡例	1: 車線減少	2: 信号現示不遵	3: 踏切	4: 橋梁	5: 右折、対向直進	6: 左折車
	7: 大型車	8: 二輪車	9: 歩行者	10: 駐車車両	11: バス停、バスレーン	12: 工事、事故
	13: 沿道出入車両	14: 道路線形	15: 交差点形状	16: 先詰まり	17: その他	

方向 観測時間	方向 a			方向 b			方向 c			方向 d		
	滞留長 (m)	渋滞長 (m)	渋滞 原因	滞留長 (m)	渋滞長 (m)	渋滞 原因	滞留長 (m)	渋滞長 (m)	渋滞 原因	滞留長 (m)	渋滞長 (m)	渋滞 原因
10:00-10:15	20	0		60	0		50	0		80	20	2
10:15-10:30	10	0		80	0		10	0		60	0	
10:30-10:45	20	0		110	0		60	0		50	0	
10:45-11:00	20	0		90	0		30	0		50	0	
11:00-11:15	10	0		120	0		20	0		60	0	
11:15-11:30	40	0		100	0		30	0		40	0	
11:30-11:45	30	0		130	0		20	0		90	10	2
11:45-12:00	20	0		80	0		20	0		60	0	
12:00-12:15	30	0		60	0		20	0		30	0	
12:15-12:30	40	0		70	0		20	0		70	0	
12:30-12:45	20	0		80	0		50	0		40	0	
12:45-13:00	30	0		80	0		10	0		50	0	
13:00-13:15	40	0		110	0		30	0		60	0	
13:15-13:30	20	0		70	0		20	0		40	0	
13:30-13:45	20	0		80	0		20	0		50	0	
13:45-14:00	10	0		50	0		10	0		60	0	
14:00-14:15	20	0		100	0		20	0		70	0	
14:15-14:30	20	0		110	0		20	0		60	0	
14:30-14:45	40	0		70	0		40	0		40	0	
14:45-15:00	20	0		50	0		10	0		30	0	
15:00-15:15	30	0		40	0		20	0		50	0	
15:15-15:30	30	0		50	0		30	0		40	0	
15:30-15:45	20	0		80	0		30	0		70	0	
15:45-16:00	10	0		50	0		10	0		30	0	
16:00-16:15	30	0		100	0		20	0		40	0	
16:15-16:30	20	0		70	0		40	0		50	0	
16:30-16:45	30	0		80	0		30	0		30	0	
16:45-17:00	30	0		70	0		20	0		30	0	
17:00-17:15	30	0		100	0		20	0		50	0	
17:15-17:30	40	0		90	0		20	0		30	0	
17:30-17:45	30	0		100	0		60	0		50	0	
17:45-18:00	20	0		90	0		40	0		30	0	
18:00-18:15	30	0		80	0		10	0		40	0	
18:15-18:30	20	0		120	0		40	0		50	0	
18:30-18:45	20	0		90	0		20	0		30	0	
18:45-19:00	20	0		100	0		10	0		30	0	
19:00-19:15	20	0		70	0		20	0		30	0	
19:15-19:30	30	0		90	0		10	0		50	0	
19:30-19:45	30	0		70	0		10	0		40	0	
19:45-20:00	20	0		80	0		10	0		20	0	
20:00-20:15	20	0		70	0		10	0		20	0	
20:15-20:30	20	0		40	0		20	0		20	0	
20:30-20:45	10	0		40	0		20	0		40	0	
20:45-21:00	10	0		30	0		30	0		10	0	
21:00-21:15	20	0		30	0		10	0		10	0	
21:15-21:30	10	0		70	0		20	0		10	0	
21:30-21:45	10	0		20	0		10	0		10	0	
21:45-22:00	10	0		50	0		10	0		10	0	

滞留長・渋滞長調査表

調査地点：地域社会4 滝沢

調査年月日：令和 2年 9月26日(土) 天候：晴れ一時雨



渋滞原因凡例	1：車線減少	2：信号現示不遵	3：踏切	4：橋梁	5：右折、対向直進	6：左折車
	7：大型車	8：二輪車	9：歩行者	10：駐車車両	11：バス停、バスレーン	12：工事、事故
	13：沿道出入車両	14：道路線形	15：交差点形状	16：先詰まり	17：その他	

方向 観測時間	方向 a			方向 b			方向 c			滞留長 (m)	渋滞長 (m)	渋滞 原因
	滞留長 (m)	渋滞長 (m)	渋滞 原因	滞留長 (m)	渋滞長 (m)	渋滞 原因	滞留長 (m)	渋滞長 (m)	渋滞 原因			
22:00-22:15	10	0		20	0		20	0				
22:15-22:30	10	0		10	0		10	0				
22:30-22:45	10	0		30	0		20	0				
22:45-23:00	10	0		10	0		10	0				
23:00-23:15	10	0		20	0		10	0				
23:15-23:30	10	0		0	0		20	0				
23:30-23:45	10	0		0	0		10	0				
23:45-24:00	10	0		10	0		10	0				
0:00-0:15	10	0		20	0		10	0				
0:15-0:30	10	0		20	0		20	0				
0:30-0:45	10	0		40	0		20	0				
0:45-1:00	10	0		20	0		20	0				
1:00-1:15	10	0		10	0		10	0				
1:15-1:30	10	0		10	0		10	0				
1:30-1:45	10	0		20	0		10	0				
1:45-2:00	10	0		20	0		20	0				
2:00-2:15	10	0		10	0		10	0				
2:15-2:30	10	0		10	0		20	0				
2:30-2:45	10	0		20	0		10	0				
2:45-3:00	10	0		10	0		10	0				
3:00-3:15	10	0		10	0		10	0				
3:15-3:30	10	0		10	0		10	0				
3:30-3:45	10	0		10	0		10	0				
3:45-4:00	10	0		10	0		10	0				
4:00-4:15	10	0		10	0		10	0				
4:15-4:30	10	0		0	0		10	0				
4:30-4:45	20	0		10	0		10	0				
4:45-5:00	10	0		10	0		20	0				
5:00-5:15	10	0		10	0		10	0				
5:15-5:30	10	0		10	0		20	0				
5:30-5:45	30	0		10	0		20	0				
5:45-6:00	10	0		20	0		10	0				
6:00-6:15	10	0		10	0		10	0				
6:15-6:30	10	0		10	0		20	0				
6:30-6:45	10	0		10	0		10	0				
6:45-7:00	10	0		10	0		20	0				
7:00-7:15	10	0		20	0		10	0				
7:15-7:30	20	0		20	0		30	0				
7:30-7:45	40	0		30	0		50	0				
7:45-8:00	50	0		20	0		40	0				
8:00-8:15	10	0		30	0		20	0				
8:15-8:30	10	0		50	0		40	0				
8:30-8:45	20	0		90	0		30	0				
8:45-9:00	20	0		30	0		70	0				
9:00-9:15	10	0		60	0		60	0				
9:15-9:30	20	0		40	0		20	0				
9:30-9:45	10	0		30	0		50	0				
9:45-10:00	30	0		40	0		20	0				

滞留長・渋滞長調査表

調査地点：地域社会4 滝沢

調査年月日：令和 2年 9月26日(土) 天候：晴れ一時雨



渋滞原因凡例	1：車線減少	2：信号現示不遵	3：踏切	4：橋梁	5：右折、対向直進	6：左折車
	7：大型車	8：二輪車	9：歩行者	10：駐車車両	11：バス停、バスレーン	12：工事、事故
	13：沿道出入車両	14：道路線形	15：交差点形状	16：先詰まり	17：その他	

観測時間	方向 a			方向 b			方向 c			滞留長 (m)	渋滞長 (m)	渋滞原因
	滞留長 (m)	渋滞長 (m)	渋滞原因	滞留長 (m)	渋滞長 (m)	渋滞原因	滞留長 (m)	渋滞長 (m)	渋滞原因			
10:00-10:15	10	0		60	0		60	0				
10:15-10:30	30	0		90	0		20	0				
10:30-10:45	20	0		70	0		40	0				
10:45-11:00	30	0		80	0		30	0				
11:00-11:15	40	0		70	0		30	0				
11:15-11:30	30	0		80	0		30	0				
11:30-11:45	30	0		70	0		40	0				
11:45-12:00	30	0		80	0		50	0				
12:00-12:15	30	0		40	0		50	0				
12:15-12:30	20	0		60	0		50	0				
12:30-12:45	20	0		70	0		60	0				
12:45-13:00	10	0		30	0		50	0				
13:00-13:15	30	0		90	0		50	0				
13:15-13:30	20	0		60	0		30	0				
13:30-13:45	40	0		110	0		60	0				
13:45-14:00	50	0		60	0		40	0				
14:00-14:15	30	0		60	0		80	0				
14:15-14:30	10	0		50	0		30	0				
14:30-14:45	30	0		40	0		40	0				
14:45-15:00	10	0		30	0		30	0				
15:00-15:15	20	0		90	0		40	0				
15:15-15:30	20	0		40	0		100	0				
15:30-15:45	20	0		40	0		60	0				
15:45-16:00	20	0		30	0		40	0				
16:00-16:15	50	0		40	0		40	0				
16:15-16:30	20	0		70	0		90	0				
16:30-16:45	40	0		60	0		60	0				
16:45-17:00	20	0		80	0		40	0				
17:00-17:15	20	0		50	0		80	0				
17:15-17:30	20	0		80	0		50	0				
17:30-17:45	10	0		70	0		40	0				
17:45-18:00	10	0		90	0		40	0				
18:00-18:15	10	0		30	0		70	0				
18:15-18:30	10	0		90	0		50	0				
18:30-18:45	20	0		30	0		40	0				
18:45-19:00	20	0		20	0		50	0				
19:00-19:15	40	0		40	0		70	0				
19:15-19:30	10	0		40	0		60	0				
19:30-19:45	20	0		70	0		50	0				
19:45-20:00	10	0		40	0		30	0				
20:00-20:15	30	0		40	0		40	0				
20:15-20:30	10	0		20	0		20	0				
20:30-20:45	30	0		20	0		40	0				
20:45-21:00	10	0		20	0		10	0				
21:00-21:15	20	0		20	0		60	0				
21:15-21:30	10	0		20	0		20	0				
21:30-21:45	10	0		10	0		20	0				
21:45-22:00	10	0		10	0		10	0				

滞留長・渋滞長調査表

調査地点：地域社会4 瀬谷土橋公園入口

調査年月日：令和 2年 9月26日(土) 天候：晴れ一時雨



渋滞原因凡例	1：車線減少	2：信号現示不遵	3：踏切	4：橋梁	5：右折、対向直進	6：左折車
	7：大型車	8：二輪車	9：歩行者	10：駐車車両	11：バス停、バスレーン	12：工事、事故
	13：沿道出入車両	14：道路線形	15：交差点形状	16：先詰まり	17：その他	

方向 観測時間	方向 a			方向 b			方向 c			滞留長 (m)	渋滞長 (m)	渋滞原因
	滞留長 (m)	渋滞長 (m)	渋滞原因	滞留長 (m)	渋滞長 (m)	渋滞原因	滞留長 (m)	渋滞長 (m)	渋滞原因			
22:00-22:15	30	0		20	0		10	0				
22:15-22:30	20	0		50	0		20	0				
22:30-22:45	20	0		10	0		10	0				
22:45-23:00	30	0		10	0		20	0				
23:00-23:15	10	0		10	0		10	0				
23:15-23:30	40	0		10	0		10	0				
23:30-23:45	30	0		10	0		10	0				
23:45-24:00	30	0		10	0		10	0				
0:00-0:15	30	0		20	0		10	0				
0:15-0:30	20	0		20	0		10	0				
0:30-0:45	30	0		10	0		10	0				
0:45-1:00	20	0		10	0		10	0				
1:00-1:15	10	0		10	0		20	0				
1:15-1:30	20	0		10	0		10	0				
1:30-1:45	20	0		10	0		10	0				
1:45-2:00	30	0		10	0		10	0				
2:00-2:15	10	0		10	0		10	0				
2:15-2:30	20	0		10	0		10	0				
2:30-2:45	20	0		10	0		20	0				
2:45-3:00	10	0		10	0		10	0				
3:00-3:15	10	0		10	0		10	0				
3:15-3:30	10	0		10	0		10	0				
3:30-3:45	10	0		10	0		10	0				
3:45-4:00	10	0		10	0		10	0				
4:00-4:15	10	0		10	0		10	0				
4:15-4:30	20	0		10	0		10	0				
4:30-4:45	10	0		10	0		10	0				
4:45-5:00	10	0		10	0		10	0				
5:00-5:15	10	0		20	0		10	0				
5:15-5:30	10	0		20	0		10	0				
5:30-5:45	10	0		10	0		10	0				
5:45-6:00	20	0		10	0		10	0				
6:00-6:15	20	0		10	0		20	0				
6:15-6:30	30	0		20	0		20	0				
6:30-6:45	40	0		20	0		20	0				
6:45-7:00	30	0		20	0		10	0				
7:00-7:15	50	0		10	0		20	0				
7:15-7:30	50	0		30	0		50	0				
7:30-7:45	30	0		20	0		40	0				
7:45-8:00	30	0		50	10	5	50	0				
8:00-8:15	40	0		80	0		20	0				
8:15-8:30	30	0		100	0		50	0				
8:30-8:45	60	0		50	0		80	0				
8:45-9:00	20	0		20	0		20	0				
9:00-9:15	20	0		80	50	5.7	20	0				
9:15-9:30	30	0		70	0		30	0				
9:30-9:45	50	0		70	0		20	0				
9:45-10:00	50	0		60	0		60	0				

滞留長・渋滞長調査表

調査地点：地域社会4 瀬谷土橋公園入口

調査年月日：令和 2年 9月26日(土) 天候：晴れ一時雨



渋滞原因凡例	1：車線減少	2：信号現示不遵	3：踏切	4：橋梁	5：右折、対向直進	6：左折車
	7：大型車	8：二輪車	9：歩行者	10：駐車車両	11：バス停、バスレーン	12：工事、事故
	13：沿道出入車両	14：道路線形	15：交差点形状	16：先詰まり	17：その他	

方向 観測時間	方向 a			方向 b			方向 c			滞留長 (m)	渋滞長 (m)	渋滞 原因
	滞留長 (m)	渋滞長 (m)	渋滞 原因	滞留長 (m)	渋滞長 (m)	渋滞 原因	滞留長 (m)	渋滞長 (m)	渋滞 原因			
10:00-10:15	50	0		50	0		30	0				
10:15-10:30	30	0		50	0		30	0				
10:30-10:45	40	0		50	0		20	0				
10:45-11:00	50	0		30	0		30	0				
11:00-11:15	50	0		40	0		20	0				
11:15-11:30	50	0		40	0		20	0				
11:30-11:45	30	0		40	0		50	0				
11:45-12:00	30	0		50	0		40	0				
12:00-12:15	40	0		30	0		60	0				
12:15-12:30	60	0		20	0		50	0				
12:30-12:45	60	0		20	0		60	0				
12:45-13:00	70	0		50	0		40	0				
13:00-13:15	50	0		30	0		60	0				
13:15-13:30	60	0		50	0		50	0				
13:30-13:45	60	0		30	0		60	0				
13:45-14:00	50	0		50	0		60	0				
14:00-14:15	60	0		40	0		20	0				
14:15-14:30	70	0		50	0		70	0				
14:30-14:45	30	0		10	0		20	0				
14:45-15:00	50	0		40	0		20	0				
15:00-15:15	30	0		30	0		10	0				
15:15-15:30	40	0		60	0		70	0				
15:30-15:45	50	0		30	0		30	0				
15:45-16:00	40	0		50	0		60	0				
16:00-16:15	50	0		50	0		50	0				
16:15-16:30	100	0		50	0		30	0				
16:30-16:45	80	0		20	0		30	0				
16:45-17:00	50	0		30	0		80	0				
17:00-17:15	50	0		100	0		60	0				
17:15-17:30	30	0		50	0		30	0				
17:30-17:45	40	0		20	0		20	0				
17:45-18:00	50	0		70	0		10	0				
18:00-18:15	60	0		20	0		30	0				
18:15-18:30	40	0		30	0		60	0				
18:30-18:45	40	0		20	0		30	0				
18:45-19:00	30	0		10	0		20	0				
19:00-19:15	60	0		30	0		20	0				
19:15-19:30	30	0		20	0		20	0				
19:30-19:45	40	0		40	0		10	0				
19:45-20:00	40	0		10	0		10	0				
20:00-20:15	40	0		10	0		40	0				
20:15-20:30	20	0		10	0		20	0				
20:30-20:45	40	0		30	0		20	0				
20:45-21:00	60	0		40	0		10	0				
21:00-21:15	50	0		10	0		30	0				
21:15-21:30	50	0		20	0		20	0				
21:30-21:45	40	0		10	0		20	0				
21:45-22:00	50	0		10	0		10	0				

滞留長・渋滞長調査表

調査地点：地域社会5

調査年月日：令和元年 5月11日(土) 天候：晴れ時々曇り



渋滞原因凡例	1：車線減少	2：信号現示不遵	3：踏切	4：橋梁	5：右折、対向直進	6：左折車
	7：大型車	8：二輪車	9：歩行者	10：駐車車両	11：バス停、バスレーン	12：工事、事故
	13：沿道出入車両	14：道路線形	15：交差点形状	16：先詰まり	17：その他	

観測時間	方向 a			方向 b			方向 c			滞留長 (m)	渋滞長 (m)	渋滞原因
	滞留長 (m)	渋滞長 (m)	渋滞原因	滞留長 (m)	渋滞長 (m)	渋滞原因	滞留長 (m)	渋滞長 (m)	渋滞原因			
22:00-22:15	70	0		30	0		10	0				
22:15-22:30	60	0		50	0		10	0				
22:30-22:45	50	0		40	10	5	30	0				
22:45-23:00	60	0		40	0		10	0				
23:00-23:15	50	0		30	0		20	0				
23:15-23:30	40	0		30	0		10	0				
23:30-23:45	30	0		40	0		10	0				
23:45-24:00	40	0		20	0		20	0				
0:00-0:15	40	0		30	0		10	0				
0:15-0:30	40	0		20	0		10	0				
0:30-0:45	30	0		20	0		10	0				
0:45-1:00	40	0		10	0		10	0				
1:00-1:15	30	0		10	0		10	0				
1:15-1:30	20	0		10	0		10	0				
1:30-1:45	20	0		10	0		10	0				
1:45-2:00	10	0		10	0		30	0				
2:00-2:15	30	0		30	0		10	0				
2:15-2:30	20	0		10	0		10	0				
2:30-2:45	30	0		20	0		20	0				
2:45-3:00	30	0		20	0		10	0				
3:00-3:15	30	0		10	0		10	0				
3:15-3:30	20	0		10	0		10	0				
3:30-3:45	30	0		30	0		0	0				
3:45-4:00	20	0		10	0		10	0				
4:00-4:15	20	0		10	0		10	0				
4:15-4:30	20	0		10	0		10	0				
4:30-4:45	10	0		10	0		10	0				
4:45-5:00	10	0		10	0		10	0				
5:00-5:15	10	0		10	0		10	0				
5:15-5:30	20	0		30	0		10	0				
5:30-5:45	30	0		10	0		10	0				
5:45-6:00	40	0		50	0		10	0				
6:00-6:15	30	0		20	0		10	0				
6:15-6:30	40	0		30	0		20	0				
6:30-6:45	60	0		60	0		20	0				
6:45-7:00	30	0		60	0		30	0				
7:00-7:15	60	0		70	0		40	0				
7:15-7:30	50	0		110	30	13	40	0				
7:30-7:45	60	0		60	0		50	0				
7:45-8:00	60	0		70	0		30	0				
8:00-8:15	50	0		60	0		30	0				
8:15-8:30	60	0		50	0		20	0				
8:30-8:45	50	0		50	0		20	0				
8:45-9:00	60	0		30	0		30	0				
9:00-9:15	60	0		50	0		30	0				
9:15-9:30	50	0		40	0		40	0				
9:30-9:45	70	0		30	0		20	0				
9:45-10:00	70	0		40	0		40	0				

滞留長・渋滞長調査表

調査地点：地域社会5

調査年月日：令和元年 5月11日(土) 天候：晴れ時々曇り



渋滞原因凡例	1：車線減少	2：信号現示不遵	3：踏切	4：橋梁	5：右折、対向直進	6：左折車
	7：大型車	8：二輪車	9：歩行者	10：駐車車両	11：バス停、バスレーン	12：工事、事故
	13：沿道出入車両	14：道路線形	15：交差点形状	16：先詰まり	17：その他	

観測時間	方向 a			方向 b			方向 c			滞留長 (m)	渋滞長 (m)	渋滞原因
	滞留長 (m)	渋滞長 (m)	渋滞原因	滞留長 (m)	渋滞長 (m)	渋滞原因	滞留長 (m)	渋滞長 (m)	渋滞原因			
10:00-10:15	40	0		70	0		90	30	2			
10:15-10:30	60	0		170	70	5.13	140	70	2			
10:30-10:45	100	10	6	70	0		50	0				
10:45-11:00	180	60	6	60	0		50	0				
11:00-11:15	110	0		150	100	5	50	0				
11:15-11:30	120	30	6	60	0		60	0				
11:30-11:45	80	0		100	0		50	0				
11:45-12:00	100	0		70	0		120	50	2			
12:00-12:15	100	0		100	40	5	60	0				
12:15-12:30	120	30	6	170	100	5	70	10	2			
12:30-12:45	80	0		120	0		40	0				
12:45-13:00	60	0		120	0		30	0				
13:00-13:15	60	0		80	0		70	10	2			
13:15-13:30	80	0		70	0		30	0				
13:30-13:45	120	30	6	100	0		50	0				
13:45-14:00	80	0		50	0		40	0				
14:00-14:15	100	0		120	40	5	40	0				
14:15-14:30	50	0		70	0		40	0				
14:30-14:45	60	0		60	0		30	0				
14:45-15:00	160	40	6	100	0		40	0				
15:00-15:15	150	20	6	70	0		40	0				
15:15-15:30	60	0		60	0		50	0				
15:30-15:45	100	0		70	0		40	0				
15:45-16:00	140	30	6	80	0		20	0				
16:00-16:15	100	0		20	0		30	0				
16:15-16:30	60	0		40	0		20	0				
16:30-16:45	80	0		40	0		40	0				
16:45-17:00	100	0		30	0		150	70	2			
17:00-17:15	90	0		30	0		40	0				
17:15-17:30	140	40	6	160	30	13	70	10	2			
17:30-17:45	120	30	6	80	0		50	0				
17:45-18:00	100	0		110	0		40	0				
18:00-18:15	110	20	6	70	0		40	0				
18:15-18:30	100	0		100	0		50	0				
18:30-18:45	120	10	13	50	0		30	0				
18:45-19:00	90	0		60	0		30	0				
19:00-19:15	80	0		50	0		10	0				
19:15-19:30	80	0		40	0		20	0				
19:30-19:45	120	30	13	50	0		20	0				
19:45-20:00	90	0		30	0		20	0				
20:00-20:15	50	0		70	0		20	0				
20:15-20:30	30	0		20	0		10	0				
20:30-20:45	50	0		40	0		20	0				
20:45-21:00	70	0		50	0		30	0				
21:00-21:15	70	0		30	0		10	0				
21:15-21:30	40	0		30	0		10	0				
21:30-21:45	60	0		40	0		30	0				
21:45-22:00	10	0		30	0		10	0				

滞留長・渋滞長調査表

調査地点：地域社会6 瀬谷中学校前

調査年月日：令和元年 5月11日(土) 天候：晴れ時々曇り



滞滯原因凡例	1：車線減少	2：信号現示不遵	3：踏切	4：橋梁	5：右折、対向直進	6：左折車
	7：大型車	8：二輪車	9：歩行者	10：駐車車両	11：バス停、バスレーン	12：工事、事故
	13：沿道出入車両	14：道路線形	15：交差点形状	16：先詰まり	17：その他	

方向 観測時間	方向 a			方向 b			方向 c			方向 d		
	滞留長 (m)	渋滞長 (m)	渋滞 原因	滞留長 (m)	渋滞長 (m)	渋滞 原因	滞留長 (m)	渋滞長 (m)	渋滞 原因	滞留長 (m)	渋滞長 (m)	渋滞 原因
22:00-22:15	30	0		20	0		30	0		10	0	
22:15-22:30	60	0		10	0		30	0		20	0	
22:30-22:45	50	0		10	0		20	0		30	0	
22:45-23:00	20	0		20	0		10	0		10	0	
23:00-23:15	40	0		20	0		30	0		20	0	
23:15-23:30	40	0		10	0		20	0		10	0	
23:30-23:45	50	0		10	0		10	0		10	0	
23:45-24:00	50	0		20	0		10	0		10	0	
0:00-0:15	40	0		30	0		20	0		10	0	
0:15-0:30	40	0		20	0		10	0		10	0	
0:30-0:45	60	0		40	0		30	0		10	0	
0:45-1:00	40	0		10	0		30	0		20	0	
1:00-1:15	20	0		10	0		10	0		10	0	
1:15-1:30	10	0		0	0		40	0		20	0	
1:30-1:45	10	0		0	0		10	0		10	0	
1:45-2:00	10	0		0	0		10	0		10	0	
2:00-2:15	10	0		10	0		20	0		10	0	
2:15-2:30	10	0		0	0		10	0		10	0	
2:30-2:45	20	0		10	0		20	0		10	0	
2:45-3:00	10	0		0	0		10	0		10	0	
3:00-3:15	20	0		0	0		20	0		10	0	
3:15-3:30	20	0		10	0		10	0		20	0	
3:30-3:45	10	0		0	0		10	0		10	0	
3:45-4:00	20	0		10	0		10	0		10	0	
4:00-4:15	30	0		10	0		10	0		10	0	
4:15-4:30	20	0		10	0		10	0		10	0	
4:30-4:45	10	0		0	0		10	0		10	0	
4:45-5:00	10	0		10	0		10	0		10	0	
5:00-5:15	10	0		0	0		20	0		10	0	
5:15-5:30	20	0		20	0		20	0		10	0	
5:30-5:45	50	0		20	0		20	0		10	0	
5:45-6:00	50	0		30	0		30	0		10	0	
6:00-6:15	50	0		10	0		20	0		10	0	
6:15-6:30	50	0		10	0		30	0		10	0	
6:30-6:45	90	0		20	0		40	0		10	0	
6:45-7:00	50	0		20	0		40	0		10	0	
7:00-7:15	40	0		20	0		80	0		20	0	
7:15-7:30	30	0		10	0		40	0		20	0	
7:30-7:45	20	0		10	0		60	0		40	0	
7:45-8:00	40	0		50	0		60	0		20	0	
8:00-8:15	50	0		20	0		90	0		30	0	
8:15-8:30	60	0		30	0		80	0		30	0	
8:30-8:45	50	0		20	0		120	20	2	30	0	
8:45-9:00	50	0		30	0		70	0		60	0	
9:00-9:15	100	0		40	0		70	0		80	0	
9:15-9:30	90	0		50	0		50	0		50	0	
9:30-9:45	40	0		40	0		90	10	2	90	30	13
9:45-10:00	50	0		50	0		80	0		130	30	6

滞留長・渋滞長調査表

調査地点：地域社会6 瀬谷中学校前

調査年月日：令和元年 5月11日(土) 天候：晴れ時々曇り



滞滯原因凡例	1：車線減少	2：信号現示不遵	3：踏切	4：橋梁	5：右折、対向直進	6：左折車
	7：大型車	8：二輪車	9：歩行者	10：駐車車両	11：バス停、バスレーン	12：工事、事故
	13：沿道出入車両	14：道路線形	15：交差点形状	16：先詰まり	17：その他	

方向 観測時間	方向 a			方向 b			方向 c			方向 d		
	滞留長 (m)	渋滞長 (m)	渋滞 原因	滞留長 (m)	渋滞長 (m)	渋滞 原因	滞留長 (m)	渋滞長 (m)	渋滞 原因	滞留長 (m)	渋滞長 (m)	渋滞 原因
10:00-10:15	100	0		70	0		50	0		80	10	13
10:15-10:30	120	10	2	60	0		50	0		80	0	
10:30-10:45	90	0		70	0		80	0		90	0	
10:45-11:00	130	10	2	30	0		70	0		80	0	
11:00-11:15	80	0		80	0		110	0		100	20	13
11:15-11:30	90	0		60	0		100	0		80	30	6
11:30-11:45	50	0		30	0		100	0		130	30	6
11:45-12:00	40	0		70	0		100	30	2	110	30	13
12:00-12:15	50	0		110	0		120	20	2	80	0	
12:15-12:30	70	0		50	0		100	10	2	70	0	
12:30-12:45	70	0		60	0		100	10	2	100	30	6
12:45-13:00	50	0		40	0		100	0		100	10	13
13:00-13:15	60	0		30	0		110	0		130	40	13
13:15-13:30	50	0		30	0		130	20	2	100	20	13
13:30-13:45	50	0		40	0		110	10	2	90	0	
13:45-14:00	100	0		50	0		100	0		60	0	
14:00-14:15	60	0		40	0		60	0		120	40	6
14:15-14:30	50	0		40	0		100	10	2	110	30	6
14:30-14:45	40	0		40	0		100	0		130	30	6
14:45-15:00	150	20	2	30	0		70	0		110	40	6
15:00-15:15	80	0		50	0		120	10	2	100	0	
15:15-15:30	120	0		50	0		130	40	2	60	0	
15:30-15:45	110	10	2	50	0		110	10	2	60	0	
15:45-16:00	100	0		60	0		50	0		40	0	
16:00-16:15	100	0		50	0		50	0		50	0	
16:15-16:30	80	0		50	0		110	0		120	50	6, 13
16:30-16:45	90	0		80	30	5	100	0		120	20	7, 13
16:45-17:00	100	10	2	40	0		50	0		70	0	
17:00-17:15	60	0		60	0		100	0		110	30	13
17:15-17:30	70	0		50	0		150	30	2	180	40	6
17:30-17:45	50	0		90	0		90	0		80	0	
17:45-18:00	40	0		80	0		100	0		80	0	
18:00-18:15	30	0		90	0		90	0		70	0	
18:15-18:30	100	0		40	0		120	20	2	60	0	
18:30-18:45	80	0		70	0		100	0		120	20	13
18:45-19:00	60	0		30	0		80	0		100	20	6
19:00-19:15	50	0		40	0		90	0		20	0	
19:15-19:30	80	0		40	0		80	0		20	0	
19:30-19:45	100	0		40	0		60	0		30	0	
19:45-20:00	70	0		40	0		50	0		30	0	
20:00-20:15	60	0		30	0		20	0		50	0	
20:15-20:30	50	0		30	0		50	0		50	0	
20:30-20:45	40	0		30	0		30	0		20	0	
20:45-21:00	70	0		20	0		30	0		40	0	
21:00-21:15	60	0		20	0		70	0		20	0	
21:15-21:30	60	0		20	0		20	0		10	0	
21:30-21:45	50	0		20	0		30	0		20	0	
21:45-22:00	30	0		20	0		50	0		10	0	

滞留長・渋滞長調査表

調査地点：地域社会1 目黒

調査年月日：令和元年10月13日(日) 天候：曇りのち雨



滞留原因凡例	1：車線減少	2：信号現示不遵	3：踏切	4：橋梁	5：右折、対向直進	6：左折車
	7：大型車	8：二輪車	9：歩行者	10：駐車車両	11：バス停、バスレーン	12：工事、事故
	13：沿道出入車両	14：道路線形	15：交差点形状	16：先詰まり	17：その他	

方向 観測時間	方向 a			方向 b			方向 c			方向 d		
	滞留長 (m)	渋滞長 (m)	渋滞 原因	滞留長 (m)	渋滞長 (m)	渋滞 原因	滞留長 (m)	渋滞長 (m)	渋滞 原因	滞留長 (m)	渋滞長 (m)	渋滞 原因
22:00-22:15	20	0		40	0		10	0		30	0	
22:15-22:30	20	0		20	0		10	0		40	0	
22:30-22:45	20	0		20	0		10	0		30	0	
22:45-23:00	30	0		40	0		10	0		40	0	
23:00-23:15	40	0		40	0		10	0		20	0	
23:15-23:30	40	0		20	0		10	0		30	0	
23:30-23:45	20	0		30	0		10	0		40	0	
23:45-24:00	10	0		20	0		30	0		40	0	
0:00-0:15	10	0		20	0		30	0		30	0	
0:15-0:30	30	0		20	0		20	0		30	0	
0:30-0:45	20	0		30	0		30	0		40	0	
0:45-1:00	20	0		20	0		20	0		30	0	
1:00-1:15	20	0		30	0		20	0		30	0	
1:15-1:30	20	0		30	0		20	0		30	0	
1:30-1:45	10	0		40	0		10	0		20	0	
1:45-2:00	10	0		20	0		20	0		10	0	
2:00-2:15	10	0		40	0		10	0		10	0	
2:15-2:30	10	0		30	0		30	0		30	0	
2:30-2:45	10	0		20	0		20	0		20	0	
2:45-3:00	30	0		20	0		10	0		20	0	
3:00-3:15	20	0		20	0		10	0		20	0	
3:15-3:30	20	0		30	0		10	0		20	0	
3:30-3:45	20	0		30	0		30	0		30	0	
3:45-4:00	10	0		30	0		40	0		20	0	
4:00-4:15	20	0		30	0		20	0		20	0	
4:15-4:30	10	0		40	0		20	0		20	0	
4:30-4:45	20	0		30	0		30	0		20	0	
4:45-5:00	20	0		20	0		20	0		30	0	
5:00-5:15	40	0		40	0		20	0		40	0	
5:15-5:30	60	0		50	0		20	0		30	0	
5:30-5:45	50	0		100	20	5	40	0		40	0	
5:45-6:00	50	0		50	0		40	0		30	0	
6:00-6:15	40	0		50	0		30	0		50	0	
6:15-6:30	60	0		70	0		50	0		40	0	
6:30-6:45	110	0		90	0		60	0		40	0	
6:45-7:00	60	0		70	0		70	0		40	0	
7:00-7:15	70	0		100	20	5,7	60	0		50	0	
7:15-7:30	140	0		70	0		30	0		40	0	
7:30-7:45	150	0		60	0		70	0		100	20	5
7:45-8:00	80	0		50	0		100	0		60	0	
8:00-8:15	90	0		70	0		70	0		40	0	
8:15-8:30	100	0		80	0		130	0		60	0	
8:30-8:45	110	0		60	0		80	0		60	0	
8:45-9:00	80	0		50	0		60	0		60	0	
9:00-9:15	70	0		70	0		40	0		70	0	
9:15-9:30	60	0		60	0		130	0		30	0	
9:30-9:45	80	0		70	0		70	0		50	0	
9:45-10:00	100	0		50	0		100	0		60	0	

滞留長・渋滞長調査表

調査地点：地域社会1 目黒

調査年月日：令和元年10月13日(日) 天候：曇りのち雨



1: 車線減少	2: 信号現示不遵	3: 踏切	4: 橋梁	5: 右折、対向直進	6: 左折車
7: 大型車	8: 二輪車	9: 歩行者	10: 駐車車両	11: バス停、バスレーン	12: 工事、事故
13: 沿道出入車両	14: 道路線形	15: 交差点形状	16: 先詰まり	17: その他	

観測時間	方向 a			方向 b			方向 c			方向 d		
	滞留長 (m)	渋滞長 (m)	渋滞 原因	滞留長 (m)	渋滞長 (m)	渋滞 原因	滞留長 (m)	渋滞長 (m)	渋滞 原因	滞留長 (m)	渋滞長 (m)	渋滞 原因
10:00-10:15	80	0		60	0		60	0		80	0	
10:15-10:30	70	0		80	0		80	0		60	0	
10:30-10:45	70	0		50	0		80	0		50	0	
10:45-11:00	110	0		60	0		70	0		70	0	
11:00-11:15	80	0		80	0		80	0		70	0	
11:15-11:30	80	0		50	0		90	0		60	0	
11:30-11:45	70	0		60	0		60	0		80	0	
11:45-12:00	120	0		70	0		90	0		90	0	
12:00-12:15	150	0		90	0		120	20	6, 16	100	0	
12:15-12:30	250	0		60	0		100	0		100	0	
12:30-12:45	360	30	7	60	0		70	0		80	0	
12:45-13:00	350	30	7	50	0		80	0		70	0	
13:00-13:15	280	0		70	0		100	0		250	200	5, 16
13:15-13:30	190	0		70	0		60	0		260	210	5, 16
13:30-13:45	200	0		80	0		100	0		120	30	5, 16
13:45-14:00	100	0		90	0		120	0		120	30	5, 16
14:00-14:15	100	0		80	0		100	0		80	0	
14:15-14:30	110	0		70	0		100	0		60	0	
14:30-14:45	130	0		90	0		100	0		80	0	
14:45-15:00	90	0		60	0		80	0		100	20	5, 16
15:00-15:15	110	0		90	0		60	0		80	0	
15:15-15:30	100	0		80	0		50	0		70	0	
15:30-15:45	90	0		60	0		60	0		60	0	
15:45-16:00	80	0		70	0		80	0		70	0	
16:00-16:15	240	0		60	0		70	0		80	0	
16:15-16:30	380	30	13, 16	60	0		100	0		80	0	
16:30-16:45	220	0		70	0		100	0		90	20	5, 7
16:45-17:00	400	50	13, 16	80	0		70	0		80	0	
17:00-17:15	500	160	13, 16	70	0		130	0		100	0	
17:15-17:30	500	150	16	100	20	5, 16	90	0		80	0	
17:30-17:45	260	0		50	0		80	0		70	0	
17:45-18:00	370	30	16	60	0		100	0		80	0	
18:00-18:15	430	140	16	60	0		120	0		110	0	
18:15-18:30	400	60	16	60	0		90	0		100	0	
18:30-18:45	170	0		80	0		80	0		80	0	
18:45-19:00	150	0		80	0		60	0		100	0	
19:00-19:15	150	0		70	0		60	0		50	0	
19:15-19:30	210	0		80	0		30	0		40	0	
19:30-19:45	120	0		70	0		60	0		60	0	
19:45-20:00	120	0		80	0		80	0		60	0	
20:00-20:15	100	0		80	0		80	0		60	0	
20:15-20:30	60	0		80	0		50	0		30	0	
20:30-20:45	50	0		60	0		30	0		40	0	
20:45-21:00	40	0		50	0		40	0		40	0	
21:00-21:15	30	0		50	0		60	0		60	0	
21:15-21:30	40	0		50	0		110	0		70	0	
21:30-21:45	30	0		60	0		50	0		50	0	
21:45-22:00	20	0		40	0		60	0		50	0	

滞留長・渋滞長調査表

調査地点：地域社会2 目黒交番前

調査年月日：令和元年10月13日(日) 天候：曇りのち雨



1: 車線減少	2: 信号現示不遵	3: 踏切	4: 橋梁	5: 右折、対向直進	6: 左折車
7: 大型車	8: 二輪車	9: 歩行者	10: 駐車車両	11: バス停、バスレーン	12: 工事、事故
13: 沿道出入車両	14: 道路線形	15: 交差点形状	16: 先詰まり	17: その他	

方向 観測時間	方向 a			方向 b			方向 c			方向 d		
	滞留長 (m)	渋滞長 (m)	渋滞 原因	滞留長 (m)	渋滞長 (m)	渋滞 原因	滞留長 (m)	渋滞長 (m)	渋滞 原因	滞留長 (m)	渋滞長 (m)	渋滞 原因
22:00-22:15	20	0		50	0		30	0		40	0	
22:15-22:30	20	0		50	0		30	0		70	0	
22:30-22:45	30	0		40	0		10	0		40	0	
22:45-23:00	20	0		30	0		10	0		20	0	
23:00-23:15	20	0		50	0		20	0		50	0	
23:15-23:30	20	0		30	0		10	0		90	0	
23:30-23:45	30	0		30	0		30	0		30	0	
23:45-24:00	20	0		20	0		20	0		50	0	
0:00-0:15	20	0		20	0		10	0		10	0	
0:15-0:30	20	0		10	0		20	0		10	0	
0:30-0:45	20	0		10	0		10	0		30	0	
0:45-1:00	20	0		10	0		10	0		10	0	
1:00-1:15	20	0		10	0		20	0		50	0	
1:15-1:30	30	0		20	0		10	0		30	0	
1:30-1:45	20	0		10	0		20	0		30	0	
1:45-2:00	20	0		20	0		10	0		30	0	
2:00-2:15	10	0		30	0		10	0		20	0	
2:15-2:30	20	0		30	0		10	0		20	0	
2:30-2:45	20	0		20	0		10	0		50	0	
2:45-3:00	20	0		30	0		10	0		10	0	
3:00-3:15	20	0		30	0		10	0		20	0	
3:15-3:30	20	0		40	0		10	0		40	0	
3:30-3:45	10	0		40	0		10	0		30	0	
3:45-4:00	10	0		20	0		10	0		30	0	
4:00-4:15	10	0		20	0		10	0		30	0	
4:15-4:30	10	0		20	0		10	0		20	0	
4:30-4:45	10	0		20	0		20	0		40	0	
4:45-5:00	10	0		30	0		10	0		10	0	
5:00-5:15	10	0		10	0		30	0		10	0	
5:15-5:30	10	0		40	0		20	0		30	0	
5:30-5:45	10	0		40	0		30	0		60	0	
5:45-6:00	10	0		20	0		20	0		60	0	
6:00-6:15	20	0		50	0		60	0		50	0	
6:15-6:30	30	0		60	0		80	0		20	0	
6:30-6:45	50	0		100	0		70	0		110	0	
6:45-7:00	40	0		60	0		60	0		150	0	
7:00-7:15	40	0		140	0		50	0		40	0	
7:15-7:30	70	0		110	0		70	0		180	0	
7:30-7:45	60	0		120	0		80	0		180	0	
7:45-8:00	50	0		80	0		60	0		190	10	13
8:00-8:15	70	0		50	0		100	10	5	100	0	
8:15-8:30	50	0		40	0		70	0		100	0	
8:30-8:45	60	0		50	0		110	20	16	60	0	
8:45-9:00	60	0		40	0		90	0		50	0	
9:00-9:15	80	40	2.5	50	0		50	0		40	0	
9:15-9:30	50	10	2.5	50	0		110	0		80	0	
9:30-9:45	50	10	2.5	60	0		40	0		160	0	
9:45-10:00	40	0		40	0		50	0		100	0	

滞留長・渋滞長調査表

調査地点：地域社会2 目黒交番前

調査年月日：令和元年10月13日(日) 天候：曇りのち雨



滞留原因凡例	1：車線減少	2：信号現示不遵	3：踏切	4：橋梁	5：右折、対向直進	6：左折車
	7：大型車	8：二輪車	9：歩行者	10：駐車車両	11：バス停、バスレーン	12：工事、事故
	13：沿道出入車両	14：道路線形	15：交差点形状	16：先詰まり	17：その他	

観測時間	方向 a			方向 b			方向 c			方向 d		
	滞留長 (m)	渋滞長 (m)	渋滞 原因	滞留長 (m)	渋滞長 (m)	渋滞 原因	滞留長 (m)	渋滞長 (m)	渋滞 原因	滞留長 (m)	渋滞長 (m)	渋滞 原因
10:00-10:15	70	30	2,5	40	0		50	0		220	0	
10:15-10:30	50	0		50	0		60	10	5	140	0	
10:30-10:45	50	0		50	0		30	0		280	10	13
10:45-11:00	70	20	2,5	110	0		40	0		140	0	
11:00-11:15	150	80	2,5	80	0		40	0		150	0	
11:15-11:30	100	50	2,5	100	0		40	0		350	10	16
11:30-11:45	90	20	2,5	150	0		80	0		250	0	
11:45-12:00	160	120	2,5	50	0		60	0		130	0	
12:00-12:15	150	80	2,5	40	0		30	0		70	0	
12:15-12:30	140	70	2,5	40	0		60	0		90	0	
12:30-12:45	100	50	2,5	50	0		100	0		60	0	
12:45-13:00	60	20	2,5	20	0		50	0		140	0	
13:00-13:15	60	20	2,5	50	0		50	0		150	0	
13:15-13:30	90	50	2,5	40	0		70	0		160	0	
13:30-13:45	140	70	2,5	60	0		60	0		430	220	7,13
13:45-14:00	120	50	2,5	50	0		50	0		310	40	7,13
14:00-14:15	40	0		40	0		10	0		60	0	
14:15-14:30	100	40	2,5	40	0		30	0		90	0	
14:30-14:45	80	30	2,5	30	0		60	0		80	0	
14:45-15:00	50	0		30	0		40	0		150	0	
15:00-15:15	70	20	2,5	40	0		50	0		40	0	
15:15-15:30	40	0		40	0		40	0		50	0	
15:30-15:45	50	0		30	0		40	0		80	0	
15:45-16:00	40	0		30	0		30	0		80	0	
16:00-16:15	60	20	2,5	60	0		30	0		310	80	7,13
16:15-16:30	60	20	2,5	50	0		70	0		400	60	7,13
16:30-16:45	50	0		50	0		70	0		250	0	
16:45-17:00	110	50	2,5	60	0		60	0		350	10	7,13
17:00-17:15	70	30	2,5	40	0		100	0		150	0	
17:15-17:30	60	20	2,5	50	0		90	0		170	0	
17:30-17:45	40	0		40	0		40	0		180	0	
17:45-18:00	60	20	2,5	60	0		100	0		150	0	
18:00-18:15	50	0		30	0		30	0		150	0	
18:15-18:30	60	0		30	0		60	0		50	0	
18:30-18:45	50	0		50	0		40	0		50	0	
18:45-19:00	60	0		50	0		10	0		160	0	
19:00-19:15	40	0		30	0		40	0		60	0	
19:15-19:30	60	20	2,5	60	0		60	0		140	0	
19:30-19:45	30	0		40	0		50	0		130	0	
19:45-20:00	50	0		60	0		30	0		30	0	
20:00-20:15	40	0		80	0		40	0		130	0	
20:15-20:30	40	0		50	0		30	0		80	0	
20:30-20:45	30	0		40	0		10	0		160	0	
20:45-21:00	40	0		30	0		30	0		140	0	
21:00-21:15	30	0		50	0		40	0		170	0	
21:15-21:30	40	0		50	0		30	0		90	0	
21:30-21:45	40	0		40	0		10	0		150	0	
21:45-22:00	30	0		40	0		40	0		60	0	

滞留長・渋滞長調査表

調査地点：地域社会3 上川井IC

調査年月日：令和元年10月13日(日) 天候：曇りのち雨



1: 車線減少	2: 信号現示不遵	3: 踏切	4: 橋梁	5: 右折、対向直進	6: 左折車
7: 大型車	8: 二輪車	9: 歩行者	10: 駐車車両	11: バス停、バスレーン	12: 工事、事故
13: 沿道出入車両	14: 道路線形	15: 交差点形状	16: 先詰まり	17: その他	

方向 観測時間	方向 a			方向 b			方向 c			方向 d		
	滞留長 (m)	渋滞長 (m)	渋滞 原因	滞留長 (m)	渋滞長 (m)	渋滞 原因	滞留長 (m)	渋滞長 (m)	渋滞 原因	滞留長 (m)	渋滞長 (m)	渋滞 原因
22:00-22:15	10	0		30	0		10	0		20	0	
22:15-22:30	20	0		40	0		10	0		30	0	
22:30-22:45	10	0		20	0		10	0		20	0	
22:45-23:00	10	0		30	0		10	0		100	0	
23:00-23:15	10	0		30	0		30	0		30	0	
23:15-23:30	10	0		20	0		10	0		30	0	
23:30-23:45	10	0		30	0		10	0		20	0	
23:45-24:00	10	0		20	0		20	0		10	0	
0:00-0:15	10	0		30	0		10	0		20	0	
0:15-0:30	10	0		30	0		10	0		30	0	
0:30-0:45	20	0		10	0		10	0		20	0	
0:45-1:00	10	0		20	0		0	0		20	0	
1:00-1:15	10	0		20	0		30	0		30	0	
1:15-1:30	10	0		50	0		10	0		30	0	
1:30-1:45	10	0		50	0		20	0		20	0	
1:45-2:00	10	0		20	0		0	0		10	0	
2:00-2:15	10	0		40	0		0	0		10	0	
2:15-2:30	10	0		30	0		10	0		10	0	
2:30-2:45	20	0		20	0		10	0		10	0	
2:45-3:00	10	0		30	0		10	0		10	0	
3:00-3:15	10	0		40	0		10	0		10	0	
3:15-3:30	10	0		70	0		10	0		20	0	
3:30-3:45	10	0		60	0		10	0		30	0	
3:45-4:00	10	0		20	0		10	0		10	0	
4:00-4:15	10	0		20	0		10	0		10	0	
4:15-4:30	10	0		40	0		0	0		30	0	
4:30-4:45	10	0		20	0		0	0		20	0	
4:45-5:00	10	0		60	0		10	0		10	0	
5:00-5:15	10	0		30	0		10	0		30	0	
5:15-5:30	10	0		80	0		10	0		30	0	
5:30-5:45	20	0		110	0		10	0		10	0	
5:45-6:00	30	0		70	0		10	0		20	0	
6:00-6:15	20	0		100	0		10	0		20	0	
6:15-6:30	20	0		80	0		10	0		30	0	
6:30-6:45	10	0		50	0		20	0		40	0	
6:45-7:00	40	0		70	0		40	0		40	0	
7:00-7:15	40	0		60	0		10	0		50	0	
7:15-7:30	50	0		110	0		30	0		30	0	
7:30-7:45	40	0		70	0		30	0		60	0	
7:45-8:00	20	0		70	0		20	0		70	0	
8:00-8:15	20	0		50	0		30	0		60	0	
8:15-8:30	50	0		80	0		30	0		70	0	
8:30-8:45	40	0		60	0		30	0		80	0	
8:45-9:00	10	0		130	0		40	0		70	0	
9:00-9:15	20	0		80	0		50	0		80	0	
9:15-9:30	20	0		90	0		30	0		80	0	
9:30-9:45	30	0		70	0		10	0		90	0	
9:45-10:00	20	0		50	0		50	0		40	0	

滞留長・渋滞長調査表

調査地点：地域社会3 上川井IC

調査年月日：令和元年10月13日(日) 天候：曇りのち雨



渋滞原因凡例	1：車線減少	2：信号現示不遵	3：踏切	4：橋梁	5：右折、対向直進	6：左折車
	7：大型車	8：二輪車	9：歩行者	10：駐車車両	11：バス停、バスレーン	12：工事、事故
	13：沿道出入車両	14：道路線形	15：交差点形状	16：先詰まり	17：その他	

観測時間	方向 a			方向 b			方向 c			方向 d		
	滞留長 (m)	渋滞長 (m)	渋滞 原因	滞留長 (m)	渋滞長 (m)	渋滞 原因	滞留長 (m)	渋滞長 (m)	渋滞 原因	滞留長 (m)	渋滞長 (m)	渋滞 原因
10:00-10:15	30	0		50	0		30	0		50	0	
10:15-10:30	20	0		90	0		40	0		40	0	
10:30-10:45	20	0		40	0		100	10	6	30	0	
10:45-11:00	60	0		120	0		40	0		80	10	16
11:00-11:15	30	0		60	0		40	0		70	0	
11:15-11:30	10	0		70	0		40	0		50	0	
11:30-11:45	30	0		120	0		30	0		60	0	
11:45-12:00	40	0		110	0		20	0		50	0	
12:00-12:15	20	0		70	0		30	0		60	0	
12:15-12:30	30	0		90	0		50	10	6	60	0	
12:30-12:45	30	0		80	0		20	0		50	0	
12:45-13:00	40	0		110	0		30	0		30	0	
13:00-13:15	20	0		50	0		30	0		60	0	
13:15-13:30	20	0		50	0		50	0		30	0	
13:30-13:45	20	0		90	0		20	0		50	0	
13:45-14:00	50	0		100	0		30	0		60	0	
14:00-14:15	20	0		80	0		40	0		40	0	
14:15-14:30	30	0		60	0		40	0		40	0	
14:30-14:45	30	0		130	0		50	0		70	0	
14:45-15:00	20	0		110	0		70	0		30	0	
15:00-15:15	40	0		120	0		30	0		30	0	
15:15-15:30	30	0		70	0		30	0		40	0	
15:30-15:45	20	0		110	0		20	0		110	20	7
15:45-16:00	20	0		50	0		30	0		60	0	
16:00-16:15	30	0		60	0		30	0		40	0	
16:15-16:30	30	0		80	0		20	0		60	0	
16:30-16:45	20	0		40	0		30	0		50	0	
16:45-17:00	30	0		90	0		20	0		60	0	
17:00-17:15	30	0		50	0		50	0		40	0	
17:15-17:30	40	0		80	0		30	0		90	0	
17:30-17:45	50	0		110	0		30	0		140	30	16
17:45-18:00	40	0		120	0		20	0		50	0	
18:00-18:15	20	0		80	0		70	10	6	50	0	
18:15-18:30	40	0		80	0		30	0		110	20	16
18:30-18:45	50	0		70	0		30	0		30	0	
18:45-19:00	20	0		70	0		10	0		20	0	
19:00-19:15	20	0		90	0		30	0		30	0	
19:15-19:30	20	0		60	0		10	0		20	0	
19:30-19:45	20	0		70	0		10	0		20	0	
19:45-20:00	10	0		90	0		10	0		30	0	
20:00-20:15	20	0		60	0		10	0		30	0	
20:15-20:30	10	0		40	0		20	0		20	0	
20:30-20:45	20	0		60	0		30	0		30	0	
20:45-21:00	10	0		130	0		10	0		30	0	
21:00-21:15	30	0		120	0		20	0		40	0	
21:15-21:30	20	0		70	0		10	0		50	0	
21:30-21:45	10	0		100	0		10	0		60	0	
21:45-22:00	10	0		80	0		10	0		40	0	

滞留長・渋滞長調査表

調査地点：地域社会4 滝沢

調査年月日：令和 2年 9月21日(月・祝) 天候：曇りのち晴れ



1：車線減少	2：信号現示不遵	3：踏切	4：橋梁	5：右折、対向直進	6：左折車
7：大型車	8：二輪車	9：歩行者	10：駐車車両	11：バス停、バスレーン	12：工事、事故
13：沿道出入車両	14：道路線形	15：交差点形状	16：先詰まり	17：その他	

方向 観測時間	方向 a			方向 b			方向 c			滞留長 (m)	渋滞長 (m)	渋滞 原因
	滞留長 (m)	渋滞長 (m)	渋滞 原因	滞留長 (m)	渋滞長 (m)	渋滞 原因	滞留長 (m)	渋滞長 (m)	渋滞 原因			
7:00-7:15	70	0		60	0		20	0				
7:15-7:30	10	0		70	0		30	0				
7:30-7:45	40	0		40	0		20	0				
7:45-8:00	30	0		80	0		20	0				
8:00-8:15	40	0		30	0		40	0				
8:15-8:30	30	0		60	0		30	0				
8:30-8:45	20	0		40	0		30	0				
8:45-9:00	50	0		90	0		30	0				
9:00-9:15	40	0		60	0		20	0				
9:15-9:30	60	0		50	0		30	0				
9:30-9:45	40	0		40	0		30	0				
9:45-10:00	50	0		70	0		20	0				
10:00-10:15	130	60	16	80	0		60	0				
10:15-10:30	440	290	16	40	0		40	0				
10:30-10:45	430	280	16	60	0		20	0				
10:45-11:00	440	270	16	50	0		40	0				
11:00-11:15	420	290	16	60	0		30	0				
11:15-11:30	430	300	16	30	0		20	0				
11:30-11:45	420	270	16	40	0		30	0				
11:45-12:00	420	280	16	30	0		20	0				
12:00-12:15	400	300	16	60	0		30	0				
12:15-12:30	280	40	16	40	0		80	0				
12:30-12:45	250	20	16	20	0		20	0				
12:45-13:00	140	0		40	0		40	0				
13:00-13:15	20	0		20	0		60	0				
13:15-13:30	60	0		20	0		30	0				
13:30-13:45	30	0		40	0		50	0				
13:45-14:00	50	0		90	0		20	0				
14:00-14:15	50	0		70	0		30	0				
14:15-14:30	40	0		90	0		20	0				
14:30-14:45	30	0		60	0		30	0				
14:45-15:00	30	0		60	0		20	0				
15:00-15:15	30	0		50	0		20	0				
15:15-15:30	20	0		90	0		20	0				
15:30-15:45	20	0		70	0		30	0				
15:45-16:00	20	0		60	0		20	0				
16:00-16:15	30	0		40	0		60	0				
16:15-16:30	30	0		30	0		20	0				
16:30-16:45	40	0		90	0		40	0				
16:45-17:00	70	0		50	0		40	0				
17:00-17:15	50	0		30	0		30	0				
17:15-17:30	40	0		40	0		30	0				
17:30-17:45	30	0		40	0		70	0				
17:45-18:00	20	0		70	0		30	0				
18:00-18:15	40	0		40	0		80	0				
18:15-18:30	50	0		40	0		60	0				
18:30-18:45	30	0		30	0		40	0				
18:45-19:00	20	0		30	0		50	0				

滞留長・渋滞長調査表

調査地点：地域社会4 滝沢

調査年月日：令和 2年 9月21日(月・祝) 天候：曇りのち晴れ



滞留原因凡例	1：車線減少	2：信号現示不遵	3：踏切	4：橋梁	5：右折、対向直進	6：左折車
	7：大型車	8：二輪車	9：歩行者	10：駐車車両	11：バス停、バスレーン	12：工事、事故
	13：沿道出入車両	14：道路線形	15：交差点形状	16：先詰まり	17：その他	

観測時間	方向 a			方向 b			方向 c			滞留長 (m)	渋滞長 (m)	渋滞原因
	滞留長 (m)	渋滞長 (m)	渋滞原因	滞留長 (m)	渋滞長 (m)	渋滞原因	滞留長 (m)	渋滞長 (m)	渋滞原因			
19:00-19:15	40	0		110	0		30	0				
19:15-19:30	30	0		90	0		20	0				
19:30-19:45	20	0		60	0		30	0				
19:45-20:00	10	0		60	0		40	0				
20:00-20:15	20	0		100	0		20	0				
20:15-20:30	30	0		70	0		40	0				
20:30-20:45	10	0		110	0		30	0				
20:45-21:00	20	0		60	0		30	0				
21:00-21:15	20	0		50	0		20	0				
21:15-21:30	20	0		30	0		20	0				
21:30-21:45	30	0		60	0		20	0				
21:45-22:00	20	0		40	0		20	0				
22:00-22:15	10	0		30	0		30	0				
22:15-22:30	10	0		40	0		30	0				
22:30-22:45	20	0		60	0		20	0				
22:45-23:00	10	0		30	0		20	0				
23:00-23:15	10	0		30	0		30	0				
23:15-23:30	10	0		20	0		20	0				
23:30-23:45	10	0		20	0		40	0				
23:45-24:00	10	0		10	0		20	0				
0:00-0:15	10	0		20	0		20	0				
0:15-0:30	10	0		20	0		10	0				
0:30-0:45	10	0		20	0		10	0				
0:45-1:00	10	0		10	0		20	0				
1:00-1:15	10	0		20	0		10	0				
1:15-1:30	10	0		10	0		20	0				
1:30-1:45	10	0		10	0		20	0				
1:45-2:00	10	0		20	0		10	0				
2:00-2:15	10	0		20	0		10	0				
2:15-2:30	10	0		10	0		10	0				
2:30-2:45	10	0		10	0		10	0				
2:45-3:00	10	0		10	0		10	0				
3:00-3:15	10	0		10	0		20	0				
3:15-3:30	10	0		30	0		20	0				
3:30-3:45	10	0		10	0		10	0				
3:45-4:00	10	0		10	0		10	0				
4:00-4:15	10	0		10	0		10	0				
4:15-4:30	10	0		20	0		10	0				
4:30-4:45	0	0		10	0		10	0				
4:45-5:00	10	0		10	0		20	0				
5:00-5:15	10	0		20	0		20	0				
5:15-5:30	10	0		40	0		20	0				
5:30-5:45	0	0		30	0		20	0				
5:45-6:00	10	0		20	0		30	0				
6:00-6:15	20	0		30	0		30	0				
6:15-6:30	10	0		30	0		30	0				
6:30-6:45	10	0		30	0		40	0				
6:45-7:00	10	0		20	0		30	0				

滞留長・渋滞長調査表

調査地点：地域社会4 瀬谷土橋公園入口

調査年月日：令和 2年 9月21日(月・祝) 天候：曇りのち晴れ



1：車線減少	2：信号現示不遵	3：踏切	4：橋梁	5：右折、対向直進	6：左折車
7：大型車	8：二輪車	9：歩行者	10：駐車車両	11：バス停、バスレーン	12：工事、事故
13：沿道出入車両	14：道路線形	15：交差点形状	16：先詰まり	17：その他	

方向 観測時間	方向 a			方向 b			方向 c			滞留長 (m)	渋滞長 (m)	渋滞 原因
	滞留長 (m)	渋滞長 (m)	渋滞 原因	滞留長 (m)	渋滞長 (m)	渋滞 原因	滞留長 (m)	渋滞長 (m)	渋滞 原因			
7:00-7:15	20	0		30	0		10	0				
7:15-7:30	40	0		20	0		20	0				
7:30-7:45	60	0		100	0		10	0				
7:45-8:00	30	0		100	0		10	0				
8:00-8:15	20	0		30	0		10	0				
8:15-8:30	30	0		60	0		30	0				
8:30-8:45	30	0		60	0		20	0				
8:45-9:00	50	0		80	0		30	0				
9:00-9:15	60	0		50	0		30	0				
9:15-9:30	60	0		60	0		20	0				
9:30-9:45	80	0		20	20	16	40	0				
9:45-10:00	220	80	6, 16	40	10	16	30	0				
10:00-10:15	350	180	6, 16	50	50	5, 7, 16	20	0				
10:15-10:30	350	200	6, 16	30	10	5, 16	30	0				
10:30-10:45	300	160	6, 16	50	40	5, 16	40	0				
10:45-11:00	300	180	6, 16	30	20	5, 16	20	0				
11:00-11:15	350	170	6, 16	30	20	5, 16	20	0				
11:15-11:30	350	260	6, 16	30	20	5, 16	40	0				
11:30-11:45	350	180	6, 16	20	0		20	0				
11:45-12:00	200	20	6, 16	60	10	5, 16	20	0				
12:00-12:15	150	0		80	30	5, 16	10	0				
12:15-12:30	220	20	6, 16	80	0		10	0				
12:30-12:45	60	0		30	0		40	0				
12:45-13:00	30	0		100	0		10	0				
13:00-13:15	30	0		30	0		60	0				
13:15-13:30	60	0		20	0		40	0				
13:30-13:45	90	0		50	0		30	0				
13:45-14:00	80	0		30	0		30	0				
14:00-14:15	80	0		30	0		30	0				
14:15-14:30	250	50	7, 13	60	0		60	0				
14:30-14:45	90	0		40	0		70	0				
14:45-15:00	180	20	6	30	0		100	0				
15:00-15:15	80	0		20	0		50	0				
15:15-15:30	50	0		30	0		50	0				
15:30-15:45	100	0		30	0		70	0				
15:45-16:00	80	0		30	0		110	0				
16:00-16:15	130	0		20	0		80	0				
16:15-16:30	70	0		30	0		130	0				
16:30-16:45	40	0		20	0		100	0				
16:45-17:00	80	0		20	0		50	0				
17:00-17:15	50	0		20	0		60	0				
17:15-17:30	80	0		40	0		70	0				
17:30-17:45	80	0		50	0		90	0				
17:45-18:00	120	0		70	0		100	0				
18:00-18:15	60	0		80	0		100	0				
18:15-18:30	60	0		30	0		50	0				
18:30-18:45	70	0		90	0		70	0				
18:45-19:00	70	0		70	0		30	0				

滞留長・渋滞長調査表

調査地点：地域社会4 瀬谷土橋公園入口

調査年月日：令和 2年 9月21日(月・祝) 天候：曇りのち晴れ



滞滯原因凡例	1：車線減少	2：信号現示不遵	3：踏切	4：橋梁	5：右折、対向直進	6：左折車
	7：大型車	8：二輪車	9：歩行者	10：駐車車両	11：バス停、バスレーン	12：工事、事故
	13：沿道出入車両	14：道路線形	15：交差点形状	16：先詰まり	17：その他	

観測時間	方向 a			方向 b			方向 c			滞留長 (m)	渋滞長 (m)	渋滞原因
	滞留長 (m)	渋滞長 (m)	渋滞原因	滞留長 (m)	渋滞長 (m)	渋滞原因	滞留長 (m)	渋滞長 (m)	渋滞原因			
19:00-19:15	70	0		80	0		50	0				
19:15-19:30	30	0		50	0		60	0				
19:30-19:45	50	0		50	0		20	0				
19:45-20:00	10	0		60	0		20	0				
20:00-20:15	20	0		60	0		30	0				
20:15-20:30	50	0		60	0		60	0				
20:30-20:45	40	0		30	0		40	0				
20:45-21:00	50	0		20	0		20	0				
21:00-21:15	40	0		20	0		20	0				
21:15-21:30	20	0		50	0		30	0				
21:30-21:45	20	0		20	0		20	0				
21:45-22:00	10	0		30	0		20	0				
22:00-22:15	30	0		50	0		10	0				
22:15-22:30	10	0		20	0		10	0				
22:30-22:45	50	0		20	0		40	0				
22:45-23:00	20	0		10	0		10	0				
23:00-23:15	20	0		10	0		10	0				
23:15-23:30	20	0		10	0		10	0				
23:30-23:45	20	0		10	0		10	0				
23:45-24:00	10	0		10	0		30	0				
0:00-0:15	10	0		10	0		10	0				
0:15-0:30	40	0		10	0		20	0				
0:30-0:45	20	0		10	0		30	0				
0:45-1:00	60	0		10	0		10	0				
1:00-1:15	20	0		20	0		10	0				
1:15-1:30	20	0		10	0		10	0				
1:30-1:45	10	0		10	0		10	0				
1:45-2:00	10	0		10	0		10	0				
2:00-2:15	20	0		10	0		10	0				
2:15-2:30	20	0		10	0		10	0				
2:30-2:45	10	0		10	0		10	0				
2:45-3:00	10	0		10	0		10	0				
3:00-3:15	20	0		20	0		10	0				
3:15-3:30	20	0		10	0		10	0				
3:30-3:45	20	0		10	0		10	0				
3:45-4:00	10	0		10	0		10	0				
4:00-4:15	10	0		10	0		10	0				
4:15-4:30	20	0		20	0		10	0				
4:30-4:45	20	0		10	0		10	0				
4:45-5:00	20	0		10	0		10	0				
5:00-5:15	20	0		40	0		10	0				
5:15-5:30	20	0		30	0		10	0				
5:30-5:45	20	0		10	0		10	0				
5:45-6:00	60	0		20	0		50	0				
6:00-6:15	30	0		50	0		30	0				
6:15-6:30	30	0		100	10	7	50	0				
6:30-6:45	30	0		20	0		40	0				
6:45-7:00	20	0		50	0		30	0				

滞留長・渋滞長調査表

調査地点：地域社会5

調査年月日：令和元年10月13日(日) 天候：曇りのち雨



渋滞原因凡例	1：車線減少	2：信号現示不遵	3：踏切	4：橋梁	5：右折、対向直進	6：左折車
	7：大型車	8：二輪車	9：歩行者	10：駐車車両	11：バス停、バスレーン	12：工事、事故
	13：沿道出入車両	14：道路線形	15：交差点形状	16：先詰まり	17：その他	

観測時間	方向 a			方向 b			方向 c			滞留長 (m)	渋滞長 (m)	渋滞原因
	滞留長 (m)	渋滞長 (m)	渋滞原因	滞留長 (m)	渋滞長 (m)	渋滞原因	滞留長 (m)	渋滞長 (m)	渋滞原因			
22:00-22:15	20	0		20	0		10	0				
22:15-22:30	90	20	6	10	0		20	0				
22:30-22:45	30	0		10	0		10	0				
22:45-23:00	30	0		20	0		20	0				
23:00-23:15	20	0		10	0		10	0				
23:15-23:30	10	0		10	0		0	0				
23:30-23:45	10	0		10	0		10	0				
23:45-24:00	30	0		10	0		0	0				
0:00-0:15	20	0		20	0		10	0				
0:15-0:30	10	0		10	0		10	0				
0:30-0:45	10	0		10	0		10	0				
0:45-1:00	20	0		10	0		10	0				
1:00-1:15	10	0		10	0		10	0				
1:15-1:30	10	0		10	0		10	0				
1:30-1:45	10	0		10	0		10	0				
1:45-2:00	10	0		20	0		10	0				
2:00-2:15	10	0		10	0		0	0				
2:15-2:30	10	0		0	0		0	0				
2:30-2:45	10	0		10	0		10	0				
2:45-3:00	10	0		0	0		0	0				
3:00-3:15	30	0		0	0		0	0				
3:15-3:30	10	0		0	0		10	0				
3:30-3:45	10	0		0	0		10	0				
3:45-4:00	10	0		0	0		10	0				
4:00-4:15	20	0		20	0		10	0				
4:15-4:30	10	0		0	0		20	0				
4:30-4:45	10	0		20	0		10	0				
4:45-5:00	20	0		10	0		10	0				
5:00-5:15	30	0		10	0		10	0				
5:15-5:30	20	0		30	0		10	0				
5:30-5:45	20	0		30	0		10	0				
5:45-6:00	30	0		30	0		10	0				
6:00-6:15	30	0		50	0		10	0				
6:15-6:30	30	0		40	0		10	0				
6:30-6:45	10	0		40	0		10	0				
6:45-7:00	30	0		50	0		10	0				
7:00-7:15	20	0		40	0		10	0				
7:15-7:30	40	0		50	0		20	0				
7:30-7:45	40	0		30	0		20	0				
7:45-8:00	40	0		50	0		20	0				
8:00-8:15	30	0		80	0		20	0				
8:15-8:30	70	0		120	30	5	20	0				
8:30-8:45	20	0		120	50	5	20	0				
8:45-9:00	20	0		50	0		30	0				
9:00-9:15	10	0		100	0		10	0				
9:15-9:30	10	0		120	0		20	0				
9:30-9:45	20	0		50	0		10	0				
9:45-10:00	40	0		100	0		60	10	2			

滞留長・渋滞長調査表

調査地点：地域社会5

調査年月日：令和元年10月13日(日) 天候：曇りのち雨

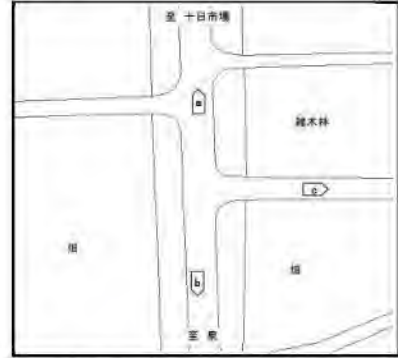

渋滞原因凡例	1：車線減少	2：信号現示不遵	3：踏切	4：橋梁	5：右折、対向直進	6：左折車
	7：大型車	8：二輪車	9：歩行者	10：駐車車両	11：バス停、バスレーン	12：工事、事故
	13：沿道出入車両	14：道路線形	15：交差点形状	16：先詰まり	17：その他	

観測時間	方向 a			方向 b			方向 c			滞留長 (m)	渋滞長 (m)	渋滞原因
	滞留長 (m)	渋滞長 (m)	渋滞原因	滞留長 (m)	渋滞長 (m)	渋滞原因	滞留長 (m)	渋滞長 (m)	渋滞原因			
10:00-10:15	30	0		100	0		30	0				
10:15-10:30	100	20	6	120	0		40	0				
10:30-10:45	50	0		120	0		60	0				
10:45-11:00	30	0		120	0		40	0				
11:00-11:15	50	0		100	0		70	10	5, 6			
11:15-11:30	70	0		80	0		80	10	5, 6			
11:30-11:45	80	0		100	0		70	10	5, 6			
11:45-12:00	60	0		60	0		40	0				
12:00-12:15	40	0		100	0		20	0				
12:15-12:30	20	0		130	0		10	0				
12:30-12:45	20	0		70	0		10	0				
12:45-13:00	50	0		110	0		20	0				
13:00-13:15	50	0		50	0		30	0				
13:15-13:30	50	0		80	0		20	0				
13:30-13:45	30	0		110	0		10	0				
13:45-14:00	50	0		90	0		30	0				
14:00-14:15	30	0		150	60	5	20	0				
14:15-14:30	80	0		300	200	16	10	0				
14:30-14:45	10	0		350	240	16	10	0				
14:45-15:00	80	0		100	70	16	40	0				
15:00-15:15	90	0		100	0		20	0				
15:15-15:30	70	0		80	0		20	0				
15:30-15:45	30	0		120	60	5	20	0				
15:45-16:00	40	0		100	0		20	0				
16:00-16:15	150	40	6	140	50	5	50	0				
16:15-16:30	80	0		120	20	16	60	10	5, 6			
16:30-16:45	80	0		80	10	5	40	0				
16:45-17:00	160	40	6	120	0		50	0				
17:00-17:15	90	0		50	0		30	0				
17:15-17:30	140	30	6	60	0		50	0				
17:30-17:45	150	30	6	160	70	5	40	0				
17:45-18:00	110	0		40	0		30	0				
18:00-18:15	50	0		50	0		10	0				
18:15-18:30	30	0		50	0		10	0				
18:30-18:45	40	0		10	0		10	0				
18:45-19:00	40	0		60	0		10	0				
19:00-19:15	20	0		50	0		10	0				
19:15-19:30	20	0		50	0		10	0				
19:30-19:45	50	0		20	0		10	0				
19:45-20:00	10	0		40	0		10	0				
20:00-20:15	40	0		30	0		20	0				
20:15-20:30	50	0		20	0		10	0				
20:30-20:45	50	0		20	0		10	0				
20:45-21:00	50	0		10	0		10	0				
21:00-21:15	40	0		20	0		10	0				
21:15-21:30	10	0		10	0		10	0				
21:30-21:45	40	0		10	0		10	0				
21:45-22:00	40	0		10	0		10	0				

滞留長・渋滞長調査表

調査地点：地域社会6 瀬谷中学校前

調査年月日：令和元年10月13日(日) 天候：曇りのち雨



滞留原因凡例	1: 車線減少	2: 信号現示不遵	3: 踏切	4: 橋梁	5: 右折、対向直進	6: 左折車
	7: 大型車	8: 二輪車	9: 歩行者	10: 駐車車両	11: バス停、バスレーン	12: 工事、事故
	13: 沿道出入車両	14: 道路線形	15: 交差点形状	16: 先詰まり	17: その他	

方向 観測時間	方向 a			方向 b			方向 c			方向 d		
	滞留長 (m)	渋滞長 (m)	渋滞 原因	滞留長 (m)	渋滞長 (m)	渋滞 原因	滞留長 (m)	渋滞長 (m)	渋滞 原因	滞留長 (m)	渋滞長 (m)	渋滞 原因
22:00-22:15	20	0		20	0		20	0		20	0	
22:15-22:30	20	0		10	0		20	0		20	0	
22:30-22:45	20	0		20	0		30	0		10	0	
22:45-23:00	20	0		10	0		30	0		10	0	
23:00-23:15	70	0		10	0		30	0		10	0	
23:15-23:30	30	0		20	0		30	0		20	0	
23:30-23:45	20	0		20	0		10	0		10	0	
23:45-24:00	30	0		20	0		20	0		10	0	
0:00-0:15	10	0		10	0		20	0		20	0	
0:15-0:30	30	0		10	0		20	0		10	0	
0:30-0:45	20	0		20	0		20	0		20	0	
0:45-1:00	20	0		10	0		30	0		10	0	
1:00-1:15	10	0		10	0		10	0		20	0	
1:15-1:30	30	0		10	0		20	0		20	0	
1:30-1:45	40	0		0	0		20	0		10	0	
1:45-2:00	20	0		10	0		20	0		10	0	
2:00-2:15	10	0		10	0		20	0		10	0	
2:15-2:30	20	0		20	0		20	0		10	0	
2:30-2:45	20	0		10	0		10	0		10	0	
2:45-3:00	10	0		10	0		20	0		10	0	
3:00-3:15	0	0		0	0		20	0		0	0	
3:15-3:30	30	0		10	0		20	0		20	0	
3:30-3:45	20	0		10	0		10	0		10	0	
3:45-4:00	10	0		10	0		20	0		10	0	
4:00-4:15	20	0		10	0		20	0		10	0	
4:15-4:30	20	0		10	0		10	0		10	0	
4:30-4:45	20	0		10	0		10	0		10	0	
4:45-5:00	20	0		10	0		20	0		10	0	
5:00-5:15	10	0		10	0		20	0		10	0	
5:15-5:30	30	0		20	0		20	0		10	0	
5:30-5:45	60	0		10	0		30	0		10	0	
5:45-6:00	60	0		20	0		50	0		10	0	
6:00-6:15	30	0		20	0		60	0		30	0	
6:15-6:30	40	0		40	0		70	0		30	0	
6:30-6:45	90	0		20	0		70	0		20	0	
6:45-7:00	50	0		20	0		70	0		10	0	
7:00-7:15	30	0		10	0		100	0		50	0	
7:15-7:30	80	0		20	0		60	0		40	0	
7:30-7:45	90	0		30	0		110	0		60	0	
7:45-8:00	50	0		40	0		100	0		50	0	
8:00-8:15	50	0		40	0		130	0		30	0	
8:15-8:30	80	0		40	0		110	0		30	0	
8:30-8:45	70	0		40	0		90	0		40	0	
8:45-9:00	50	0		80	0		120	0		50	0	
9:00-9:15	50	0		20	0		70	0		90	0	
9:15-9:30	30	0		40	0		70	0		40	0	
9:30-9:45	60	0		50	0		60	0		110	0	
9:45-10:00	50	0		50	0		60	0		110	20	6, 9, 13

滞留長・渋滞長調査表

調査地点：地域社会6 瀬谷中学校前

調査年月日：令和元年10月13日(日) 天候：曇りのち雨



滞留原因凡例	1：車線減少	2：信号現示不遵	3：踏切	4：橋梁	5：右折、対向直進	6：左折車
	7：大型車	8：二輪車	9：歩行者	10：駐車車両	11：バス停、バスレーン	12：工事、事故
	13：沿道出入車両	14：道路線形	15：交差点形状	16：先詰まり	17：その他	

方向 観測時間	方向 a			方向 b			方向 c			方向 d		
	滞留長 (m)	渋滞長 (m)	渋滞 原因	滞留長 (m)	渋滞長 (m)	渋滞 原因	滞留長 (m)	渋滞長 (m)	渋滞 原因	滞留長 (m)	渋滞長 (m)	渋滞 原因
10:00-10:15	60	0		50	0		60	0		600	510	6, 13
10:15-10:30	110	0		20	0		110	0		520	430	6, 13
10:30-10:45	150	20	2	50	0		40	0		600	480	6, 13
10:45-11:00	110	0		20	0		50	0		680	600	6, 13
11:00-11:15	60	0		50	0		70	0		160	10	6, 13
11:15-11:30	160	20	2	70	20	5	50	0		360	300	6, 13, 16
11:30-11:45	210	60	2	50	0		70	0		180	40	6, 13
11:45-12:00	70	0		40	0		30	0		120	20	6, 13
12:00-12:15	20	0		20	0		40	0		50	0	
12:15-12:30	60	0		30	0		30	0		50	0	
12:30-12:45	30	0		50	0		100	0		50	0	
12:45-13:00	60	0		30	0		80	0		40	0	
13:00-13:15	70	0		50	0		80	0		100	20	6, 9
13:15-13:30	80	0		60	10	5	100	0		90	20	6, 13
13:30-13:45	70	0		50	10	5	170	30	2	100	30	6, 7
13:45-14:00	30	0		40	20	5	70	0		100	20	6, 9, 13
14:00-14:15	20	0		20	0		110	0		60	0	
14:15-14:30	30	0		30	0		170	40	2, 6	100	0	
14:30-14:45	40	0		30	0		100	0		60	0	
14:45-15:00	30	0		60	0		80	0		100	20	6
15:00-15:15	80	20	2	60	0		70	0		60	0	
15:15-15:30	30	0		20	0		180	20	2	90	0	
15:30-15:45	20	0		80	0		190	20	2	160	30	13
15:45-16:00	220	50	16	60	0		100	0		120	10	13
16:00-16:15	140	0		20	0		150	10	2	110	10	6
16:15-16:30	60	0		60	0		170	20	2	170	40	6, 13
16:30-16:45	90	0		60	0		80	0		120	10	11
16:45-17:00	160	30	16	50	0		170	10	2	170	30	6, 13
17:00-17:15	60	0		50	0		80	0		60	0	
17:15-17:30	60	0		60	0		70	0		20	0	
17:30-17:45	150	10	2	80	0		20	0		70	10	6, 9
17:45-18:00	120	0		50	0		30	0		100	0	
18:00-18:15	30	0		80	10	5	30	0		100	10	6, 9
18:15-18:30	20	0		90	0		50	0		30	0	
18:30-18:45	120	0		90	30	5	30	0		20	0	
18:45-19:00	40	0		70	0		30	0		40	0	
19:00-19:15	30	0		60	0		70	0		60	0	
19:15-19:30	50	0		30	0		40	0		50	0	
19:30-19:45	160	20	2	30	0		40	0		40	0	
19:45-20:00	100	0		20	0		60	0		30	0	
20:00-20:15	20	0		10	0		50	0		20	0	
20:15-20:30	10	0		20	0		40	0		20	0	
20:30-20:45	30	0		30	0		40	0		30	0	
20:45-21:00	80	0		30	0		40	0		40	0	
21:00-21:15	30	0		20	0		40	0		20	0	
21:15-21:30	20	0		30	0		80	0		20	0	
21:30-21:45	50	0		20	0		20	0		10	0	
21:45-22:00	30	0		20	0		50	0		20	0	

9.17-4 信号現示調査結果

対象事業実施区域周辺の主要交差点（7交差点）において、平日・休日・混雑時に実施した調査結果は、平日はP.資料 地域-890～896、休日はP.資料 地域-897～903、混雑時はP.資料 地域-904～910 に示すとおりです。

信号現示調査表

調査地点：地域社会1 目黒
 調査年月日：令和元年5月14日（火）



凡 例			
	青		西進青矢
	赤		直右青矢
	黄		直左青矢
	右折青矢		右左折青矢
	左折青矢		歩行者青点滅

現示 灯器 階梯	1φ					2φ			3φ				4φ			合計
	1	2	3	4	5	6	7	8	9	10	11	12	13	14	15	
A																
B																
a																
b																
7時台①	22	8	2	3	1	20	3	2	62	8	2	3	6	3	2	147
7時台②	26	8	2	3	1	28	3	2	59	8	2	3	5	3	2	155
7時台③	24	8	2	3	1	32	3	2	56	8	2	3	11	3	2	160
8時台①	28	8	2	3	1	25	3	2	58	8	2	3	5	3	2	153
8時台②	23	8	2	3	1	19	3	2	58	8	2	3	5	3	2	142
8時台③	24	8	2	3	1	32	3	2	55	8	2	3	5	3	2	153
12時台①	22	8	2	3	1	31	3	2	56	8	2	3	5	3	2	151
12時台②	22	8	2	3	1	31	3	2	54	8	2	3	5	3	2	149
12時台③	22	8	2	3	1	30	3	2	55	8	2	3	11	3	2	155
13時台①	22	8	2	3	1	33	3	2	55	8	2	3	5	3	2	152
13時台②	22	8	2	3	1	31	3	2	56	8	2	3	5	3	2	151
13時台③	22	8	2	3	1	31	3	2	56	8	2	3	11	3	2	157
17時台①	22	8	2	3	1	27	3	2	57	8	2	3	11	3	2	154
17時台②	22	8	2	3	1	31	3	2	53	8	2	3	10	3	2	153
17時台③	21	8	2	3	1	20	3	2	57	8	2	3	5	3	2	140
18時台①	21	8	2	3	1	17	3	2	60	8	2	3	5	3	2	140
18時台②	25	8	2	3	1	24	3	2	60	8	2	3	5	3	2	151
18時台③	24	8	2	3	1	33	3	2	55	8	2	3	11	3	2	160
22時台①	26	8	2	3	1	12	3	2	53	8	2	3	6	3	2	134
22時台②	29	8	2	3	1	15	3	2	53	8	2	3	6	3	2	140
22時台③	29	8	2	3	1	28	3	2	47	8	2	3	5	3	2	146
23時台①	26	8	2	3	1	18	3	2	47	8	2	3	6	3	2	134
23時台②	25	8	2	3	1	22	3	2	45	8	2	3	5	3	2	134
23時台③	23	8	2	3	1	9	3	2	49	8	2	3	6	3	2	124

単位：秒

現示	1φ	2φ	3φ	4φ

信号現示調査表

調査地点：地域社会2 目黒交番前
 調査年月日：令和元年5月14日（火）

凡 例	
	: 青
	: 赤
	: 黄
	: 右折青矢
	: 左折青矢
	: 直進青矢
	: 直右青矢
	: 直左青矢
	: 右左折青矢
	: 右左折青矢
	: 歩行者青点滅



現示 灯器 階梯	1φ					2φ			3φ				4φ			合計
	1	2	3	4	5	6	7	8	9	10	11	12	13	14	15	
A																
B																
a																
b																
7時台①	17	9	2	3	1	15	3	2	89	12	2	3	7	3	2	170
7時台②	17	9	2	3	1	15	3	2	88	12	2	3	7	3	2	169
7時台③	17	9	2	3	1	15	3	2	88	12	2	3	7	3	2	169
8時台①	17	9	2	3	1	15	3	2	90	12	2	3	7	3	2	171
8時台②	17	9	2	3	1	15	3	2	90	12	2	3	7	3	2	171
8時台③	17	9	2	3	1	15	3	2	89	12	2	3	7	3	2	170
12時台①	17	9	2	3	1	15	3	2	89	12	2	3	7	3	2	170
12時台②	17	9	2	3	1	15	3	2	89	12	2	3	7	3	2	170
12時台③	17	9	2	3	1	15	3	2	89	12	2	3	7	3	2	170
13時台①	20	9	2	3	1	14	3	2	76	12	2	3	5	3	2	157
13時台②	20	9	2	3	1	14	3	2	76	12	2	3	5	3	2	157
13時台③	20	9	2	3	1	14	3	2	76	12	2	3	5	3	2	157
17時台①	17	9	2	3	1	15	3	2	88	12	2	3	7	3	2	169
17時台②	17	9	2	3	1	15	3	2	89	12	2	3	7	3	2	170
17時台③	17	9	2	3	1	15	3	2	89	12	2	3	7	3	2	170
18時台①	17	9	2	3	1	15	3	2	89	12	2	3	7	3	2	170
18時台②	17	9	2	3	1	15	3	2	89	12	2	3	7	3	2	170
18時台③	17	9	2	3	1	15	3	2	89	12	2	3	7	3	2	170
22時台①	18	9	2	3	1	14	3	2	70	12	2	3	7	3	2	151
22時台②	18	9	2	3	1	13	3	2	71	12	2	3	7	3	2	151
22時台③	18	9	2	3	1	13	3	2	69	12	2	3	7	3	2	149
23時台①	20	9	2	3	1	11	3	2	49	12	2	3	8	3	2	130
23時台②	20	9	2	3	1	11	3	2	49	12	2	3	8	3	2	130
23時台③	20	9	2	3	1	11	3	2	49	12	2	3	8	3	2	130

単位：秒











現示	1φ	2φ	3φ	4φ

信号現示調査表

調査地点：地域社会3 上川井1G
 調査年月日：令和元年5月14日（火）

	青		直進青矢
	赤		直右青矢
	黄		直左青矢
	右折青矢		右左折青矢
	左折青矢		歩行者青点滅



現示 灯器 階梯	1 φ			2 φ				3 φ								合計		
	1	2	3	4	5	6	7	8	9	10	11	12	13	14				
A																		
B																		
a																		
b																		
7時台①	14	3	3	24	5	3	2	32	7	3	4						100	
7時台②	14	3	3	25	5	3	2	43	7	3	4						112	
7時台③	16	3	3	21	5	3	2	35	7	3	4						102	
8時台①	24	3	3	15	5	3	2	42	7	3	4						111	
8時台②	24	3	3	15	5	3	2	40	7	3	4						109	
8時台③	24	3	3	15	5	3	2	41	7	3	4						110	
12時台①	20	3	3	19	5	3	2	41	7	3	4						110	
12時台②	22	3	3	17	5	3	2	41	7	3	4						110	
12時台③	20	3	3	19	5	3	2	41	7	3	4						110	
13時台①	20	3	3	21	5	3	2	41	7	3	4						112	
13時台②	20	3	3	19	5	3	2	37	7	3	4						106	
13時台③	22	3	3	21	5	3	2	39	7	3	4						112	
17時台①	20	3	3	25	5	3	2	43	7	3	4						118	
17時台②	20	3	3	17	5	3	2	35	7	3	4						102	
17時台③	20	3	3	25	5	3	2	43	7	3	4						118	
18時台①	22	3	3	19	5	3	2	40	7	3	4						111	
18時台②	22	3	3	17	5	3	2	41	7	3	4						110	
18時台③	20	3	3	19	5	3	2	41	7	3	4						110	
22時台①	12	3	3	13	5	3	2	35	7	3	4						90	
22時台②	12	3	3	13	5	3	2	27	7	3	4						82	
22時台③	12	3	3	21	5	3	2	35	7	3	4						98	
23時台①	12	3	3	17	5	3	2	27	7	3	4						86	
23時台②	16	3	3	21	5	3	2	27	7	3	4						94	
23時台③	12	3	3	21	5	3	2	27	7	3	4						90	

単位：秒

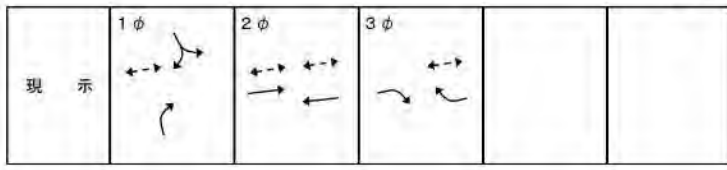

信号現示調査表

調査地点：地域社会4 滝沢
 調査年月日：令和2年9月29日（火）

凡 例	
— (青)	(1) : 直進青矢
— (赤)	(2) : 直右青矢
W (黄)	(3) : 直左青矢
(4) : 右折青矢	(5) : 右左折青矢
(6) : 左折青矢	: 歩行者青点滅



灯器 階梯	1 φ			2 φ				3 φ						合計	
	1	2	3	4	5	6	7	8	9	10	11	12	13		14
A	—	—	—	—	—	W	—	—	—	—	—	—	—	—	—
B	—	—	—	W	—	—	—	—	—	—	—	—	—	—	—
C	—	—	—	—	—	—	—	—	—	—	—	W	—	—	—
a		—	—	—	—	—	—	—	—	—	—	—	—	—	—
b	—	—	—	—	—	—	—		—	—	—	—	—	—	—
7時台①	28	8	1	3	8	3	2	22	8	1	3	3			90
7時台②	28	8	1	3	8	3	2	22	8	1	3	3			90
7時台③	45	8	1	3	8	3	2	25	8	1	3	3			110
8時台①	33	8	1	3	8	3	2	23	8	1	3	3			96
8時台②	35	8	1	3	8	3	2	25	8	1	3	3			100
8時台③	42	8	1	3	8	3	2	28	8	1	3	3			110
12時台①	28	8	1	3	8	3	2	22	8	1	3	3			90
12時台②	28	8	1	3	8	3	2	22	8	1	3	3			90
12時台③	28	8	1	3	8	3	2	22	8	1	3	3			90
13時台①	28	8	1	3	8	3	2	22	8	1	3	3			90
13時台②	28	8	1	3	8	3	2	22	8	1	3	3			90
13時台③	28	8	1	3	8	3	2	22	8	1	3	3			90
17時台①	45	8	1	3	8	3	2	30	8	1	3	3			115
17時台②	42	8	1	3	8	3	2	28	8	1	3	3			110
17時台③	30	8	1	3	8	3	2	25	8	1	3	3			95
18時台①	28	8	1	3	8	3	2	22	8	1	3	3			90
18時台②	28	8	1	3	8	3	2	22	8	1	3	3			90
18時台③	28	8	1	3	8	3	2	22	8	1	3	3			90
22時台①	33	8	1	3	8	3	2	27	8	1	3	3			100
22時台②	33	8	1	3	8	3	2	27	8	1	3	3			100
22時台③	30	8	1	3	8	3	2	25	8	1	3	3			95
23時台①	30	8	1	3	8	3	2	25	8	1	3	3			95
23時台②	30	8	1	3	8	3	2	25	8	1	3	3			95
23時台③	30	8	1	3	8	3	2	25	8	1	3	3			95

単位：秒

現 示	1 φ	2 φ	3 φ

信号現示調査表

調査地点：地域社会4 瀬谷土橋公園入口

調査年月日：令和2年9月29日（火）

凡 例	
	青
	赤
	黄
	右折青矢
	左折青矢
	直進青矢
	直右青矢
	直左青矢
	右左折青矢
	歩行者青点滅



灯器 階梯	1φ			2φ		3φ			4φ					合計	
	1	2	3	4	5	6	7	8	9	10	11	12	13		14
A															
B															
C															
a															
b															
7時台①	38	10	2	3	2	13	3	2	20	10	2	3	2		110
7時台②	45	10	2	3	2	15	3	2	25	10	2	3	2		124
7時台③	40	10	2	3	2	15	3	2	29	10	2	3	2		123
8時台①	30	10	2	3	2	12	3	2	24	10	2	3	2		105
8時台②	30	10	2	3	2	12	3	2	24	10	2	3	2		105
8時台③	30	10	2	3	2	12	3	2	24	10	2	3	2		105
12時台①	33	10	2	3	2	12	3	2	21	10	2	3	2		105
12時台②	37	10	2	3	2	12	3	2	19	10	2	3	2		107
12時台③	42	10	2	3	2	12	3	2	18	10	2	3	2		111
13時台①	34	10	2	3	2	12	3	2	18	10	2	3	2		103
13時台②	44	10	2	3	2	14	3	2	18	10	2	3	2		115
13時台③	33	10	2	3	2	12	3	2	20	10	2	3	2		104
17時台①	24	10	2	3	2	9	3	2	18	10	2	3	2		90
17時台②	24	10	2	3	2	10	3	2	19	10	2	3	2		92
17時台③	30	10	2	3	2	12	3	2	24	10	2	3	2		105
18時台①	30	10	2	3	2	11	3	2	21	10	2	3	2		101
18時台②	36	10	2	3	2	13	3	2	27	10	2	3	2		115
18時台③	36	10	2	3	2	13	3	2	27	10	2	3	2		115
22時台①	33	10	2	3	2	11	3	2	17	10	2	3	2		100
22時台②	32	10	2	3	2	11	3	2	20	10	2	3	2		102
22時台③	29	10	2	3	2	10	3	2	17	10	2	3	2		95
23時台①	29	10	2	3	2	10	3	2	17	10	2	3	2		95
23時台②	29	10	2	3	2	10	3	2	17	10	2	3	2		95
23時台③	20	10	2	3	2	7	3	2	17	10	2	3	2		83

単位：秒

現 示	1φ	2φ	3φ	4φ

信号現示調査表

調査地点：地域社会5

調査年月日：令和元年5月14日（火）

凡 例	
— (青)	① (直進青矢)
— (赤)	② (直右青矢)
W (黄)	③ (直左青矢)
④ (右折青矢)	⑤ (右左折青矢)
⑥ (左折青矢)	(歩行者青点滅)

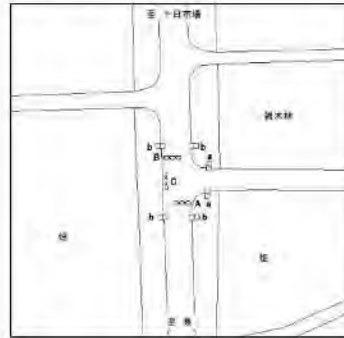

現示 灯器 階梯	1 φ				2 φ			3 φ				13	14	合計	
	1	2	3	4	5	6	7	8	9	10	11				12
A	[Signal diagram]				[Signal diagram]			[Signal diagram]							
B	[Signal diagram]				[Signal diagram]			[Signal diagram]							
C	[Signal diagram]				[Signal diagram]			[Signal diagram]							
a	[Signal diagram]				[Signal diagram]			[Signal diagram]							
b	[Signal diagram]				[Signal diagram]			[Signal diagram]							
7時台①	39	4	3	3	7	3	2	10	4	10	3	2			90
7時台②	39	4	3	3	7	3	2	10	4	10	3	2			90
7時台③	39	4	3	3	7	3	2	10	4	10	3	2			90
8時台①	39	4	3	3	7	3	2	10	4	10	3	2			90
8時台②	39	4	3	3	7	3	2	10	4	6	3	2			86
8時台③	39	4	3	3	7	3	2	10	4	10	3	2			90
12時台①	34	4	3	3	5	3	2	10	4	3	3	2			76
12時台②	34	4	3	3	5	3	2	10	4	3	3	2			76
12時台③	34	4	3	3	5	3	2	10	4	3	3	2			76
13時台①	34	4	3	3	5	3	2	10	4	6	3	2			79
13時台②	34	4	3	3	5	3	2	10	4	3	3	2			76
13時台③	34	4	3	3	5	3	2	10	4	3	3	2			76
17時台①	39	4	3	3	7	3	2	10	4	10	3	2			90
17時台②	39	4	3	3	7	3	2	10	4	10	3	2			90
17時台③	39	4	3	3	7	3	2	10	4	3	3	2			83
18時台①	34	4	3	3	5	3	2	10	4	7	3	2			80
18時台②	34	4	3	3	5	3	2	10	4	7	3	2			80
18時台③	34	4	3	3	5	3	2	10	4	7	3	2			80
22時台①	23	4	3	3	5	3	2	8	4	2	3	2			62
22時台②	23	4	3	3	5	3	2	8	4	2	3	2			62
22時台③	23	4	3	3	5	3	2	8	4	2	3	2			62
23時台①	23	4	3	3	5	3	2	8	4	2	3	2			62
23時台②	23	4	3	3	5	3	2	8	4	2	3	2			62
23時台③	23	4	3	3	5	3	2	8	4	2	3	2			62

単位：秒

現示	1 φ	2 φ	3 φ
	[Signal diagram]	[Signal diagram]	[Signal diagram]

信号現示調査表

調査地点：地域社会6 瀬谷中学校前

調査年月日：令和元年5月14日（火）

凡 例	
	青
	赤
	黄
	直進青矢
	直右青矢
	直左青矢
	右折青矢
	左折青矢
	右左折青矢
	歩行者青点滅



現示 灯器 階梯	1 φ				2 φ			3 φ				4 φ				合計
	1	2	3	4	5	6	7	8	9	10	11	12	13	14		
A																
B																
a																
b																
7時台①	25	8	2	3	8	3	2	20	10	2	3	9	3	2	100	
7時台②	25	8	2	3	8	3	2	20	10	2	3	9	3	2	100	
7時台③	25	8	2	3	8	3	2	20	10	2	3	9	3	2	100	
8時台①	25	8	2	3	8	3	2	20	10	2	3	9	3	2	100	
8時台②	25	8	2	3	8	3	2	20	10	2	3	9	3	2	100	
8時台③	25	8	2	3	8	3	2	20	10	2	3	9	3	2	100	
12時台①	19	8	2	3	6	3	2	20	10	2	3	7	3	2	90	
12時台②	19	8	2	3	6	3	2	20	10	2	3	7	3	2	90	
12時台③	19	8	2	3	6	3	2	20	10	2	3	7	3	2	90	
13時台①	19	8	2	3	6	3	2	20	10	2	3	7	3	2	90	
13時台②	19	8	2	3	6	3	2	20	10	2	3	7	3	2	90	
13時台③	19	8	2	3	6	3	2	20	10	2	3	7	3	2	90	
17時台①	23	8	2	3	6	3	2	20	10	2	3	13	3	2	100	
17時台②	23	8	2	3	6	3	2	20	10	2	3	13	3	2	100	
17時台③	23	8	2	3	6	3	2	20	10	2	3	13	3	2	100	
18時台①	23	8	2	3	6	3	2	20	10	2	3	13	3	2	100	
18時台②	23	8	2	3	6	3	2	20	10	2	3	13	3	2	100	
18時台③	23	8	2	3	6	3	2	20	10	2	3	13	3	2	100	
22時台①	16	8	2	3	4	3	2	18	10	2	3	4	3	2	80	
22時台②	16	8	2	3	4	3	2	18	10	2	3	4	3	2	80	
22時台③	16	8	2	3	4	3	2	18	10	2	3	4	3	2	80	
23時台①	16	8	2	3	4	3	2	18	10	2	3	4	3	2	80	
23時台②	16	8	2	3	4	3	2	18	10	2	3	4	3	2	80	
23時台③	16	8	2	3	4	3	2	18	10	2	3	4	3	2	80	

単位：秒

現示	1 φ	2 φ	3 φ	4 φ

信号現示調査表

調査地点：地域社会1 目黒
 調査年月日：令和元年5月11日（土）

凡 例	
	: 青
	: 赤
	: 黄
	: 右折青矢
	: 左折青矢
	: 直進青矢
	: 直右青矢
	: 直左青矢
	: 右左折青矢
	: 右左折青矢
	: 歩行者青点滅

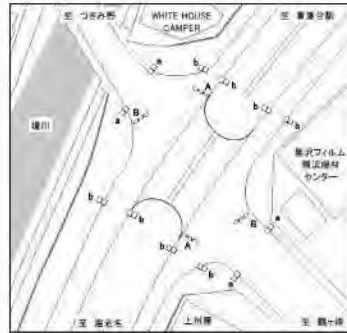

現示 灯器 階梯	1 φ					2 φ			3 φ				4 φ			合計
	1	2	3	4	5	6	7	8	9	10	11	12	13	14	15	
A																
B																
a																
b																
22時台①	24	8	2	3	1	27	3	2	58	8	2	3	5	3	2	151
22時台②	24	8	2	3	1	24	3	2	59	8	2	3	5	3	2	149
22時台③	24	8	2	3	1	22	3	2	60	8	2	3	6	3	2	149
23時台①	24	8	2	3	1	17	3	2	47	8	2	3	6	3	2	131
23時台②	25	8	2	3	1	11	3	2	50	8	2	3	6	3	2	129
23時台③	26	8	2	3	1	12	3	2	50	8	2	3	6	3	2	131
7時台①	30	8	2	3	1	13	3	2	53	8	2	3	6	3	2	139
7時台②	29	8	2	3	1	29	3	2	45	8	2	3	5	3	2	145
7時台③	26	8	2	3	1	15	3	2	49	8	2	3	6	3	2	133
8時台①	25	8	2	3	1	28	3	2	59	8	2	3	9	3	2	158
8時台②	24	8	2	3	1	31	3	2	54	8	2	3	4	3	2	150
8時台③	22	8	2	3	1	30	3	2	56	8	2	3	4	3	2	149
12時台①	24	8	2	3	1	21	3	2	60	8	2	3	6	3	2	148
12時台②	25	8	2	3	1	18	3	2	62	8	2	3	6	3	2	148
12時台③	26	8	2	3	1	34	3	2	56	8	2	3	5	3	2	158
13時台①	22	8	2	3	1	15	3	2	62	8	2	3	6	3	2	142
13時台②	26	8	2	3	1	33	3	2	56	8	2	3	5	3	2	157
13時台③	22	8	2	3	1	31	3	2	56	8	2	3	5	3	2	151
17時台①	26	8	2	3	1	25	3	2	57	8	2	3	5	3	2	150
17時台②	23	8	2	3	1	24	3	2	59	8	2	3	5	3	2	148
17時台③	24	8	2	3	1	32	3	2	56	8	2	3	11	3	2	160
18時台①	22	8	2	3	1	23	3	2	58	8	2	3	5	3	2	145
18時台②	24	8	2	3	1	32	3	2	56	8	2	3	5	3	2	154
18時台③	22	8	2	3	1	16	3	2	62	8	2	3	6	3	2	143

単位：秒

現示	1 φ	2 φ	3 φ	4 φ

信号現示調査表

調査地点：地域社会2 目黒交番前
 調査年月日：令和元年5月11日（土）

	青		直進青矢
	赤		直右青矢
	黄		直左青矢
	右折青矢		右左折青矢
	左折青矢		歩行者青点滅



現示 灯器 階梯	1φ					2φ			3φ				4φ			合計
	1	2	3	4	5	6	7	8	9	10	11	12	13	14	15	
A																
B																
a																
b																
22時台①	20	9	2	3	1	11	3	2	49	12	2	3	8	3	2	130
22時台②	20	9	2	3	1	11	3	2	64	12	2	3	6	3	2	143
22時台③	18	9	2	3	1	12	3	2	81	12	2	3	9	3	2	162
23時台①	20	9	2	3	1	13	3	2	38	12	2	3	6	3	2	119
23時台②	20	9	2	3	1	8	3	2	49	12	2	3	8	3	2	127
23時台③	20	9	2	3	1	11	3	2	49	12	2	3	8	3	2	130
7時台①	20	9	2	3	1	11	3	2	49	12	2	3	8	3	2	130
7時台②	20	9	2	3	1	11	3	2	50	12	2	3	8	3	2	131
7時台③	20	9	2	3	1	11	3	2	48	12	2	3	8	3	2	129
8時台①	20	9	2	3	1	11	3	2	49	12	2	3	8	3	2	130
8時台②	20	9	2	3	1	11	3	2	49	12	2	3	8	3	2	130
8時台③	20	9	2	3	1	11	3	2	48	12	2	3	8	3	2	129
12時台①	18	9	2	3	1	13	3	2	69	12	2	3	7	3	2	149
12時台②	18	9	2	3	1	13	3	2	71	12	2	3	7	3	2	151
12時台③	18	9	2	3	1	13	3	2	69	12	2	3	7	3	2	149
13時台①	18	9	2	3	1	13	3	2	71	12	2	3	7	3	2	151
13時台②	18	9	2	3	1	13	3	2	70	12	2	3	7	3	2	150
13時台③	18	9	2	3	1	13	3	2	70	12	2	3	7	3	2	150
17時台①	20	9	2	3	1	14	3	2	75	12	2	3	8	3	2	159
17時台②	20	9	2	3	1	14	3	2	76	12	2	3	8	3	2	160
17時台③	20	9	2	3	1	14	3	2	75	12	2	3	8	3	2	159
18時台①	20	9	2	3	1	14	3	2	76	12	2	3	8	3	2	160
18時台②	20	9	2	3	1	14	3	2	68	12	2	3	7	3	2	151
18時台③	18	9	2	3	1	13	3	2	70	12	2	3	7	3	2	150

単位：秒

現示	1φ	2φ	3φ	4φ

信号現示調査表

調査地点：地域社会4 滝沢
 調査年月日：令和2年9月26日（土）



凡 例	
: 青	: 直進青矢
: 赤	: 直右青矢
: 黄	: 直左青矢
: 右折青矢	: 右左折青矢
: 左折青矢	: 歩行者青点滅

灯器 階梯	1φ			2φ				3φ						合計	
	1	2	3	4	5	6	7	8	9	10	11	12	13		14
A															
B															
C															
a															
b															
22時台①	30	8	1	3	8	3	2	25	8	1	3	3			95
22時台②	30	8	1	3	8	3	2	25	8	1	3	3			95
22時台③	30	8	1	3	8	3	2	25	8	1	3	3			95
23時台①	30	8	1	3	8	3	2	25	8	1	3	3			95
23時台②	30	8	1	3	8	3	2	25	8	1	3	3			95
23時台③	30	8	1	3	8	3	2	25	8	1	3	3			95
7時台①	30	8	1	3	8	3	2	25	8	1	3	3			95
7時台②	30	8	1	3	8	3	2	25	8	1	3	3			95
7時台③	30	8	1	3	8	3	2	25	8	1	3	3			95
8時台①	35	8	1	3	8	3	2	25	8	1	3	3			100
8時台②	35	8	1	3	8	3	2	25	8	1	3	3			100
8時台③	35	8	1	3	8	3	2	25	8	1	3	3			100
12時台①	42	8	1	3	8	3	2	28	8	1	3	3			110
12時台②	42	8	1	3	8	3	2	28	8	1	3	3			110
12時台③	35	8	1	3	8	3	2	25	8	1	3	3			100
13時台①	33	8	1	3	8	3	2	27	8	1	3	3			100
13時台②	39	8	1	3	8	3	2	31	8	1	3	3			110
13時台③	39	8	1	3	8	3	2	31	8	1	3	3			110
17時台①	42	8	1	3	8	3	2	28	8	1	3	3			110
17時台②	35	8	1	3	8	3	2	25	8	1	3	3			100
17時台③	35	8	1	3	8	3	2	25	8	1	3	3			100
18時台①	33	8	1	3	8	3	2	27	8	1	3	3			100
18時台②	35	8	1	3	8	3	2	25	8	1	3	3			100
18時台③	37	8	1	3	8	3	2	23	8	1	3	3			100

単位：秒

現 示	1φ	2φ	3φ

信号現示調査表

調査地点 : 地域社会4 瀬谷土橋公園入口

調査年月日 : 令和2年9月26日 (土)

凡 例	
— (青)	(→) : 直進青矢
— (赤)	(→) : 直右青矢
— (黄)	(→) : 直左青矢
(→)	(→) : 右折青矢
(→)	(→) : 左折青矢
	: 歩行者青点滅



灯器 階梯	1 φ			2 φ		3 φ			4 φ					合計	
	1	2	3	4	5	6	7	8	9	10	11	12	13		14
A	(→)	(→)	(→)	(→)	(→)										
B															
C															
a															
b															
22時台①	29	10	2	3	2	10	3	2	17	10	2	3	2		95
22時台②	29	10	2	3	2	10	3	2	17	10	2	3	2		95
22時台③	29	10	2	3	2	10	3	2	17	10	2	3	2		95
23時台①	20	10	2	3	2	7	3	2	17	10	2	3	2		83
23時台②	29	10	2	3	2	10	3	2	17	10	2	3	2		95
23時台③	35	10	2	3	2	12	3	2	21	10	2	3	2		107
7時台①	29	10	2	3	2	10	3	2	17	10	2	3	2		95
7時台②	29	10	2	3	2	10	3	2	17	10	2	3	2		95
7時台③	29	10	2	3	2	10	3	2	17	10	2	3	2		95
8時台①	30	10	2	3	2	12	3	2	24	10	2	3	2		105
8時台②	27	10	2	3	2	10	3	2	22	10	2	3	2		98
8時台③	28	10	2	3	2	11	3	2	22	10	2	3	2		100
12時台①	27	10	2	3	2	11	3	2	21	10	2	3	2		98
12時台②	35	10	2	3	2	12	3	2	21	10	2	3	2		107
12時台③	37	10	2	3	2	14	3	2	26	10	2	3	2		116
13時台①	38	10	2	3	2	13	3	2	20	10	2	3	2		110
13時台②	37	10	2	3	2	12	3	2	20	10	2	3	2		108
13時台③	38	10	2	3	2	13	3	2	20	10	2	3	2		110
17時台①	31	10	2	3	2	11	3	2	19	10	2	3	2		100
17時台②	34	10	2	3	2	12	3	2	21	10	2	3	2		106
17時台③	31	10	2	3	2	11	3	2	19	10	2	3	2		100
18時台①	31	10	2	3	2	11	3	2	19	10	2	3	2		100
18時台②	31	10	2	3	2	11	3	2	19	10	2	3	2		100
18時台③	32	10	2	3	2	12	3	2	19	10	2	3	2		102

単位 : 秒

現示	1 φ	2 φ	3 φ	4 φ

信号現示調査表

調査地点：地域社会5

調査年月日：令和元年5月11日（土）

凡 例	
— (青)	① (直進青矢)
— (赤)	② (直右青矢)
— (黄)	③ (直左青矢)
④ (右折青矢)	⑤ (右左折青矢)
⑥ (左折青矢)	(歩行者青点滅)



現示 灯器 階梯	1 φ				2 φ			3 φ					13	14	合計
	1	2	3	4	5	6	7	8	9	10	11	12			
A				黄											
B						黄									
C												黄			
a		歩													
b										歩					
22時台①	23	4	3	3	5	3	2	8	4	2	3	2			62
22時台②	23	4	3	3	5	3	2	8	4	5	3	2			65
22時台③	23	4	3	3	5	3	2	8	4	5	3	2			65
23時台①	23	4	3	3	5	3	2	8	4	5	3	2			65
23時台②	23	4	3	3	5	3	2	8	4	5	3	2			65
23時台③	23	4	3	3	5	3	2	8	4	5	3	2			65
7時台①	26	4	3	3	5	3	2	10	4	2	3	2			67
7時台②	26	4	3	3	5	3	2	10	4	2	3	2			67
7時台③	26	4	3	3	5	3	2	10	4	2	3	2			67
8時台①	26	4	3	3	5	3	2	10	4	2	3	2			67
8時台②	26	4	3	3	5	3	2	10	4	2	3	2			67
8時台③	26	4	3	3	5	3	2	10	4	2	3	2			67
12時台①	34	4	3	3	5	3	2	10	4	7	3	2			80
12時台②	34	4	3	3	5	3	2	10	4	7	3	2			80
12時台③	34	4	3	3	5	3	2	10	4	3	3	2			76
13時台①	37	4	3	3	7	3	2	10	4	7	3	2			85
13時台②	37	4	3	3	7	3	2	10	4	7	3	2			85
13時台③	37	4	3	3	7	3	2	10	4	7	3	2			85
17時台①	37	4	3	3	7	3	2	10	4	3	3	2			81
17時台②	37	4	3	3	7	3	2	10	4	7	3	2			85
17時台③	37	4	3	3	7	3	2	10	4	7	3	2			85
18時台①	34	4	3	3	5	3	2	10	4	3	3	2			76
18時台②	34	4	3	3	5	3	2	10	4	3	3	2			76
18時台③	34	4	3	3	5	3	2	10	4	3	3	2			76

単位：秒

現示	1 φ	2 φ	3 φ

信号現示調査表

調査地点 : 地域社会6 瀬谷中学校前
 調査年月日 : 令和元年5月11日(土)

凡例	
	青
	赤
	黄
	右折青矢
	左折青矢
	直進青矢
	直右青矢
	直左青矢
	右左折青矢
	歩行者青点滅



現示 灯器 階梯	1φ				2φ			3φ				4φ				合計	
	1	2	3	4	5	6	7	8	9	10	11	12	13	14			
A																	
B																	
a																	
b																	
22時台①	16	8	2	3	4	3	2	18	10	2	3	4	3	2	80		
22時台②	16	8	2	3	4	3	2	18	10	2	3	4	3	2	80		
22時台③	16	8	2	3	4	3	2	18	10	2	3	4	3	2	80		
23時台①	16	8	2	3	4	3	2	18	10	2	3	4	3	2	80		
23時台②	16	8	2	3	4	3	2	18	10	2	3	4	3	2	80		
23時台③	16	8	2	3	4	3	2	18	10	2	3	4	3	2	80		
7時台①	19	8	2	3	6	3	2	20	10	2	3	7	3	2	90		
7時台②	19	8	2	3	6	3	2	20	10	2	3	7	3	2	90		
7時台③	19	8	2	3	6	3	2	20	10	2	3	7	3	2	90		
8時台①	19	8	2	3	6	3	2	20	10	2	3	7	3	2	90		
8時台②	19	8	2	3	6	3	2	20	10	2	3	7	3	2	90		
8時台③	19	8	2	3	6	3	2	20	10	2	3	7	3	2	90		
12時台①	25	8	2	3	8	3	2	20	10	2	3	9	3	2	100		
12時台②	25	8	2	3	8	3	2	20	10	2	3	9	3	2	100		
12時台③	25	8	2	3	8	3	2	20	10	2	3	9	3	2	100		
13時台①	25	8	2	3	8	3	2	20	10	2	3	9	3	2	100		
13時台②	25	8	2	3	8	3	2	20	10	2	3	9	3	2	100		
13時台③	25	8	2	3	8	3	2	20	10	2	3	9	3	2	100		
17時台①	25	8	2	3	8	3	2	20	10	2	3	9	3	2	100		
17時台②	25	8	2	3	8	3	2	20	10	2	3	9	3	2	100		
17時台③	25	8	2	3	8	3	2	20	10	2	3	9	3	2	100		
18時台①	25	8	2	3	8	3	2	20	10	2	3	9	3	2	100		
18時台②	25	8	2	3	8	3	2	20	10	2	3	9	3	2	100		
18時台③	25	8	2	3	8	3	2	20	10	2	3	9	3	2	100		

単位: 秒

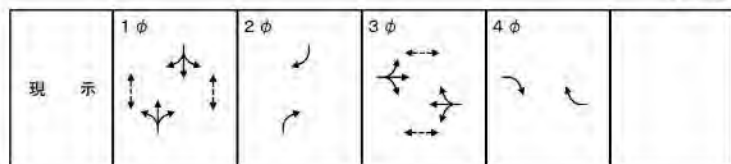

信号現示調査表

調査地点：地域社会1 目黒
 調査年月日：令和元年10月13日（日）

	青		直進青矢
	赤		直右青矢
	黄		直左青矢
	右折青矢		右左折青矢
	左折青矢		歩行者青点滅

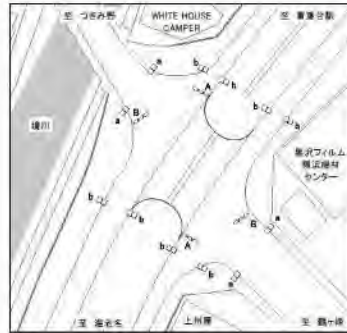

現示 灯器 階梯	1φ					2φ			3φ				4φ			合計
	1	2	3	4	5	6	7	8	9	10	11	12	13	14	15	
A																
B																
a																
b																
22時台①	26	8	2	3	1	10	3	2	48	8	2	3	6	3	2	127
22時台②	26	8	2	3	1	14	3	2	50	8	2	3	5	3	2	132
22時台③	26	8	2	3	1	14	3	2	47	8	2	3	6	3	2	130
23時台①	23	8	2	3	1	10	3	2	48	8	2	3	6	3	2	124
23時台②	25	8	2	3	1	10	3	2	51	8	2	3	6	3	2	129
23時台③	23	8	2	3	1	10	3	2	48	8	2	3	5	3	2	123
7時台①	24	8	2	3	1	16	3	2	60	8	2	3	6	3	2	143
7時台②	24	8	2	3	1	16	3	2	56	8	2	3	6	3	2	139
7時台③	27	8	2	3	1	16	3	2	56	8	2	3	6	3	2	142
8時台①	25	8	2	3	1	26	3	2	60	8	2	3	7	3	2	155
8時台②	24	8	2	3	1	32	3	2	56	8	2	3	5	3	2	154
8時台③	26	8	2	3	1	32	3	2	56	8	2	3	6	3	2	157
12時台①	25	8	2	3	1	32	3	2	60	8	2	3	6	3	2	160
12時台②	20	8	2	3	1	16	3	2	60	8	2	3	6	3	2	139
12時台③	20	8	2	3	1	16	3	2	60	8	2	3	5	3	2	138
13時台①	20	8	2	3	1	16	3	2	64	8	2	3	6	3	2	143
13時台②	25	8	2	3	1	32	3	2	59	8	2	3	6	3	2	159
13時台③	25	8	2	3	1	32	3	2	64	8	2	3	6	3	2	164
17時台①	22	8	2	3	1	30	3	2	60	8	2	3	6	3	2	155
17時台②	25	8	2	3	1	30	3	2	60	8	2	3	6	3	2	158
17時台③	23	8	2	3	1	30	3	2	58	8	2	3	5	3	2	153
18時台①	25	8	2	3	1	20	3	2	62	8	2	3	6	3	2	150
18時台②	25	8	2	3	1	30	3	2	62	8	2	3	6	3	2	160
18時台③	23	8	2	3	1	30	3	2	60	8	2	3	6	3	2	156

単位：秒

現示	1φ	2φ	3φ	4φ

信号現示調査表

調査地点：地域社会2 目黒交番前
 調査年月日：令和元年10月13日（日）

	青		直進青矢
	赤		直右青矢
	黄		直左青矢
	右折青矢		右左折青矢
	左折青矢		歩行者青点滅



現示 灯器 階梯	1 φ					2 φ			3 φ				4 φ			合計
	1	2	3	4	5	6	7	8	9	10	11	12	13	14	15	
A																
B																
a																
b																
22時台①	21	9	2	3	1	11	3	2	44	17	3	3	10	3	2	134
22時台②	26	9	2	3	1	13	3	2	51	17	3	3	11	3	2	149
22時台③	26	9	2	3	1	14	3	2	51	17	3	3	11	3	2	150
23時台①	21	9	2	3	1	11	3	2	45	17	3	3	10	3	2	135
23時台②	21	9	2	3	1	11	3	2	45	17	3	3	10	3	2	135
23時台③	21	9	2	3	1	11	3	2	45	17	3	3	10	3	2	135
7時台①	26	9	2	3	1	13	3	2	53	17	3	3	11	3	2	151
7時台②	26	9	2	3	1	13	3	2	52	17	3	3	11	3	2	150
7時台③	26	9	2	3	1	13	3	2	54	17	3	3	11	3	2	152
8時台①	26	9	2	3	1	13	3	2	53	17	3	3	11	3	2	151
8時台②	26	9	2	3	1	13	3	2	51	17	3	3	11	3	2	149
8時台③	26	9	2	3	1	13	3	2	52	17	3	3	11	3	2	150
12時台①	26	9	2	3	1	13	3	2	53	17	3	3	11	3	2	151
12時台②	26	9	2	3	1	13	3	2	51	17	3	3	11	3	2	149
12時台③	26	9	2	3	1	13	3	2	52	17	3	3	11	3	2	150
13時台①	26	9	2	3	1	13	3	2	52	17	3	3	11	3	2	150
13時台②	26	9	2	3	1	13	3	2	51	17	3	3	11	3	2	149
13時台③	26	9	2	3	1	13	3	2	52	17	3	3	11	3	2	150
17時台①	18	9	2	3	1	16	3	2	75	17	3	3	8	3	2	165
17時台②	18	9	2	3	1	16	3	2	74	17	3	3	8	3	2	164
17時台③	18	9	2	3	1	16	3	2	75	17	3	3	8	3	2	165
18時台①	18	9	2	3	1	16	3	2	74	17	3	3	8	3	2	164
18時台②	18	9	2	3	1	16	3	2	75	17	3	3	8	3	2	165
18時台③	18	9	2	3	1	16	3	2	75	17	3	3	8	3	2	165

単位：秒

現示	1 φ	2 φ	3 φ	4 φ

信号現示調査表

調査地点：地域社会3 上川井IC
 調査年月日：令和元年10月13日（日）

凡例

	青		直進青矢
	赤		直右青矢
	黄		直左青矢
	右折青矢		右左折青矢
	左折青矢		歩行者青点滅



現示 灯器 階梯	1φ			2φ				3φ								合計
	1	2	3	4	5	6	7	8	9	10	11	12	13	14		
A																
B																
a																
b																
22時台①	20	3	3	24	5	3	2	36	7	3	4				110	
22時台②	20	3	3	24	5	3	2	36	7	3	4				110	
22時台③	20	3	3	24	5	3	2	36	7	3	4				110	
23時台①	20	3	3	24	5	3	2	36	7	3	4				110	
23時台②	20	3	3	24	5	3	2	36	7	3	4				110	
23時台③	20	3	3	24	5	3	2	36	7	3	4				110	
7時台①	20	3	3	24	5	3	2	36	7	3	4				110	
7時台②	20	3	3	24	5	3	2	36	7	3	4				110	
7時台③	20	3	3	24	5	3	2	36	7	3	4				110	
8時台①	20	3	3	24	5	3	2	36	7	3	4				110	
8時台②	20	3	3	24	5	3	2	36	7	3	4				110	
8時台③	20	3	3	24	5	3	2	36	7	3	4				110	
12時台①	20	3	3	24	5	3	2	36	7	3	4				110	
12時台②	20	3	3	24	5	3	2	36	7	3	4				110	
12時台③	20	3	3	24	5	3	2	36	7	3	4				110	
13時台①	20	3	3	24	5	3	2	36	7	3	4				110	
13時台②	20	3	3	24	5	3	2	36	7	3	4				110	
13時台③	20	3	3	24	5	3	2	36	7	3	4				110	
17時台①	20	3	3	24	5	3	2	36	7	3	4				110	
17時台②	20	3	3	24	5	3	2	36	7	3	4				110	
17時台③	20	3	3	24	5	3	2	36	7	3	4				110	
18時台①	20	3	3	24	5	3	2	36	7	3	4				110	
18時台②	20	3	3	24	5	3	2	36	7	3	4				110	
18時台③	20	3	3	24	5	3	2	36	7	3	4				110	

単位：秒

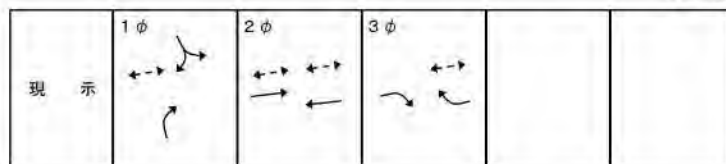

信号現示調査表

調査地点：地域社会4 滝沢
 調査年月日：令和2年9月21日（月）



凡 例			
	青		直進青矢
	赤		直右青矢
	黄		直左青矢
	右折青矢		右左折青矢
	左折青矢		歩行者青点滅

灯器 階梯	1φ			2φ				3φ						合計	
	1	2	3	4	5	6	7	8	9	10	11	12	13		14
A															
B															
C															
a															
b															
7時台①	28	8	1	3	8	3	2	22	8	1	3	3			90
7時台②	28	8	1	3	8	3	2	22	8	1	3	3			90
7時台③	28	8	1	3	8	3	2	22	8	1	3	3			90
8時台①	28	8	1	3	8	3	2	22	8	1	3	3			90
8時台②	50	8	1	3	8	3	2	27	8	1	3	3			117
8時台③	45	8	1	3	8	3	2	25	8	1	3	3			110
12時台①	45	8	1	3	8	3	2	25	8	1	3	3			110
12時台②	45	8	1	3	8	3	2	25	8	1	3	3			110
12時台③	28	8	1	3	8	3	2	22	8	1	3	3			90
13時台①	37	8	1	3	8	3	2	23	8	1	3	3			100
13時台②	45	8	1	3	8	3	2	25	8	1	3	3			110
13時台③	35	8	1	3	8	3	2	25	8	1	3	3			100
17時台①	35	8	1	3	8	3	2	25	8	1	3	3			100
17時台②	35	8	1	3	8	3	2	25	8	1	3	3			100
17時台③	28	8	1	3	8	3	2	22	8	1	3	3			90
18時台①	28	8	1	3	8	3	2	22	8	1	3	3			90
18時台②	50	8	1	3	8	3	2	34	8	1	3	3			124
18時台③	28	8	1	3	8	3	2	22	8	1	3	3			90
22時台①	30	8	1	3	8	3	2	25	8	1	3	3			95
22時台②	30	8	1	3	8	3	2	25	8	1	3	3			95
22時台③	30	8	1	3	8	3	2	25	8	1	3	3			95
23時台①	30	8	1	3	8	3	2	25	8	1	3	3			95
23時台②	39	8	1	3	8	3	2	31	8	1	3	3			110
23時台③	30	8	1	3	8	3	2	25	8	1	3	3			95

単位：秒

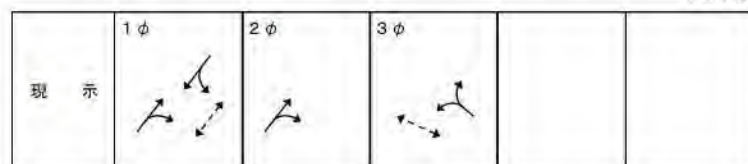

信号現示調査表

調査地点：地域社会4 瀬谷土橋公園入口

調査年月日：令和2年9月21日（月）

凡 例	
：青	：直進青矢
：赤	：直右青矢
：黄	：直左青矢
：右折青矢	：右左折青矢
：左折青矢	：歩行者青点滅



灯器 階梯	1 φ			2 φ		3 φ			4 φ						合計
	1	2	3	4	5	6	7	8	9	10	11	12	13	14	
A															
B															
C															
a															
b															
7時台①	30	10	2	3	2	10	3	2	24	10	2	3	2		103
7時台②	32	10	2	3	2	6	3	2	24	10	2	3	2		101
7時台③	41	10	2	3	2	7	3	2	21	10	2	3	2		108
8時台①	49	10	2	3	2	5	3	2	17	10	2	3	2		110
8時台②	49	10	2	3	2	5	3	2	17	10	2	3	2		110
8時台③	49	10	2	3	2	5	3	2	17	10	2	3	2		110
12時台①	43	10	2	3	2	14	3	2	18	10	2	3	2		114
12時台②	40	10	2	3	2	12	3	2	17	10	2	3	2		108
12時台③	42	10	2	3	2	13	3	2	17	10	2	3	2		111
13時台①	47	10	2	3	2	6	3	2	20	10	2	3	2		112
13時台②	41	10	2	3	2	11	3	2	18	10	2	3	2		109
13時台③	36	10	2	3	2	5	3	2	18	10	2	3	2		98
17時台①	43	10	2	3	2	6	3	2	16	10	2	3	2		104
17時台②	41	10	2	3	2	7	3	2	21	10	2	3	2		108
17時台③	42	10	2	3	2	11	3	2	17	10	2	3	2		109
18時台①	40	10	2	3	2	12	3	2	17	10	2	3	2		108
18時台②	42	10	2	3	2	13	3	2	17	10	2	3	2		111
18時台③	42	10	2	3	2	13	3	2	17	10	2	3	2		111
22時台①	34	10	2	3	2	5	3	2	17	10	2	3	2		95
22時台②	34	10	2	3	2	5	3	2	17	10	2	3	2		95
22時台③	34	10	2	3	2	5	3	2	17	10	2	3	2		95
23時台①	34	10	2	3	2	5	3	2	17	10	2	3	2		95
23時台②	34	10	2	3	2	5	3	2	17	10	2	3	2		95
23時台③	34	10	2	3	2	5	3	2	17	10	2	3	2		95

単位：秒

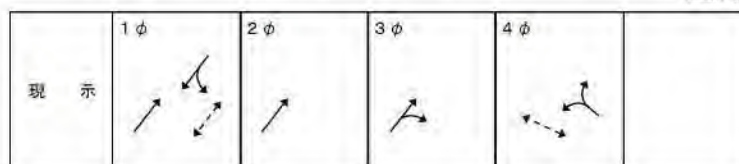

信号現示調査表

調査地点：地域社会5

調査年月日：令和元年10月13日（日）

凡 例	
— (青)	① (直進青矢)
— (赤)	② (直右青矢)
— (黄)	③ (直左青矢)
④ (右折青矢)	⑤ (右左折青矢)
⑥ (左折青矢)	(歩行者青点滅)

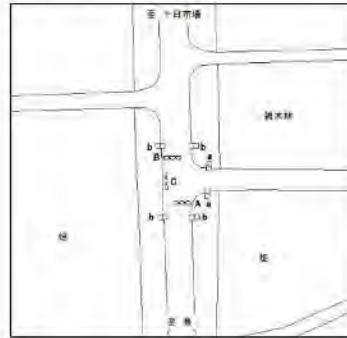

現示 灯器 階梯	1 φ				2 φ			3 φ				13	14	合計	
	1	2	3	4	5	6	7	8	9	10	11				12
A	— (青)				— (赤)			— (黄)							
B	— (赤)				— (黄)			— (青)							
C	— (黄)				— (青)			— (赤)							
a	(歩行者青点滅)				— (赤)			— (黄)							
b	— (赤)				— (黄)			— (青)							
22時台①	23	4	3	3	5	3	2	8	4	2	3	2			62
22時台②	23	4	3	3	5	3	2	8	4	2	3	2			62
22時台③	23	4	3	3	5	3	2	8	4	2	3	2			62
23時台①	23	4	3	3	5	3	2	8	4	2	3	2			62
23時台②	23	4	3	3	5	3	2	8	4	2	3	2			62
23時台③	23	4	3	3	5	3	2	8	4	2	3	2			62
7時台①	26	4	3	3	5	3	2	10	4	2	3	2			67
7時台②	26	4	3	3	5	3	2	10	4	2	3	2			67
7時台③	26	4	3	3	5	3	2	10	4	2	3	2			67
8時台①	32	4	3	3	7	3	2	10	4	3	3	2			76
8時台②	32	4	3	3	7	3	2	10	4	3	3	2			76
8時台③	32	4	3	3	7	3	2	10	4	3	3	2			76
12時台①	37	4	3	3	7	3	2	10	4	4	3	2			82
12時台②	37	4	3	3	7	3	2	10	4	4	3	2			82
12時台③	37	4	3	3	7	3	2	10	4	4	3	2			82
13時台①	39	4	3	3	7	3	2	12	4	4	3	2			86
13時台②	39	4	3	3	7	3	2	12	4	4	3	2			86
13時台③	39	4	3	3	7	3	2	12	4	4	3	2			86
17時台①	37	4	3	3	7	3	2	10	4	4	3	2			82
17時台②	37	4	3	3	7	3	2	10	4	4	3	2			82
17時台③	37	4	3	3	7	3	2	10	4	4	3	2			82
18時台①	34	4	3	3	5	3	2	10	4	2	3	2			75
18時台②	34	4	3	3	5	3	2	10	4	2	3	2			75
18時台③	34	4	3	3	5	3	2	10	4	2	3	2			75

単位：秒

現 示	1 φ	2 φ	3 φ

信号現示調査表

調査地点：地域社会6 瀬谷中学校前
 調査年月日：令和元年10月13日（日）

凡 例	
— : 青	① : 直進青矢
— : 赤	② : 直右青矢
— : 黄	③ : 直左青矢
④ : 右折青矢	⑤ : 右左折青矢
⑥ : 左折青矢	: 歩行者青点滅



現示 灯器 階梯	1 φ				2 φ			3 φ				4 φ				合計
	1	2	3	4	5	6	7	8	9	10	11	12	13	14		
A	— — — —				— — —			— — — —				— — — —				
B	— — — —				— — —			— — — —				— — — —				
a					— — —			— — — —				— — — —				
b	— — — —				— — —			— — — —				— — — —				
22時台①	16	8	2	3	4	3	2	18	10	2	3	4	3	2	80	
22時台②	16	8	2	3	4	3	2	18	10	2	3	4	3	2	80	
22時台③	16	8	2	3	4	3	2	18	10	2	3	4	3	2	80	
23時台①	16	8	2	3	4	3	2	18	10	2	3	4	3	2	80	
23時台②	16	8	2	3	4	3	2	18	10	2	3	4	3	2	80	
23時台③	16	8	2	3	4	3	2	18	10	2	3	4	3	2	80	
7時台①	19	8	2	3	6	3	2	20	10	2	3	7	3	2	90	
7時台②	19	8	2	3	6	3	2	20	10	2	3	7	3	2	90	
7時台③	19	8	2	3	6	3	2	20	10	2	3	7	3	2	90	
8時台①	19	8	2	3	6	3	2	20	10	2	3	7	3	2	90	
8時台②	19	8	2	3	6	3	2	20	10	2	3	7	3	2	90	
8時台③	19	8	2	3	6	3	2	20	10	2	3	7	3	2	90	
12時台①	25	8	2	3	8	3	2	20	10	2	3	9	3	2	100	
12時台②	25	8	2	3	8	3	2	20	10	2	3	9	3	2	100	
12時台③	25	8	2	3	8	3	2	20	10	2	3	9	3	2	100	
13時台①	25	8	2	3	8	3	2	20	10	2	3	9	3	2	100	
13時台②	25	8	2	3	8	3	2	20	10	2	3	9	3	2	100	
13時台③	25	8	2	3	8	3	2	20	10	2	3	9	3	2	100	
17時台①	25	8	2	3	8	3	2	20	10	2	3	9	3	2	100	
17時台②	25	8	2	3	8	3	2	20	10	2	3	9	3	2	100	
17時台③	25	8	2	3	8	3	2	20	10	2	3	9	3	2	100	
18時台①	25	8	2	3	8	3	2	20	10	2	3	9	3	2	100	
18時台②	25	8	2	3	8	3	2	20	10	2	3	9	3	2	100	
18時台③	25	8	2	3	8	3	2	20	10	2	3	9	3	2	100	

単位：秒

現 示	1 φ	2 φ	3 φ	4 φ

9.17-5 飽和交通流率調査結果

対象事業実施区域周辺の主要交差点（7交差点）において実施した調査結果は、平日はP.資料 地域-912～936、休日はP.資料 地域-937～961に示すとおりです。

飽和交通流率調査 調査結果

調査地点 : 地域社会1 目黒

調査年月日 : 令和元年10月 8日(火) 天候:晴れ



(単位:台・秒・台/有効青1時間)

方向・車線 回数	a 1					a 2									
	捌け台数			通過 時間	飽和 交通 流率	捌け台数			通過 時間	飽和 交通 流率	捌け台数			通過 時間	飽和 交通 流率
	小型車	大型車	二輪車			小型車	大型車	二輪車			小型車	大型車	二輪車		
1	13	3	2	49.44	1165										
2	5	1	0	14.99	1441										
3	6	1	0	20.44	1233										
4	9	0	1	24.44	1326										
5	7	2	0	23.45	1382										
6	15	1	0	47.01	1225										
7	14	1	0	40.19	1344										
8	9	1	0	25.81	1395										
9	12	0	1	31.29	1381										
10	13	1	1	43.39	1162										
11															
12															
平均					1305										

飽和交通流率調査 調査結果

調査地点 : 地域社会1 目黒

調査年月日 : 令和元年10月 8日(火) 天候:晴れ



(単位:台・秒・台/有効青1時間)

方向・車線 回数	b 1					b 2									
	捌け台数			通過 時間	飽和 交通 流率	捌け台数			通過 時間	飽和 交通 流率	捌け台数			通過 時間	飽和 交通 流率
	小型車	大型車	二輪車			小型車	大型車	二輪車			小型車	大型車	二輪車		
1	6	0	0	15.08	1432	5	0	0	14.23	1265					
2	2	0	0	5.19	1387	6	1	0	18.16	1388					
3	4	0	0	12.43	1158	5	2	0	17.39	1449					
4	4	0	0	12.55	1147	7	3	0	18.36	1961					
5	3	0	0	6.65	1624	5	3	1	25.18	1144					
6	3	0	0	7.60	1421	7	2	0	25.73	1259					
7	3	1	0	11.94	1206	5	2	0	21.82	1155					
8	3	0	0	7.42	1456	3	3	0	18.49	1168					
9	4	0	0	10.24	1406	7	1	0	22.39	1286					
10	1	0	0	2.15	1674	6	2	1	24.83	1160					
11															
12															
平均					1391					1324					

飽和交通流率調査 調査結果

調査地点 : 地域社会1 目黒

調査年月日 : 令和元年10月 8日(火) 天候:晴れ



(単位: 台・秒・台/有効青1時間)

方向・車線 回数	c 1					c 2					c 3				
	捌け台数			通過 時間	飽和 交通 流率	捌け台数			通過 時間	飽和 交通 流率	捌け台数			通過 時間	飽和 交通 流率
	小型車	大型車	二輪車			小型車	大型車	二輪車			小型車	大型車	二輪車		
1	10	2	0	43.51	993	13	0	1	35.77	1308	1	0	0	3.92	918
2	9	4	0	32.94	1421	16	0	1	42.49	1356	2	0	0	3.04	2368
3	8	6	0	46.26	1089	17	0	1	39.64	1544					
4	8	5	1	48.62	963	22	2	1	65.40	1321					
5	11	5	0	57.68	999	22	1	1	59.89	1383					
6	8	4	0	42.45	1018	21	1	0	61.04	1298					
7	9	3	0	42.41	1019	10	0	1	26.61	1353					
8	10	8	1	59.12	1096	15	2	1	52.96	1156					
9															
10															
11															
12															
平均					1075					1340					1643

飽和交通流率調査 調査結果

調査地点：地域社会1 目黒

調査年月日：令和元年10月 8日(火) 天候:晴れ



(単位：台・秒・台/有効青1時間)

方向・車線 回数	d 1					d 2									
	捌け台数			通過 時間	飽和 交通 流率	捌け台数			通過 時間	飽和 交通 流率	捌け台数			通過 時間	飽和 交通 流率
	小型車	大型車	二輪車			小型車	大型車	二輪車			小型車	大型車	二輪車		
1	4	1	0	11.12	1619	6	1	0	15.21	1657					
2	2	1	0	7.07	1528	8	1	0	17.94	1806					
3	6	1	0	18.86	1336	7	1	0	14.03	2053					
4	3	0	0	4.95	2182	7	1	0	17.97	1603					
5	6	0	2	17.16	1259	8	0	0	15.64	1841					
6	7	0	0	20.29	1242	7	1	0	20.91	1377					
7	6	0	0	15.92	1357	5	0	0	10.67	1687					
8	3	2	0	16.26	1107	6	0	0	9.06	2384					
9	2	2	1	13.34	1079	7	2	0	19.18	1689					
10	5	1	1	18.57	1163	6	2	0	18.16	1586					
11	2	1	0	6.74	1602	11	0	0	23.77	1666					
12	4	0	0	7.78	1851	8	1	0	21.28	1523					
平均					1444					1739					

飽和交通流率調査 調査結果

調査地点 : 地域社会2 目黒交番前

調査年月日 : 令和元年10月 8日(火) 天候:晴れ

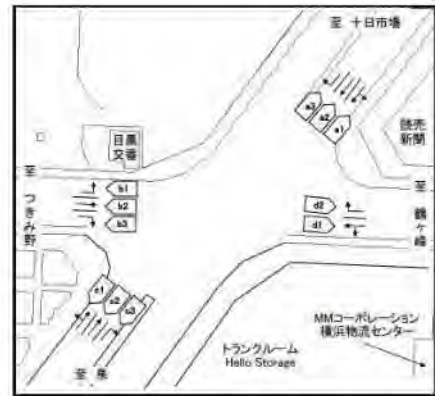

(単位: 台・秒・台/有効青1時間)

方向・車線 回数	a 1					a 2					a 3				
	捌け台数			通過 時間	飽和 交通 流率	捌け台数			通過 時間	飽和 交通 流率	捌け台数			通過 時間	飽和 交通 流率
	小型車	大型車	二輪車			小型車	大型車	二輪車			小型車	大型車	二輪車		
1	8	0	0	18.74	1537	6	0	0	13.71	1575	6	0	0	15.09	1431
2	7	1	0	17.88	1611	5	0	0	8.83	2039	6	0	0	12.16	1776
3	7	0	0	14.54	1733	6	0	0	21.14	1022	4	0	0	8.30	1735
4	10	1	1	21.09	1878	7	0	1	17.86	1411	4	1	0	12.68	1420
5	9	0	0	19.91	1627	3	1	0	9.27	1553	5	2	0	13.25	1902
6	11	0	0	23.83	1662	4	0	0	11.63	1238	5	1	0	11.27	1917
7	13	0	0	24.30	1926	2	1	0	6.28	1720	6	0	0	12.85	1681
8	11	0	0	22.91	1729	3	0	0	5.90	1831	4	3	0	14.26	1767
9	10	0	0	22.34	1611	6	1	0	18.85	1337	7	0	0	13.20	1909
10	8	1	0	25.80	1256	7	2	2	21.85	1483	6	2	0	15.32	1880
11	10	0	0	22.68	1587	5	0	0	12.26	1468	5	1	0	12.84	1682
12	11	0	0	23.90	1657	5	1	0	14.40	1500	5	0	1	10.23	1760
平均					1651					1515					1738

飽和交通流率調査 調査結果

調査地点 : 地域社会2 目黒交番前

調査年月日 : 令和元年10月 8日(火) 天候:晴れ

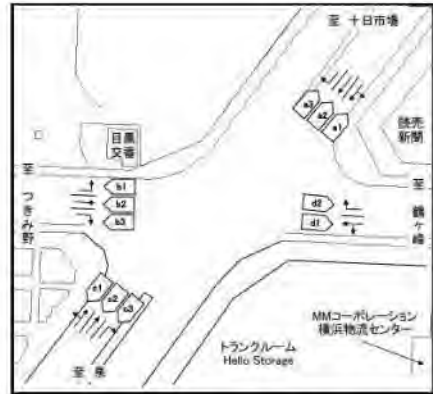

(単位: 台・秒・台/有効青1時間)

方向・車線 回数	b 1					b 2					b 3				
	捌け台数			通過 時間	飽和 交通 流率	捌け台数			通過 時間	飽和 交通 流率	捌け台数			通過 時間	飽和 交通 流率
	小型車	大型車	二輪車			小型車	大型車	二輪車			小型車	大型車	二輪車		
1	1	0	0	3.95	911	14	4	1	49.28	1315	1	0	0	4.41	816
2	1	0	0	2.91	1237	10	5	1	46.04	1173	2	1	0	6.38	1693
3	2	1	1	10.69	1010	12	1	0	31.95	1465	1	0	0	2.65	1358
4	3	0	0	6.60	1636	12	2	0	39.74	1268	1	0	0	1.79	2011
5	1	0	0	5.36	672	22	4	0	67.43	1388	1	0	0	3.21	1121
6	3	1	0	12.97	1110	22	1	3	54.01	1533	1	0	0	3.57	1008
7	8	0	0	30.06	958	12	0	1	30.53	1415	1	0	0	4.92	732
8						7	4	1	29.53	1341					
9						10	5	0	39.89	1354					
10															
11															
12															
平均					1076					1361					1248

飽和交通流率調査 調査結果

調査地点 : 地域社会2 目黒交番前

調査年月日 : 令和元年10月 8日(火) 天候:晴れ

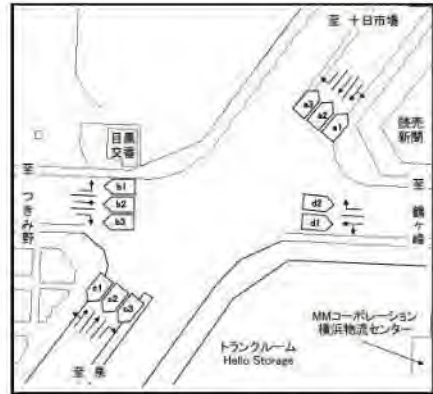

(単位 : 台・秒・台/有効青1時間)

方向・車線 回数	c 1					c 2					c 3				
	捌け台数			通過 時間	飽和 交通 流率	捌け台数			通過 時間	飽和 交通 流率	捌け台数			通過 時間	飽和 交通 流率
	小型車	大型車	二輪車			小型車	大型車	二輪車			小型車	大型車	二輪車		
1	2	1	0	8.87	1218	4	1	0	12.88	1398	3	0	0	7.69	1404
2	5	0	0	12.43	1448	6	0	0	15.75	1371	1	1	0	5.13	1404
3	2	0	0	5.10	1412	7	1	0	21.85	1318	4	1	0	10.59	1700
4						9	2	0	22.81	1736	2	1	0	6.96	1552
5						7	1	0	20.93	1376	3	0	0	6.91	1563
6						6	0	0	15.17	1424	2	0	0	5.01	1437
7						3	0	0	5.24	2061	3	0	0	7.43	1454
8						9	0	0	20.90	1550	1	0	0	2.04	1765
9						8	0	0	21.48	1341	1	0	0	2.49	1446
10						4	0	0	8.05	1789	2	0	0	5.33	1351
11															
12															
平均					1359					1536					1508

飽和交通流率調査 調査結果

調査地点 : 地域社会2 目黒交番前

調査年月日 : 令和元年10月 8日(火) 天候:晴れ

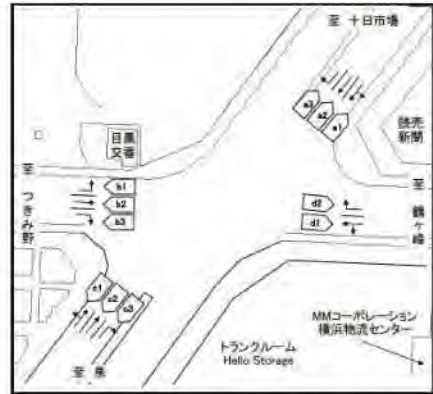

(単位: 台・秒・台/有効青1時間)

方向・車線 回数	d 1																	
	捌け台数				通過 時間	飽和 交通 流率	捌け台数				通過 時間	飽和 交通 流率	捌け台数				通過 時間	飽和 交通 流率
	小型車	大型車	二輪車				小型車	大型車	二輪車				小型車	大型車	二輪車			
1	24	5	3	84.72	1232													
2	23	6	1	79.33	1316													
3	18	4	1	62.66	1264													
4	18	2	0	51.80	1390													
5	22	1	3	58.98	1404													
6	25	4	5	78.15	1336													
7	15	4	2	50.91	1344													
8	19	0	2	50.60	1352													
9																		
10																		
11																		
12																		
平均					1330													

飽和交通流率調査 調査結果

調査地点 : 地域社会3 上川井IC

調査年月日 : 令和元年10月 8日(火) 天候: 晴れ



(単位: 台・秒・台/有効青1時間)

方向・車線 回数	a 1					a 2									
	捌け台数			通過 時間	飽和 交通 流率	捌け台数			通過 時間	飽和 交通 流率	捌け台数			通過 時間	飽和 交通 流率
	小型車	大型車	二輪車			小型車	大型車	二輪車			小型車	大型車	二輪車		
1	4	0	1	10.14	1420	1	1	0	7.22	997					
2	1	4	0	12.45	1446	1	0	0	3.27	1101					
3	2	1	0	8.56	1262										
4	4	1	2	13.71	1313										
5	2	2	0	11.83	1217										
6	3	1	0	12.43	1158										
7	1	2	0	7.94	1360										
8	4	0	0	11.69	1232										
9	4	0	0	7.92	1818										
10	2	1	0	8.87	1218										
11	3	0	1	9.84	1098										
12	3	1	0	10.12	1423										
平均					1330					1049					

飽和交通流率調査 調査結果

調査地点 : 地域社会3 上川井IC

調査年月日 : 令和元年10月 8日(火) 天候: 晴れ



(単位: 台・秒・台/有効青1時間)

方向・車線 回数	b 1					b 2									
	捌け台数			通過 時間	飽和 交通 流率	捌け台数			通過 時間	飽和 交通 流率	捌け台数			通過 時間	飽和 交通 流率
	小型車	大型車	二輪車			小型車	大型車	二輪車			小型車	大型車	二輪車		
1	5	0	0	19.05	945	8	5	0	40.29	1162					
2	4	1	0	12.56	1433	1	6	0	22.98	1097					
3	3	1	0	11.46	1257	4	0	0	7.82	1841					
4	5	1	0	12.18	1773	7	4	0	29.32	1351					
5	4	0	0	10.21	1410	3	0	0	7.52	1436					
6	6	0	0	23.24	929	10	1	0	22.85	1733					
7	6	3	0	17.40	1862	7	1	0	22.15	1300					
8	9	2	1	30.53	1297	6	0	0	13.58	1591					
9	6	1	0	23.74	1061	11	1	0	30.11	1435					
10	5	1	0	16.12	1340	11	3	0	36.78	1370					
11	8	2	0	26.74	1346	5	1	1	16.07	1344					
12	9	1	0	25.86	1392	12	1	0	32.48	1441					
平均					1337					1425					

飽和交通流率調査 調査結果

調査地点 : 地域社会3 上川井IC

調査年月日 : 令和元年10月 8日(火) 天候: 晴れ



(単位: 台・秒・台/有効青1時間)

方向・車線 回数	c 1														
	捌け台数			通過 時間	飽和 交通 流率	捌け台数			通過 時間	飽和 交通 流率	捌け台数			通過 時間	飽和 交通 流率
	小型車	大型車	二輪車			小型車	大型車	二輪車			小型車	大型車	二輪車		
1	4	0	0	12.80	1125										
2	2	1	0	10.02	1078										
3	7	0	0	17.27	1459										
4															
5															
6															
7															
8															
9															
10															
11															
12															
平均					1221										

飽和交通流率調査 調査結果

調査地点 : 地域社会3 上川井IC

調査年月日 : 令和元年10月 8日(火) 天候:晴れ



(単位:台・秒・台/有効青1時間)

方向・車線 回数	d 1					d 2									
	捌け台数			通過 時間	飽和 交通 流率	捌け台数			通過 時間	飽和 交通 流率	捌け台数			通過 時間	飽和 交通 流率
	小型車	大型車	二輪車			小型車	大型車	二輪車			小型車	大型車	二輪車		
1	6	0	2	15.75	1371	3	0	0	6.64	1627					
2	7	0	0	18.78	1342	3	1	1	12.18	1182					
3	9	0	0	21.36	1517	7	0	0	16.24	1552					
4						5	1	0	19.51	1107					
5						7	1	0	19.41	1484					
6						5	0	0	11.47	1569					
7						7	0	1	16.48	1529					
8						3	1	0	13.41	1074					
9						2	0	0	5.78	1246					
10						6	1	0	17.32	1455					
11						6	1	1	18.92	1332					
12						6	0	0	18.19	1187					
平均					1410					1362					

飽和交通流率調査 調査結果

調査地点：地域社会4 滝沢

調査年月日：令和 2年11月25日(水) 天候：曇り

調査時間帯：16時～18時台



(単位：台・秒・台/有効青1時間)

方向・車線 回数	a 1					a 2									
	捌け台数			通過 時間	飽和 交通 流率	捌け台数			通過 時間	飽和 交通 流率	捌け台数			通過 時間	飽和 交通 流率
	小型車	大型車	二輪車			小型車	大型車	二輪車			小型車	大型車	二輪車		
1	5	2	0	18.55	1,358	2	0	0	5.03	1,431					
2	4	0	0	9.47	1,521	4	1	0	11.27	1,597					
3	8	0	0	20.04	1,437	4	0	0	10.77	1,337					
4	8	1	0	21.08	1,537	1	0	0	2.26	1,593					
5	13	0	1	31.46	1,488										
6	10	1	0	25.34	1,563										
7	5	0	0	11.34	1,587										
8	7	0	0	17.17	1,468										
9	10	1	1	27.25	1453										
10	7	0	0	15.31	1,646										
11	6	0	0	12.14	1,779										
12	10	0	0	21.85	1,648										
回数平均					1,540					1,490					

飽和交通流率調査 調査結果

調査地点：地域社会4 滝沢

調査年月日：令和 2年11月25日(水) 天候：曇り

調査時間帯：16時～18時台



(単位：台・秒・台/有効青1時間)

方向・車線 回数	b 1					b 2					b 3				
	捌け台数			通過 時間	飽和 交通 流率	捌け台数			通過 時間	飽和 交通 流率	捌け台数			通過 時間	飽和 交通 流率
	小型車	大型車	二輪車			小型車	大型車	二輪車			小型車	大型車	二輪車		
1	6	0	0	14.81	1,458	6	0	0	15.79	1,368					
2	2	1	0	7.61	1,419	5	0	0	11.62	1,549					
3	2	0	0	5.32	1,353	2	0	0	5.04	1,429					
4	6	0	0	13.89	1,555	5	0	0	11.94	1,508					
5	2	0	0	3.87	1,860	8	0	1	15.67	1,838					
6	7	0	0	16.71	1,508	5	0	0	11.54	1,560					
7	3	0	0	7.71	1,401	2	0	0	3.85	1,870					
8	6	0	0	13.25	1,630	3	0	0	6.49	1,664					
9	2	0	0	4.50	1,600	5	0	0	12.11	1,486					
10	10	0	0	22.78	1,580	8	0	0	17.41	1,654					
11	4	0	0	9.45	1,524	3	0	0	6.98	1,547					
12	2	0	0	4.27	1,686	3	0	0	6.03	1,791					
回数平均					1,548					1,605					

飽和交通流率調査 調査結果

調査地点：地域社会4 滝沢

調査年月日：令和 2年11月25日(水) 天候：曇り

調査時間帯：16時～18時台



(単位：台・秒・台/有効青1時間)

方向・車線 回数	c 1					c 2									
	捌け台数			通過 時間	飽和 交通 流率	捌け台数			通過 時間	飽和 交通 流率	捌け台数			通過 時間	飽和 交通 流率
	小型車	大型車	二輪車			小型車	大型車	二輪車			小型車	大型車	二輪車		
1	4	0	0	8.86	1,625	2	0	0	4.60	1,565					
2	4	0	0	9.11	1,581	2	0	0	4.87	1,478					
3	5	0	0	12.55	1,434	5	0	0	9.84	1,829					
4	4	1	0	12.23	1,472	3	0	0	4.38	2,466					
5	3	1	0	8.14	1,769	3	0	0	6.87	1,572					
6	4	0	0	10.95	1,315	1	0	0	2.60	1,385					
7	7	1	0	20.30	1,419	3	0	0	7.04	1,534					
8	7	1	0	21.19	1,359	2	0	0	6.22	1,158					
9	2	0	0	4.78	1,506	3	0	0	7.10	1,521					
10	3	0	0	5.93	1,821	6	0	0	17.78	1,215					
11	4	1	0	11.53	1,561	2	0	0	4.32	1,667					
12	4	1	0	10.54	1,708										
回数平均					1,548					1,581					

飽和交通流率調査 調査結果

調査地点：地域社会4 瀬谷土橋公園入口

調査年月日：令和 2年11月25日(水) 天候：曇り

調査時間帯：16時～18時台



(単位：台・秒・台/有効青1時間)

方向・車線 回数	a 1					a 2									
	捌け台数			通過 時間	飽和 交通 流率	捌け台数			通過 時間	飽和 交通 流率	捌け台数			通過 時間	飽和 交通 流率
	小型車	大型車	二輪車			小型車	大型車	二輪車			小型車	大型車	二輪車		
1	2	0	1	5.27	1,366	4	0	0	8.54	1,686					
2	3	0	0	9.20	1,174	6	2	0	16.58	1,737					
3	6	3	0	28.92	1,120	7	2	0	19.31	1,678					
4	6	1	0	16.54	1,524	10	2	0	26.26	1,645					
5	4	2	0	19.27	1,121	10	2	0	30.43	1,420					
6	2	1	0	9.77	1,105	14	0	0	30.70	1,642					
7	3	1	0	11.25	1,280	14	2	0	36.81	1,565					
8	4	0	0	12.61	1,142	10	0	0	20.29	1,774					
9	7	0	0	18.22	1,383	15	0	0	34.77	1,553					
10	5	1	0	22.93	942	8	2	0	20.92	1,721					
11	2	0	0	4.81	1,497	11	2	0	30.12	1,554					
12	5	1	0	19.07	1,133	7	0	0	14.73	1,711					
回数平均					1,232					1,641					

飽和交通流率調査 調査結果

調査地点：地域社会4 瀬谷土橋公園入口

調査年月日：令和 2年11月25日(水) 天候：曇り

調査時間帯：16時～18時台



(単位：台・秒・台/有効青1時間)

方向・車線 回数	b 1					b 2					b 3				
	捌け台数			通過 時間	飽和 交通 流率	捌け台数			通過 時間	飽和 交通 流率	捌け台数			通過 時間	飽和 交通 流率
	小型車	大型車	二輪車			小型車	大型車	二輪車			小型車	大型車	二輪車		
1	3	1	0	12.17	1,183	1	0	0	3.65	986	1	1	0	6.50	1,108
2	10	1	0	26.59	1,489	1	0	0	3.13	1,150	2	0	0	7.57	951
3	8	2	0	27.39	1,314						2	0	0	6.01	1,198
4	2	0	0	4.84	1,488						1	0	0	2.71	1,328
5	13	0	0	28.96	1,616						1	0	0	3.66	984
6	8	0	0	20.62	1,397										
7	9	1	0	22.32	1,613										
8	13	0	0	28.96	1,616										
9	6	0	0	15.65	1,380										
10	14	0	0	32.11	1,570										
11	1	0	0	2.27	1,586										
12	12	3	0	43.97	1,228										
回数平均					1.457					1.068					1.114

飽和交通流率調査 調査結果

調査地点 : 地域社会4 瀬谷土橋公園入口

調査年月日 : 令和 2年11月25日(水) 天候:曇り

調査時間帯 : 16時~18時台



(単位 : 台・秒・台/有効青1時間)

方向・車線 回数	c 1					c 2										
	捌け台数			通過 時間	飽和 交通 流率	捌け台数			通過 時間	飽和 交通 流率	捌け台数			通過 時間	飽和 交通 流率	
	小型車	大型車	二輪車			小型車	大型車	二輪車			小型車	大型車	二輪車			
1						12	0	0	23.74	1,820						
2						9	0	0	17.43	1,859						
3						6	0	0	14.69	1,470						
4						6	0	0	13.25	1,630						
5						4	0	0	9.19	1,567						
6						4	0	0	9.34	1,542						
7						7	0	0	13.93	1,809						
8						8	0	0	18.55	1,553						
9						8	0	0	19.87	1,449						
10						7	0	0	16.37	1,539						
11						6	0	0	12.97	1,665						
12						6	0	0	14.52	1,488						
回数平均											1.616					

飽和交通流率調査 調査結果

調査地点 : 地域社会5

調査年月日 : 令和元年10月 8日(火) 天候:晴れ



(単位:台・秒・台/有効青1時間)

方向・車線 回数	a 1														
	捌け台数			通過 時間	飽和 交通 流率	捌け台数			通過 時間	飽和 交通 流率	捌け台数			通過 時間	飽和 交通 流率
	小型車	大型車	二輪車			小型車	大型車	二輪車			小型車	大型車	二輪車		
1	10	1	0	34.66	1143										
2	10	1	0	25.16	1574										
3	7	3	0	30.53	1179										
4	7	1	0	18.14	1588										
5	11	1	0	40.51	1066										
6	11	0	0	31.41	1261										
7	11	2	1	35.18	1330										
8	9	1	2	32.01	1125										
9															
10															
11															
12															
平均					1283										

飽和交通流率調査 調査結果

調査地点 : 地域社会5

調査年月日 : 令和元年10月 8日(火) 天候:晴れ



(単位 : 台・秒・台/有効青1時間)

方向・車線 回数	b 1														
	捌け台数			通過 時間	飽和 交通 流率	捌け台数			通過 時間	飽和 交通 流率	捌け台数			通過 時間	飽和 交通 流率
	小型車	大型車	二輪車			小型車	大型車	二輪車			小型車	大型車	二輪車		
1	7	1	0	21.02	1370										
2	12	2	2	43.22	1166										
3	15	2	0	44.53	1374										
4	12	3	0	44.38	1217										
5															
6															
7															
8															
9															
10															
11															
12															
平均					1282										

飽和交通流率調査 調査結果

調査地点 : 地域社会5

調査年月日 : 令和元年10月 8日(火) 天候:晴れ



(単位 : 台・秒・台/有効青1時間)

方向・車線 回数	c 1														
	捌け台数			通過 時間	飽和 交通 流率	捌け台数			通過 時間	飽和 交通 流率	捌け台数			通過 時間	飽和 交通 流率
	小型車	大型車	二輪車			小型車	大型車	二輪車			小型車	大型車	二輪車		
1	6	0	0	16.43	1315										
2	7	0	0	14.83	1699										
3	5	1	0	14.77	1462										
4	7	0	0	17.68	1425										
5	6	1	0	18.37	1372										
6	7	0	0	16.71	1508										
7	5	0	0	12.88	1398										
8	2	0	1	5.46	1319										
9	4	0	0	9.00	1600										
10	6	0	0	15.10	1430										
11	3	0	1	9.32	1159										
12															
平均					1426										

飽和交通流率調査 調査結果

調査地点 : 地域社会6 瀬谷中学校前

調査年月日 : 令和元年10月 8日(火) 天候:晴れ



(単位:台・秒・台/有効青1時間)

方向・車線 回数	a 2														
	捌け台数			通過 時間	飽和 交通 流率	捌け台数			通過 時間	飽和 交通 流率	捌け台数			通過 時間	飽和 交通 流率
	小型車	大型車	二輪車			小型車	大型車	二輪車			小型車	大型車	二輪車		
1	8	1	1	19.55	1657										
2	14	0	0	20.74	2430										
3	12	0	0	28.12	1536										
4	10	1	0	21.09	1878										
5	10	0	3	29.30	1229										
6	10	1	0	23.95	1653										
7	10	0	0	21.82	1650										
8	9	1	1	23.32	1544										
9	6	0	0	13.05	1655										
10	10	3	0	27.77	1685										
11	7	1	0	16.61	1734										
12	8	1	0	17.11	1894										
平均					1712										

飽和交通流率調査 調査結果

調査地点 : 地域社会6 瀬谷中学校前

調査年月日 : 令和元年10月 8日(火) 天候:晴れ



(単位:台・秒・台/有効青1時間)

方向・車線 回数	b 1					b 2									
	捌け台数			通過 時間	飽和 交通 流率	捌け台数			通過 時間	飽和 交通 流率	捌け台数			通過 時間	飽和 交通 流率
	小型車	大型車	二輪車			小型車	大型車	二輪車			小型車	大型車	二輪車		
1	10	0	0	23.20	1552	3	0	1	4.62	2338					
2	10	0	1	23.59	1526	4	0	0	9.40	1532					
3	5	0	0	10.30	1748	4	0	1	7.51	1917					
4	11	1	0	21.84	1978	4	0	2	8.14	1769					
5	10	0	0	21.41	1681	3	0	0	4.11	2628					
6	8	0	0	20.32	1417	6	0	0	8.32	2596					
7	7	0	0	18.23	1382	6	0	0	15.84	1364					
8	10	0	1	23.42	1537	5	0	1	15.87	1134					
9	9	0	0	21.42	1513	4	0	0	5.25	2743					
10	10	1	0	25.46	1555										
11	5	0	0	8.89	2025										
12	7	1	0	19.97	1442										
平均					1613					2002					

飽和交通流率調査 調査結果

調査地点 : 地域社会6 瀬谷中学校前

調査年月日 : 令和元年10月 8日(火) 天候:晴れ



(単位 : 台・秒・台/有効青1時間)

方向・車線 回数	c 1					c 2					c 3				
	捌け台数			通過 時間	飽和 交通 流率	捌け台数			通過 時間	飽和 交通 流率	捌け台数			通過 時間	飽和 交通 流率
	小型車	大型車	二輪車			小型車	大型車	二輪車			小型車	大型車	二輪車		
1	6	0	0	21.66	997	10	0	0	25.99	1385	2	0	0	4.02	1791
2	6	0	0	23.44	922	9	1	1	25.50	1412	1	0	0	2.48	1452
3	5	0	0	16.74	1075	10	2	1	29.64	1457	1	0	0	1.89	1905
4	4	0	0	10.26	1404	9	2	0	26.32	1505	2	0	0	3.16	2278
5						10	2	4	32.17	1343	1	0	0	3.66	984
6						10	1	0	24.93	1588	1	0	0	3.40	1059
7						7	1	0	18.61	1548	2	0	0	7.12	1011
8						7	0	0	19.25	1309	1	0	0	2.68	1343
9						5	2	0	18.85	1337	1	0	0	2.55	1412
10															
11															
12															
平均					1100					1432					1471

飽和交通流率調査 調査結果

調査地点：地域社会6 瀬谷中学校前

調査年月日：令和元年10月 8日(火) 天候：晴れ



(単位：台・秒・台/有効青1時間)

方向・車線 回数	d 1					d 2									
	捌け台数			通過 時間	飽和 交通 流率	捌け台数			通過 時間	飽和 交通 流率	捌け台数			通過 時間	飽和 交通 流率
	小型車	大型車	二輪車			小型車	大型車	二輪車			小型車	大型車	二輪車		
1	9	0	0	22.52	1439	1	0	0	2.05	1756					
2	6	0	0	18.91	1142	2	0	0	4.03	1787					
3	8	0	0	25.97	1109	2	0	0	7.80	923					
4	9	0	0	25.40	1276	1	0	0	4.37	824					
5	8	0	0	20.48	1406	1	0	0	2.62	1374					
6	7	1	0	26.32	1094										
7	9	0	0	20.70	1565										
8	5	0	0	15.64	1151										
9															
10															
11															
12															
平均					1273					1333					

飽和交通流率調査 調査結果

調査地点 : 地域社会1 目黒

調査年月日 : 令和元年10月 6日(日) 天候:曇り



(単位: 台・秒・台/有効青1時間)

方向・車線 回数	a 1					a 2									
	捌け台数			通過 時間	飽和 交通 流率	捌け台数			通過 時間	飽和 交通 流率	捌け台数			通過 時間	飽和 交通 流率
	小型車	大型車	二輪車			小型車	大型車	二輪車			小型車	大型車	二輪車		
1	14	1	0	42.96	1257	1	0	0	2.58	1395					
2	14	1	0	43.69	1236										
3	16	0	0	37.16	1550										
4	12	0	1	31.48	1372										
5	18	1	0	51.19	1336										
6	20	0	0	52.07	1383										
7	15	0	0	44.10	1224										
8	20	1	0	62.10	1217										
9	15	1	2	42.33	1361										
10															
11															
12															
平均					1326					1395					

飽和交通流率調査 調査結果

調査地点 : 地域社会1 目黒

調査年月日 : 令和元年10月 6日(日) 天候:曇り



(単位: 台・秒・台/有効青1時間)

方向・車線 回数	b 1					b 2									
	捌け台数			通過 時間	飽和 交通 流率	捌け台数			通過 時間	飽和 交通 流率	捌け台数			通過 時間	飽和 交通 流率
	小型車	大型車	二輪車			小型車	大型車	二輪車			小型車	大型車	二輪車		
1	6	0	0	17.86	1209	11	1	1	28.27	1528					
2	3	0	0	6.37	1695	6	0	0	16.00	1350					
3	2	0	0	5.73	1257	5	1	0	18.74	1153					
4	9	0	0	23.44	1382	6	3	0	23.87	1357					
5	5	0	0	12.07	1491	8	0	0	20.44	1409					
6	2	0	0	5.82	1237	7	0	0	15.87	1588					
7	5	1	0	17.85	1210	7	2	0	23.09	1403					
8						5	3	0	20.69	1392					
9						5	1	0	14.76	1463					
10						7	1	0	17.91	1608					
11						4	2	0	17.81	1213					
12						4	0	0	9.13	1577					
平均					1354					1420					

飽和交通流率調査 調査結果

調査地点 : 地域社会1 目黒

調査年月日 : 令和元年10月 6日(日) 天候:曇り



(単位:台・秒・台/有効青1時間)

方向・車線 回数	c 1					c 2					c 3				
	捌け台数			通過 時間	飽和 交通 流率	捌け台数			通過 時間	飽和 交通 流率	捌け台数			通過 時間	飽和 交通 流率
	小型車	大型車	二輪車			小型車	大型車	二輪車			小型車	大型車	二輪車		
1	6	0	1	19.03	1135	18	1	1	43.92	1557	3	0	0	6.54	1651
2	5	0	1	16.04	1122	5	0	0	13.07	1377	1	0	0	2.65	1358
3	4	1	0	15.87	1134	13	3	0	41.23	1397	1	0	0	2.70	1333
4	5	0	0	11.45	1572	8	0	0	15.21	1893					
5	4	1	0	14.55	1237	22	2	0	53.86	1604					
6	8	1	0	24.91	1301	18	1	0	43.55	1571					
7	9	0	0	23.27	1392	7	1	0	19.88	1449					
8	11	2	0	35.90	1304	9	0	0	21.70	1493					
9						5	1	1	15.30	1412					
10															
11															
12															
平均					1275					1528					1447

飽和交通流率調査 調査結果

調査地点 : 地域社会1 目黒

調査年月日 : 令和元年10月 6日(日) 天候:曇り



(単位: 台・秒・台/有効青1時間)

方向・車線 回数	d 1					d 2									
	捌け台数			通過 時間	飽和 交通 流率	捌け台数			通過 時間	飽和 交通 流率	捌け台数			通過 時間	飽和 交通 流率
	小型車	大型車	二輪車			小型車	大型車	二輪車			小型車	大型車	二輪車		
1	3	0	0	8.29	1303	5	0	0	11.01	1635					
2	3	1	0	12.09	1191	6	2	0	19.31	1491					
3	3	0	0	7.35	1469	6	0	0	15.06	1434					
4	3	0	0	7.23	1494	7	0	0	18.01	1399					
5						5	0	0	13.25	1358					
6						5	1	0	14.78	1461					
7						6	1	0	22.36	1127					
8						5	0	0	11.65	1545					
9						10	0	0	21.55	1671					
10						7	0	0	19.21	1312					
11															
12															
平均					1364					1443					

飽和交通流率調査 調査結果

調査地点 : 地域社会2 目黒交番前

調査年月日 : 令和元年10月 6日(日) 天候:曇り

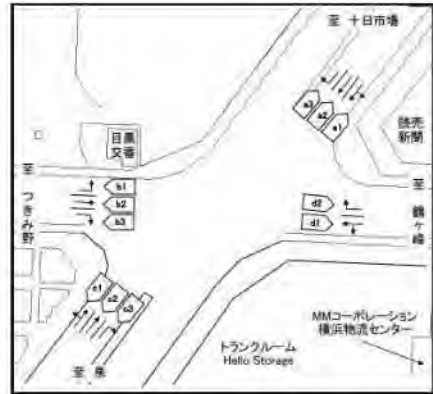

(単位: 台・秒・台/有効青1時間)

方向・車線 回数	a 1					a 2					a 3				
	捌け台数			通過 時間	飽和 交通 流率	捌け台数			通過 時間	飽和 交通 流率	捌け台数			通過 時間	飽和 交通 流率
	小型車	大型車	二輪車			小型車	大型車	二輪車			小型車	大型車	二輪車		
1	5	1	0	13.84	1561	1	0	0	2.42	1488	4	0	0	8.91	1616
2	4	0	0	7.04	2045	1	0	0	2.53	1423	3	0	0	6.13	1762
3	4	1	0	12.30	1463	4	1	0	11.75	1532	5	0	0	11.01	1635
4	4	0	1	11.54	1248	2	0	0	4.98	1446	3	0	0	5.72	1888
5	2	0	1	5.16	1395	1	0	0	2.38	1513	3	0	0	5.87	1840
6	4	0	0	7.71	1868						4	0	0	7.29	1975
7	3	0	0	6.18	1748						4	0	0	9.30	1548
8	6	0	0	12.69	1702						3	0	0	8.12	1330
9	6	0	1	17.75	1217						2	1	0	5.98	1806
10	4	0	0	10.60	1358						4	0	0	8.50	1694
11											5	0	0	10.27	1753
12											3	0	0	5.96	1812
平均					1561					1480					1722

飽和交通流率調査 調査結果

調査地点 : 地域社会2 目黒交番前

調査年月日 : 令和元年10月 6日(日) 天候:曇り

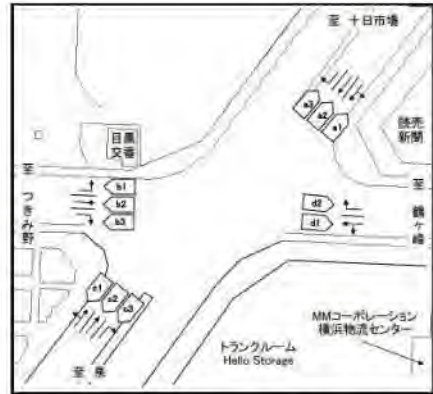

(単位: 台・秒・台/有効青1時間)

方向・車線 回数	b 1					b 2					b 3				
	捌け台数			通過 時間	飽和 交通 流率	捌け台数			通過 時間	飽和 交通 流率	捌け台数			通過 時間	飽和 交通 流率
	小型車	大型車	二輪車			小型車	大型車	二輪車			小型車	大型車	二輪車		
1	2	0	0	4.56	1579	4	0	0	10.61	1357					
2	1	0	0	2.18	1651	20	2	0	54.25	1460					
3	1	1	0	4.45	1618	13	3	0	43.03	1339					
4	0	1	0	4.28	841	11	0	1	29.34	1350					
5	1	1	0	4.57	1575	9	2	2	29.84	1327					
6	5	0	0	21.02	856	3	0	0	6.42	1682					
7	1	0	0	1.95	1846										
8	2	0	1	10.24	703										
9	1	0	0	3.54	1017										
10	3	0	0	7.32	1475										
11															
12															
平均					1316					1419					

飽和交通流率調査 調査結果

調査地点 : 地域社会2 目黒交番前

調査年月日 : 令和元年10月 6日(日) 天候:曇り

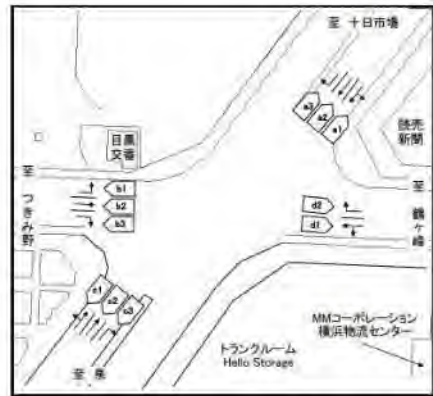

(単位: 台・秒・台/有効青1時間)

方向・車線 回数	c 1					c 2					c 3				
	捌け台数			通過 時間	飽和 交通 流率	捌け台数			通過 時間	飽和 交通 流率	捌け台数			通過 時間	飽和 交通 流率
	小型車	大型車	二輪車			小型車	大型車	二輪車			小型車	大型車	二輪車		
1	2	0	0	5.35	1346	5	0	0	13.73	1311	3	0	0	7.86	1374
2	3	0	1	9.77	1105	7	0	0	18.44	1367	3	0	0	8.19	1319
3	3	0	0	9.51	1136	2	0	0	2.98	2416	3	0	0	6.45	1674
4	7	0	0	22.28	1131	13	0	0	30.79	1520	2	0	1	4.66	1545
5	1	0	0	2.84	1268	4	0	0	11.31	1273	4	0	0	9.78	1472
6	3	0	0	8.48	1274	7	0	0	20.67	1219	3	0	0	7.65	1412
7	2	0	0	4.96	1452	6	0	1	11.34	1905	4	0	0	8.20	1756
8	5	0	1	14.19	1268	9	0	0	23.87	1357	3	1	0	9.92	1452
9	2	0	0	6.00	1200						3	0	0	7.76	1392
10											3	0	0	5.45	1982
11											3	1	0	8.50	1694
12											2	0	0	4.26	1690
平均					1242					1546					1564

飽和交通流率調査 調査結果

調査地点 : 地域社会2 目黒交番前

調査年月日 : 令和元年10月 6日(日) 天候:曇り

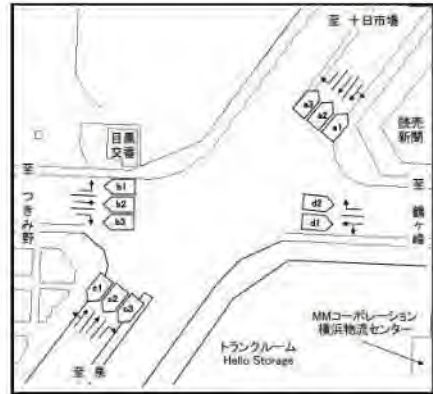

(単位: 台・秒・台/有効青1時間)

方向・車線 回数	d 1														
	捌け台数			通過 時間	飽和 交通 流率	捌け台数			通過 時間	飽和 交通 流率	捌け台数			通過 時間	飽和 交通 流率
	小型車	大型車	二輪車			小型車	大型車	二輪車			小型車	大型車	二輪車		
1	22	1	0	60.97	1358										
2	24	6	2	55.36	1951										
3	19	1	1	52.59	1369										
4	17	2	1	47.58	1438										
5	18	2	1	51.16	1407										
6	25	1	0	64.62	1448										
7	25	1	0	67.62	1384										
8															
9															
10															
11															
12															
平均					1479										

飽和交通流率調査 調査結果

調査地点 : 地域社会3 上川井IC

調査年月日 : 令和元年10月 6日(日) 天候:曇り



(単位:台・秒・台/有効青1時間)

方向・車線 回数	a 1														
	捌け台数			通過 時間	飽和 交通 流率	捌け台数			通過 時間	飽和 交通 流率	捌け台数			通過 時間	飽和 交通 流率
	小型車	大型車	二輪車			小型車	大型車	二輪車			小型車	大型車	二輪車		
1	5	0	0	11.52	1563										
2	4	0	1	9.01	1598										
3	2	0	1	6.09	1182										
4	2	0	0	4.22	1706										
5	3	1	0	8.88	1622										
6	2	0	1	4.17	1727										
7	2	0	0	3.79	1900										
8	1	0	1	3.67	981										
9	3	0	1	7.00	1543										
10	4	0	0	8.32	1731										
11	4	0	1	10.24	1406										
12	2	0	0	3.21	2243										
平均					1600										

飽和交通流率調査 調査結果

調査地点 : 地域社会3 上川井IC

調査年月日 : 令和元年10月 6日(日) 天候:曇り



(単位: 台・秒・台/有効青1時間)

方向・車線 回数	b 1					b 2									
	捌け台数			通過 時間	飽和 交通 流率	捌け台数			通過 時間	飽和 交通 流率	捌け台数			通過 時間	飽和 交通 流率
	小型車	大型車	二輪車			小型車	大型車	二輪車			小型車	大型車	二輪車		
1	9	1	0	21.95	1640	5	1	0	12.59	1716					
2	10	0	1	23.11	1558	12	2	0	27.02	1865					
3	8	0	0	17.73	1624	10	4	0	38.86	1297					
4	6	0	0	14.17	1524	7	1	0	17.85	1613					
5	7	1	0	16.84	1710	10	3	4	35.75	1309					
6	6	1	1	17.74	1421	10	1	0	26.14	1515					
7	6	0	0	18.13	1191	12	1	0	27.74	1687					
8	5	0	0	11.39	1580	11	1	0	22.58	1913					
9	7	1	1	20.17	1428	11	3	0	35.69	1412					
10	6	0	0	13.93	1551	13	2	0	33.93	1592					
11						13	0	0	29.50	1586					
12						10	2	0	28.86	1497					
平均					1523					1584					

飽和交通流率調査 調査結果

調査地点 : 地域社会3 上川井IC

調査年月日 : 令和元年10月 6日(日) 天候:曇り



(単位:台・秒・台/有効青1時間)

方向・車線 回数	c 1														
	捌け台数			通過 時間	飽和 交通 流率	捌け台数			通過 時間	飽和 交通 流率	捌け台数			通過 時間	飽和 交通 流率
	小型車	大型車	二輪車			小型車	大型車	二輪車			小型車	大型車	二輪車		
1	2	0	0	4.95	1455										
2	2	0	0	6.27	1148										
3	5	0	1	14.18	1269										
4	2	0	0	4.06	1773										
5	4	0	0	10.95	1315										
6															
7															
8															
9															
10															
11															
12															
平均					1392										

飽和交通流率調査 調査結果

調査地点 : 地域社会3 上川井IC

調査年月日 : 令和元年10月 6日(日) 天候:曇り

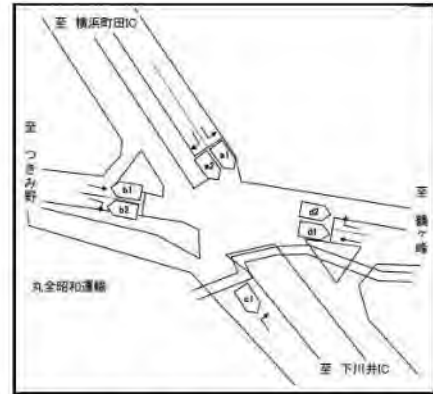

(単位:台・秒・台/有効青1時間)

方向・車線 回数	d 1					d 2									
	捌け台数			通過 時間	飽和 交通 流率	捌け台数			通過 時間	飽和 交通 流率	捌け台数			通過 時間	飽和 交通 流率
	小型車	大型車	二輪車			小型車	大型車	二輪車			小型車	大型車	二輪車		
1	5	0	0	11.05	1629	3	0	3	7.85	1376					
2	4	0	0	10.32	1395	1	0	0	2.92	1233					
3	7	1	0	20.03	1438	4	0	0	9.99	1441					
4	8	0	0	19.49	1478	9	1	0	19.30	1865					
5	9	0	0	21.69	1494	2	2	0	9.66	1491					
6	8	0	0	21.04	1369	4	0	0	8.61	1672					
7															
8															
9															
10															
11															
12															
平均					1467					1513					

飽和交通流率調査 調査結果

調査地点：地域社会4 滝沢

調査年月日：令和 2年11月29日(日) 天候：曇り

調査時間帯：15時～17時台



(単位：台・秒・台/有効青1時間)

方向・車線 回数	a 1					a 2									
	捌け台数			通過 時間	飽和 交通 流率	捌け台数			通過 時間	飽和 交通 流率	捌け台数			通過 時間	飽和 交通 流率
	小型車	大型車	二輪車			小型車	大型車	二輪車			小型車	大型車	二輪車		
1	2	0	1	4.77	1,509	2	0	1	7.11	1,013					
2	2	0	0	5.06	1,423	1	0	0	3.01	1,196					
3	5	0	0	12.58	1,431	1	0	0	1.84	1,957					
4	2	0	0	4.23	1,702	5	0	1	14.93	1,206					
5	4	0	0	10.85	1,327	3	0	0	8.57	1,260					
6	10	0	0	23.49	1,533	1	0	0	2.47	1,457					
7	5	1	0	14.37	1,503										
8	11	0	1	28.86	1,372										
9	3	0	0	6.76	1,598										
10	10	0	0	21.43	1,680										
11	11	0	0	27.46	1,442										
12	5	0	0	11.37	1,583										
回数平均					1,509					1,348					

飽和交通流率調査 調査結果

調査地点 : 地域社会4 滝沢

調査年月日 : 令和 2年11月29日(日) 天候:曇り

調査時間帯 : 15時~17時台



(単位:台・秒・台/有効青1時間)

方向・車線 回数	b 1					b 2					b 3				
	捌け台数			通過 時間	飽和 交通 流率	捌け台数			通過 時間	飽和 交通 流率	捌け台数			通過 時間	飽和 交通 流率
	小型車	大型車	二輪車			小型車	大型車	二輪車			小型車	大型車	二輪車		
1	4	0	0	9.90	1,455	6	0	0	14.04	1,538					
2	5	0	1	13.43	1,340	7	0	0	17.46	1,443					
3	4	0	0	11.47	1,255	8	0	0	16.99	1,695					
4	7	0	0	18.59	1,356	5	0	0	9.97	1,805					
5	8	0	0	21.69	1,328	6	0	0	14.57	1,482					
6	7	0	1	15.65	1,610	8	0	0	19.63	1,467					
7	4	0	0	9.35	1,540	7	0	0	15.48	1,628					
8	4	0	0	10.62	1,356	10	0	0	27.46	1,311					
9	3	0	0	5.86	1,843	5	0	0	11.47	1,569					
10	4	0	0	10.59	1,360	4	0	0	9.47	1,521					
11	2	0	0	4.58	1,572	5	0	0	11.79	1,527					
12	13	0	0	36.40	1,286	6	0	0	14.83	1,457					
回数平均					1,442					1,537					

飽和交通流率調査 調査結果

調査地点：地域社会4 滝沢

調査年月日：令和 2年11月29日(日) 天候：曇り

調査時間帯：15時～17時台



(単位：台・秒・台/有効青1時間)

方向・車線 回数	c 1					c 2									
	捌け台数			通過 時間	飽和 交通 流率	捌け台数			通過 時間	飽和 交通 流率	捌け台数			通過 時間	飽和 交通 流率
	小型車	大型車	二輪車			小型車	大型車	二輪車			小型車	大型車	二輪車		
1	1	0	0	3.18	1,132	4	0	0	10.31	1,397					
2	3	0	0	9.90	1,091	4	0	0	8.55	1,684					
3	5	1	0	15.95	1,354	6	0	0	20.12	1,074					
4	1	0	0	3.12	1,154	2	1	0	7.76	1,392					
5	1	0	0	3.07	1,173	5	0	0	10.39	1,732					
6	2	0	0	6.30	1,143	5	0	2	14.35	1,254					
7	3	0	0	10.37	1,041	6	0	1	16.56	1,304					
8	4	0	0	13.62	1,057	3	0	0	7.62	1,417					
9	1	2	0	9.13	1,183	7	0	1	17.64	1,429					
10	2	1	0	9.51	1,136	3	0	0	7.16	1,508					
11						4	0	0	10.62	1,356					
12						5	0	0	12.18	1,478					
回数平均					1,146					1,419					

飽和交通流率調査 調査結果

調査地点：地域社会4 瀬谷土橋公園入口

調査年月日：令和 2年11月29日(日) 天候：曇り

調査時間帯：15時～17時台



(単位：台・秒・台/有効青1時間)

方向・車線 回数	a 1					a 2									
	捌け台数			通過 時間	飽和 交通 流率	捌け台数			通過 時間	飽和 交通 流率	捌け台数			通過 時間	飽和 交通 流率
	小型車	大型車	二輪車			小型車	大型車	二輪車			小型車	大型車	二輪車		
1	8	1	0	22.73	1,425	4	0	0	8.14	1,769					
2	3	2	0	12.87	1,399	3	1	0	8.22	1,752					
3	2	0	0	5.16	1,395	5	0	0	10.29	1,749					
4	6	1	0	19.93	1,264	4	0	0	9.16	1,572					
5	11	2	0	35.32	1,325	3	1	0	8.64	1,667					
6	2	0	0	5.43	1,326	4	0	0	7.84	1,837					
7	7	0	0	14.44	1,745	5	0	0	11.42	1,576					
8	3	1	0	10.57	1,362	4	1	0	10.37	1,736					
9	4	0	0	10.32	1,395	6	0	0	14.67	1,472					
10	4	1	0	12.64	1,424	3	0	0	5.81	1,859					
11	5	0	0	12.99	1,386	6	0	0	14.39	1,501					
12	8	0	0	20.36	1,415	10	1	0	26.45	1,497					
回数平均					1,405					1,666					

飽和交通流率調査 調査結果

調査地点 : 地域社会4 瀬谷土橋公園入口

調査年月日 : 令和 2年11月29日(日) 天候:曇り

調査時間帯 : 15時~17時台



(単位:台・秒・台/有効青1時間)

方向・車線 回数	b 1					b 2					b 3					
	捌け台数			通過 時間	飽和 交通 流率	捌け台数			通過 時間	飽和 交通 流率	捌け台数			通過 時間	飽和 交通 流率	
	小型車	大型車	二輪車			小型車	大型車	二輪車			小型車	大型車	二輪車			
1	2	0	0	3.88	1.856							1	0	0	3.27	1.101
2	12	0	0	34.74	1,244							1	0	0	1.97	1.827
3	4	0	0	9.53	1,511											
4	5	0	0	14.21	1,267											
5	5	0	0	11.45	1,572											
6	7	0	0	19.72	1,278											
7	9	0	0	24.90	1,301											
8	3	0	0	5.86	1,843											
9	4	0	0	10.23	1,408											
10	7	0	0	15.47	1,629											
11	10	0	2	25.07	1,436											
12	15	0	0	38.84	1,390											
回数平均					1.478											1.464

飽和交通流率調査 調査結果

調査地点 : 地域社会4 瀬谷土橋公園入口

調査年月日 : 令和 2年11月29日(日) 天候:曇り

調査時間帯 : 15時~17時台



(単位 : 台・秒・台/有効青1時間)

方向・車線 回数	c 1					c 2									
	捌け台数			通過 時間	飽和 交通 流率	捌け台数			通過 時間	飽和 交通 流率	捌け台数			通過 時間	飽和 交通 流率
	小型車	大型車	二輪車			小型車	大型車	二輪車			小型車	大型車	二輪車		
1						6	0	0	9.86	2,191					
2						8	0	0	21.91	1,314					
3						4	0	0	9.64	1,494					
4						4	0	0	9.53	1,511					
5						6	0	0	15.71	1,375					
6						5	0	0	12.26	1,468					
7						6	0	0	16.58	1,303					
8						10	0	0	19.64	1,833					
9						8	0	0	18.38	1,567					
10						3	0	0	5.98	1,806					
11						7	0	0	15.98	1,577					
12															
回数平均										1.585					

飽和交通流率調査 調査結果

調査地点 : 地域社会5

調査年月日 : 令和元年10月 6日(日) 天候:曇り



(単位:台・秒・台/有効青1時間)

方向・車線 回数	a 1														
	捌け台数			通過時間	飽和交通流率	捌け台数			通過時間	飽和交通流率	捌け台数			通過時間	飽和交通流率
	小型車	大型車	二輪車			小型車	大型車	二輪車			小型車	大型車	二輪車		
1	3	1	1	11.69	1232										
2	5	0	1	16.12	1117										
3	8	0	0	22.71	1268										
4	4	0	0	12.78	1127										
5	10	0	0	31.46	1144										
6	3	0	0	8.13	1328										
7	9	0	0	27.74	1168										
8	10	0	0	24.67	1459										
9															
10															
11															
12															
平均					1230										

飽和交通流率調査 調査結果

調査地点 : 地域社会5

調査年月日 : 令和元年10月 6日(日) 天候:曇り



(単位:台・秒・台/有効青1時間)

方向・車線 回数	b 1														
	捌け台数			通過時間	飽和交通流率	捌け台数			通過時間	飽和交通流率	捌け台数			通過時間	飽和交通流率
	小型車	大型車	二輪車			小型車	大型車	二輪車			小型車	大型車	二輪車		
1	11	2	1	37.73	1240										
2	6	0	0	16.31	1324										
3	4	0	0	13.71	1050										
4	6	0	0	16.90	1278										
5	7	0	1	28.69	878										
6	9	1	0	28.40	1268										
7	3	0	0	7.54	1432										
8	5	0	1	19.06	944										
9															
10															
11															
12															
平均					1177										

飽和交通流率調査 調査結果

調査地点 : 地域社会5

調査年月日 : 令和元年10月 6日(日) 天候:曇り



(単位:台・秒・台/有効青1時間)

方向・車線 回数	c 1														
	捌け台数			通過 時間	飽和 交通 流率	捌け台数			通過 時間	飽和 交通 流率	捌け台数			通過 時間	飽和 交通 流率
	小型車	大型車	二輪車			小型車	大型車	二輪車			小型車	大型車	二輪車		
1	3	0	0	7.04	1534										
2	6	0	0	16.03	1347										
3	3	0	0	9.11	1186										
4	5	0	0	16.74	1075										
5	4	0	0	11.89	1211										
6	6	0	0	15.09	1431										
7	5	0	0	12.47	1443										
8	3	0	0	8.43	1281										
9	2	0	0	5.98	1204										
10	3	0	0	9.64	1120										
11	5	0	0	11.63	1548										
12	5	0	1	13.48	1335										
平均					1310										

飽和交通流率調査 調査結果

調査地点 : 地域社会6 瀬谷中学校前

調査年月日 : 令和元年10月 6日(日) 天候:曇り



(単位:台・秒・台/有効青1時間)

方向・車線 回数	a 1					a 2									
	捌け台数			通過 時間	飽和 交通 流率	捌け台数			通過 時間	飽和 交通 流率	捌け台数			通過 時間	飽和 交通 流率
	小型車	大型車	二輪車			小型車	大型車	二輪車			小型車	大型車	二輪車		
1	3	0	0	6.25	1728	7	0	0	14.82	1700					
2	1	0	0	1.92	1875	7	0	1	18.84	1338					
3						5	0	0	8.78	2050					
4						10	1	1	25.56	1549					
5						9	0	0	19.81	1636					
6						9	0	1	24.14	1342					
7						3	0	0	3.97	2720					
8						8	0	0	21.05	1368					
9						9	1	0	21.14	1703					
10						11	0	0	25.83	1533					
11						14	0	0	25.51	1976					
12						7	0	0	21.54	1170					
平均					1802					1674					

飽和交通流率調査 調査結果

調査地点 : 地域社会6 瀬谷中学校前

調査年月日 : 令和元年10月 6日(日) 天候:曇り



(単位:台・秒・台/有効青1時間)

方向・車線 回数	b 1					b 2									
	捌け台数			通過 時間	飽和 交通 流率	捌け台数			通過 時間	飽和 交通 流率	捌け台数			通過 時間	飽和 交通 流率
	小型車	大型車	二輪車			小型車	大型車	二輪車			小型車	大型車	二輪車		
1	4	0	0	7.83	1839	3	0	0	7.83	1379					
2	2	0	0	4.17	1727	5	0	0	8.52	2113					
3	3	0	0	5.16	2093	4	0	0	7.72	1865					
4	4	0	0	10.18	1415	4	0	0	5.76	2500					
5	6	0	0	14.89	1451	4	0	0	9.33	1543					
6	7	0	0	19.34	1303	3	0	1	7.35	1469					
7	8	0	0	19.16	1503	3	0	0	4.25	2541					
8	8	0	0	17.11	1683	3	0	0	5.54	1949					
9	4	0	0	6.57	2192										
10															
11															
12															
平均					1690					1920					

飽和交通流率調査 調査結果

調査地点 : 地域社会6 瀬谷中学校前

調査年月日 : 令和元年10月 6日(日) 天候:曇り



(単位:台・秒・台/有効青1時間)

方向・車線 回数	c 1					c 2					c 3				
	捌け台数			通過 時間	飽和 交通 流率	捌け台数			通過 時間	飽和 交通 流率	捌け台数			通過 時間	飽和 交通 流率
	小型車	大型車	二輪車			小型車	大型車	二輪車			小型車	大型車	二輪車		
1	2	0	0	5.26	1369	3	0	0	5.42	1993	2	0	0	4.35	1655
2	1	0	0	2.53	1423	9	0	0	24.67	1313	1	0	0	1.93	1865
3	2	0	0	4.84	1488	3	0	0	7.43	1454	1	0	0	2.55	1412
4	4	0	0	13.95	1032	8	2	0	25.02	1439	3	0	0	8.83	1223
5	1	0	0	2.11	1706	6	1	0	17.50	1440	3	0	0	9.18	1176
6	3	0	0	8.67	1246	6	0	1	13.62	1586	2	0	0	5.22	1379
7	8	0	0	25.47	1131	7	0	0	18.21	1384					
8	2	0	0	4.58	1572										
9															
10															
11															
12															
平均					1371					1516					1452

飽和交通流率調査 調査結果

調査地点 : 地域社会6 瀬谷中学校前

調査年月日 : 令和元年10月 6日(日) 天候:曇り



(単位:台・秒・台/有効青1時間)

方向・車線 回数	d 1					d 2									
	捌け台数			通過 時間	飽和 交通 流率	捌け台数			通過 時間	飽和 交通 流率	捌け台数			通過 時間	飽和 交通 流率
	小型車	大型車	二輪車			小型車	大型車	二輪車			小型車	大型車	二輪車		
1	8	0	0	23.59	1221										
2	5	0	0	11.84	1520										
3	7	0	1	19.74	1277										
4	1	0	0	2.18	1651										
5	7	0	0	15.28	1649										
6	1	1	0	6.06	1188										
7	5	0	0	14.30	1259										
8	6	0	2	18.08	1195										
9	8	0	0	23.02	1251										
10	4	0	0	10.62	1356										
11															
12															
平均					1357										

9.17-6 将来交通量の算定について

対象事業実施区域周辺における将来交通量の算定方法についてはP.資料 地域-963～991に示すとおりです。

平日・休日平均交通量について（2046年）

以下に示す箇所の平休別交通量（断面・方向別）を日別・時間帯別に算定しました。



図1 対象箇所（6断面、7交差点）

1. 平日・休日平均交通量の換算

平日・休日平均交通量を算定しました。

「1.1.1 開発交通量」「②バックグラウンド交通量」それぞれ既存資料等を用いて平日と休日それぞれの平均交通量（台/日）を以下の式を基に算定しました。

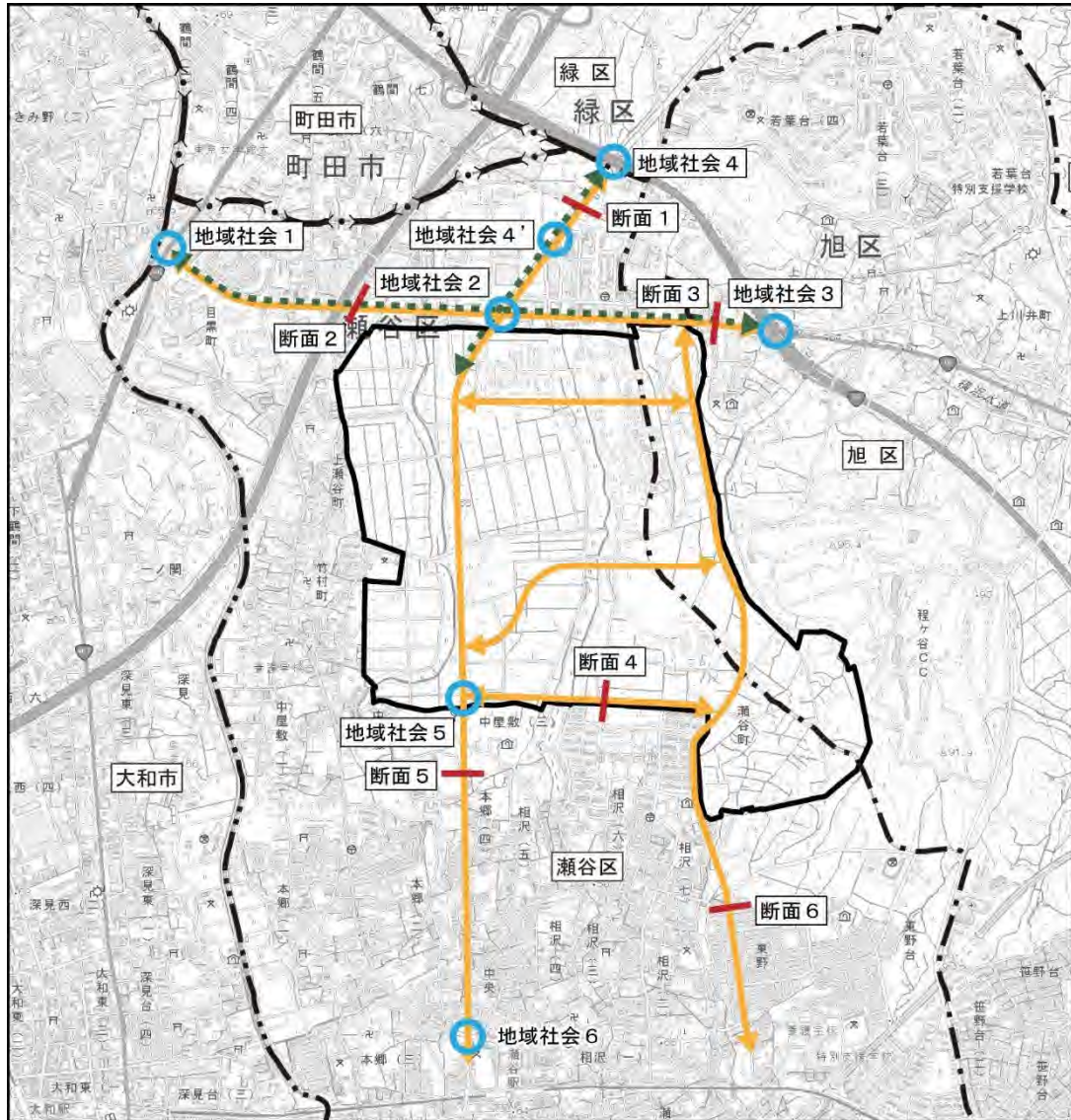
表 1 平日・休日平均交通量（台/日）の算出式

①開発交通量

開発施設	算出式	算出根拠資料
賑わい	\blacksquare (年平均日交通量) × (平日or休日換算係数) 平日 (年平均日交通量) × 0.86 休日 (年平均日交通量) × 1.29	\lt 平日or休日換算係数 \gt 東京ディズニーリゾートの流入交通量 (平成25年度浦安市内主要交差点等交通量調査)
物流	\blacksquare (年平均日交通量) × (平日or休日換算係数) 平日 (年平均日交通量) × 1.22 休日 (年平均日交通量) × 0.56	\lt 平日or休日換算係数 \gt 神奈川県発出荷量の曜日別指数 (H17物流センサス(国土交通省))
公園	\blacksquare (年平均日交通量) × (平日or休日換算係数) 平日 (年平均日交通量) × 0.68 休日 (年平均日交通量) × 1.65	\lt 平日or休日換算係数 \gt 「haあたり入園者数」、及び「開設面積と利用可能面積」 (都市公園利用実態調査(国土交通省))
防災	\blacksquare (年平均日交通量) × (平日換算係数) 平日 (年平均日交通量) × 1.49 休日 なし	\lt 平日換算係数 \gt 既存の横浜市の施設である「消防訓練センター」の従業員数を 自動車交通量に換算

②バックグラウンド交通量

	算出式	算出根拠資料
	\blacksquare (年平均日交通量) × (平日or休日換算係数) 平日 (年平均日交通量) × 1.04 休日 (年平均日交通量) × 0.92	\lt 平日or休日換算係数 \gt 道路の交通容量

1.1 算出方法

1.1.1 開発交通

開発交通は以下の通りである。開発施設毎の平日比・休日比を算定しました。

- ・賑わい施設（来場者・従業員）
- ・物流施設（来場者・従業員）
- ・公園
- ・防災

(1)賑わい施設（来場者・従業員）

ピーク日の交通量を算出する際は、来場者・従業員ともに平日 or 休日換算係数を用いました。

平日 or 休日換算係数は、既存の類似施設である「東京ディズニーリゾートの流出入交通量（平成25年度浦安市内主要交差点等交通量調査）」の平日換算係数（0.86）及び休日換算係数（1.29）を用いて、平日と休日それぞれの平均交通量を算出しました。

■算出式

$$\begin{aligned} \text{(賑わい施設の平日平均交通量)} &= \text{(年平均日交通量)} \times \text{(平日換算係数)} \\ &= \text{(年平均日交通量)} \times 0.86 \end{aligned}$$

$$\begin{aligned} \text{(賑わい施設の休日平均交通量)} &= \text{(年平均日交通量)} \times \text{(休日換算係数)} \\ &= \text{(年平均日交通量)} \times 1.29 \end{aligned}$$

表1-1 東京ディズニーリゾートの流出入交通量

	平日（平成25年6月6日（木））								休日（平成25年6月8日（土））								
	交通量						構成比		交通量						構成比		
	地点9		地点10		計		in	out	地点9		地点10		計		in	out	
	in	out	in	out	in	out			in	out	in	out	in	out			
7-8	1,316	133	190	258	1,506	391	10.2%	2.6%	7-8	3,033	147	292	294	3,325	441	15.0%	2.0%
8-9	2,151	207	290	388	2,441	595	16.5%	4.0%	8-9	2,951	157	421	338	3,372	495	15.2%	2.2%
9-10	1,787	168	298	341	2,085	509	14.1%	3.4%	9-10	2,552	227	328	383	2,880	610	13.0%	2.7%
10-11	1,273	167	251	367	1,524	534	10.3%	3.5%	10-11	1,918	246	316	435	2,234	681	10.1%	3.0%
11-12	861	227	200	339	1,061	566	7.2%	3.8%	11-12	1,341	302	224	426	1,565	728	7.1%	3.2%
12-13	581	167	168	295	749	462	5.1%	3.1%	12-13	752	246	185	423	937	669	4.2%	3.0%
13-14	580	142	162	324	742	466	5.0%	3.1%	13-14	783	213	241	461	1,024	674	4.6%	3.0%
14-15	436	217	143	383	579	600	3.9%	4.0%	14-15	871	253	218	444	1,089	697	4.9%	3.1%
15-16	368	267	140	451	508	718	3.4%	4.8%	15-16	714	320	194	612	908	932	4.1%	4.1%
16-17	345	330	146	519	491	849	3.3%	5.6%	16-17	593	366	205	814	798	1,180	3.6%	5.2%
17-18	436	339	160	651	596	990	4.0%	6.6%	17-18	614	442	209	911	823	1,353	3.7%	6.0%
18-19	332	367	151	713	483	1,080	3.3%	7.2%	18-19	429	371	198	971	627	1,342	2.8%	6.0%
19-20	254	335	153	627	407	962	2.8%	6.4%	19-20	384	380	196	1,146	580	1,526	2.6%	6.8%
20-21	251	598	166	997	417	1,595	2.8%	10.6%	20-21	335	699	186	1,521	521	2,220	2.4%	9.9%
21-22	290	652	182	1,426	472	2,078	3.2%	13.8%	21-22	336	1,374	234	1,679	570	3,053	2.6%	13.6%
22-23	194	639	216	1,387	410	2,026	2.8%	13.5%	22-23	240	1,443	199	1,681	439	3,124	2.0%	13.9%
23-0	117	189	85	202	202	391	1.4%	2.6%	23-0	154	1,191	85	1,274	239	2,465	1.1%	10.9%
0-1	85	121	34	112	119	233	0.8%	1.5%	0-1	142	169	56	160	198	329	0.9%	1.5%
合計	11,657	5,265	3,135	9,780	14,792	15,045	100.0%	100.0%	合計	18,142	8,546	3,987	13,973	22,129	22,519	100.0%	100.0%

：入退園交通量の合計値を算出する際に使用

※この「東京ディズニーリゾートの流出入交通量」は以下の著作物を改変して利用しています。

「主要交差点などの交通量調査結果（平成25年）」、浦安市、クリエイティブ・コモンズ・ライセンス表示 4.0 国際
[http://creativecommons.org/licenses/by/4.0/deed.ja\(link is external\)](http://creativecommons.org/licenses/by/4.0/deed.ja(link%20is%20external))

※入退園交通量は平日：29,837台、休日：44,648台、年平均：34,706台である。

<平日> 換算係数=平日交通量/年平均交通量=29,837台/34,706台=0.86

<休日> 換算係数=休日交通量/年平均交通量=44,648台/34,706台=1.29



図 1 交通量調査箇所

※この「交通量調査箇所」は以下の著作物を改変して利用しています。

「主要交差点などの交通量調査結果（平成 25 年）」、浦安市、クリエイティブ・コモンズ・ライセンス表示 4.0 国際
<http://creativecommons.org/licenses/by/4.0/deed.ja>(link is external))

(2) 物流施設

貨物・従業員とも「平成 17 年 物流センサス（国土交通省）の神奈川県発出荷量の曜日別指数」を基に、平日換算係数（1.22）と休日換算係数（0.56）を用いて、平日と休日それぞれの平均交通量を算出しました。

■算出式

$$\begin{aligned}(\text{物流施設の平日平均交通量}) &= (\text{年平均日交通量}) \times (\text{平日換算係数}) \\ &= (\text{年平均日交通量}) \times 1.22 \\ (\text{物流施設の休日平均交通量}) &= (\text{年平均日交通量}) \times (\text{休日換算係数}) \\ &= (\text{年平均日交通量}) \times 0.56\end{aligned}$$

表 2 神奈川県における出荷量の曜日別指数（産業別）

（年間調査 単位：トン、曜日平均出荷量＝1.00）

	日曜日	月曜日	火曜日	水曜日	木曜日	金曜日	土曜日	年間出荷量
神奈川県	0.35	1.19	1.18	1.15	1.17	1.23	0.73	169,116,682

平日平均:1.18

休日平均:0.54

【出典】「第 8 回全国貨物純流動調査（物流センサス）」国土交通省の「都道府県別出荷量の曜日別指数（産業別）」

※年平均は、平日を 245 日、休日を 120 日として換算

$$\Rightarrow \text{年平均} = (1.18 \times 245 \text{ 日} + 0.54 \times 120 \text{ 日}) / 365 = 0.97$$

$$\langle \text{平日} \rangle \quad \text{換算係数} = \text{平日平均} / \text{年平均} = 1.18 / 0.97 = 1.22$$

$$\langle \text{休日} \rangle \quad \text{換算係数} = \text{休日平均} / \text{年平均} = 0.54 / 0.97 = 0.56$$

(3) 公園

「平成 26 年度 都市公園利用実態調査」(国土交通省都市局 平成 27 年 3 月)の平休日の来園傾向データを基に、平日換算係数(0.68)と休日換算係数(1.65)を用いて、平日と休日それぞれの平均交通量を算出しました。

■算出式

$$\begin{aligned} (\text{公園の平日平均交通量}) &= (\text{年平均日交通量}) \times (\text{平日換算係数}) \\ &= (\text{年平均日交通量}) \times 0.68 \end{aligned}$$

$$\begin{aligned} (\text{公園の休日平均交通量}) &= (\text{年平均日交通量}) \times (\text{休日換算係数}) \\ &= (\text{年平均日交通量}) \times 1.65 \end{aligned}$$

【参考】平成 26 年度 都市公園利用実態調査(国土交通省)の「ha あたり入園者数」、及び「開設面積と利用可能面積」

表 3 都市公園利用実態調査(平成 26 年度総括表)

		街区	近隣	地区	運動	総合	広域	国営	
平均開設面積		ha/ヶ所	0.328	1.805	4.866	23.804	26.686	69.726	—
平均利用可能面積		ha/ヶ所	0.285	1.416	3.610	21.113	19.525	52.638	92.832
平均入園者数	休日	人	222	811	1,418	4,798	4,090	4,746	12,016
	平日	人	226	686	1,119	3,064	2,424	1,927	5,132
ha あたり入園者数	休日	人/ha	779	572	393	227	209	90	127
	平日	人/ha	795	484	310	145	124	37	38
平均在園時間	休日	時間	1.30	1.44	1.41	1.89	2.07	2.99	2.73
	平日	時間	1.09	1.09	1.26	1.19	1.45	2.39	1.50
最大時在園者数	休日	人/ha	106	88	55	54	52	33	55
	平日	人/ha	93	54	39	19	18	10	14
平均到達時間		分	13.3	17.3	18.3	25.9	31.7	43.3	67.4
80%到達時間		分	19.0	24.1	25.0	41.2	42.7	73.0	116.1
平均来園頻度		回/月	9.7	9.7	9.4	6.6	6.9	4.8	0.8
リピーター率		%	89.9	90.5	91.9	92.4	88.1	85.9	69.1
平均誘致圏人口		人	2,967	6,950	18,287	—	—	—	—
平均誘致圏老年人口		人	653	1,571	4,502	—	—	—	—
公園利用率	休日	%	7.9	11.9	8.5	—	—	—	—
	平日	%	8.2	10.3	6.7	—	—	—	—
老年公園利用率	休日	%	5.2	10.1	5.7	—	—	—	—
	平日	%	5.8	10.3	5.4	—	—	—	—
徒歩・自転車利用率		%	79.8	67.2	65.1	39.1	38.8	21.4	8.2
徒歩利用率		%	58.8	48.9	47.4	28.2	28.3	12.7	3.2
自転車利用率		%	21.0	18.3	17.7	10.9	10.5	8.7	5.0
バス、電車等の公共交通率		%	2.8	5.8	3.8	8.3	7.9	6.4	11.0
貸切バス利用率		%	0	0.1	0.1	0.4	0.6	1.6	5.4
自家用車利用率		%	15.5	24.7	28.6	49.2	50.2	68.4	73.3
バイク		%	1.1	1.2	1.3	1.8	1.2	1.3	0.6
その他		%	0.4	0.6	0.6	0.7	1.0	0.5	1.3
無回答		%	0.4	0.4	0.5	0.5	0.3	0.3	0.2

【出典】平成 26 年度 都市公園利用実態調査 報告書(抄)平成 27 年 3 月
(国土交通省 都市局 公園緑地・景観課)

【利用可能面積】

- 公園面積：広域公園 45.2ha
- 利用可能面積：広域公園の平均開設面積に対する平均利用可能面積の比率は、 $52.638 \div 69.726 = 75.5\%$ となっています。
(※利用可能面積＝植栽地等人が利用できない面積を除いた面積)

本広域公園における利用可能面積は、
 $45.2\text{ha} \times 75.5\% \approx 34.1\text{ha}$ となります。

【日入園者数、最大時在園者数】

「都市公園利用実態調査」によると、「広域公園」の利用可能面積に対し、次のような来園傾向になっています。

- ・ 入園者数は 平日 37 人/ha、休日 90 人/ha
- このデータから本公園（有効面積 ha）の需要を推計すると、
- ・ 入園者数は 平日 $37 \text{人/ha} \times 34.1\text{ha} \rightarrow 1,263 \text{人/日}$
休日 $90 \text{人/ha} \times 34.1\text{ha} \rightarrow 3,071 \text{人/日}$

【年間平均日入園者数】

平日と休日の日数は、下表のとおりとします。

表 4 平日と休日の日数

項目	設定条件	備考
年間の平日日数	245	
年間の休日日数	120	休日は、土日、祝日、年末年始、お盆と設定

年間入場者数は、下表のように算定されます。

表 5 年間入場者数

	平日	休日
来訪者数（人/日）	1,263	3,071
年間日数（日）	245	120
年間人数（人/年）	309,435	368,520
		677,955

年平均入場者数 $677,955 \text{人/年} \div 365 \text{日} = 1,857 \text{人/日}$

【換算係数】

平日 $1,263 \text{人} \div \text{年平均 } 1,857 \text{人} = 0.68$

休日 $3,071 \text{人} \div \text{年平均 } 1,857 \text{人} = 1.65$

(4) 防災施設

平日 or 休日換算係数は、「旧上瀬谷通信施設地区土地区画整理事業に伴う交通協議」より、平日のみ稼働していると想定し、休日換算係数は0としました。平日換算係数は、1.49としました。

■算出式

$$\begin{aligned}(\text{防災施設の平日平均交通量}) &= (\text{年平均日交通量}) \times (\text{平日換算係数}) \\ &= (\text{年平均日交通量}) \times 1.49\end{aligned}$$

【参考】既存の横浜市の施設である「消防訓練センター」の従業員数を自動車交通量に換算

表 6 防災施設の平日の従業員数

平日従業員数 (人/日)	279
自動車分担率	24%
平均乗車人員 (人/台)	1.09

【出典】既存の横浜市の施設である「消防訓練センター」の平日の従業員数

$$\begin{aligned}\text{※平日発生集中交通量} &= \text{平日従業員数} \times \text{自動車分担率} \div \text{平均乗車人員} \times (\text{発生} \rightarrow \text{発集換算}) \\ &= 279 \times 24\% \div 1.09 \times 2 \\ &= 122 \text{ 台}\end{aligned}$$

$$\text{※平日換算係数} = \text{平日発生集中交通量} / \text{年平均発生集中交通量} = 122 \text{ 台} / 82 \text{ 台} = 1.49$$

※年平均発生集中交通量は、平日を245日、休日を120日として換算

1.1.2 バックグラウンド交通

平日 or 休日換算係数は、「道路の交通容量」((社)日本道路協会 昭和59年9月)の「交通量の曜日変動」から、都市部(その他)の平日換算係数(1.04)、及び休日換算係数(0.92)を算定し、平日と休日それぞれの平均交通量を算出しました。

■算出式

$$\begin{aligned}(\text{バックグラウンドの平日平均交通量}) &= (\text{年平均日交通量}) \times (\text{平日換算係数}) \\ &= (\text{年平均日交通量}) \times 1.04\end{aligned}$$

$$\begin{aligned}(\text{バックグラウンドの休日平均交通量}) &= (\text{年平均日交通量}) \times (\text{休日換算係数}) \\ &= (\text{年平均日交通量}) \times 0.92\end{aligned}$$

※年平均は、平日を245日、休日を120日として換算

$$\text{年平均交通量} = (1.04 \times 245 + 0.92 \times 120) / 365 = 1.00$$

$$\text{＜平日＞換算係数} = \text{平日平均} / \text{年平均} = 1.04 / 1.00 = \mathbf{1.04}$$

$$\text{＜休日＞換算係数} = \text{休日平均} / \text{年平均} = 0.92 / 1.00 = \mathbf{0.92}$$

2. 時間係数の換算

時間別交通量を算出する際は、以下の資料を基に算出しました。

■ 開発交通

表 7 時間係数の出典

開発・設	ピーク率根拠資料		
	平日比、休日比	出典	備考
賑わい (来場者、従業員)	時間変動	主要交差点などの交通量調査結果(平成25年)浦安市 (東京ディズニーリゾートの交通量調査結果)	東京ディズニーリゾートの平・休日時間変動特性を参照
物流・設	貨物	第8回全国貨物純流動調査(平成17年) 国土交通省 神奈川県発・出荷時間帯別流動量	神奈川県出発時間帯別流動量(重量ベース) の営業用トラック計を参照
	従業員	第6回パーソントリップ調査(東京都市圏)(平成30年)	通勤(自宅-勤務)・帰宅、横浜市着を参照
公園	時間変動	「平成26年度 都市公園利用実態調査報告書(抄) 国土交通省」の入退園の経時変化データ 国土交通省	入退園の経時変化を参照
防災	時間変動	第6回パーソントリップ調査(東京都市圏)(平成30年)	通勤(自宅-勤務)・帰宅、横浜市着を参照

3. 結果

「1. 平日・休日平均交通量の換算」「2. 時間係数の換算」を基に単路部と交差点の平休交通量（台/日、台/時）を算定しました。

3.1 単路部

交通量と大型車混入率について、平日・休日平均の算出結果を以下に示します。

表 8 単路部の平休別交通量（台/日）、大型車混入率

No	箇所	交通量(台/日)		大型車混入率	
		平日平均	休日平均	平日平均	休日平均
断面1	環状4号線(鴨志田線)	22,552	21,383	25.6%	23.7%
断面2	五貫目第33号線	24,251	21,774	34.7%	34.1%
断面3	五貫目第33号線	27,524	28,489	22.9%	19.2%
断面4	その他道路	8,277	7,957	15.2%	13.8%
断面5	環状4号線(上瀬谷線)	10,866	9,775	18.1%	17.3%
断面6	その他道路	9,119	8,859	13.0%	11.4%



図 2 算定箇所（断面1～6）

3.1.1 断面計

断面計の平休時間帯別交通量を以下に示します。

表 9 単路部交通量（時間帯）

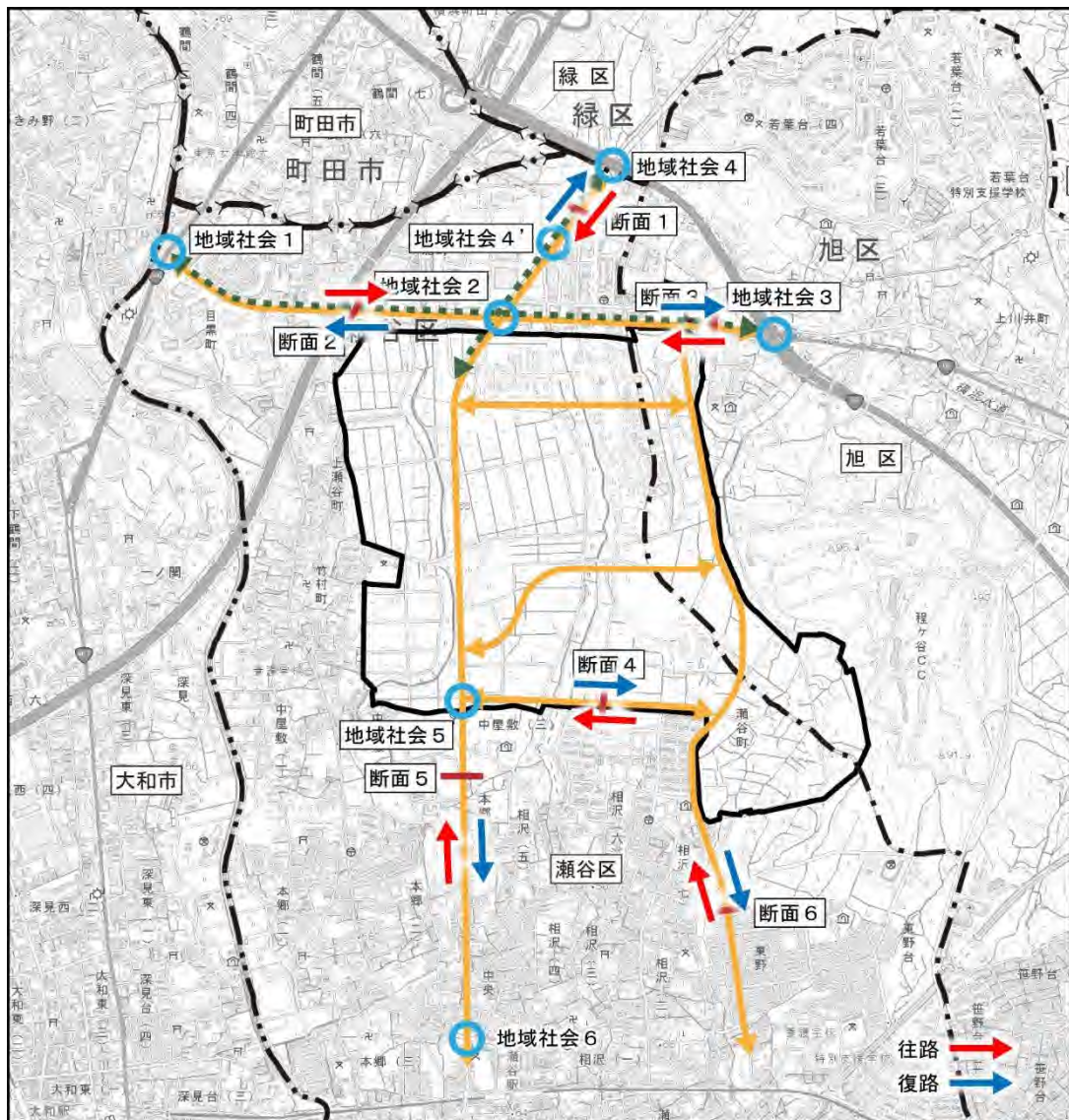
	時間帯	断面①	断面②	断面③	断面④	断面⑤	断面⑥
平日	1時	516	601	258	25	75	29
	2時	421	522	246	23	73	26
	3時	1,726	2,062	270	24	68	29
	4時	422	470	402	27	115	31
	5時	371	511	877	122	282	140
	6時	462	541	1,211	391	623	445
	7時	2,701	2,904	1,528	696	793	796
	8時	880	831	1,995	738	762	839
	9時	698	736	1,846	543	605	612
	10時	707	785	1,650	472	623	532
	11時	683	718	1,550	414	574	473
	12時	2,352	2,745	1,384	363	500	417
	13時	659	711	1,371	461	575	520
	14時	598	580	1,340	414	572	467
	15時	636	617	1,415	492	624	550
	16時	725	648	1,495	535	646	587
	17時	2,279	2,404	1,636	640	725	695
	18時	634	604	1,510	569	683	605
	19時	594	644	1,227	373	548	394
	20時	717	626	1,262	365	505	370
	21時	779	688	1,179	239	348	225
	22時	2,102	2,328	1,062	221	306	205
	23時	430	476	468	87	149	88
	24時	460	499	342	43	92	44
	1日	22,552	24,251	27,524	8,277	10,866	9,119
休日	1時	133	247	234	37	82	40
	2時	123	226	229	19	72	20
	3時	131	216	187	23	72	25
	4時	132	229	213	23	81	24
	5時	215	385	354	94	139	105
	6時	404	564	531	148	241	170
	7時	903	877	1,894	388	457	435
	8時	1,196	1,221	2,141	413	569	478
	9時	1,118	1,260	2,039	482	561	601
	10時	1,158	1,344	1,905	596	591	693
	11時	1,297	1,234	1,641	568	631	668
	12時	1,201	1,204	1,410	551	624	640
	13時	1,297	1,299	1,408	512	574	593
	14時	1,371	1,268	1,499	535	637	615
	15時	1,417	1,302	1,504	529	648	606
	16時	1,466	1,305	1,524	580	633	655
	17時	1,476	1,386	1,630	562	633	625
	18時	1,247	1,346	1,399	440	552	483
	19時	1,092	1,129	1,270	335	453	358
	20時	1,040	947	1,311	285	417	271
	21時	1,081	934	1,452	308	395	282
	22時	958	922	1,328	277	351	247
	23時	696	554	961	197	238	171
	24時	231	375	425	55	124	54
	1日	21,383	21,774	28,489	7,957	9,775	8,859

3.1.2 上下線別

往復別の平休時間帯別交通量、大型車混入率を算定しました。

(1) 断面 1

表 10 断面 1 (往路・復路)

	時間帯	往路			復路		
		全車	大型車	大型混入率	全車	大型車	大型混入率
平日	1時	276	113	0.41	240	77	0.32
	2時	202	67	0.33	219	28	0.13
	3時	910	327	0.36	816	253	0.31
	4時	236	78	0.33	186	43	0.23
	5時	208	66	0.32	163	18	0.11
	6時	259	101	0.39	203	42	0.21
	7時	1,264	258	0.20	1,437	210	0.15
	8時	470	59	0.13	410	42	0.10
	9時	316	80	0.25	382	88	0.23
	10時	337	63	0.19	370	67	0.18
	11時	296	76	0.26	387	106	0.27
	12時	1,076	236	0.22	1,276	289	0.23
	13時	282	62	0.22	377	90	0.24
	14時	240	87	0.36	358	104	0.29
	15時	263	117	0.44	373	100	0.27
	16時	335	117	0.35	390	107	0.27
	17時	1,039	357	0.34	1,240	395	0.32
	18時	235	91	0.39	399	82	0.21
	19時	245	87	0.36	349	50	0.14
	20時	230	87	0.38	487	71	0.15
	21時	251	84	0.33	528	87	0.16
	22時	907	337	0.37	1,195	287	0.24
	23時	206	100	0.49	224	53	0.24
	24時	233	47	0.20	227	94	0.41
1日		10,316	3,097	0.30	12,236	2,783	0.23
休日	1時	64	57	0.89	69	47	0.68
	2時	82	57	0.70	41	38	0.93
	3時	74	59	0.80	57	56	0.98
	4時	63	58	0.92	69	23	0.33
	5時	77	21	0.27	138	120	0.87
	6時	180	129	0.72	224	98	0.44
	7時	454	234	0.52	449	323	0.72
	8時	581	267	0.46	615	323	0.53
	9時	501	188	0.38	617	323	0.52
	10時	546	145	0.27	612	98	0.16
	11時	650	131	0.20	647	109	0.17
	12時	581	156	0.27	620	39	0.06
	13時	599	79	0.13	698	76	0.11
	14時	655	115	0.18	716	121	0.17
	15時	714	142	0.20	703	66	0.09
	16時	645	156	0.24	821	39	0.05
	17時	581	171	0.29	895	172	0.19
	18時	527	101	0.19	720	76	0.11
	19時	436	46	0.11	656	56	0.09
	20時	365	46	0.13	675	39	0.06
	21時	326	99	0.30	755	23	0.03
	22時	239	87	0.36	719	65	0.09
	23時	183	87	0.48	513	86	0.17
	24時	101	44	0.44	130	30	0.23
1日		9,224	2,675	0.29	12,159	2,446	0.20

(2) 断面 2

表 11 断面 2 (往路・復路)

	時間帯	往路			復路		
		全車	大型車	大型混入率	全車	大型車	大型混入率
平日	1時	258	110	0.43	343	147	0.43
	2時	295	96	0.33	227	74	0.33
	3時	965	438	0.45	1,097	449	0.41
	4時	165	65	0.39	305	125	0.41
	5時	232	78	0.34	279	137	0.49
	6時	275	113	0.41	266	107	0.40
	7時	1,597	345	0.22	1,307	388	0.30
	8時	431	69	0.16	400	101	0.25
	9時	451	84	0.19	285	91	0.32
	10時	430	84	0.20	355	104	0.29
	11時	365	116	0.32	353	116	0.33
	12時	1,463	331	0.23	1,282	374	0.29
	13時	430	196	0.46	281	75	0.27
	14時	312	177	0.57	268	105	0.39
	15時	297	93	0.31	320	136	0.43
	16時	270	93	0.34	378	136	0.36
	17時	1,264	550	0.44	1,140	429	0.38
	18時	283	163	0.58	321	90	0.28
	19時	284	137	0.48	360	126	0.35
	20時	279	131	0.47	347	138	0.40
	21時	298	109	0.37	390	86	0.22
	22時	1,111	534	0.48	1,217	428	0.35
	23時	210	90	0.43	266	153	0.58
	24時	209	141	0.67	290	74	0.26
1日	12,174	4,343	0.36	12,077	4,189	0.35	
休日	1時	131	114	0.87	116	96	0.83
	2時	109	94	0.86	117	105	0.90
	3時	93	56	0.60	123	103	0.84
	4時	136	122	0.90	93	60	0.65
	5時	221	122	0.55	164	104	0.63
	6時	280	123	0.44	284	150	0.53
	7時	461	194	0.42	416	263	0.63
	8時	624	347	0.56	597	194	0.32
	9時	625	338	0.54	635	188	0.30
	10時	593	141	0.24	751	223	0.30
	11時	555	171	0.31	679	165	0.24
	12時	583	181	0.31	621	163	0.26
	13時	656	125	0.19	643	145	0.23
	14時	602	166	0.28	666	135	0.20
	15時	631	89	0.14	671	152	0.23
	16時	603	89	0.15	702	163	0.23
	17時	734	181	0.25	652	132	0.20
	18時	703	185	0.26	643	199	0.31
	19時	657	235	0.36	472	137	0.29
	20時	477	142	0.30	470	173	0.37
	21時	407	176	0.43	527	226	0.43
	22時	500	145	0.29	422	139	0.33
	23時	256	100	0.39	298	132	0.44
	24時	198	180	0.91	177	103	0.58
1日	10,835	3,816	0.35	10,939	3,650	0.33	

(3) 断面 3

表 12 断面 3 (往路・復路)

	時間帯	往路			復路		
		全車	大型車	大型混入率	全車	大型車	大型混入率
平日	1時	131	71	0.54	127	63	0.50
	2時	156	95	0.61	90	59	0.66
	3時	134	93	0.69	136	91	0.67
	4時	205	111	0.54	197	113	0.57
	5時	421	201	0.48	456	196	0.43
	6時	707	217	0.31	504	182	0.36
	7時	1,089	158	0.15	439	158	0.36
	8時	1,473	167	0.11	522	175	0.34
	9時	1,251	218	0.17	595	234	0.39
	10時	1,078	234	0.22	572	224	0.39
	11時	939	249	0.27	611	198	0.32
	12時	770	201	0.26	614	216	0.35
	13時	770	198	0.26	601	203	0.34
	14時	716	210	0.29	624	188	0.30
	15時	750	211	0.28	665	146	0.22
	16時	756	195	0.26	739	151	0.20
	17時	773	145	0.19	863	111	0.13
	18時	684	103	0.15	826	103	0.12
	19時	539	60	0.11	688	79	0.11
	20時	534	74	0.14	728	69	0.09
	21時	466	78	0.17	713	52	0.07
	22時	388	65	0.17	674	67	0.10
	23時	235	52	0.22	233	58	0.25
	24時	174	52	0.30	168	68	0.40
	1日		15,139	3,458	0.23	12,385	3,204
休日	1時	122	83	0.68	112	107	0.96
	2時	132	92	0.70	97	70	0.72
	3時	106	94	0.89	81	73	0.90
	4時	101	92	0.91	112	73	0.65
	5時	180	131	0.73	174	93	0.53
	6時	307	136	0.44	224	142	0.63
	7時	1,503	137	0.09	391	160	0.41
	8時	1,643	209	0.13	498	98	0.20
	9時	1,502	135	0.09	537	124	0.23
	10時	1,334	121	0.09	571	163	0.29
	11時	1,052	118	0.11	589	141	0.24
	12時	839	141	0.17	571	163	0.29
	13時	833	114	0.14	575	116	0.20
	14時	920	148	0.16	579	116	0.20
	15時	836	89	0.11	668	124	0.19
	16時	795	117	0.15	729	101	0.14
	17時	823	127	0.15	807	103	0.13
	18時	650	101	0.16	749	109	0.15
	19時	549	181	0.33	721	122	0.17
	20時	516	152	0.29	795	119	0.15
	21時	526	131	0.25	926	146	0.16
	22時	420	83	0.20	908	89	0.10
	23時	261	108	0.41	700	61	0.09
	24時	225	111	0.49	200	66	0.33
	1日		16,175	2,951	0.18	12,314	2,679

(4) 断面 4

表 13 断面 4 (往路・復路)

	時間帯	往路			復路		
		全車	大型車	大型混入率	全車	大型車	大型混入率
平日	1時	11	2	0.18	14	9	0.64
	2時	9	8	0.89	14	9	0.64
	3時	13	2	0.15	11	9	0.82
	4時	16	2	0.13	11	1	0.09
	5時	83	6	0.07	39	0	0.00
	6時	183	25	0.14	208	50	0.24
	7時	386	43	0.11	310	15	0.05
	8時	431	56	0.13	307	140	0.46
	9時	341	74	0.22	202	118	0.58
	10時	272	50	0.18	200	27	0.14
	11時	238	51	0.21	176	50	0.28
	12時	202	41	0.20	161	34	0.21
	13時	275	69	0.25	186	15	0.08
	14時	198	114	0.58	216	50	0.23
	15時	268	22	0.08	224	21	0.09
	16時	287	54	0.19	248	15	0.06
	17時	298	54	0.18	342	21	0.06
	18時	321	5	0.02	248	5	0.02
	19時	212	7	0.03	161	2	0.01
	20時	122	15	0.12	243	5	0.02
	21時	76	8	0.11	163	5	0.03
	22時	54	4	0.07	167	0	0.00
	23時	27	2	0.07	60	0	0.00
	24時	13	0	0.00	30	0	0.00
	1日		4,336	714	0.16	3,941	601
休日	1時	15	14	0.93	22	8	0.36
	2時	9	0	0.00	10	8	0.80
	3時	16	5	0.31	7	0	0.00
	4時	14	1	0.07	9	0	0.00
	5時	36	26	0.72	58	8	0.14
	6時	74	8	0.11	74	8	0.11
	7時	223	40	0.18	165	39	0.24
	8時	260	55	0.21	153	72	0.47
	9時	325	42	0.13	157	72	0.46
	10時	369	17	0.05	227	72	0.32
	11時	349	42	0.12	219	72	0.33
	12時	336	109	0.32	215	39	0.18
	13時	283	40	0.14	229	0	0.00
	14時	270	16	0.06	265	21	0.08
	15時	292	16	0.05	237	21	0.09
	16時	298	27	0.09	282	8	0.03
	17時	269	16	0.06	293	39	0.13
	18時	222	1	0.00	218	21	0.10
	19時	133	26	0.20	202	8	0.04
	20時	84	15	0.18	201	8	0.04
	21時	90	38	0.42	218	0	0.00
	22時	55	25	0.45	222	8	0.04
	23時	36	13	0.36	161	0	0.00
	24時	23	0	0.00	32	0	0.00
	1日		4,081	592	0.15	3,876	532

(5) 断面 5

表 14 断面 5 (往路・復路)

	時間帯	往路			復路		
		全車	大型車	大型混入率	全車	大型車	大型混入率
平日	1時	33	22	0.67	42	15	0.36
	2時	40	22	0.55	33	15	0.45
	3時	42	30	0.71	26	11	0.42
	4時	71	41	0.58	44	16	0.36
	5時	188	54	0.29	94	37	0.39
	6時	388	80	0.21	235	60	0.26
	7時	458	75	0.16	335	72	0.21
	8時	453	69	0.15	309	77	0.25
	9時	334	81	0.24	271	92	0.34
	10時	319	81	0.25	304	77	0.25
	11時	289	96	0.33	285	70	0.25
	12時	241	78	0.32	259	55	0.21
	13時	308	83	0.27	267	58	0.22
	14時	262	73	0.28	310	61	0.20
	15時	304	53	0.17	320	56	0.18
	16時	275	55	0.20	371	52	0.14
	17時	305	50	0.16	420	34	0.08
	18時	282	32	0.11	401	21	0.05
	19時	220	17	0.08	328	17	0.05
	20時	183	20	0.11	322	13	0.04
	21時	119	14	0.12	229	9	0.04
	22時	104	17	0.16	202	15	0.07
	23時	53	18	0.34	96	13	0.14
	24時	31	9	0.29	61	15	0.25
	1日		5,302	1,170	0.22	5,564	961
休日	1時	38	25	0.66	44	33	0.75
	2時	28	24	0.86	44	38	0.86
	3時	38	28	0.74	34	29	0.85
	4時	36	27	0.75	45	29	0.64
	5時	74	41	0.55	65	55	0.85
	6時	139	45	0.32	102	38	0.37
	7時	271	45	0.17	186	59	0.32
	8時	337	68	0.20	232	48	0.21
	9時	358	47	0.13	203	49	0.24
	10時	330	42	0.13	261	26	0.10
	11時	338	41	0.12	293	36	0.12
	12時	337	46	0.14	287	37	0.13
	13時	288	38	0.13	286	31	0.11
	14時	309	48	0.16	328	31	0.09
	15時	310	31	0.10	338	37	0.11
	16時	313	39	0.12	320	29	0.09
	17時	286	42	0.15	347	21	0.06
	18時	244	32	0.13	308	30	0.10
	19時	173	57	0.33	280	22	0.08
	20時	158	48	0.30	259	26	0.10
	21時	145	40	0.28	250	31	0.12
	22時	98	25	0.26	253	31	0.12
	23時	75	33	0.44	163	40	0.25
	24時	43	34	0.79	81	13	0.16
	1日		4,766	946	0.20	5,009	819

(6) 断面 6

表 15 断面 6 (往路・復路)

	時間帯	往路			復路		
		全車	大型車	大型混入率	全車	大型車	大型混入率
平日	1時	13	2	0.15	16	8	0.50
	2時	10	8	0.80	16	9	0.56
	3時	17	5	0.29	12	9	0.75
	4時	20	5	0.25	11	2	0.18
	5時	97	9	0.09	43	0	0.00
	6時	219	29	0.13	226	45	0.20
	7時	466	44	0.09	330	13	0.04
	8時	517	58	0.11	322	127	0.39
	9時	401	76	0.19	211	106	0.50
	10時	323	54	0.17	209	24	0.11
	11時	291	55	0.19	182	45	0.25
	12時	250	42	0.17	167	30	0.18
	13時	326	69	0.21	194	13	0.07
	14時	242	109	0.45	225	45	0.20
	15時	318	27	0.08	232	19	0.08
	16時	331	56	0.17	256	14	0.05
	17時	338	55	0.16	357	19	0.05
	18時	352	6	0.02	253	5	0.02
	19時	233	9	0.04	161	2	0.01
	20時	132	16	0.12	238	5	0.02
	21時	81	8	0.10	144	4	0.03
	22時	57	5	0.09	148	0	0.00
	23時	30	2	0.07	58	0	0.00
	24時	15	1	0.07	29	0	0.00
	1日		5,079	750	0.15	4,040	544
休日	1時	16	12	0.75	24	7	0.29
	2時	10	0	0.00	10	7	0.70
	3時	18	6	0.33	7	0	0.00
	4時	16	2	0.13	8	0	0.00
	5時	42	24	0.57	63	7	0.11
	6時	90	10	0.11	80	7	0.09
	7時	263	40	0.15	172	36	0.21
	8時	321	54	0.17	157	65	0.41
	9時	441	42	0.10	160	65	0.41
	10時	458	21	0.05	235	65	0.28
	11時	442	43	0.10	226	65	0.29
	12時	417	101	0.24	223	36	0.16
	13時	355	39	0.11	238	0	0.00
	14時	339	17	0.05	276	19	0.07
	15時	364	17	0.05	242	19	0.08
	16時	368	27	0.07	287	7	0.02
	17時	328	17	0.05	297	36	0.12
	18時	268	2	0.01	215	19	0.09
	19時	163	25	0.15	195	7	0.04
	20時	89	14	0.16	182	7	0.04
	21時	95	34	0.36	187	0	0.00
	22時	57	22	0.39	190	7	0.04
	23時	37	12	0.32	134	0	0.00
	24時	24	1	0.04	30	0	0.00
	1日		5,021	582	0.12	3,838	481

3.2 交差点部（地域社会）

地域社会1～6、地域社会8及び地域社会9について、平休時間帯別交通量を算定しました。なお、地域社会7の平日、休日の時間別・方向別の交通量は、「表15 断面6（往路・復路）」（P.資料 地域-981）に示すとおりです。



図3 4差路と3差路の流入部番号



図4 交差点位置図（地域社会1～9）

表 16 【方向別交通量】目黒交差点（地域社会 1）

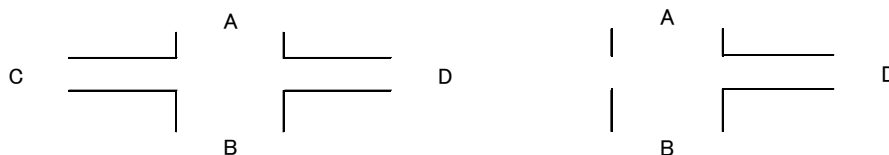
		方向別交通量												計	
		A→B	A→C	A→D	B→A	B→C	B→D	C→A	C→B	C→D	D→A	D→B	D→C		
平日	7時	27	137	152	40	428	629	144	297	158	53	457	94	2,617	
	8時	26	132	153	38	413	613	138	287	165	56	442	93	2,556	
	9時	24	121	129	35	377	545	126	262	130	50	407	85	2,291	
	10時	25	126	129	36	394	562	132	273	124	53	425	89	2,369	
	11時	26	131	131	38	410	582	137	284	124	56	444	93	2,458	
	12時	25	130	128	37	403	572	135	280	120	53	434	91	2,408	
	13時	24	123	121	35	383	542	128	266	113	51	412	86	2,285	
	14時	27	135	132	39	420	593	141	291	122	58	454	96	2,508	
	15時	26	131	128	38	407	576	137	283	118	60	445	96	2,444	
	16時	28	144	140	41	447	632	150	311	129	67	487	106	2,681	
	17時	30	150	146	43	468	661	157	325	135	73	513	113	2,813	
	18時	29	148	143	43	460	649	154	319	132	74	504	112	2,766	
	19時	26	130	126	38	405	571	136	281	116	65	443	98	2,435	
	20時	23	115	112	33	359	506	120	249	103	73	393	94	2,179	
	21時	18	91	89	26	284	401	95	197	82	74	311	82	1,751	
	22時	15	74	72	21	231	327	78	161	67	67	253	70	1,436	
	23時	9	47	46	14	147	207	49	102	42	24	158	35	880	
	24時	7	36	35	10	112	158	38	78	32	17	119	26	667	
			A→B	A→C	A→D	B→A	B→C	B→D	C→A	C→B	C→D	D→A	D→B	D→C	計
	休日	7時	18	90	101	26	279	415	94	194	111	42	298	64	1,730
		8時	11	54	75	16	170	268	57	118	94	37	184	45	1,127
		9時	8	40	54	12	126	193	42	87	65	29	139	35	830
		10時	7	34	43	10	106	159	35	73	49	28	118	31	693
		11時	6	31	37	9	96	142	32	66	40	29	109	31	627
12時		5	26	30	7	80	118	27	56	32	24	91	26	524	
13時		5	24	28	7	73	108	25	51	30	24	84	25	481	
14時		8	39	41	11	122	175	41	85	41	34	137	38	771	
15時		10	53	54	15	165	236	55	115	53	43	185	49	1,035	
16時		15	78	78	22	243	345	81	169	74	55	267	68	1,494	
17時		22	110	108	32	341	484	114	237	102	71	373	91	2,085	
18時		24	119	117	34	372	526	125	258	109	78	405	99	2,266	
19時		28	143	139	41	445	628	149	309	128	81	479	111	2,683	
20時		27	138	134	40	431	608	145	299	124	98	466	117	2,628	
21時		26	133	129	38	414	584	139	287	120	110	447	119	2,547	
22時		27	137	132	40	426	602	143	296	123	109	459	120	2,614	
23時		27	136	130	39	423	596	142	294	120	57	447	95	2,505	
24時		27	137	131	40	427	600	143	296	120	52	449	92	2,515	

表 17 【大型車混入率】目黒交差点（地域社会 1）

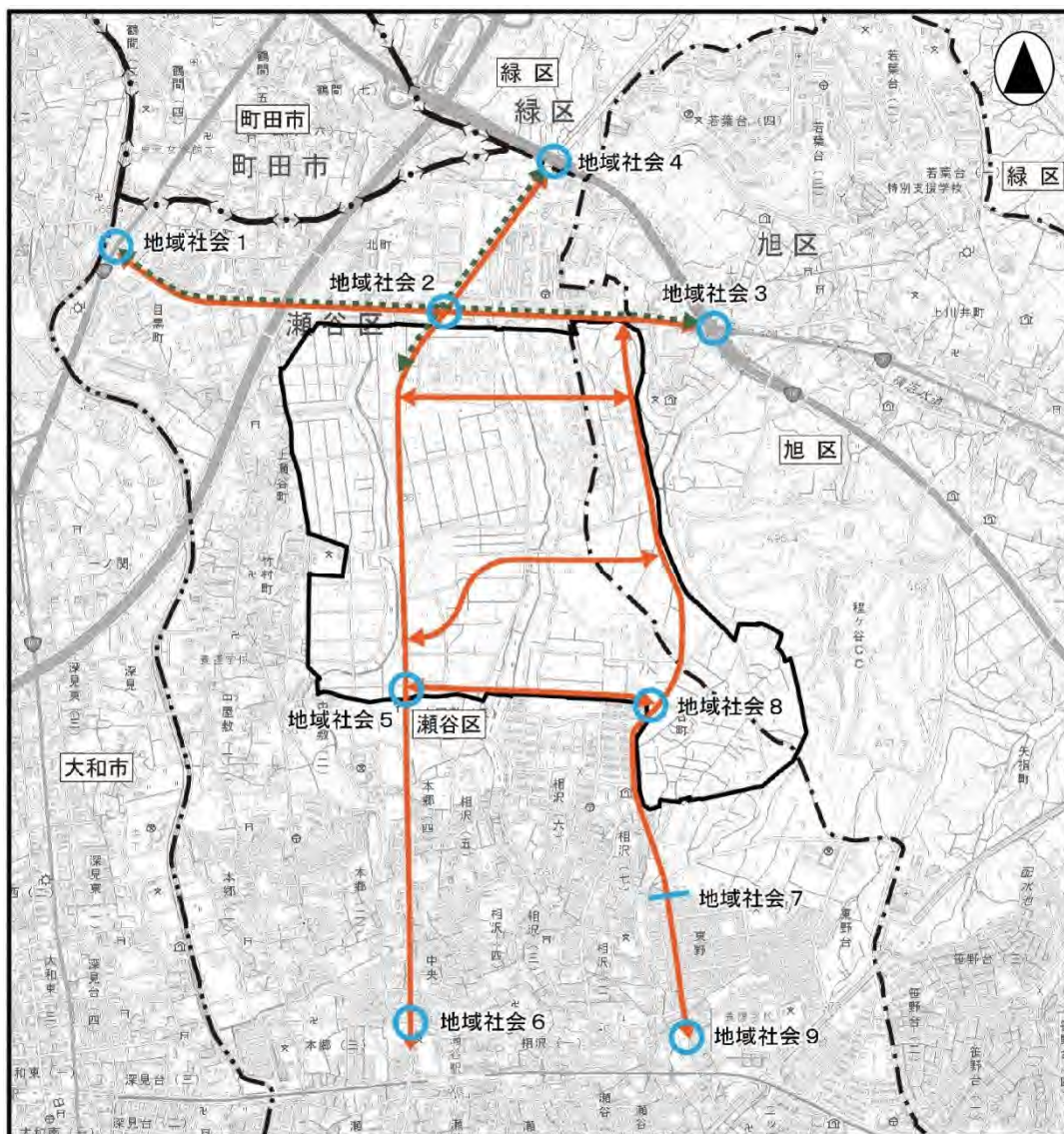
		大型車混入率												計	
		A→B	A→C	A→D	B→A	B→C	B→D	C→A	C→B	C→D	D→A	D→B	D→C		
平日	7時	0.29	0.31	0.28	0.17	0.15	0.30	0.32	0.21	0.18	0.19	0.39	0.34	0.27	
	8時	0.29	0.31	0.27	0.17	0.15	0.30	0.32	0.21	0.17	0.18	0.39	0.33	0.27	
	9時	0.29	0.31	0.30	0.17	0.15	0.31	0.32	0.21	0.19	0.18	0.39	0.33	0.27	
	10時	0.29	0.31	0.17	0.15	0.15	0.31	0.32	0.21	0.21	0.18	0.39	0.33	0.28	
	11時	0.29	0.31	0.32	0.17	0.15	0.31	0.32	0.21	0.22	0.18	0.39	0.33	0.28	
	12時	0.29	0.31	0.32	0.17	0.15	0.31	0.32	0.21	0.22	0.18	0.39	0.33	0.28	
	13時	0.29	0.31	0.32	0.17	0.15	0.31	0.32	0.21	0.22	0.18	0.39	0.33	0.28	
	14時	0.29	0.31	0.32	0.17	0.15	0.31	0.32	0.21	0.23	0.17	0.39	0.33	0.28	
	15時	0.29	0.31	0.32	0.17	0.15	0.31	0.32	0.21	0.23	0.16	0.38	0.32	0.28	
	16時	0.29	0.31	0.32	0.17	0.15	0.31	0.32	0.21	0.23	0.16	0.39	0.32	0.28	
	17時	0.29	0.31	0.32	0.17	0.15	0.31	0.32	0.21	0.23	0.16	0.38	0.31	0.28	
	18時	0.29	0.31	0.32	0.17	0.15	0.31	0.32	0.21	0.23	0.15	0.38	0.31	0.28	
	19時	0.29	0.31	0.32	0.17	0.15	0.31	0.32	0.21	0.23	0.15	0.38	0.31	0.28	
	20時	0.29	0.31	0.32	0.17	0.15	0.31	0.32	0.21	0.23	0.12	0.38	0.29	0.27	
	21時	0.29	0.31	0.32	0.17	0.15	0.31	0.32	0.21	0.22	0.09	0.38	0.26	0.27	
	22時	0.29	0.31	0.32	0.17	0.15	0.31	0.32	0.21	0.22	0.08	0.38	0.25	0.27	
	23時	0.29	0.31	0.32	0.17	0.15	0.31	0.32	0.21	0.23	0.15	0.39	0.31	0.28	
	24時	0.29	0.31	0.32	0.17	0.15	0.31	0.32	0.21	0.23	0.16	0.39	0.32	0.28	
			A→B	A→C	A→D	B→A	B→C	B→D	C→A	C→B	C→D	D→A	D→B	D→C	計
	休日	7時	0.29	0.31	0.28	0.17	0.15	0.30	0.32	0.21	0.16	0.16	0.39	0.33	0.27
		8時	0.29	0.31	0.23	0.17	0.15	0.28	0.32	0.21	0.12	0.11	0.39	0.28	0.25
		9時	0.29	0.31	0.24	0.17	0.15	0.29	0.32	0.21	0.13	0.10	0.39	0.27	0.25
		10時	0.29	0.31	0.25	0.17	0.15	0.29	0.32	0.21	0.15	0.09	0.39	0.25	0.26
		11時	0.29	0.31	0.27	0.17	0.15	0.30	0.32	0.21	0.16	0.08	0.38	0.24	0.26
12時		0.29	0.31	0.28	0.17	0.15	0.30	0.32	0.21	0.17	0.08	0.38	0.23	0.26	
13時		0.29	0.31	0.27	0.17	0.15	0.30	0.32	0.21	0.16	0.08	0.38	0.23	0.26	
14時		0.29	0.31	0.30	0.17	0.15	0.31	0.32	0.21	0.19	0.09	0.38	0.24	0.26	
15時		0.29	0.31	0.31	0.17	0.15	0.31	0.32	0.21	0.21	0.09	0.38	0.25	0.27	
16時		0.29	0.31	0.31	0.17	0.15	0.31	0.32	0.21	0.22	0.11	0.38	0.27	0.27	
17時		0.29	0.31	0.32	0.17	0.15	0.31	0.32	0.21	0.22	0.12	0.38	0.28	0.27	
18時		0.29	0.31	0.32	0.17	0.15	0.31	0.32	0.21	0.22	0.12	0.38	0.28	0.27	
19時		0.29	0.31	0.32	0.17	0.15	0.31	0.32	0.21	0.23	0.13	0.39	0.30	0.28	
20時		0.29	0.31	0.32	0.17	0.15	0.31	0.32	0.21	0.23	0.11	0.38	0.28	0.27	
21時		0.29	0.31	0.32	0.17	0.15	0.31	0.32	0.21	0.22	0.09	0.38	0.26	0.27	
22時		0.29	0.31	0.32	0.17	0.15	0.31	0.32	0.21	0.23	0.09	0.38	0.26	0.27	
23時		0.29	0.31	0.32	0.17	0.15	0.31	0.32	0.21	0.23	0.18	0.39	0.33	0.28	
24時		0.29	0.31	0.33	0.17	0.15	0.31	0.32	0.21	0.23	0.20	0.39	0.34	0.28	

表 18 【方向別交通量】目黒交番前交差点（地域社会 2）

		A→B	A→C	A→D	B→A	B→C	B→D	C→A	C→B	C→D	D→A	D→B	D→C	計	
		平日	7時	380	188	57	358	80	18	159	203	337	50	155	328
8時	411		190	62	384	87	19	160	218	349	54	169	332	2,435	
9時	356		189	52	374	84	18	159	166	337	54	121	333	2,244	
10時	328		187	47	376	85	18	158	148	328	55	104	331	2,164	
11時	310		183	44	378	85	18	155	141	316	57	98	328	2,113	
12時	286		185	43	357	83	18	156	138	317	53	84	327	2,048	
13時	266		171	40	335	78	17	144	128	293	50	79	303	1,902	
14時	289		191	44	387	91	19	162	140	325	60	83	343	2,134	
15時	266		175	40	381	89	19	148	129	297	61	79	320	2,004	
16時	296		198	45	432	102	21	167	144	336	68	85	361	2,256	
17時	341		231	52	504	119	25	195	166	392	81	95	422	2,622	
18時	316		209	47	496	113	23	177	149	354	78	77	385	2,424	
19時	272		177	40	427	96	20	150	126	300	66	67	326	2,066	
20時	233		148	33	449	102	20	125	105	251	69	58	275	1,867	
21時	178		108	25	440	99	18	91	78	185	67	37	206	1,533	
22時	190		119	27	446	100	19	100	84	203	66	39	221	1,616	
23時	87		62	14	144	34	7	53	44	106	22	21	112	709	
24時	75		54	12	111	27	6	46	38	92	16	19	95	590	
			A→B	A→C	A→D	B→A	B→C	B→D	C→A	C→B	C→D	D→A	D→B	D→C	計
休日	7時		262	114	49	267	58	12	96	122	223	36	92	200	1,530
	8時		363	164	67	380	86	18	138	169	322	53	119	286	2,165
	9時		341	173	54	381	87	18	146	152	322	53	95	302	2,123
	10時		334	187	50	409	94	19	158	150	336	58	87	328	2,211
	11時		298	173	44	398	91	19	146	135	304	58	78	305	2,048
	12時	269	170	42	366	87	18	144	129	296	54	69	299	1,942	
	13時	286	184	44	386	92	19	156	138	319	56	72	322	2,075	
	14時	274	179	42	410	98	20	151	133	308	62	69	317	2,063	
	15時	277	183	43	444	105	21	155	135	314	69	70	327	2,142	
	16時	275	183	42	467	112	22	154	134	312	72	70	328	2,171	
	17時	291	193	45	515	122	24	163	141	331	82	73	349	2,328	
	18時	290	188	43	538	123	24	158	136	321	84	66	341	2,312	
	19時	244	155	36	458	103	21	131	112	264	71	55	282	1,930	
	20時	204	124	29	512	116	22	105	90	214	79	46	235	1,777	
	21時	196	118	28	579	131	24	100	86	205	89	40	226	1,821	
	22時	191	116	27	561	127	23	98	83	200	85	39	220	1,771	
	23時	94	66	15	175	42	8	56	48	114	27	22	118	786	
	24時	74	53	12	123	29	6	45	38	90	18	18	92	598	

表 19 【大型車混入率】目黒交番前交差点（地域社会 2）

		A→B	A→C	A→D	B→A	B→C	B→D	C→A	C→B	C→D	D→A	D→B	D→C	計	
		平日	7時	0.21	0.42	0.07	0.21	0.12	0.20	0.43	0.12	0.38	0.10	0.15	0.38
8時	0.20		0.42	0.07	0.20	0.11	0.19	0.43	0.11	0.37	0.10	0.14	0.38	0.26	
9時	0.23		0.42	0.08	0.20	0.11	0.19	0.43	0.14	0.38	0.10	0.22	0.38	0.28	
10時	0.25		0.42	0.09	0.20	0.11	0.19	0.43	0.16	0.39	0.10	0.26	0.38	0.29	
11時	0.26		0.42	0.09	0.20	0.11	0.19	0.43	0.17	0.40	0.10	0.27	0.37	0.29	
12時	0.23		0.42	0.09	0.18	0.11	0.19	0.43	0.16	0.40	0.09	0.25	0.37	0.29	
13時	0.24		0.42	0.09	0.18	0.11	0.19	0.43	0.17	0.40	0.09	0.25	0.37	0.29	
14時	0.24		0.42	0.09	0.17	0.10	0.18	0.43	0.17	0.40	0.08	0.25	0.37	0.28	
15時	0.24		0.42	0.09	0.16	0.10	0.17	0.43	0.17	0.40	0.08	0.26	0.36	0.28	
16時	0.24		0.42	0.09	0.15	0.10	0.17	0.43	0.17	0.41	0.07	0.26	0.36	0.28	
17時	0.23		0.42	0.09	0.15	0.10	0.17	0.43	0.17	0.41	0.07	0.25	0.36	0.28	
18時	0.26		0.42	0.09	0.16	0.09	0.16	0.43	0.17	0.41	0.06	0.23	0.35	0.28	
19時	0.27		0.42	0.09	0.17	0.09	0.16	0.43	0.17	0.41	0.06	0.24	0.35	0.28	
20時	0.29		0.42	0.09	0.14	0.07	0.14	0.43	0.17	0.40	0.05	0.24	0.35	0.26	
21時	0.30		0.42	0.09	0.12	0.05	0.11	0.43	0.16	0.40	0.03	0.20	0.34	0.24	
22時	0.30		0.42	0.09	0.13	0.06	0.12	0.43	0.17	0.40	0.04	0.21	0.35	0.25	
23時	0.20		0.42	0.09	0.12	0.09	0.16	0.43	0.17	0.40	0.06	0.21	0.36	0.26	
24時	0.20		0.42	0.10	0.13	0.10	0.18	0.43	0.17	0.41	0.07	0.22	0.37	0.27	
			A→B	A→C	A→D	B→A	B→C	B→D	C→A	C→B	C→D	D→A	D→B	D→C	計
休日	7時		0.22	0.42	0.05	0.21	0.10	0.17	0.43	0.11	0.35	0.08	0.14	0.38	0.26
	8時		0.20	0.42	0.05	0.18	0.09	0.17	0.43	0.12	0.35	0.07	0.13	0.37	0.25
	9時		0.22	0.42	0.07	0.19	0.10	0.18	0.43	0.14	0.37	0.08	0.19	0.38	0.27
	10時		0.24	0.42	0.08	0.18	0.10	0.18	0.43	0.15	0.38	0.08	0.22	0.37	0.28
	11時		0.25	0.42	0.08	0.18	0.09	0.17	0.43	0.16	0.39	0.07	0.23	0.37	0.28
	12時	0.23	0.42	0.09	0.16	0.10	0.18	0.43	0.16	0.40	0.07	0.22	0.37	0.28	
	13時	0.23	0.42	0.09	0.16	0.10	0.18	0.43	0.16	0.40	0.07	0.22	0.37	0.28	
	14時	0.23	0.42	0.09	0.15	0.09	0.17	0.43	0.16	0.40	0.07	0.22	0.37	0.27	
	15時	0.23	0.42	0.09	0.14	0.09	0.16	0.43	0.16	0.40	0.06	0.23	0.36	0.27	
	16時	0.23	0.42	0.09	0.13	0.08	0.15	0.43	0.16	0.40	0.06	0.23	0.36	0.26	
	17時	0.23	0.42	0.09	0.13	0.08	0.15	0.43	0.16	0.40	0.05	0.23	0.36	0.26	
	18時	0.26	0.42	0.09	0.14	0.08	0.14	0.43	0.16	0.40	0.05	0.21	0.36	0.26	
	19時	0.28	0.42	0.09	0.15	0.07	0.14	0.43	0.16	0.40	0.05	0.22	0.36	0.26	
	20時	0.29	0.42	0.09	0.11	0.05	0.11	0.43	0.17	0.40	0.03	0.22	0.34	0.24	
	21時	0.29	0.42	0.09	0.10	0.04	0.09	0.43	0.16	0.40	0.03	0.19	0.34	0.22	
	22時	0.29	0.42	0.09	0.10	0.05	0.09	0.43	0.16	0.40	0.03	0.20	0.34	0.22	
	23時	0.19	0.42	0.09	0.10	0.08	0.15	0.43	0.16	0.40	0.05	0.20	0.36	0.25	
	24時	0.20	0.42	0.09	0.12	0.09	0.16	0.43	0.17	0.40	0.06	0.21	0.37	0.26	

表 20【方向別交通量】上川井インター交差点（地域社会3）

		A→B	A→C	A→D	B→A	B→C	B→D	C→A	C→B	C→D	D→A	D→B	D→C	計	
平日	7時	0	518	161	0	402	97	164	295	63	122	88	130	2,040	
	8時	0	767	182	0	474	109	204	334	74	138	99	158	2,537	
	9時	0	607	193	0	425	115	207	356	80	146	105	120	2,353	
	10時	0	448	191	0	389	114	211	356	81	145	104	100	2,138	
	11時	0	331	197	0	381	118	225	371	88	149	107	93	2,061	
	12時	0	250	196	0	363	117	202	361	82	148	106	84	1,910	
	13時	0	247	193	0	358	116	200	356	80	147	105	83	1,884	
	14時	0	204	190	0	346	114	223	359	88	144	103	78	1,848	
	15時	0	189	200	0	361	120	252	385	99	151	108	80	1,946	
	16時	0	188	213	0	382	127	278	411	106	161	115	84	2,065	
	17時	0	217	227	0	407	136	313	445	120	172	123	90	2,249	
	18時	0	181	208	0	367	124	309	414	115	157	113	79	2,066	
	19時	0	150	164	0	292	98	259	331	94	124	89	63	1,665	
	20時	0	148	149	0	267	89	323	313	94	113	81	58	1,635	
	21時	0	150	116	0	209	70	353	261	85	88	63	46	1,441	
	22時	0	131	102	0	184	61	332	231	75	78	56	40	1,289	
	23時	0	68	62	0	110	37	93	119	30	47	33	24	621	
	24時	0	44	50	0	88	30	62	92	21	38	27	19	471	
			A→B	A→C	A→D	B→A	B→C	B→D	C→A	C→B	C→D	D→A	D→B	D→C	計
	休日	7時	0	729	124	0	355	74	157	229	51	94	67	123	2,002
		8時	0	1,104	165	0	477	99	224	307	70	125	90	165	2,826
		9時	0	868	179	0	424	107	220	330	74	135	97	127	2,560
		10時	0	635	193	0	405	115	234	356	80	146	105	108	2,376
		11時	0	454	181	0	361	108	240	342	81	137	98	91	2,095
12時		0	337	181	0	344	108	217	336	77	137	98	82	1,917	
13時		0	332	175	0	333	105	213	325	74	133	95	80	1,865	
14時		0	272	186	0	344	112	253	355	87	141	101	79	1,931	
15時		0	247	189	0	345	113	284	370	96	143	103	78	1,966	
16時		0	241	191	0	348	115	313	379	101	145	104	78	2,014	
17時		0	281	202	0	369	121	353	408	113	153	110	84	2,193	
18時		0	229	171	0	311	103	351	361	107	130	93	69	1,925	
19時		0	193	144	0	262	86	303	305	90	109	78	59	1,630	
20時		0	193	130	0	239	78	409	297	98	99	71	54	1,666	
21時		0	211	126	0	233	76	489	301	103	96	69	53	1,757	
22時		0	183	109	0	201	65	463	266	93	83	59	46	1,569	
23時		0	97	77	0	139	46	127	149	37	59	42	30	803	
24時		0	60	56	0	99	33	80	104	24	42	30	21	549	

表 21【大型車混入率】上川井インター交差点（地域社会3）

		A→B	A→C	A→D	B→A	B→C	B→D	C→A	C→B	C→D	D→A	D→B	D→C	計	
平日	7時	-	0.03	0.16	-	0.26	0.08	0.17	0.38	0.19	0.13	0.08	0.10	0.17	
	8時	-	0.02	0.16	-	0.24	0.08	0.15	0.37	0.17	0.13	0.08	0.09	0.15	
	9時	-	0.03	0.16	-	0.29	0.08	0.16	0.38	0.18	0.13	0.08	0.14	0.17	
	10時	-	0.04	0.16	-	0.32	0.08	0.16	0.37	0.18	0.13	0.08	0.16	0.19	
	11時	-	0.06	0.16	-	0.33	0.08	0.15	0.37	0.17	0.13	0.08	0.18	0.20	
	12時	-	0.07	0.16	-	0.34	0.08	0.15	0.37	0.16	0.13	0.08	0.18	0.21	
	13時	-	0.07	0.16	-	0.34	0.08	0.15	0.37	0.16	0.13	0.08	0.18	0.21	
	14時	-	0.08	0.16	-	0.34	0.08	0.13	0.36	0.14	0.13	0.08	0.19	0.21	
	15時	-	0.09	0.16	-	0.35	0.08	0.12	0.35	0.13	0.13	0.08	0.19	0.21	
	16時	-	0.10	0.16	-	0.35	0.08	0.12	0.35	0.13	0.13	0.08	0.19	0.21	
	17時	-	0.09	0.16	-	0.35	0.08	0.11	0.34	0.12	0.13	0.08	0.19	0.20	
	18時	-	0.09	0.16	-	0.35	0.08	0.10	0.34	0.10	0.13	0.08	0.19	0.20	
	19時	-	0.09	0.16	-	0.35	0.08	0.09	0.33	0.10	0.13	0.08	0.19	0.20	
	20時	-	0.08	0.16	-	0.34	0.08	0.07	0.32	0.10	0.13	0.08	0.19	0.18	
	21時	-	0.06	0.16	-	0.34	0.08	0.04	0.29	0.07	0.13	0.08	0.17	0.16	
	22時	-	0.06	0.16	-	0.34	0.08	0.04	0.29	0.07	0.13	0.08	0.17	0.15	
	23時	-	0.07	0.16	-	0.34	0.08	0.09	0.34	0.11	0.13	0.08	0.18	0.19	
	24時	-	0.09	0.16	-	0.35	0.08	0.11	0.36	0.13	0.13	0.08	0.18	0.21	
			A→B	A→C	A→D	B→A	B→C	B→D	C→A	C→B	C→D	D→A	D→B	D→C	計
	休日	7時	-	0.01	0.16	-	0.22	0.08	0.12	0.37	0.16	0.13	0.08	0.08	0.13
		8時	-	0.01	0.16	-	0.21	0.08	0.11	0.36	0.14	0.13	0.08	0.07	0.12
		9時	-	0.02	0.16	-	0.26	0.08	0.12	0.37	0.15	0.13	0.08	0.11	0.14
		10時	-	0.03	0.16	-	0.29	0.08	0.12	0.37	0.15	0.13	0.08	0.13	0.16
		11時	-	0.03	0.16	-	0.31	0.08	0.11	0.36	0.14	0.13	0.08	0.15	0.17
12時		-	0.04	0.16	-	0.32	0.08	0.12	0.36	0.14	0.13	0.08	0.16	0.19	
13時		-	0.04	0.16	-	0.32	0.08	0.12	0.36	0.14	0.13	0.08	0.16	0.19	
14時		-	0.06	0.16	-	0.33	0.08	0.10	0.35	0.12	0.13	0.08	0.17	0.19	
15時		-	0.06	0.16	-	0.34	0.08	0.09	0.34	0.11	0.13	0.08	0.17	0.19	
16時		-	0.06	0.16	-	0.34	0.08	0.09	0.34	0.11	0.13	0.08	0.17	0.19	
17時		-	0.06	0.16	-	0.33	0.08	0.08	0.33	0.10	0.13	0.08	0.17	0.18	
18時		-	0.06	0.16	-	0.34	0.08	0.07	0.31	0.09	0.13	0.08	0.17	0.17	
19時		-	0.06	0.16	-	0.34	0.08	0.07	0.31	0.09	0.13	0.08	0.17	0.17	
20時		-	0.05	0.16	-	0.33	0.08	0.04	0.29	0.07	0.13	0.08	0.17	0.15	
21時		-	0.05	0.16	-	0.33	0.08	0.03	0.28	0.06	0.13	0.08	0.16	0.14	
22時		-	0.05	0.16	-	0.33	0.08	0.03	0.27	0.06	0.13	0.08	0.16	0.13	
23時		-	0.06	0.16	-	0.34	0.08	0.08	0.34	0.11	0.13	0.08	0.17	0.19	
24時		-	0.07	0.16	-	0.34	0.08	0.09	0.35	0.12	0.13	0.08	0.17	0.20	

表 22【方向別交通量】滝沢交差点（地域社会 4）

		A→B	A→C	A→D	B→A	B→C	B→D	C→A	C→B	C→D	D→A	D→B	D→C	計	
平日	7時	759	0	267	673	0	0	0	0	0	283	137	0	2,119	
	8時	742	0	285	649	0	0	0	0	0	265	154	0	2,095	
	9時	587	0	216	541	0	0	0	0	0	215	124	0	1,683	
	10時	537	0	176	509	0	0	0	0	0	198	108	0	1,528	
	11時	497	0	159	487	0	0	0	0	0	189	94	0	1,426	
	12時	460	0	145	451	0	0	0	0	0	180	75	0	1,311	
	13時	508	0	157	497	0	0	0	0	0	200	81	0	1,443	
	14時	481	0	143	484	0	0	0	0	0	189	75	0	1,371	
	15時	528	0	165	544	0	0	0	0	0	215	77	0	1,529	
	16時	561	0	177	583	0	0	0	0	0	231	80	0	1,632	
	17時	624	0	207	657	0	0	0	0	0	263	86	0	1,837	
	18時	679	0	226	721	0	0	0	0	0	289	91	0	2,007	
	19時	523	0	180	563	0	0	0	0	0	224	72	0	1,562	
	20時	316	0	110	386	0	0	0	0	0	131	52	0	996	
	21時	221	0	80	312	0	0	0	0	0	89	41	0	742	
	22時	154	0	57	242	0	0	0	0	0	60	33	0	547	
	23時	85	0	28	99	0	0	0	0	0	33	13	0	258	
	24時	80	0	19	84	0	0	0	0	0	29	13	0	224	
			A→B	A→C	A→D	B→A	B→C	B→D	C→A	C→B	C→D	D→A	D→B	D→C	計
	休日	7時	311	0	183	267	0	0	0	0	0	102	87	0	949
		8時	428	0	269	377	0	0	0	0	0	147	120	0	1,340
		9時	405	0	226	384	0	0	0	0	0	152	107	0	1,275
		10時	431	0	203	428	0	0	0	0	0	170	96	0	1,327
		11時	428	0	185	443	0	0	0	0	0	176	83	0	1,315
12時		448	0	179	460	0	0	0	0	0	189	71	0	1,347	
13時		428	0	173	441	0	0	0	0	0	181	68	0	1,291	
14時		436	0	169	468	0	0	0	0	0	187	65	0	1,325	
15時		433	0	165	480	0	0	0	0	0	186	63	0	1,327	
16時		468	0	176	525	0	0	0	0	0	202	66	0	1,437	
17時		455	0	176	528	0	0	0	0	0	196	67	0	1,423	
18時		416	0	157	502	0	0	0	0	0	177	64	0	1,317	
19時		319	0	120	393	0	0	0	0	0	134	53	0	1,020	
20時		227	0	91	341	0	0	0	0	0	93	44	0	796	
21時		199	0	81	339	0	0	0	0	0	79	42	0	741	
22時		168	0	68	301	0	0	0	0	0	66	38	0	640	
23時		105	0	39	128	0	0	0	0	0	42	16	0	330	
24時		81	0	28	92	0	0	0	0	0	33	12	0	247	

表 23【大型車混入率】滝沢交差点（地域社会 4）

		A→B	A→C	A→D	B→A	B→C	B→D	C→A	C→B	C→D	D→A	D→B	D→C	計	
平日	7時	0.24	-	0.05	0.24	-	-	-	-	-	0.18	0.30	-	0.21	
	8時	0.27	-	0.05	0.27	-	-	-	-	-	0.21	0.28	-	0.23	
	9時	0.33	-	0.07	0.32	-	-	-	-	-	0.25	0.35	-	0.28	
	10時	0.39	-	0.09	0.36	-	-	-	-	-	0.30	0.43	-	0.34	
	11時	0.34	-	0.08	0.31	-	-	-	-	-	0.24	0.42	-	0.29	
	12時	0.31	-	0.07	0.28	-	-	-	-	-	0.22	0.39	-	0.26	
	13時	0.31	-	0.08	0.28	-	-	-	-	-	0.22	0.39	-	0.27	
	14時	0.33	-	0.08	0.29	-	-	-	-	-	0.24	0.42	-	0.28	
	15時	0.25	-	0.06	0.21	-	-	-	-	-	0.17	0.36	-	0.21	
	16時	0.22	-	0.05	0.19	-	-	-	-	-	0.15	0.34	-	0.19	
	17時	0.17	-	0.04	0.14	-	-	-	-	-	0.11	0.28	-	0.14	
	18時	0.14	-	0.03	0.12	-	-	-	-	-	0.09	0.29	-	0.12	
	19時	0.11	-	0.02	0.09	-	-	-	-	-	0.06	0.28	-	0.09	
	20時	0.14	-	0.02	0.11	-	-	-	-	-	0.07	0.35	-	0.12	
	21時	0.19	-	0.03	0.12	-	-	-	-	-	0.10	0.40	-	0.14	
	22時	0.20	-	0.03	0.12	-	-	-	-	-	0.09	0.45	-	0.15	
	23時	0.35	-	0.08	0.26	-	-	-	-	-	0.27	0.36	-	0.28	
	24時	0.57	-	0.19	0.48	-	-	-	-	-	0.48	0.57	-	0.49	
			A→B	A→C	A→D	B→A	B→C	B→D	C→A	C→B	C→D	D→A	D→B	D→C	計
	休日	7時	0.18	-	0.02	0.19	-	-	-	-	-	0.13	0.23	-	0.15
		8時	0.13	-	0.01	0.14	-	-	-	-	-	0.09	0.17	-	0.11
		9時	0.14	-	0.02	0.13	-	-	-	-	-	0.09	0.19	-	0.11
		10時	0.16	-	0.02	0.14	-	-	-	-	-	0.10	0.23	-	0.13
		11時	0.11	-	0.01	0.09	-	-	-	-	-	0.06	0.23	-	0.09
12時		0.10	-	0.02	0.09	-	-	-	-	-	0.06	0.19	-	0.09	
13時		0.10	-	0.02	0.08	-	-	-	-	-	0.06	0.18	-	0.08	
14時		0.09	-	0.02	0.08	-	-	-	-	-	0.05	0.19	-	0.07	
15時		0.08	-	0.01	0.07	-	-	-	-	-	0.05	0.18	-	0.07	
16時		0.08	-	0.01	0.07	-	-	-	-	-	0.05	0.18	-	0.07	
17時		0.08	-	0.01	0.06	-	-	-	-	-	0.05	0.18	-	0.07	
18時		0.09	-	0.01	0.07	-	-	-	-	-	0.04	0.25	-	0.07	
19時		0.11	-	0.01	0.08	-	-	-	-	-	0.05	0.30	-	0.09	
20時		0.11	-	0.01	0.07	-	-	-	-	-	0.04	0.33	-	0.09	
21時		0.17	-	0.02	0.09	-	-	-	-	-	0.09	0.37	-	0.12	
22時		0.19	-	0.02	0.10	-	-	-	-	-	0.09	0.40	-	0.13	
23時		0.26	-	0.06	0.19	-	-	-	-	-	0.19	0.26	-	0.20	
24時		0.28	-	0.07	0.22	-	-	-	-	-	0.21	0.30	-	0.22	

表 24【方向別交通量】瀬谷土橋公園入口交差点（地域社会 4'）

		A→B	A→C	A→D	B→A	B→C	B→D	C→A	C→B	C→D	D→A	D→B	D→C	計	
平日	7時	816	0	0	902	0	361	0	0	0	61	0	0	2,140	
	8時	837	0	0	863	0	353	0	0	0	55	0	0	2,107	
	9時	669	0	0	708	0	286	0	0	0	43	0	0	1,707	
	10時	614	0	0	666	0	270	0	0	0	39	0	0	1,588	
	11時	565	0	0	650	0	273	0	0	0	39	0	0	1,528	
	12時	487	0	0	588	0	243	0	0	0	37	0	0	1,355	
	13時	530	0	0	638	0	260	0	0	0	40	0	0	1,468	
	14時	524	0	0	640	0	269	0	0	0	39	0	0	1,472	
	15時	573	0	0	737	0	318	0	0	0	46	0	0	1,673	
	16時	606	0	0	800	0	353	0	0	0	51	0	0	1,809	
	17時	653	0	0	917	0	418	0	0	0	61	0	0	2,050	
	18時	708	0	0	1,013	0	469	0	0	0	68	0	0	2,259	
	19時	560	0	0	810	0	386	0	0	0	55	0	0	1,811	
	20時	359	0	0	544	0	328	0	0	0	33	0	0	1,264	
	21時	245	0	0	406	0	311	0	0	0	21	0	0	983	
	22時	181	0	0	309	0	269	0	0	0	14	0	0	773	
	23時	86	0	0	122	0	72	0	0	0	7	0	0	287	
	24時	67	0	0	83	0	44	0	0	0	4	0	0	199	
			A→B	A→C	A→D	B→A	B→C	B→D	C→A	C→B	C→D	D→A	D→B	D→C	計
	休日	7時	372	0	0	359	0	183	0	0	0	23	0	0	937
		8時	504	0	0	505	0	261	0	0	0	33	0	0	1,303
		9時	483	0	0	538	0	264	0	0	0	36	0	0	1,320
		10時	446	0	0	546	0	272	0	0	0	37	0	0	1,300
		11時	439	0	0	577	0	289	0	0	0	39	0	0	1,343
12時		451	0	0	616	0	288	0	0	0	42	0	0	1,398	
13時		446	0	0	615	0	290	0	0	0	43	0	0	1,393	
14時		431	0	0	624	0	309	0	0	0	42	0	0	1,406	
15時		454	0	0	673	0	341	0	0	0	45	0	0	1,513	
16時		467	0	0	704	0	367	0	0	0	47	0	0	1,585	
17時		464	0	0	710	0	385	0	0	0	46	0	0	1,604	
18時		406	0	0	640	0	374	0	0	0	40	0	0	1,461	
19時		323	0	0	504	0	307	0	0	0	30	0	0	1,164	
20時		240	0	0	423	0	343	0	0	0	21	0	0	1,027	
21時		217	0	0	409	0	387	0	0	0	18	0	0	1,030	
22時		191	0	0	365	0	363	0	0	0	15	0	0	933	
23時		100	0	0	155	0	100	0	0	0	9	0	0	363	
24時		80	0	0	114	0	66	0	0	0	7	0	0	266	

表 25【大型車混入率】瀬谷土橋公園入口交差点（地域社会 4'）

		A→B	A→C	A→D	B→A	B→C	B→D	C→A	C→B	C→D	D→A	D→B	D→C	計	
平日	7時	0.24	-	-	0.16	-	0.10	-	-	-	0.05	-	-	0.18	
	8時	0.29	-	-	0.21	-	0.12	-	-	-	0.07	-	-	0.22	
	9時	0.36	-	-	0.25	-	0.15	-	-	-	0.10	-	-	0.27	
	10時	0.41	-	-	0.28	-	0.17	-	-	-	0.11	-	-	0.31	
	11時	0.37	-	-	0.24	-	0.14	-	-	-	0.09	-	-	0.27	
	12時	0.33	-	-	0.21	-	0.11	-	-	-	0.08	-	-	0.23	
	13時	0.34	-	-	0.21	-	0.12	-	-	-	0.08	-	-	0.24	
	14時	0.37	-	-	0.23	-	0.12	-	-	-	0.09	-	-	0.26	
	15時	0.31	-	-	0.18	-	0.09	-	-	-	0.07	-	-	0.21	
	16時	0.28	-	-	0.16	-	0.08	-	-	-	0.06	-	-	0.18	
	17時	0.17	-	-	0.09	-	0.05	-	-	-	0.03	-	-	0.11	
	18時	0.16	-	-	0.08	-	0.05	-	-	-	0.02	-	-	0.10	
	19時	0.14	-	-	0.06	-	0.05	-	-	-	0.02	-	-	0.08	
	20時	0.18	-	-	0.08	-	0.05	-	-	-	0.02	-	-	0.10	
	21時	0.20	-	-	0.08	-	0.05	-	-	-	0.02	-	-	0.10	
	22時	0.27	-	-	0.10	-	0.06	-	-	-	0.03	-	-	0.12	
	23時	0.30	-	-	0.16	-	0.05	-	-	-	0.07	-	-	0.17	
	24時	0.46	-	-	0.29	-	0.10	-	-	-	0.14	-	-	0.30	
			A→B	A→C	A→D	B→A	B→C	B→D	C→A	C→B	C→D	D→A	D→B	D→C	計
	休日	7時	0.18	-	-	0.12	-	0.10	-	-	-	0.03	-	-	0.14
		8時	0.14	-	-	0.09	-	0.07	-	-	-	0.03	-	-	0.10
		9時	0.16	-	-	0.10	-	0.07	-	-	-	0.03	-	-	0.11
		10時	0.14	-	-	0.07	-	0.06	-	-	-	0.02	-	-	0.09
		11時	0.13	-	-	0.06	-	0.06	-	-	-	0.01	-	-	0.08
12時		0.12	-	-	0.06	-	0.04	-	-	-	0.02	-	-	0.07	
13時		0.10	-	-	0.05	-	0.04	-	-	-	0.01	-	-	0.06	
14時		0.09	-	-	0.04	-	0.03	-	-	-	0.01	-	-	0.05	
15時		0.09	-	-	0.04	-	0.03	-	-	-	0.01	-	-	0.05	
16時		0.09	-	-	0.04	-	0.03	-	-	-	0.01	-	-	0.05	
17時		0.09	-	-	0.04	-	0.03	-	-	-	0.01	-	-	0.05	
18時		0.11	-	-	0.04	-	0.04	-	-	-	0.01	-	-	0.06	
19時		0.14	-	-	0.06	-	0.05	-	-	-	0.01	-	-	0.08	
20時		0.16	-	-	0.05	-	0.04	-	-	-	0.01	-	-	0.07	
21時		0.21	-	-	0.07	-	0.04	-	-	-	0.02	-	-	0.09	
22時		0.25	-	-	0.08	-	0.04	-	-	-	0.03	-	-	0.10	
23時		0.17	-	-	0.09	-	0.03	-	-	-	0.04	-	-	0.09	
24時		0.25	-	-	0.14	-	0.05	-	-	-	0.06	-	-	0.15	

表 26【方向別交通量】中瀬谷消防署出張所北側交差点（地域社会 5）

		A→B	A→C	A→D	B→A	B→C	B→D	C→A	C→B	C→D	D→A	D→B	D→C	計	
平日	7時	318	26	205	469	0	40	11	0	23	305	34	22	1,453	
	8時	299	24	200	466	0	39	10	0	21	303	31	20	1,416	
	9時	255	21	166	310	0	34	8	0	18	222	26	17	1,077	
	10時	274	23	173	293	0	35	8	0	19	215	28	18	1,086	
	11時	262	22	162	261	0	33	8	0	18	195	26	16	1,002	
	12時	232	20	143	227	0	30	7	0	16	160	23	15	872	
	13時	269	23	164	266	0	33	8	0	18	185	27	17	1,011	
	14時	277	24	166	256	0	32	8	0	18	179	26	17	1,002	
	15時	313	28	185	279	0	34	8	0	19	195	29	18	1,108	
	16時	325	29	192	287	0	33	9	0	19	200	30	19	1,143	
	17時	374	33	218	321	0	35	10	0	21	223	33	21	1,290	
	18時	363	32	211	302	0	32	9	0	20	222	32	20	1,243	
	19時	289	24	170	241	0	25	7	0	15	183	25	16	996	
	20時	267	22	166	217	0	22	6	0	14	167	23	15	918	
	21時	194	14	132	141	0	14	4	0	9	119	15	10	651	
	22時	167	11	118	123	0	12	4	0	8	107	13	8	571	
	23時	76	6	47	65	0	7	2	0	4	43	7	4	262	
	24時	44	3	28	41	0	4	1	0	3	27	4	3	158	
			A→B	A→C	A→D	B→A	B→C	B→D	C→A	C→B	C→D	D→A	D→B	D→C	計
	休日	7時	187	14	139	266	0	29	6	0	14	199	19	12	888
		8時	243	20	184	333	0	40	8	0	19	246	24	16	1,133
		9時	239	20	177	273	0	52	8	0	21	207	24	15	1,038
		10時	267	23	183	279	0	46	8	0	21	209	27	17	1,079
		11時	295	26	198	291	0	47	9	0	22	216	29	19	1,151
12時		299	27	194	292	0	44	9	0	22	203	29	19	1,137	
13時		273	25	178	266	0	40	8	0	20	186	27	17	1,041	
14時		315	29	204	293	0	43	9	0	22	203	30	19	1,167	
15時		327	29	213	294	0	43	9	0	22	204	30	19	1,192	
16時		329	32	214	286	0	41	9	0	21	199	29	19	1,180	
17時		336	30	222	285	0	39	9	0	20	199	29	19	1,188	
18時		306	26	205	247	0	33	7	0	17	187	26	16	1,070	
19時		244	20	165	197	0	25	6	0	14	154	20	13	858	
20時		238	18	168	180	0	18	5	0	11	144	19	12	812	
21時		225	14	169	163	0	17	5	0	10	134	17	11	765	
22時		196	12	151	139	0	14	4	0	9	118	15	9	668	
23時		101	7	67	91	0	9	3	0	6	60	9	6	360	
24時		61	5	41	57	0	6	2	0	4	37	6	4	222	

表 27【大型車混入率】中瀬谷消防署出張所北側交差点（地域社会 5）

		A→B	A→C	A→D	B→A	B→C	B→D	C→A	C→B	C→D	D→A	D→B	D→C	計	
平日	7時	0.21	0.22	0.14	0.13	-	0.04	0.26	-	0.17	0.18	0.06	0.16	0.16	
	8時	0.20	0.21	0.13	0.12	-	0.04	0.25	-	0.17	0.17	0.06	0.16	0.15	
	9時	0.20	0.21	0.13	0.16	-	0.04	0.27	-	0.17	0.22	0.06	0.16	0.17	
	10時	0.20	0.20	0.13	0.17	-	0.04	0.28	-	0.17	0.23	0.06	0.16	0.18	
	11時	0.19	0.19	0.13	0.18	-	0.04	0.28	-	0.17	0.25	0.06	0.16	0.18	
	12時	0.19	0.18	0.13	0.18	-	0.04	0.29	-	0.16	0.20	0.06	0.16	0.17	
	13時	0.19	0.18	0.13	0.18	-	0.04	0.29	-	0.17	0.20	0.06	0.16	0.17	
	14時	0.18	0.17	0.13	0.18	-	0.04	0.29	-	0.17	0.20	0.06	0.16	0.17	
	15時	0.18	0.16	0.13	0.18	-	0.04	0.29	-	0.17	0.19	0.06	0.16	0.17	
	16時	0.18	0.16	0.13	0.18	-	0.05	0.29	-	0.18	0.19	0.06	0.16	0.17	
	17時	0.17	0.16	0.12	0.18	-	0.05	0.29	-	0.18	0.19	0.06	0.16	0.16	
	18時	0.17	0.16	0.12	0.18	-	0.05	0.29	-	0.18	0.23	0.06	0.16	0.17	
	19時	0.17	0.16	0.12	0.18	-	0.05	0.29	-	0.19	0.25	0.06	0.16	0.17	
	20時	0.16	0.16	0.11	0.18	-	0.05	0.29	-	0.19	0.26	0.06	0.16	0.17	
	21時	0.14	0.16	0.09	0.18	-	0.05	0.29	-	0.19	0.31	0.06	0.16	0.17	
	22時	0.15	0.17	0.09	0.18	-	0.05	0.29	-	0.19	0.33	0.06	0.16	0.17	
	23時	0.17	0.18	0.12	0.18	-	0.05	0.29	-	0.19	0.14	0.06	0.16	0.15	
	24時	0.18	0.19	0.12	0.18	-	0.05	0.29	-	0.19	0.14	0.06	0.16	0.16	
			A→B	A→C	A→D	B→A	B→C	B→D	C→A	C→B	C→D	D→A	D→B	D→C	計
	休日	7時	0.20	0.21	0.11	0.13	-	0.03	0.26	-	0.16	0.21	0.06	0.16	0.16
		8時	0.20	0.19	0.11	0.13	-	0.03	0.25	-	0.15	0.19	0.06	0.16	0.15
		9時	0.20	0.19	0.11	0.16	-	0.02	0.27	-	0.13	0.22	0.06	0.16	0.16
		10時	0.20	0.19	0.12	0.17	-	0.03	0.28	-	0.15	0.23	0.06	0.16	0.17
		11時	0.19	0.18	0.12	0.18	-	0.03	0.28	-	0.15	0.23	0.06	0.16	0.17
12時		0.19	0.17	0.13	0.18	-	0.03	0.29	-	0.16	0.19	0.06	0.16	0.17	
13時		0.19	0.17	0.12	0.18	-	0.03	0.29	-	0.16	0.19	0.06	0.16	0.17	
14時		0.18	0.16	0.12	0.18	-	0.04	0.29	-	0.16	0.19	0.06	0.16	0.16	
15時		0.18	0.16	0.12	0.18	-	0.04	0.29	-	0.16	0.19	0.06	0.16	0.16	
16時		0.17	0.15	0.11	0.18	-	0.04	0.29	-	0.16	0.19	0.06	0.16	0.16	
17時		0.17	0.15	0.11	0.18	-	0.04	0.29	-	0.16	0.19	0.06	0.16	0.16	
18時		0.16	0.15	0.10	0.18	-	0.04	0.29	-	0.17	0.25	0.06	0.16	0.16	
19時		0.16	0.16	0.10	0.18	-	0.04	0.29	-	0.17	0.27	0.06	0.16	0.17	
20時		0.15	0.16	0.09	0.18	-	0.05	0.29	-	0.19	0.28	0.06	0.16	0.16	
21時		0.14	0.18	0.08	0.18	-	0.05	0.29	-	0.19	0.29	0.06	0.16	0.16	
22時		0.14	0.18	0.08	0.18	-	0.05	0.29	-	0.19	0.31	0.06	0.16	0.16	
23時		0.18	0.19	0.11	0.18	-	0.05	0.29	-	0.19	0.13	0.06	0.16	0.15	
24時		0.19	0.20	0.12	0.18	-	0.05	0.29	-	0.19	0.14	0.06	0.16	0.16	

表 28【方向別交通量】瀬谷中学校前交差点（地域社会 6）

		方向別交通量												計	
		A→B	A→C	A→D	B→A	B→C	B→D	C→A	C→B	C→D	D→A	D→B	D→C		
平日	7時	313	18	14	625	424	255	37	270	319	33	193	339	2,840	
	8時	291	17	15	603	389	234	38	248	293	35	177	310	2,649	
	9時	247	15	13	440	325	196	23	207	245	24	148	260	2,144	
	10時	266	17	14	439	347	209	20	221	261	21	158	277	2,251	
	11時	251	17	14	395	316	191	19	201	238	19	144	253	2,058	
	12時	222	16	12	347	279	168	17	178	210	16	127	223	1,813	
	13時	258	19	14	408	331	200	19	211	249	18	151	265	2,142	
	14時	262	20	16	394	322	194	18	205	242	17	146	257	2,091	
	15時	294	23	18	430	353	212	19	225	266	18	160	282	2,301	
	16時	304	25	20	442	364	219	19	232	274	18	166	291	2,374	
	17時	349	28	24	495	409	247	20	261	308	21	186	327	2,674	
	18時	337	27	24	467	388	234	18	247	292	19	176	310	2,539	
	19時	269	20	20	372	309	186	14	197	233	15	140	247	2,022	
	20時	244	18	24	334	277	167	12	176	209	14	126	221	1,821	
	21時	170	11	25	217	179	108	8	114	135	9	82	143	1,201	
	22時	146	9	23	189	157	94	7	100	118	8	71	125	1,046	
	23時	71	5	6	100	83	50	4	53	63	4	38	66	543	
	24時	42	2	3	62	52	31	2	33	39	3	23	41	334	
			A→B	A→C	A→D	B→A	B→C	B→D	C→A	C→B	C→D	D→A	D→B	D→C	計
	休日	7時	181	10	11	358	240	145	21	153	181	21	109	192	1,624
		8時	231	15	15	452	304	183	27	193	229	28	138	242	2,057
		9時	228	16	15	406	298	180	28	190	225	22	136	238	1,981
		10時	254	18	16	424	332	200	24	212	250	21	151	265	2,167
		11時	279	21	18	450	359	217	25	229	271	21	163	287	2,340
12時		282	23	17	454	367	221	24	234	276	20	167	293	2,377	
13時		257	21	16	413	333	201	22	212	251	18	152	266	2,163	
14時		293	25	21	457	372	224	23	237	280	19	169	297	2,419	
15時		302	25	24	459	375	226	24	239	282	19	170	299	2,445	
16時		298	29	25	447	365	220	23	233	275	18	166	291	2,390	
17時		304	26	29	442	362	218	21	231	272	19	165	289	2,378	
18時		274	23	30	384	315	190	18	201	237	16	143	252	2,082	
19時		219	16	25	305	251	151	14	160	189	13	114	200	1,656	
20時		207	14	31	276	228	137	10	145	172	12	104	182	1,519	
21時		193	10	35	250	206	124	9	131	155	11	94	165	1,383	
22時		167	9	33	214	177	106	8	112	133	9	80	141	1,189	
23時		94	5	9	140	117	70	5	74	88	6	53	93	755	
24時		58	3	5	88	73	44	3	47	55	4	33	59	473	

表 29【大型車混入率】瀬谷中学校前交差点（地域社会 6）

		大型車混入率												計	
		A→B	A→C	A→D	B→A	B→C	B→D	C→A	C→B	C→D	D→A	D→B	D→C		
平日	7時	0.21	0.14	0.19	0.09	0.09	0.27	0.07	0.17	0.16	0.06	0.32	0.19	0.16	
	8時	0.20	0.14	0.16	0.09	0.09	0.27	0.06	0.17	0.16	0.06	0.32	0.19	0.16	
	9時	0.20	0.13	0.16	0.10	0.09	0.27	0.09	0.17	0.16	0.08	0.32	0.19	0.17	
	10時	0.20	0.13	0.15	0.11	0.09	0.27	0.11	0.17	0.16	0.09	0.32	0.19	0.17	
	11時	0.19	0.11	0.14	0.11	0.09	0.27	0.11	0.17	0.16	0.10	0.32	0.19	0.17	
	12時	0.19	0.10	0.14	0.11	0.09	0.27	0.10	0.17	0.16	0.09	0.32	0.19	0.17	
	13時	0.20	0.11	0.15	0.11	0.09	0.27	0.11	0.17	0.16	0.09	0.32	0.19	0.17	
	14時	0.19	0.10	0.13	0.11	0.09	0.27	0.11	0.17	0.16	0.10	0.32	0.19	0.17	
	15時	0.18	0.09	0.12	0.11	0.09	0.27	0.12	0.17	0.16	0.10	0.32	0.19	0.17	
	16時	0.18	0.09	0.11	0.11	0.09	0.27	0.12	0.17	0.16	0.10	0.32	0.19	0.17	
	17時	0.18	0.09	0.11	0.11	0.09	0.27	0.13	0.17	0.16	0.10	0.32	0.19	0.17	
	18時	0.17	0.09	0.10	0.11	0.09	0.27	0.13	0.17	0.16	0.09	0.32	0.19	0.17	
	19時	0.17	0.09	0.09	0.11	0.09	0.27	0.14	0.17	0.16	0.09	0.32	0.19	0.17	
	20時	0.17	0.10	0.07	0.11	0.09	0.27	0.14	0.17	0.16	0.09	0.32	0.19	0.17	
	21時	0.16	0.10	0.04	0.11	0.09	0.27	0.14	0.17	0.16	0.08	0.32	0.19	0.16	
	22時	0.16	0.11	0.04	0.11	0.09	0.27	0.14	0.17	0.16	0.08	0.32	0.19	0.16	
	23時	0.18	0.11	0.08	0.11	0.09	0.27	0.14	0.17	0.16	0.08	0.32	0.19	0.17	
	24時	0.19	0.13	0.09	0.11	0.09	0.27	0.14	0.17	0.16	0.09	0.32	0.19	0.17	
			A→B	A→C	A→D	B→A	B→C	B→D	C→A	C→B	C→D	D→A	D→B	D→C	計
	休日	7時	0.20	0.14	0.13	0.09	0.09	0.27	0.07	0.17	0.16	0.05	0.32	0.19	0.16
		8時	0.20	0.12	0.12	0.09	0.09	0.27	0.07	0.17	0.16	0.05	0.32	0.19	0.16
		9時	0.20	0.11	0.13	0.10	0.09	0.27	0.07	0.17	0.16	0.06	0.32	0.19	0.16
		10時	0.20	0.11	0.13	0.11	0.09	0.27	0.09	0.17	0.16	0.07	0.32	0.19	0.17
		11時	0.20	0.11	0.12	0.11	0.09	0.27	0.09	0.17	0.16	0.08	0.32	0.19	0.17
12時		0.20	0.10	0.13	0.11	0.09	0.27	0.10	0.17	0.16	0.08	0.32	0.19	0.17	
13時		0.20	0.10	0.12	0.11	0.09	0.27	0.10	0.17	0.16	0.08	0.32	0.19	0.17	
14時		0.19	0.09	0.11	0.11	0.09	0.27	0.10	0.17	0.16	0.09	0.32	0.19	0.17	
15時		0.19	0.09	0.10	0.11	0.09	0.27	0.10	0.17	0.16	0.09	0.32	0.19	0.17	
16時		0.19	0.08	0.09	0.11	0.09	0.27	0.10	0.17	0.16	0.09	0.32	0.19	0.17	
17時		0.18	0.08	0.08	0.11	0.09	0.27	0.11	0.17	0.16	0.09	0.32	0.19	0.17	
18時		0.17	0.09	0.06	0.11	0.09	0.27	0.11	0.17	0.16	0.08	0.32	0.19	0.16	
19時		0.17	0.10	0.06	0.11	0.09	0.27	0.11	0.17	0.16	0.08	0.32	0.19	0.16	
20時		0.17	0.10	0.05	0.11	0.09	0.27	0.14	0.17	0.16	0.08	0.32	0.19	0.16	
21時		0.16	0.12	0.04	0.11	0.09	0.27	0.14	0.17	0.16	0.08	0.32	0.19	0.16	
22時		0.16	0.13	0.03	0.11	0.09	0.27	0.14	0.17	0.16	0.08	0.32	0.19	0.16	
23時		0.19	0.13	0.08	0.11	0.09	0.27	0.14	0.17	0.16	0.08	0.32	0.19	0.17	
24時		0.19	0.14	0.09	0.11	0.09	0.27	0.14	0.17	0.16	0.08	0.32	0.19	0.17	

表 30【方向別交通量】 地域社会 8

	時間	方向別交通量												計
		A→B	A→C	A→D	B→A	B→C	B→D	C→A	C→B	C→D	D→A	D→B	D→C	
平日	7時	9	25	0	77	0	0	24	1	0	0	0	0	136
	8時	11	25	0	106	0	0	32	6	0	0	0	181	
	9時	14	25	0	75	0	0	18	9	0	0	0	141	
	10時	16	25	0	55	0	0	11	10	0	0	0	118	
	11時	23	26	0	44	0	0	7	16	0	0	0	117	
	12時	19	14	0	36	0	0	5	21	0	0	0	96	
	13時	18	14	0	33	0	0	5	24	0	0	0	94	
	14時	27	15	0	29	0	0	4	27	0	0	0	102	
	15時	36	16	0	26	0	0	4	31	0	0	0	112	
	16時	36	16	0	22	0	0	3	42	0	0	0	120	
	17時	47	18	0	22	0	0	4	38	0	0	0	128	
	18時	49	30	0	16	0	0	3	27	0	0	0	125	
	19時	40	29	0	12	0	0	3	10	0	0	0	94	
	20時	34	29	0	11	0	0	3	18	0	0	0	94	
	21時	27	29	0	12	0	0	3	5	0	0	0	76	
22時	21	29	0	10	0	0	3	4	0	0	0	67		
23時	8	1	0	5	0	0	1	1	0	0	0	17		
24時	3	1	0	3	0	0	1	1	0	0	0	8		
休日	7時	6	25	0	111	0	0	36	1	0	0	0	179	
	8時	8	25	0	160	1	0	48	22	0	0	0	265	
	9時	9	25	0	141	1	0	27	30	0	0	0	232	
	10時	10	25	0	95	0	0	16	32	0	0	0	180	
	11時	13	26	0	77	0	0	11	44	0	0	0	171	
	12時	11	14	0	58	0	0	8	56	0	0	0	148	
	13時	10	14	0	56	0	0	8	52	0	0	0	140	
	14時	15	14	0	48	0	0	6	69	0	0	0	153	
	15時	20	15	0	46	0	0	5	65	0	0	0	151	
	16時	21	15	0	44	0	0	5	101	0	0	0	186	
	17時	26	16	0	43	0	0	6	73	0	0	0	163	
	18時	27	28	0	33	0	0	5	56	0	0	0	150	
	19時	23	29	0	26	0	0	4	27	0	0	0	108	
	20時	23	29	0	16	0	0	4	30	0	0	0	102	
	21時	23	29	0	18	0	0	5	7	0	0	0	82	
22時	19	29	0	15	0	0	4	7	0	0	0	74		
23時	6	1	0	8	0	0	2	1	0	0	0	18		
24時	3	1	0	4	0	0	1	1	0	0	0	10		

表 31【大型車混入率】 地域社会 8

	時間	大型車混入率												計
		A→B	A→C	A→D	B→A	B→C	B→D	C→A	C→B	C→D	D→A	D→B	D→C	
平日	7時	0.30	0.97	-	0.00	0.00	-	0.00	0.00	-	-	-	-	0.20
	8時	0.24	0.95	-	0.00	0.00	-	0.00	0.00	-	-	-	-	0.15
	9時	0.25	0.95	-	0.00	0.00	-	0.00	0.00	-	-	-	-	0.20
	10時	0.22	0.94	-	0.00	0.00	-	0.00	0.00	-	-	-	-	0.23
	11時	0.15	0.92	-	0.00	0.00	-	0.00	0.00	-	-	-	-	0.24
	12時	0.11	0.85	-	0.00	0.00	-	0.00	0.00	-	-	-	-	0.15
	13時	0.12	0.86	-	0.00	0.00	-	0.00	0.00	-	-	-	-	0.15
	14時	0.08	0.80	-	0.00	0.00	-	0.00	0.00	-	-	-	-	0.14
	15時	0.06	0.74	-	0.00	0.00	-	0.00	0.00	-	-	-	-	0.13
	16時	0.06	0.73	-	0.00	0.00	-	0.00	0.00	-	-	-	-	0.12
	17時	0.05	0.68	-	0.00	0.00	-	0.00	0.00	-	-	-	-	0.11
	18時	0.02	0.79	-	0.00	0.00	-	0.00	0.00	-	-	-	-	0.20
	19時	0.03	0.82	-	0.00	0.00	-	0.00	0.00	-	-	-	-	0.27
	20時	0.03	0.83	-	0.00	0.00	-	0.00	0.00	-	-	-	-	0.27
	21時	0.01	0.83	-	0.00	0.00	-	0.00	0.00	-	-	-	-	0.32
22時	0.01	0.85	-	0.00	0.00	-	0.00	0.00	-	-	-	-	0.36	
23時	0.02	0.00	-	0.00	0.00	-	0.00	0.00	-	-	-	-	0.01	
24時	0.05	0.00	-	0.00	0.00	-	0.00	0.00	-	-	-	-	0.02	
休日	7時	0.20	0.96	-	0.00	0.00	-	0.00	0.00	-	-	-	-	0.14
	8時	0.15	0.94	-	0.00	0.00	-	0.00	0.00	-	-	-	-	0.10
	9時	0.18	0.95	-	0.00	0.00	-	0.00	0.00	-	-	-	-	0.11
	10時	0.16	0.94	-	0.00	0.00	-	0.00	0.00	-	-	-	-	0.14
	11時	0.12	0.93	-	0.00	0.00	-	0.00	0.00	-	-	-	-	0.15
	12時	0.09	0.88	-	0.00	0.00	-	0.00	0.00	-	-	-	-	0.09
	13時	0.09	0.88	-	0.00	0.00	-	0.00	0.00	-	-	-	-	0.09
	14時	0.06	0.84	-	0.00	0.00	-	0.00	0.00	-	-	-	-	0.08
	15時	0.05	0.81	-	0.00	0.00	-	0.00	0.00	-	-	-	-	0.09
	16時	0.05	0.79	-	0.00	0.00	-	0.00	0.00	-	-	-	-	0.07
	17時	0.04	0.75	-	0.00	0.00	-	0.00	0.00	-	-	-	-	0.08
	18時	0.02	0.85	-	0.00	0.00	-	0.00	0.00	-	-	-	-	0.16
	19時	0.02	0.87	-	0.00	0.00	-	0.00	0.00	-	-	-	-	0.23
	20時	0.02	0.84	-	0.00	0.00	-	0.00	0.00	-	-	-	-	0.24
	21時	0.00	0.82	-	0.00	0.00	-	0.00	0.00	-	-	-	-	0.30
22時	0.00	0.83	-	0.00	0.00	-	0.00	0.00	-	-	-	-	0.32	
23時	0.01	0.00	-	0.00	0.00	-	0.00	0.00	-	-	-	-	0.00	
24時	0.03	0.00	-	0.00	0.00	-	0.00	0.00	-	-	-	-	0.01	

表 32【方向別交通量】 地域社会9

		A→B	A→C	A→D	B→A	B→C	B→D	C→A	C→B	C→D	D→A	D→B	D→C	計	
平日	7時	283	0	20	369	178	0	0	170	292	43	0	321	1,676	
	8時	278	0	21	377	173	0	0	165	283	53	0	312	1,661	
	9時	258	0	19	322	155	0	0	150	259	40	0	283	1,486	
	10時	248	0	19	293	145	0	0	142	245	32	0	267	1,391	
	11時	237	0	18	267	133	0	0	130	226	26	0	243	1,282	
	12時	224	0	17	245	123	0	0	121	209	23	0	225	1,188	
	13時	238	0	18	257	131	0	0	129	223	23	0	240	1,260	
	14時	243	0	19	251	129	0	0	127	221	21	0	236	1,248	
	15時	267	0	22	265	139	0	0	137	239	22	0	254	1,344	
	16時	283	0	24	268	143	0	0	141	248	21	0	262	1,390	
	17時	317	0	27	299	162	0	0	160	281	24	0	296	1,566	
	18時	332	0	28	315	175	0	0	173	304	23	0	320	1,670	
	19時	265	0	23	260	144	0	0	143	252	19	0	265	1,371	
	20時	228	0	24	216	121	0	0	120	216	16	0	221	1,162	
	21時	172	0	22	170	94	0	0	94	174	14	0	173	914	
	22時	123	0	19	121	66	0	0	67	127	11	0	122	654	
	23時	55	0	6	56	31	0	0	31	55	5	0	56	295	
	24時	38	0	4	40	22	0	0	22	39	3	0	41	209	
		A→B	A→C	A→D	B→A	B→C	B→D	C→A	C→B	C→D	D→A	D→B	D→C	計	
	休日	7時	115	0	10	194	72	0	0	68	120	45	0	132	757
		8時	185	0	17	286	106	0	0	102	178	64	0	196	1,133
		9時	237	0	20	343	133	0	0	130	226	55	0	247	1,390
		10時	285	0	23	355	160	0	0	158	273	44	0	296	1,596
		11時	304	0	25	355	165	0	0	163	283	38	0	304	1,637
12時		298	0	24	325	156	0	0	154	268	32	0	288	1,546	
13時		313	0	25	342	168	0	0	166	287	33	0	309	1,642	
14時		307	0	27	314	154	0	0	153	267	29	0	283	1,533	
15時		312	0	28	318	157	0	0	156	275	28	0	289	1,563	
16時		376	0	34	356	180	0	0	179	315	30	0	331	1,801	
17時		316	0	31	304	153	0	0	152	273	28	0	282	1,540	
18時		316	0	32	308	160	0	0	160	287	26	0	294	1,583	
19時		215	0	23	217	112	0	0	112	203	19	0	206	1,107	
20時		196	0	27	181	99	0	0	100	187	16	0	182	988	
21時		143	0	26	142	77	0	0	78	154	14	0	141	776	
22時		145	0	26	145	79	0	0	80	156	14	0	146	791	
23時		74	0	8	79	43	0	0	43	77	7	0	79	410	
24時		54	0	5	58	32	0	0	32	56	5	0	59	300	

表 33【大型車混入率】 地域社会9

		A→B	A→C	A→D	B→A	B→C	B→D	C→A	C→B	C→D	D→A	D→B	D→C	計	
平日	7時	0.12	-	0.13	0.10	0.02	-	-	0.03	0.39	0.06	-	0.38	0.19	
	8時	0.12	-	0.12	0.09	0.02	-	-	0.03	0.39	0.05	-	0.37	0.18	
	9時	0.11	-	0.12	0.10	0.03	-	-	0.03	0.39	0.05	-	0.38	0.19	
	10時	0.11	-	0.11	0.10	0.03	-	-	0.03	0.39	0.06	-	0.38	0.19	
	11時	0.11	-	0.11	0.10	0.03	-	-	0.03	0.39	0.07	-	0.38	0.19	
	12時	0.11	-	0.10	0.10	0.03	-	-	0.03	0.39	0.08	-	0.38	0.19	
	13時	0.11	-	0.11	0.10	0.03	-	-	0.03	0.39	0.08	-	0.38	0.19	
	14時	0.10	-	0.10	0.10	0.03	-	-	0.03	0.38	0.09	-	0.38	0.19	
	15時	0.10	-	0.09	0.11	0.03	-	-	0.03	0.38	0.09	-	0.38	0.19	
	16時	0.10	-	0.09	0.11	0.03	-	-	0.03	0.38	0.10	-	0.38	0.19	
	17時	0.10	-	0.09	0.11	0.03	-	-	0.03	0.38	0.10	-	0.38	0.19	
	18時	0.10	-	0.09	0.11	0.02	-	-	0.03	0.38	0.11	-	0.38	0.19	
	19時	0.10	-	0.09	0.11	0.02	-	-	0.03	0.38	0.11	-	0.38	0.19	
	20時	0.10	-	0.08	0.11	0.02	-	-	0.03	0.37	0.10	-	0.38	0.19	
	21時	0.10	-	0.06	0.11	0.02	-	-	0.03	0.36	0.10	-	0.38	0.19	
	22時	0.10	-	0.05	0.11	0.02	-	-	0.03	0.35	0.09	-	0.38	0.18	
	23時	0.10	-	0.08	0.11	0.02	-	-	0.03	0.37	0.09	-	0.38	0.19	
	24時	0.11	-	0.09	0.11	0.02	-	-	0.03	0.38	0.09	-	0.38	0.19	
		A→B	A→C	A→D	B→A	B→C	B→D	C→A	C→B	C→D	D→A	D→B	D→C	計	
	休日	7時	0.12	-	0.10	0.07	0.02	-	-	0.03	0.38	0.02	-	0.37	0.17
		8時	0.11	-	0.09	0.07	0.02	-	-	0.03	0.38	0.02	-	0.37	0.17
		9時	0.11	-	0.10	0.08	0.02	-	-	0.03	0.39	0.03	-	0.37	0.17
		10時	0.11	-	0.10	0.09	0.02	-	-	0.03	0.39	0.05	-	0.38	0.18
		11時	0.10	-	0.10	0.09	0.02	-	-	0.03	0.38	0.06	-	0.38	0.18
12時		0.10	-	0.09	0.10	0.02	-	-	0.03	0.39	0.07	-	0.38	0.18	
13時		0.10	-	0.10	0.10	0.02	-	-	0.03	0.39	0.07	-	0.38	0.18	
14時		0.09	-	0.09	0.10	0.02	-	-	0.03	0.38	0.08	-	0.38	0.18	
15時		0.09	-	0.08	0.10	0.02	-	-	0.03	0.38	0.08	-	0.38	0.18	
16時		0.09	-	0.08	0.10	0.02	-	-	0.03	0.38	0.09	-	0.38	0.18	
17時		0.09	-	0.07	0.10	0.02	-	-	0.03	0.37	0.08	-	0.38	0.18	
18時		0.09	-	0.07	0.10	0.02	-	-	0.03	0.37	0.09	-	0.38	0.18	
19時		0.10	-	0.07	0.10	0.02	-	-	0.03	0.36	0.08	-	0.38	0.18	
20時		0.09	-	0.05	0.11	0.02	-	-	0.03	0.35	0.09	-	0.38	0.18	
21時		0.10	-	0.04	0.11	0.02	-	-	0.03	0.33	0.08	-	0.38	0.18	
22時		0.10	-	0.05	0.11	0.02	-	-	0.03	0.34	0.08	-	0.38	0.18	
23時		0.11	-	0.08	0.11	0.02	-	-	0.03	0.37	0.09	-	0.38	0.19	
24時		0.11	-	0.09	0.11	0.02	-	-	0.03	0.38	0.09	-	0.38	0.19	

3.3 地域社会 7 における将来交通量の内訳

地域社会 7 の断面においては、騒音の現地調査の段階では環境基準を下回っていましたが、将来交通量による予測結果は、昼間は約 7 dB、夜間は約 8 dB 高くなり環境基準を上回る予測結果となりました。

そこで、地域社会 7 の断面を走行する平日の将来交通量が、どこを利用している交通量なのかを算出し、環境保全措置の検討資料の一部としました。

地域社会 7 の平日の断面交通量は、「表 15 断面 6 (往路・復路)」(p. 資料 地域-981) に示すとおりです。この交通量を、「①観光・賑わい地区」、「②物流地区」、「③公益的施設用地 (公園・防災等用地)」の開発事業に関連するものと、開発事業によらない「④一般」の 4 種類に分け、昼間と夜間の時間帯で整理をしました。整理をした結果は、表 34、表 35、図 5、図 6 に示します。

なお、昼間、夜間とは、騒音の環境基準の時間帯に合わせて、昼間は 6 時から 22 時まで、夜間は 22 時から翌朝 6 時までとしています。

内訳を算定した結果、昼間、夜間の北行き、南行きともに「④一般」の交通量が多く占める結果となりました。さらに、「④一般」のみが走行したと仮定した場合の騒音を予測した結果、昼間は、西側 64.5dB、東側 64.1dB、夜間は、西側 56.8dB、東側 57.0dB となり、いずれも環境基準 (昼間 60dB 以下、夜間 55dB 以下) を超える結果となりました。(表 36 参照)

一般の走行車による影響については、本区画整理事業に係る影響ではありますが、本区画整理事業では対応が困難なところもありますので、横浜市として対応をしていくこととします。今回の予測結果については、関係部局に引き継いでいくとともに、供用時におけるモニタリングの実施を検討していきます。

なお、区画整理事業の事業者としては、開発事業者に対して、「公共交通機関の利用促進」、「車両の効率的な利用促進」を促し、騒音の低減に努めていきます。

表 34 地域社会 7 の断面を通過する自動車交通量 (昼間)

内訳	北行き (台)		南行き (台)	
	小型車	大型車	小型車	大型車
①観光・賑わい地区	143	0	372	0
②物流地区	253	170	31	0
③公益的施設用地	408	0	0	0
④一般	3,303	543	2,788	516
合計	4,107	713	3,191	516

表 35 地域社会 7 の断面を通過する自動車交通量 (夜間)

内訳	北行き (台)		南行き (台)	
	小型車	大型車	小型車	大型車
①観光・賑わい地区	7	0	80	0
②物流地区	10	20	4	0
③公益的施設用地	0	0	0	0
④一般	205	17	221	28
合計	222	37	305	28



図5 地域社会7の断面を通過する自動車交通量（昼間）



図6 地域社会7の断面を通過する自動車交通量（夜間）

表 36 地域社会7における騒音の予測結果と環境基準

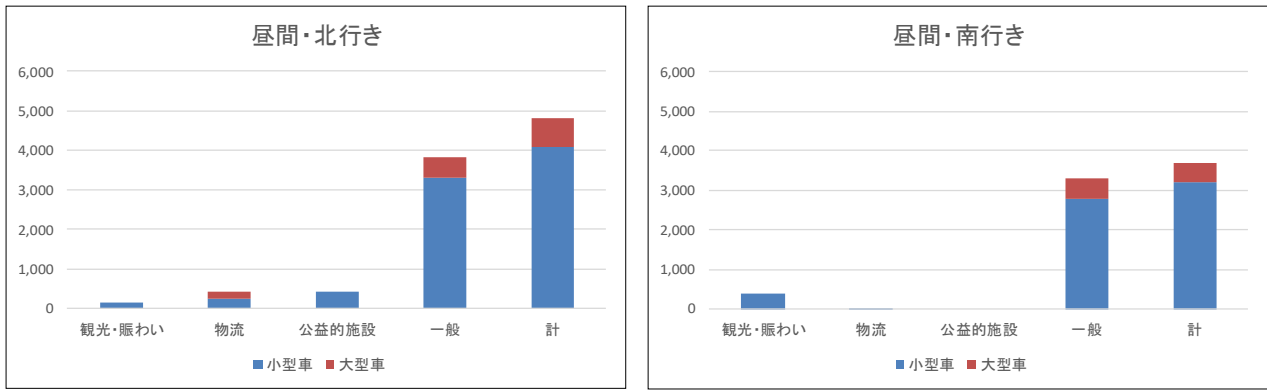
単位：dB

予測 時間帯	方 向	予測結果		環境基準	
		将来交通量※ ¹	④一般※ ²	環境基準	地域累計
昼 間	西 側	65.4 (×)	64.5 (×)	60 以下	A (道路)
	東 側	64.7 (×)	64.1 (×)		
夜 間	西 側	58.1 (×)	56.8 (×)	55 以下	
	東 側	58.0 (×)	57.0 (×)		

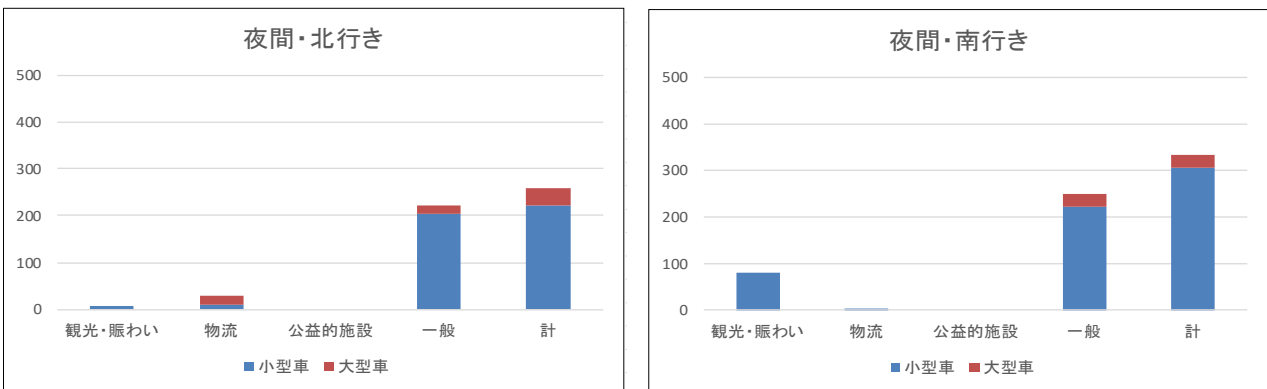
注：×印は、環境基準を上回ることを示します。

※1：開発事業（前述①～③）と一般（前述④）の合計台数による予測結果で、準備書に記載した数値です。

※2：一般（前述④）の車両だけによる予測結果です。

9.17-7 交差点需要率

対象事業実施区域周辺の主要交差点（9交差点）において求めた交差点需要率は、以下に示すとおりです。

- ・現況交通量 平日 P.資料 地域-995～1001
- ・現況交通量 休日 P.資料 地域-1002～1008
- ・現況交通量 混雑時 P.資料 地域-1009～1015
- ・工事中交通量 平日 P.資料 地域-1016～1020
- ・工事中交通量 休日 P.資料 地域-1021～1025
- ・供用時交通量 平日 P.資料 地域-1026～1034
- ・供用時交通量 休日 P.資料 地域-1035～1043

現況平日交差点検討資料

交差点概略図

現況平日 地域社会Ⅰ 目黒 17:45~18:45の需要率の算出

流入車線の種別	① 近つきみ野		② 海老名		③ 至 緑ヶ丘		④ 至 青葉台駅	
	左折・直進	右折	左折・直進	右折	直進	右折	左折・直進	右折
流車線の種別	1	1	1	1	1	1	1	1
飽和交通容量の基本値	1370	1800	1636	1543	1427	1788	1821	1798
車線幅員による補正率	α _w	1.000	1.000	1.000	1.000	1.000	1.000	1.000
(車線幅員)	m	(2.70)	(3.20)	(3.00)	(3.00)	(3.00)	(3.20)	(3.10)
縦断勾配による補正率	α _G	1.000	1.000	1.000	1.000	1.000	1.000	1.000
(縦断勾配)	%	(0.00)	(0.00)	(0.00)	(0.00)	(0.00)	(0.00)	(0.00)
大型車混入による補正率	α _T	0.923	0.900	0.964	0.959	0.925	0.939	0.985
(大型車混入率)	%	(11.89)	(12.50)	(5.38)	(23.65)	(30.25)	(9.36)	(18.54)
左折車混入による補正率	α _L	0.948		0.882				0.896
(左折率)	L%	(24.7)		(64.0)				(65.0)
(歩行者による低減率)	f _p	0.12		0.13		0.12		0.13
(歩行者用青時間)	秒	65		34		65		34
(歩行者用青時間)	秒	55		24		55		24
機動歩行者による補正率	α _R					0.898		
(右折率)	R%							
(右折車の通過確率)	f	0.589				0.712		
(有効青時間)	f	65				65		
(表示灯り目のるばけ台数増分)	R	2(45)				2(45)		
既設信号/サイクル数	q							
(交差点内補償台数)	q							
飽和交通容量	S	1305	1656	1391	1324	1075	1340	1444
設計交通容量	C	429	64	186	288	314	513	143
(R・C/サイクル)	q	(109+223)		(119+67)		(85+68)		
右折補正交通量	q _{R-N}	0	0	0	0	0	0	0
車入線の必要率	ρ	0.329	0.000	0.134	0.179	0.292	0.393	0.000
必要表示率	ρ	0.134	0.134	0.134	0.179	0.292	0.393	0.000
有効青時間(秒)	1φ							
2φ								
3φ								
4φ								
サイクル数(秒)	1φ	65	65	65	65	65	65	65
2φ								
3φ								
4φ								
青時間比	G/C	65/160	11/160	34/160	39/160	65/160	65/160	11/160
可能交通容量	C-1	530	296	273	437	544	463	307
交通容量比	q/C-1	0.809	0.278	0.628	0.872	0.719	0.943	0.316
交通容量比	q/C	0.809	0.278	0.628	0.872	0.719	0.943	0.316

* N = K × C / 3500

N : 第1時間現況変化時右折車の預け台数

* : 交通容量 (表1時間)

現況方式の図示

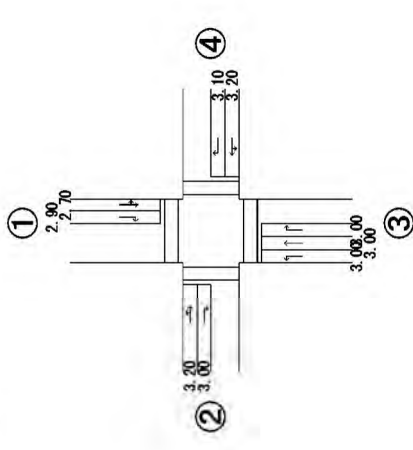
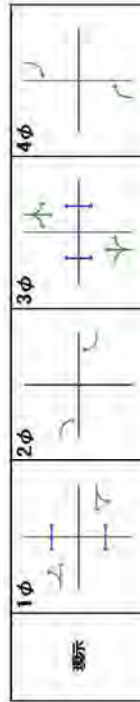

交通量図

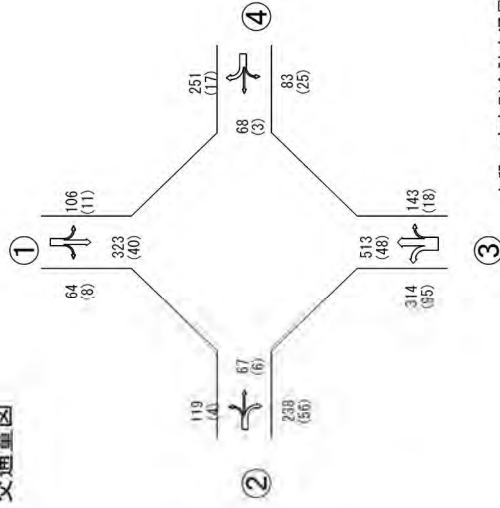

上段：方向別合計交通量(台)
下段：大型車混入台数(台)

現況平日 交差点検討資料

現況平日 地域社会2 目黒交番前 17:00~18:00 の需要率の算出

流入部 車線の種類	①至 十日市場		②至 つぎみ野		③至 泉		④至 鶴ヶ峰	
	左折・直進 直進	右折	左折 直進	右折	左折・直進 直進	右折	左折・直進 右折	右折
飽和交通流率の基本値 車線幅員による補正率 (車線幅員)	1647 1.000 (3.10)	1800 1.000 (3.10)	1388 0.950 (2.90)	1352 1.000 (2.80)	1557 1.000 (3.30)	1733 1.000 (3.20)	1536 1.000 (3.00)	1800 1.000 (2.75)
縦断勾配による補正率 (縦断勾配)	0.964 (0.00)	0.963 (0.00)	0.925 (0.00)	0.923 (0.00)	0.964 (0.00)	0.966 (0.00)	0.989 (0.00)	0.826 (0.00)
大型車混入による補正率 (大型車混入率)	0.963 (5.34)	0.925 (11.59)	0.919 (12.64)	0.896 (16.52)	0.964 (5.35)	0.966 (5.05)	0.870 (17.91)	0.826 (30.00)
左折車混入による補正率 (左折率)	0.995 (2.5)				0.927 (41.6)		0.974 (11.2)	
(歩行者による低減率)	0.13		0.13		0.13		0.13	
(有効歩時間)	28		103		28		103	
(歩行者用歩時間)	17		89		17		89	
横断歩行者による補正率 (横断歩行者による補正率)			0.888					
右折車混入による補正率 (右折率)				0.493 103 2(42)				0.508 103 2(42)
(右折車の通過確率)								
(有効歩時間)								
(現示変更目目のさげ台数増分)								
KER: 台/サイクル (交差点内滞留台数)								
K: 台/サイクル								
飽和交通流率	S A	1580	1665	1076	1361	1248	1508	1330
設計交通量	q	314 (4+310)	164	182	672	75	98	793 (89+704)
右折補正交通量	q R - N					0		0
流入部の需要率	ρ	0.099	0.098	0.169	0.494	0.000	0.065	0.000
必要現示率		0.099	0.098	0.169	0.494	0.000	0.065	0.000
1 φ								
2 φ								
3 φ								
4 φ								
有効歩時間(秒)		28				0.000		
1 φ								
2 φ								
3 φ								
4 φ								
信号機時間比	G/C	28/170	15/170	103/170	103/170	7/170	15/170	103/170
可能交通容量	C i	521	147	652	825	261	133	806
交通容量比	q/C i	0.603	1.116	0.279	0.815	0.287	0.737	0.031

$$* N = K \times \frac{3600}{C}$$

N : 実1時間現示変化する右折車の捌け台数

* : 交通容量(実1時間)

現示方式の現示

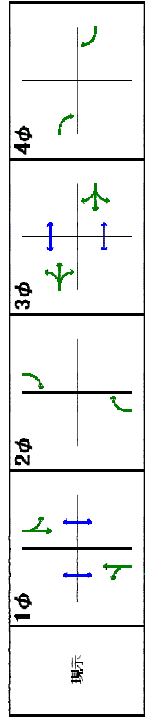

上段: 方向別合計交通量(台)
下段: 大型車混入台数(台)

交差点概略図

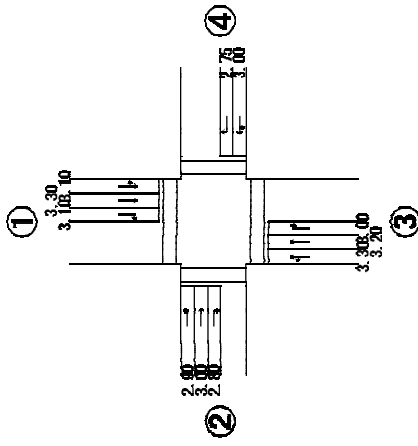

交通量図

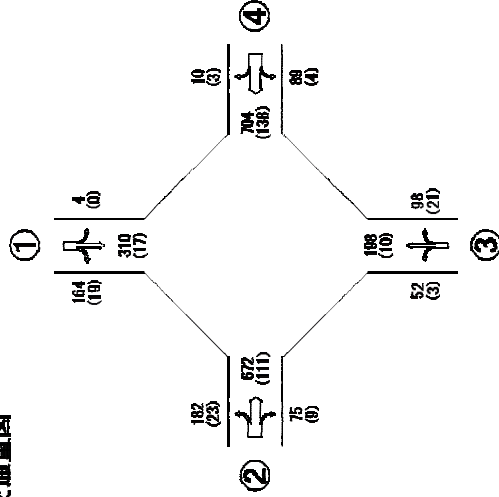

現況平日交差点検討資料

交差点概略図

現況平日 地域社会3 上川井 IC. 17:00~18:00の需要率の算出

流入部	①至 構延町田IC		②至 つきみ野		③至 下山井 IC		④至 鶴ヶ峰	
	左折	右折	直進	右折	直進	右折	直進	右折
車線の種類	1	1	1	1	1	1	1	1
車線数	1387	1587	1461	1587	1349	1511	1450	1450
飽和交通流率の基本値	SB							
車線幅員による補正率	αw	1.000	1.000	1.000	1.000	1.000	1.000	1.000
(車線幅員)	m	(5.10)	(3.60)	(3.60)	(3.60)	(3.60)	(3.60)	(3.60)
総貯留配による補正率	αG	1.000	1.000	1.000	1.000	1.000	1.000	1.000
(総貯留配)	%	(0.00)	(0.00)	(0.00)	(0.00)	(0.00)	(0.00)	(0.00)
大型車混入による補正率	αT	0.887	0.915	0.898	0.905	0.933	0.939	0.939
(大型車混入率)	%	(23.84)	(13.27)	(16.21)	(15.08)	(10.27)	(9.24)	(9.24)
左折車混入による補正率	$\alpha L T$							
(左折率)	L%							
(旅行者による低減率)	f p							
(有効青時間)	f							
(旅行者用青時間)	f p							
横断歩行者による補正率	αL	1.000						
(右折率)	R%	(17.2)						
(右折車の通過確率)	f	1.000						
(有効青時間)	f	20						
(現示変り目のさげ台数増分)	KER	2(61)						
(交差点内滞留台数)	K							
K: 右/サイクル								
K: 左/サイクル								
飽和交通流率	SA	1189	1337	1425	1221	1410	1362	
設計交通量	q	151	294	475	126	224	184	
(125+26)								
右折補正交通量	q R-N							
流入部の必要率	ρ	0.127	0.220	0.333	0.103	0.159	0.135	
必要現示率		0.127	0.220	0.333	0.103	0.159	0.135	
1φ								
2φ								
3φ								
1φ								
2φ								
3φ								
信号青時間比	G/C	20/118	30/118	50/118	20/118	30/118	50/118	
可能交通容量	Ci	202	340	604	207	358	577	
交通容量比	q/Ci	0.748	0.865	0.786	0.609	0.626	0.319	

$$* N = K \times \frac{3600}{C}$$

N : 実1時間現示変り右折車の捌け台数

* * : 交通容量(実1時間)

現示方式の図示

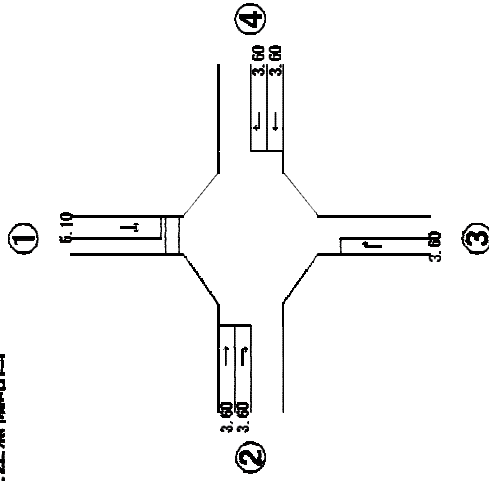
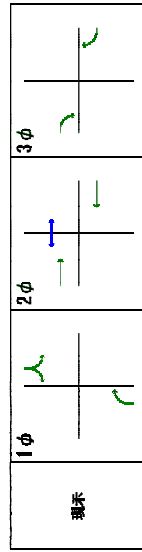

交通量図

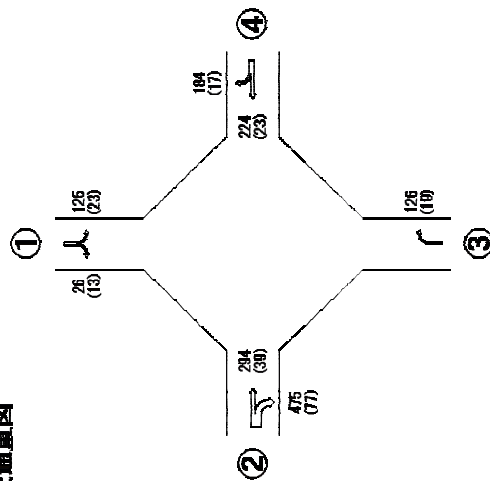

上段: 方向別合計交通量(台)
下段: 大型車混入台数(台)

現況平日 交差点検討資料

交差点概略図

現況平日 地域社会 4 滝沢 18:00~19:00 の需要率の算出

流入 車線	①		②		③	
	左折・直進	直進	直進	右折	左折・右折	右折
車線数	1	1	2	1	1	1
飽和交通流量の基本値 車線幅員による補正率 (車線幅員)	1658 αw (3.10)	1658 1,000 (3.20)	1618 1,000 (3.00)	1800 1,000 (3.00)	1800 1,000 (3.10)	1640 1,000 (3.20)
縦断分配による補正率 (縦断分配)	αG (0.00)	1,000 (0.00)	1,000 (0.00)	1,000 (0.00)	1,000 (0.00)	1,000 (0.00)
大型車混入による補正率 (大型車混入率)	αT (7.29)	0.951 (7.47)	0.950 (3.84)	0.781 (40.00)	0.896 (16.56)	0.964 (5.29)
左折車混入による補正率 (右折率) (右折率) (右折率による低減率) (有効車時間) (歩行者歩行時間による補正率) 横断歩行者による補正率 右折車混入による補正率 (右折率) (右折車の通過確率) (有効車時間) (現示変り目のさげ台数増分) KER: 台/サイクル (交差点内滞留台数) K: 台/サイクル	αLT (40.2) L% 0.12 f 秒 37 28	0.922 (40.2) 0.12				0.12 31 22 0.915
飽和交通流量	SA	1454	1575	3152	1406	1581
設計交通量	q	637 (128+509)	703	326 (326+0)	20	359
右折補正交通量	qR-N		0			
流入部の需要率	ρ	0.210	0.223	0.000	0.221	0.227
必要現示率	1φ 2φ 3φ	0.210 0.037 0.037	0.186 0.037	0.000 0.000	0.000 0.000	0.210 0.037
有効車時間(秒)	1φ 2φ 3φ	37 8 8	40 8	8	8	0.227 0.227 90
信号車時間比	G/C	37/90	48/90	8/90	31/90	31/90
可能交通容量	Ci	1245	1681	450	508	545
交通容量比	q/Ci	0.512	0.418	0.044	0.642	0.659
現示の 需要率						
交差点の 需要率						
サイクル長(秒)						

$$* N = K \times \frac{3600}{C}$$

N : 実1時間現示変化する右折車の捌け台数

* : 交通容量(実1時間)

**** : 連続現示での使用現示

①: 至 十日市場駅

②: 至 瀬谷駅

③:

現示方式の図示

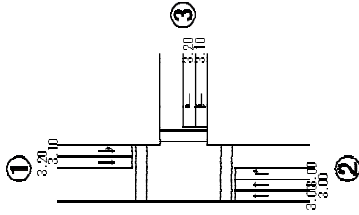
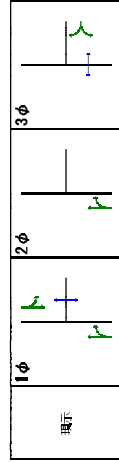

交通量図

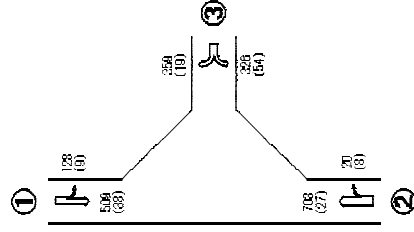

上段: 方向別右折交通量(台)
下段: 大型車混入台数(台)

現況平日交差点検討資料

交差点概略図

現況平日 地域社会4 瀬谷土樋公園入口 17:30~18:30の需要率の算出

流入線	①至 十日市場駅		②至 瀬谷駅		③	
	左折	直進	直進	右折	左折	右折
車線	1	1	2	1	1	1
車線	1	1	2	1	1	1
総和交通流率の基本値	1577	1877	1315	1369	1800	1682
車線幅員による補正率	αw	1.000	1.000	1.000	1.000	1.000
(車線幅員)	m	(3.20)	(3.20)	(3.30)	(3.30)	(3.60)
縦断勾配による補正率	αG	1.000	1.000	1.000	1.000	1.000
(縦断勾配)	%	(0.00)	(0.00)	(0.00)	(0.00)	(0.00)
大型車混入による補正率	αT	0.919	0.960	0.814	0.950	0.961
(大型車混入率)	%	(12.67)	(5.99)	(32.65)	(7.53)	(5.79)
左折車混入による補正率	$\alpha L T$	0.949				
(左折率)	L %	(25.4)				
(歩行者による低減率)	f p	0.12			0.12	
(有効車時間)	秒	48			39	
(歩行者滞留時間)	秒	36			27	
横断歩行者による補正率	αL				0.917	
右折車混入による補正率	$\alpha R T$					
(右折率)	R %					
(右折車の通過確率)	f					
(有効車時間)	秒					
(現示変り目のさばり台数増分)	K R					
(交差点内滞留台数)	K					
台/サイクル						
飽和交通流率	S A	1375	1498	2524	1114	1568
設計交通量	q	763	(97+666)	434	49	146
右折補正交通量	q R - N					311
流入部の需要率	ρ	0.266		0.172	0.044	0.093
必要現示率		0.266		0.138		0.266
1 ϕ				0.034	0.044	0.044
2 ϕ						0.192
3 ϕ						0.093
有効車時間(秒)		48		53		13
1 ϕ						39
2 ϕ						532
3 ϕ						548
信号青時間比	G / C	48/115		66/115	13/115	39/115
可能交通容量	C i	1199		1449	126	548
交通容量比	q / C i	0.636		0.300	0.389	0.274
						0.568
現示の需要率						0.192
必要現示率						0.266
1 ϕ						0.044
2 ϕ						0.192
3 ϕ						115
サイクル長(秒)						
交差点の需要率						0.502
必要現示率						0.044
1 ϕ						0.192
2 ϕ						115
3 ϕ						

$$* N = K \times \frac{3600}{C}$$

N : 第1時間現示変化時右折車の捌け台数

* : 交通容量(第1時間)

**** : 連続現示での使用現示

現示方式の図示

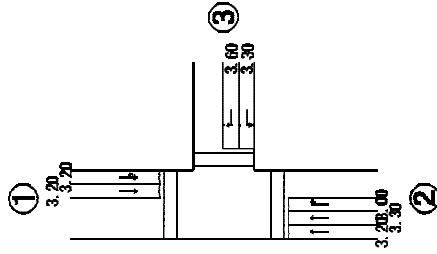
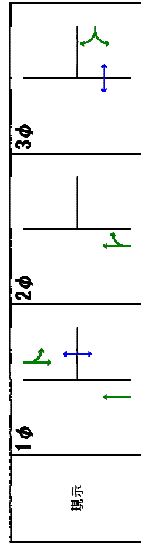

交通量図

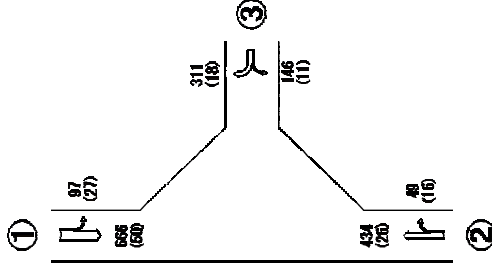

上段：方向別合計交通量(台)
下段：大型車混入台数(台)

交差点概略図

現況平日 地域社会5 中瀬谷消防署出張所北側 7:00~8:00 の需要率の算出

現況平日交差点検討資料

流入部	①至 十日市場		②至泉		③	
	左折・直進	直進・右折	左折・直進	直進・右折	左折・右折	右折
車線の種類	1	1	1	1	1	1
車線数	1	1	1	1	1	1
車線幅員	3.00	3.00	3.00	3.00	3.00	3.00
車線幅員による補正率	1.000	1.000	1.000	1.000	1.000	1.000
車線幅員による補正率	αw	αw	αw	αw	αw	αw
縦断勾配による補正率	αG	αG	αG	αG	αG	αG
縦断勾配による補正率	m	m	m	m	m	m
縦断勾配による補正率	%	%	%	%	%	%
大型車混入による補正率	αT	αT	αT	αT	αT	αT
大型車混入による補正率	%	%	%	%	%	%
大型車混入による補正率	αL	αL	αL	αL	αL	αL
大型車混入による補正率	(13.27)	(13.27)	(10.42)	(10.42)	(3.32)	(3.32)
左折車混入による補正率	αLT	αLT	αLT	αLT	αLT	αLT
左折車混入による補正率	(27.7)	(27.7)				
左折車混入による補正率	L%	L%	L%	L%	L%	L%
左折車混入による補正率	f	f	f	f	f	f
左折車混入による補正率	秒	秒	秒	秒	秒	秒
左折車混入による補正率	秒	秒	秒	秒	秒	秒
左折車混入による補正率	αL	αL	αL	αL	αL	αL
左折車混入による補正率	αRT	αRT	αRT	αRT	αRT	αRT
左折車混入による補正率	R%	R%	R%	R%	R%	R%
左折車混入による補正率	f	f	f	f	f	f
左折車混入による補正率	秒	秒	秒	秒	秒	秒
左折車混入による補正率	秒	秒	秒	秒	秒	秒
左折車混入による補正率	KER	KER	KER	KER	KER	KER
左折車混入による補正率	(交差点内滞留台数)	(交差点内滞留台数)	(交差点内滞留台数)	(交差点内滞留台数)	(交差点内滞留台数)	(交差点内滞留台数)
左折車混入による補正率	KC	KC	KC	KC	KC	KC
左折車混入による補正率	台/サイクル	台/サイクル	台/サイクル	台/サイクル	台/サイクル	台/サイクル
飽和交通流率	SA	SA	1282	1282	1426	1426
設計交通量	q	q	624	624	241	241
設計交通量	(167+436)	(167+436)	(540+84)	(540+84)	(67+174)	(67+174)
右折補正交通量	qR-N	qR-N				
流入部の必要率	ρ	ρ	0.470	0.487	0.169	0.169
必要率	φ	φ	0.470	0.426	0.470	0.700
必要率	2φ	2φ	0.061	0.061	0.061	0.061
必要率	3φ	3φ	0.169	0.169	0.169	0.169
有効時間(秒)	1φ	1φ	46	49	サイクル長(秒)	サイクル長(秒)
有効時間(秒)	2φ	2φ		7	サイクル長(秒)	90
有効時間(秒)	3φ	3φ			サイクル長(秒)	90
信号青時間比	G/C	G/C	46/90	56/90	24/90	24/90
可能交通容量	Ci	Ci	656	798	380	380
交通容量比	q/Ci	q/Ci	0.919	0.782	0.634	0.634

$$* N = K \times \frac{3600}{C}$$

N : 実1時間現況変化時右折車の割け台数

* : 交通容量 (実1時間)

* : 連続現況での使用現況

現況方式の図示

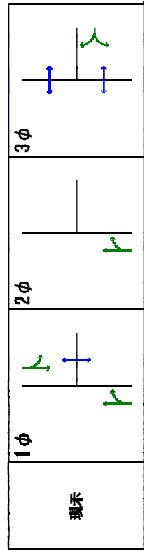

上段：方向別合計交通量(台)
下段：大型車混入台数(台)

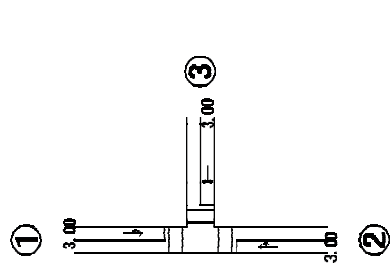

交通量図

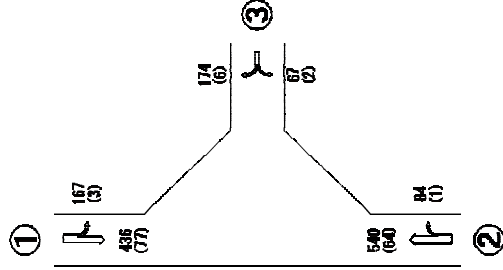

現況平日交差点検討資料

交差点概略図

現況平日 地域社会6 瀬谷中学校前 7:45~8:45の需要率の算出

流入の種類	①至 十日市場		②至 国道246号		③至 泉		④至 瀬谷小学校	
	左折	右折	左折・直進	右折	左折	直進	左折・直進	右折
車線数	1	1	1	1	1	1	1	1
飽和交通量の基本値 SB	1873	1800	1805	1800	1532	1594	1466	1400
車線員による補正率 αw	1.000 (3.00)	1.000 (2.75)	0.950 (2.90)	1.000 (2.80)	1.000 (3.00)	1.000 (3.00)	0.950 (2.80)	1.000 (2.80)
車線員による補正率 αG	1.000 (0.00)	1.000 (0.00)	1.000 (0.00)	1.000 (0.00)	1.000 (0.00)	1.000 (0.00)	1.000 (0.00)	1.000 (0.00)
総御分配による補正率 αT	0.923 (11.93)	0.914 (13.51)	0.954 (6.87)	0.963 (5.44)	0.935 (9.87)	0.923 (12.00)	0.960 (7.22)	0.952 (7.22)
大型車混入による補正率 αLT			0.986 (7.1)				0.952 (25.3)	
左折率 L%	0.13		0.13		0.13		0.13	
(走行者による低減率) fD	35		32		35		32	
(有効歩時間) 秒	25		20		25		20	
機動歩行者による補正率 αL	0.907				0.907			
右折車混入による補正率 αRT								
(右折率) R%								
(右折車の通過補率) f								
(有効歩時間) 秒								
(現示変り目のさげ台数増分) K								
KER: 右/サイクル								
K: 右/サイクル								
飽和交通量 S.A	960	1712	1613	1733	1100	1432	1471	1333
設計交通量 q	109	333	264 (26+338)	239	237	395	100 (84+248)	97
右折補正交通量 q R-N			0			0		0
流入部の需要率 ρ	0.114	0.195	0.226	0.000	0.215	0.276	0.000	0.261
必要現示率	0.114	0.195			0.215	0.276		0.276
1φ								0.000
2φ								0.261
3φ								0.000
4φ								0.000
有効歩時間(秒)	35	35			35			100
1φ								
2φ								
3φ								
4φ								
信号青時間比 G/C	35/100	35/100	32/100	9/100	35/100	35/100	8/100	32/100
可能交通容量 C.i	336	599	516	471	385	501	407	344
交通容量比 q/C.i	0.324	0.556	0.705	0.507	0.616	0.788	0.246	0.816

※ $N = K \times \frac{3600}{C}$

N : 実1時間現示変り右折車の捌け台数

※ * : 交通容量 (実1時間)

現示方式の現示

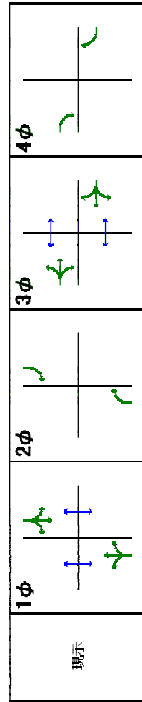

上段：方向別合計交通量(台)
下段：大型車混入台数(台)

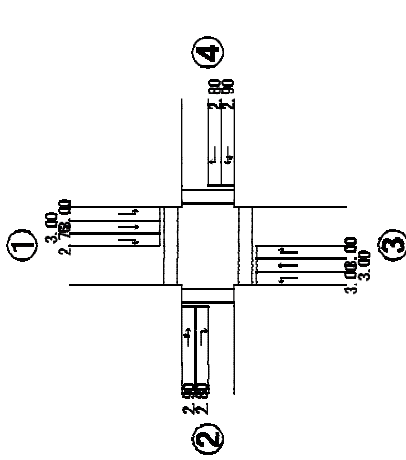

交通量図

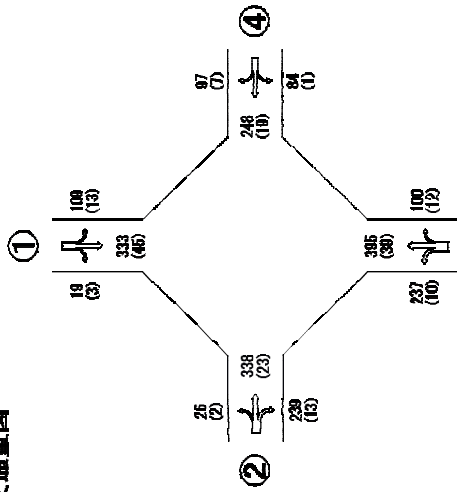

交差点概略図

現況休日 地域社会 1 目黒 16 : 45 ~ 17 : 45 の需要率の算出

流入線の種別	① 近づき		の混雑		③ 至 鶴ヶ峰		④ 至 東葉台駅	
	左折/直進	右折	左折/直進	右折	左折/直進	右折	左折/直進	右折
車線数	1	1	1	1	1	1	1	1
車線幅員	1540	1446	1524	1534	1517	1589	1478	1500
車線幅員による補正率	α _{WB}	1.000	1.000	1.000	1.000	1.000	1.000	1.000
(車線幅員)	(2.70)	(2.90)	(3.20)	(3.00)	(3.00)	(3.00)	(3.20)	(3.10)
総計分配による補正率	α _G	1.000	1.000	1.000	1.000	1.000	1.000	1.000
(総計分配)	(0.00)	(0.00)	(0.00)	(0.00)	(0.00)	(0.00)	(0.00)	(0.00)
大型車混入による補正率	α _T	0.965	0.965	0.926	0.936	0.974	0.979	0.962
(大型車混入率)	(6.60)	(5.17)	(1.69)	(11.39)	(9.82)	(3.79)	(3.03)	(6.79)
左折車混入による補正率	α _L	0.948	0.899	0.899				0.898
(左折率)	(25.1)	(53.4)						(54.3)
(右折率)	0.12	0.13	0.13		0.12			0.13
(有効時間)	66	66	34		56			34
(歩行者利用時間)	56	56	24		0.898			24
横断歩行者による補正率	α _L							
右折車混入による補正率	α _R							
(右折率)	R%							
(右折車の通過確率)	f	0.638						
(有効時間)	f	66						
(視界目ざしによる台数増分)	K	2(45)						
(交差点内滞留台数)	K							
(右/左/直進)	q	1326	1354	1420	1275	1528	1447	1443
設計交通量	q	530	118	202	387	422	66	162
(133+397)								233
右折補正交通量	q _{R-N}	0						
流入線の必要率	ρ	0.400	0.087	0.142	0.304	0.276	0.000	0.119
必要表示率	必要表示率	0.087	0.087	0.142				0.119
1φ								0.161
2φ								0.161
3φ								0.400
4φ								0.000
1φ			34					34
2φ								32
3φ								160
4φ								
信号機時間比	G/C	66/160	32/160	66/160	66/160	11/160	34/160	32/160
可能交通容量	C-I	547	288	284	526	630	341	289
交通容量比	q/C-I	0.969	0.184	0.711	0.736	0.670	0.194	0.806

※ N = K × $\frac{3600}{C}$

N : 実1時間間表示変化時右折車の捌け台数

※ * : 交通容量 (実1時間)

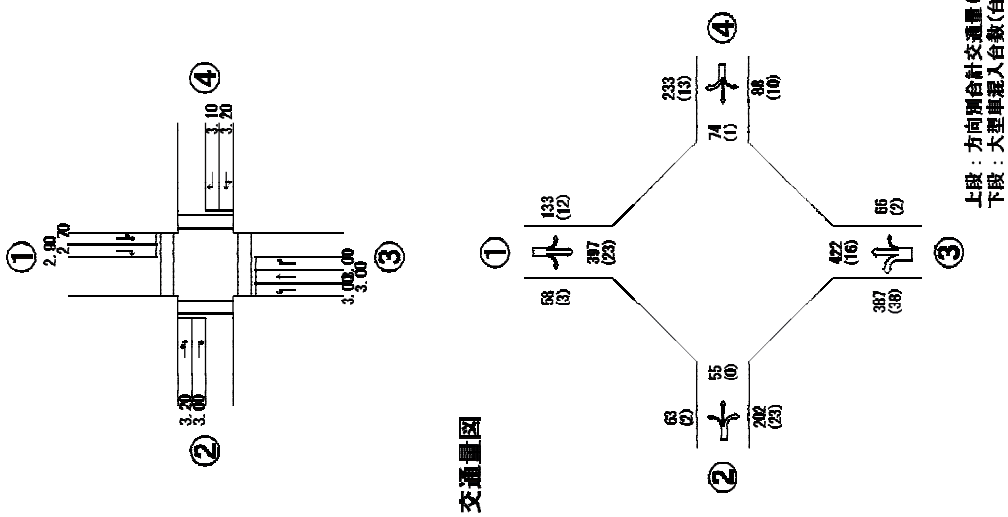

上段 : 方向混合計交通量 (台)
下段 : 大型車混入台数 (台)

表示方式の図示

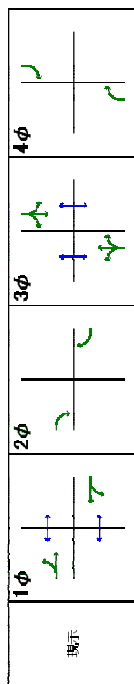

現況休日交差点検討資料

交差点標路図

現況休日 地域社会2 目黒交番前 16:45~17:45の需要率の算出

流入部	①至十日市場		②至つきみ野		③至泉		④至鶴ヶ峰	
	左折	直進	左折	直進	左折	直進	左折	直進
車線数	1	1	1	1	1	1	1	1
飽和交通流率の基本値 SB	1568	1568	1616	1505	1800	1454	1695	1800
車線幅員による補正率 αw (車線幅員)	1.000 (3.10)	1.000 (3.10)	0.950 (2.90)	1.000 (3.00)	1.000 (2.80)	1.000 (3.20)	1.000 (3.00)	1.000 (2.75)
網野分配による補正率 αG (網野分配)	1.000 (0.00)	1.000 (0.00)	1.000 (0.00)	1.000 (0.00)	1.000 (0.00)	1.000 (0.00)	1.000 (0.00)	1.000 (0.00)
大型車混入による補正率 αT (大型車混入率)	0.971 (4.29)	0.980 (2.88)	0.963 (5.52)	0.943 (8.59)	0.966 (5.00)	0.985 (2.05)	0.943 (11.94)	0.969 (4.55)
左折車混入による補正率 αLT (左折率)	0.987 (6.4)					0.955 (23.8)		0.979 (9.0)
(歩行者による低減率) L%	0.13					0.13		0.13
(有効歩時間) f p	31					31		90
(歩行者用青時間) 秒	20					20		76
横断歩行者による補正率 αL (右折率)	0.890							
右折車混入による補正率 αRT (右折率)								
(右折車の通過確率) R%								
(有効歩時間) 秒								
(現示変り目のさばけ台数増分) KER: 右/サイクル								
(交差点内滞留台数) K: 右/サイクル								
飽和交通流率 SA	1503	1537	1316	1419	1739	1434	1564	1744
設計交通量 q	251 (8+243)	137	181	582	60	277 (33+244)	67	641 (58+583)
右折補正交通量 qR-N					0			0
流入部の需要率 ρ	0.083	0.080	0.138	0.410	0.000	0.099	0.043	0.433
必要現示率	1φ 0.083					0.099		
	2φ	0.080					0.043	
	3φ							0.433
	4φ							0.000
有効歩時間(秒)	1φ 31				0.000			0.000
	2φ							
	3φ							
	4φ							
信号青時間比 G/C	31/160	14/160	90/160	90/160	8/160	31/160	14/160	90/160
可能交通容量 C-I	589	130	740	798	430	540	137	832
交通容量比 q/C-I	0.426	0.913	0.245	0.729	0.140	0.513	0.489	0.770
現在の需要率								0.612
現在の需要率								0.080
現在の需要率								0.433
現在の需要率								0.000
サイクル長(秒)								160

※ N = K × C

N : 実1時間現示変化時右折車の捌け台数

※ * : 交通容量 (実1時間)

現示方式の標示

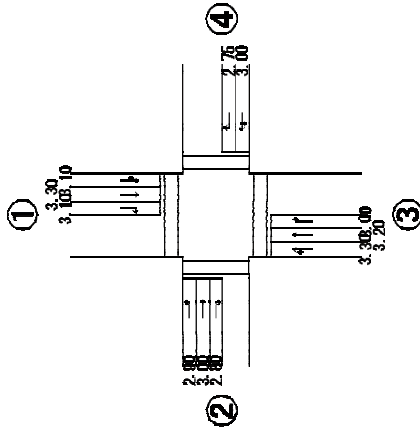
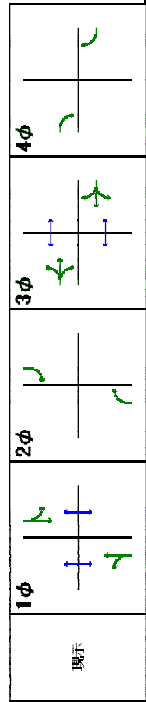

交通量図

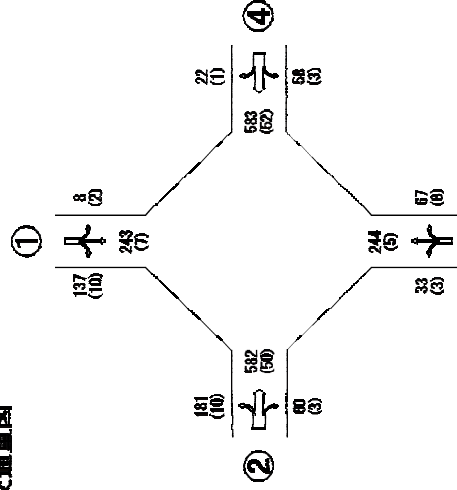

上段：方向別合計交通量(台)
下段：大型車混入台数(台)

現況休日交差点検討資料

現況休日 地域社会3 上川井 IC 16 : 45~17 : 45 の需要率の算出

流入部	①至 横浜町田 IC		②至 つきみ野		③至 下川井 IC		④至 鶴ヶ峰	
	左折・右折	直進	左折	右折	左折	右折	直進	右折
車線の種類	1	1	1	1	1	1	1	1
車線数	1	1	1	1	1	1	1	1
船舶交通流の基本値	SB	1646	1583	1705	1400	1525	1544	1544
船舶員による補正率	αw	1.000	1.000	1.000	1.000	1.000	1.000	1.000
(船舶員)	m	(5.10)	(3.60)	(3.60)	(3.60)	(3.60)	(3.60)	(3.60)
船舶交通による補正率	αG	1.000	1.000	1.000	1.000	1.000	1.000	1.000
(船舶交通)	%	(0.00)	(0.00)	(0.00)	(0.00)	(0.00)	(0.00)	(0.00)
大型車混入による補正率	αT	0.935	0.962	0.929	0.994	0.962	0.980	0.980
(大型車混入率)	%	(10.00)	(5.60)	(10.91)	(0.79)	(5.64)	(2.96)	(2.96)
左折車混入による補正率	$\alpha L T$							
(左折率)	L%							
(歩行者による低減率)	L%							
(歩行者)	f							
(有効歩時間)	p							
(歩行者用歩時間)	秒							
権限歩行者による補正率	$\alpha R T$	1.000						
(左折率)	R%	(18.0)						
右折車混入による補正率	αR	1.000						
(左折率)	R%	20						
(有効歩時間)	f							
(有効歩時間)	秒							
(現示変り目のさげ台数増分)	KER	2(68)						
(交差点内滞留台数)	K							
(右/サイクル)	q	1539	1523	1584	1392	1467	1513	1513
設計交通量	q	100	232	394	126	195	169	169
(82+18)								
右折補正交通量	q R-N							
流入部の必要率	ρ	0.065	0.152	0.249	0.091	0.133	0.112	0.112
必要現示率	1- ϕ	0.065			0.091		0.091	0.492
	2- ϕ		0.152			0.133	0.152	
	3- ϕ			0.249			0.112	0.249
有効歩時間(秒)	1- ϕ	20			20		27	105
	2- ϕ							
	3- ϕ							
信号歩時間比	G/C	20/105	27/105	40/105	20/105	27/105	40/105	40/105
可能交通容量	C i	293	603	265	377	576		
交通容量比	q/C i	0.341	0.592	0.653	0.475	0.517	0.293	0.293

$$\ast N = K \times \frac{3600}{C}$$

N : 実1時間現示変化時右折車の捌け台数

$\ast \ast$: 交通容量(実1時間)

交差点概略図

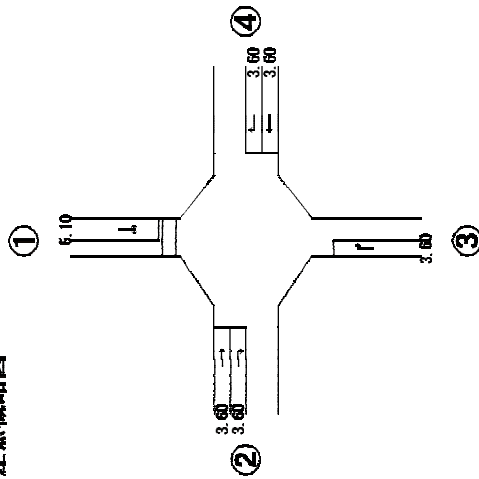

交通量図

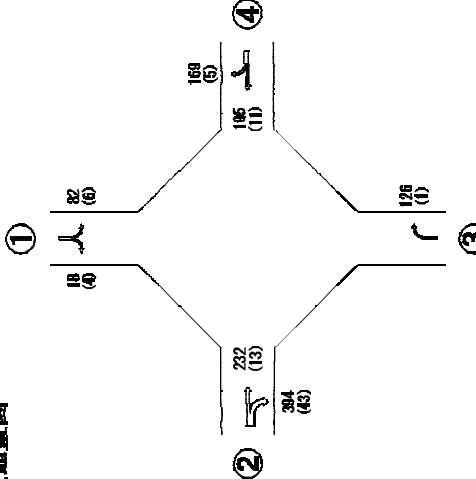

上段 : 方向別合計交通量(台)
下段 : 大型車混入台数(台)

現示方式の図示

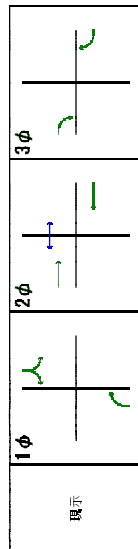

現況休日交差点検討資料

交差点概略図

現況休日 地域社会4 滝沢 15:45~16:45の需要率の算出

流入部	①至十市場駅		②至瀬谷駅		③	
	左折・直進	直進	直進	右折	左折・右折	右折
車線数	1	2	1	1	1	1
緩和交通流率の基本値	1545	1545	1800	1428	1428	1428
車線幅員による補正率	α _w	1.000	1.000	1.000	1.000	1.000
(車線幅員)	(3.10)	(3.20)	(3.00)	(3.10)	(3.20)	(3.20)
総野分配による補正率	α _G	1.000	1.000	1.000	1.000	1.000
(細野分配)	(0.00)	(0.00)	(0.00)	(0.00)	(0.00)	(0.00)
大型車混入による補正率	α _T	0.977	0.984	0.857	0.883	0.984
(大型車混入率)	(3.37)	(4.46)	(2.30)	(23.81)	(18.85)	(0.93)
左折車混入による補正率	α _L	0.899				
(左折率)	(50.9)					
(非行者による低減率)	L%	0.12				
(有効車時間)	f _p	51				
(歩行者用車時間)	f _p	42				
機師歩行者による補正率	α _R	1.000				
右折車混入による補正率	α _R	1.000				
(右折率)	R%	(0.0)				
(右折車の通過確率)	f	0.665				
(有効車時間)	f	54				
(現示変更目による台数増分)	f	1(32)				
KER: 台/サイクル						
(交差点内滞留台数)						
K: 台/サイクル						
設計交通量	SA	1357	2978	1543	1419	1419
右折補正交通量	q _{R-N}	511	610	21	122	216
(130+381)					(122+0)	
流入部の需要率	ρ	0.179	0.205	0.000	0.106	0.152
必要現示率	1φ	0.179	0.179	0.026	0.026	0.179
	2φ					0.026
	3φ					0.152
有効車時間(秒)	1φ	51	54	8	37	110
	2φ					37
	3φ					37/110
信号車時間比	G/C	51/110	62/110	8/110	37/110	37/110
可能交通容量	C _i	1324	1679	574	385	477
交通容量比	q/C _i	0.386	0.363	0.037	0.317	0.453

$$\ast N = K \times \frac{3600}{C}$$

N : 実1時間現示変化時右折車の捌け台数

∗∗ : 交通容量(実1時間)

∗∗∗∗ : 連続現示での使用現示

現示方式の図示

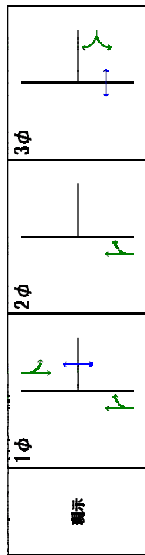

上段: 方向別合計交通量(台)
下段: 大型車混入台数(台)

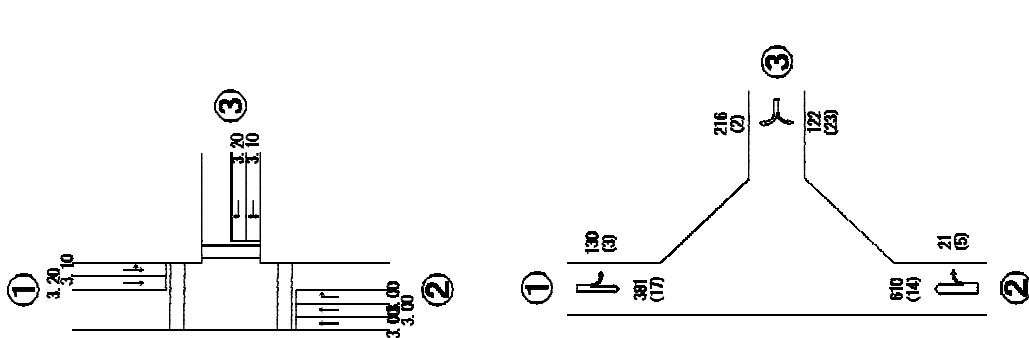

交通量図

現況休日交差点検討資料

交差点概略図

現況休日 地域社会4 瀬谷土橋公園入口 15:45~16:45の需要率の算出

流入部 車線 の種別	①至 土市場駅		②至 瀬谷駅		③	
	左折+直進	直進	直進	右折	左折	右折
車線数	1	2	1	1	1	1
飽和交通流率の基本値 S/B	1643	1514	1506	1800	1604	
車線幅員による補正率 αw	1.000	1.000	1.000	1.000	1.000	
(車線幅員)	(3.20)	(3.20)	(3.20)	(3.30)	(3.60)	
縦断勾配による補正率 αG	1.000	1.000	1.000	1.000	1.000	
(縦断勾配)	(0.00)	(0.00)	(0.00)	(0.00)	(0.00)	
大型車混入による補正率 αT	0.953	0.976	0.972	0.968	0.988	
(大型車混入率)	(7.02)	(3.52)	(4.08)	(4.76)	(1.76)	
左折車混入による補正率 αLT	0.944					
(左折率)	(29.6)					
L%	0.12			0.12		
(歩行者による低減率)	f			31		
(有効青時間)	秒			19		
歩行者用青時間	秒			31		
歩行者による補正率 αL				0.926		
右折車混入による補正率 αRT						
(右折率)	R%					
(右折車の通過確率)	f					
(有効青時間)	秒					
(現示変り目のさばけ台数増分)						
KER: 右/サイクル						
(交差点内滞留台数)						
K: 右/サイクル						
飽和交通流率 S/A	1478	1592	1464	1613	1585	
設計交通量 q	480	398	49	21	227	
(71+409)						
右折補正交通量 qR-N						
流入部の需要率 ρ	0.156	0.135	0.033	0.013	0.143	交差点の 需要率
必要現示率	1 φ 0.156	0.110			0.156	0.332
	2 φ	0.025	0.033		0.033	
	3 φ			0.013	0.143	
有効青時間(秒)	1 φ 43	48			サイクル長(秒)	
	2 φ	11	11		100	
	3 φ			31	31	
信号青時間比 G/C	43/100	59/100	11/100	31/100	31/100	
可能交通容量 C-1	1320	1744	161	500	491	
交通容量比 q/C-1	0.364	0.228	0.304	0.042	0.462	

$$N = K \times \frac{3600}{C}$$

N: 実1時間現示変化時右折車の捌け台数

* : 交通容量(実1時間)

** : 連続現示での使用現示

現示方式の図示

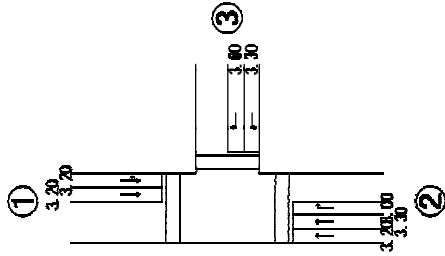
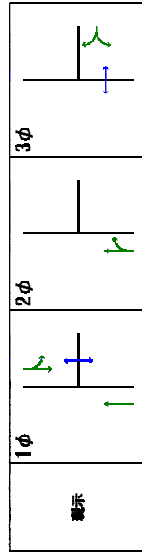

交通量図

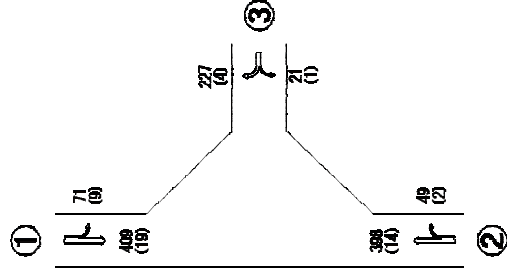

上段: 方向別合計交通量(台)
下段: 大型車混入台数(台)

交差点概略図

現況休日交差点検討資料

現況休日 地域社会5 中瀬谷消防署出張所北側 16:30~17:30 の需要率の算出

流入部	①至 十日市場		②至 泉		③	
	直進・直進	左折・右折	直進・直進	左折・右折	直進・直進	左折・右折
車線の種類	1	1	1	1	1	1
車線数	1333	1317	1317	1371	1371	1371
飽和交通流率の基本値	SB	1.000	1.000	1.000	1.000	1.000
車線幅員による補正率	αw	(3.00)	(3.00)	(3.00)	(3.00)	(3.00)
総野分配による補正率	αG	1.000	1.000	1.000	1.000	1.000
(総野分配)	%	(0.00)	(0.00)	(0.00)	(0.00)	(0.00)
大型車混入による補正率	αT	0.984	0.981	0.981	0.985	0.985
(大型車混入率)	%	(2.35)	(2.71)	(2.71)	(0.75)	(0.75)
左折車混入による補正率	αLT	0.838				
(左折率)	L%	(30.2)				
(持行者による低減率)	L%	0.12				
(有効青時間)	f	44				
(歩行者用青時間)	秒	44				
(歩行者用青時間)	秒	37				
横断歩行者による補正率	αL					
右折車混入による補正率	αRT		0.911	1.000	1.000	1.000
(右折率)	R%		(10.8)	(68.7)	(68.7)	(68.7)
(右折車の通過補正率)	f		0.685	1.000	1.000	1.000
(有効青時間)	秒		54	21	21	21
(現示変り目のさげ台数増分)						
KER: 台/サイクル			1(42)	1(42)	1(42)	1(42)
(交差点内滞留台数)						
K: 台/サイクル						
飽和交通流率	SA	1290	1177	1310	1310	1310
設計交通量	q	510	443	265	265	(83+182)
(154+356)			(385+48)			
右折補正交通量	qR-N					
流入部の需要率	ρ	0.415	0.376	0.202	0.202	0.202
必要現示率	1φ	0.415	0.327	0.415	0.415	0.666
	2φ			0.049	0.049	0.049
	3φ			0.202	0.202	0.202
有効青時間(秒)	1φ	44	47	47	47	サイクル長(秒)
	2φ					85
	3φ					
信号青時間比	G/C	44/85	54/85	21/85	21/85	
可能交通容量	Ci	637	748	324	324	
交通容量比	q/Ci	0.801	0.592	0.818	0.818	

$$* N = K \times \frac{3600}{C}$$

N : 現示時間現示変化時右折車の捌け台数

* : 交通容量(実1時間)

* : 現示での使用現示

現示方式の図示

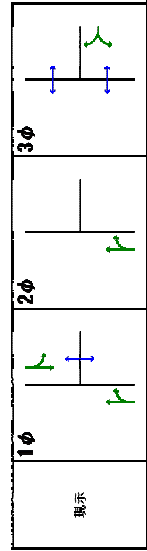

上段：方向別合計交通量(台)
下段：大型車混入台数(台)

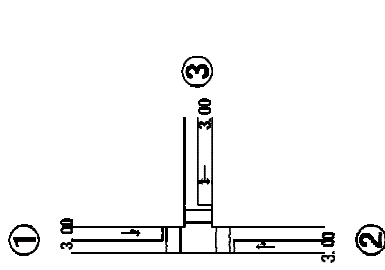

交通量図

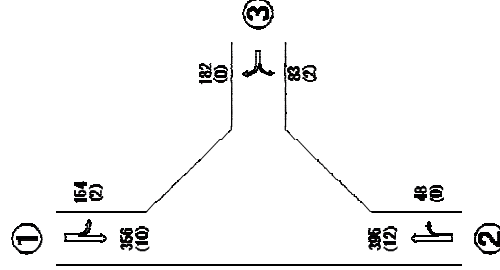

交差点概略図

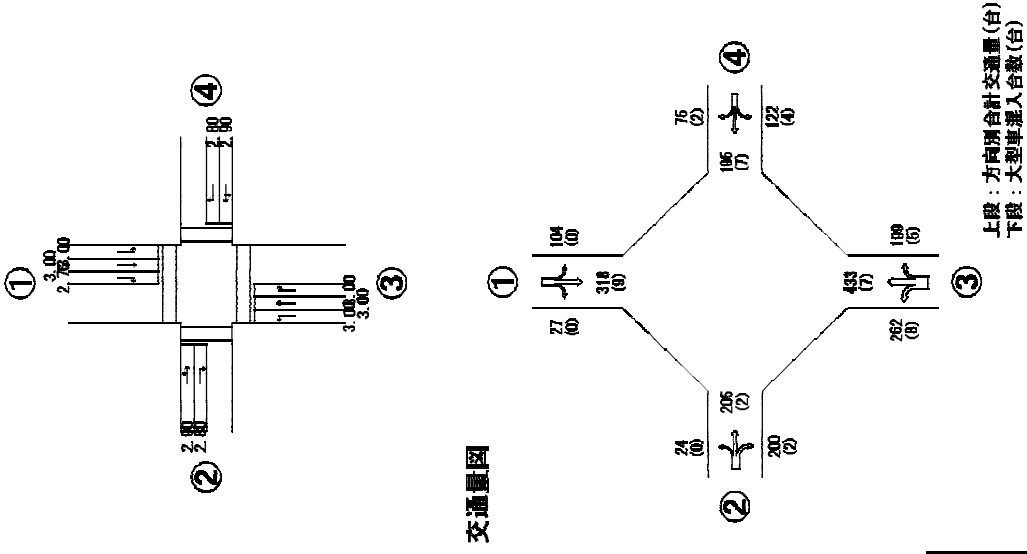

上段：方向別合計交通量(台)
下段：大型車進入台数(台)

現況休日交差点検討資料

現況休日 地域社会6 瀬谷中学校前 14:30~15:30 の需要率の算出

流入部	①至 十日市場		②至 国道246号		③至 泉		④至 瀬谷小学校	
	左折	右折	左折・直進	右折	直進	左折	右折	
車線の種類	1	1	1	1	1	1	1	
車線数	1	1	1	1	1	1	1	
総和交通流率の基本値 SB	1711	1800	1828	1800	1544	1477	1800	
乗換員による補正率 αw	1.000	1.000	0.960	1.000	1.000	1.000	1.000	
乗換員による補正率 m	(3.00)	(2.75)	(2.90)	(2.80)	(3.00)	(3.00)	(2.80)	
総和分配による補正率 αG	1.000	1.000	1.000	1.000	1.000	1.000	1.000	
総和分配による補正率 %	(0.00)	(0.00)	(0.00)	(0.00)	(0.00)	(0.00)	(0.00)	
大型車進入による補正率 αT	1.000	1.000	0.981	0.993	0.979	0.989	0.976	
大型車進入による補正率 %	(0.00)	(0.00)	(0.83)	(1.00)	(3.05)	(1.62)	(3.47)	
左折車進入による補正率 αLT			0.979					
左折車進入による補正率 L%			(10.5)					
(右折率)	0.13		0.13		0.13			
(右折率による低減率) fD	35		32		35			
(有効時間) f	25		20		25			
(右折率目背時間) αL	0.907		0.907		0.907			
横断歩行者による補正率 αR								
横断歩行者による補正率 αRT								
右折車進入による補正率 R%								
(右折率) f								
(右折率の通過補正率) f								
(有効時間) f								
(現示変り目のさげ台数増分) K								
KER: 台/サイクル								
(交差点内滞留台数) K:								
右/サイクル								
総和交通流率 SA	1552	1673	1690	1787	1371	1452	1768	
設計交通量 q	104	318	229	200	262	199	317	
右折補正交通量 qR-N								
流入部の必要率 ρ	0.067	0.190	0.136	0.000	0.191	0.286	0.000	
必要現示率	0.067	0.190	0.136	0.000	0.191	0.286	0.520	
1φ								
2φ								
3φ								
4φ								
有効時間(秒)	35	35	35	35	35	35	35	
1φ								
2φ								
3φ								
4φ								
信号青時間比 G/C	35/100	35/100	32/100	9/100	35/100	35/100	32/100	
可能交通容量 Ci	543	586	541	559	480	531	565	
交通容量比 q/Ci	0.192	0.543	0.423	0.358	0.546	0.815	0.501	
0.133								

現示方式の標示

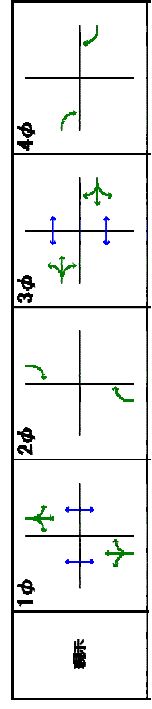

※ $N = K \times \frac{3600}{C}$

N : 実1時間現示変化時右折車の捌け台数

※ * : 交通容量 (実1時間)

現況混雑交差点検討資料

交差点概略図

現況混雑時 地域社会 1 目黒 11:15~12:15 の需要率の算出

流入種別	①至 つきみ野		②至 海老名		③至 鶴ヶ峰		④至 青葉台駅	
	左折	右折	左折	右折	直進	右折	左折	直進
車線数	1	1	1	1	1	1	1	1
飽和交通流率の基本値 (車線幅員)	1579	1482	1596	1711	1686	1641	1632	1691
αw	0.950	1.000	1.000	1.000	1.000	1.000	1.000	1.000
m	(2.70)	(3.20)	(3.20)	(3.00)	(3.00)	(3.00)	(3.10)	(3.10)
αG	1.000	1.000	1.000	1.000	1.000	1.000	1.000	1.000
(縦線勾配)	(0.00)	(0.00)	(0.00)	(0.00)	(0.00)	(0.00)	(0.00)	(0.00)
αT	0.936	0.941	0.953	0.830	0.843	0.931	0.907	0.932
(大型車混入率)	(9.83)	(9.00)	(7.05)	(29.23)	(26.69)	(10.64)	(20.27)	(10.34)
左折車混入による補正率 αLT	0.944		0.890				0.889	
(左折率)	(26.0)		(59.0)				(59.7)	
L%	0.12		0.13		0.12		0.13	
f	70		35		70		35	
p	60		25		60		25	
αR		0.596				0.689		
(右折率)		(70)				(70)		
R%		(2.45)				(2.45)		
f								
(有効車時間)								
(現示変り目による補正率)								
αL								
(横断歩行者による補正率)								
αRT								
(右折率)								
飽和交通流率	1325	1395	1354	1420	1275	1528	1447	1364
設計交通量	458	100	156	195	326	498	74	129
(交差点内滞留台数)	(119+339)		(92+64)				(77+52)	
右折補正交通量	q R-N	0				0		
流入部の必要率	ρ	0.346	0.115	0.137	0.256	0.326	0.000	0.095
必要現示率	1φ		0.115					0.115
2φ								0.181
3φ		0.346		0.137				0.181
4φ					0.256	0.326		0.346
有効車時間(秒)	1φ		35					0.000
2φ								0.000
3φ		70		32				35
4φ					70	70		32
信号時間比	G/C	70/160	6/160	32/160	70/160	6/160	35/160	32/160
可能交通容量	C1	580	296	284	558	669	386	299
交通容量比	q/C1	0.790	0.389	0.687	0.584	0.744	0.192	0.433

* N = K × $\frac{3600}{C}$

N : 実1時間現示変化時右折車の捌け台数

* : 交通容量 (実1時間)

現示方式の現示

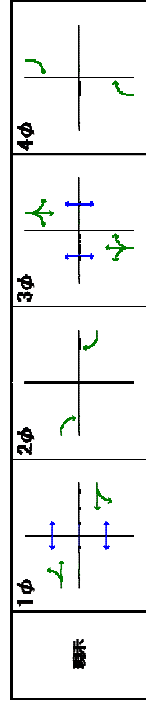

上段：方向別合計交通量(台)
下段：大型車混入台数(台)

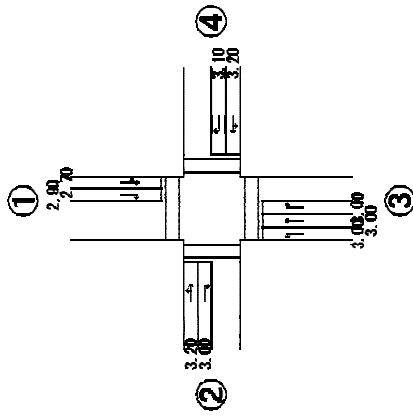

交通量図

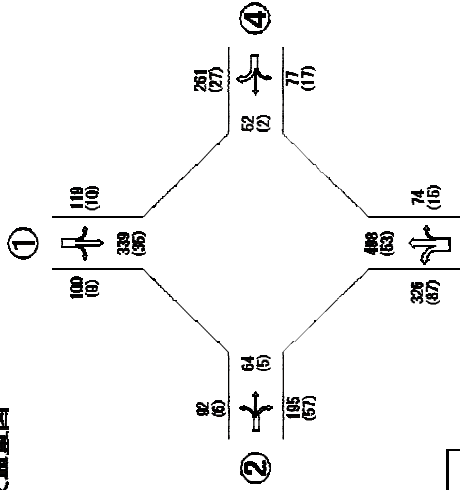

現況混雑交差点検討資料

交差点標路図

現況混雑時 地域社会2 目黒交番前 16:45~17:45の需要率の算出

流入部	①至十日市場		②至つきみ野		③至泉		④至鶴ヶ峰	
	左折	直進	左折	直進	左折	直進	左折	直進
車線数	1	1	1	1	1	1	1	1
飽和交通流率の基本値 SB	1594	1594	1642	1544	1800	1491	1779	1800
車線幅員による補正率 αw	1.000	1.000	0.950	1.000	1.000	1.000	1.000	1.000
(車線幅員)	(3.10)	(3.30)	(2.90)	(3.00)	(2.80)	(3.20)	(3.00)	(2.75)
縦断勾配による補正率 αG	1.000	1.000	1.000	1.000	1.000	1.000	1.000	1.000
(縦断勾配)	(0.00)	(0.00)	(0.00)	(0.00)	(0.00)	(0.00)	(0.00)	(0.00)
大型車混入による補正率 αT	0.959	0.964	0.949	0.919	0.932	0.953	0.976	0.914
(大型車混入率)	(6.17)	(5.81)	(7.62)	(12.64)	(10.47)	(7.11)	(3.49)	(19.64)
左折車混入による補正率 αLT	0.987					0.938		0.977
(左折率)	(6.7)					(32.9)		(9.6)
(歩行者による低減率)	0.13		0.13			0.13		0.13
(有効歩時間)	29		29			29		95
(歩行者用青時間)	18		18			18		81
横断歩行者による補正率 αL			0.889					
右折車混入による補正率 αRT					0.554			0.583
(右折率)					95			95
(右折車の通過確率)					2(43)			2(43)
(有効歩時間)								
(現示変り目のさばけ台数増分)								
KER: 右/サイクル								
(交差点内滞留台数)								
K: 右/サイクル								
飽和交通流率 SA	1509	1532	1316	1419	1678	1333	1455	1564
設計交通量 q	267		223	522	86	377	56	56
右折補正交通量 qR-N					0			(61+574)
流入部の必要率 ρ	0.088		0.169	0.368	0.000	0.135	0.036	0.429
必要現示率	0.088		0.102	0.102		0.135	0.036	0.102
1φ								0.429
2φ								0.429
3φ								0.000
4φ								0.000
有効歩時間(秒)	29				0.000	29		165
1φ								16
2φ								16
3φ								95
4φ								8
信号青時間比 G/C	29/165		95/165	95/165	8/165	29/165	16/165	95/165
可能交通容量 C-1	166		758	817	450	490	152	852
交通容量比 q/C-1	0.500		0.294	0.639	0.191	0.769	0.368	0.745
交通容量比 q/C								0.010

※ $N = K \times \frac{3600}{C}$

N: 実1時間現示変化時右折車の捌け台数

※*: 交通容量(実1時間)

現示方式の図示

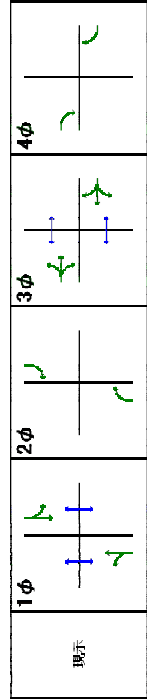

上段: 方向別合計交通量(台)
下段: 大型車混入台数(台)

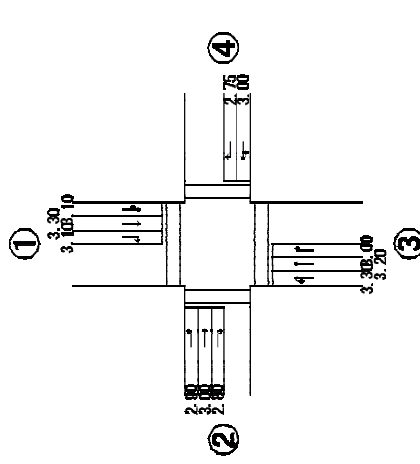

交通量図

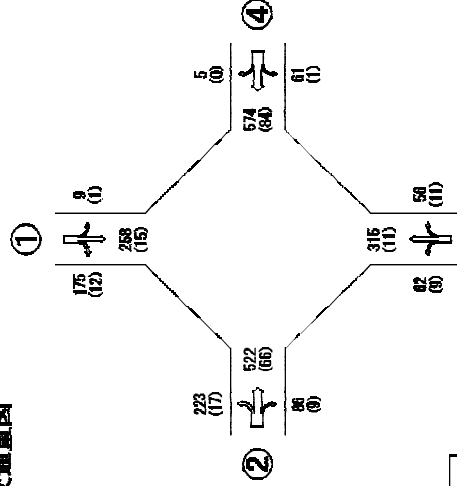

現況混雑交差点検討資料

現況混雑時 地域社会3 上川井 IC 17:45~18:45の需要率の算出

流入部	①至 横浜町田 IC		②至 つきみ野		③至 下山井 IC		④至 鶴ヶ峰	
	左折	右折	直進	右折	右折	直進	右折	右折
車線の種類	1	1	1	1	1	1	1	1
車線数	1671	1718	1564	1718	1449	1517	1583	1583
船舶交通流の基本値	SB	1718	1564	1718	1449	1517	1583	1583
船舶員による補正率	αw	1.000	1.000	1.000	1.000	1.000	1.000	1.000
(船舶員)	m	(3.60)	(3.60)	(3.60)	(3.60)	(3.60)	(3.60)	(3.60)
船舶分配による補正率	αG	1.000	1.000	1.000	1.000	1.000	1.000	1.000
(船舶分配)	%	(0.00)	(0.00)	(0.00)	(0.00)	(0.00)	(0.00)	(0.00)
大型車混入による補正率	αT	0.974	0.922	0.981	0.966	0.956	0.956	0.956
(大型車混入率)	%	(12.26)	(12.14)	(5.77)	(4.98)	(6.62)	(6.62)	(6.62)
左折車混入による補正率	$\alpha L T$							
(左折率)	L%							
(歩行者による低減率)	f p							
(有効歩時間)	秒							
(歩行者用歩時間)	秒							
補正歩行者による補正率	$\alpha R T$	1.000						
(左折率)	R%	(6.6)						
(有効歩時間)	秒	20						
(現不変り目のさばり台数増分)	KER	2 (65)						
(交差点内滞留台数)	K							
(右/サイクル)	q	1539	1523	1584	1465	1513	1513	1513
船舶交通流	SA	106	234	420	104	241	136	136
設計交通量	q	(99+7)						
右折補正交通量	q R-N							
流入部の需要率	ρ	0.069	0.154	0.265	0.075	0.165	0.090	0.090
必要現示率	ρ	0.069	0.154	0.265	0.075	0.165	0.090	0.090
1φ								
2φ								
3φ								
有効歩時間(秒)		20	29	20	29	20	29	29
1φ								
2φ								
3φ								
信号青時間比	G/C	20/110	29/110	43/110	20/110	29/110	43/110	43/110
可能交通容量	C i	280	402	619	253	386	591	591
交通容量比	q/C i	0.379	0.582	0.679	0.411	0.624	0.230	0.230

$$N = K \times \frac{3600}{C}$$

N : 第1時間現示変化時右折車の捌け台数

* : 交通容量 (実1時間)

現示方式の図示

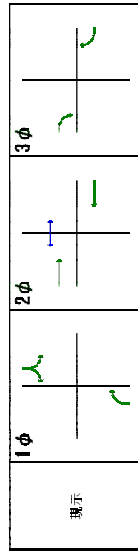

交差点概略図

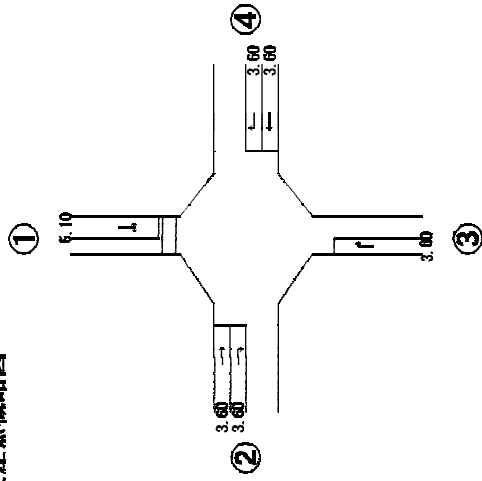

交通量図

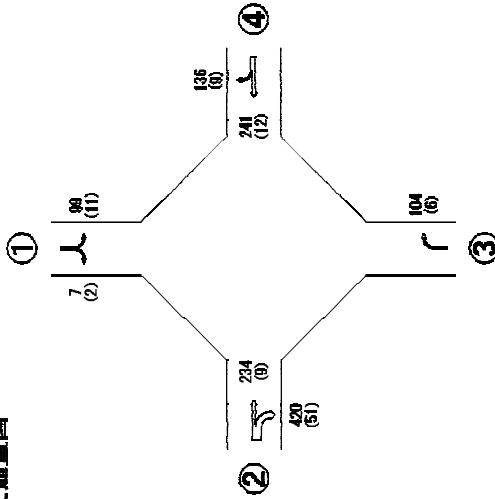

上段 : 方向別合計交通量(台)
下段 : 大型車混入台数(台)

現況混雑交差点検討資料

交差点概略図

現況混雑時 地域社会4 滝沢 17:30~18:30 の需要率の算出

流入部	①至 十日市場駅				②至 瀬谷駅				③			
	左折・直進	直進	右折	右折	左折・直進	直進	右折	右折	左折・右折	右折	右折	右折
車線の種類数	1	2	1	1	1	1	1	1	1	1	1	1
飽和交通流量の基本値 (車線幅員)	S B 1,570 (3.10)	1,570 (3.20)	1,570 (3.00)	1,800 (3.10)	1,570 (3.20)	1,800 (3.10)	1,800 (3.00)	1,800 (3.10)	1,429 (3.20)	1,429 (3.10)	1,429 (3.00)	1,429 (3.20)
縦断勾配による補正率 (%)	α G 1.000 (0.00)	1.000 (0.00)	1.000 (0.00)	1.000 (0.00)	1.000 (0.00)	1.000 (0.00)	1.000 (0.00)	1.000 (0.00)	1.000 (0.00)	1.000 (0.00)	1.000 (0.00)	1.000 (0.00)
大型車混入による補正率 (%) (大型車混入率)	α T 0.962 (5.70)	0.952 (7.22)	0.972 (4.05)	0.741 (50.00)	0.983 (4.05)	0.977 (50.00)	0.977 (4.05)	0.977 (4.05)	0.977 (4.05)	0.977 (4.05)	0.977 (4.05)	0.977 (4.05)
左折車混入による補正率 (%) (左折率)	α L T 0.902 (51.7)											
(有効青時間)	L % 0.12 37											
(歩行者目撃時間)	f p 37											
欄外歩行者による補正率 (%)	α L 28											
右折車混入による補正率 (%) (右折率)	α R T 0.000 (0.0)											
(右折車の通過確率)	R % 0.000 (0.0)											
(有効青時間)	f 40											
(表示変り目のさげ右数増分)	KER : 右/サイクル 1(40)											
(交差点内滞留台数)	K : 右/サイクル 1(40)											
飽和交通流量	S A 1,362	1,495	2,978	1,334	1,362	1,495	2,978	1,334	1,362	1,495	2,978	1,334
設計交通量	q 635 (164+471)		692	10	635 (164+471)		692	10	635 (164+471)		692	10
右折補正交通量	q R-N 0											
流入部の需要率	1 φ 0.222	0.232	0.193	0.000	0.222	0.232	0.193	0.000	0.222	0.232	0.193	0.000
必要現示率	2 φ 0.222	0.039	0.039	0.000	0.222	0.039	0.039	0.000	0.222	0.039	0.039	0.000
3 φ												
有効青時間(秒)	1 φ 37	40	8	8	37	40	8	8	37	40	8	8
2 φ												
3 φ												
信号青時間比	G/C 37/90	48/90	8/90	31/90	37/90	48/90	8/90	31/90	37/90	48/90	8/90	31/90
可能交通容量	C i 1,175	1,588	441	402	1,175	1,588	441	402	1,175	1,588	441	402
交通容量比	q/C i 0.540	0.436	0.023	0.420	0.540	0.436	0.023	0.420	0.540	0.436	0.023	0.420
現示の需要率	0.188	0.188	0.188	0.188	0.188	0.188	0.188	0.188	0.188	0.188	0.188	0.188
交差点の需要率	0.449	0.449	0.449	0.449	0.449	0.449	0.449	0.449	0.449	0.449	0.449	0.449
サイクル長(秒)	90	90	90	90	90	90	90	90	90	90	90	90

$$N = K \times \frac{3600}{C}$$

N : 実工時間現示変化時右折車の削け台数

* : 交通容量 (実工時間)

** : 必要現示率

*** : 連続現示での使用現示

現示方式の図示

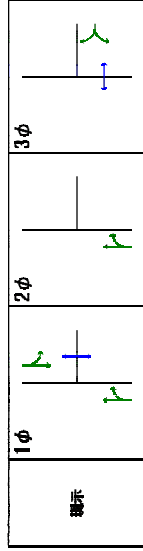

上段：方向別台計交通量(台)
下段：大型車混入台数(台)

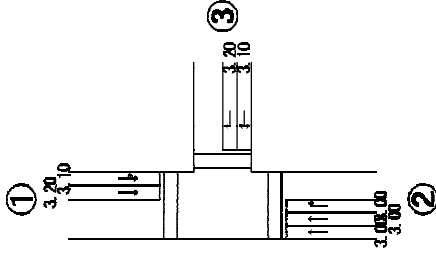

交通量図

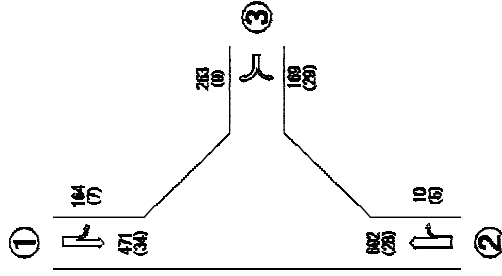

現況混雑交差点検討資料

交差点概略図

現況混雑時 地域社会4 瀬谷土橋公園入口 15:45~16:45 の需要率の算出

流入部	①至十田市場駅		②至瀬谷駅		③	
	左折・直進	直進	直進	右折	左折	右折
車線数	1	1	2	1	1	1
飽和交通流率の基本値 S.B	1707	1544	1544	1549	1800	1634
車線幅員による補正率 α _w	1.000	1.000	1.000	1.000	1.000	1.000
(車線幅員)	(3.20)	(3.20)	(3.30)	(3.30)	(3.30)	(3.60)
縦断勾配による補正率 α _G	1.000	1.000	1.000	1.000	1.000	1.000
(縦断勾配)	(0.00)	(0.00)	(0.00)	(0.00)	(0.00)	(0.00)
大型車混入による補正率 α _T	0.917	0.982	0.957	0.945	0.970	0.970
(大型車混入率)	(12.97)	(10.48)	(6.35)	(8.33)	(9.00)	(4.36)
左折車混入による補正率 α _L	0.945					
(左折率)	(27.6)					
(歩行者による低減率) I/P	0.12				0.12	
(有効青時間)	54				29	
(歩行者用青時間)	42				17	
権限歩行者による補正率 α _R	0.930				0.930	
右折車混入による補正率 α _R						
(右折率)						
(右折車の通過確率) f						
(有効青時間)						
(表示変り目のさげ台数増分) K.B.R.						
(台/サイクル)						
(交差点内滞留台数) K						
(台/サイクル)						
飽和交通流率 S.A	1479	1591	2956	1464	1575	1585
設計交通量 q	631	362	362	48	100	321
(87+544)						
右折補正交通量 q _{R-N}						
流入部の需要率 ρ	0.206		0.122	0.033	0.063	0.203
必要現示率	0.206		0.103		0.208	0.442
1φ					0.033	
2φ					0.033	
3φ					0.063	0.203
有効青時間(秒)	54		59			
1φ			11			
2φ						
3φ						109
信号青時間比 G/C	54/109		70/109	11/109	29/109	29/109
可能交通容量 C _i	1521		1898	148	419	422
交通容量比 q/C _i	0.415		0.191	0.324	0.239	0.761
現在の交差点の需要率						0.208
必要率						0.442
サイクル長(秒)						109

$$※ N = K \times \frac{3600}{C}$$

N : 実1時間現示変化時右折車の捌け台数

※ * : 交通容量(実1時間)

※ **** : 連続現示での使用現示

現示方式の図示

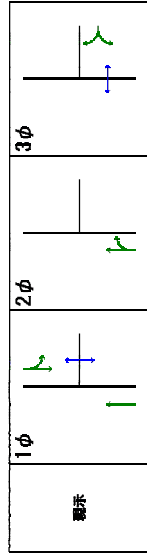

上段：方向別合計交通量(台)
下段：大型車混入台数(台)

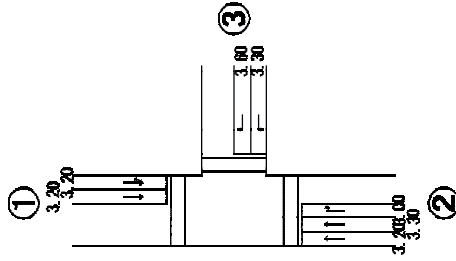

交通量図

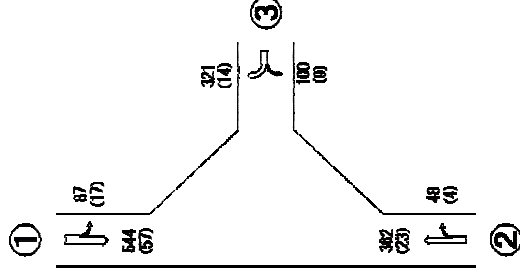

交差点概略図

現況混雑時 地域社会5 中瀬谷消防署出張所北側 10:45~11:45 の需要率の算出

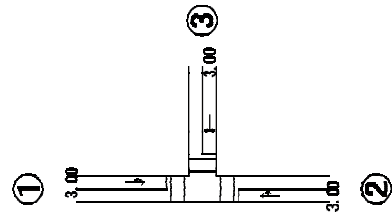

交通量図

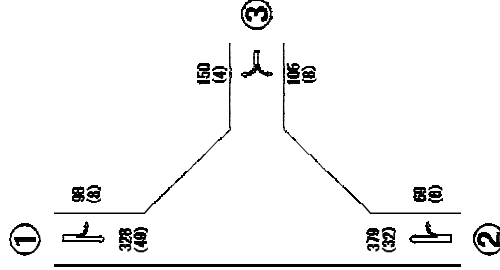

上段：方向別合計交通量(台)
下段：大型車混入台数(台)

現況混雑交差点検討資料

流入部	①至 ②至 承		③	
	①至 十日市場 左折・直進 I	②至・右折 I	左折・右折 I	左折・右折 I
車線の種別	1	1387	1391	
車線数	1	1387	1391	
車線幅員	3.00	3.00	3.00	
車線幅員による補正率	αw	1.000	1.000	
総野分配による補正率	m	1.000	1.000	
総野分配による補正率	αG	1.000	1.000	
(総野均配)	%	(0.00)	(0.00)	
大型車混入による補正率	αT	0.914	0.944	0.968
(大型車混入率)	%	(13.38)	(8.48)	(4.71)
左折車混入による補正率	αLT	0.962		
(左折率)	L%	(23.0)		
(歩行者による低減率)	f	0.12		
(有効歩時間)	秒	18		
(歩行者歩行時間)	秒	44		
横断歩行者による補正率	αL	37		
右折車混入による補正率	αRT	0.899	0.899	1.000
(右折率)	R%	(15.4)	(15.4)	(58.8)
(右折車の通過確率)	f	0.708	0.708	1.000
(有効歩時間)	秒	54	54	18
(現示変り目のさばけ台数増分)				
KER：台/サイクル				
(交差点内滞留台数)				
K：台/サイクル			1(43)	1(43)
飽和交通流率	SA	1220	1177	1310
設計交通量	q	426	448	255
(98+228)			(379+69)	(106+150)
右折補正交通量	qR-N			
流入部の必要率	ρ	0.346	0.381	0.195
必要現示率	1φ	0.346	0.332	0.346
	2φ		0.049	0.049
	3φ		0.195	0.195
有効歩時間(秒)	1φ	44	47	サイクル長(秒)
	2φ		7	82
	3φ			
信号青時間比	G/C	44/82	54/82	18/82
可能交通容量	Ci	660	775	288
交通容量比	q/Ci	0.645	0.578	0.885

$$※ N = K \times \frac{3600}{C}$$

N：実1時間現示変化時右折車の捌け台数

※*：交通容量(実1時間)

※****：連航現示での使用現示

現示方式の図示

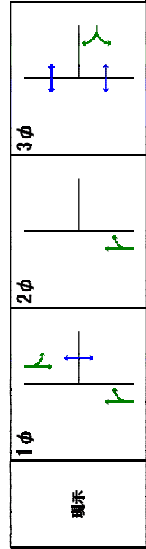

交差点概略図

現況混雑時 地域社会6 瀬谷中学校前 11:15~12:15 の需要率の算出

流入部	①至 十日市場		②至 国道246号		③至 泉		④至 瀬谷小学校		
	直進	右折	左折・直進	右折	左折	直進	右折	左折・直進	右折
車線数	1	1	1	1	1	1	1	1	1
飽和交通流率の基本値 SB	1800	1800	1864	1800	1555	1623	1497	1564	1800
車線員による補正率 αw	1.000	1.000	1.000	1.000	1.000	1.000	1.000	1.000	1.000
(車線員)	(3.00)	(2.75)	(2.90)	(3.00)	(3.00)	(3.00)	(3.00)	(2.90)	(2.80)
総野分配による補正率 αG	1.000	1.000	1.000	1.000	1.000	1.000	1.000	1.000	1.000
(総野分配)	(0.00)	(0.00)	(0.00)	(0.00)	(0.00)	(0.00)	(0.00)	(0.00)	(0.00)
大型車混入による補正率 αT	0.967	0.940	0.965	0.977	0.972	0.934	0.970	0.978	0.983
(大型車混入率)	(4.81)	(9.12)	(5.13)	(3.35)	(4.12)	(10.13)	(4.48)	(3.21)	(2.42)
左折車混入による補正率 αLT			0.989					0.984	
(左折率)			(5.6)					(35.6)	
(歩行者による低減率) I p	0.13		0.13		0.13			0.13	
(有効青時間)	35		32		35			32	
(歩行者用青時間)	25		20		25			20	
横断歩行者による補正率 αL	0.907				0.907				
右折車混入による補正率 αRT									
(右折率)									
(右折車の通過権率) R %									
f									
(有効青時間)									
(現示変り目のえぼけ台数増分)									
KER : 台/サイクル									
(交差点内滞留台数)									
K : 台/サイクル									
飽和交通流率 SA	1579	1674	1690	1759	1371	1516	1452	1357	1769
設計交通量 q	104	351	234	209	170	316	134	405	124
			(13+221)				(144+261)		
右折補正交通量 q R-N				0			0		0
流入部の需要率 ρ	0.066	0.210	0.138	0.000	0.124	0.208	0.000	0.298	0.000
必要現示率	0.066	0.210	0.138	0.000	0.124	0.208	0.000	0.210	0.508
1φ								0.000	
2φ								0.298	
3φ								0.000	
4φ								0.000	
有効青時間(秒)								サイクル長(秒)	
1φ	35	35	35	35	35	35	35	100	
2φ									
3φ									
4φ									
信号青時間比 G/C	35/100	35/100	32/100	9/100	35/100	35/100	8/100	32/100	9/100
可能交通容量 Ci	553	586	541	476	480	531	379	434	552
交通容量比 q/Ci	0.188	0.599	0.433	0.439	0.354	0.595	0.354	0.933	0.225

※ N = K × $\frac{3600}{C}$

N : 実1時間現示変化時右折車の捌け台数

※ : 交通容量 (実1時間)

現示方式の標示

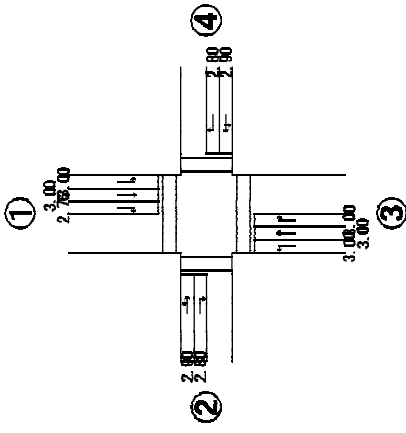
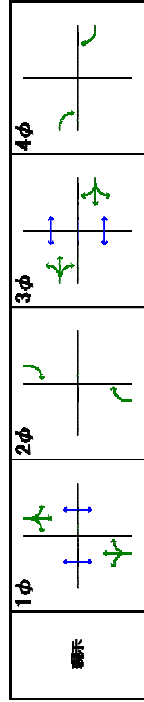

交通量図

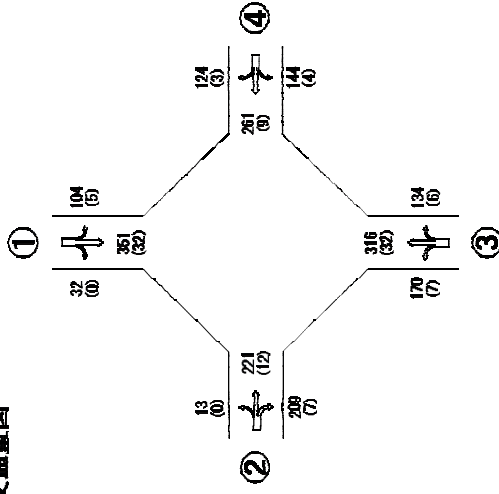

上段：方向別合計交通量(台)
下段：大型車混入台数(台)

工事中交差点検討資料

工事中(平日) 地域社会 1 目黒 17:00~18:00 の需要率の算出

交差点概略図

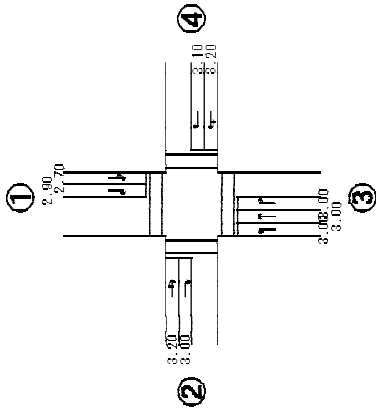

交通量図

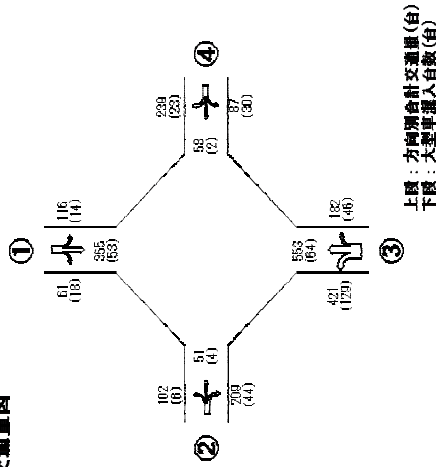

上段：方向別合計交通量(台)
下段：大型車混入台数(台)

流入部 車線の種類	①		②		③		④	
	左折・直進	右折	左折・直進	右折	左折	右折	直進	右折
車線数	1	1	1	1	1	1	1	1
飽和交通流量の基本値	1570	1800	1636	1543	1451	1427	1788	1821
車線幅員による補正率	α w	1.000	1.000	1.000	1.000	1.000	1.000	1.000
(車線幅員)	m	(2.70)	(3.20)	(3.00)	(3.00)	(3.00)	(3.20)	(3.10)
縦断勾配による補正率	α G	1.000	1.000	1.000	1.000	1.000	1.000	1.000
(縦断勾配)	%	(0.00)	(0.00)	(0.00)	(0.00)	(0.00)	(0.00)	(0.00)
大型車混入による補正率	α T	0.909	0.829	0.956	0.872	0.823	0.925	0.866
(大型車混入率)	%	(14.23)	(29.51)	(6.54)	(21.05)	(30.64)	(11.57)	(22.07)
左折車混入による補正率	α L T	0.949	0.949	0.877	0.877	0.877	0.877	0.888
(左折率)	L %	(24.6)	(66.7)					(60.0)
(歩行者による低減率)	f p	0.12	0.13	0.13	0.12	0.12	0.13	0.13
(有効青時間)	秒	63	32	32	63	63	32	32
(歩行者用青時間)	秒	53	22	22	53	53	22	22
横断歩行者による補正率	α L				0.899	0.899		
右折車混入による補正率	α R T							
(右折率)	R %							
(右折車の通過確率)	f	0.566	0.566				0.686	
(有効青時間)	秒	63	63				63	
(表示変り目のさげ台数増分)	KER	2(47)	2(47)				2(47)	
KER: 台/サイクル (交差点内滞留台数)	K: 台/サイクル							
飽和交通流量	S A	1287	1492	1372	1346	1074	1320	1520
設計交通量	q	471 (116+355)	61	153 (102+51)	209	421	553	182
右折補正交通量	q R-N	0	0				0	0
流入部の需要率	ρ	0.366	0.000	0.112	0.155	0.392	0.419	0.000
必要表示率	1 φ			0.112	0.155			0.104
2 φ								0.104
3 φ	0.366					0.392	0.419	0.142
4 φ								0.142
有効青時間(秒)	1 φ			32				32
2 φ								
3 φ	63				31	63		
4 φ								31
信号青時間比	G/C	63/153	10/153	32/153	31/153	63/153	63/153	10/153
可能交通容量	C i	530	178	287	273	442	544	396
交通容量比	q/C i	0.889	0.343	0.533	0.766	0.952	1.017	0.460
	q/C i							0.495
								0.701
表示の需要率								
0.112								
0.155								
0.000								
0.000								
サイクル長(秒)								153

※ N = K × $\frac{3600}{C}$

N : 実1時間現示変化時右折車の捌け台数

※ * : 交通容量(実1時間)

- ①: 至 つきみ野
- ②: 至 海老名
- ③: 至 鶴ヶ峰
- ④: 至 青葉台駅

標示方式の図示

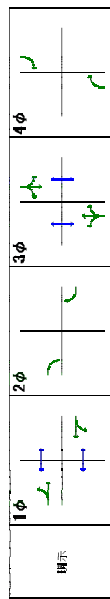

工事中交差点検討資料

交差点概略図

工事中(平日) 地域社会2 目黒交番前 17:00~18:00の需要率の算出

流線の種類	①				②				③				④			
	左折・直進	直進	右折	左折・直進	左折	直進	右折	左折・直進	左折	直進	右折	左折・直進	左折	直進	右折	
車線の種数	1	1	1	1	1	1	1	1	1	1	1	1	1	1	1	
飽和交通流量の基本値	1647	1647	1800	1388	1519	1352	1557	1536	1800	1536	1733	1536	1800	1536	1800	
車線幅員による補正率	αw	1.000	1.000	0.950	1.000	1.000	1.000	1.000	1.000	1.000	1.000	1.000	1.000	1.000	1.000	
(車線幅員)	m	(3.10)	(3.30)	(2.90)	(3.00)	(2.80)	(3.30)	(3.00)	(3.00)	(3.20)	(3.00)	(3.00)	(2.75)	(3.00)	(2.75)	
縦断勾配による補正率	αG	1.000	1.000	1.000	1.000	1.000	1.000	1.000	1.000	1.000	1.000	1.000	1.000	1.000	1.000	
(縦断勾配)	%	(0.00)	(0.00)	(0.00)	(0.00)	(0.00)	(0.00)	(0.00)	(0.00)	(0.00)	(0.00)	(0.00)	(0.00)	(0.00)	(0.00)	
大型車混入による補正率	αT	0.964	0.963	0.925	0.919	0.896	0.923	0.813	0.853	0.800	0.853	0.889	0.826	0.800	0.826	
(大型車混入率)	%	(5.34)	(5.48)	(11.59)	(12.64)	(16.52)	(12.00)	(32.82)	(24.52)	(35.83)	(17.91)	(30.00)	(30.00)	(30.00)	(30.00)	
左折車混入による補正率	αLT	0.995						0.869				0.974				
(左折率)	L%	(2.5)						(79.0)				(11.2)				
(歩行者による低減率)	f	0.13			0.13			0.13				0.13				
(有効青時間)	p	28			103			28				103				
(歩行者用青時間)	f	17			89			17				89				
横断歩行者による補正率	αL				0.888											
右折車混入による補正率	αRT															
(右折率)	R%															
(右折車の通過確率)	f					0.493									0.508	
(有効青時間)	f					103									103	
(表示変り目のさばけ台数増分)						2(42)									2(42)	
KER: 白/サイクル																
(交差点内滞留台数)																
K: 白/サイクル																
飽和交通流量	SA	1580	1586	1665	1076	1361	1248	1100	1328	1386	1330	1487				
設計交通量	q	314		164	182	672	75	694		321	793	10				
(4+310)								(274+420)			(89+704)					
右折補正交通量	qR-N						0					0				
流入部の需要率	ρ	0.099		0.098	0.169	0.494	0.000	0.286		0.232	0.596	0.000				
必要現示率		0.099		0.098	0.169	0.494	0.000	0.286		0.232	0.596	0.000				
1φ																
2φ																
3φ																
4φ																
有効青時間(秒)		28						28								
1φ																
2φ																
3φ																
4φ																
信号青時間比	G/C	28/170		15/170	103/170	103/170	7/170	28/170		15/170	103/170	7/170				
可能交通容量	Ci	521		147	682	825	261	400		122	806	324				
交通容量比	q/Ci	0.603		1.116	0.279	0.815	0.287	1.735		2.631	0.984	0.031				

※ $N = K \times \frac{3600}{C}$

N : 実1時間現示変化時右折車の捌け台数

※ * : 交通容量(実1時間)

①: 至 十日市場

②: 至 つきみ野

③: 至 泉

④: 至 鶴ヶ峰

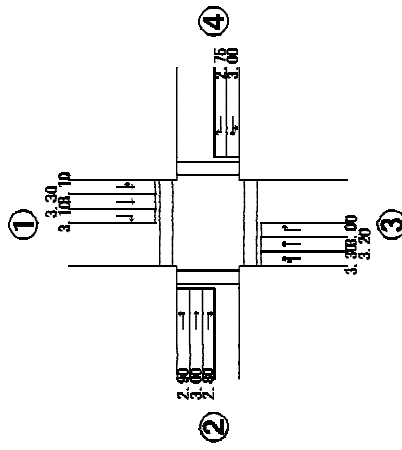

交通量図

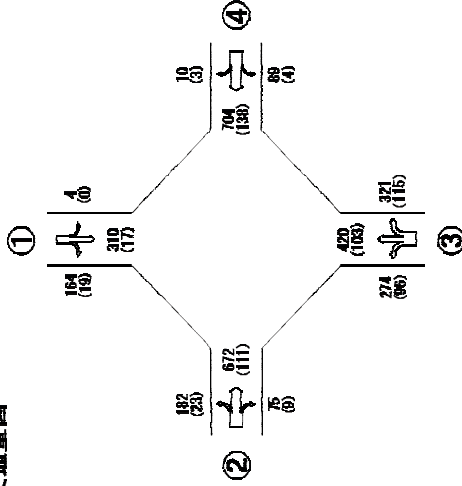

上段: 方向別合計交通量(白)
下段: 大型車混入台数(白)

現示方式の図示

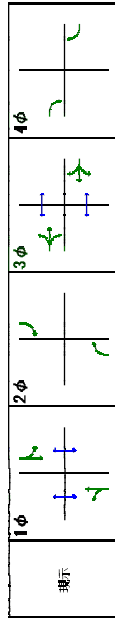

工事中交差点検討資料

工事中(平日) 地域社会3 上川井 IC 17:00~18:00 の需要率の算出

流線の種類	①		②		③		④	
	左折	右折	直進	右折	直進	右折	直進	右折
車線の種別	1	1	1	1	1	1	1	1
車線の数	1387	1461	1587	1349	1511	1450	1450	1450
飽和交通流率の基本値	S B	1461	1587	1349	1511	1450	1450	1450
車線幅員による補正率	αw	1.000	1.000	1.000	1.000	1.000	1.000	1.000
(車線幅員)	m	(5.10)	(3.60)	(3.60)	(3.60)	(3.60)	(3.60)	(3.60)
縦断勾配による補正率	αG	1.000	1.000	1.000	1.000	1.000	1.000	1.000
(縦断勾配)	%	(0.00)	(0.00)	(0.00)	(0.00)	(0.00)	(0.00)	(0.00)
大型車混入による補正率	αT	0.857	0.882	0.878	0.905	0.933	0.939	0.939
(大型車混入率)	%	(23.84)	(19.02)	(19.82)	(15.08)	(10.27)	(9.24)	(9.24)
左折車混入による補正率	$\alpha L T$							
(左折率)	L %							
(歩行者による低減率)	f p							
(有効青時間)	秒							
(歩行者用青時間)	秒							
権限歩行者による補正率	$\alpha R T$	1.000						
右折車混入による補正率	$\alpha R T$	1.000						
(右折率)	R %	(17.2)						
(右折車の通過確率)	f	1.000						
(有効青時間)	秒	20						
(現示変り目のさげ台数増分)	KER	2 (61)						
(交差点内滞留台数)	K	2 (61)						
(台/サイクル)								
飽和交通流率	S A	1189	1289	1393	1221	1410	1362	184
設計交通量	q	151 (125+26)	368	550	126	224	224	184
右折補正交通量	q R - N							
流入部の需要率	ρ	0.127	0.285	0.395	0.103	0.159	0.135	0.135
必要現示率	1 ϕ	0.127	0.285	0.103	0.103	0.159	0.159	0.135
	2 ϕ							0.285
	3 ϕ							0.395
有効青時間(秒)	1 ϕ	20			20			サイクル長(秒)
	2 ϕ							118
	3 ϕ							
信号青時間比	G/C	20/118	30/118	50/118	20/118	30/118	50/118	
可能交通容量	C i	202	328	590	207	358	577	
交通容量比	q/C i	0.748	1.122	0.932	0.609	0.626	0.319	

$$N = K \times \frac{3600}{C}$$

N : 実1時間現示変化時右折車の捌け台数

* : 交通容量(実1時間)

①: 至 横浜町田 IC

②: 至 つきみ野

③: 至 下川井 IC

④: 至 鶴ヶ峰

現示方式の図示

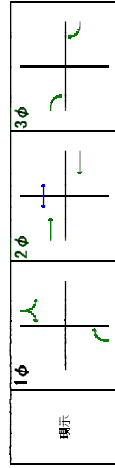

交差点概略図

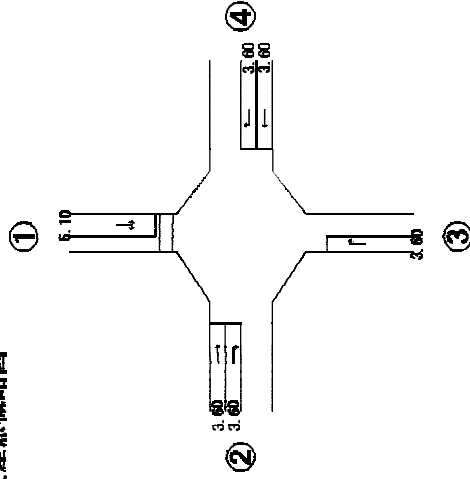

交通量図

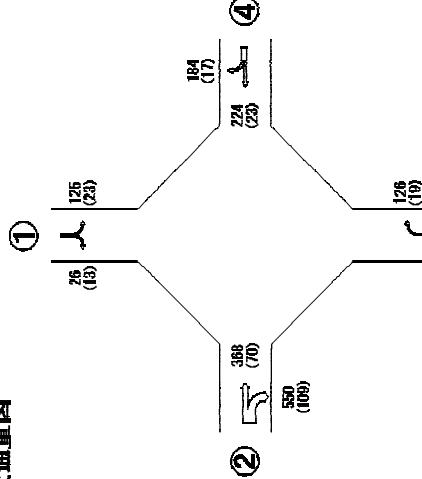

上段: 方向別合計交通量(台)
下段: 大型車混入台数(台)

工事中交差点検討資料

工事中 (平日) 地域社会 4 滝沢 17:30~18:30 の需要率の算出

交差点概略図

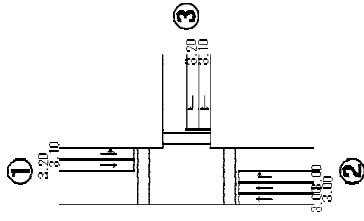

交通量図

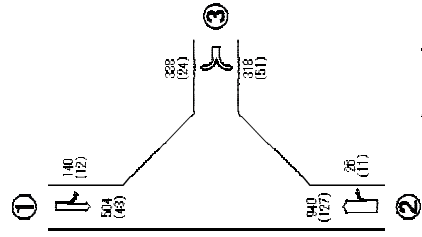

上線：方向別合計交通量(台)
下線：大型車混入台数(台)

流入の種別	①		②		③	
	左折・直進	直進	直進	右折	左折・右折	右折
車線数	1	1	2	1	1	1
飽和交通流率の基本値	1678	1678	1628	1800	1800	1659
車線幅員による補正率	1.000	1.000	1.000	1.000	1.000	1.000
(車線幅員)	(3.10)	(3.20)	(3.00)	(3.10)	(3.10)	(3.20)
縦断勾配による補正率	1.000	1.000	1.000	1.000	1.000	1.000
(縦断勾配)	(0.00)	(0.00)	(0.00)	(0.00)	(0.00)	(0.00)
大型車混入による補正率	0.944	0.944	0.914	0.772	0.899	0.953
(大型車混入率)	(8.55)	(8.53)	(13.51)	(42.31)	(16.04)	(7.10)
左折車混入による補正率	0.913					
(左折率)	(43.5)					
(歩行者による低減率)	0.12				0.12	
(有効青時間)	54				39	
(非行者自着時間)	45				30	
横断歩行者による補正率						
右折車混入による補正率						
(右折率)					1.000	
(右折車の通過確率)					(0.0)	
(有効青時間)					1.000	
(理示変り目のさばけ台数増分)					57	
KER: 台/サイクル					1 (31)	
K: 台/サイクル					1 (31)	
飽和交通流率	S A	1446	2976	1390	1469	1581
設計交通量	q	644	940	26	318	338
	q R - N	(140+504)			(318+0)	
右折補正交通量			0			
流入線の需要率	ρ	0.213	0.316	0.000	0.216	0.214
必要現示率	1 φ	0.213	0.277			0.277
	2 φ		0.039	0.000		0.039
	3 φ					0.216
有効青時間(秒)	1 φ	54	57			サイクル長(秒)
	2 φ		8			115
	3 φ					
信号青時間比	G/C	54/115	65/115	8/115	39/115	39/115
可能交通容量	C i	1423	1682	463	498	536
交通容量比	q/C i	0.453	0.559	0.056	0.639	0.631

$$※ N = K \times \frac{3600}{C}$$

N : 実1時間現示変化時右折車の捌け台数

※ * : 交通容量(実1時間)

※ **** : 運統現示での使用現示

①: 至 十日市場駅

②: 至 瀬谷駅

③:

現示方式の図示

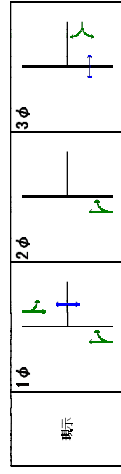

交差点概略図

工事中交差点検討資料
工事中(平日) 地域社会4 瀬谷土橋公園入口 17:30~18:30の需要率の算出

流入種別	①		②		③	
	左折-直進	直進	直進	右折	左折	右折
車線数	1	2	1	1	1	1
飽和交通流率の基本値 SB	1577	1315	1369	1800	1682	
車線幅員による補正率 αw	1.000	1.000	1.000	1.000	1.000	1.000
(車線幅員)	(3.20)	(3.20)	(3.30)	(3.30)	(3.60)	(3.60)
縦断勾配による補正率 αG	1.000	1.000	1.000	1.000	1.000	1.000
(縦断勾配)	(0.00)	(0.00)	(0.00)	(0.00)	(0.00)	(0.00)
大型車混入による補正率 αT	0.919	0.950	0.887	0.814	0.950	0.961
(大型車混入率)	(12.67)	(18.14)	(18.14)	(32.65)	(7.53)	(5.79)
左折車混入による補正率 αLT	0.949					
(左折率)	(25.4)					
(歩行者による低減率) L%	0.12				0.12	
(有効青時間) f p	48				39	
(歩行者用青時間) 秒	36				27	
権限法行者による補正率 αL					0.917	
右折車混入による補正率 αRT						
(右折率) R%						
(右折車の通過確率) f						
(有効青時間) 秒						
(現示変り目のさげ台数増分)						
KER: 台/サイクル						
(交差点内滞留台数)						
K: 台/サイクル						
飽和交通流率 SA	1375	1498	2332	1114	1568	1616
設計交通量 q	763		656	49	146	311
(97+666)						
右折補正交通量 qR-N						
流入部の需要率 ρ	0.266		0.281	0.044	0.093	0.192
必要現示率	0.266		0.226			0.266
			0.055	0.044		0.055
有効青時間(秒)	48		53		0.093	0.192
			13			
						115
信号青時間比 G/C	48/115		66/115	13/115	39/115	39/115
可能交通容量 Ci	1199		1338	126	532	548
交通容量比 q/Ci	0.636		0.490	0.389	0.274	0.568

※ $N = K \times \frac{3600}{C}$

N: 実1時間現示変化時右折車の捌け台数

※ *: 交通容量(実1時間)

※ ****: 連続現示での使用現示

①: 至 十日市場駅

②: 至 瀬谷駅

③:

現示方式の図示

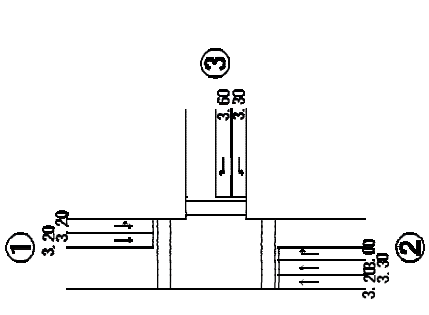
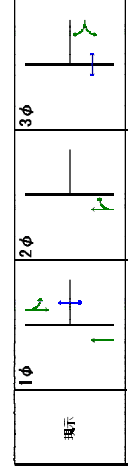

交通量図

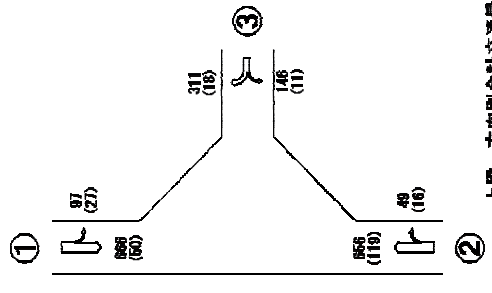

上段: 方向別合計交通量(台)
下段: 大型車混入台数(台)

交差点概略図

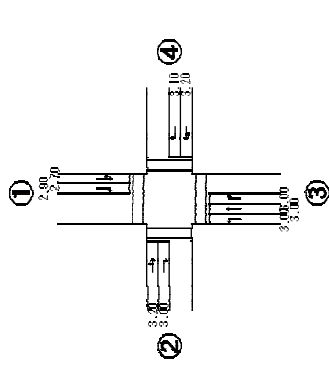

工事中交差点検討資料

工事中 (休日) 地域社会 1 目黒 16:45~17:45 の需要率の算出

流入部 車線の種別	①		②		③		④	
	左折	右折	左折	右折	左折	右折	左折	右折
総和交通流率の基本値	1540	1446	1524	1534	1517	1569	1478	1500
車線幅員による補正率	αw	1.000 (2.70)	1.000 (3.20)	1.000 (3.00)	1.000 (3.00)	1.000 (3.00)	1.000 (3.00)	1.000 (3.10)
網野公配による補正率	αG	1.000 (0.00)	1.000 (0.00)	1.000 (0.00)	1.000 (0.00)	1.000 (0.00)	1.000 (0.00)	1.000 (0.00)
大形重混入による補正率	αT	0.956 (6.60)	0.985 (5.17)	0.988 (11.39)	0.926 (14.97)	0.905 (9.48)	0.938 (23.57)	0.955 (6.79)
左折車混入による補正率	αLT	0.948 (25.1)		0.889 (53.4)				0.898 (54.3)
(歩行者による低減率)	f p	0.12		0.13		0.12		0.13
(歩行者用青時間)	f p	66		34		66		34
権野歩行者による補正率	αL	56		24		56		24
右折車混入による補正率	αRT			0.898		0.898		
(右折率)	R%							
(右折車の通過補正率)	f	0.597					0.652	
(有効青時間)	秒	66					66	
(現示変更り目のさげ台数増分)		2(45)					2(45)	
KER: 台/サイクル								
(交差点内滞留台数)								
K: 台/サイクル								
総和交通流率	SA	1326	1395	1354	1420	1233	1472	1268
設計交通量	q	530 (133+397)	58	118 (63+55)	202	461	496	140
右折補正交通量	qR-N	0	0	0	0	0	0	0
流入部の需要率	ρ	0.400	0.000	0.087	0.142	0.374	0.337	0.000
必要現示率				0.087		0.119		0.161
1φ								
2φ								
3φ								
4φ								
1φ								
2φ								
3φ								
4φ								
有効青時間(秒)			34					34
G/C								
4φ			11					11
信守青時間比		66/160	11/160	32/160	66/160	66/160	66/160	32/160
可能交通容量	Ci	547	258	288	284	509	607	304
交通容量比	q/Ci	0.969	0.225	0.410	0.711	0.906	0.817	0.461
現示の需要率								
必要率								
1φ								
2φ								
3φ								
4φ								
サイクル長(秒)								160

$$N = K \times \frac{3600}{C}$$

N: 実1時間現示変化時右折車の掛け台数

*: 交通容量 (実1時間)

現示方式の図示

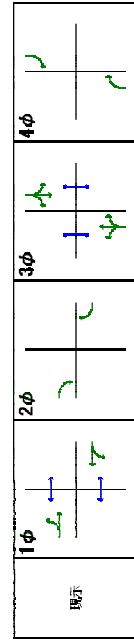

- ①: 至 つきみ野
- ②: 至 海老名
- ③: 至 鶴ヶ峰
- ④: 至 青葉台駅

交通量図

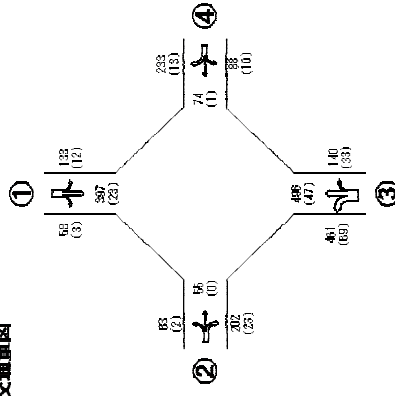

上段: 右折割合計交通量(台)
下段: 大型車混入台数(台)

工事中交差点検討資料

工事中 (休日) 地域社会3 上川井 IC 16:45~17:45 の需要率の算出

交差点概略図

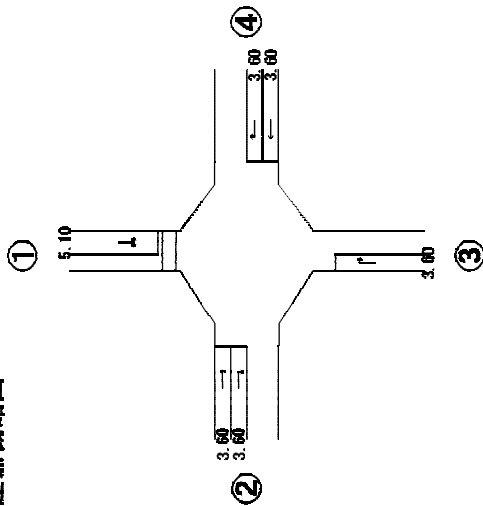

交通量図

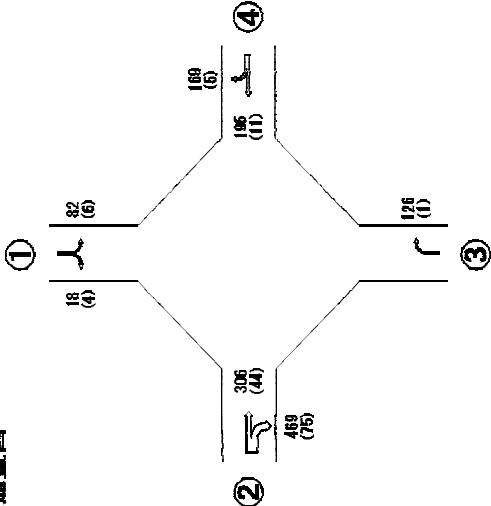

上段：方向別合計交通量(台)
下段：大型車混入台数(台)

流入部 車線の種類	①		②		③		④	
	左折	右折	直進	右折	直進	右折	直進	右折
飽和交通流率の基本値 S B	1646	1705	1400	1533	1400	1525	1544	
車線幅員による補正率 α w	1.000 (5.10)	1.000 (3.60)	1.000 (3.60)	1.000 (3.60)	1.000 (3.60)	1.000 (3.60)	1.000 (3.60)	
縦断勾配による補正率 α G	1.000 (0.00)	1.000 (0.00)	1.000 (0.00)	1.000 (0.00)	1.000 (0.00)	1.000 (0.00)	1.000 (0.00)	
総断勾配による補正率 (純断勾配) %	0.935 (10.00)	0.909 (14.38)	0.909 (15.99)	0.899 (15.99)	0.994 (0.79)	0.962 (5.64)	0.980 (2.96)	
大型車混入による補正率 (大型車混入率) %								
左折車混入による補正率 α L T								
(左折率) L %								
(歩行者による低減率) f p								
(有効青時間) 秒								
(歩行者用青時間) 秒								
横断歩行者による補正率 α L	1.000							
右折車混入による補正率 α R T	1.000 (18.0)							
(右折率) R %	1.000							
(右折車の通過確率) f	20							
(有効青時間) 秒								
(現示変り目のさげ台数増分) KER; 台/サイクル (交差点内滞留台数) K; 台/サイクル	2(68)							
飽和交通流率 S A	1539	1439	1533	1392	1467	1513		
設計交通量 q	100 (82+18)	306	469	126	195	169		
右折補正交通量 q R - N								
流入部の需要率 必要現示率	ρ	0.065	0.306	0.091	0.133	0.112	0.091	0.610
1 φ	0.065			0.091			0.091	0.610
2 φ		0.213			0.133			0.213
3 φ			0.306			0.112		0.306
1 φ	20			20				105
2 φ		27			27			
3 φ			40			40		
信号青時間比 G/C	20/105	27/105	40/105	20/105	27/105	40/105		
可能交通容量 C 1	293	370	584	265	377	576		
交通容量比 q/C 1	0.341	0.827	0.803	0.475	0.517	0.293		

$$N = K \times \frac{3600}{C}$$

N : 実1時間現示変化時右折車の捌け台数

* : 交通容量 (実1時間)

現示方式の図示

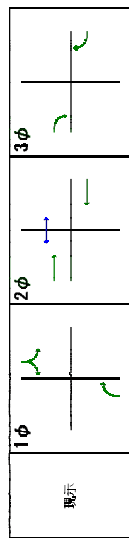

- ①: 至 横浜町田 IC
- ②: 至 つきみ野
- ③: 至 下川井 IC
- ④: 至 鶴ヶ峰

工事中交差点検討資料

工事中 (休日) 地域社会4 滝沢 17:00~18:00 の需要率の算出

交差点概略図

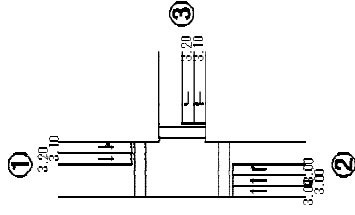

交通量図

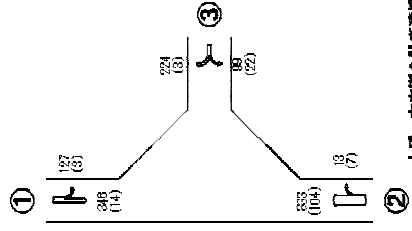

流入部 車線の種類	①		②		③		
	左折・直進	直進	直進	右折	左折・右折	右折	
車線数	1	2	1	1	1	1	
飽和交通流量の基本値 S B	1545	1545	1545	1800	1428	1428	
車線幅員による補正率 α w	1.000 (3.10)	1.000 (3.20)	1.000 (3.20)	1.000 (3.00)	1.000 (3.10)	1.000 (3.20)	
縦断勾配による補正率 α G	1.000 (0.00)	1.000 (0.00)	1.000 (0.00)	1.000 (0.00)	1.000 (0.00)	1.000 (0.00)	
大型車混入による補正率 α T (大型車混入率)	0.978 (3.14)	0.972 (4.05)	0.920 (12.48)	0.726 (53.85)	0.865 (22.22)	0.991 (1.34)	
左折車混入による補正率 α L T (左折率)	0.894 (53.7)						
(歩行者による低減率) L %	0.12				0.12		
(有効青時間) f p	51				37		
(歩行者用青時間) 秒	42				28		
横断歩行者による補正率 α L					0.909		
右折車混入による補正率 α R T (右折率)	1.000 (0.0)				1.000 (0.0)		
(右折車の通過確率) R %	0.693				0.693		
(有効青時間) f	54				37		
(現示変り目のさばり台数増分) KER : 台/サイクル (交差点内滞留台数) K : 台/サイクル	1 (32)				1 (32)		
飽和交通流量 S A	1351	1502	2784	1307	1123	1415	
設計交通量 q	473 (127+346)	833	13	99 (99+0)	224		
右折補正交通量 q R - N				0			
流入部の需要率 必要現示率	ρ	0.166	0.299	0.000	0.088	0.158	
1 φ	0.166	0.260	0.039	0.000	0.039	0.457	
2 φ							
3 φ							
有効青時間(秒)	1 φ	51	54	8	0.088	0.158	
2 φ							
3 φ							
青劣時間比 G / C	51/110	62/110	8/110	37/110	37/110	37/110	
可能交通容量 C i	1323	1569	513	378	476		
交通容量比 q / C i	0.358	0.531	0.025	0.262	0.471		
現示の 需要率							0.260
交差点の 需要率							0.457
サイクル長(秒)							110

※ $N = K \times \frac{3600}{C}$

N : 実1時間現示変化時右折車の捌け台数

※ * : 交通容量(実1時間)

※ *** : 連続現示での使用現示

①: 至 十日市場駅

②: 至 瀬谷駅

③:

現示方式の図示

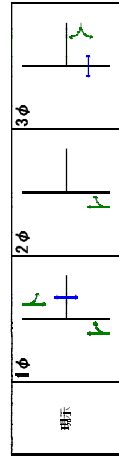

交差点概略図

工事中(休日) 地域社会 4 瀬谷土橋公園入口 17:00~18:00の需要率の算出

車線の種類	①		②		③	
	左折車線	直進車線	左折車線	直進車線	左折車線	直進車線
車線の本数	1	1	1	1	1	1
緩和交通流量の基本値	S B	1643	1514	1506	1800	1604
車線幅員による補正率	α w	1.000	1.000	1.000	1.000	1.000
(車線幅員)	m	(3.20)	(3.20)	(3.20)	(3.20)	(3.60)
縦断勾配による補正率	α G	1.000	1.000	1.000	1.000	1.000
(縦断勾配)	%	(0.00)	(0.00)	(0.00)	(0.00)	(0.00)
大型車混入による補正率	α T	0.937	0.970	0.884	0.932	1.000
(大型車混入率)	%	(9.68)	(16.93)	(10.42)	(0.00)	(2.65)
左折車混入による補正率	α L T	0.938				
(左折率)	L %	(32.9)				
(歩行者による低減率)	f p	0.12				
(有効青時間)	f	秒	43			
(有効青時間)	f	秒	31			
機形法による補正率	α L					
右折車混入による補正率	α R					
(右折率)	R %					0.326
(左折車の通過率)	R ₁					
(右折車の通過率)	R ₂					
(有効青時間)	f					
(現在残り目のきはけ台数増分)	KER					
(交差点内滞留台数)	K					
緩和交通流量	S A	1444	1594	2708	1404	1667
設計交通量	q	413	626	48	27	226
右折補正交通量	q R-N					
流入部の需要率	ρ	0.136	0.231	0.034	0.016	0.143
必要現示率	1 φ	0.136	0.188	0.034	0.034	0.188
	2 φ		0.043	0.034	0.016	0.043
有効青時間(秒)	3 φ	43	48	11	11	48
	4 φ					
	5 φ					
	6 φ					
信号機時間比	G/C	49/100	59/100	11/100	1/100	1/100
車線交通量	C 1	130	159	15	17	48
交通容量比	q / C 1	0.316	0.392	0.312	0.652	0.463

※ $N = K \times \frac{3600}{C}$

※ N : 1時間現示変化時右折車の捌け台数

※ * : 交通容量(実1時間)

※ **** : 連続現示での使用現示

①: 至 十日市駅

②: 至 瀬谷駅

③:

現示方式の図示

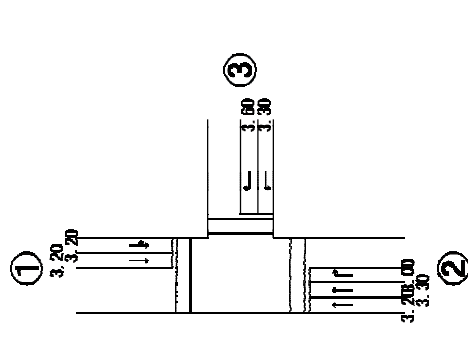
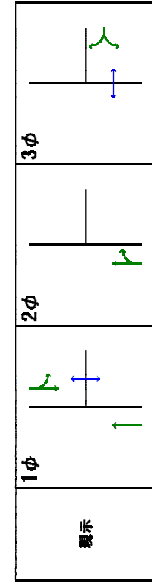

交通量図

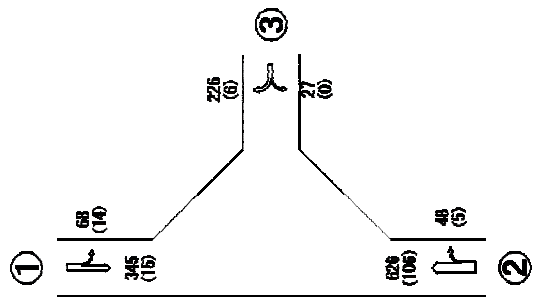

上段: 方向別合計交通量(台)
下段: 大型車混入台数(台)

供用時平日交差点検討資料

交差点概略図

供用時平日 地域社会1 目黒 17:00~18:00の需要率の算出

流入部 車線の種類 車線数	①		②		③		④	
	左折・直進	右折	左折・直進	右折	左折・直進	右折	左折・直進	右折
総和交通流率の基本値 SB/2000	1.800	1.800	1.800	1.800	1.800	1.800	1.800	1.800
車線員による補正率 (車線員)	αw (2.70)	1.000 (2.90)	1.000 (3.20)	1.000 (3.00)	1.000 (3.00)	1.000 (3.10)	1.000 (3.20)	1.000 (3.10)
総断面配による補正率 (総断面配)	αG (0.00)	1.000 (0.00)	1.000 (0.00)	1.000 (0.00)	1.000 (0.00)	1.000 (0.00)	1.000 (0.00)	1.000 (0.00)
大型車混入による補正率 (大型車混入率)	αT (27.84)	0.837 (21.00)	0.804 (15.17)	0.822 (31.00)	0.790 (38.00)	0.819 (31.48)	0.822 (31.00)	0.822 (31.00)
右折車混入による補正率 αLT (歩行者による低減率) (有効青時間) 秒 (歩行者用青時間) 秒 視距歩行者による補正率 αL	L% (53.8) f p 0.15 46 41	0.873 (91.6) 0.15 75 70	0.796 (91.6) 0.15 68 63	0.796 (91.6) 0.15 68 63	0.811 (83.0) 0.15 75 70	0.811 (83.0) 0.15 75 70	0.811 (83.0) 0.15 75 70	0.811 (83.0) 0.15 75 70
右折車混入による補正率 αRT (右折率) R% (右折車の通過確率) f (有効青時間) 秒 (視距歩行者によるさげ台数増分) KER、台/サイクル (交差点内滞留台数) K:台/サイクル	ρ 1φ 2φ 3φ 4φ	0.210 0.207 0.355 0.355	0.893 46 2(45)	0.972 75 2(45)	0.419 0.069	0.872 46 2(45)	0.419 0.069	0.101 0.101
右折補正交通量 qR-N	0	0	0	0	0	0	0	0
交差点流入部の需要率 必要現示率	ρ 1φ 2φ 3φ 4φ	0.210 0.207 0.355 0.355	0.207 0.355 0.355	0.447 0.447	0.419 0.069	0.447 0.447	0.045 0.045	0.133 0.133
有効青時間(秒)	1φ 2φ 3φ 4φ	75 75 75 75	75 75 75 75	75 75 75 75	75 75 75 75	75 75 75 75	75 75 75 75	75 75 75 75
信号青時間比 G/C	6/160	6/160	6/160	6/160	6/160	6/160	6/160	6/160
可能交通容量 C i	389	447	675	912	520	473	623	898
交通容量比 q/C i	0.732	0.727	0.757	0.725	0.987	0.239	0.166	0.167
現示の 必要率	0.355	0.355	0.355	0.355	0.355	0.355	0.355	0.355
交差点の 必要率	0.774	0.774	0.774	0.774	0.774	0.774	0.774	0.774
サイクル長(秒)	160	160	160	160	160	160	160	160

※ N = K × 3600 / C

N : 実1時間現示変化時右折車の捌け台数

※ * : 交通容量 (実1時間)

※ **** : 連続現示での使用現示

※ : 交通容量、流入部の需要率を車線ごとに算出する方法は「改訂 平面交差の計画と設計」基礎編 第3版に準拠していません。

- ①: 至 つきみ野
- ②: 至 海老名
- ③: 至 鶴ヶ峰
- ④: 至 青葉台駅

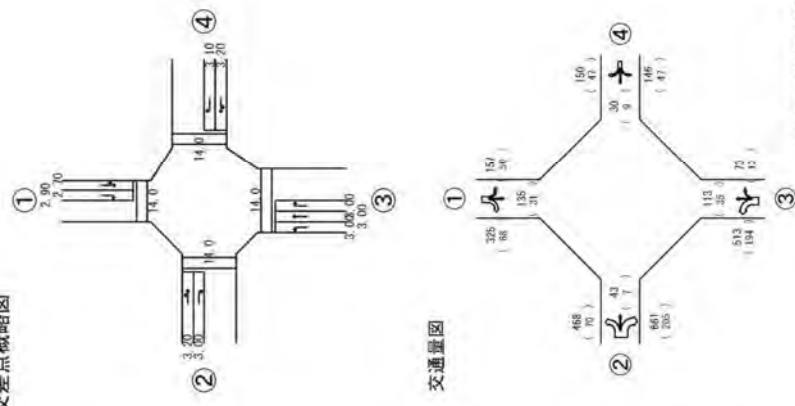

上段 方向別合計交通量[台/時]
下段 大型車混入台数[台/時]

現示方式の図示

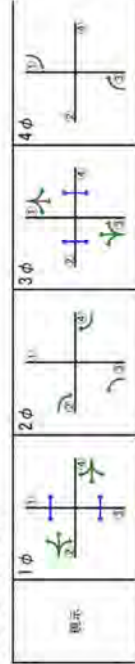

供用時平日交差点検討資料

供用時平日 地域社会 2 目黒交番前 17:00~18:00 の需要率の算出

流入部	①		②		③		④		右折	直進	左折	直進	右折	直進	左折	直進	右折
	左折	直進	左折	直進	左折	直進	左折	直進									
車線数	1	1	1	1	1	1	1	1	1	1	1	1	1	1	1	1	1
車線幅員	2000	2000	2000	2000	2000	2000	2000	2000	1800	2000	2000	2000	1800	2000	2000	1800	1800
飽和交通流率の基本値	S B																
車線幅員による補正率	αw	1.000	1.000	1.000	1.000	1.000	1.000	1.000	1.000	1.000	1.000	1.000	1.000	1.000	1.000	1.000	1.000
(車線幅員)	m	(3.00)	(3.00)	(3.00)	(3.00)	(3.00)	(3.00)	(3.00)	(3.00)	(3.00)	(3.00)	(3.00)	(3.00)	(3.00)	(3.00)	(3.00)	(3.00)
縦断勾配による補正率	αG	1.000	1.000	1.000	1.000	1.000	1.000	1.000	1.000	1.000	1.000	1.000	1.000	1.000	1.000	1.000	1.000
(縦断勾配)	%	(0.00)	(0.00)	(0.00)	(0.00)	(0.00)	(0.00)	(0.00)	(0.00)	(0.00)	(0.00)	(0.00)	(0.00)	(0.00)	(0.00)	(0.00)	(0.00)
大型車混入による補正率	αT	0.878	0.859	0.775	0.770	0.779	0.894	0.917	0.905	0.905	0.899	0.817	0.798	0.798	0.951	0.951	0.951
(大型車混入率)	%	(19.61)	(23.46)	(41.66)	(42.57)	(40.66)	(16.87)	(12.85)	(16.08)	(16.08)	(16.00)	(32.07)	(36.02)	(36.02)	(7.41)	(7.41)	(7.41)
左折車混入による補正率	$\alpha L T$	0.833			0.848			0.907				0.910			0.910		
(左折率)	L %	(26.5)			(66.4)			(38.2)				(36.8)			(36.8)		
(歩行者による低減率)	L P	0.15			0.15			0.15			0.15			0.15			
(有効歩時間)	F	秒	44		50		44	39			50			50			
(歩行者費用時間)	F P	秒	39		45		39	45			45			45			
横断歩行者による補正率	αL																
右折車混入による補正率	$\alpha R T$																
(右折率)	R %																
(右折車の通過確率)	F																
(有効歩時間)	F																
(現示変り目のきはけ台数増分)																	
K B : 与/サイクル																	
(交差点内の歩者台数)																	
K : 与/サイクル																	
飽和交通流率	S A	1638	1718	1395	1306	1558	1809	1863	1810	1618	1487	1598	1712	1598	1487	1712	1712
設計交通量	q	393	231	587	623	119+504	166	823	517	95+422	81	39	39	39	39	39	39
(59+341)																	
右折補正交通量	q R - N																
流入部の需要率	p	0.117	0.166	0.205	0.179	0.179	0.077	0.179	0.179	0.015	0.168	0.179	0.023	0.179	0.168	0.023	0.168
必要現示率		0.117	0.166	0.205	0.179	0.179	0.077	0.179	0.179	0.015	0.168	0.179	0.023	0.179	0.168	0.023	0.168
1 φ																	
2 φ																	
3 φ																	
4 φ																	
有効歩時間(秒)		44	41	50	50	44	41	50	50	41	50	21	41	50	21	41	50
信号青時間比	G/C	44/170	41/170	50/170	50/170	44/170	41/170	50/170	50/170	41/170	50/170	21/170	41/170	50/170	21/170	41/170	50/170
可能交通容量	C I	869	335	842	842	869	335	842	842	869	335	842	842	869	335	842	842
交通容量比	q/C I	0.452	0.688	0.697	0.689	0.689	0.689	0.689	0.689	0.689	0.689	0.689	0.689	0.689	0.689	0.689	0.689

$$\text{※ } N = K \times \frac{3600}{C}$$

N : 実1時間現示変化時右折車の捌け台数

※ * : 交通容量 (第1時間)

- ①: 至 十日市場
- ②: 至 つぎみ野
- ③: 至 泉
- ④: 至 鶴ヶ峰

交差点概略図

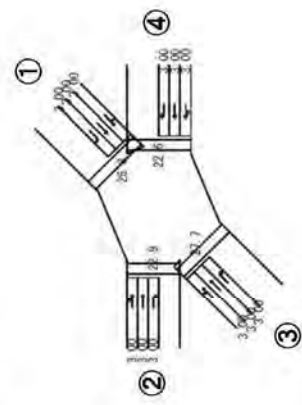

交通量図

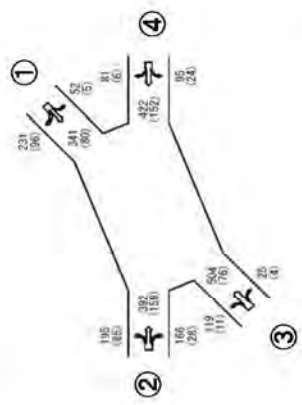

上段 方向別合計交通量 [台/時]
下段 (大型車混入台数) [台/時]

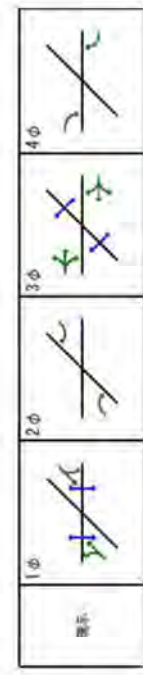

供用時平日交差点検討資料

供用時平日 地域社会4 滝沢 7:00~8:00 の需要率の算出

流入部	①		②		③	
	直進	左折・直進	直進	右折	左折・右折	右折
車種数	1	1	2	1	1	1
原形交通流量の基本値	SB	2000	2000	1800	1800	1800
車種構成による補正率	αw	1,000	1,000	1,000	1,000	1,000
(乗換係数)	m	(3.00)	(3.00)	(3.00)	(3.00)	(3.00)
種別転回による補正率	αG	1,000	1,000	1,000	1,000	1,000
(種別転回)	%	(0.00)	(0.00)	(0.00)	(0.00)	(0.00)
大型車混入による補正率	αT	0.911	0.958	0.858	1,000	0.847
(大型車混入率)	%	(13.91)	(23.72)	(23.43)	(0.00)	(25.78)
左折車混入による補正率	αLT	0.946				(17.67)
(左折率)	L%	(52.0)				
(歩行者による伝達率)	f p					0.15
(有効歩時間)	秒					29
(歩行者混入率)	秒					24
横断歩行者による補正率	αL					0.876
右折車混入による補正率	αRT					1,000
(右折率)	R%					(33.8)
(右折車の通過時間)	f					1,000
(有効歩時間)	秒					29
(頭車乗り目のさげ台数増分)	KER	各/サイクル				
(交差点内滞留台数)	K	各/サイクル				
飽和交通流量	SA	1724	1716	3432	1800	1336
設計交通量	q	1028	(207+759)	873	0	207
右折補正交通量	qR-N			0	(137+70)	213
交差点流入部の需要率	ρ	0.298		0.196	-	0.155
必要信号率	1φ	0.298		0.196		0.133
	2φ			****		
	3φ					
有効歩時間(秒)	1φ	55		57		0.155
	2φ			6		0.133
	3φ			6		100
信号青時間比	G/C	55/100		63/100	6/100	29/100
可能交通流量	C I	1892		2142	160	367
交通容量比	q/C I	0.542		0.311	0.000	0.585
						0.458

$N = K \times \frac{3600}{C}$

N : 実1時間現示変化時右折車の捌け台数

* : 交通容量 (実1時間)

*** : 連続現示での使用現示

①: 至 十日市場駅

②: 至 瀬谷駅

③:

交差点概略図

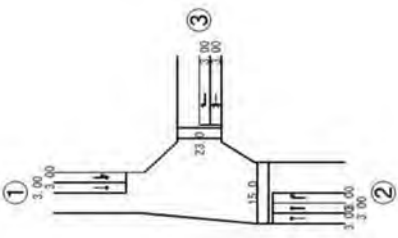

交通量図

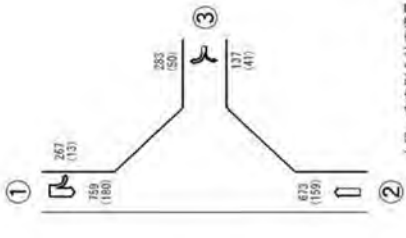

上段: 方向別合計交通量[台/時]
下段: (大型車混入台数)[台/時]

現示方式の図示



供用時平日交差点検討資料

供用時平日 地域社会4 瀬谷上総公園入口 18:00~19:00の需要率の算出

交差点概略図

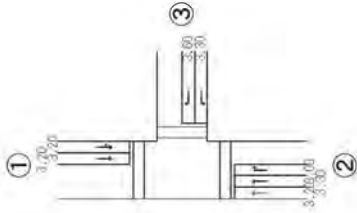

交通量図

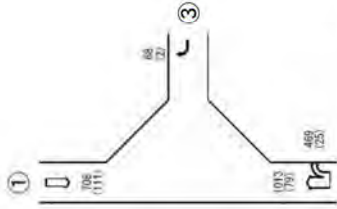

上段：方向別合計交通量[台/時]
下段：(大型車混入台数)[台/時]

交差点名	瀬谷上総公園交差点					
	① 流入部		②		③	
車線の種類	左折	直進	右折	直進	左折	右折
車線数	1	2	1	1	1	1
飽和交通流率の基本値 SB	2000	2000	1800	1800	1800	1800
車線幅員による補正率 αw	1.000	1.000	1.000	1.000	1.000	1.000
(車線幅員) m	(3.00)	(3.00)	(3.00)	(3.00)	(3.50)	(3.50)
縦断勾配による補正率 αG	1.000	1.000	1.000	1.000	1.000	1.000
(縦断勾配) %	(0.00)	(0.00)	(0.00)	(0.00)	(0.00)	(0.00)
大型車混入による補正率 αT	0.901	0.901	0.964	1.000	0.960	0.960
(大型車混入率) %	(15.68)	(15.68)	(7.80)	(5.33)	(0.00)	(2.94)
左折車混入による補正率 αLT	1.000					
(左折率) L%	(0.0)					
(非行者による低減率) f p	0.15				0.15	
(有効青時間) 秒	40				23	
横断歩行者による補正率 αL	35				18	
右折車混入による補正率 αRT						0.883
(右折率) R%						
(右折車の通過確率) f						
(有効赤時間) 秒 (現示変り) 目のさばけ台数増分) KER : 台/サイクル (交差点内滞留台数) K : 台/サイクル						
飽和交通流率 S A	1802	3792	1735	1569	1764	
設計交通量 q	708 (0+708)	1013	469	0	68	
右折補正交通量 α R-N						
交差点流入部の需要率 1 ϕ	0.196	0.267	0.270	-	0.039	交差点の需要率
必要現示率 2 ϕ	0.196	0.267	0.270		0.270	0.505
有効青時間(秒) 3 ϕ		****			0.196	0.196
1 ϕ		37			0.039	0.039
2 ϕ		40				0.039
3 ϕ						110
信号青時間比 G/C	40/110	77/110	37/110	23/110	23/110	23/110
可能交通容量 C i	1311	2654	584	332	369	
交通容量比 q/C i	0.540	0.382	0.803	0.000	0.184	

* N = K × $\frac{3600}{C}$

N : 実1時間現示変化時右折車の捌け台数

* : 交通容量 (実1時間)

* : 連続現示での使用現示

①: 至 十日市場駅

②: 至 瀬谷駅

③:

現示方式の図示

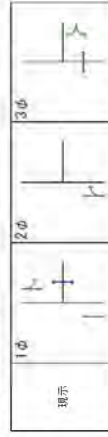

供用時平日交差点検討資料

供用時平日 地域社会6 瀬谷中学校前 7:00~8:00の需要率の算出

交差点概略図

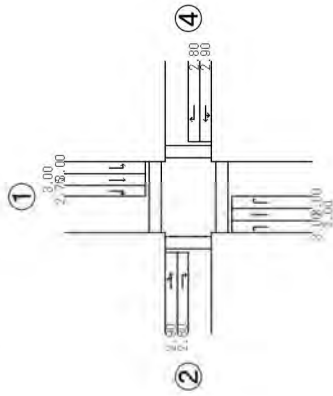

交通量図

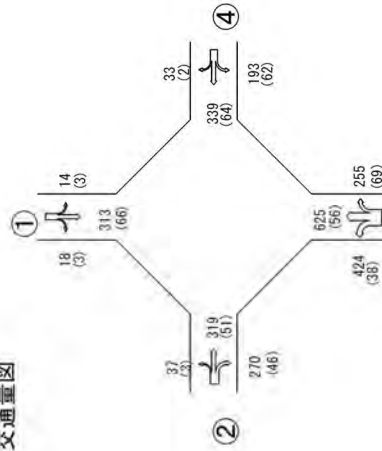

上段：方向別合計交通量(台)
下段：(大型車混入台数)[台/時]

流人の種類 車線数	①		②		③		④		
	左折	右折	左折	右折	左折	右折	左折	右折	
飽和交通流率の基本値	1800	1800	2000	1800	1800	2000	1800	1800	
車線幅員による補正率 αw	1.000	1.000	0.950	1.000	1.000	1.000	0.950	1.000	
(車線幅員)	(3.00)	(2.75)	(2.90)	(3.00)	(3.00)	(3.00)	(2.90)	(2.80)	
縦断勾配による補正率 αG	1.000	1.000	1.000	1.000	1.000	1.000	1.000	1.000	
(縦断勾配)	(0.00)	(0.00)	(0.00)	(0.00)	(0.00)	(0.00)	(0.00)	(0.00)	
大型車混入による補正率 αT	0.883	0.872	0.905	0.894	0.894	0.941	0.888	0.900	
(大型車混入率)	(19.00)	(21.00)	(15.06)	(17.00)	(17.00)	(9.00)	(23.72)	(6.00)	
左折車混入による補正率 αLT			0.969				0.895		
(左折率)			(10.4)				(36.3)		
(歩行者による低減率) I P	0.50	0.529	0.50	0.699	0.50	0.720	0.715	0.35	
(有効青時間)	36	36	33	33	36	36	33	33	
(歩行者用青時間)	25	2(72)	20	2(72)	25	2(72)	20	2(72)	
横断歩行者による補正率 αL	0.653				0.653				
右折車混入による補正率 αRT									
(右折率)									
(右折車の通過確率) I R									
(有効青時間)									
(現示変り目のさげ台数増分)									
KER：台/サイクル									
(交差点内滞留台数)									
K：台/サイクル									
飽和交通流率	S A	1038	1744	1640	1699	1106	1882	1514	1728
設計交通量	q	14	313	18	270	424	625	455	33
右折補正交通量	q R-N			0	0				0
流入部の需要率	ρ	0.013	0.179	0.000	0.000	0.383	0.332	0.000	0.000
必要現示率	1 φ	0.013	0.179			0.383	0.332		
2 φ									
3 φ									
4 φ									
有効青時間(秒)	1 φ	40	40			40	40		
2 φ									
3 φ									
4 φ									
信号青時間比	G/C	40/100	40/100	5/100	5/100	40/100	40/100	5/100	5/100
可能交通容量	C i	415	698	214	369	412	753	411	169
交通容量比	q/C i	0.034	0.448	0.084	0.731	0.959	0.830	0.620	0.084

* N = K × $\frac{3600}{C}$

N：実1時間現示変化時右折車の捌け台数

*：交通容量(表1時間)

- ①：至 十日市場
- ②：至 国道246号
- ③：至 泉
- ④：至 瀬谷小学校

現示方式の図示

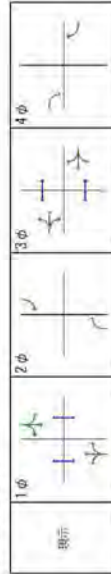

供用時平日 交差点検討資料

供用時平日 地域社会 8 8:00~9:00 の需要率の算出

流車線の種類	① 直進		② 右折		③ 左折・直進	
	l	1	l	1	l	1
総和交通流量の基値	2000	1800	1800	1800	2000	2000
車線幅員による補正率	α _w	1.000 (3.25)	1.000 (3.00)	1.000 (3.25)	1.000 (3.00)	1.000 (3.00)
縦断勾配による補正率	α _G	1.000 (0.00)	1.000 (0.00)	1.000 (0.00)	1.000 (0.00)	1.000 (0.00)
大型車混入による補正率	α _T	0.840 (27.27)	0.588 (96.00)	1.000 (0.00)	1.000 (0.00)	1.000 (0.00)
左折車混入による補正率	α _L				1.000 (0.0)	1.000 (0.0)
(左折率)	L %			0.50		0.50
(歩行者による低減率)	F p			30		52
(有効青時間)	f			25		47
(歩行者出青時間)	α _L			0.583		
横断歩行者による補正率	α _L					
右折車混入による補正率	α _R					
(右折率)	R %		0.899			
(右折車の通過確率)	f		52			
(有効青時間)	f					
(現示変更日目のさげ台数増分)	KDR		2(80)			
K: 台/サイクル						
(交差点内滞留台数)	K					
K: 台/サイクル						
飽和交通流量	S A	1680	*616	1049	1800	2000
設計交通量	q	11	25	32	6	106 (0+106)
右折補正交通量	q R = N					
流入部の需要率	φ	0.007	—	0.031	0.003	0.053
必要現示率	1 φ	0.007	—	—	—	0.053
	2 φ			0.031	0.003	0.031
有効青時間(秒)	1 φ	52	52	30	30	52
	2 φ			30	30	52/ 90
信号青時間比	G / C	52 / 90	52 / 90	30 / 90	30 / 90	52 / 90
可能交通容量	C i	971	616	350	600	1156
交通容量比	q / C i	0.011	0.041	0.091	0.010	0.092

$$N = KEB \times \frac{3600}{C}$$

N : 1 時間以内右折車が交差点内に滞留する台数
 K : 交通容量 (実1時間)

現示方式の図示

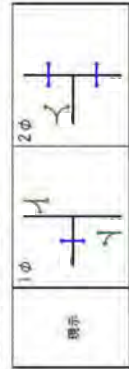

- ① : 至 八王子街道
- ② : 至 環状 4 号線
- ③ : 至 細谷戸ハイッ

交差点概略図

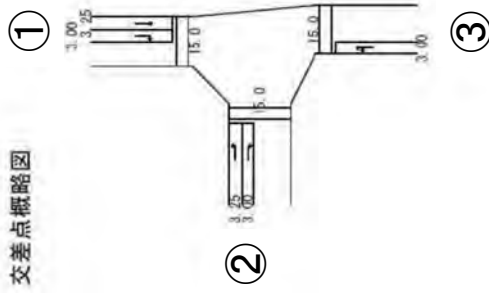

交通量図

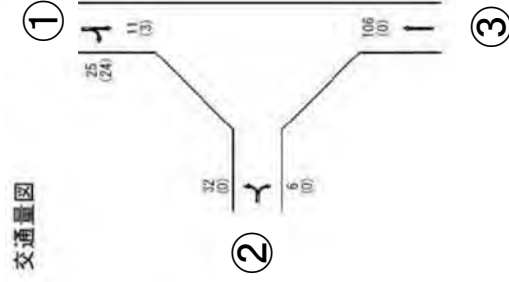

上段 : 方向別合計交通量 [台/時]
 下段 : (大型車混入台数) [台/時]

供用時平日交差点検討資料

供用時平日 地域社会 9 7:00~8:00 の需要率の算出

車線の種類	①		②		③		④	
	左折・直進	右折	左折・直進	右折	左折・直進	右折	左折・直進	右折
重線数	2000	1800	2000	1800	2000	1800	2000	1800
飽和交通流量の基本値 S/B	1,000	1,000	1,000	1,000	1,000	1,000	1,000	1,000
市街幅員による補正率 α w	(3.00)	(3.00)	(3.00)	(3.00)	(3.00)	(3.00)	(3.00)	(3.00)
市街幅員による補正率 α m	1,000	1,000	1,000	1,000	1,000	1,000	1,000	1,000
縦断勾配による補正率 α G	(0.00)	(0.00)	(0.00)	(0.00)	(0.00)	(0.00)	(0.00)	(0.00)
縦断勾配による補正率 α G	(0.00)	(0.00)	(0.00)	(0.00)	(0.00)	(0.00)	(0.00)	(0.00)
大型車混入による補正率 α T	0.923	1.000	0.785	0.980	0.952	0.980	0.791	0.968
(大型車混入率)	(11.88)	(0.00)	(394.04)	(2.91)	(7.13)	(0.00)	(37.69)	(4.65)
左折車混入による補正率 α L	0.936	1.000	1.000	1.000	0.749	1.000	1.000	1.000
(左折率)	(6.6)	(0.0)	(0.0)	(32.5)	(0.0)	(0.0)	(0.0)	(0.0)
歩行者による低減率 β	0.50	0.50	0.50	0.50	0.50	0.50	0.50	0.50
(歩行者用青時間)	58	33	33	58	58	33	33	58
(歩行者用青時間)	53	28	28	53	53	28	28	53
横断歩行者による補正率 α R	1.000	1.000	1.000	1.000	1.000	1.000	1.000	1.000
横断歩行者による補正率 α R	1.000	1.000	1.000	1.000	1.000	1.000	1.000	1.000
右折車混入による補正率 α R	1.000	1.000	1.000	1.000	1.000	1.000	1.000	1.000
(右折率)	(0.0)	(0.0)	(0.0)	(0.0)	(0.0)	(0.0)	(0.0)	(0.0)
右折車混入による補正率 α R	1.000	1.000	1.000	1.000	1.000	1.000	1.000	1.000
(右折車の通過確率)	(0.0)	(0.0)	(0.0)	(0.0)	(0.0)	(0.0)	(0.0)	(0.0)
(右折車の通過確率)	(0.0)	(0.0)	(0.0)	(0.0)	(0.0)	(0.0)	(0.0)	(0.0)
(有効青時間) 秒	58	33	33	58	58	33	33	58
(有効青時間)	53	28	28	53	53	28	28	53
(表示変り口のさげ上げ増分)								
KER: 台/サイクル								
(交差点内部留台数)								
K: 台/サイクル								
飽和交通流量 S/A	1782	*505	1570	1764	1426	1582	1582	1742
設計交通量 q	303	0	292	170	547	321	321	43
(20*283)			(0*292)		(178*369)		(0*321)	
右折補正交通量 q R-N				110				0
流入部の需要率	0.175	-	0.186	0.062	0.384	-	0.203	-
必要表示率	1 φ		0.186		0.384		0.203	
	2 φ							
	3 φ							
有効青時間(秒)	1 φ		33		0.384		33	
	2 φ			19				19
	3 φ		58		58		58	
信号青時間比 G/C	58/120	33/120	33/120	19/120	58/120	33/120	33/120	19/120
可能交通容量 C/I	835	505	432	339	689	435	435	336
交通容量比 q/C_i	0.363	0.000	0.676	0.501	0.791	0.000	0.788	0.128

$$q \cdot N = KER \cdot \frac{3600}{C}$$

N : 1時間で行新車が交差点内に滞留する台数

※ * : 交通容量 (歩1時間)

- ① : 至 対象事業実施区域
- ② : 至 環状 4 号線
- ③ : 至 二ツ上橋交差点
- ④ : 至 中原街道

表示方式の図示

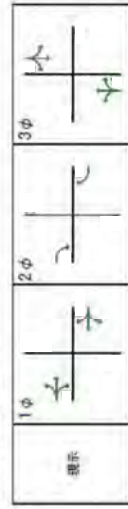

交差点概略図

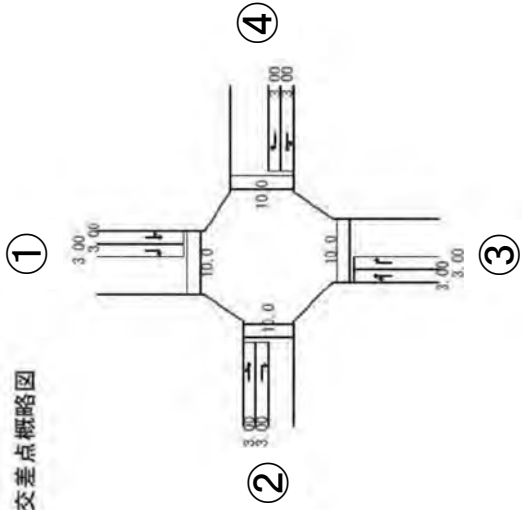

交通量図

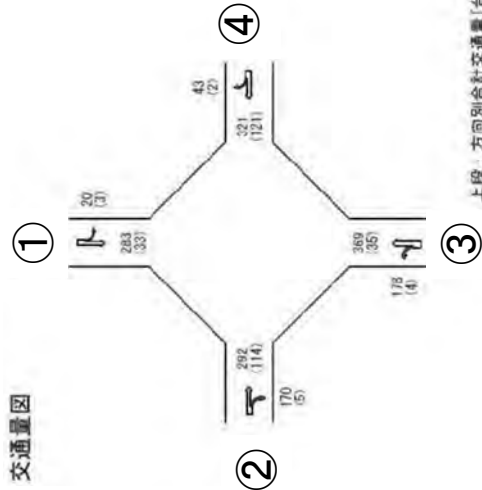

上段: 方向別合計交通量 [台/時]
下段: (大型車混入台数) [台/時]

供用時休日交差点検討資料

供用時休日 地域社会 1 目黒 19:00~20:00 の需要量の算出

流入部	①		②		③		④	
	左折・直進	右折	左折・直進	右折	左折	右折	左折・直進	右折
車線数	1	1	1	1	1	1	1	1
車線数	2000	1800	2000	1800	1800	2000	2000	1800
飽和交通流率の基本値	S _B 2000	1800	2000	1800	1800	2000	2000	1800
車線幅員による補正率	α _w	1.000	1.000	1.000	1.000	1.000	1.000	1.000
(車線幅員)	m	(2.70)	(3.20)	(3.20)	(3.00)	(3.20)	(3.20)	(3.10)
車線幅員による補正率	α _G	1.000	1.000	1.000	1.000	1.000	1.000	1.000
(車線幅員)	%	(0.00)	(0.00)	(0.00)	(0.00)	(0.00)	(0.00)	(0.00)
総断勾配による補正率	α _T	0.837	0.872	0.904	0.822	0.786	0.826	0.819
(大型車混入率)	%	(27.84)	(15.17)	(31.00)	(39.00)	(30.00)	(31.50)	(31.00)
左折車混入による補正率	α _L	0.873	0.796	0.796	0.811	0.811	0.811	0.811
(左折率)	L %	(53.8)	(91.6)	(83.2)	(83.2)	(83.2)	(83.2)	(83.2)
(歩行者による低減率)	f _p	0.15	0.15	0.15	0.15	0.15	0.15	0.15
(歩行者用青時間)	秒	46	78	65	65	78	78	78
(歩行者用青時間)	秒	41	73	60	60	73	73	73
横断歩行者による補正率	α _L							
右折車混入による補正率	α _R	0.895	0.895	0.895	0.895	0.895	0.895	0.895
(右折率)	R %	(46)	(46)	(46)	(46)	(46)	(46)	(46)
(右折車の通過確率)	f	2.45	2.45	2.45	2.45	2.45	2.45	2.45
(有効青時間)	秒							
(現示要り目のさばり台数増分)	K _{ER}	台/サイクル						
(交差点内滞留台数)	K	台/サイクル						
飽和交通流率	S _A	1388	1570	1439	1480	1220	1652	1328
設計交通量	q	277	306	486	628	479	111	167
(149+128)				(445+41)			(139+28)	143
右折補正交通量	q _{R-N}	0	0	0	0	0	0	0
交差点流入部の必要率	ρ	0.200	0.197	0.338	0.474	0.383	0.067	0.126
必要現示率	1 φ							0.097
2 φ								0.126
3 φ								0.097
4 φ								0.000
有効青時間(秒)	1 φ							サイクル長(秒)
2 φ								160
3 φ								
4 φ								
信号青時間比	G/C	46/160	70/160	19/160	19/160	65/160	46/160	78/160
可能交通容量	C _i	399	446	702	912	495	475	647
交通容量比	q/C _i	0.694	0.688	0.689	0.689	0.968	0.234	0.258

※ $N = K \times \frac{3600}{C}$

N : 実1時間現示変化時右折車の捌け台数

※ * : 交通容量 (実1時間)

※ **** : 連続現示での使用現示

※ 交通容量、流入部の必要率を車線ごとに表示する方法は「改訂 平面交差点の計画と設計」基礎編 第3版に準拠していません。

- ①: 至 つきみ野
- ②: 至 海老名
- ③: 至 鶴ヶ峰
- ④: 至 青葉台駅

交差点概略図

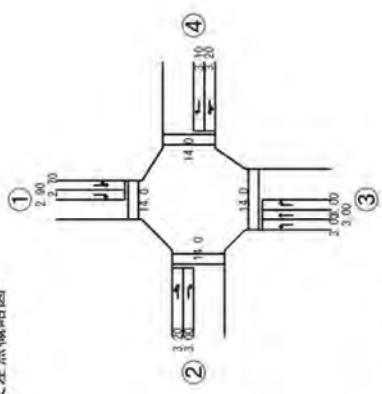

交通量図

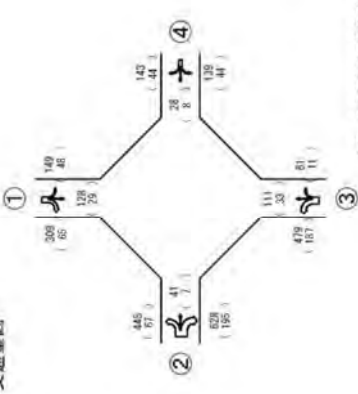

上段、方向別合計交通量[台/時]
下段、大型車混入台数[台/時]

現示方式の図示

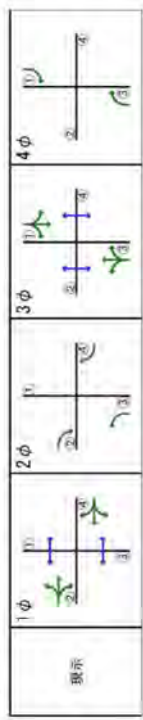

供用時休日交差点検討資料

使用時休日 地域社会 2 目黒交番前 17:00~18:00 の需要率の算出

流車線の種類	①		②		③		④	
	左折・直進	右折	左折・直進	右折	左折・直進	右折	左折・直進	右折
流車線の種別	1	1	1	1	1	1	1	1
流車線の種別	1	1	1	1	1	1	1	1
緩和交通流の基本値	2000	1800	2000	1800	2000	1800	2000	1800
αw (車輛係数)	1.000	1.000	1.000	1.000	1.000	1.000	1.000	1.000
αG (緩和率)	1.000	1.000	1.000	1.000	1.000	1.000	1.000	1.000
αT (緩和率)	0.881	0.775	0.771	0.780	0.829	0.919	0.896	0.821
αLT (大型車混入率)	0.893	(23.02)	(41.46)	(40.18)	(10.83)	(12.62)	(18.67)	(31.20)
αLT (左折率)	0.849				0.908			0.915
L% (歩行者による低減率)	(26.8)				(38.3)			(34.6)
f (有効青時間)	0.15				0.15			0.15
Fp (歩行者用青時間)	50				50			48
αLT (撮影走行者による補正率)	46				45			43
R% (右折車の通過確率)								
f (有効青時間)								
KRR (当/サイクル)								
K (交差点の青時間係数)								
K (当/サイクル)								
設計交通量	SA	1644	1722	1366	1309	1660	1616	1683
設計交通量	q	336	494	193	494	141	141	687
設計交通量	q	(45+291)	(168+331)			(122+616)		(73+349)
右折補正交通量	qR-N			99				
流入部の需要率	p	0.100	0.172	0.138	0.172	0.181	0.181	0.181
必要現示率	1φ	0.100	0.138	0.138	0.138	0.138	0.138	0.138
必要現示率	2φ							
必要現示率	3φ							
必要現示率	4φ							
有効青時間(秒)	1φ	50		38		50	38	48
有効青時間(秒)	2φ							
有効青時間(秒)	3φ							
有効青時間(秒)	4φ							
信号青時間比	G/C	50/170	48/170	38/170	48/170	50/170	48/170	48/170
可能交通容量	C1	990	812	232	1036	361	876	247
交通容量比	q/C1	0.339	0.619	0.608	0.615	0.482	0.666	0.332
現示の需要率								
現示の需要率								
現示の需要率								
現示の需要率								
サイタル長(秒)		170						
交差点の需要率								
交差点の需要率								
交差点の需要率								
交差点の需要率								

$$N = K \times \frac{3600}{C}$$

N : 実1時間現示変化時右折車の捌け台数

※ * : 交通容量 (実1時間)

- ①: 至 十日市場
- ②: 至 つきみ野
- ③: 至 泉
- ④: 至 鶴ヶ崎

現示方式の図示

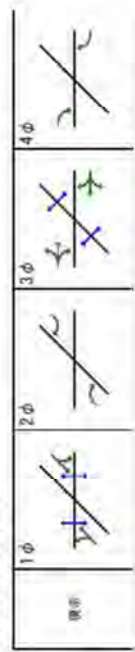

交差点概略図

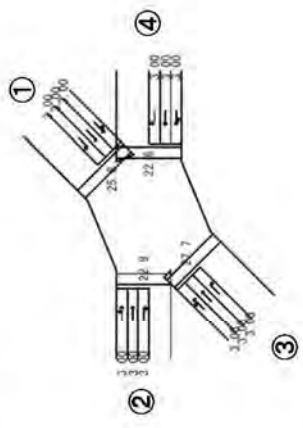

交通量図



上段 方向別社会交通量 [台/時]
下段 (大型車混入台数) [台/時]

供用時休日交差点検討資料

供用時休日 地域社会 3 上川井 IC 8:00~9:00の需要率の算出

算入部	①		②		③		④	
	右折	左折・右折	右折	左折・右折	右折	左折・右折	右折	左折・右折
算 額	1	1	1	1	1	1	1	1
熟知交通標準の基本値 S B	1800	1800	1800	1800	1800	1800	1800	1800
乗務員による補正率 α w	1,000	1,000	1,000	1,000	1,000	1,000	1,000	1,000
(乗務員) m	(3,00)	(3,00)	(3,00)	(3,00)	(3,00)	(3,00)	(3,00)	(3,00)
視界勾配による補正率 α G	1,000	1,000	1,000	1,000	1,000	1,000	1,000	1,000
(視界勾配) %	(0,00)	(0,00)	(0,00)	(0,00)	(0,00)	(0,00)	(0,00)	(0,00)
大型車混入による補正率 T	0,966	0,966	0,909	0,786	0,870	0,946	0,952	0,913
(大型車混入率) %	(5,08)	(1,27)	(10,71)	(36,16)	(21,38)	(7,78)	(7,27)	(13,60)
右折車混入による補正率 α L T								
(左折車) L %								
(歩行者による低減率) F P								
(有効歩時間) 秒								
(歩行者用歩時間) 秒								
横断歩行者による補正率 α L	1,000							
右折車混入による補正率 α R T	1,000							
(右折車) R %	(78,7)							
(右折車の通過標準) t	1,000							
(有効歩時間) 秒	53							
(表示変更り目のさげ付増加分) KER : 台/サイクル	2(65)							
(交差点内滞留台数) K : 台/サイクル								
熟知交通標準 S A	1789	*1674	3636	1436	*1566	1703	*1706	1643
既計交通量 q	628	641	70	307	477	99	90	165
右折補正交通量 q R-N								
交差点混入車の需要率 ρ	0,361	0,359	-	0,019	0,214	-	0,058	0,076
必要歩数	1 φ			0,019			0,087	0,087
	2 φ						0,214	0,214
	3 φ							0,361
有効歩時間(秒)	1 φ							
	2 φ							
	3 φ							
歩行時間(秒)	53	53	30	53	53	53	30	110
歩行時間比 G/C	53/110	110/110	12/110	90/110	110/110	53/110	110/110	30/110
可能交通容量 C I	838	860	1674	392	1566	821	1706	448
交通容量比 q/C I	0,749	0,745	0,134	0,176	0,783	0,305	0,121	0,279

$$\ast N = K \times \frac{3600}{C}$$

N : 実 1 時間現示変化時右折車の捌け台数

※ * : 交通容量 (実 1 時間)

- ①: 至 横浜町田 IC
- ②: 至 つきみ野
- ③: 至 下川井 IC
- ④: 至 鎌ヶ峰

交差点概略図

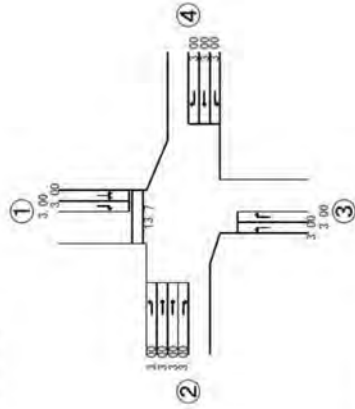

交通量図

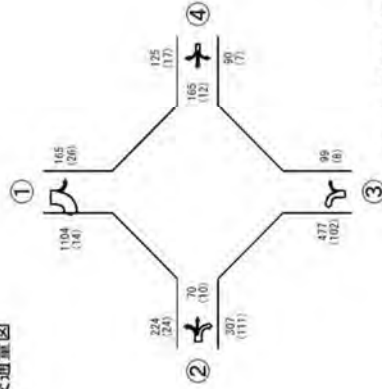

上段: 方向別合計交通量 [台/時]
下段: (大型車混入台数) [台/時]

現示方式の図示 ※ 破線矢印は「左折可」標識を示す

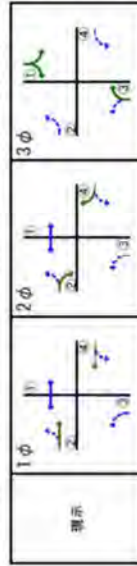

供用時休日交差点検討資料

供用時休日 地域社会4 滝沢 16:00~17:00 の需要率の算出

交差点名	① 滝沢交差点		②		③	
	流入部	流出部	左折	直進	右折	右折
車線数	1	1	1	2	1	1
原形交通流量の標準値	SB 2000	2000	1800	1800	1800	1800
車線幅員による補正率	αw (3.00)	1,000 (3.00)	1,000 (3.00)	1,000 (3.00)	1,000 (3.00)	1,000 (3.00)
縦断勾配による補正率	αG (0.00)	1,000 (0.00)	1,000 (0.00)	1,000 (0.00)	1,000 (0.00)	1,000 (0.00)
大型車混入による補正率	αT (4.81)	0.987 (6.67)	0.985 (6.67)	0.985 (6.67)	0.985 (6.67)	0.987 (6.67)
左折車混入による補正率	αLT (54.7)	0.943 (54.7)	0.943 (54.7)	0.943 (54.7)	0.943 (54.7)	0.943 (54.7)
(歩行者による削減率)	LP					0.15
(有効青時間)	IP					29
(歩行者両側歩道)	IP					24
横断歩行者による補正率	αL					0.976
右折車混入による補正率	αRT				2.72	1,000 (43.1)
(右折率)	R%					1,000
(右折車の通過確率)	f					29
(有効青時間)	I					2.72
(環状交差点)目的のさばり台数増分)	KER					
KER: 右/サイクル						
(交差点内滞留台数)	K, α/サイクル					
飽和交通流量	SA 1824	1886	1800	3520	1451	1741
設計交通量	q (176-468)	944	0	525	116 (86+50)	152
右折補正交通量	qR-N		0			
交差点流入部の需要率	ρ	0.173	0.137	0.137	0.080	0.087
必要現示率				****		
1φ						0.173
2φ						0.000
3φ						0.087
有効青時間(秒)		52	54	54	54	サイクル数(秒)
1φ						100
2φ						
3φ						
標準青時間比	G/C	52/100	63/100	9/100	29/100	29/100
可能交通容量	C1	1930	2407	234	421	506
交通容量比	q/C1	0.334	0.218	0.000	0.276	0.301

※ $N = K \times \frac{3600}{C}$

N: 実1時間現示変化時右折車の捌け台数

※*: 交通容量(実1時間)

※****: 連続現示での使用現示

- ①: 至 十日市場駅
- ②: 至 瀬谷駅
- ③:

現示方式の図示

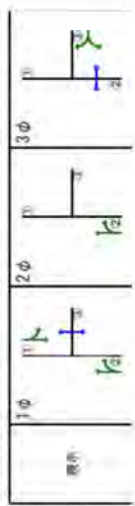

交差点概略図

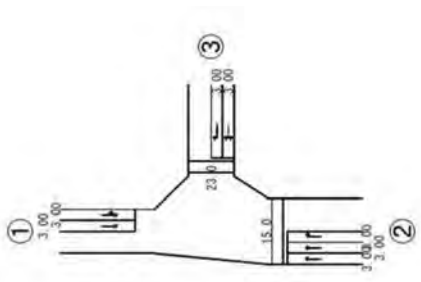

交通量図

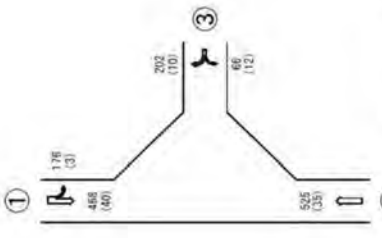

上段 方向別合計交通量 [台/時]
下段 (大型車混入台数) [台/時]

供用時休日交差点検討資料

供用時休日 地域社会 4 瀬谷上橋公園入口 17:00~18:00の需要率の算出

交差点概略図

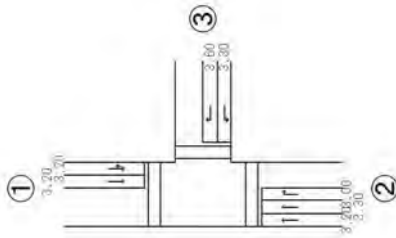

交通量図

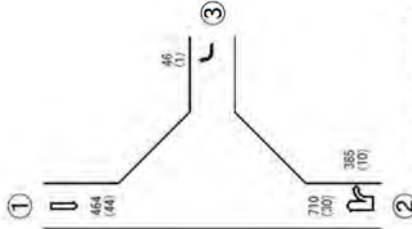

上段 方向別合計交通量[台/時]
下段 (大型車混入台数)[台/時]

交差点名	瀬谷上橋公園交差点				
	①	②			
流入部	左折・直進	直進	右折	左折	右折
車線の種類	1	2	1	1	1
車線数	1	2	1	1	1
飽和交通流率の基本値	SB 2000	2000	1800	1800	1800
車線幅員による補正率	αw 1.000	1.000	1.000	1.000	1.000
(車線幅員)	m 3.000	(3.00)	(3.00)	(3.50)	(3.50)
縦断勾配による補正率	αG 1.000	1.000	1.000	1.000	1.000
(縦断勾配)	% (0.00)	(0.00)	(0.00)	(0.00)	(0.00)
大型車混入による補正率	αT 0.938	0.938	0.982	1.000	0.985
(大型車混入率)	% (9.48)	(9.48)	(2.60)	(0.00)	(2.17)
左折車混入による補正率	αLT 1.000				
(左折率)	L % (0.0)				
(歩行者による低減率)	f p 0.15			0.15	
(有効青時間) 秒	34			22	
(歩行者用青時間) 秒	29			17	
横断歩行者による補正率	αL				
右折車混入による補正率	αRT				
(右折率)	R % (0.0)			0.884	
(右折車の通過確率)	f				
(有効青時間) 秒					
(現示変更目目のさばけ台数増分)					
KER: 台/サイクル					
(交差点内滞留台数)					
K: 台/サイクル					
飽和交通流率	SA 1876	1876	1768	1591	1773
設計交通量	q 464	710	385	0	46
(0+464)					
右折補正交通量	q R-N				
交差点流入部の需要率	ρ 0.124	0.183	0.218	-	0.026
必要現示率	1 ϕ 0.124	0.183	0.218		0.026
2 ϕ 0.124	****				0.124
3 ϕ					0.026
有効青時間(秒)	1 ϕ 44	44	44		110
2 ϕ 34					
3 ϕ 34					
信号青時間比	G/C 34/110	78/110	44/110	22/110	22/110
可能交通容量	C i 1160	2754	707	318	355
交通容量比	q/C i 0.400	0.258	0.545	0.000	0.130
現示の需 要率					0.026
交差点の 需要率					0.026
必要率					0.368
サイクル長(秒)					110

$$N = K \times \frac{3600}{C}$$

N: 実1時間現示変化時右折車の捌け台数

※*: 交通容量(実1時間)

※****: 連続現示での使用現示

①: 至 十口市場駅

②: 至 瀬谷駅

③:

現示方式の図示



供用時休日交差点検討資料

供用時休日 地域社会 5 中瀬谷消防署出張所北側 15:00~16:00 の需要率の算出

流入部	①		②		③		④	
	左折	直進	右折	左折・直進	右折	左折・直進	右折	左折・直進
車線の種別	L	1	1	1	1	1	1	1
車線数	1	1800	1800	2000	1800	2000	1800	2000
飽和交通流率の基本値	S B	1.000	1.000	1.000	1.000	1.000	1.000	1.000
飽和交通流率による補正率	α_w	(3.00)	(3.00)	(3.00)	(3.00)	(3.00)	(3.00)	(3.00)
(車線幅員)	m	1.000	1.000	1.000	1.000	1.000	1.000	1.000
経路勾配による補正率	α_G	(0.00)	(0.00)	(0.00)	(0.00)	(0.00)	(0.00)	(0.00)
(経路勾配)	%	0.924	0.880	0.892	0.881	0.886	0.888	0.882
大型車混入による補正率	α_T	(11.74)	(17.74)	(17.74)	(18.37)	(18.37)	(18.37)	(19.12)
(大型車混入率)	%	0.795	0.795	0.795	0.647	0.647	0.647	0.647
左折車混入による補正率	α_{LT}	(29.0)	(29.0)	(29.0)	(61.2)	(61.2)	(61.2)	(61.2)
(左折率)	L%	0.50	0.50	0.50	0.50	0.50	0.50	0.50
(歩行者による低減率)	f p	36	30	36	30	36	30	36
(有効歩時間)	f	31	25	31	25	31	25	31
(歩行者用骨時間)	秒	0.569	0.569	0.569	0.569	0.569	0.569	0.569
機動歩行者による補正率	α_L							
右折車混入による補正率	α_{RT}							
(右折率)	R%							
(左折車の通過確率)	f							
(有効骨時間)	秒							
(現示方式のさげ増加分)	K							
(K: 当/サイクル)								
(K: 当/サイクル)								
飽和交通流率	S A	946	1780	1606	1401	*742	1772	1207
設計交通量	q	213	327	29	31	0	294	49
右折補正交通量	q R-N			0	(9+22)		(9+294)	204
流入部の需要率	ρ	0.225	0.184	-	0.022	-	0.166	-
必要現示率	1 ϕ	0.225	0.184	-	0.166	-	0.166	-
	2 ϕ							
	3 ϕ							
有効骨時間(秒)	1 ϕ	36	36	6	0.022	-	0.041	-
	2 ϕ							
	3 ϕ							
信号骨時間比	G/C	36/80	36/80	6/80	30/80	30/80	36/80	30/80
可能交通量	C i	426	801	210	525	742	797	221
交通容量比	q/C i	0.500	0.408	0.138	0.059	0.000	0.389	0.108

$N = K \times \frac{3600}{C}$

N: 1時間現示変化時右折車の捌け台数

※*: 交通容量(第1時間)

- ①: 至 十日市場
- ②: 至 坂
- ③: 至 坂
- ④: 至 坂

交差点概略図

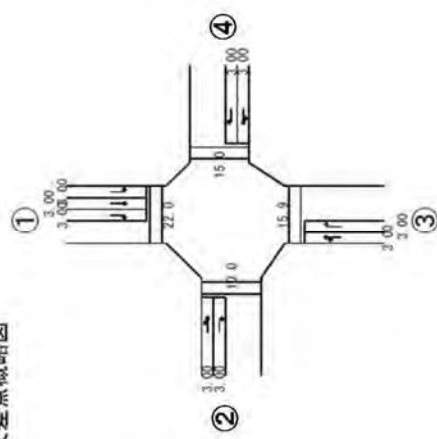

交通量図

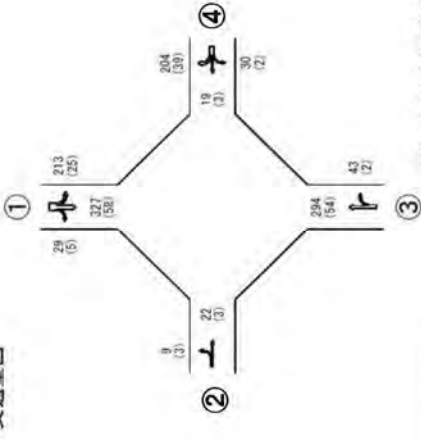

上段: 方向別合計交通量[台/時]
下段: (大型車混入台数)[台/時]

現示方式の図示

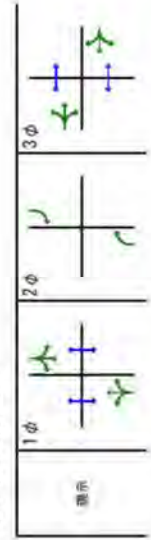

供用時休日交差点検討資料

供用時休日 地域社会 6 瀬谷中学校前 15:00~16:00 の需要率の算出

交差点概略図

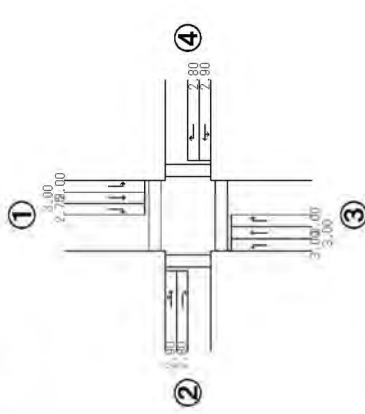

交通量図

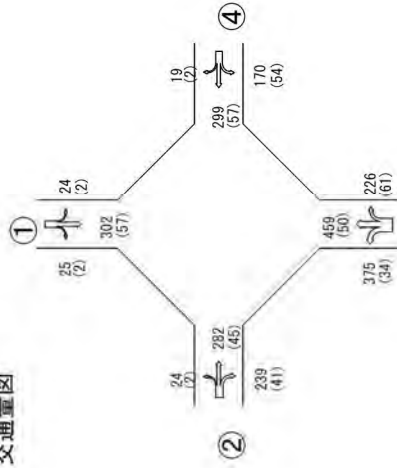

上段：方向別合計交通量(台)
下段：(大型車混入台数)[台/時]

流入部 車線	①		②		③		④		
	左折	直進	右折	左折	直進	右折	左折	直進	右折
車線数	1	1	1	1	1	1	1	1	1
緩和交通流率の基本値 SB	1800	2000	1800	1800	2000	1800	2000	1800	1800
緩和係数による補正率 αw	1.000	1.000	1.000	1.000	1.000	1.000	0.950	1.000	1.000
(乗換係数) m	(3.00)	(3.00)	(2.75)	(2.90)	(3.00)	(3.00)	(2.90)	(2.80)	(2.80)
緩和分配による補正率 αG	1.000	1.000	1.000	1.000	1.000	1.000	1.000	1.000	1.000
(緩和分配) %	(0.00)	(0.00)	(0.00)	(0.00)	(0.00)	(0.00)	(0.00)	(0.00)	(0.00)
大型車混入による補正率 αT	0.935	0.883	0.941	0.894	0.941	0.841	0.868	0.941	0.941
(大型車混入率) %	(10.00)	(19.00)	(9.00)	(15.53)	(17.00)	(11.00)	(23.71)	(9.00)	(9.00)
左折車流入による補正率 αLT				0.979			0.895		
(注釈者) L%				(7.8)			(36.2)		
(歩行者による低減率) f p	0.50			0.50			0.50		
(有効青時間) 秒	36			33			33		
(歩行者用青時間) 秒	25			20			20		
補換歩行者による補正率 αLT	0.853			0.653			0.653		
右折車流入による補正率 αRT									0.744
(右折率) R%			0.616			0.725			33
(右折車の通過確率) f			36			36			2(72)
(有効青時間) 秒			2(72)			2(72)			
(表示変更目によるはげけ増分) KLR : 台/サイクル									
(交差点内滞留台数) Kc : 台/サイクル									
緩和交通流率 SA	1099	1766	1694	1678	1609	1106	1668	1654	1459
設計交通量 q	34	302	35	306	239	375	459	228	489
				(24+282)			(170+299)		19
右折補正交通量 qR-N			0		0	0			0
流入部の需要率	0.023	0.171	0.000	0.182	0.000	0.339	0.247	0.000	0.321
必要現示率	0.022	0.171	0.000			0.339	0.247		0.321
1φ			0.000						0.000
2φ				0.182					0.321
3φ									0.000
4φ					0.000				0.000
有効青時間(秒)	36	36	9			36	36		100
1φ									33
2φ				33					
3φ									
4φ									
信号青時間比 G/C	36/100	36/100	9/100	33/100	10/100	96/100	36/100	33/100	10/100
可能交通容量 Ci	396	636	401	554	483	396	669	479	461
交通容量比 q/Ci	0.081	0.475	0.062	0.652	0.496	0.942	0.686	0.473	0.375

現示方式の図示



※ N = K × 3600 / C

N : 実1時間現示変化時右折車の捌け台数

※ * : 交通容量 (実1時間)

- ①: 至 十日市場
- ②: 至 国道246号
- ③: 至 泉
- ④: 至 瀬谷小学校

供用時休日 交差点検討資料

供用時休日 地域社会 8 8:00~9:00 の需要率の算出

流人種別	① 直進		② 左折		③ 右折・直進	
	車線数	1	1	1	1	1
飽和交通流量の算本値	SR	2000	1800	1800	1800	2000
車線幅員による補正率	αw	1.000	1.000	1.000	1.000	1.000
(車線幅員)	m	(3.25)	(3.00)	(3.25)	(3.00)	(3.00)
縦断勾配による補正率	αG	1.000	1.000	1.000	1.000	1.000
(縦断勾配)	%	(0.00)	(0.00)	(0.00)	(0.00)	(0.00)
大型車混入による補正率	αT	0.920	0.598	1.000	1.000	1.000
(大型車混入率)	%	(12.50)	(95.00)	(0.00)	(0.00)	(0.00)
左折車混入による補正率	αL				0.994	
(左折率)	L %			0.50	(0.6)	
(左行者による低減率)	f p			30	52	
(有効青時間)	秒			25	47	
(歩行者用青時間)	秒			0.583		
横断歩行者による補正率	αL					
右折車混入による補正率	αR					
(右折率)	R %					
(右折車の通過確率)	f					
(有効青時間)	秒					
(見がかり目のさげ台数(秒分))	J					
KER : 台/サイクル						
(交差点内部留台数)	K					
K : 台/サイクル						
飽和交通流量	S.A	1840	*574	1049	1800	1988
設計交通量	q	8	25	48	22	161
(右折補正交通量)	q R - N					(1+160)
流入部の需要率	ρ	0.001		0.046	0.012	0.081
必要現示率	1 ϕ	0.004		0.081	0.081	0.127
有効青時間(秒)	1 ϕ	52	52	52	52	52
2 ϕ						90
信号青時間比	G/C	52/90	52/90	30/90	30/90	52/90
可能交通容量	C I	1063	574	350	600	1149
交通容量比	q/C I	0.008	0.044	0.137	0.037	0.140

$\phi = KES \times \frac{5600}{C}$

N : 1時間ごに右折車が交差点内に滞留する台数
 C : 交通容量 (実1時間)

現示方式の図示



- ① : 至 八王子街道
- ② : 至 環状4号線
- ③ : 至 細谷戸ハイッ

交差点概略図

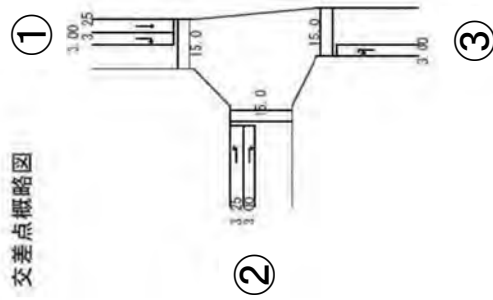

交通量図

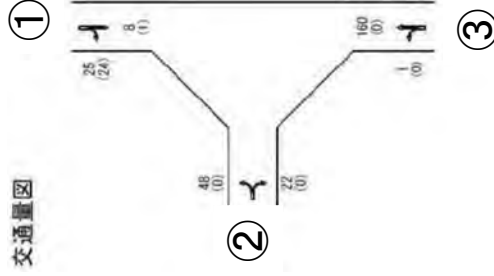

上段 : 方向別合計交通量 [台/時]
 下段 : 大型車混入台数 [台/時]

供用時休日 交差点検討資料

供用時休日 地域社会 9 16:00~17:00 の需要率の算出

流 入 部 類	①		②		③		④	
	左折・直進	右折	左折・直進	右折	左折・直進	右折	左折・直進	右折
車 線 数	1	1	1	1	1	1	1	1
飽和交通流量の基本値	2000	1800	2000	1800	2000	1800	2000	1800
車道幅員による補正率	α _w	1.000	1.000	1.000	1.000	1.000	1.000	1.000
(車線幅員)	m	(3.00)	(3.00)	(3.00)	(3.00)	(3.00)	(3.00)	(3.00)
縦断勾配による補正率	α _G	1.000	1.000	1.000	1.000	1.000	1.000	1.000
(縦断勾配)	%	(0.00)	(0.00)	(0.00)	(0.00)	(0.00)	(0.00)	(0.00)
大型車混入による補正率	α _T	0.941	1.000	0.791	0.984	0.950	1.000	0.935
(大型車混入率)	%	(9.02)	(0.00)	(37.78)	(2.79)	(7.46)	(0.00)	(38.07)
左折車混入による補正率	α _L	0.922	1.000	1.000	1.000	1.000	1.000	1.000
(左折率)	I	(8.3)	(0.0)	(33.6)	(0.0)	(0.0)	(0.0)	(0.0)
(歩行者による低減率)	I _p	0.50	0.50	0.50	0.50	0.50	0.50	0.50
(有効者時間)	秒	57	34	57	34	57	34	57
(歩行者用者時間)	秒	52	29	52	29	52	29	52
横断歩行者による補正率	α _L							
(右折率)	R							
(右折車の通過確率)	R%							
(右折車の通過確率)	I	0.685	0.685	0.669	0.669	0.669	0.669	0.669
(有効者時間)	秒	57	57	57	57	57	57	57
(現示要り日のさげ係数増分)	秒	2(60)	2(60)	2(60)	2(60)	2(60)	2(60)	2(60)
KER: 台/サイクル								
(交差点内滞留台数)								
K: 台/サイクル								
飽和交通流量	S A	1735	1582	1766	1766	1416	1580	1683
設計交通量	q	410	315	179	526	0	331	30
(31.376)			(0.315)	(180.356)		(0.331)		
右折補正交通量	q R - N			119		0		0
流入部の必要率	μ	0.236	0.199	0.067	0.379	0.379	0.209	0.655
必要現示率	1 φ		0.199	0.067	0.379	0.379	0.209	0.655
2 φ				0.067			0.067	
3 φ							0.379	
1 φ			31				34	
2 φ				19			19	
3 φ			57	57	57	57	57	57
信号時間止	G/C	57/120	34/120	19/120	57/120	57/120	34/120	19/120
可能交通容量	C i	506	448	340	673	486	448	326
交通容量比	q/C i	0.498	0.703	0.326	0.796	0.000	0.739	0.092

$$\mu = \mu + \frac{KER \times \mu}{\mu}$$

μ : 1 時間で右折車が交差点内に滞留する台数
φ : 交通容量 (毎 1 時間)

現示方式の図示

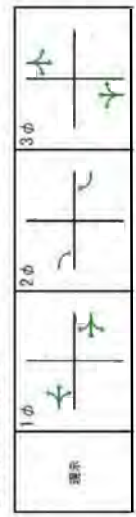

- ① : 至 対象事業実施区域
- ② : 至 環状 4 号線
- ③ : 至 ニツ上橋交差点
- ④ : 至 中原街道

交差点概略図

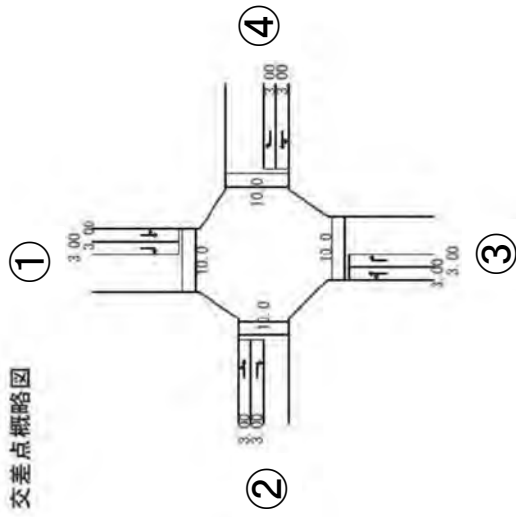

交通量図

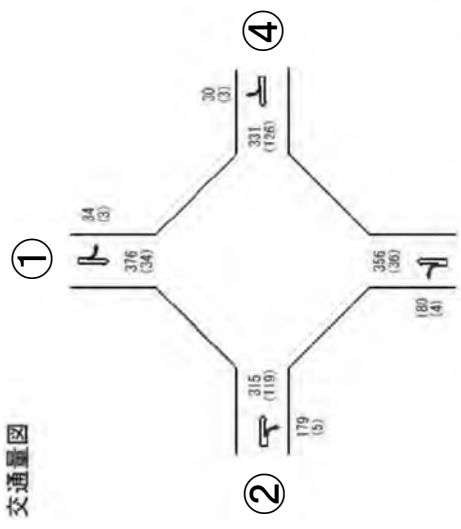

上段: 方向別合計交通量 [台/時]
下段: (大型車混入台数) [台/時]

9.17-8 工事用車両の運行に係る環境保全措置実施後の交差点需要率

工事用車両の運行に係る環境保全措置実施後の地域社会 1～地域社会 4において求めた交差点需要率は、以下に示すとおりです。

- ・ 平日 P.資料 地域-1045～1049
- ・ 休日 P.資料 地域-1050～1054

環境保全措置実施後の工事中交差点検討資料

工事中(平日) 地域社会Ⅰ 日黒 7:00~8:00 の需要率の算出

流 入 車 線 の 種 別	①		②		③		④	
	左折・直進	右折	左折・直進	右折	左折	右折	左折・直進	右折
車 線 数	1	1	1	1	1	1	1	1
飽和交通流率の基本値	SB	1800	1636	1543	1451	1427	1788	1821
車線幅員による補正率	α w	1.000	1.000	1.000	1.000	1.000	1.000	1.000
(車線幅員)	m	(2.70)	(3.20)	(3.20)	(3.00)	(3.00)	(3.20)	(3.10)
縦断勾配による補正率	α G	1.000	1.000	1.000	1.000	1.000	1.000	1.000
(縦断勾配)	%	(0.00)	(0.00)	(0.00)	(0.00)	(0.00)	(0.00)	(0.00)
大型車混入による補正率	α T	0.855	0.791	0.829	0.770	0.770	0.852	0.812
(大型車混入率)	%	(24.15)	(37.80)	(29.37)	(42.74)	(42.59)	(23.77)	(33.15)
左折車混入による補正率	α L T	0.956		0.921			0.852	
(左折率)	l %	(20.9)		(40.6)			(82.9)	
(歩行者による低減率)	f D	0.12		0.12			0.13	
(有効青時間)	秒	66		66			34	
(通行者混雑時間)	秒	56		34			56	
横断歩行者による補正率	α L			0.898				
右折車混入による補正率	α R T							
(右折率)	R %							
(右折車の通過確率)	f	0.608					0.627	
(有効青時間)	秒	66					66	
(現示要り日のさほけ数増分)	KFR	2(15)					2(15)	
KFR:右/サイクル (交差点内滞留台数)								
K:右/サイクル								
飽和交通流率	S A	1219	1424	1219	1188	1003	1216	1260
設計交通量	q	559	82	143	241	324	477	181
(117~142)				(58+85)				(150+31)
右折補正交通量	q R-N	0	0				0	
流入部の需要率	n	0.459	0.000	0.114	0.203	0.323	0.392	0.000
必要現示率	1 φ			0.114			0.000	0.114
2 φ				0.114			0.000	0.141
3 φ								0.203
4 φ								0.459
有効青時間(秒)	1 φ							0.000
2 φ								34
3 φ								66
4 φ								11
信号青時間比	G/C	66/160	11/160	34/160	32/160	66/160	66/160	11/160
可能交通容量	C I	503	245	265	238	411	502	268
交通容量比	q/C I	1.111	0.335	0.540	1.013	0.783	0.950	0.375
現在の交通容量	必要率	0.141	0.806	0.203	0.459	0.000	0.109	0.109
サイクル長(秒)	160							

$$N = K \times \frac{3600}{C}$$

N: 表1時間現示変化時右折車の捌け台数

K*: 交通容量(実1時間)

①: 至 つきみ野

②: 至 海老名

③: 至 鶴ヶ峰

④: 至 青葉台駅

現示方式の図示

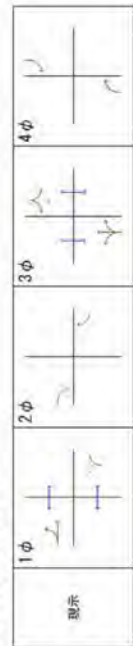

交差点概略図

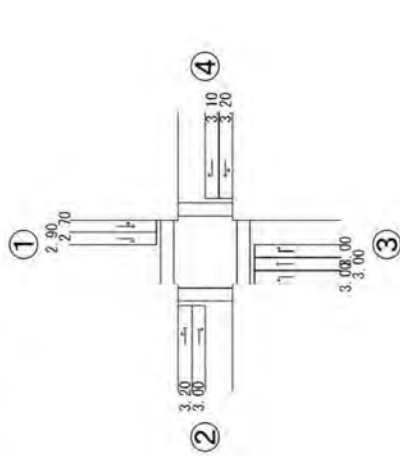

交通量図

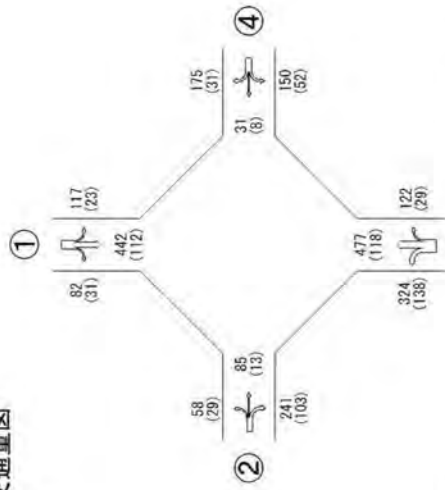

上段: 方向別合計交通量(台)
下段: 大型車混入台数(台)

環境保全措置実施後の工事中交差点検討資料

交差点概略図

工事中(平日) 地域社会2 目黒交番前 17:00~18:00の需要率の算出

車線の種別	①		②		③		④	
	左折・直進	右折	左折・直進	右折	左折・直進	右折	左折・直進	右折
車線数	1	1	1	1	1	1	1	1
飽和交通流率の基本値	1617	1800	1388	1519	1352	1733	1536	1800
車線幅員による補正率	1.000	1.000	0.950	1.000	1.000	1.000	1.000	1.000
(車線幅員)	(3.30)	(3.10)	(2.90)	(3.00)	(2.80)	(3.20)	(3.00)	(2.75)
縦断勾配による補正率	1.000	1.000	1.000	1.000	1.000	1.000	1.000	1.000
(縦断勾配)	(0.00)	(0.00)	(0.00)	(0.00)	(0.00)	(0.00)	(0.00)	(0.00)
大型車混入による補正率	0.964	0.925	0.919	0.896	0.923	0.886	0.889	0.777
(大型車混入率)	(5.34)	(11.59)	(12.64)	(16.52)	(12.00)	(18.39)	(17.91)	(40.98)
左折車混入による補正率	0.995						0.974	
(左折率)	(2.5)						(11.2)	
(歩行者による低減率)	1.0		0.13				0.13	
(歩行者歩行時間)	28		103				103	
横断歩行者による補正率	17		89				89	
右折車混入による補正率			0.888					
(右折率)								
(右折車の通過確率)					0.493			0.508
(有効歩時間)					103			103
(歩行者歩行時間のさばり台数増分)					2(42)			2(42)
KLR:右/サイクル								
(交差点内滞留台数)								
K:右/サイクル								
飽和交通流率	S A	1586	1665	1361	1248	1380	1330	1399
設計交通量	q	314	164	182	75	409	793	122
(4:310)						(99:310)	(89:704)	
右折補正交通量	q R	N			0			0
混入部の必要率	μ	0.099	0.098	0.169	0.494	0.162	0.065	0.000
必要現示率	1 φ	0.099				0.162		
	2 φ		0.098				0.005	
	3 φ			0.169	0.494			0.596
	4 φ							
有効歩時間(秒)	1 φ	28			0.000			
	2 φ		15				15	
	3 φ			103				103
	4 φ				7			7
信号青時間比	G/C	28/170	15/170	103/170	7/170	28/170	15/170	103/170
可能交通容量	C i	521	447	825	261	417	333	308
交通容量比	q/C i	0.603	1.116	0.279	0.816	0.981	0.737	0.904

※ $N = K \times \frac{3600}{C}$

N: 1時間現示変化時右折車の捌け行數

※ μ : 交通容量(実1時間)

①: 全1口市場

②: 全1つさみ野

③: 全1泉

④: 全1絶ヶ峰

現示方式の図示

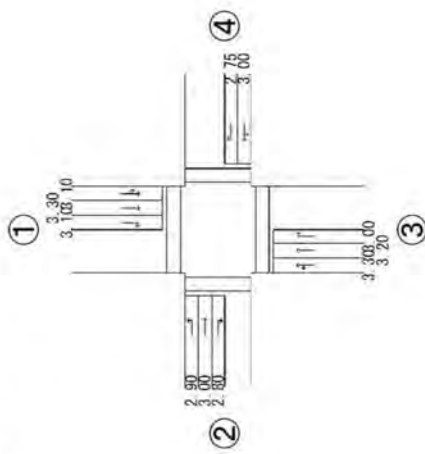

交通量図

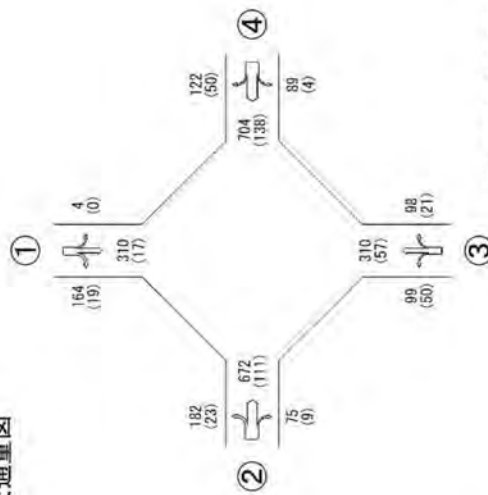

上段: 方向別合計交通量(台)
下段: 大型車混入台数(台)

環境保全措置実施後の工事中交差点検討資料

工事中（平日） 地域社会4 流況 18:00～19:00 の需要率の算出

流入の種類	①		②		③	
	左折・直進	直進	直進	右折	左折・右折	右折
車線数	1	2	1	1	1	1
飽和交通流量の基本値	SB 1678	1628	1800	1800	1639	1639
車線幅員による補正率	α_w 1.000	1.000	1.000	1.000	1.000	1.000
(車線幅員)	m (3.10)	(3.20)	(3.00)	(3.00)	(3.10)	(3.20)
縦断勾配による補正率	α_G 1.000	1.000	1.000	1.000	1.000	1.000
(縦断勾配)	% (0.00)	(0.00)	(0.00)	(0.00)	(0.00)	(0.00)
大型車混入による補正率	α_T 0.951	0.950	0.941	0.772	0.909	0.964
(大型車混入率)	% (7.29)	(7.47)	(8.98)	(42.11)	(16.56)	(5.29)
右折車混入による補正率	α_{LT} 0.922					
(左折率)	L% (10.2)					
(歩行者による低減率)	I P 0.12				0.12	
(有効歩行時間)	秒 37				31	
(歩行者歩行時間)	秒 28				22	
横断歩行者による補正率	α_L				0.915	
右折車混入による補正率	α_{RT}				1.000	
(右折率)	R% (0.0)				(0.0)	
(右折車の通過確率)	I 1.000				1.000	
(有効歩行時間)	秒 40				31	
(現が必要り目の上げ下げ台数増分)	KIR: 1/サイクル				1(40)	
(交差点内滞留台数)	K: 0/サイクル				1(40)	
飽和交通流量	S A 1171	1594	3064	1390	1107	1599
設計交通量	q 637	813	95	326	359	359
(128-509)				(326+0)		
右折補正交通量	q_{R-N}		0			
流入部の必要率	ρ 0.208		0.255	0.000	0.218	0.225
必要現示率	1φ 0.208		0.221	0.000	0.218	0.225
	2φ		0.014	0.000	0.014	0.014
	3φ				0.225	0.225
有効歩行時間(秒)	1φ 37		10		31	31
	2φ		8		8	8
	3φ					
信号青時間比	G/C 37/90		48/90	8/90	31/90	31/90
可能交通容量	C I 1260		1634	447	518	551
交通容量比	q/C_i 0.506		0.498	0.213	0.632	0.652

$$N = K \times \frac{3600}{C}$$

N: 実1時間現況変化時点近市の捌け台数

※*: 交通容量(実1時間)

※***: 連続現示での使用現示

①: 至 平日市場駅

②: 右 瀬谷駅

③:

交差点概略図

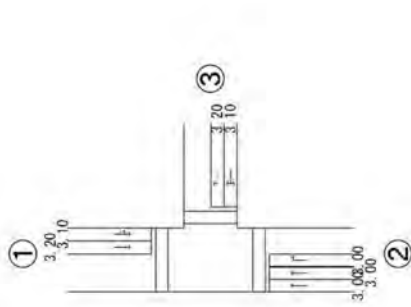

交通量図

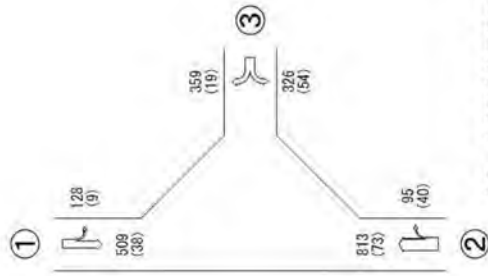

上段: 方向別合計交通量(台)
下段: 大型車混入台数(台)

現示方式の図示

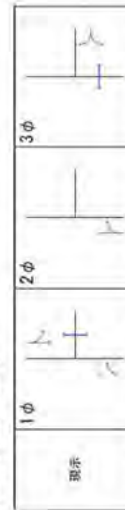

環境保全措置実施後の工事中交差点検討資料

交差点概略図

「工事中(平日) 地域社会 4 瀬谷上橋公園入口 7:00~8:00」の需要率の算出

流入車種の種類	①		②		③	
	左折・直進	右折	直進	右折	左折	右折
車線の数	1	1	2	1	1	1
飽和交通流率の基本値	S B	1577	1315	1369	1800	1682
直線幅員による補正率	α w	1.000	1.000	1.000	1.000	1.000
(車線幅員)	m	(3.20)	(3.30)	(3.00)	(3.30)	(3.60)
縦断勾配による補正率	α G	1.000	1.000	1.000	1.000	1.000
(縦断勾配)	%	(0.00)	(0.00)	(0.00)	(0.00)	(0.00)
大型車混入による補正率	α T	0.865	0.862	0.921	0.877	0.919
(大型車混入率)	%	(24.19)	(22.80)	(12.17)	(20.00)	(20.00)
左折車混入による補正率	α L T	0.908				
(左折率)	L %	(31.5)				
(歩行者による低減率)	f p	0.12			0.12	
(右折歩行者による補正率)	α R T	0.925			0.925	
橋断歩行者による補正率	α L					
(右折率)	R %					
(右折車の通過確率)	I					
(有効歩時間)	I p					
(現が走り目のさげ台数(歩分))	K K K					
(交差点内滞留台数)	K					
K:台/サイクル						
飽和交通流率	S A	1265	1359	2422	1201	1460
設計交通量	q	864	534	534	85	75
右折補正交通量	q R-N					
流入部の需要率	ρ	0.329	0.226	0.071	0.051	0.201
必要現示	1φ	0.329	0.178	0.071	0.071	0.329
	2φ		0.012	0.071	0.071	0.071
	3φ					0.201
有効歩時間(秒)	1φ	50	55	13		110
	2φ		13			
	3φ					32
信号青時間比	G/C	50/110	68/110	13/110	32/110	32/110
可能交通容量	C 1	1193	1497	142	425	450
交通容量比	q/C 1	0.724	0.357	0.599	0.176	0.691
表示の需要率						
表示の需要率						
サイクル長(秒)						

$$\text{※ } N = K \times \frac{3600}{C}$$

N: 実行時間現示変化時右折車の捌け台数

※*: 交通容量(実行時間)

※***: 連続現示での使用現示

①: 至 1山田地蔵

②: 至 瀬谷駅

③

現示方式の図示

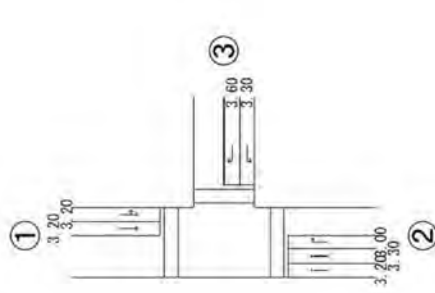

交通量図

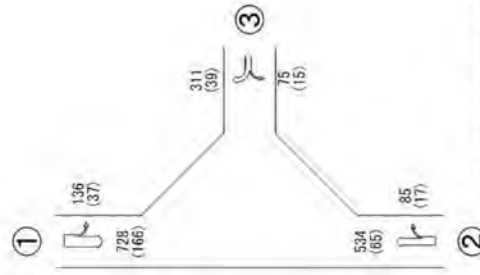

上段: 方向別合計交通量(台)

下段: 大型車混入台数(台)

環境保全措置実施後の工事中交差点検討資料

交差点概略図

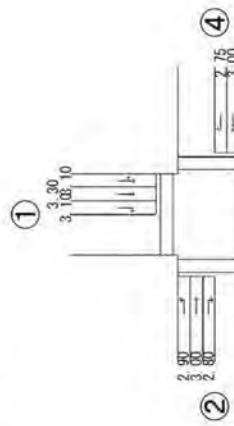

交通量図

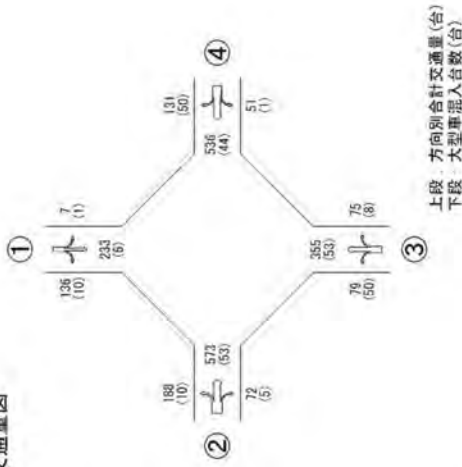

上段：方向別合計交通量(台)
下段：大型車進入台数(台)

工事中(休日) 地域社会2 日曜交番前 17:00~18:00の需要率の算出

車線の種類	①		②		③		④	
	左折・直進	右折	左折・直進	右折	左折・直進	右折	左折・直進	右折
車線数	1	1	1	1	1	1	1	1
飽和交通流率の基本値 S/B	1568	1800	1616	1505	1451	1695	1602	1800
車線幅員による補正率 α w	1.000	1.000	0.950	1.000	1.000	1.000	1.000	1.000
(車線幅員)	(3.10)	(3.30)	(2.90)	(3.00)	(3.30)	(3.00)	(3.00)	(2.75)
側断勾配による補正率 α G	1.000	1.000	1.000	1.000	1.000	1.000	1.000	1.000
(側断勾配)	(0.00)	(0.00)	(0.00)	(0.00)	(0.00)	(0.00)	(0.00)	(0.00)
大型車進入による補正率 α T	0.978	0.982	0.964	0.939	0.814	0.905	0.949	0.789
(大型車進入率)	(3.26)	(2.38)	(5.32)	(9.25)	(6.94)	(14.93)	(7.07)	(38.17)
右折車進入による補正率 α L T	0.980				0.982		0.980	
(右折車)	(5.8)				(36.1)		(8.7)	
(歩行者による低減率) I p	0.13		0.13		0.13		0.13	
(有効歩道幅)	31		31		31		31	
(歩行者通行時間)	76		76		20		76	
側断法による補正率 α L			0.890					
右折車進入による補正率 α R T								
(右折車)								
(右折車の通過確率) f								
(有効歩道幅)								
(視界入り目の長さ(台数分))								
K係：台/サイクル								
(交差点内設備台数)								
K：台/サイクル								
飽和交通流率 SA	1517	1510	1712	1413	1103	1316	1490	1420
設計交通量 q	240		136	488	573	72	331	587
(7.253)							(79.965)	
右折補正交通量 q R-N								0
流入部の需要率 ρ	0.079		0.079	0.143	0.106	0.000	0.179	0.000
必要現示率	0.079		0.079				0.179	0.000
1φ								
2φ								
3φ								
4φ								
有効歩時間(秒)			14		31			
1φ								
2φ								
3φ								
4φ								
信号青時間比 G/C	31/160		14/160	90/160	90/160	31/160	14/160	90/160
可能交通容量 C I	592		450	741	796	469	498	538
交通容量比 q/C I	0.405		0.907	0.354	0.721	0.154	0.325	0.378

現示方式の図示



※ N-K × 3600 / C

N：実1時間現示変化時右折車の割合(台数)

※*：交通容量(実1時間)

①：歩 10分間

②：歩 つきみ野

③：歩 歩

④：歩 歩

環境保全措置実施後の工事中交差点検討資料

交差点概略図

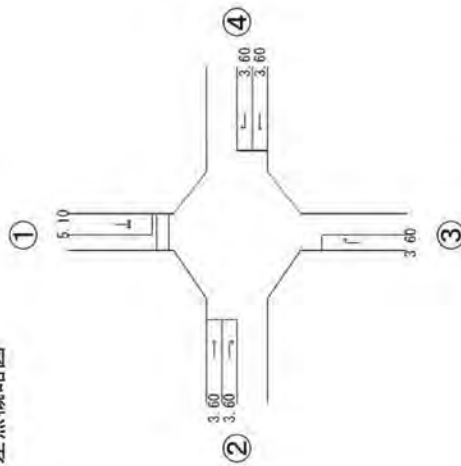

交通量図

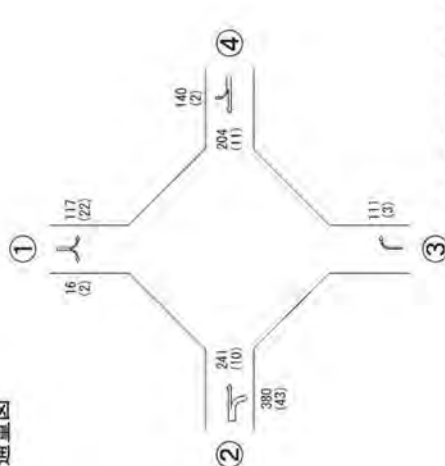

上段：方向別合計交通量(台)
下段：大型車混入台数(台)

工事中(休日) 地域社会3 七川井IC 17:00~18:00の需要率の算出

流車要素の種別	①		②		③		④	
	左折	右折	直進	右折	直進	右折	直進	右折
車線数	1	1	1	1	1	1	1	1
飽和交通流量の基本値 S.B	1616	1583	1705	1705	1705	1525	1544	1544
車線幅員による補正率 α _w	1.000	1.000	1.000	1.000	1.000	1.000	1.000	1.000
(車線幅員)	(5.10)	(3.60)	(3.60)	(3.60)	(3.60)	(3.60)	(3.60)	(3.60)
視距勾配による補正率 α _G	1.000	1.000	1.000	1.000	1.000	1.000	1.000	1.000
(視距勾配)	(0.00)	(0.00)	(0.00)	(0.00)	(0.00)	(0.00)	(0.00)	(0.00)
大型車混入による補正率 α _T	0.888	0.972	0.927	0.981	0.964	0.990	0.990	0.990
(大型車混入率)	(18.05)	(4.15)	(11.32)	(2.70)	(5.39)	(1.43)	(1.43)	(1.43)
左折車混入による補正率 α _L								
(左折率)	1.000							
(歩行者による低減率) I _p								
(有効歩時間)								
(歩行者歩留時間)								
自転車歩行者による補正率 α _R								
(右折率)	1.000							
(右折車の通過確率) R%	(12.0)							
(有効歩時間)	1.000							
(有効歩時間)	20							
(表示変り目のさばり台数増分) KEM	2(68)							
(交差点内滞留台数) K								
(台/サイクル)								
飽和交通流量 SA	1462	1539	1581	1573	1470	1529	1529	1529
設計交通量 q	133	241	380	111	201	140	140	140
(117-16)								
右折補正交通量 q _{R-N}								
歩行者の必要率	0.091	0.157	0.240	0.081	0.139	0.092	0.092	0.092
必要現示率	0.091	0.157	0.240	0.081	0.139	0.092	0.092	0.092
1φ								
2φ								
3φ								
有効歩時間(秒)	20	32	20	20	32	105	105	105
1φ								
2φ								
3φ								
信号青時間比 G/C	20/105	32/105	35/105	20/105	32/105	35/105	35/105	35/105
可能交通容量 C _i	278	469	527	362	448	510	510	510
交通容量比 q/C _i	0.478	0.511	0.721	0.421	0.455	0.275	0.275	0.275

$$※ N = K \times \frac{3600}{C}$$

N：実1時間現示変化時右折車の捌出台数

※*：交通容量(実1時間)

①：至 備前町出口

②：至 つきみ野

③：至 下川井IC

④：至 鶴ヶ峰

現示方式の図示

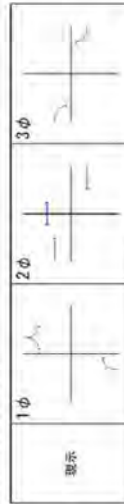

環境保全措置実施後の工事中交差点検討資料

工事中(休日) 地域社会4 滝沢 17:00~18:00 の需要率の算出

流 入 部 類	①		②		③	
	左折・直進	直進	左折	右折・左折	右折	右折
重 額	1	2	1	1	1	1
私和交通流率の基本値	S/B	1545	1513	1800	1428	1428
車線幅員による補正率	α W	1.000	1.000	1.000	1.000	1.000
(車線幅員)	in	(3.10)	(3.20)	(3.00)	(3.10)	(3.20)
縦断勾配による補正率	α G	1.000	1.000	1.000	1.000	1.000
(縦断勾配)	%	(0.00)	(0.00)	(0.00)	(0.00)	(0.00)
大型車混入による補正率	α T	0.978	0.972	0.947	0.766	0.989
(大型車混入率)	%	(3.14)	(4.05)	(8.02)	(43.68)	(22.22)
右折車混入による補正率	α L T	0.894				
(左折率)	L%	(53.7)				
(歩行者による低減率)	L%	0.12				
(有効青時間)	f P	51				
(歩行者利用青時間)	f P	42				
機断歩行者による補正率	α L					
右折車混入による補正率	α R T					
(左折率)	R%					
(左折車の通過確率)	f					
(有効青時間)	f					
(現示要り目のさばけ台数増分)						
KER: 六/サイクル						
(交差点内階段台数)						
K: 右/サイクル						
飽和交通流率	S A	1351	1502	2866	1379	1219
設計交通量	q	473		723	87	99
(127-346)					(99+0)	
右折補正交通量	q R - N			0		
流入部の需要率	ρ	0.166		0.252	0.000	0.081
必要現示率	1 φ	0.166		0.219		0.410
	2 φ			0.033	0.000	0.033
	3 φ					0.158
有効青時間(秒)	1 φ	51		54		57
	2 φ			8		8
	3 φ					37
信号青時間比	G/C	51/110		62/110	8/110	37/110
可能交通容量	C 1	1323		1615	540	410
交通容量比	q/C 1	0.358		0.448	0.161	0.241
現示の 必要率						
サイクル長(秒)						110

$$※ N - K \times \frac{3600}{c}$$

N: 実1時間現示変化(右折車の削減台数)

※ *: 交通容量(実1時間)

※ ** **: 選線現示での使用現示

①: 至 10月市場駅

②: 至 額谷駅

③:

現示方式の図示

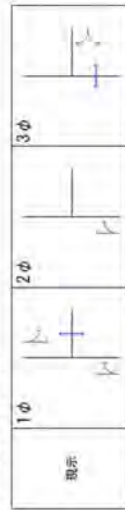

交差点概略図

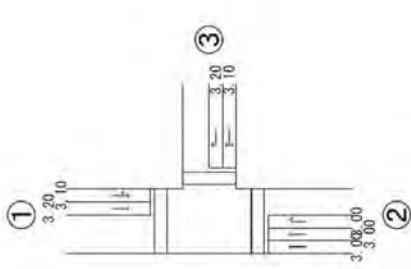

交通量図

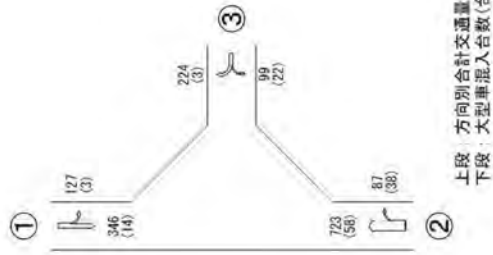

環境保全措置実施後の工事中交差点概略図

交差点概略図

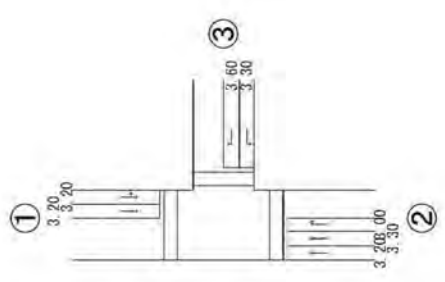

交通量図

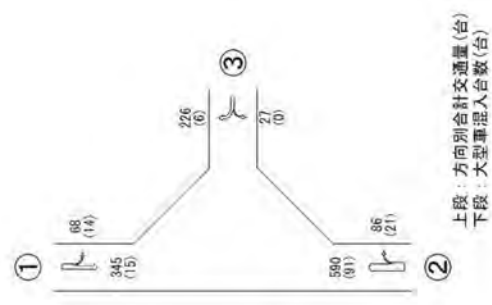

工事中(休日) 地域社会4 瀬谷上橋公園入口 17:00~18:00の需要率の算出

車線の種類	①		②		③	
	左折・直進	直進	直進	右折	右折	右折
車線の幅	1	1	2	1	1	1
飽和交通流量の基本値	S B	1643	1514	1506	1800	1604
車線幅員による補正率	α_w	1.000	1.000	1.000	1.000	1.000
(車線幅員)	m	(3.20)	(3.20)	(3.00)	(3.30)	(3.60)
縦断勾配による補正率	α_G	1.000	1.000	1.000	1.000	1.000
(縦断勾配)	%	(0.00)	(0.00)	(0.00)	(0.00)	(0.00)
大型車混入による補正率	α_T	0.937	0.970	0.903	0.854	1.000
(大型車混入率)	%	(9.68)	(4.35)	(15.42)	(24.42)	(0.00)
左折車混入による補正率	α_L	0.938				
(左折率)	L %	(32.9)				
(歩行者利用時間)	F D	0.12				
(歩行者利用時間)	秒	43				
機動歩行者による補正率	α_L	31				
(左折率)	R %				0.12	
(右折車の通過確率)	F				31	
(右折車時間)	秒				19	
(坂が変更目的のさげ台数割合)	KER				0.926	
(交差点内歩留台数)	K _i					
(交差点内歩留台数)	T _i /サイケル					
飽和交通流量	S A	1444	1594	2734	1286	1687
設計交通量	q	413	590	86	27	296
右折補正交通量 $\alpha R = N$						
流入部の需要率	μ	0.136	0.216	0.067	0.016	0.143
必要現示率	1 ϕ	0.136	0.176			0.176
	2 ϕ		0.040	0.067		0.067
	3 ϕ					0.143
有効待時間(秒)	1 ϕ	43	48			0.143
	2 ϕ		11	11		100
	3 ϕ					31
信号青時間比	G/C	43/100	59/100	11/100	31/100	31/100
可能交通容量	C _i	1306	1613	141	517	488
交通容量比	q/C _i	0.316	0.366	0.610	0.052	0.463
$X = K \times \frac{3600}{C}$						

現示方式の図示

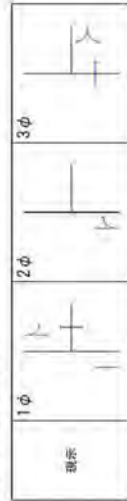

※ X = K × 3600 / C

※ X: 変1時間単位変化時右折車の捌け台数

※ q: 交通容量 (変1時間)

※ ****: 連続現示での使用現示

①: 至 上り市場線

②: 至 瀬谷駅

③:

資料 14.1 審査会に提出した資料

14.1-1 審査会に提出した資料

都市計画対象事業に関する準備書における横浜市環境影響評価審査会の開催状況及び概要は、表 14.1-1 に示すとおりです。

審査員からの質問に対する回答を、補足資料を用いて説明しました。その際に使用した資料を P. 資料 審査会-5 以降に掲載します。

表 14.1-1(1) 都市計画対象事業に関する審査会の開催状況及び概要

年月日	審査概要	参照頁
令和3年度	7月27日 【令和3年度 第8回横浜市環境影響評価審査会】 補足資料を用いた説明（事業者） 1. グリーンインフラの検討内容について 2. 排水施設計画と河川の切り回し及び暗渠化について 3. 現況を踏まえた予測・評価について 4. 関係車両の走行について 5. 転圧や植栽後のSS濃度について 6. アルカリ排水対策の内容について 7. 地盤改良材について 8. 堀谷戸川と和泉川を底質調査の対象外とした理由について 9. 地下水への影響について（防衛省による調査結果） 10. 汚染土壌の掘削除去を行う際の対応について 11. 囲繞景観の予測の前提条件について 12. 工事用車両の運行ルートについて	審査会-5
	8月31日 【令和3年度 第10回横浜市環境影響評価審査会】 補足資料を用いた説明（事業者） 13. 将来の土地利用について 14. 相沢川の暗渠化のイメージについて 15. 関係車両の走行に係る環境保全措置について 16. 転圧や植栽後のSS濃度について 17. 大門川及び相沢川の暗渠化による影響等について 18. 災害用井戸への影響について 19. 湧水の涵養源について 20. 汚染土壌の掘削除去に際しての河川水質対策 21. 相沢川における生育・生息環境確保及び対象措置 22. 草地環境の保全について 23. 農業振興地区の生態系機能について 24. 動植物の予測の考え方について 25. 建設発生土について 26. モニタリングの実施等について	審査会-25

表 14.1-1 (2) 都市計画対象事業に関する審査会の開催状況及び概要

	年月日	審査概要	参照頁
令和3年度	9月30日	<p>【令和3年度 第12回横浜市環境影響評価審査会】 補足資料を用いた説明（事業者）</p> <p>27. 公益的施設用地内の調整池について 28. 相沢川の水や事業実施区域内の降雨の流し方等について 29. 工事用車両運行ルートを検討及びこれに伴う騒音、地域社会への影響低減について 30. 将来の自動車交通量の需要予測について 31. 大門川及び相沢川の暗渠化による影響等について（継続） 32. 「地下水への影響について（防衛省による調査結果）」の誤記について 33. 農地間の空間における草地環境について 34. 動植物の予測の考え方について（継続） 35. 相沢川における生育・生息環境確保及び代償措置について（継続） 36. 和泉川源流部における生育・生息環境確保及び代償措置について 37. 対象事業実施区域内の眺望景観（遠景）について 38. 建設発生土について（継続） 39. 温室効果ガスの低減対策について 40. 瀬谷地内線に新設される交差点の交差点需要率について 41. モニタリングについて（継続）</p>	審査会-47
	10月27日	<p>【令和3年度 第14回横浜市環境影響評価審査会】 補足資料を用いた説明（事業者）</p> <p>42. 工事用車両運行に伴う地域社会への影響低減について（継続） 43. 地点No.7における将来交通量の内訳について 44. 瀬谷地内線における交差点需要率について（継続） 45. 防衛省による土壌汚染調査結果について</p>	審査会-81
	11月11日	<p>【令和3年度 第15回横浜市環境影響評価審査会】 補足資料を用いた説明（事業者）</p> <p>46. 建設発生土の指定処分について 47. 公益的施設用地における防災機能について 48. 桜並木の景観について 49. 鎌倉古道の一部改変に伴う人と自然との触れ合いの活動の場への影響について 50. 後背地との連続性に配慮した調整池について 51. 鳥類のねぐら調査の時間帯について 52. 大門川と相沢川を暗渠化した理由及び経緯 53. 国内における暗渠化の事例について 54. 相沢川の谷戸環境について</p>	審査会-115

表 14. 1-1 (3) 都市計画対象事業に関する審査会の開催状況及び概要

	年月日	審査概要	参照頁
令和3年度	11月29日	<p>【令和3年度 第16回横浜市環境影響評価審査会】 補足資料を用いた説明（事業者）</p> <p>55. 動植物の調査方法、調査地点について 56. 農業振興地区の生態系機能を踏まえた予測評価について 57. 大門川の暗渠化による影響等について 58. 桜並木の景観について（継続） 59. 鎌倉古道の一部改変に伴う人と自然との触れ合いの活動の場への影響について（継続） 60. 盛土の高さについて 61. 調整池4を地上式とした場合の影響について 62. 公益的施設用地における防災機能について</p>	審査会-135

旧上瀬谷通信施設地区土地区画整理事業 環境影響評価に関する補足資料

＜補足資料内容＞

1. グリーンインフラの検討内容について
2. 排水施設計画と河川の切り回し及び暗渠化について
3. 現況を踏まえた予測・評価について
4. 関係車両の走行について
5. 転圧や植栽後のSS濃度について
6. アルカリ排水対策の内容について
7. 地盤改良材について
8. 堀谷戸川と和泉川を底質調査の対象外とした理由について
9. 地下水への影響について（防衛省による調査結果）
10. 汚染土壌の掘削除去を行う際の対応について
11. 困繞景観の予測の前提条件について
12. 工事用車両の運行ルートについて

令和3年7月

横浜市

1. グリーンインフラの検討内容について

地区全体の「緑・環境・景観に関する方針」の策定に向けた、令和2年度からの検討状況については、次ページ以降に示す通りです。私有地も含めた地区全体で検討を行っているグリーンインフラの手法について、断面イメージと土地利用計画図に落とし込んでいます。本地区におけるグリーンインフラの手法については、今後も引き続き検討を行っていきます。

なお、道路などの公共用地におけるグリーンインフラについては、土地区画整理事業で公共用地を整備する際に実装を行っていき、私有地におけるグリーンインフラについては地区計画等を定める際の緑化率やグリーンインフラにおけるガイドラインを作成することなどによる実装を検討していきます。

また、準備書 p2-8 に示したD-D' 断面における現況高さ及び盛土厚については、以下に示す通りです。

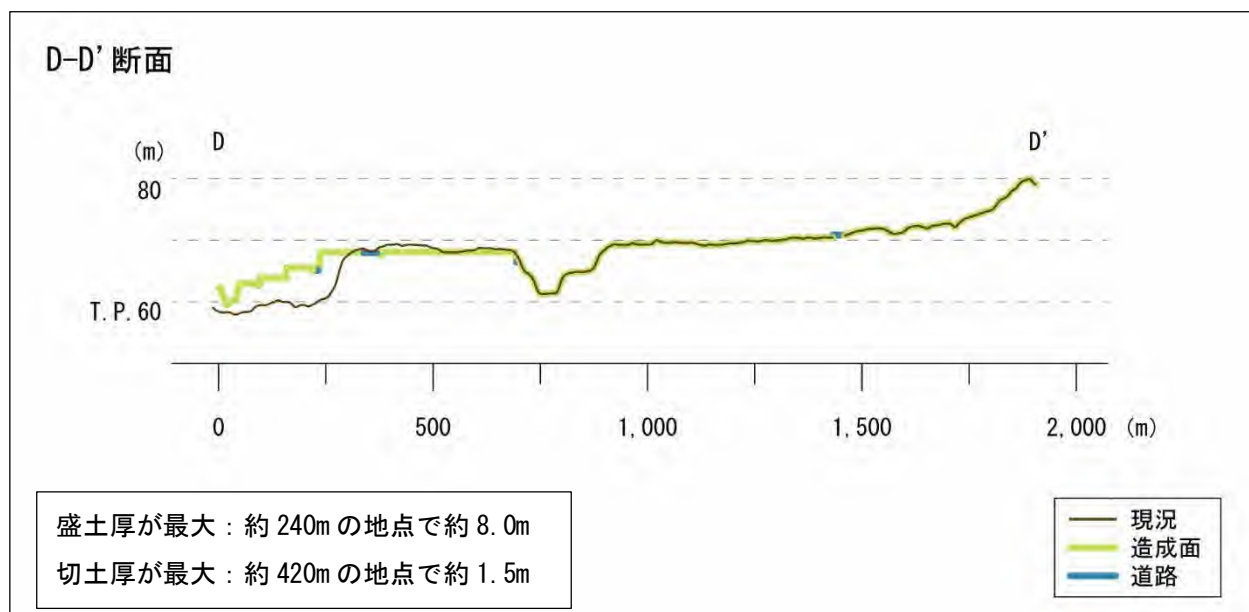

■グリーンインフラを活用したまちづくりの検討内容

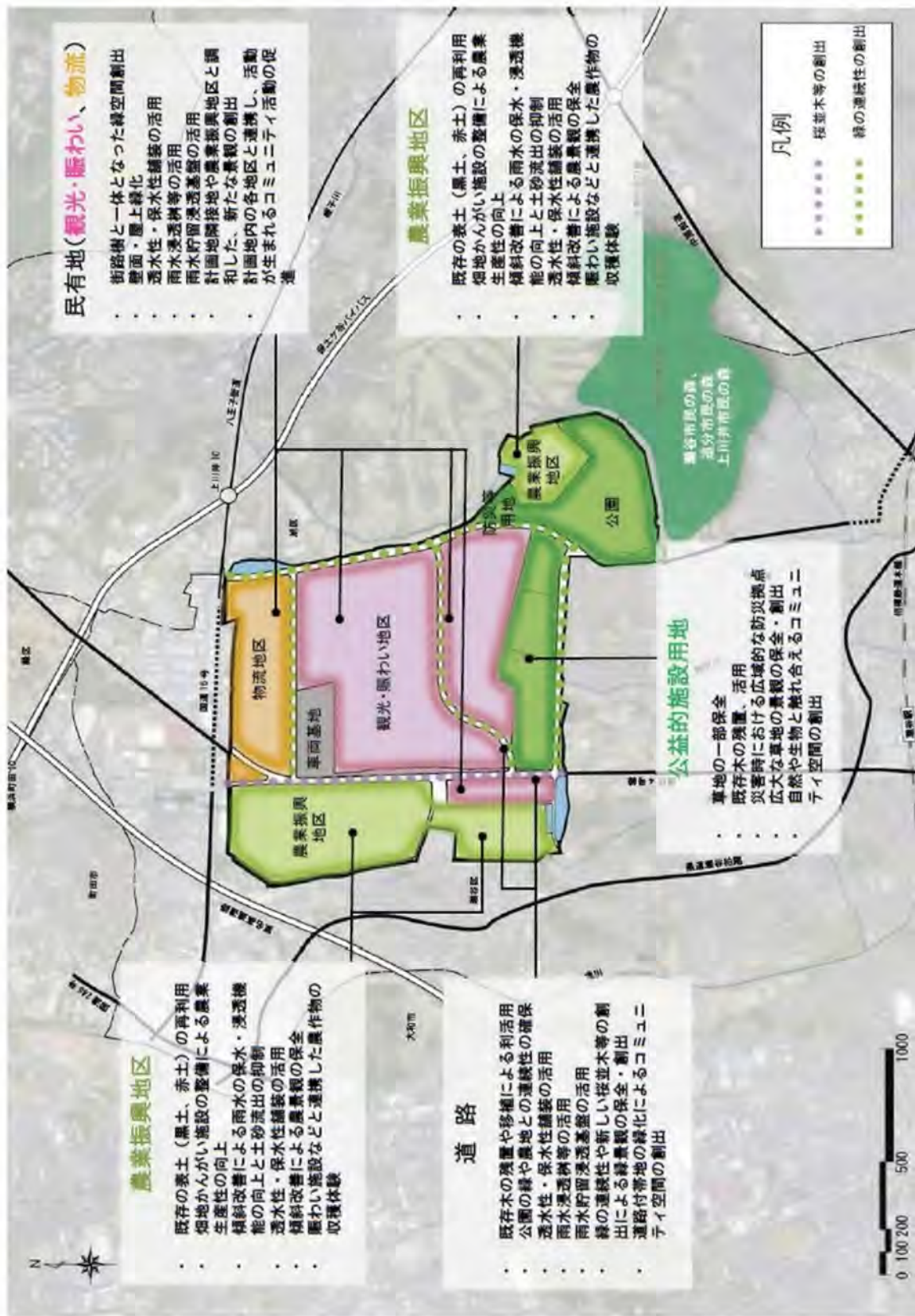

■グリーンインフラを活用したまちづくりの検討内容



	農業振興地区	道路	民有地 (観光・賑わい、物流)	公益的施設用地
環境保全 ・改善	<ul style="list-style-type: none"> 既存の表土（黒土、赤土）の再利用 畑地かんがい施設の整備による農業生産性の向上 	<ul style="list-style-type: none"> 既存木の残置や移植による利活用 公園の緑や農地との連続性の確保 	<ul style="list-style-type: none"> 街路樹と一体となった緑空間創出 壁面・屋上緑化 	<ul style="list-style-type: none"> 草地の一部保全 既存木の残置、活用
防災・減災	<ul style="list-style-type: none"> 傾斜改善による雨水の保水・浸透機能の向上と土砂流出の抑制 透水性・保水性舗装の活用 	<ul style="list-style-type: none"> 透水性・保水性舗装の活用 雨水浸透樹等の活用 雨水貯留浸透基盤の活用 	<ul style="list-style-type: none"> 透水性・保水性舗装の活用 雨水浸透樹等の活用 雨水貯留浸透基盤の活用 	<ul style="list-style-type: none"> 災害時における広域的な防災拠点
景観	<ul style="list-style-type: none"> 傾斜改善による農景観の保全 	<ul style="list-style-type: none"> 緑の連続性や新しい桜並木等の創出による緑景観の保全・創出 	<ul style="list-style-type: none"> 計画地隣接地や農業振興地区と調和した、新たな景観の創出 	<ul style="list-style-type: none"> 広大な草地の景観の保全・創出
グリーン コミュニティ	<ul style="list-style-type: none"> 賑わい施設などと連携した農作物の収穫体験 	<ul style="list-style-type: none"> 道路付帯地の緑化によるコミュニティ空間の創出 	<ul style="list-style-type: none"> 計画地内の各地区と連携し、活動が生まれるコミュニティ活動の促進 	<ul style="list-style-type: none"> 自然や生物と触れ合えるコミュニティ空間の創出

2. 排水施設計画と河川の切り回し及び暗渠化について



図 調整池の位置及び河川切り回しルート

表 調整池の容量及び集水区域面積

名称	流域	集水区域面積 (ha)	調整池容量 (m ³)
調整池 1	堀谷戸川	約 36.6	約 26,400
調整池 2	堀谷戸川	約 7.9	約 5,700
調整池 3	相沢川	約 81.8	約 58,900
調整池 4	和泉川	約 21.2	約 15,200
調整池 5	大門川	約 57.0	約 41,000
調整池 6	大門川	約 33.7	約 24,300

まとまった土地利用を行うにあたり、河川による土地の分断を避けるため、相沢川については、新たに整備する区域内道路の下に切り回し、暗渠化する計画です。また、大門川についても、なるべく平坦な農地環境を創出するため、道路の下に切り回し、暗渠化する計画です。

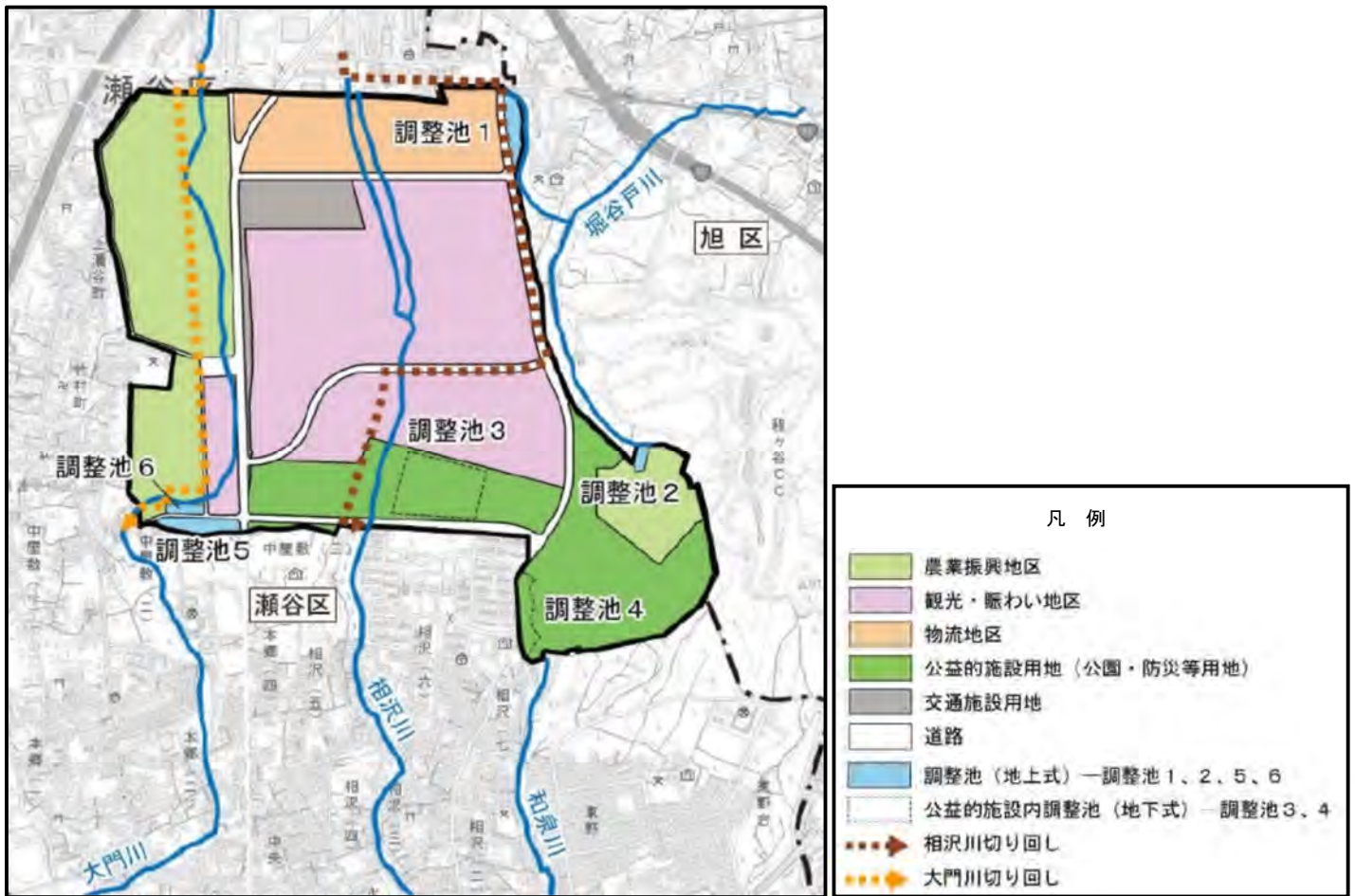
なお、対象事業実施区域内の雨水については、今後、関係部署と協議をしていきますが、各流域の調整池に適切に流入する計画です。

また、河川への雨水の流出量を抑制する措置として、表に示すとおり、対象事業実施区域内の6か所に30年確率降雨に対応する調整池を適切に設置します。なお、超過降雨に対しては、ハザードマップの周知等のソフト対策を活用していきます。

3. 現況を踏まえた予測・評価について

大気質、騒音、振動及び地域社会の予測評価項目において、現況値と予測値並びにそれらの数値が環境基準、規制基準等の目標となる数値を満足しているかどうか、さらに現況値と予測値を比較した結果を下表に示します。

表 現況値と予測値との比較

予測評価項目			現況値		予測値		現況値と予測値の比較 ^{※1}	
大気質	建設機械の稼働	二酸化窒素	ppm	0.031 ^{※2}	○	0.048	×	0.017 (寄与率 ^{※3} : 43.5%)
		浮遊粒子状物質	mg/m ³	0.050 ^{※2}	○	0.052	○	0.002 (寄与率 ^{※3} : 8.7%)
		降下ばいじん	t/km ² /月	* ^{※4}	○	5.7~9.6	○	
	工事用車両の運行	二酸化窒素	ppm	0.030777 ^{※2}	○	0.032266~ 0.035794	○	0.001489~0.005017 (寄与率 ^{※3} : 0.2~2.7%)
		浮遊粒子状物質	mg/m ³	0.049607 ^{※2}	○	0.049683~ 0.050001	○	0.000076~0.000394 (寄与率 ^{※3} : 0.01~0.19%)
		降下ばいじん	t/km ² /月	* ^{※4}	○	0.1~3.4	○	
関係車両の走行	二酸化窒素	ppm	0.030777 ^{※2}	○	0.031510~ 0.033218	○	0.000733~0.002441 (寄与率 ^{※3} : 3.32~10.00%)	
	浮遊粒子状物質	mg/m ³	0.049607 ^{※2}	○	0.049638~ 0.049766	○	0.000031~0.000159 (寄与率 ^{※3} : 0.11~0.54%)	
騒音	建設機械の稼働		dB	* ^{※4}	○	69	○	
	工事用車両の運行 ^{※5}		dB	65.7~72.7	—	65.9~73.5	—	0.1~1.9
	関係車両の走行 ^{※6}		dB	昼 58~73 夜 50~72	—	昼 64.6~72.9 夜 57.9~72.9	—	昼 -0.7~6.9 夜 -2.5~6.7
振動	建設機械の稼働		dB	* ^{※4}	○	61	○	
	工事用車両の運行		dB	昼 47.6~57.9 夜 45.1~55.8	○	昼 47.6~58.9 夜 46.2~56.4	○	昼 0~2.3 夜 0.6~3.2
	関係車両の走行		dB	昼 36~58 夜 32~59	○	昼 46.0~53.3 夜 44.8~52.7	○	昼 -5.1~9.0 夜 -14.2~9.8
地域社会	工事用車両の運行	交差点需要率 ^{※7}		平 0.457~0.793 休 0.313~0.680	○	平 0.513~1.114 休 0.374~0.959	—	平 0.011~0.321 休 0.000~0.347
		交通容量比 ^{※8}		平 0.031~1.116 休 0.025~0.969	—	平 0.031~2.631 休 0.025~2.437	—	平 0.000~1.894 休 0.000~1.948
	関係車両の走行	交差点需要率		平 0.485~0.793 休 0.338~0.680	○	平 0.302~0.774 休 0.260~0.731	○	平 -0.398~0.211 休 -0.400~0.170
		交通容量比		平 0.031~1.116 休 0.037~0.969	○	平 0.000~0.987 休 0.000~0.975	○	平 -0.704~0.449 休 -0.647~0.500

注：○印、×印は、環境基準等の数値を満足しているか又はしていないかを示します。

※：1. 地点別に現況値から予測値の増分を求め、その最小値と最大値を示しました。

2. バックグラウンド濃度（二酸化窒素：0.013ppm、浮遊粒子状物質：0.021mg/m³）に準備書 p.9.1-25 の表 9.1-25 に示しました年平均値から日平均値への換算式を用いて、二酸化窒素は日平均値の年間98%値、浮遊粒子状物質は日平均値の年間2%除外値を示しました。

3. 寄与率は、準備書に記載されている数値（年平均値から求めた数値）を記載しています。

4. *の予測評価項目は、予測値と比較できる現況値ではないため、現況値を記載していません。

5. 地点により○、×があるので—と示しました。詳細は準備書 p.9.2-27 をご覧ください。

6. 地点により○、×があるので—と示しました。詳細は準備書 p.9.2-37 をご覧ください。

7. 地点により○、×があるので—と示しました。詳細は準備書 p.9.17-49 をご覧ください。

8. 地点により○、×があるので—と示しました。詳細は準備書 p.9.17-50,51 をご覧ください。

前掲表に示すようにほぼ全ての予測評価項目において、現況値に比べて予測値の方が大きな値を示しています。

そこで、準備書に記載している「事業者により実施できる環境保全措置」はもちろんのこと、電気自動車、燃料電池等の走行時に環境負荷の小さい車両の導入や、車両の出入口の分散化などを上物事業者に促すなどの対応を進めていきます。

特に注意しなければいけないのが、①大気質・建設機械の稼働・二酸化窒素、②騒音・工事用車両の運行、③騒音・関係車両の走行、④地域社会・工事用車両の運行・交差点需要率及び⑤地域社会・工事用車両の運行・交通容量比と考えます。これら5つの予測評価項目は、現況値は目標となる数値を満足していますが予測値はその値を満足していない結果となっています。

よって、①大気質・建設機械の稼働・二酸化窒素については、評価書において該当する部分の記述を修正したいと考えます。(修正箇所とその内容については、下記のとおりとします。)②騒音・工事用車両の運行、④と⑤の地域社会・工事用車両の運行については、工事用車両の運行ルートを再検討し、目黒交番前交差点の負荷を少しでも抑えられるように検討し、事業者の実行可能な範囲内で、できる限りの影響の低減に努めます。③騒音・関係車両の走行については、準備書 p. 9. 2-34 に記載した環境保全措置(公共交通機関の利用促進、車両の効率的な利用促進)が行われるように将来の土地利用者に促していきます。

環境影響評価を行う事業者の姿勢として、実行可能な範囲内でできる限り環境への影響を抑えることが大切であることを再認識して、本事業の検討や必要となる手続きに取り組んでいきます。

○評価書の修正箇所と内容について

- ・ p. 9. 1-26 ②評価結果 イ. 国又は地方公共団体による基準又は目標との整合による評価の文章を以下のとおり修正します。

建設機械の稼働に伴う二酸化窒素の予測結果と環境基準の比較は、表 9. 1-26 に示すとおりです。

対象事業実施区域周辺の二酸化窒素の濃度(バックグラウンド濃度)は、0. 013ppm です。これは、瀬谷区南瀬谷小学校測定局の年平均値の5年間の平均値であり、日平均値の年間98%値に換算すると0. 031ppmとなり、0. 04ppmを下回っている地域です。

二酸化窒素の予測結果(日平均値の年間98%値)は0. 048ppmであり、環境基準の範囲(0. 04~0. 06ppm)内には入っているものの、環境省の通達「二酸化窒素に係る環境基準の改定について」(環大企262号 昭和53年7月)では、「1日平均値が0. 04ppm以下の地域にあっては、原則として0. 04ppmを大きく上回らないよう防止に努めるよう配慮されたい。」とされているため、環境基準との整合が完全に図られているとは言い難いと評価します。また、横浜市環境目標値(0. 04ppm)についても整合が図られていません。

よって、表 9.1-23 に記しました環境保全措置の実施を徹底し、建設機械の稼働に伴う二酸化窒素の低減を図ります。

建設機械の稼働に伴う浮遊粒子状物質の～（以下、準備書の文章のまま）

・上記の修正内容を受けて、二酸化窒素の環境基準を記載している以下の3箇所について波線の文章を追記します。

1)p. 9.1-25 (3)評価 ①評価手法 イ. 国又は地方公共団体による基準又は目標との整合による評価

●二酸化窒素(日平均値の年間98%値)：0.04～0.06ppm内、又はそれ以下※

※「1日平均値が0.04ppm以下の地域にあつては、原則として0.04ppmを大きく上回らないよう防止に努めるよう配慮されたい。」(環境省通達「二酸化窒素に係る環境基準の改定について」(環大企262号 昭和53年7月)より抜粋)

2)p. 9.1-25 表 9.1-24 二酸化窒素及び浮遊粒子状物質の環境基準

表 9.1-24 二酸化窒素及び浮遊粒子状物質の環境基準

昭和48年環境庁告示第25号
昭和53年環境庁告示第38号

物質	環境上の条件	評価方法(長期的評価)
二酸化窒素	1時間値の1日平均値が0.04ppmから0.06ppmまでのゾーン内又はそれ以下であること。※	1年間の測定を通じて得られた1日平均値のうち、低い方から数えて98%(日平均値の年間98%値)を環境基準と比較して評価を行う。
浮遊粒子状物質	1時間値の1日平均値が0.10mg/m ³ 以下であり、かつ、1時間値が0.20mg/m ³ 以下であること。	1年間の測定を通じて得られた1日平均値のうち、高い方から数えて2%の範囲にあたる測定値を除外した後の最高値(日平均値の年間2%除外値)を環境基準と比較して評価を行う。ただし、上記の評価方法にかかわらず1日平均値について環境基準を超える日が2日以上連続した場合には非達成と評価する。

※：「1日平均値が0.04ppm以下の地域にあつては、原則として0.04ppmを大きく上回らないよう防止に努めるよう配慮されたい。」(環境省通達「二酸化窒素に係る環境基準の改定について」(環大企262号 昭和53年7月)より抜粋)

3)p. 9. 1-26 表 9. 1-26 二酸化窒素の予測結果と環境基準との比較

表 9. 1-26 二酸化窒素の予測結果^{※1}と環境基準との比較

単位：ppm

予測地点	年平均値	日平均値の年間 98%値	環境基準
最大寄与濃度出現地点	0.023	0.048	1時間値の1日平均値が 0.04ppmから0.06ppmまでの ゾーン内又はそれ以下であ ること。 ^{※2}

※：1. 予測結果（年平均値）は、バックグラウンド濃度（0.013ppm）を含みます。

2. 「1日平均値が0.04ppm以下の地域にあっては、原則として0.04ppmを大きく上回らないよう防止に努めるよう配慮されたい。」（環境省通達「二酸化窒素に係る環境基準の改定について」（環大企262号 昭和53年7月）より抜粋）

4. 関係車両の走行について

本事業に係る環境影響評価は、土地区画整理事業として実施される「工事の実施」や「土地又は工作物の存在及び供用」について、予測・評価を行うものですが、令和2年3月に策定した「旧上瀬谷通信施設土地利用基本計画」において、将来的には年間1,500万人が訪れることを見込んでいることから、「観光・賑わい地区」や「物流地区」への従業者や来客者による「関係車両の走行」についても、環境影響評価項目として選定しました。

観光・賑わい地区や物流地区に建設される上物については、その施設の規模が市条例の規模要件を満たす場合は、将来の土地利用者が環境影響評価を実施することとなります。

従って、土地区画整理事業者としては、将来の土地利用者に公共交通機関の利用促進や関係車両の効率的な管理等による車両の効率的な利用促進をお願いすることで、関係車両の走行における影響について低減を図っていきたいと考えています。

道路の通行規制等については、交通管理者と必要に応じて、今後、協議していくこととなります。

なお、社会情勢を勘案すると、温室効果ガス低減の施策とも関連して、電気自動車や燃料電池車などの一層の普及や車両の軽量化等も期待でき、これらによる自動車単体の低騒音化も期待できます。

5. 転圧や植栽後のSS濃度について

準備書における水の濁りの予測に当たっては、SSの初期濃度2,000mg/Lと高濃度の条件を設定しているほか、和泉川の地点については、土砂の沈降特性は土質1地点（武蔵野ローム層で粘土質主体）の結果を用いて、土砂の残留率が高くなる条件により予測をしており、現況を上回る濃度となっています。

そのため、本事業で環境保全措置として実施する、造成箇所の速やかな転圧や植栽の効果について予測しました。

予測の前提条件及び予測結果は次に示すとおりです。

(1) 予測の前提条件

ア 流出係数

「流出雨水量の最大値を算定する際に用いる土地利用形態ごとの流出係数を定める告示」（平成16年国土交通省告示第521号）に示す土地利用の形態の区分のうち、「人工的に造成され植生に覆われた法面」を適用して、0.4としました。

イ SSの初期濃度

国総研資料第594号『道路環境影響評価技術手法「7.水質 7.4切土工事等、工事施工ヤードの設置、及び工事用道路等の設置に係る水の濁り」に関する参考資料』によると、植栽したばかりの法面では、濁水を抑える効果が十分に現れることが明らかになっています。

上記資料に掲載されている事例では、累積雨量65.5mmで、裸地法面では平均で310mg/Lに対し、植栽法面では平均で20mg/Lとなっており、約9割の削減となっています。

従って、環境保全措置を行うことで、少なくとも1割程度の初期濃度削減が図られると想定し、SSの初期濃度を1,800mg/Lと仮定しました。

(2) 予測結果

$$Q = A \times f \times I / (1,000 \times 60) = 211,800 \times 0.4 \times 7.1 / 60,000 = 10.0 \text{ (m}^3/\text{min)}$$

$$T = V / Q = 15,200 / 10.0 = 1,520 \text{ (min)}$$

1,520分後の仮設調整池出口での土砂の残留率Pは、

$$P = 748.27 \times 1,520^{-0.463} / 2,000 \times 100 = 1.26\%$$

となり、初期濃度を1,800mg/Lとした場合の仮設調整池出口でのSS濃度は以下の通りです。

$$\text{SS濃度} = 1,800 \times 1.26 / 100 = 22.68 \text{ mg/L}$$

従って、法面植栽等により、初期濃度を1割削減することにより、現況SS濃度の23mg/L以下となるため、現況を悪化させないものと考えます。

6. アルカリ排水対策の内容について

アルカリ排水対策の具体的な内容については、今後の詳細な施工計画立案時において検討しますが、現時点では以下に示すとおりです。

- ・プレキャスト製品の活用により、現場でのコンクリート打設量は必要最小限とします。
- ・調整池の工事等でやむを得ずコンクリートの打設を行う場合は中和剤を用いますが、その際は、劇物、危険物に該当しない無機酸系の中和剤を積極的に利用します。
- ・作業員には安全教育の一環として、中和剤の取り扱いに関する留意点（原液を河川に漏らさないこと、作業時の服装等）を徹底します。
- ・中和剤使用による仮設調整池下流側でのCOD上昇等による水質悪化や生態系への影響を未然防止に留意します。
- ・温室効果ガス排出量削減等の観点から、炭酸ガスの投入による中和は回避します。
- ・中和については、排水の水質（pH、SS等）を考慮した排水処理施設を設置し、処理の流れは次のとおりです。

- ① 排水量を確認します。
- ② 排水のpH値を測定します。
- ③ 投入量の目安表より中和剤を計量します。（目安表は中和剤に添付されています。）
- ④ 排水に計量した中和剤を添加します。
- ⑤ 添加後、全体に混ざるように良く攪拌します。（30秒程度）
- ⑥ pH値を測定します。
- ⑦ 排水基準値内であれば処理完了、pH値が排水基準を満足しない場合は、手順③より再度調整を行います。

※準備書では自然沈殿方式を前提として水の濁りの予測を行っていますが、必要に応じて沈殿装置を設置することとし、今後詳細施工計画で決定します。

7. 地盤改良材について

セメント系固化材を地盤改良に用いる場合は、六価クロム溶出量低減型の汎用固化材を用います。

（製品名の例 ジオセット200、タフロック3E型等）

なお、その際、「セメント及びセメント系固化材を使用した改良土の六価クロム溶出試験要領（案）の一部変更について」（国官技第16号 国営建第1号 平成13年4月20日 国土交通省大臣官房技術調査課長、国土交通省大臣官房官庁営繕部建築課長）に基づき、溶出試験を行い、土壌の汚染に係る環境基準値以下であることを確認します。

8. 堀谷戸川と和泉川を底質調査の対象外とした理由について

都市計画対象事業では、各河川の流域ごとに調整池（工事中は仮設調整池）を配置し、降雨時の土砂が直接そのまま当該河川に流れ込むことはないため、方法書段階で河道の改修工事を行うことが想定されており、改修箇所の下流側の底質への影響が懸念された相沢川と大門川の対象事業実施区域下流側の地点で調査を行うことを計画し、これに従い調査を行いました。

なお、準備書の P.9.5-7 の脚注に記載のように、都市計画対象事業の工事中においては、仮設調整池により土砂を沈降させた後、公共用水域に放流することから、底質汚染は主に水の汚れを介して生じると考えられます。そのため、底質汚染の監視は、水質（水の汚れ）を定期的に監視することにより効果的に把握できるものと考えます。水質の監視は、事後調査として堀谷戸川、和泉川についても行いますので、堀谷戸川、和泉川についても、事後調査で水の汚れが確認された場合は、その状況に応じて底質汚染の確認も行う予定であり、その旨を評価書に記載します。

9. 地下水への影響について（防衛省による調査結果）

防衛省により国有地において地下水調査が行われた地点の調査場所と調査結果（地下水だけでなく、土壌汚染の調査結果も併記しています。）については、次ページ以降に示すとおりであり、土壌溶出量が指定基準を超過した 23 区画（鉛及びその化合物 21 区画、砒素及びその化合物 1 区画、ふっ素及びその化合物 1 区画）の全てにおいて地下水が確認され、調査がなされていますが、地下水汚染は現状では見られていません。

対象事業実施区域及びその周辺の地下水の流向について直接観測したデータはありませんが、大門川沿いでは、資料編（P.資料 地下水-2、図 9.6-1(1)）に示すように、広域的な地下水帯水層となりうる洪積砂礫層（図中の凡例 Dg）の傾きに沿って北から南への流れになるものと推定されます。相沢川沿いにおいては、資料編（P.資料 地下水-3、図 9.6-1(2)）に示すように、大門川沿いほど顕著ではありませんが、地質 6（準備書 P.9.6-2 参照）の南側においては同様な傾向がみられます。当該洪積砂礫層は概ね GL-15m 以深に分布しています。一方、防衛省による調査では、GL-10m 程度よりも浅い位置において確認されている地下水層は武蔵野ローム層又は表層の沖積層の中にある宙水を採取しているものと考えられます。

防衛省による調査結果で汚染土壌が確認された範囲は、大半が深度 2m 以下の地表面近くであり、最も深い和泉川の源流部付近の 1 区画においても深度 8、9m での確認となっていることから、洪積砂礫層内に分布すると推定される GL-15m 以下の帯水層には影響が及ぶことはないと考えています。

民有地における地下水の水質の調査は、ふっ素及びその化合物の土壌溶出量調査結果が指定基準を上回った 20 区画のうち、地下水が確認された 10 区画で行われており、その結果はいずれも定量下限値（0.08mg/L）未満でした。なお、地下水位（孔内水位）は、多くの地点が GL-7m 以深にあり、国有地よりも深い値でした。

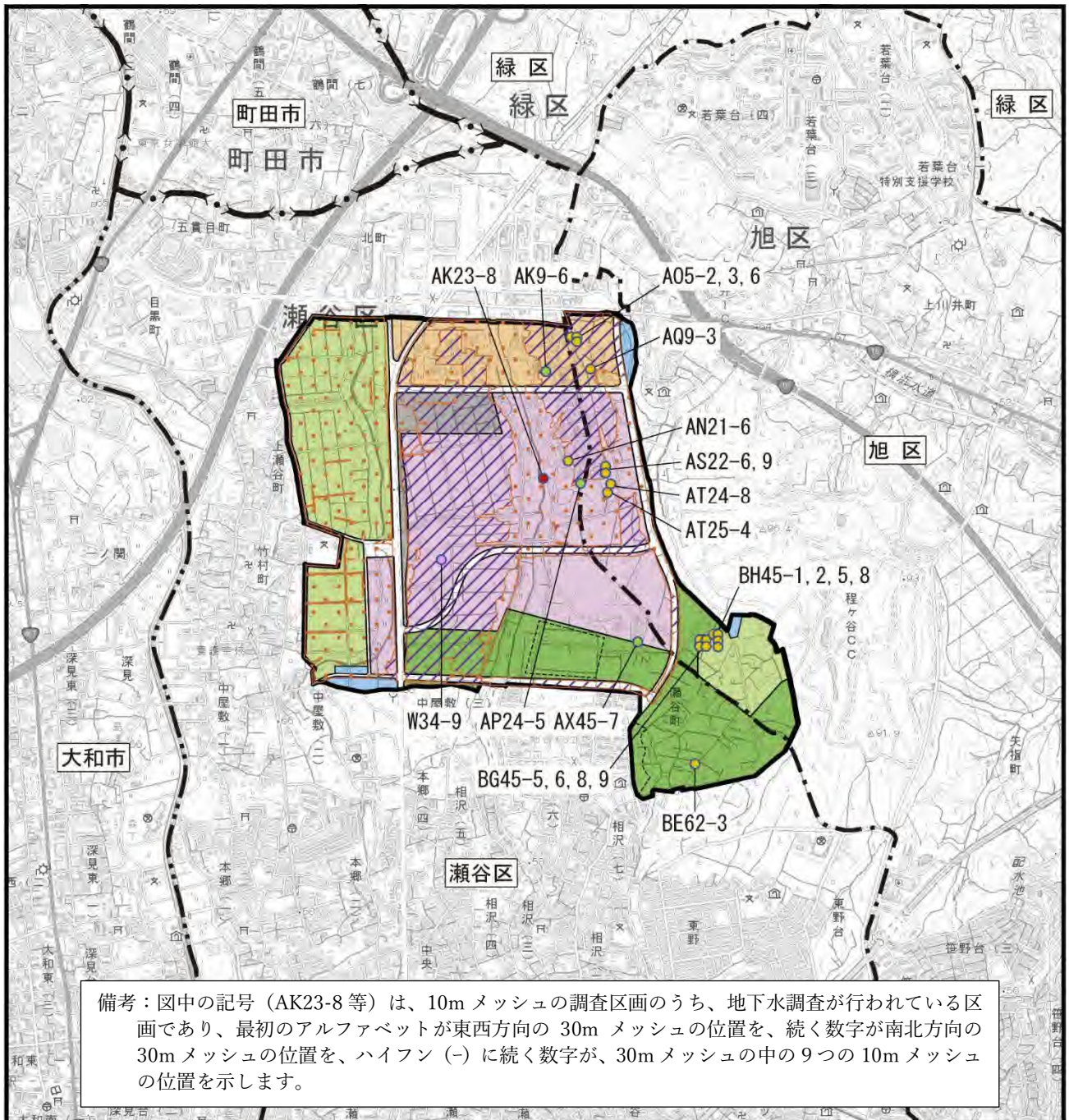

凡例

- 対象事業実施区域
- 都県界
- 市界
- 区界
- 農業振興地区
- 観光・賑わい地区
- 物流地区
- 公益的施設用地（公園・防災等用地）
- 交通施設用地
- 道路
- 調整池（地上式）
- 公益的施設内調整池（地下式）
- 盛土
- 切土
- 鉛（土壌溶出量）基準超過地点
- 鉛（土壌溶出量・含有量）基準超過地点
- ひ素（土壌溶出量）基準超過地点
- ふっ素（土壌溶出量）基準超過地点

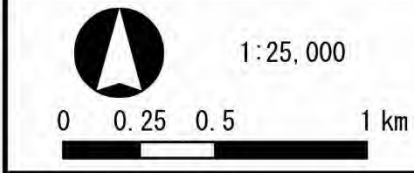

注：○は、汚染土壌が確認された区画の概略位置を見やすさの観点から、強調して示すものです。

図 地下水汚染の調査実施場所（国有地）

表 土壌分析結果一覧表（鉛 土壌溶出量、地下水（mg/L））

深度（m）	AK9-6	AN21-6	A05-2	A05-3	A05-6	AP24-5	AQ9-3	AS22-6
0～0.05 0.05～0.5	0.019	0.014	0.042	0.056	0.013	0.025	0.024	0.029
旧地盤	—	—	—	—	—	—	—	—
1.0	<0.001	<0.001	<0.001	<0.001	<0.001	<0.001	<0.001	<0.001
2.0	<0.001	<0.001	<0.001	<0.001	<0.001	<0.001	<0.001	<0.001
3.0	0.006	<0.001	<0.001	<0.001	<0.001	<0.001	<0.001	<0.001
4.0	<0.001	<0.001	<0.001	<0.001	<0.001	<0.001	<0.001	<0.001
5.0	<0.001	<0.001	<0.001	<0.001	<0.001	<0.001	0.004	0.006
6.0	0.003	<0.001	<0.001	<0.001	<0.001	<0.001	<0.001	<0.001
7.0	<0.001	<0.001	<0.001	<0.001	<0.001	0.002	<0.001	<0.001
8.0	0.001	<0.001	<0.001	<0.001	<0.001	<0.001	<0.001	0.001
9.0	0.001	<0.001	<0.001	0.002	<0.001	<0.001	<0.001	<0.001
10.0	0.001	<0.001	<0.001	0.001	0.001	<0.001	<0.001	<0.001
地下水位(m)	-3.5	-3.3	-4.5	-4.3	-4.7	-5.4	-1.8	-3.1
地下水質	<0.001	<0.001	<0.001	<0.001	<0.001	<0.001	<0.001	<0.001
基準	0.01 以下							
定量下限値	0.001							
深度（m）	AS22-9	AT24-8	AT25-4	AX45-7	BE62-3	BG45-5	BG45-6	BG45-8
0～0.05 0.05～0.5	0.024	0.011	0.011	0.014	0.014	0.068	0.069	0.037
旧地盤	—	—	—	—	—	—	—	—
1.0	<0.001	0.008	0.005	<0.001	<0.001	<0.001	<0.001	<0.001
2.0	<0.001	<0.001	<0.001	<0.001	<0.001	0.001	<0.001	<0.001
3.0	<0.001	<0.001	<0.001	<0.001	<0.001	0.005	<0.001	<0.001
4.0	<0.001	<0.001	0.004	<0.001	<0.001	<0.001	<0.001	<0.001
5.0	<0.001	<0.001	<0.001	<0.001	<0.001	<0.001	<0.001	<0.001
6.0	0.002	<0.001	<0.001	0.001	<0.001	<0.001	0.001	<0.001
7.0	0.001	<0.001	0.001	<0.001	0.001	0.001	0.001	0.001
8.0	<0.001	<0.001	<0.001	<0.001	0.021	<0.001	0.001	0.002
9.0	0.001	<0.001	<0.001	0.001	0.018	<0.001	0.001	<0.001
10.0	<0.001	<0.001	<0.001	0.001	0.008	<0.001	<0.001	<0.001
地下水位(m)	-2.8	-2.5	-0.2	-1.1	-2.3	-1.4	-1.0	-1.2
地下水質	<0.001	<0.001	<0.001	<0.001	<0.001	<0.001	<0.001	<0.001
基準	0.01 以下							
定量下限値	0.001							
深度（m）	BG45-9	BH45-1	BH45-2	BH45-5	BH45-8			
0～0.05 0.05～0.5	0.056	0.013	0.014	0.020	0.040			
旧地盤	—	—	—	—	—			
1.0	<0.001	<0.001	<0.001	<0.001	<0.001			
2.0	<0.001	<0.001	<0.001	<0.001	<0.001			
3.0	<0.001	<0.001	<0.001	<0.001	<0.001			
4.0	<0.001	<0.001	<0.001	<0.001	<0.001			
5.0	<0.001	<0.001	<0.001	<0.001	<0.001			
6.0	<0.001	<0.001	<0.001	<0.001	<0.001			
7.0	0.001	<0.001	<0.001	<0.001	<0.001			
8.0	<0.001	<0.001	<0.001	<0.001	<0.001			
9.0	<0.001	<0.001	<0.001	<0.001	<0.001			
10.0	<0.001	<0.001	<0.001	<0.001	<0.001			
地下水位(m)	-1.8	-1.5	-1.4	-1.3	-1.5			
地下水質	<0.001	<0.001	<0.001	<0.001	<0.001			
基準	0.01 以下							
定量下限値	0.001							

※表中の赤字は基準不適合の値を示します。

※表層（深度0～0.5m）は平成29年度調査結果、その他は平成元年度調査結果によります。

※表層は、0～0.05mの土壌と0.05～0.5mの土壌を等量混合した試料を分析しています。

※地下水位は孔内水位で、地表からの深度を示します。

表 土壌分析結果一覧表
(砒素 土壌溶出量、地下水 (mg/L))

深度 (m)	AK23-8	
0~0.05 0.05~0.5	0.017	
旧地盤	—	
1.0	<0.001	
2.0	0.001	
3.0	<0.001	
4.0	<0.001	
5.0	<0.001	
6.0	<0.001	
7.0	0.001	
8.0	<0.001	
9.0	<0.001	
10.0	<0.001	
地下水位(m)	-1.7	
地下水質	<0.001	
基準	0.01 以下	
定量下限値	0.001	

※表中の赤字は基準不適合の値を示します。
 ※表層（深度0~0.5m）は平成29年度調査結果、
 その他は平成元年度調査結果によります。
 ※表層は、0~0.05mの土壌と0.05~0.5mの土壌
 を等量混合した試料を分析しています。
 ※地下水位は孔内水位で、地表からの深度を示します。

表 土壌分析結果一覧表
(ふっ素 土壌溶出量、地下水 (mg/L))

深度 (m)	W34-9	
0~0.05 0.05~0.5	0.94	
旧地盤	—	
1.0	0.09	
2.0	0.09	
3.0	0.11	
4.0	0.21	
5.0	<0.08	
6.0	<0.08	
7.0	<0.08	
8.0	<0.08	
9.0	0.10	
10.0	<0.08	
地下水位(m)	-3.4	
地下水質	<0.08	
基準	0.8 以下	
定量下限値	0.08	

※表中の赤字は基準不適合の値を示します。
 ※表層（深度0~0.5m）は平成29年度調査結果、
 その他は平成元年度調査結果によります。
 ※表層は、0~0.05mの土壌と0.05~0.5mの土壌
 を等量混合した試料を分析しています。
 ※地下水位は孔内水位で、地表からの深度を示します。

10. 汚染土壌の掘削除去を行う際の対応について

■ 準備書 P. 9. 9-8 「⑤ア. 予測の前提条件」における記述内容

土壌汚染対策法に則り掘削除去を行う場合、汚染土壌の運搬は、「汚染土壌の運搬に関するガイドライン（改訂第4版）」（環境省 水・大気環境局 土壌環境課 平成 31 年3月）に準じるものとし、運搬時の汚染土壌の飛散防止対策を十分に講じるものとします。汚染土壌の処理・処分は、「土壌汚染対策法に基づく調査及び措置に関するガイドライン（改訂第3版）」（環境省 水・大気環境局 土壌環境課 平成 31 年3月）に準じ、汚染土壌処理施設（浄化等処理施設又は管理型埋立処分場等）にて行うものとします。

① 掘削除去を行う際の周辺環境保全対策

掘削除去等の措置を実施するにあたっては、周辺環境保全計画を立案します。

- ・ 周辺環境保全対策の施行体制（責任者と平常時、緊急時の体制等、緊急対応策）をあらかじめ立案します。
- ・ 地下水の水質と水位を測定します。測定場所については、準備書 P. 11-2（表 11-1(1)）の地下水の水質とリンクさせて検討するものとし、下流側の地下水の揚水状況^注等を踏まえて適切に設定します。
- ・ 掘削時に基準不適合土壌又は特定有害物質が飛散、揮散しないよう、基準不適合土壌又は特定有害物質の飛散等の防止対策を講じます。（現場の状況に応じ、散水、養生シートの敷設等）
- ・ 詰替えまでの仮置き期間中、飛散等及び異臭の発散の防止措置を行うとともに、当該場所に新たな汚染が生じないように、地下浸透防止措置を行います。
- ・ 作業員の靴、手袋、衣服、車両のタイヤ及び使用機材等に特定有害物質が付着し、周囲の環境に持ち出されることがないように、洗浄施設等の適切な対策を講じます。
- ・ 地下浸透防止措置の実施、又は集水渠を設けるなどの対策を行うとともに、周辺河川の水質や流量の測定を行います。測定場所については、準備書 P. 11-2（表 11-1(1)）の水質（水の汚れ）とリンクさせて検討します。

なお、掘削除去後の地下水及び水質モニタリングの詳細については、8月の審査会にてご説明いたします。

注：許可対象揚水施設：日本アビオニクス株式会社横浜事業所及び解体工事現場

② 汚染土壌の運搬、処理の手順

汚染土壌の運搬先等の具体的な内容については、最低限以下の手順を踏んで対応します。

- ・形質変更時要届出区域等から搬出する際には、あらかじめ形質変更時要届出区域等の所在地、汚染土壌の汚染状態、体積、搬出着手・完了、運搬完了、処理完了予定日などを記載し、必要な図面など（形質変更時要届出区域等の図面、管理票写し、自動車等の構造、保管・詰替施設の構造など）を添付した書類を市長に届け出ます。
- ・形質変更時要届出区域等外への搬出日から汚染土壌処理施設搬入までを速やかに行い、30日以内に終了させます。運搬にあたっては、特定有害物質などの地下への浸透防止策を講じ、汚染土壌を運搬している旨を表示するとともに、専用のフレキシブルコンテナ等によるものとします。
- ・処理は汚染土壌処理施設に搬入した日から60日以内に行います。
- ・汚染土壌を形質変更時要届出区域等外へ搬出にあたり、運搬又は処理を委託する際には、環境省令に従い、管理票を交付し、適正に運搬され、かつ、処理されていることを事後的に確認します。

③ 運搬、処理、処分の際の留意点

- ・フレキシブルコンテナ等による搬出の際は防水性の高いものを用い、浸透防止シートを併用します。
- ・異なる形質変更時要届出区域等の土壌の混入を回避します。
- ・運搬を行う際には、汚染土壌の積込み・積卸し等の作業、積替え・保管、運搬中の事故等により、生活環境への影響又は作業員等の健康被害が生じないように、これらの事故等を未然に防止するための教育や事故等が発生した場合の対応についての教育を徹底します。
- ・自動車等のタイヤ・車体、又は作業員の長靴等に付着した汚染土壌を形質変更時要届出区域等から持ち出さないよう、搬出前に洗浄を行います。
- ・住宅街、商店街、通学路、狭い道路を避ける等、地域住民に対する影響を低減するように努めます。
- ・混雑した時間帯や通学通園時間を避けるようにします。
- ・運搬にあたっては、低騒音型の運搬車両や重機等を選択し、騒音を低減します。

11. 困繞景観の予測の前提条件について

困繞景観をはじめとする景観の予測については、準備書 p. 8-4 の表 8. 1-2(2)に示しますように、「敷地の存在（土地の改変）」と「構造物の存在」について予測を行うことが方法書の手続きにおいて決まりました。

「敷地の存在（土地の改変）」と「構造物の存在」の具体的な状況は、本事業が基盤整備事業である土地区画整理事業であることを踏まえ、以下のとおりとします。

敷地の存在（土地の改変）	造成工事を実施し、河道を含む地表の改変が終わった段階
構造物の存在	道路、調整池等の公共施設の構造物の整備が終わった段階

なお、桜並木等の街路樹を含む緑地については、グリーンインフラの検討や海軍道路の桜並木の検討状況を踏まえ、今後、詳細を検討していくため、フォトモンタージュ上には記載していません。

12. 工事用車両の運行ルートについて

対象事業実施区の南側には住宅地、学校等が存在し、かつ、瀬谷駅の周辺には商業施設も多く存在していることや、既存の道路ネットワークによる広域的なアクセス条件の良さを踏まえ、工事用車両は、環状4号線の南側は走行せず、環状4号線の北側や市道五貫目第33号線を主な走行ルートとしています。

大気質、騒音、振動及び地域社会において、工事用車両の運行による影響について予測評価を行う時の車両の設定は、現地調査で得られた調査結果を現況交通量とし、それに施工計画により算出された工事用車両を加えることで、予測条件となる交通量としています。そのため、工事用車両が通らない地点については、工事用車両による影響を予測計算することができません。地域社会5の地点は工事用車両が通らないことを前提とした計画なので、定量的な予測評価はできない状況です。

旧上瀬谷通信施設地区土地区画整理事業 環境影響評価に関する補足資料

<補足資料内容>

13. 将来の土地利用について
14. 相沢川の暗渠化のイメージについて
15. 関係車両の走行に係る環境保全措置について
16. 転圧や植栽後のSS濃度について
17. 大門川及び相沢川の暗渠化による影響等について
18. 災害用井戸への影響について
19. 湧水の涵養源について
20. 汚染土壌の掘削除去に際しての河川水質対策
21. 相沢川における生育・生息環境確保及び代償措置
22. 草地環境の保全について
23. 農業振興地区の生態系機能について
24. 動植物の予測の考え方について
25. 建設発生土について
26. モニタリングの実施等について

令和3年8月

横浜市

13. 将来の土地利用について

将来の土地利用については、「農業振興地区」「観光・賑わい地区」「物流地区」「公益的施設用地（公園・防災等用地）」の4つの地区を配置することで、将来的には年間1,500万人が訪れる郊外部の新たな活性化拠点の形成を目指していくことに変更はありません。

対象事業実施区域の持つ、立地・規模、後背人口、広域での交通利便性等の高いポテンシャルは、変わらないものと考えているため、「観光・賑わい地区」においては、「テーマパークを核とした複合的な集客施設が立地し、国内外から人を呼び込む観光と賑わいの拠点を形成」に向けて、まちづくりを進めていきます。

また、これらの大規模な土地利用転換に伴う交通需要へ対応するため、相鉄本線瀬谷駅周辺を起点とした新交通システム（AGT）についても引き続き、検討を進めていきます。

本事業における環境影響評価は、造成工事の実施、道路や調整池等の存在及び供用、1,500万人が訪れた際の関係車両の走行に関する予測・評価を行うものですので、「観光・賑わい地区」や「物流地区」の内容は考慮していません。

14. 河川の切り回し及び暗渠化について（前回から継続）

まとまった土地利用を行うにあたり、河川による土地の分断を避けるため、大門川及び相沢川については、現況のコンクリート三面張りの構造を暗渠化する計画です。

<現況>



<将来>



現況の図のうち、青矢印の波線で示した区間を切り回し、暗渠化します。その切り回しルートは、将来の図のうち、大門川については、黄色の波線で示した通り、農業振興地区内に整備される予定の道路下に切り回し、相沢川については、茶色の波線で示した通り、新たに整備される区域内道路や歩行者専用道路等の下に切り回す計画です。

また、動植物の環境保全措置で実施する、相沢川における保全対象種の生息環境（湿地環境と草地環境）の創出（将来の図のうち、赤丸部分）については、暗渠化した相沢川から取水することにより、新たに創出します。

<イメージ図>

現況

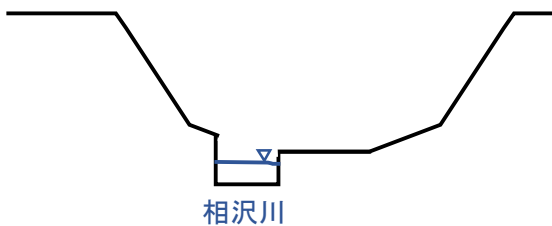

将来

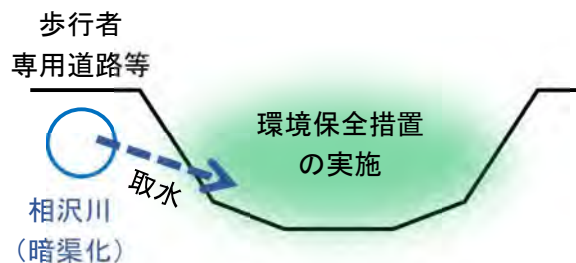

15. 関係車両の走行に係る環境保全措置について

関係車両の走行に係る環境保全措置については、土地区画整理事業者としては、将来の土地利用者に公共交通機関の利用促進や関係車両の効率的な管理等による車両の効率的な利用促進をお願いすることで、関係車両の走行における影響について低減を図っていきたいと考えています。

道路の通行規制については、交通管理者と必要に応じて、今後、協議していきますが、上物施設の事業者に対して、本事業による環境影響の予測結果を引き継ぎ、従業者の通勤自動車や貨物自動車等に対して、自主規制をかけることについて協力を促していきます。

16. 転圧や植栽後のSS濃度について（前回から継続）

前回審査会でのご指摘を踏まえて、以下の条件にて再検討しました。

【流出係数】

和泉川流域については、切土、盛土等の大規模な土工を行わず、現地形を生かした整地を行うため、造成法面はほとんど生じることなく、整地を行っている部分のみの限られた範囲に裸地が生じる程度になります。また、和泉川流域は、公園・防災施設用地としての土地利用であることから、道路や広場等に該当する部分以外は速やかに植生を施します。したがって、安全側を見込んでも、半分程度は植生が施されることが想定されます。

これらを踏まえ、「流出雨水量の最大値を算定する際に用いる土地利用形態ごとの流出係数を定める告示（平成16年国土交通省告示第521号）」に示す土地利用の形態の区分のうち、「人工的に造成された植生に覆われた法面（流出係数：0.4）」が5割、「造成裸地（流出係数：0.5）」が5割であることから、流出係数は0.45とします。

【SSの初期濃度】

国総研資料第594号『道路環境影響評価技術手法「7.水質 7.4切土工事等、工事施工ヤードの設置、及び工事用道路等の設置に係る水の濁り」に関する参考資料』を踏まえて、植栽範囲（5割）では9割程度の低減が図られるとし、200mg/L、整地が行われている範囲（5割）では準備書と同じ2,000mg/Lとし、SSの初期濃度は、1,100mg/Lとします。

注：当該文献では、裸地法面で平均310mg/Lに対し、植栽法面では平均20mg/Lとなっており、9割以上の削減となっています。

再検討結果

$f = 0.45$ 、 $C_0 = 1,100\text{mg/L}$ として、再検討した結果は以下のとおりです。

$$Q = A \times f \times I / (1,000 \times 60) = 211,800 \times 0.45 \times 7.1 / 60,000 \\ \doteq 11.3 \text{ (m}^3\text{/min)}$$

$$T = V / Q = 15,200 / 11.3 = 1,350 \text{ (min)}$$

1,350分後の仮設調整池出口での土砂の残留率Pは、

$$P = 748.27 \times 1,350^{-0.463} / 2,000 \times 100 = 1.3\%$$

となり、初期濃度（ C_0 ）を1,100mg/Lとした場合の仮設調整池出口でのSS濃度（ C ）は以下の通りです。

$$C = 1,100 \times 1.3 / 100 = 14\text{mg/L}$$

従って、和泉川の放流先での濃度（ C_R ）は

$$C_R = (2.15 \times 23 + 11.3 \times 14) / (2.15 + 11.3) \doteq 15\text{mg/L}$$

となり、現況23mg/Lを下回り、現況を悪化させることはありません。

17. 大門川及び相沢川の暗渠化による影響等について

相沢川及び大門川の現状の河床の状況（2021年8月13日撮影 天候雨）は次の写真のとおりです。いずれも、川底には、斑状に藻類が付着している状況が見られます。

<相沢川の状況>



<大門川の状況>



大門川については、北町の工場地帯を流下してから対象事業実施区域内に入ることもあり、令和元年度の現地調査時の観測では、上流側（対象事業実施区域の北端部付近）では、豊水期、渇水期ともにBODや全亜鉛について環境基準値を超過しています。また、上流側の水質調査地点付近には川底に土砂が堆積しており、降雨がない場合においても水の濁りが目視で確認できる場合があります。（準備書P.9.4-10（表9.4-5(2)参照。)) また、上流側の水質が悪いこともあり、pHを除くほぼ全ての水質項目で上流側よりも下流側の水質は良好となっており、濁り成分の沈降、吸着に加えて、下流側でBODが低下し、DOが上昇していることを踏まえると、日中については、川底の藻類等の光合成による水質浄化機能を有していると考えられます。なお、夜間には藻類の呼吸により、貧酸素状態になることも考えられます。

相沢川については、対象事業実施区域の北端部付近が源となっており、上流側の水質が比較的良好であるため、上流側と下流側の水質の差異は顕著ではありませんが、渇水期では大門川と同様に、下流側で水質が良好になる傾向がみられ、一定の水質浄化機能を有していると考えられます。

都市計画対象事業の実施に伴い、大門川と相沢川が暗渠化された場合、光合成を行う藻類は生育できなくなるため、光合成や吸着に係る浄化機能は失われますが、特に大門川については、上流側の土地利用や川底に溜まった土砂が水質悪化の要因になっていると考えられるため、暗渠化に併せて、暗渠入口周辺の舗装や土砂流出防止柵設置等により、上流部における河川への土砂流入を防ぐことで、水の濁りなどが低減され、水質の改善が図られると考えられます。

底質については、暗渠化に伴い、対象事業実施区域内の土砂が河川に流れ込むことがなくなる一方、調整池（工事中は仮設調整池）で濁り成分を十分沈降させた上澄みを放流することになります。従って、大門川及び相沢川の対象事業実施区域よりも下流側の底質への著しい影響はないものと考えます。

18. 災害用井戸への影響について

災害用井戸の多くは私有地にあるため、詳細の把握は困難ですが、防衛省による土壌汚染の深度方向の調査時に確認されている地下水の分布範囲はGL-5.4mよりも浅く、武蔵野ローム層の中に宙水として分布しているものと推定され、GL-16m以深に分布する広域的な帯水層である洪積砂礫層（Dg）（準備書資料編（P.資料 地下水-2、図9.6-1(1)）参照）とは直接つながっている可能性は低いものと考えられます。従って、対象事業実施区域内の土壌汚染による影響が災害用井戸の水質に及ぶ可能性は低いものと考えています。このことを、裏付けるため、事後調査で対象事業実施区域の南端部2ヶ所において、洪積砂礫層（Dg）の帯水層までの観測用井戸を設置し、地下水質のモニタリングを実施します。（モニタリングの手法は、26⑤参照）

19. 湧水の涵養源について

対象事業実施区域及びその周辺の広域的な帯水層については、準備書資料編（P. 資料地下水-2、図 9.6-1(1)）に示す洪積砂礫層（Dg）と考えられますが、防衛省による地下水調査の結果によれば、その水位は多くが深度 2m 以下の地表面近くであるため、湧水の涵養源はその近傍の地表近くに雨水が溜まった宙水のような不安定な状況であることが推察されます。

堀谷戸川付近の湧水 1 については、平成元年 7 月 29 日に行った豊水期（晴天時）の調査では流量が観測されておらず、平成 2 年 1 月 10 日に行った渇水期（晴天時）の調査においても流量は $0.0002\text{m}^3/\text{s}$ 程度と比較的少ない状況です。

したがって、地表近くで植物が繁茂する豊水期（概ね春～夏季）には植物の根が水を吸い上げ、湧水が枯渇してしまう可能性があります。また、豊水期には付近の営農による水需要が高まるため、これが湧水の枯渇の要因になる可能性も否定できません。

一方、湧水 1 は対象事業実施区域の外側に位置しますが、直近は「観光・賑わい地区」としての土地利用であるため、雨水起源の宙水は形成されにくくなり、準備書 P. 9.7-8 に記載のように、湧水 1 への涵養源への影響はあると想定されます。この影響は準備書 P. 9.7-9（表 9.7-6）に記載の環境保全措置を講じることにより、低減されるものと考えています。

なお、湧水 1 付近の植生の状況は、下記の写真のとおり、クズ、カナムグラ、アオミズ、スギナ、ツユクサ、ヒナタイノコヅチ、トクダミなど、荒地や路傍などにみられる植物のみで、コケ類や付着藻類など、水辺に依存する植物は確認されませんでした。

<湧水 1 付近の植生の状況>



（撮影日 2021 年 8 月 13 日 雨）



（撮影日 2021 年 8 月 16 日 雨）

20. 汚染土壌の掘削除去に際しての河川水質対策

仮設調整池については、着工後速やかに設置しますが、汚染土壌の掘削除去時に仮設調整池が完成しなかった場合についての河川水質対策を、評価書において、準備書 P. 9. 4-25 の予測の前提条件に以下のように追記します。なお、汚染土壌の流出防止対策については、前回審査会の補足資料「10. 汚染土壌の掘削除去を行う際の対応について」に記載したように、掘削時に基準不適合土壌又は特定有害物質が飛散、揮散しないよう、基準不適合土壌又は特定有害物質の飛散等の防止対策を講じます。（現場の状況に応じ、散水、養生シートの敷設等）

<追記内容（波線太字が追記部分）>

⑤ 予測結果

ア. 予測の前提条件

コンクリート打設時には、アルカリ排水による水の汚れが生じないように、適正な規模の仮設調整池を設置し、アルカリ排水の適正処理をした後、公共用水域に放流するものとします。また、仮設調整池の工事は着工後速やかに行いますが、仮に汚染土壌の掘削除去時に仮設調整池が完成していない場合には、掘削除去現場に個別の集水枡を設ける等の措置を講じ、直接河川への流入を防止します。なお、汚染土壌の飛散等防止のため、現場の状況に応じ、散水、養生シートの敷設等を行います。

対象事業実施区域内において確認されている汚染土壌については、後述する土壌汚染に示す予測の前提条件（P. 9. 9-8 ⑤ア）に従い、造成工事に先立って汚染拡散防止のための措置が講じられます。

21. 相沢川における生育・生息環境確保及び代償措置

■ 保全対象種の環境区分とモデル地域について

相沢川沿いで確認された重要な種のハビタットタイプを種ごとに整理し、必要な環境要素を抽出した結果、大きくは湿地環境、湿性草地、水路、樹林、乾性草地の5つの環境区分が必要となる。さらに、湿地環境は水深、湿性草地は草丈、水路は水深及び河床材料に変化を持たせた複数の環境区分が必要となることから、下記①～⑧に示す8つの環境区分を設定します。

環境区分	保全対象種
①湿地環境 (水深5cm、泥底)	昆虫類：ナツアカネ(幼虫)、エサキコミズムシ、シオカラトンボ(幼虫) 底生動物：マルタニシ 植物：ヒメミズワラビ、ウスゲチョウジタデ、シャジクモ、イチョウウキゴケ
②湿性草地 (草丈の低い草地)	昆虫類：ケラ、クロヒメヒョウタンゴミムシ、アトモンコミズギワゴミムシ、クロケブカゴミムシ 植物：ミズニラ、ヌマトラノオ、アマナ、ミズタカモジ、セイタカハリイ、ハリイ
③水路(水深20～40cm、砂礫底)	魚類：アブラハヤ 植物：チャイロカワモズク、アオカワモズク
④湿地環境(水深10～20cm、泥底)	昆虫類：コマルケシゲンゴロウ、コガムシ
⑤湿性草地(草丈の高い草地)	昆虫類：ショウリョウバッタモドキ
⑥水路(水深10～20cm、砂泥底)	昆虫類：ハグロトンボ(幼虫)、ヤマサナエ(幼虫)
⑦樹林(落葉広葉樹)	(他の環境区分との連続性により保全されるため、対象種は下記で記載)
⑧乾性草地	昆虫類：トノサマバッタ 植物：ヒロハノカワラサイコ
⑤⑥⑦水路周辺の湿性草地、樹林のまとまり	昆虫類：ハグロトンボ(成虫)、ヤマサナエ(成虫)
①～⑦湿地環境、水路、湿性草地等のまとまり	鳥類：キセキレイ 爬虫類：ヤマカガシ
①②④⑤⑦湿地環境、湿性草地、樹林のまとまり	両生類：シュレーゲルアオガエル 爬虫類：ヒバカリ、シマヘビ 昆虫類：ナツアカネ(成虫)、シオカラトンボ(成虫)

事業の影響を受けると予測された種が、世代交代を行い、地域個体群を維持できる環境保全措置が求められています。そのためには、創出する生息・生育環境は、質・量ともに現在の相沢川の環境に近づけることが有効です。しかし、量的に相沢川沿いの現環境(約13.5ha)を確保することは困難であることから、相沢川沿いのうち、水田、休耕田、水路及び樹林が一体となった対象事業実施区域北部の環境をモデル地域とするとともに、各環境区分の質を向上させることで、モデル地域以外に生息・生育する種も保全できる環境創出を目標とします。

■環境創出の考え方

- ・成長段階によって生息環境が異なる種、豊富な餌量と多様な環境を必要とする種が生息するためには、環境区分①～⑧に示す環境区分を適切に組み合わせて配置し、多様な環境を創出する必要があります。
- ・事業の影響を受けると予測された種が、世代交代を行い、地域個体群を維持できる環境保全措置が求められています。
- ・そのためにモデル地域と同様の谷戸地形である対象事業実施区域の南側において、現況の地形及び土地利用を活かした保全対象種の生息・生育環境を創出します。
- ・生息・生育環境の創出は、土地区画整理事業で整備を実施します。

■環境保全措置のイメージについて

- ・湿地環境については、水深の異なる湿地を配置します。
- ・水路については、現況の3面張りから多自然水路とし、水の流れに変化を持たせるとともに、周辺には湿地環境や草地環境を創出することで、質の向上を図ります。
- ・樹林を西側に創出します。
- ・水路、草地、湿地、樹林という環境区分を連続的に推移させることで、様々なハビタットタイプの保全対象種が生息・生育できる環境を創出します。

■環境区分のエコトーン断面イメージ

【東西断面】

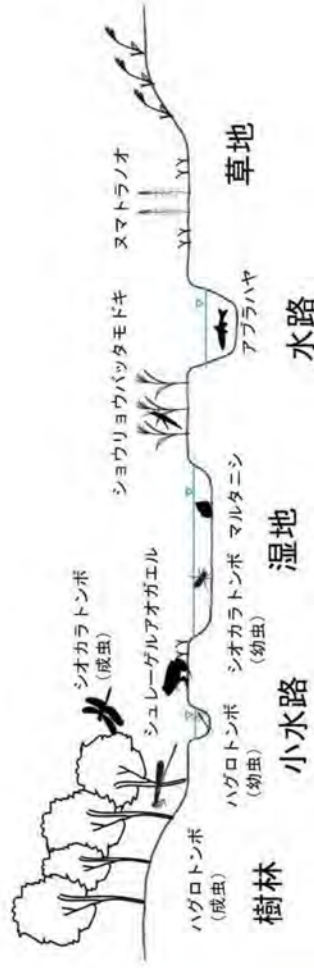

【南北断面】



※お示している環境保全措置のイメージは、環境区分の配置(順合せ)の考え方を示したものであり、具体的な配置などの詳細は、今後、公園整備事業等と調整を図りながら、検討していきます。

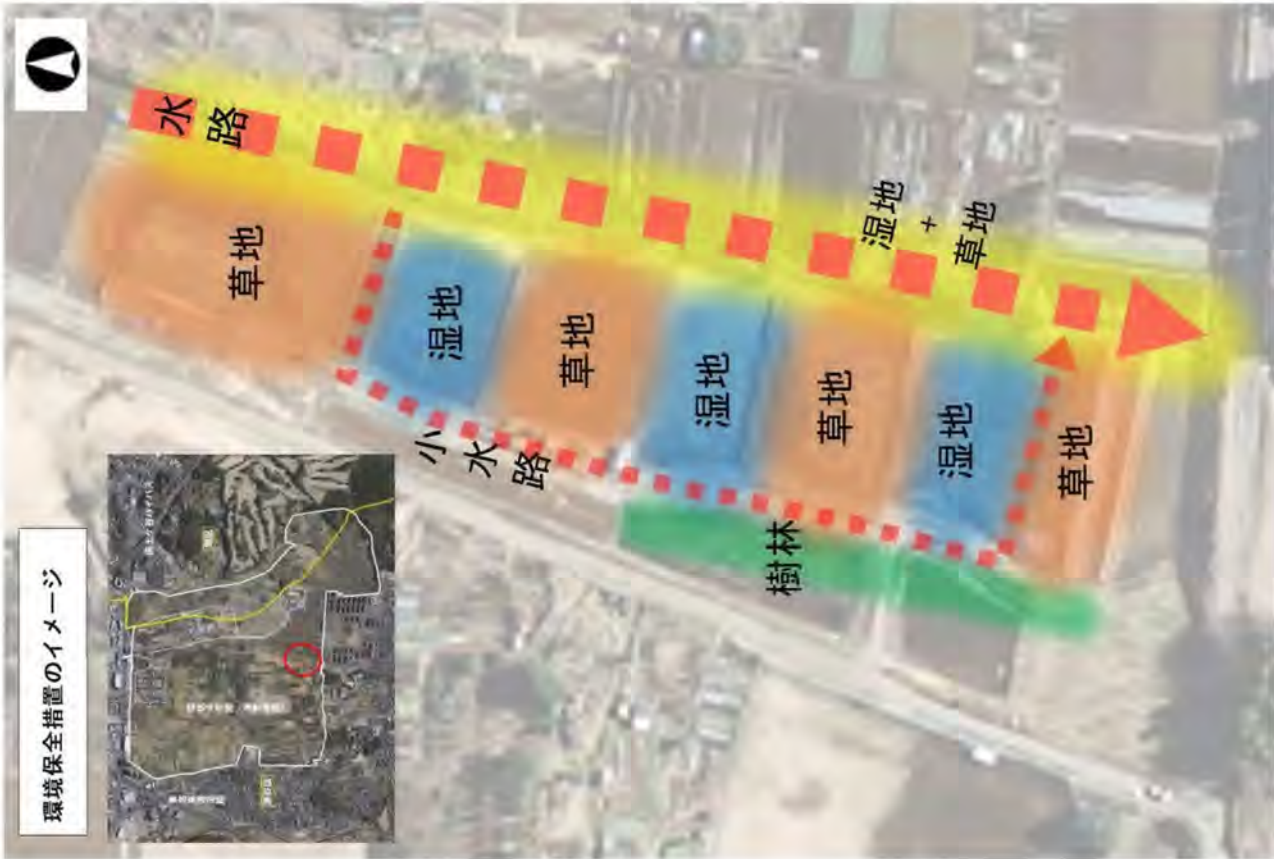

22. 草地環境の保全について

草地環境については、トノサマバッタ（昆虫類）やヒロハノカワラサイコ（植物）を保全対象種として、「21. 相沢川における生育・生息環境確保及び代償措置」でお示した公益的施設用地内の概ね 1.5ha のエリアに配置していきます。

23. 農業振興地区の生態系機能について

本事業が土地区画整理事業という特性上、具体的な農業振興地区の土地利用が決まっていますが、農業振興地区内の農地間の空間や、農道と農地間の空間など、事業者として整備可能な部分での草地環境としての役割を期待しています。

このような環境は、ニホントカゲ等の耕作地周辺を生息環境とする種や鳥類にとって、生息環境の代償となるかと考えております。

公園も含め上物の計画が検討中の段階ではありますが、瀬谷市民の森、相沢川沿いに創出する湿地・草地環境、農業振興地区を有機的に繋げられるよう検討してまいります。

24. 動植物の予測の考え方について

準備書 p. 9. 11-39 等に記載の「対象事業実施区域外に生息地は確認されませんでした」という表現について説明させていただきます。

p. 9. 11-36 に示すとおり、予測条件として対象事業実施区域内はすべて改変の可能性があるとしています。

「工事の実施」については、予測対象時期が、造成工事が最大となった時期であることから、対象事業実施区域内にのみ生育する個体は、「全ての生育地が改変されることから、造成工事による生育環境への影響は大きい」と予測評価しました。

この場合、「土地又は工作物の存在及び供用（敷地の存在（土地の改変）」については、予測対象時期が、供用後の環境が安定することが想定される時期としていることから、対象事業実施区域内に現地調査時の生育環境が存在していない、すなわち予測地域内に存在していないことから、「対象事業実施区域外に生息地は確認されませんでした」と記載しました。（あくまで影響予測の対象となるのは、対象事業実施区域外に確認された種となります。）

しかし、分かりにくい表現であるため、以下の修正案に修正します。また、P9. 11-37 に記載の影響予測の手順についても、次ページの通り、修正します。なお、影響予測の手順については、一部、文字が消えている箇所があったため、あわせて修正させていただきます。

修正案：本種は対象事業実施区域内のみに生育し、工事の実施（造成工事）により、全ての生育地が改変されるため、土地又は工作物の存在及び供用（敷地の存在（土地の改変））時点で存在しないことから、影響予測の対象外としました。

なお、移動能力がある動物については、造成工事により対象事業実施区域からいなくなっても、周辺に逃避すること等により、現地調査において対象事業実施区域外に確認されなかった場合においても、敷地の存在時には動物が確認される可能性があるため、その影響の程度に触れています。



図 影響予測の手順（植物）

25. 建設発生土について

まだ具体的な搬出先や計画等は決まっていますが、建設発生土の処分については、下記の点に努めます。

- ・場外搬出する建設発生土の量をできる限り少なくするように、計画熟度の進捗に伴って切土量、盛土量のバランスの見直しを適宜行う
- ・市内および近辺で行われる公共事業において、場外搬出される建設発生土が有効利用することができないか情報収集、協議を行う
- ・場外搬出される建設発生土の埋立地及び受入地先は、対象事業実施区域からなるべく近いところを選び、建設発生土を運搬するダンプカーから発生する排気ガス、騒音、振動等の抑制を図る
- ・車両については、低燃費のものを使用し、二酸化炭素の排出抑制を図る
- ・運搬時には、過積載の防止を徹底し、高負荷運転による大気汚染、騒音、振動の抑制を図る
- ・汚染土壌の掘削除去に伴い場外搬出する場合は、土壌汚染対策法に基づいて適切に処理を行う

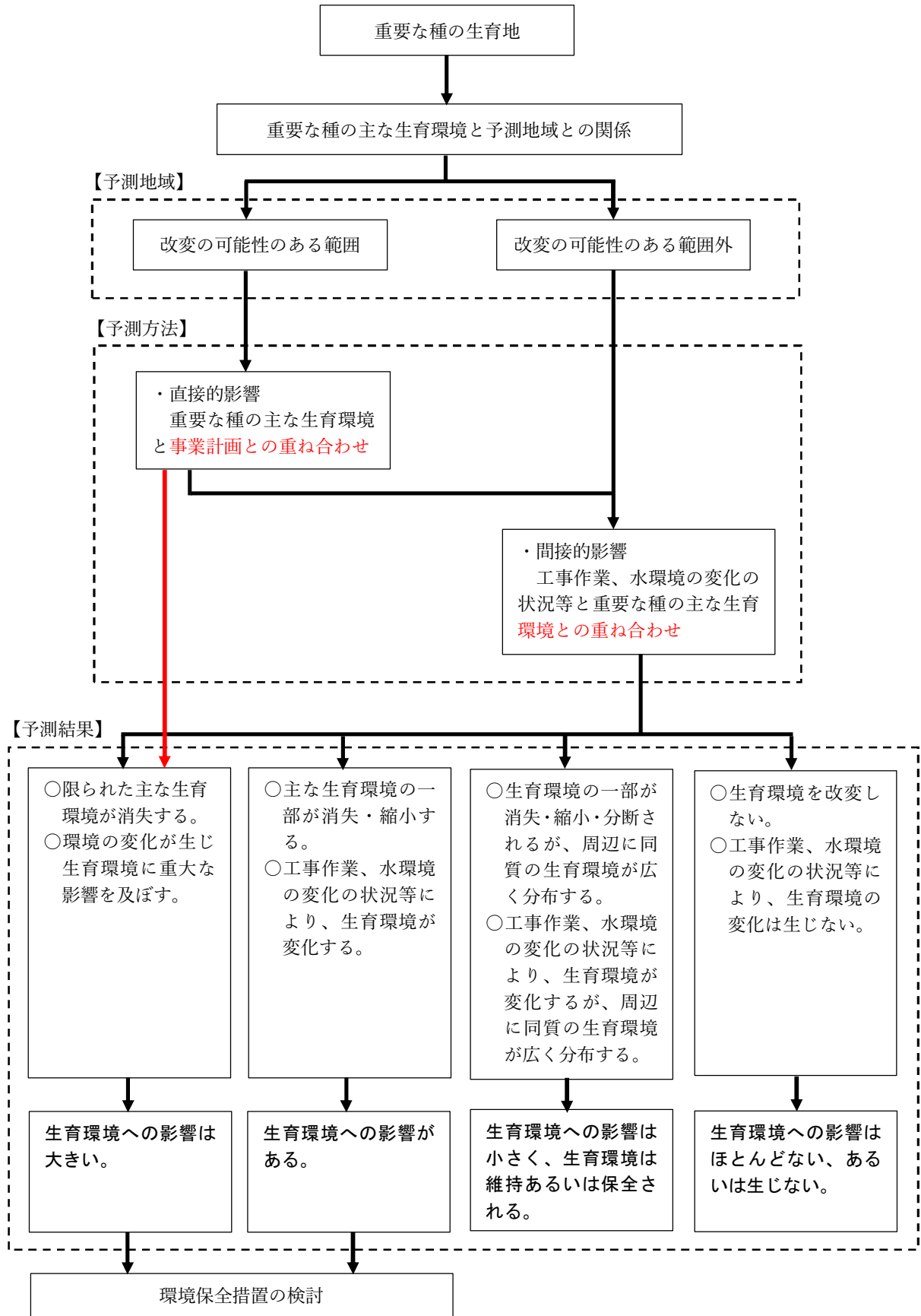
26. モニタリングの実施等について

環境影響評価法に基づく事後調査については、準備書 P. 11-1～4 に示す内容にて行いますが、予測結果が環境基準値を超過している項目や影響が大きいと判断される項目に対して環境保全措置を講じる場合などについても、モニタリングの実施等により、環境保全措置の効果を検証します。なお、関係車両の走行に係るモニタリングについては、基盤整備までを事業範囲とする土地区画整理事業においては行いません。

環境要素	環境影響要因	実施理由	備考
大気質（二酸化窒素）	建設機械の稼働	横浜市の環境目標値を超過している。	今後、必要性を踏まえ検討
騒音	工事用車両の運行	一部地点で環境基準を超過している。	現地調査による確認（工事車両騒音の測定及び工事用車両、一般車両の交通量計測）
水質（水の濁り、汚れ）	雨水の排水	予測の不確実性の程度が大きい項目について環境保全措置を講じる。	現地調査による確認（仮設調整池出口及び水の濁り予測地点での水質調査）
地下水の水質	敷地の存在（土地の改変）	予測の不確実性の程度が大きい項目について環境保全措置を講じる。	現地調査による確認（地下水観測井を設置し調査）
湧水の流量	敷地の存在（土地の改変）	予測の不確実性の程度が大きい項目について環境保全措置を講じる。	現地調査による確認（準備書の現地調査を行った場所又は新たな湧水環境を設置した場合は当該箇所を確認）
河川の形態、流量	敷地の存在（土地の改変）	工事の実施中及び土地又は工作物の供用開始後において環境保全措置の内容をより詳細なものとする必要がある。	現地調査による確認（仮設調整池出口及び放流先河川での流量観測）
動物、植物、生態系	造成工事の実施、敷地の存在（土地の改変）	代償措置について、効果の不確実性の程度及び知見の充実の程度を勘案して、事後調査が必要と認められる。	現地調査による確認
地域社会（交通混雑）	工事用車両の運行	一部地点で交差点需要率が限界需要率を超過している。	現地調査による確認（工事用車両、一般車両の交通量及び渋滞の状況計測）
文化財	造成工事の実施	予測の不確実性の程度が大きい項目について環境保全措置を講じる。	周知の埋蔵文化財包蔵地での工事の状況と、新たな埋蔵文化財を発見した場合の対応状況を報告

注： 水色網掛は準備書の事後調査から追加する項目

① 大気質（二酸化窒素）

新しい排出ガス規制適合型の車両の使用や工事工程の平準化等について施工業者と調整し、二酸化窒素への影響の低減を図っていきます。また、モニタリングについては、今後、施工業者と必要性を踏まえ検討していきます。

② 騒音

工事用車両騒音の予測を行った4地点で車両の運行台数がピークとなる時期に調査を行うことにより、モニタリングを行います。併せて、工事用車両、一般車両の車種別台数についても調査を行います。

③ 水質－水の濁り

a 仮設調整池の出口

各仮設調整池の出口において、濁度計により連続的に濁度の監視を行います。また、SSについては、平常時（非降雨時）に年間4回の測定を行うとともに、10mm以上の降雨時についても年間4回の調査を行います。

b 放流先河川

準備書の現地調査を行った地点（ただし、堀谷戸川については、支流を含む。）において、平常時（非降雨時）に年間4回の測定を行うとともに、仮設調整池出口におけるSSの降雨時調査時期と併せて年間4回の調査を行います。（図1参照）

④ 水質－水の汚れ（準備書P.9.4-30（表9.4-30）に示す事後調査の項目）

a 仮設調整池出口及び放流先河川

各仮設調整池の出口及び放流先河川（水の濁りの調査と同じ場所）において、年間4回の調査を行います。（図1参照）

なお、水の汚れ（健康項目に限る。）について、万一、環境基準値を超過するような結果となった場合は、当該河川において底質の調査も行います。

注： 準備書の現地調査や横浜市で行われている中小河川の調査が豊水期1回、渇水期1回の年間2回程度となっていますが、水質等の調査を年間4回とした理由は、工事工程の変化を把握できる調査とし、かつ、四季の各季1回程度調査を行うのが妥当と判断したためです。なお、調整池排出口での濁度は連続観測の予定です。

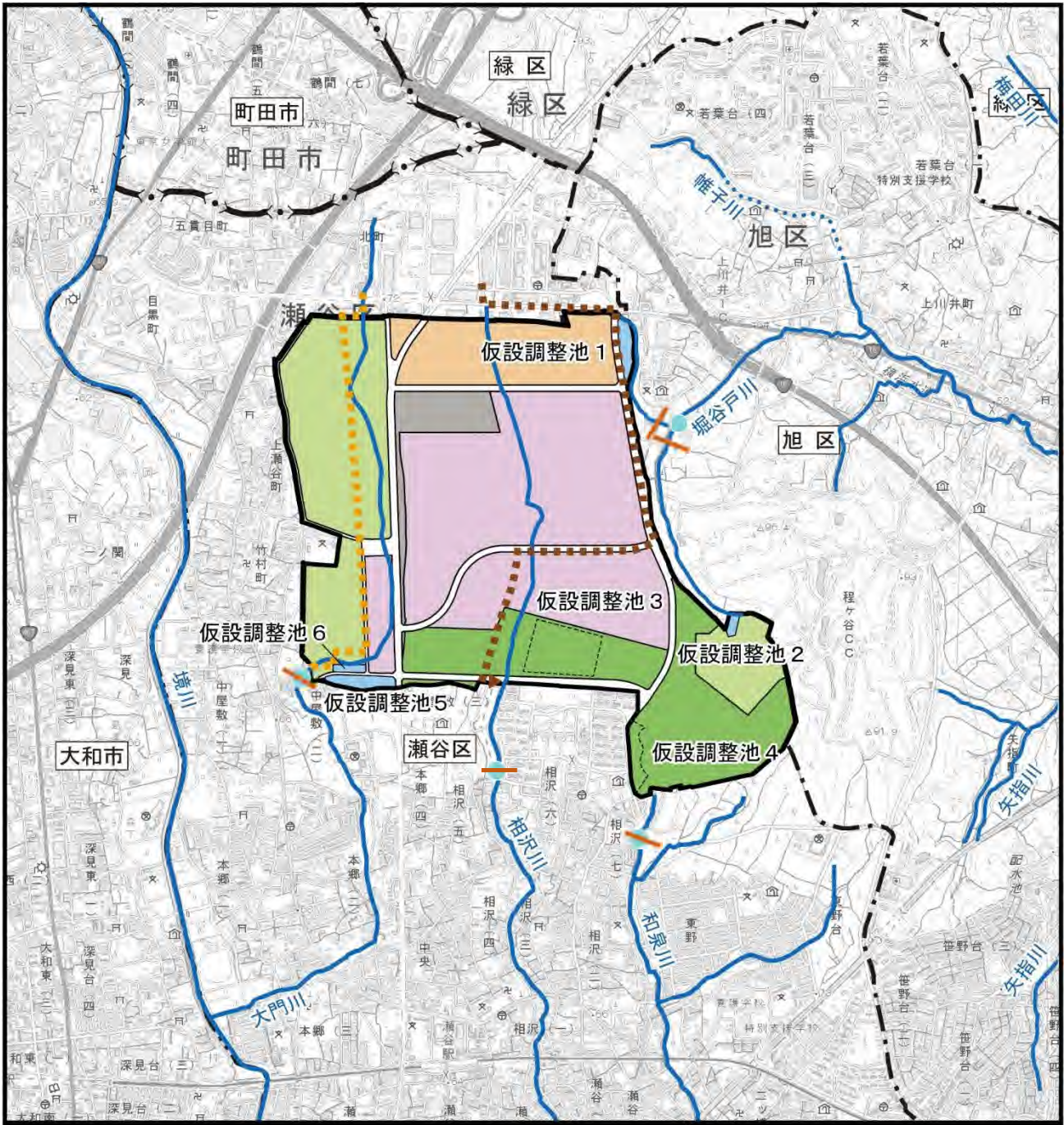

凡 例

対象事業実施区域
 都県界
 市界
 区界

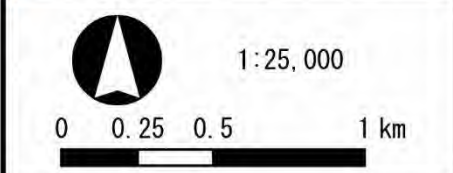

- | | |
|---|--|
| <ul style="list-style-type: none"> 農業振興地区 観光・賑わい地区 物流地区 公益的施設用地（公園・防災等用地） 交通施設用地 道路 | <ul style="list-style-type: none"> 調整池（地上式）—工事中は仮設調整池 1、2、5、6 公益的施設内調整池（地下式）—工事中は仮設調整池 3、4 相沢川切り回し 大門川切り回し ● 水質（水の濁り）予測地点 — 水質（放流先河川）モニタリング地点（断面） |
|---|--|

図 1 水質モニタリング地点

⑤ 地下水の水質

地下水の水質については、対象事業実施区域内及びその周辺の帯水層が南方向に傾いており、地下水の流れも北から南に向かうと推察されることから、対象事業実施区域の南端部に接する箇所のうち、GL-8, 9m で鉛の土壌溶出量が指定基準を超過した地点近傍及びその南側で地下水の利用がある場所として、図 2 に示す 2 ヶ所においてモニタリングを行います。調査頻度は「地下水質モニタリングの手引き」（環境省、平成 20 年 8 月）では、継続監視調査の場合は年 1 回以上とされていますが、水質（水の汚れ）の調査と同様な理由で年 4 回とし、汚染がみられない場合は、竣工 1 年後まで継続します。なお、参考として地下水位についてもこの間、継続的に観測します。

⑥ 湧水の流量

湧水の流量のモニタリングは、準備書の現地調査で湧水が確認された 3 地点を基本としますが、代償措置により湧水環境の創出が行われる場所においてもモニタリングを行うこととします。モニタリングの頻度は水質と同様に年間 4 回を基本としますが、近接地域で造成工事が行われる期間については、工事実施日について毎日湧水の状況を目視で観測するものとします。

⑦ 河川の形態、流量

河川流量のモニタリングは、準備書の現地調査を行った地点（ただし、堀谷戸川については、支流を含む。）において、10 mm 程度以上の降雨時に年間 4 回の測定を行うとともに、仮設調整池出口における放流量について連続的なデータを取集するものとします。



図2 地下水の水質モニタリング地点

⑧ 動物、植物、生態系

動物、植物、生態系について、工事中及び工事完了後に現地調査を行い、保全対象種の生息・生育状況を確認いたします。

また、動物については、環境保全措置（保全対象種の個体の移動）の一環として、工事中にシュレーゲルアオガエル、ハグロトンボ、ヤマサナエ、ナツアカネ、クツワムシ、エサキコミズムシ、コマルケシゲンゴロウ、コガムシ、アブラハヤ、ホトケドジョウ、マルタニシ、スナガイが確認された場合には、創出した生息環境（湿地環境と草地環境）もしくは工事区域外の生息適地へ移動させます。捕獲の方法や時期等については、専門家等の助言を踏まえ、今後計画、実施いたします。

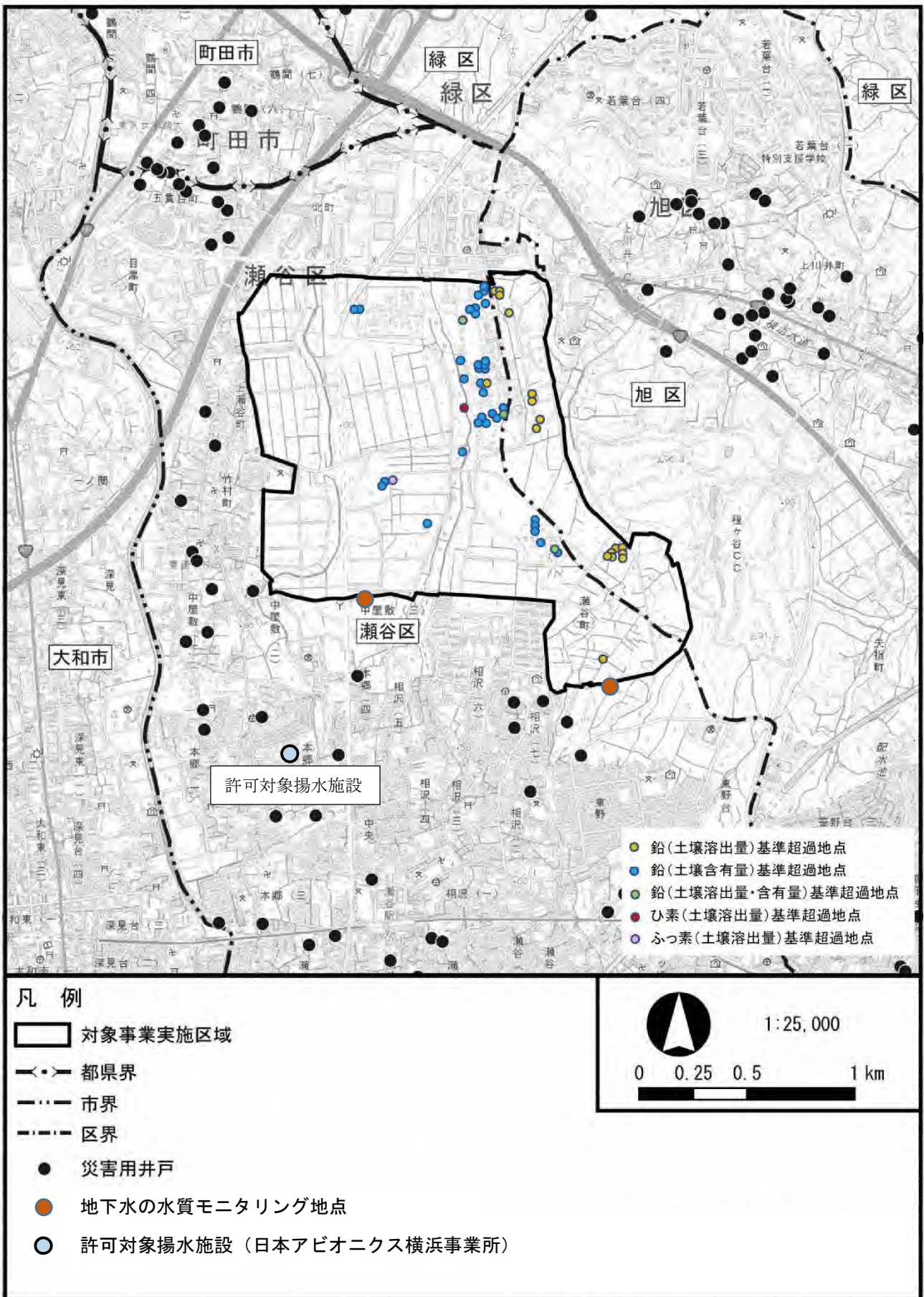
植物については、環境保全措置（保全対象種の移植・播種）の一環として、工事中にミズニラ、ヒメミズワラビ、ヒロハノカワラサイコ、ウスゲチョウジタデ、ヌマトラノオ、アマナ、ミズタカモジ、セイタカハリイ、ハリイ、チャイロカワモズク、アオカワモズク、シャジクモ、イチョウウキゴケが確認された場合には、創出した生育環境（湿地環境と草地環境）へ移植します。なお、移植・播種の方法や時期等については、専門家等の助言を踏まえ、今後計画、実施いたします。

生態系については、環境保全措置（保全対象種の個体の移動）の一環として、工事中にシオカラトンボ（幼虫）が確認された場合には、創出した生息環境（湿地環境と草地環境）もしくは工事区域外の生息適地へ移動させます。捕獲の方法や時期等については、専門家等の助言を踏まえ、今後計画、実施いたします。

また、動物、生態系におけるホトケドジョウについては、工事中にモニタリング調査を実施し、生息状況が変化した場合に順応的に対策を検討いたします。

⑨ 地域社会（交通混雑）

工事用車両に係る交通混雑の予測を行った4交差点で車両の運行台数がピークとなる時期（平日及び土曜日）に調査を行うことにより、モニタリングを行います。併せて、工事用車両、一般車両の車種別台数についても調査を行います。また、渋滞等の状況についてもその有無や滞留長、渋滞長について観測します。

⑩ 文化財

周知の埋蔵文化財包蔵地での工事の状況と、新たな埋蔵文化財を発見した場合の対応状況を収集整理します。

旧上瀬谷通信施設地区土地区画整理事業 環境影響評価に関する補足資料

＜補足資料内容＞

27. 公益的施設用地内の調整池について
28. 相沢川の水や事業実施区域内の降雨の流し方等について
29. 工事用車両運行ルートを検討及びこれに伴う騒音、地域社会への影響低減について
30. 将来の自動車交通量の需要予測について
31. 大門川及び相沢川の暗渠化による影響等について（継続）
32. 「地下水への影響について（防衛省による調査結果）」の誤記について
33. 農地間の空間における草地環境について
34. 動植物の予測の考え方について（継続）
35. 相沢川における生育・生息環境確保及び代償措置について（継続）
36. 和泉川源流部における生育・生息環境確保及び代償措置について
37. 対象事業実施区域内の眺望景観（遠景）について
38. 建設発生土について（継続）
39. 温室効果ガスの低減対策について
40. 瀬谷地内線に新設される交差点の交差点需要率について
41. モニタリングについて（継続）

令和3年9月

横浜市

27. 公益的施設用地内の調整池について

■構造について

排水施設計画（準備書P.2-13）に示すとおり、土地区画整理事業において、洪水の発生を防止するために必要となる雨水調整池を各流域に1箇所以上配置する計画です。

本地区の公益的施設用地では、大規模発生時には、消防・警察・自衛隊などの受入に必要な広域応援活動拠点としての機能や市民の生命・身体を守るために一時的に避難できる機能を確保に向けた検討を進めており、ある一定規模の平場が必要であることから、公益的施設用地に隣接する調整池である、相沢川流域に設置する調整池3、和泉川流域に設置する調整池4については、上部利用できる地下式調整池としていました。

しかし、検討を深度化していく過程の中で、防災拠点としての平場確保は主に公益的施設用地の中央付近で行うことを現在検討していることから、調整池4については、地上式調整池として設置が可能となったため、今後は地上式調整池を基本として検討を進めます。なお、容量等に変更はありません。

また、地上式調整池の具体的な設えについては、今後、公園整備事業等と調整を図りながら、地形や自然豊かな環境をいかし、環境に負荷の少ない調整池を検討していきます。

■位置について

調整池4の詳細な位置は今後検討していきますが、地形や自然豊かな環境をいかし、環境に負荷の少ない調整池を検討していくことから、下図の赤で囲ったエリアを中心に検討を行います。



図 27-1：調整池4（地上式）の検討位置

28. 相沢川の水や事業実施区域内の降雨の流し方等について

相沢川の切り回し、対象事業実施区域内の降雨処理、調整池及び創出する生息・生育環境の考え方は、次のフロー図に示す通りです。

平常時は、切り回し、暗渠化した相沢川から取水することで、生息・生育環境の創出を図ります。降雨時には、対象事業実施区域内に降った雨は、暗渠化した相沢川に流入させることを想定しており、途中で分水することで、生息・生育環境の創出へは平常時と同様、取水するとともに、地区降雨相当分は調整池を経由して下流に接続することとします。

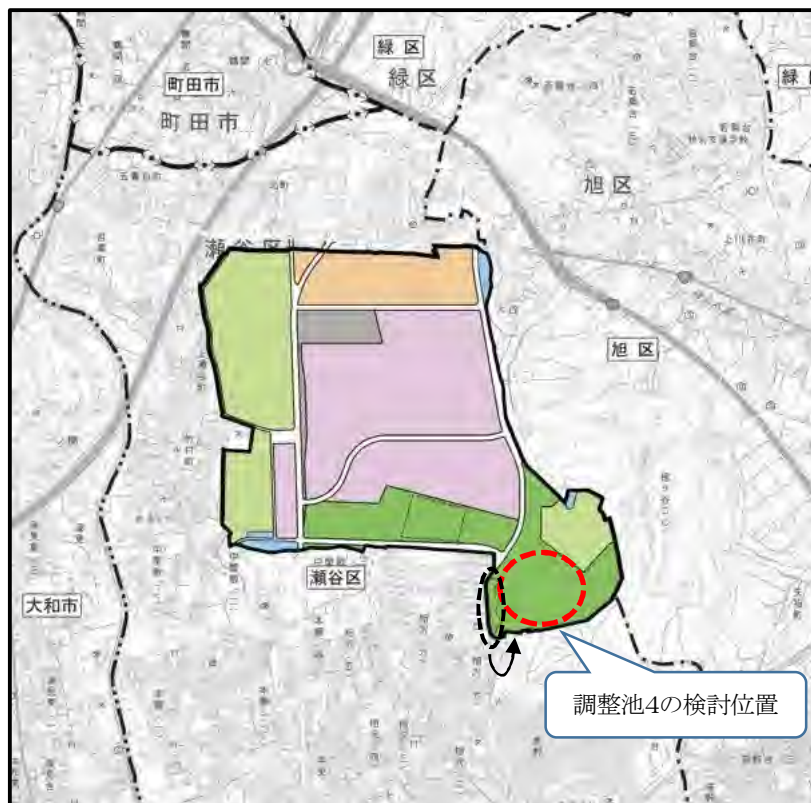
大門川については、暗渠化して切り回し、地区内降雨分も含めて調整池を経由して下流に接続することとします。

和泉川及び堀谷戸川については、地区内降雨分が調整池を経由し、下流に接続することとします。

<平常時>

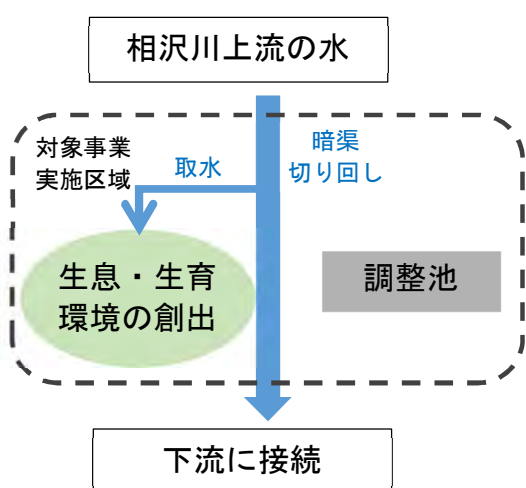

<降雨時>

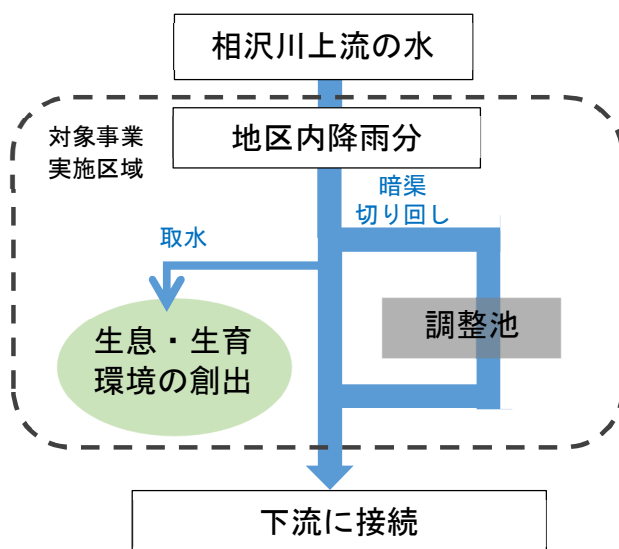

なお、暗渠化にあたっての生物対応策として、以下の配慮事項を検討します。

- ・暗渠部の排水の設計にあたっては、生物の移動などが可能となる様、検討する。
- ・開渠から暗渠への切り替え前に開渠部の調査を行い、重要な種を創出する生息・生育環境等へ移動させる。

29. 工事用車両運行ルート分散及びこれに伴う騒音、地域社会への影響低減について

(1) 工事用車両運行ルート分散について

工事用車両の走行に伴う交通混雑の予測対象の時間帯については、通過する一般車両と工事用車両を合わせた台数が最も多い時間帯（17時台）で予測評価を行っています。

予測結果より、目黒交番前交差点に工事用車両が集中しているため、以下の通り、工事用車両運行ルート分散を検討しました。

なお、検討は平日で行いましたが、評価書では平日と休日の両方で再予測計算を行い、その予測結果を掲載します。

検討A：対象事業実施区域北東側の八王子街道に面している所において、左折 in、左折 out が可能な工事用車両専用の出入口を設けます。

検討B：西側方面への発生的小型車を、目黒交番前交差点を通過することを避けて旧海軍道路へ分散します。なお、西側方面へは通勤用車両の走行しか想定していないため、本分散ルートを走行する工事用車両は、17時台だけとなります。

検討C：目黒交番前交差点は負荷をかけないように、海軍道路を南北に直進するルートをメインとします。

以上より検討した工事用車両の運行ルートを、図 29-1～4 に示します。

図 29-1 は、通勤用の工事用車両が対象事業実施区域へ集中するルートです。対象時間は7時台となります。

図 29-2 は、運搬用の工事用車両が対象事業実施区域から外へ発生するルートです。対象時間は、8時台～16時台です。

図 29-3 は、運搬用の工事用車両が対象事業実施区域へ集中するルートです。対象時間は、8時台～16時台です。

図 29-4 は、通勤用の工事用車両が対象事業実施区域から外へ発生するルートです。対象時間は17時台となります。なお、この時間帯が一日の中で一般車両、工事用車両を含めて台数のピークとなりますので、地域社会（交通混雑）の予測対象時間は、17時台で行っています。



図 29-1 工事用車両（通勤車両）の運行ルート（集中）



図 29-2 工事用車両（運搬車両）の運行ルート（発生）

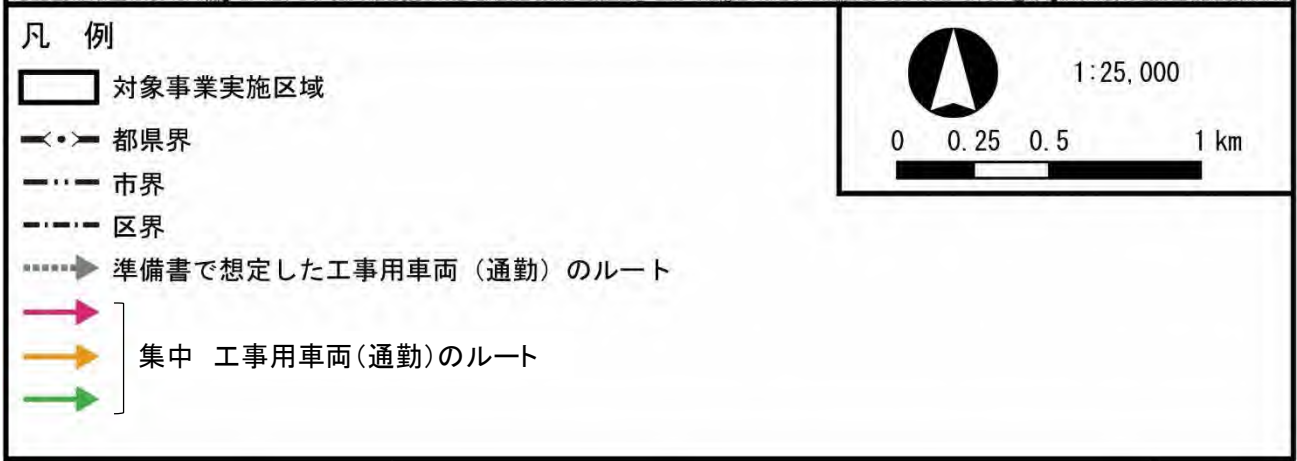
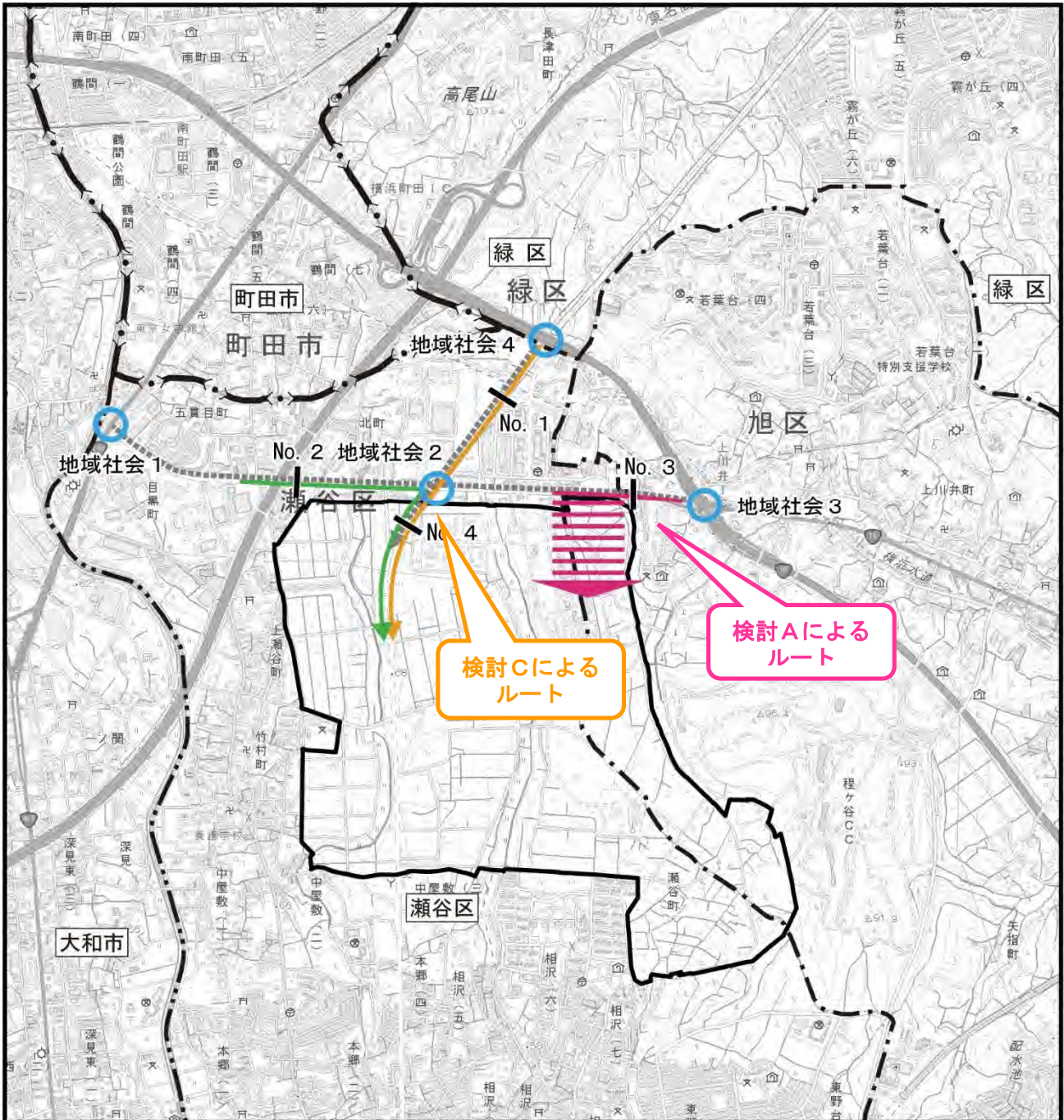

凡例

- 対象事業実施区域
- 都県界
- 市界
- 区界
- 準備書で想定した工事用車両（運搬）のルート
- 集中 工事用車両（運搬）のルート

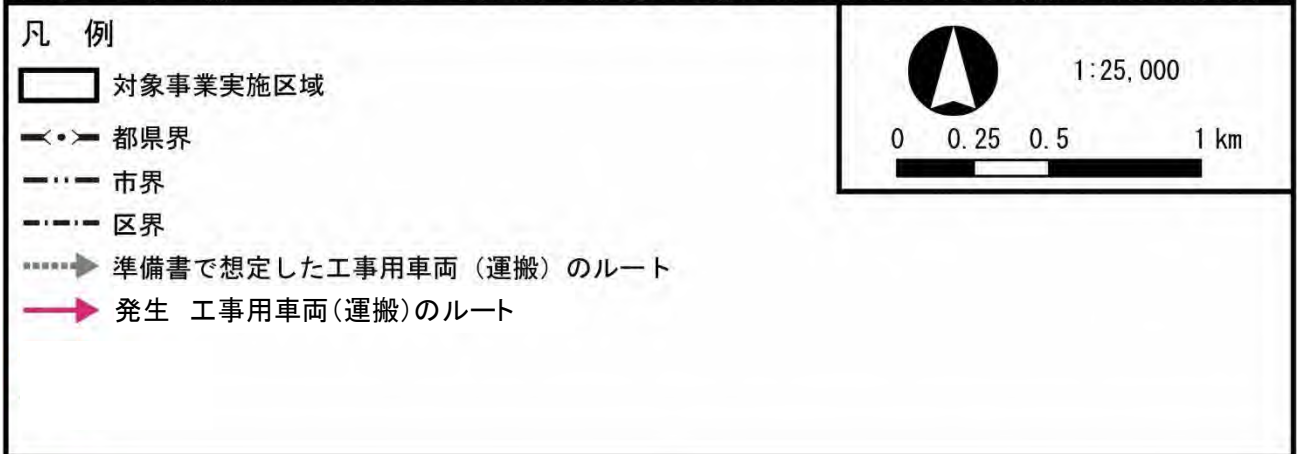
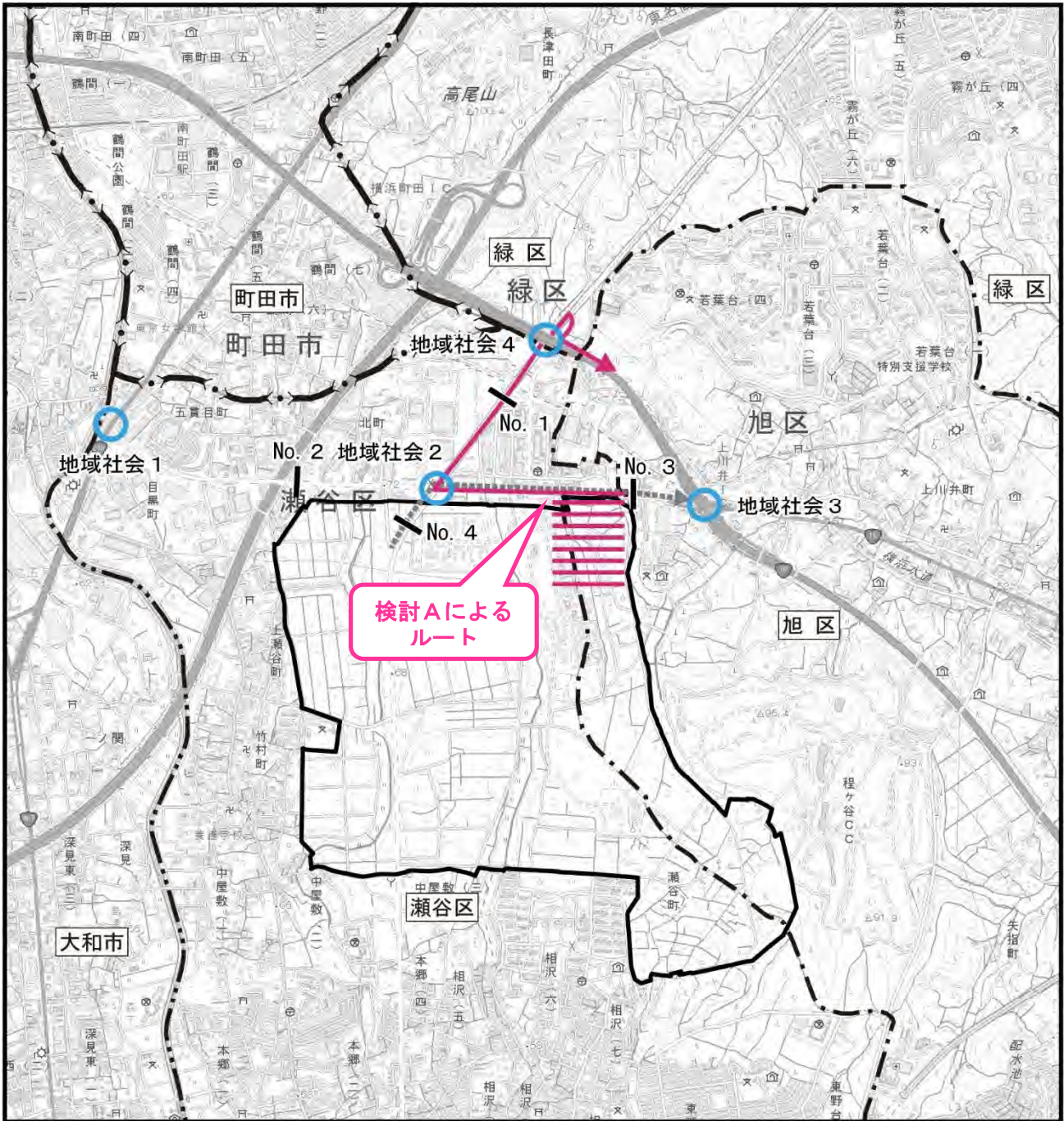
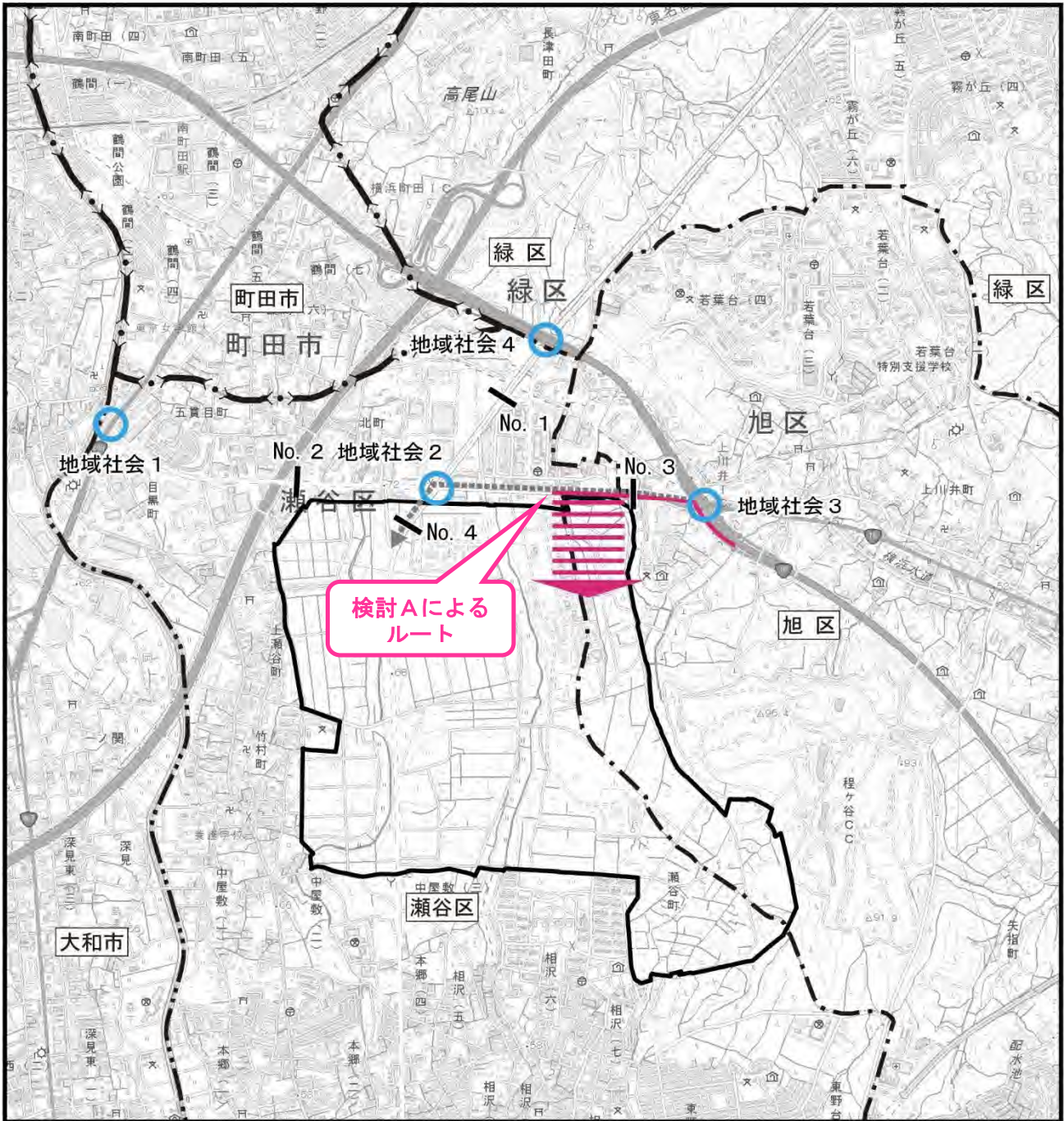

図 29-3 工事用車両（運搬車両）の運行ルート（集中）



図 29-4 工事用車両（通勤車両）の運行ルート（発生）

(2) 分散後の地域社会（交通混雑）の予測評価

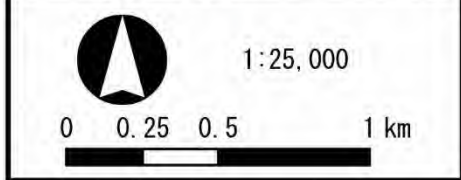
① 交差点需要率

準備書に記載した予測に用いた工事用車両の台数と、分散後の工事用車両の台数を表 29-1 に示します。また、準備書と分散後の交差点需要率の予測結果を表 29-2 に示します。

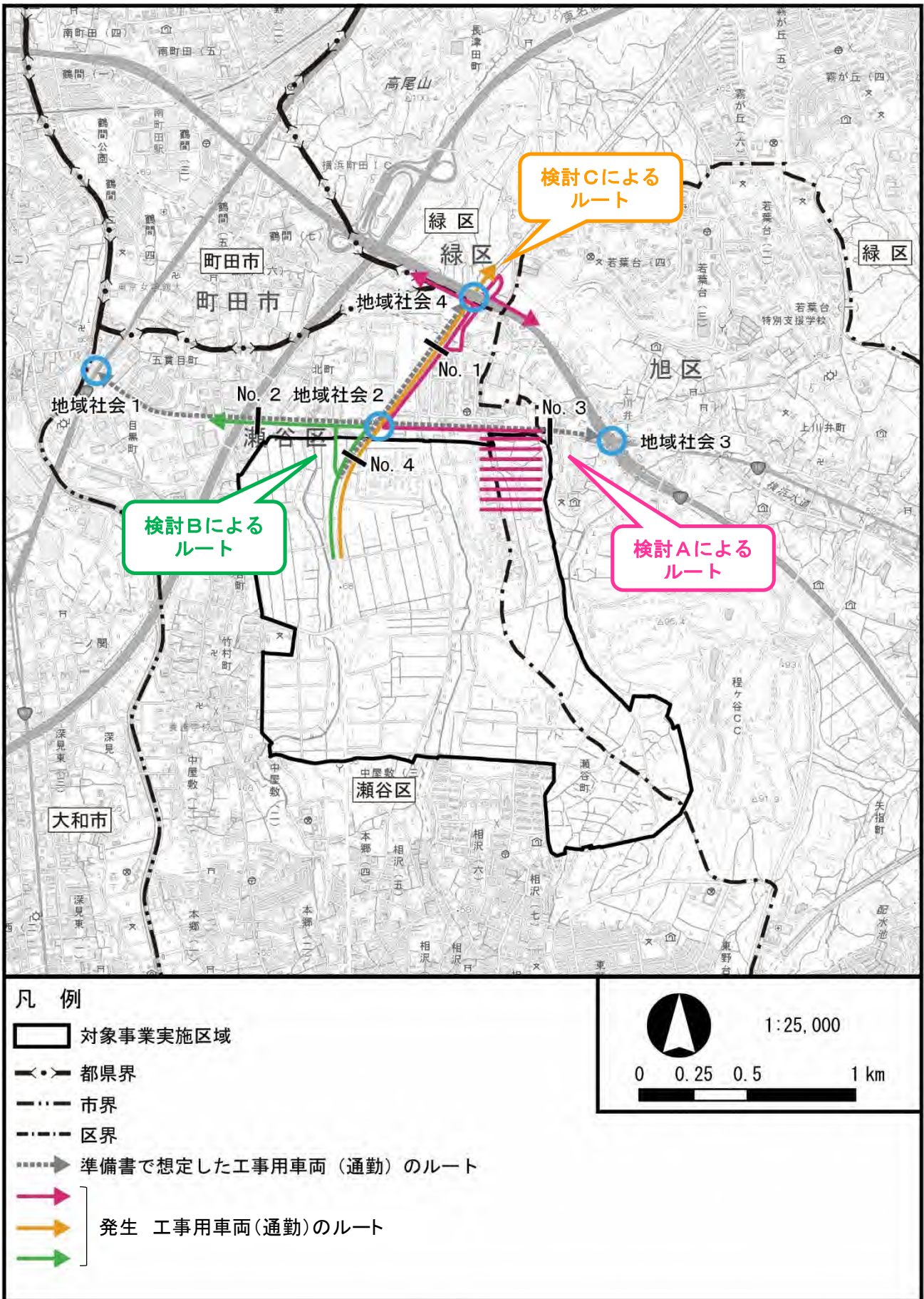
地域社会 1（目黒交差点）は、工事用車両の台数に変化がありませんので、交差点需要率も変化はありません。

最も混雑していた地域社会 2（目黒交番前交差点）は、交差点を通過する工事用車両の台数を分散させたことにより、交差点需要率は、1.114 から 0.929 と改善されました。しかし、限界需要率（0.900）は超えています。

地域社会 3（上川井 IC 交差点）は、交差点を通過する工事用車両台数が減るので、交差点需要率も小さくなります。

地域社会 4 は、滝沢交差点は対象事業実施区域からの右折車が増えますが、対向車線の直進車が少ないため負荷がかからず、交差点需要率の変化はありません。瀬谷土橋交差点は、通過する工事用車両台数が増えるため、交差点需要率は大きくなります。しかし、限界需要率は超えていません。

表 29-1 準備書及び分散後の予測に用いた工事用車両の台数

予測地点	工事中ピーク時間帯		準備書※ ¹				分散後※ ²			
			方向	1 時間あたり		方向	1 時間あたり			
	平日	休日		大型車	小型車		大型車	小型車		
地域社会 1 （目黒）	17:00～ 18:00	16:45～ 17:45	C→A	31 台	43 台	C→A	31 台	43 台		
			C→B	31 台	43 台	C→B	31 台	43 台		
			C→D	31 台	43 台	C→D	31 台	43 台		
地域社会 2 （目黒交番前）	17:00～ 18:00	16:45～ 17:45	C→A	93 台	129 台	C→A	93 台	129 台		
			C→B	93 台	129 台	C→B	93 台	0 台		
			C→D	94 台	129 台	C→D	0 台	0 台		
			D→A	0 台	0 台	D→A	94 台	129 台		
地域社会 3 （上川井 IC）	17:00～ 18:00	16:45～ 17:45	B→A	31 台	43 台	B→A	0 台	0 台		
			B→C	32 台	43 台	B→C	0 台	0 台		
			B→D	31 台	43 台	B→D	0 台	0 台		
			A→D	0 台	0 台	A→D	31 台	43 台		
地域社会 4 （滝沢）	17:30～ 18:30	17:00～ 18:00	B→A	93 台	129 台	B→A	93 台	129 台		
			B→C	0 台	0 台	B→C	63 台	86 台		
地域社会 4 （瀬谷土橋公園入口）	17:30～ 18:30	17:00～ 18:00	B→A	93 台	129 台	B→A	156 台	215 台		
			B→C	0 台	0 台	B→C	31 台	43 台		

注：1. 網掛けは、準備書の時と比べて工事用車両の台数が変わったことを示します。

2. 「方向」は、後掲図 29-5 と対応しています。

※1：「準備書」は、準備書に記載された工事用車両の台数を示します。

※2：「分散後」は、今回の工事用車両運行ルート of 分散を行い、予測計算に用いた台数を示します。

表 29-2 準備書及び分散後の交差点需要率の予測結果

交差点名		時間帯	交差点需要率（平日）			限界 需要率
			現況	準備書※ ¹	分散後※ ²	
地域社会 1	目黒	17：00～18：00	0.633	0.686	0.686	0.889
地域社会 2	目黒交番前	17：00～18：00	0.793	1.114	0.929	0.900
地域社会 3	上川井 IC	17：00～18：00	0.680	0.807	0.763	0.847
地域社会 4	滝沢	17：30～18：30	0.457	0.532	0.532	0.904
	瀬谷土橋公園入口	17：30～18：30	0.502	0.513	0.591	0.913

注：網掛けは、限界需要率を上回ったことを示します。

※1：「準備書」は、準備書に記載された交差点需要率を示します。

※2：「分散後」は、今回の工事用車両運行ルート分散を行い、予測計算を行った結果を示します。

② 車線の交通容量比

準備書と分散後の車線の交通容量比を表 29-3 に示します。

全体的に工事用車両の分散により、車線の交通容量比は小さくなり改善がみられます。特に目黒交番前交差点の C 断面の右折車線は 2.631 であったのが 0.737 へと 1.0 を下回る改善が見られました。一方、上川井 IC 交差点の A 断面の左折・右折車線、瀬谷土橋公園入口交差点の B 断面の右折車線は新たに 1.0 を上回る予測結果となりました。

しかし、これらの交差点は交差点需要率が限界需要率を超えていませんので、信号現示を検討することによって 1.0 を下回ることが可能と考えられます。

①、②より、目黒交番前交差点では交差点需要率が限界需要率を超え、滝沢交差点以外の交差点では、一部の車線において交通容量比が 1.0 を上回る車線が存在するので、準備書に記載した環境保全措置に加えて、

「ピーク時間帯における運行ルートの分散」

という項目を追記します。

表 29-3 準備書及び分散後の車線の交通容量比の予測結果

交差点名		断面※1	流入車線構成	車線の交通容量比（平日）		
				現況	準備書※2	分散後※3
地域社会 1	目黒	A	左折・直進	0.889	0.889	0.889
			右折	0.245	0.343	0.343
		B	左折・直進	0.533	0.533	0.533
			右折	0.766	0.766	0.766
		C	左折	0.773	0.952	0.952
			直進	0.855	1.017	1.017
			右折	0.257	0.460	0.460
		D	左折・直進	0.495	0.495	0.495
			右折	0.701	0.701	0.701
		地域社会 2	目黒交番前	A	左折・直進	0.603
直進	0.603				0.603	0.603
右折	1.116				1.116	1.116
B	左折			0.279	0.279	0.279
	直進			0.815	0.815	0.815
	右折			0.287	0.287	0.287
C	左折・直進			0.524	1.735	1.427
	直進			0.524	1.735	1.427
	右折			0.737	2.631	0.737
D	左折・直進			0.984	0.984	0.984
	右折			0.031	0.031	0.759
地域社会 3	上川井 IC			A	左折・右折	0.748
		直進	0.865		1.122	0.865
		B	右折	0.786	0.932	0.819
			右折	0.609	0.609	0.609
		D	直進	0.626	0.626	0.626
			右折	0.319	0.319	0.319
地域社会 4	滝沢	A	左折・直進	0.453	0.453	0.453
			直進	0.453	0.453	0.453
		B	直進	0.403	0.559	0.559
			右折	0.056	0.056	0.378
		C	左折・右折	0.639	0.639	0.639
			右折	0.631	0.631	0.631
	瀬谷土橋公園入口	A	左折・直進	0.636	0.636	0.636
			直進	0.636	0.636	0.636
		B	直進	0.300	0.490	0.618
			右折	0.389	0.389	1.008
C	左折	0.274	0.274	0.274		
	右折	0.568	0.568	0.568		

注：網掛けは、交通容量比が1.0を上回ったことを示します。

※1：「断面」は、図 29-5 と対応しています。

※2：「準備書」は、準備書に記載された交通容量比を示します。

※3：「分散後」は、今回の工事用車両運行ルート分散を行い、予測計算を行った結果を示します。



図 29-5 : 交差点の断面の位置

※赤で示した断面は、車線の交通容量比が 1.0 を超える車線を含む断面になります。

(3) 分散後の騒音の予測評価

準備書に記載した予測値と今回の工事用車両運行ルート of 分散後の予測値について、騒音の予測値の比較を表 29-4 に示します。

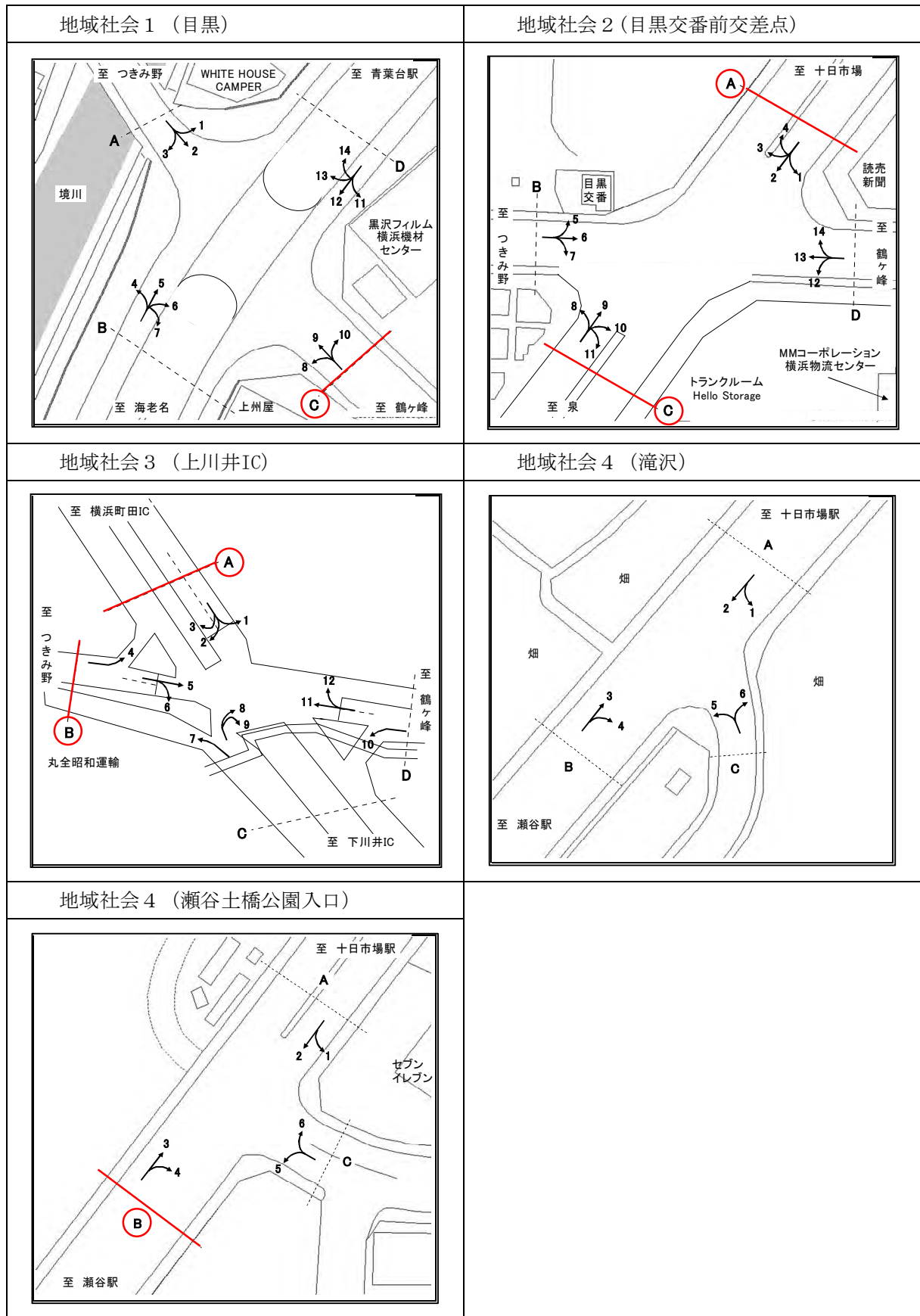
No. 1 は、迂回してきた工事用車両が通過し車両台数が増えるため、騒音レベルの予測値は増加しますが、環境基準の値は下回ります。

No. 2 は、準備書の時と通過する工事用車両台数に変化が無いので、騒音レベルの予測値も変化はありません。

No. 3 は、通過する工事用車両台数が減るため、騒音レベルの予測値は減少します。環境基準は超過していますが、将来一般交通量の段階でも超えている予測となっています。

No. 4 は、当初、将来一般交通量の段階では環境基準値を下回っていますが、工事用車両の運行により、環境基準を超過する地点でした。運行ルートの分散により、改善がみられ、工事用車両の走行によっても、環境基準を上回らない予測結果となります。

表 29-4 準備書の予測値と今回検討した予測値との比較（騒音レベル）

単位：dB

予測時間帯	予測地点	道路名	方向	予測結果			環境基準	
				将来一般交通量※1	準備書※1	分散後※2	環境基準	地域類型
昼間	No. 1	環状4号線	東側	65.7 (○)	65.9 (○)	66.2 (○)	70 以下	幹線
			西側	66.7 (○)	66.9 (○)	67.8 (○)	70 以下	幹線
	No. 2	八王子街道	北側	71.9 (×)	72.0 (×)	72.0 (×)	65 以下	C (道路)
			南側	71.0 (×)	71.1 (×)	71.1 (×)	65 以下	C (道路)
	No. 3	八王子街道	南側	72.7 (×)	73.5 (×)	73.2 (×)	65 以下	C (道路)
			北側	72.6 (×)	73.4 (×)	72.9 (×)	65 以下	C (道路)
	No. 4	環状4号線	西側	69.7 (○)	71.6 (×)	70.1 (○)	70 以下	幹線
			東側	69.8 (○)	71.7 (×)	70.2 (○)	70 以下	幹線

注：網掛けは、環境基準の値を超えていることを示します。

※1：「将来一般交通量」、「準備書」は、準備書に記載された予測結果を示します。

※2：「分散後」は、今回の工事用車両運行ルートの分散を行い、予測計算を行った結果を示します。

30. 将来の自動車交通量の需要予測について

影響要因の「関係車両の走行」については、予測対象時期を、関係車両の走行が定常となる時期（2046年）としています。

予測対象時期における交通量は、下記の都市計画事業が整備されていることを条件とし、当該時期の自動車交通量を算出しました。

従って、他の道路を迂回して、対象事業実施区域内を走行する車両台数についても加味された需要予測となっています。

<対象としている都市計画事業>

- 対象事業実施区域内の道路整備（区域内道路1号～3号の整備、環状4号線南区間の拡幅整備）
- 五貫目第33号線の拡幅整備
- 瀬谷地内線の整備
- （仮称）都市高速鉄道上瀬谷ラインの整備

31. 大門川及び相沢川の暗渠化による影響等について（継続）

8月31日開催の審査会で提示した記述について、以下のとおり修正します。修正にあたっては、相沢川の状況の写真についても、河床の状況が分かりやすいものに差し替えました。また、文章についてもわかりやすくするために、記載の順序の変更などを行いました。

相沢川及び大門川の現状の河床の状況（2021年8月13日撮影 天候雨）は次の写真のとおりです。いずれも、川底には、斑状に藻類が付着している状況が見られます。

<相沢川の状況>



<大門川の状況>



都市計画対象事業の実施に伴い、大門川と相沢川が暗渠化された場合、藻類による酸素供給ができなくなるため、好気性細菌による浄化機能は低下すると思われる。

(1)大門川について

大門川については、北町の工場地帯を流下してから対象事業実施区域内に入ることもあり、令和元年度の現地調査時の観測では、上流側（対象事業実施区域の北端部付近）では、豊水期、渇水期ともにBODや全亜鉛について環境基準値を超過しています。また、上流側の水質調査地点付近には川底に土砂が堆積しており、降雨がない場合においても水の濁りが目視で確認できる場合があります。（準備書P.9.4-10（表9.4-5(2)参照。））また、上流側の水質が悪いこともあり、pHを除くほぼ全ての水質項目で上流側よりも下流側の水質は良好となっており、濁り成分の沈降、吸着に加えて、下流側でBODが低下し、DOが上昇していることを踏まえると、川底の藻類等の光合成による酸素供給及び河床の従属栄養の好気性菌類（生物膜）による水質浄化機能を有していると考えられます。

水の汚れについては、上流側の工場地帯の排水がその要因になっていると考えられますが、暗渠化により、対象事業実施区域内におけるこれらの水の汚れの浄化機能は低下するものと思われる。これに対応するため、大門川下流側の予測地点（準備書P.9.4-16（図9.4-5）参照）において、後述する補足資料41に示す手法により、水の汚れのモニタリングを行

い、環境基準に適合しない結果となった場合には、適切な環境保全措置を講じるものとします。

一方、水の濁りについては、大門川上流側の水質調査地点である「水質1」（準備書P.9.4-5（図9.4-1）参照）付近において非耕作期にその周辺の農耕地が裸地状態になり、大門川に土砂が流れ込みやすくなっている状況であるため、暗渠化に併せて、暗渠入口周辺の舗装や土砂流出防止柵設置等により、「水質1」付近における河川への土砂流入を防ぐことで、水の濁りなどが低減されると考えられます。

(2)相沢川について

相沢川については、対象事業実施区域の北端部付近が源となっており、上流側の水質が比較的良好であるため、上流側と下流側の水質の差異は顕著ではありませんが、渇水期では大門川と同様に、下流側で水質が良好になる傾向がみられ、一定の水質浄化機能を有していると考えられます。ただし、相沢川については上流側の調査地点「水質3」における水質は環境基準に適合しており、暗渠内での水の滞留等を防ぐことができれば、下流側の水質は環境基準に適合したものになると考えられます。なお、相沢川下流側の予測地点（準備書P.9.4-16（図9.4-5）参照）においても、後述する補足資料41に示す手法により、水の汚れのモニタリングを行います。

(3)底質について

底質については、暗渠化に伴い、対象事業実施区域内の土砂が河川に流れ込むことがなくなる一方、調整池（工事中は仮設調整池）で濁り成分を十分沈降させた上澄みを放流することになります。従って、大門川及び相沢川の対象事業実施区域よりも下流側の底質への著しい影響はないものと考えます。

32. 「地下水への影響について（防衛省による調査結果）」の誤記について

7月27日開催の審査会資料のうち、「補足資料9. 地下水への影響について（防衛省による調査結果）」の表の注釈に誤りがありましたので、訂正します。

【誤】	【正】
※表層（深度0～0.5m）は平成29年度調査結果、その他は <u>平成</u> 元年度調査結果によります。	※表層（深度0～0.5m）は平成29年度調査結果、その他は <u>令和</u> 元年度調査結果によります。

33. 農地間の空間における草地環境について

本事業が土地区画整理事業という特性上、具体的な農業振興地区の土地利用が決まっていますが、畦道等の農地間の空間や、農道と農地間の空間等は、農耕地周辺に生息する種にとって生息環境の代償となり得るような整備が行えるよう、地権者と調整を図りながら検討していきます。

検討に際しては、現地形や新たに整備される盛土空間を踏まえ、将来的な土地利用も含めて面的に草地環境が確保できるよう検討いたします。

また、鳥類をはじめとする種が、周辺緑地と対象事業実施区域を広域に利用できるよう、草地環境を周辺緑地と有機的に繋げられるように整備し、地域個体群の維持に努めます。

34. 動植物の予測の考え方について（継続）

8月31日開催の審査会で提示した「図 影響予測の手順（植物）」について、原則、直接的影響と間接的影響の両方を予測した上で、予測結果の4段階のどれに該当するかを検討しています。

ただし、植物については対象事業実施区域内がすべて改変する前提としていることから、対象事業実施区域内にのみ生育し、工事の実施により消失してしまう種については、直接的影響のみで「生息環境への影響は大きい。」と予測できることから、直接的影響から「生育環境への影響は大きい。」に直結する赤色の矢印を追加しました。

したがって、対象事業実施区域内にのみ生育する植物については、直接的影響のみで予測していますが、動物、対象事業実施区域の周辺にも生育する植物、生態系については、直接的影響と間接的影響の両方を踏まえて予測しています。

35. 相沢川における生育・生息環境確保及び代償措置について（継続）

創出する生息・生育環境は、準備書（p.9.10-145、p.9.11-50、p.9.12-23）に記載した種を保全することを目的として、公園整備事業区域内の概ね1.5ha（東西方向：約60m～70m、南北方向：約220m～230m）のエリアにおいて、現在の土地利用や現地形をいかし、各保全対象種のハビタットタイプから必要な環境要素（湿地、草地、水路、樹林等）を確保する計画です。

現在の土地利用が水田と畑地又は休耕田がモザイク状に分布していることから、湿地と草地をモザイク状に配置し、草地については湿性草地と乾性草地を創出する計画としています。

各環境区分の面積や具体的な配置については、今後、公園整備事業等と調整を図りながら検討していきますが、湿地環境の周辺には湿性草地を配置するなど、各環境が緩やかに移行するような配置・構造を検討していきます。

なお、面積が限られることから、特に湿地環境、湿性草地及び水路といった水辺に生息・生育する種を中心に保全を図っていく方針です。樹林や乾性草地に生息・生育する種については、公園も含め上物の計画が検討中の段階ではありますが、瀬谷市民の森、周辺の緑との連続性に配慮した緑地の創出、農業振興地区等を有機的に繋げることにより、生物の移動に配慮する計画です。

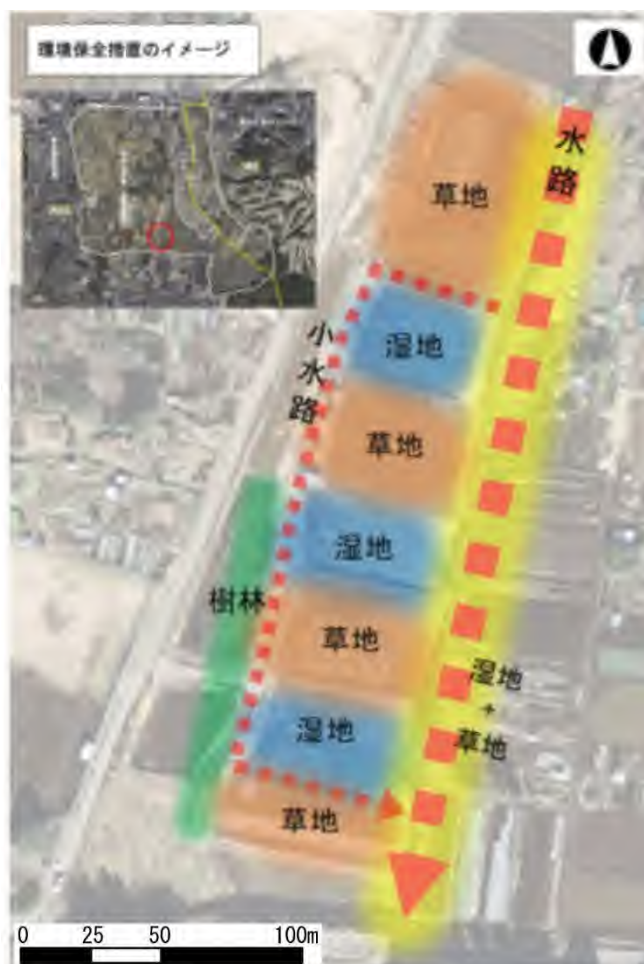

36. 和泉川源流部における生育・生息環境確保及び代償措置について



■ 生育・生息環境の考え方

- ・ 現況の湧水環境にて生息が確認されているホトケドジョウを保全対象種として、新たに小水路環境を創出します。
- ・ 現在の湧水地から湧水を導水する計画とし、水質は現状を維持します。

環境区分	保全対象種
小水路環境 (浅い水域、緩やかな流れ、砂泥底)	魚類：ホトケドジョウ

■ 環境区分のエコトーン断面イメージ

【東西断面】

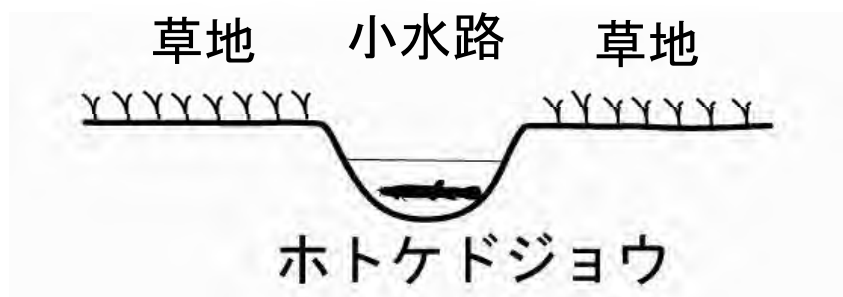

- ・ 産卵環境や稚魚の生息環境を創出するため、水草が繁茂した環境とします。
- ・ ホトケドジョウは雑食性であるため、水生昆虫や藻類等が生息・生育できる環境とします。
- ・ 水面への緑陰の形成や昆虫類等の餌資源供給のため、水際は草地環境とします。

※具体的な配置などの詳細は、今後、公園整備事業等と調整を図りながら、検討していきます。

37. 対象事業実施区域内の眺望景観（遠景）について

準備書における囲繞景観の現地調査地点は、図 37-1 に示す 4 地点 6 方向ですが、遠景の眺望点について再度、現地踏査を行いました。

現地踏査により代表的と思われる①から④の 4 地点と各地点から撮影した写真の撮影方向を図 37-1 に示します。また、撮影地点①から④付近の状況は以下のとおりです。

①地点

海軍道路の西側は主に畑として利用されており、標高は、海軍道路と同じか低いため、遠景の眺望点になるようなところはありませんでした。



①地点から東方向を撮影



①地点から西方向を撮影

②地点

囲障区域の西側から海軍道路までの範囲は、標高に大きな高低差が無く、主に畑や草地として利用されています。そのため、遠景の眺望点になるようなところはありませんでした。



②地点から東方向を撮影



②地点から西方向を撮影

③地点

囲障区域内にあるグラウンド付近は、周辺より小高い丘になって畑や草地となっています。そこからの東側の遠景の眺望は比較的開けており、準備書の現地調査地点のB地点と同じように、川井・矢指風致地区内の丘陵地や崖線の連なりが見え、丘陵地には農地と樹林などの緑と墓地が見えました。西側の眺望も比較的開けていますが、遠景の眺望は準備書の現地調査地点のA地点、C地点と同じように、丹沢の山並みが見えました。



③地点から東方向を撮影



③地点から西方向を撮影

④地点

程ヶ谷カントリー倶楽部近くにあるグラウンドの西側は、周辺より標高が高くなっていますが周囲には高木が連なっており、東側の眺望は、手前側に畑、その奥に程ヶ谷カントリー倶楽部等の樹木が見えました。西側の遠景はほとんど見えず、坂道の道路から少しだけ丹沢の山並みの遠景が望めました。



④地点から北東方向を撮影



④地点から南西方向を撮影

以上のように対象事業実施区域内には標高が少し高い所はありますが、そこからの遠景の眺望は、準備書で設定している地点からの眺望と大きな違いはありませんでした。

以上より、囲繞景観の調査、予測・評価地点は、準備書に記載された地点で問題はないと考えます。



図 37-1 困障景観の現地踏査位置（写真撮影を行った位置と方向）

38. 建設発生土について（継続）

準備書 P. 9. 15-7 の「(2)環境保全措置の検討」について、評価書においては、次のように追記します。（太字、下線部分が追記内容） また、関連する準備書 P. 10-19（表 10. 2. 15-1）についても同様に追記します。

(2) 環境保全措置の検討

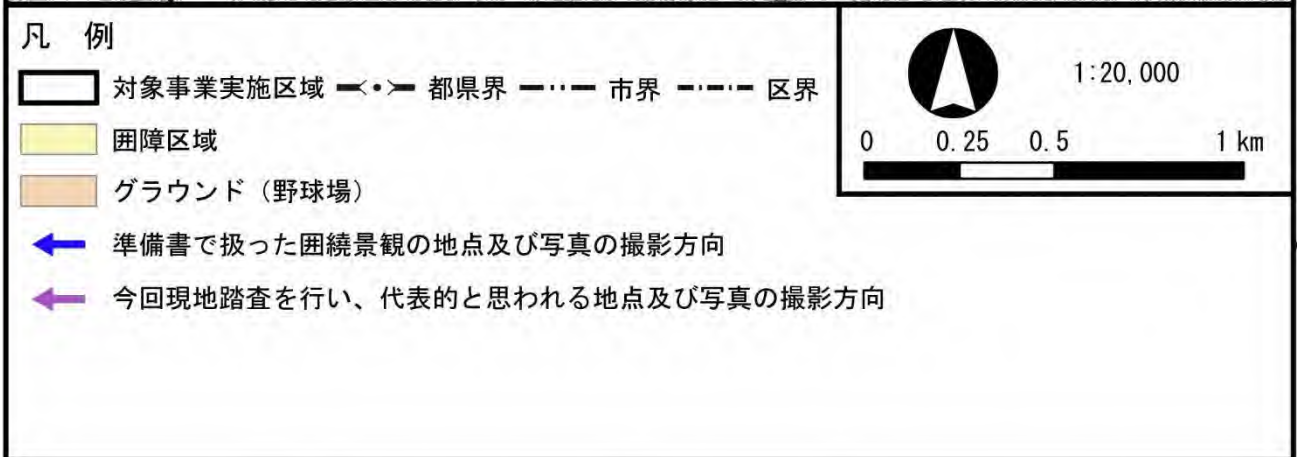
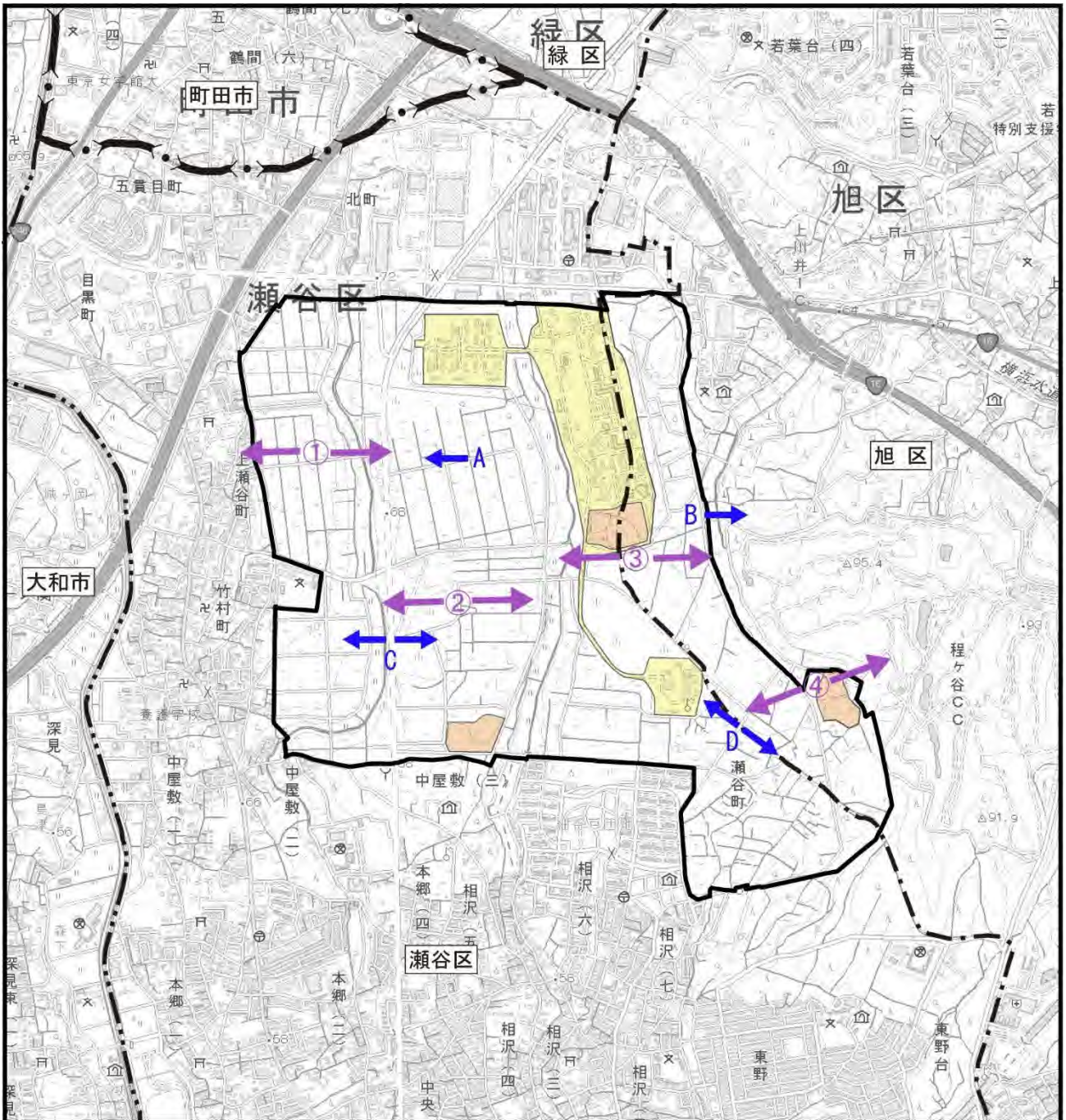
① 環境保全措置の検討の状況

事業者の実行可能な範囲内でできる限り、環境影響を回避又は低減することを目的として行った環境保全措置の検討の状況を、表 9. 15-9 に示します。

表 9. 15-9 環境保全措置の検討の状況

環境保全措置	実施の適否	適否の理由
産業廃棄物の分別・適正処理	適	産業廃棄物は、分別を徹底し可能な限り再資源化に努め、再資源化できないものは最終処分場にて適切に処理することにより、廃棄物等への影響が低減されることから、適正な環境保全措置であると考えて採用します。
建設発生土の場内利用	適	切土・盛土工事において、造成地盤高を調整することで、建設発生土をできる限り対象事業実施区域内で利用するとともに、関連事業の事業者と調整を図ることで、可能な限り場外搬出量の低減に努めることにより、廃棄物等への影響が低減されることから、適正な環境保全措置であると考えて採用します。
<u>市内及び近辺で行われる公共事業における有効利用</u>	適	<u>市内および近辺で行われる公共事業において、場外搬出される建設発生土の有効利用ができないか情報収集、協議を行うことにより、有効利用ができれば、埋立処分を行う発生土量の低減が図られることから、適正な環境保全措置であると考えて採用します。</u>
産業廃棄物、建設発生土の適正な管理	適	廃棄物の処理及び清掃に関する法律、神奈川県土砂の適正処理に関する条例等を遵守することにより、 <u>産業廃棄物や建設発生土の適正処理が図られることから採用します。</u>
<u>運搬距離を考慮した建設発生土の埋立地及び受入地の選定</u>	適	<u>場外搬出される建設発生土の埋立地及び受入地先は、対象事業実施区域からなるべく近いところを選ぶことにより、建設発生土を運搬する車両から発生する排気ガス、騒音、振動等の影響範囲の縮小が図られることから採用します。</u>
運搬時の環境負荷軽減	適	車両については、 <u>低燃費のものを使用し、二酸化炭素の排出抑制を図るほか、運搬時には、過積載の防止を徹底することにより、高負荷運転による大気汚染、騒音、振動の抑制を図ることができるため採用します。</u>
<u>汚染土壌の場外搬出時における適切な対応</u>	適	<u>汚染土壌の掘削除去に伴い場外搬出する場合は、土壌汚染対策法に基づいて適切に処理を行うことにより、汚染物質の拡散防止が図られることから採用します。</u>

② 環境保全措置の実施主体、内容、効果の不確実性、他への影響

造成工事の実施に伴う廃棄物等の発生への影響を低減させるため、表 9.15-10 に示すとおり、環境保全措置を実施します。

表 9.15-10 環境保全措置の実施の内容

影響要因	影響	検討の視点	環境保全措置			実施主体	効果の不確実性	他の環境への影響	
			内容	効果	区分				
工事の実施	造成工事の実施	廃棄物等による環境への負荷	廃棄物等の発生量削減	産業廃棄物の分別・適正処理	分別を徹底し、可能な限り再資源化を行い、再資源化できない場合は適正処理を行うことにより、廃棄物等による環境への負荷が低減されます。	低減	事業者	なし	なし
				建設発生土の場内利用	切土・盛土工事において、造成地盤高の調整、関連事業の事業者と調整を図ることにより、建設発生土の場外搬出量が低減されます。	低減	事業者	なし	なし
				市内及び近辺で行われる公共事業における有効利用	<u>有効利用ができれば、埋立処分を行う発生土量の低減が図られます。</u>	低減	事業者	なし	なし
			産業廃棄物、建設発生土の適正な管理	<u>廃棄物の処理及び清掃に関する法律、神奈川県土砂の適正処理に関する条例等を遵守することにより、産業廃棄物や建設発生土の適正処理が図られます。</u>	低減	事業者	なし	なし	
			廃棄物等の運搬に伴う影響低減	<u>運搬距離を考慮した建設発生土の埋立地及び受入地の選定</u>	<u>建設発生土を運搬する車両から発生する排気ガス、騒音、振動等の影響範囲の縮小が図られます。</u>	低減	事業者	なし	なし
				運搬時の環境負荷軽減	<u>二酸化炭素の排出抑制、大気汚染、騒音、振動の抑制が図られます。</u>	低減	事業者	なし	なし
				汚染土壌の場外搬出時における適切な対応	<u>汚染物質の拡散防止が図られます。</u>	低減	事業者	なし	なし

39. 温室効果ガスの低減対策について

温室効果ガスについては、準備書P. 11-1～4に示す事後調査の項目とはしていませんが、その低減対策として準備書 P. 9. 16-7（表 9. 16-9）、P. 9. 16-11（表 9. 16-14）に示した環境保全措置が適切に実施されているかどうかについて、用いた建設機械等の機種、省エネ運転等の公表について検討します。

40. 瀬谷地内線における交差点需要率について

対象事業実施区域の南東側を走る瀬谷地内線等に、新しく2つの交差点ができます。その2つの交差点について交差点需要率を予測計算しました。2つの交差点の位置を図40-1に、交差点需要率の予測結果は表40-1及び表40-2に示します。また、方向別交通量と大型車混入率を表40-3に示します。

予測の結果、関係車両の走行における2つの交差点の交差点需要率は0.084～0.655となり、いずれも供用時限界需要率の値よりも小さな値となっています。

表 40-1 新設される2つの交差点の交差点需要率

時期	交差点名	ピーク時間帯	交差点需要率	供用時 限界需要率
平日	地域社会8	8:00～9:00	0.084	0.900
	地域社会9	7:00～8:00	0.649	0.900
休日	地域社会8	8:00～9:00	0.127	0.900
	地域社会9	16:00～17:00	0.655	0.900

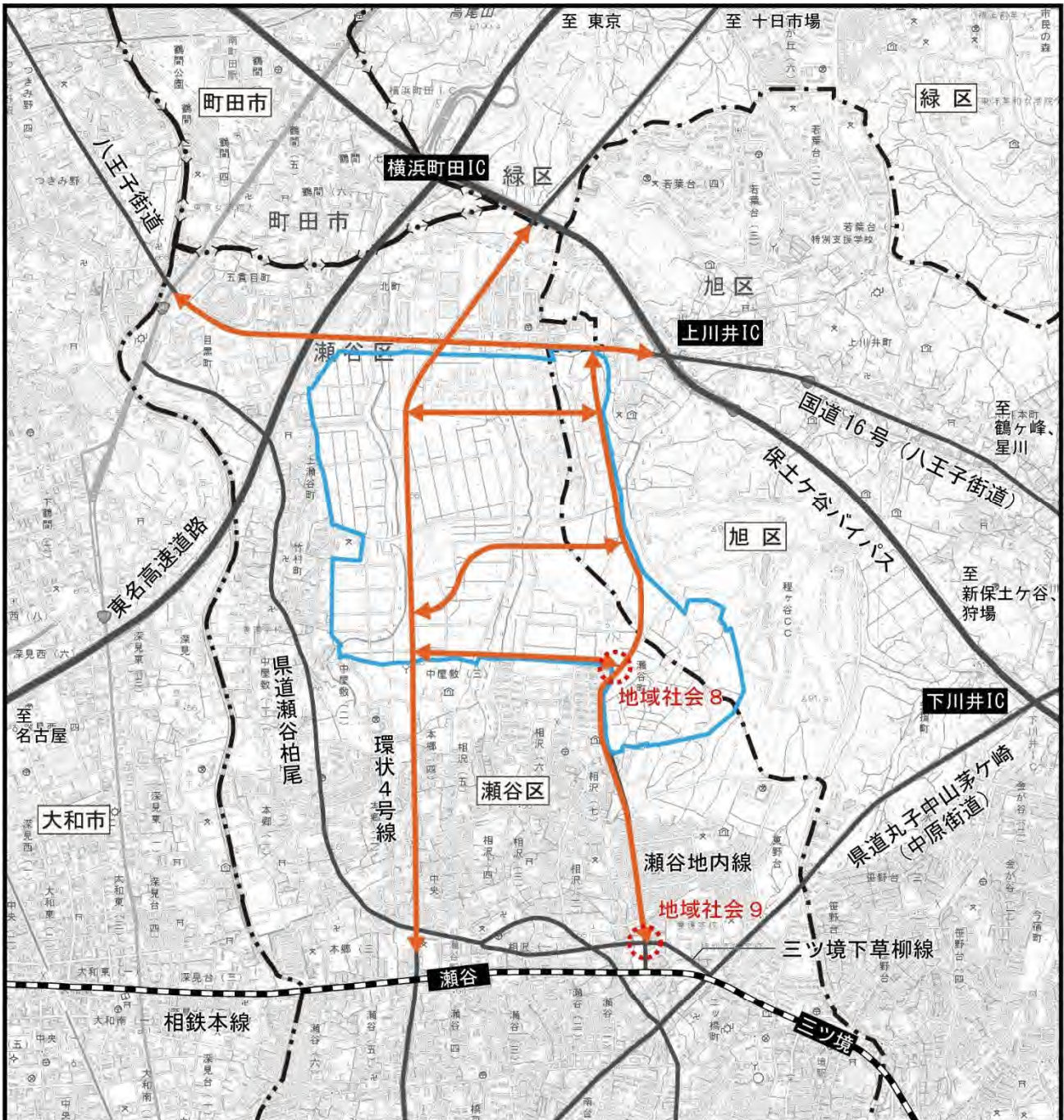

凡例

- 対象事業実施区域
- 都県界
- 市界
- 区界
- ↔ 関係車両の主な走行ルート
- ⊙ 交差点需要率を予測計算した交差点（まだ現存しません）



図 40-1 新設される2つの交差点の位置

表 40-2(1) 地域社会8の交差点需要率(平日:8時台)

流入部	①	②		③		現示の 需要率	交差点の 需要率
		直進	右折	左折・直進	左折		
車線の種類		直進	右折	左折・直進	左折	右折	
車線数		1	1	1	1	1	
飽和交通流率の基本値	S B	2000	1800	2000	1800	1800	
車線幅員による補正率 (車線幅員)	α_w m	1.000 (3.25)	1.000 (3.00)	1.000 (3.00)	1.000 (3.25)	1.000 (3.00)	
縦断勾配による補正率 (縦断勾配)	α_G %	1.000 (0.00)	1.000 (0.00)	1.000 (0.00)	1.000 (0.00)	1.000 (0.00)	
大型車混入による補正率 (大型車混入率)	α_T %	0.840 (27.27)	0.598 (96.00)	1.000 (0.00)	1.000 (0.00)	1.000 (0.00)	
左折車混入による補正率 (左折率)	α_{LT} L%			1.000 (0.0)			
(歩行者による低減率)	f p			0.50	0.50		
(有効青時間)	秒			52	30		
(歩行者用青時間)	秒			47	25		
横断歩行者による補正率	α_L				0.583		
右折車混入による補正率 (右折率)	α_{RT} R%						
(右折車の通過確率)	f		0.899				
(有効青時間)	秒		52				
(現示変り目のさげ台数増分)			2(80)				
KER:台/サイクル (交差点内滞留台数)							
K:台/サイクル							
飽和交通流率	S A	1680	*616	2000	1049	1800	
設計交通量	q	11	25	106 (0+106)	32	6	
右折補正交通量	q R - N						
交差点流入部の需要率	ρ	0.007	-	0.053	0.031	0.003	
必要現示率	1 ϕ	0.007	-	0.053			0.053
	2 ϕ				0.031	0.003	0.031
有効青時間(秒)	1 ϕ	52	52	52			サイクル長(秒)
	2 ϕ				30	30	90
信号青時間比	G/C	52/90	52/90	52/90	30/90	30/90	
可能交通容量	C i	971	616	1156	350	600	
交通容量比	q/C i	0.011	0.041	0.092	0.091	0.010	

* $N = KER \times \frac{3600}{C}$

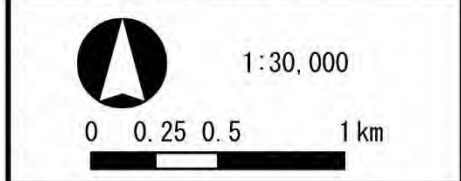
N : 1時間で右折車が交差点内に滞留する台数
* : 交通容量 (実1時間)

- A : 至 八王子街道
- B : 至 細谷戸ハイツ
- C : 至 環状4号線

現示方式の図示

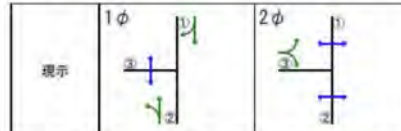

交差点概略図

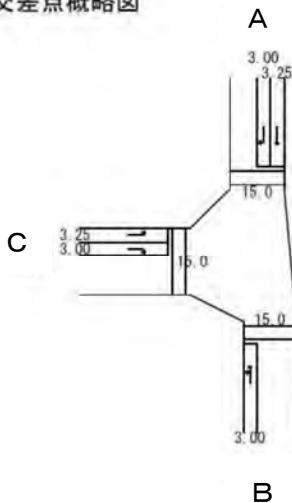

交通量図

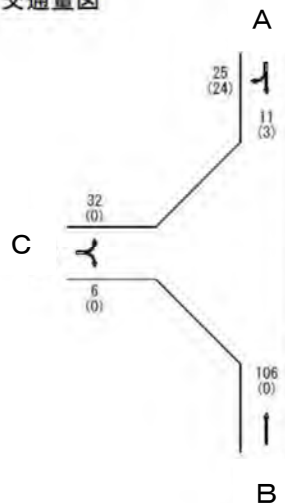

上段: 方向別合計交通量[台/時]
下段: (大型車混入台数)[台/時]

表 40-2(2) 地域社会8の交差点需要率(休日:8時台)

流入部		①	②	③		
車線の種類		直進	右折	左折・直進	左折	右折
車線数		1	1	1	1	1
飽和交通流率の基本値	S B	2000	1800	2000	1800	1800
車線幅員による補正率 (車線幅員)	α_w m	1.000 (3.25)	1.000 (3.00)	1.000 (3.00)	1.000 (3.25)	1.000 (3.00)
縦断勾配による補正率 (縦断勾配)	α_G %	1.000 (0.00)	1.000 (0.00)	1.000 (0.00)	1.000 (0.00)	1.000 (0.00)
大型車混入による補正率 (大型車混入率)	α_T %	0.920 (12.50)	0.598 (96.00)	1.000 (0.00)	1.000 (0.00)	1.000 (0.00)
左折車混入による補正率 (左折率)	α_{LT} L %			0.994 (0.6)		
(歩行者による低減率)	f p			0.50	0.50	
(有効青時間)	秒			52	30	
(歩行者用青時間)	秒			47	25	
横断歩行者による補正率	α_L				0.583	
右折車混入による補正率 (右折率)	α_{RT} R %					
(右折車の通過確率)	f		0.848			
(有効青時間)	秒		52			
(現示変り目のさげ台数増分)	KER ; 台/サイクル (交差点内滞留台数)		2(80)			
K ; 台/サイクル						
飽和交通流率	S A	1840	4574	1988	1049	1800
設計交通量	q	8	25	161 (1+160)	48	22
右折補正交通量	q R - N					
交差点流入部の需要率	ρ	0.004	-	0.081	0.046	0.012
必要現示率	1 ϕ	0.004	-	0.081		0.081
	2 ϕ				0.046	0.046
有効青時間(秒)	1 ϕ	52	52	52		90
	2 ϕ				30	30
信号青時間比	G / C	52 / 90	52 / 90	52 / 90	30 / 90	30 / 90
可能交通容量	C i	1063	574	1149	350	600
交通容量比	q / C i	0.008	0.044	0.140	0.137	0.037

$$N = KER \times \frac{3600}{C}$$

N : 1 時間で右折車が交差点内に滞留する台数
 ※ * : 交通容量 (実1時間)

A : 至 八王子街道
 B : 至 細谷戸ハイツ
 C : 至 環状4号線

現示方式の図示

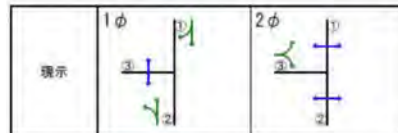

交差点概略図

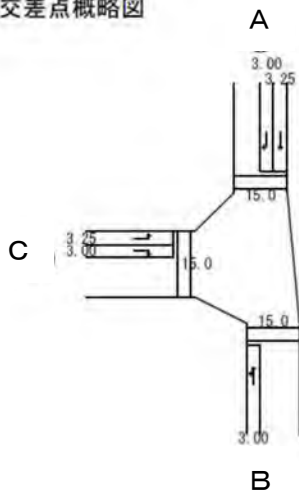

交通量図

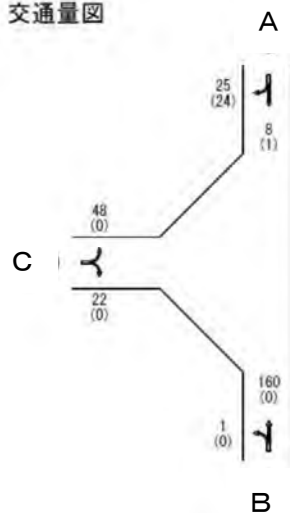

上段 : 方向別合計交通量[台/時]
 下段 : (大型車混入台数)[台/時]

表 40-2(3) 地域社会9の交差点需要率(平日:7時台)

流入部	①		②		③		④		左折・直進	右折
	左折・直進	右折	左折・直進	右折	左折・直進	右折	左折・直進	右折		
車線の種類	1	1	1	1	1	1	1	1		
車線数	1	1	1	1	1	1	1	1		
飽和交通流率の基本値	S B	2000	1800	2000	1800	2000	1800	2000	1800	1800
車線幅員による補正率 (車線幅員)	a w m	1.000 (3.00)	1.000 (3.00)	1.000 (3.00)	1.000 (3.00)	1.000 (3.00)	1.000 (3.00)	1.000 (3.00)	1.000 (3.00)	1.000 (3.00)
縦断勾配による補正率 (縦断勾配)	a G %	1.000 (0.00)	1.000 (0.00)	1.000 (0.00)	1.000 (0.00)	1.000 (0.00)	1.000 (0.00)	1.000 (0.00)	1.000 (0.00)	1.000 (0.00)
大型車混入による補正率 (大型車混入率)	a T %	0.785 (39.04)	0.980 (2.94)	0.923 (11.88)	1.000 (0.00)	0.791 (37.69)	0.968 (4.65)	0.952 (7.13)	1.000 (0.00)	1.000 (0.00)
左折車混入による補正率 (左折率)	a L T L %	1.000 (0.0)		0.936 (6.6)		1.000 (0.0)		0.749 (32.5)		
(歩行者による低減率)	f p	0.50		0.50		0.50		0.50		
(有効青時間)	秒	33		58		33		58		
(歩行者用青時間)	秒	28		53		28		53		
横断歩行者による補正率	a L									
右折車混入による補正率 (右折率)	a R T R %									0.744
(右折車の通過確率)	f				0.675					58
(有効青時間)	秒				58					58
(現示変り目のさげ台数増分)			2(60)				2(60)			
KER:台/サイクル (交差点内滞留台数)					2(60)					2(60)
K:台/サイクル										
飽和交通流率	S A	1570	1764	1728	*505	1582	1742	1426	*593	
設計交通量	q	292 (0+292)	170	303 (20+283)	0	321 (0+321)	43	547 (178+369)	0	
右折補正交通量	q R - N		110				0			
交差点流入部の需要率	ρ	0.186	0.062	0.175	-	0.203	-	0.384	-	現示の 需要率
必要現示率	1 φ	0.186				0.203				交差点の 需要率
	2 φ		0.062				-			0.649
	3 φ			0.175	-			0.384	-	0.062
有効青時間(秒)	1 φ	33				33				0.384
	2 φ		19				19			サイクル長(秒)
	3 φ			58	58			58	58	120
信号青時間比	G / C	33/120	19/120	58/120	58/120	33/120	19/120	58/120	58/120	
可能交通容量	C i	432	339	835	505	435	336	689	593	
交通容量比	q / C i	0.676	0.501	0.363	0.000	0.738	0.128	0.794	0.000	

* N = KER × $\frac{3600}{C}$

N : 1時間で右折車が交差点内に滞留する台数
* : 交通容量 (実1時間)

- C : 至 環状4号線
- A : 至 跡地
- D : 至 中原街道
- B : 至 ニツ上橋交差点

現示方式の図示



交差点概略図

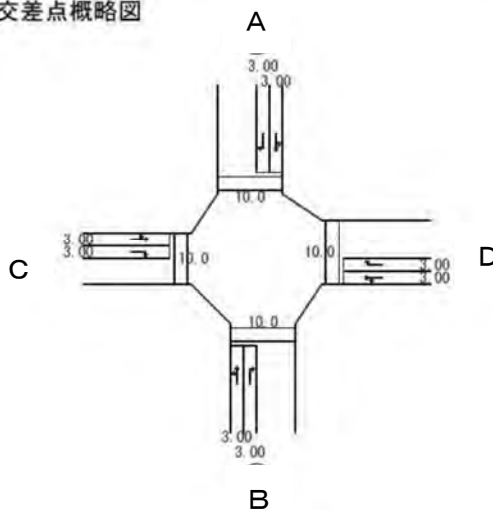

交通量図

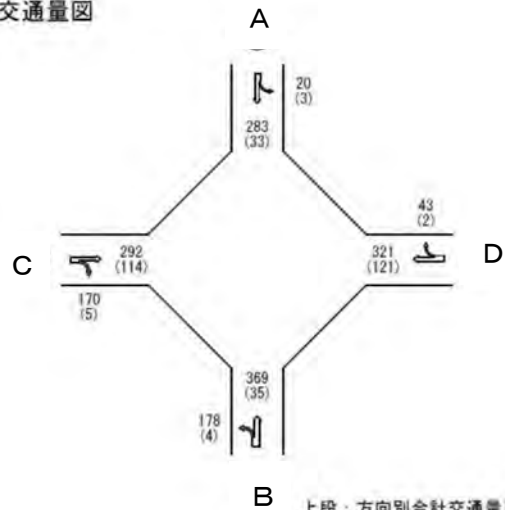

上段 : 方向別合計交通量[台/時]
下段 : (大型車混入台数)[台/時]

表 40-2(4) 地域社会9の交差点需要率(休日:16時台)

流入部	①		②		③		④		
	左折・直進	右折	左折・直進	右折	左折・直進	右折	左折・直進	右折	
車線の種類	1	1	1	1	1	1	1	1	
車線数	1	1	1	1	1	1	1	1	
飽和交通流率の基本値 S/B	2000	1800	2000	1800	2000	1800	2000	1800	
車線幅員による補正率 α _w (車線幅員)	1.000 (3.00)	1.000 (3.00)	1.000 (3.00)	1.000 (3.00)	1.000 (3.00)	1.000 (3.00)	1.000 (3.00)	1.000 (3.00)	
縦断勾配による補正率 α _G (縦断勾配)	1.000 (0.00)	1.000 (0.00)	1.000 (0.00)	1.000 (0.00)	1.000 (0.00)	1.000 (0.00)	1.000 (0.00)	1.000 (0.00)	
大型車混入による補正率 α _T (大型車混入率)	0.791 (37.78)	0.981 (2.79)	0.941 (9.02)	1.000 (0.00)	0.790 (38.07)	0.935 (10.00)	0.950 (7.46)	1.000 (0.00)	
左折車混入による補正率 α _L T (左折率) L%	1.000 (0.0)		0.922 (8.3)		1.000 (0.0)		0.745 (33.6)		
(歩行者による低減率) f _p (有効青時間) 秒	0.50 34		0.50 57		0.50 34		0.50 57		
(歩行者用青時間) 秒	29		52		29		52		
横断歩行者による補正率 α _L									
右折車混入による補正率 α _R T (右折率) R%									
(右折車の通過確率) f (有効青時間) 秒				0.685 57				0.669 57	
(現示変り目のさげ台数増分) KER: 台/サイクル (交差点内滞留台数) K: 台/サイクル		2(60)			2(60)			2(60)	
飽和交通流率 S/A	1582	1766	1735	*506	1580	1683	1416	*486	
設計交通量 q	315 (0+315)	179	410 (34+376)	0	331 (0+331)	30	536 (180+356)	0	
右折補正交通量 q _{R-N}		119				0			
交差点流入部の需要率 ρ	0.199	0.067	0.236	-	0.209	-	0.379	-	現示の 需要率
必要現示率	1φ 0.199				0.209				交差点の 需要率
	2φ	0.067							0.067
	3φ		0.236				0.379		0.379
有効青時間(秒)	1φ 34				34				サイクル長(秒)
	2φ	19				19			120
	3φ		57		57		57		
信号青時間比 G/C	34/120	19/120	57/120	57/120	34/120	19/120	57/120	57/120	
可能交通容量 C _i	448	340	824	506	448	326	673	486	
交通容量比 q/C _i	0.703	0.526	0.498	0.000	0.739	0.092	0.796	0.000	

$$N = KER \times \frac{3600}{C}$$

N: 1時間で右折車が交差点内に滞留する台数

*: 交通容量(実1時間)

- C: 至 環状4号線
- A: 至 跡地
- D: 至 中原街道
- B: 至 ニッ上橋交差点

現示方式の図示



交差点概略図

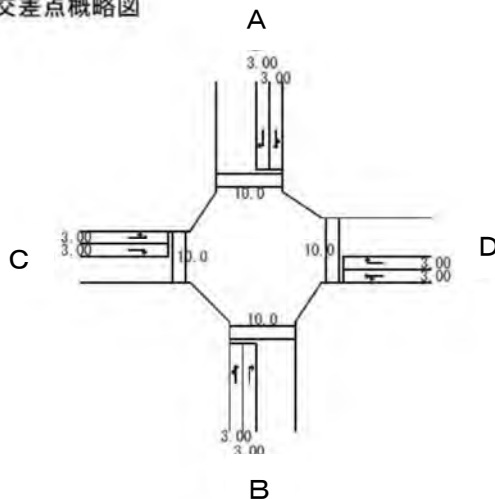

交通量図

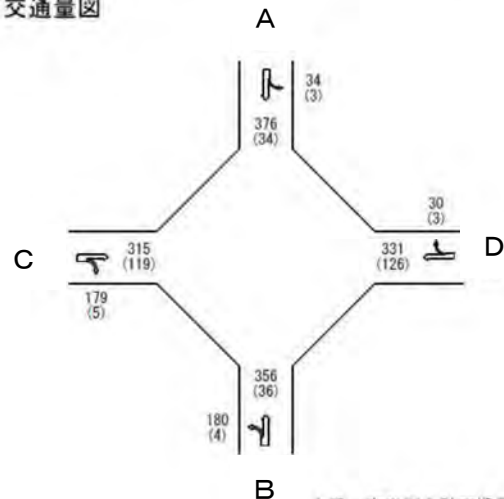

上段: 方向別合計交通量[台/時]
下段: (大型車混入台数)[台/時]

表 40-3(1) 地域社会 8 の方向別交通量

		A→B	A→C	A→D	B→A	B→C	B→D	C→A	C→B	C→D	D→A	D→B	D→C	計	
平日	7時	9	25	0	77	0	0	24	1	0	0	0	0	136	
	8時	11	25	0	100	0	0	32	6	0	0	0	0	181	
	9時	14	25	0	75	0	0	18	9	0	0	0	0	141	
	10時	16	25	0	55	0	0	11	10	0	0	0	0	118	
	11時	23	26	0	44	0	0	7	16	0	0	0	0	117	
	12時	19	14	0	36	0	0	5	21	0	0	0	0	96	
	13時	18	14	0	33	0	0	5	24	0	0	0	0	94	
	14時	27	15	0	29	0	0	4	27	0	0	0	0	102	
	15時	36	16	0	26	0	0	4	31	0	0	0	0	112	
	16時	26	18	0	22	0	0	3	42	0	0	0	0	120	
	17時	47	18	0	22	0	0	4	38	0	0	0	0	128	
	18時	46	30	0	16	0	0	3	27	0	0	0	0	125	
	19時	40	29	0	12	0	0	3	10	0	0	0	0	94	
	20時	24	29	0	11	0	0	3	18	0	0	0	0	94	
	21時	27	29	0	12	0	0	3	5	0	0	0	0	76	
	22時	21	28	0	10	0	0	3	4	0	0	0	0	67	
	23時	8	1	0	5	0	0	1	1	0	0	0	0	17	
	24時	3	1	0	3	0	0	1	1	0	0	0	0	8	
	休日	7時	6	25	0	111	0	0	35	1	0	0	0	0	179
		8時	8	25	0	100	1	0	48	22	0	0	0	0	265
		9時	9	25	0	141	1	0	27	30	0	0	0	0	232
		10時	10	25	0	55	0	0	16	32	0	0	0	0	180
		11時	13	26	0	77	0	0	11	44	0	0	0	0	171
		12時	11	14	0	58	0	0	8	56	0	0	0	0	148
13時		10	14	0	56	0	0	8	52	0	0	0	0	140	
14時		15	14	0	48	0	0	6	59	0	0	0	0	133	
15時		20	15	0	46	0	0	5	65	0	0	0	0	151	
16時		21	15	0	44	0	0	5	101	0	0	0	0	186	
17時		26	16	0	43	0	0	6	73	0	0	0	0	163	
18時		27	20	0	33	0	0	5	56	0	0	0	0	150	
19時		23	28	0	26	0	0	4	27	0	0	0	0	108	
20時		23	28	0	16	0	0	4	30	0	0	0	0	102	
21時		23	29	0	18	0	0	5	7	0	0	0	0	82	
22時		19	29	0	15	0	0	4	7	0	0	0	0	74	
23時		6	1	0	8	0	0	2	1	0	0	0	0	18	
24時		3	1	0	4	0	0	1	1	0	0	0	0	10	

表 40-3(2) 地域社会 8 の大型車混入率

		A→B	A→C	A→D	B→A	B→C	B→D	C→A	C→B	C→D	D→A	D→B	D→C	計	
平日	7時	0.39	0.91	-	0.00	0.00	-	0.00	0.00	-	-	-	-	0.20	
	8時	0.24	0.96	-	0.00	0.00	-	0.00	0.00	-	-	-	-	0.19	
	9時	0.25	0.95	-	0.00	0.00	-	0.00	0.00	-	-	-	-	0.20	
	10時	0.22	0.94	-	0.00	0.00	-	0.00	0.00	-	-	-	-	0.23	
	11時	0.15	0.92	-	0.00	0.00	-	0.00	0.00	-	-	-	-	0.24	
	12時	0.11	0.88	-	0.00	0.00	-	0.00	0.00	-	-	-	-	0.15	
	13時	0.12	0.88	-	0.00	0.00	-	0.00	0.00	-	-	-	-	0.15	
	14時	0.08	0.86	-	0.00	0.00	-	0.00	0.00	-	-	-	-	0.14	
	15時	0.08	0.74	-	0.00	0.00	-	0.00	0.00	-	-	-	-	0.13	
	16時	0.05	0.72	-	0.00	0.00	-	0.00	0.00	-	-	-	-	0.12	
	17時	0.05	0.68	-	0.00	0.00	-	0.00	0.00	-	-	-	-	0.11	
	18時	0.02	0.79	-	0.00	0.00	-	0.00	0.00	-	-	-	-	0.20	
	19時	0.03	0.82	-	0.00	0.00	-	0.00	0.00	-	-	-	-	0.27	
	20時	0.03	0.83	-	0.00	0.00	-	0.00	0.00	-	-	-	-	0.27	
	21時	0.01	0.83	-	0.00	0.00	-	0.00	0.00	-	-	-	-	0.32	
	22時	0.01	0.96	-	0.00	0.00	-	0.00	0.00	-	-	-	-	0.36	
	23時	0.02	0.00	-	0.00	0.00	-	0.00	0.00	-	-	-	-	0.01	
	24時	0.05	0.00	-	0.00	0.00	-	0.00	0.00	-	-	-	-	0.02	
	休日	7時	0.20	0.96	-	0.00	0.00	-	0.00	0.00	-	-	-	-	0.14
		8時	0.13	0.94	-	0.00	0.00	-	0.00	0.00	-	-	-	-	0.10
		9時	0.18	0.86	-	0.00	0.00	-	0.00	0.00	-	-	-	-	0.11
		10時	0.16	0.94	-	0.00	0.00	-	0.00	0.00	-	-	-	-	0.14
		11時	0.12	0.93	-	0.00	0.00	-	0.00	0.00	-	-	-	-	0.15
		12時	0.09	0.88	-	0.00	0.00	-	0.00	0.00	-	-	-	-	0.09
13時		0.09	0.86	-	0.00	0.00	-	0.00	0.00	-	-	-	-	0.09	
14時		0.05	0.84	-	0.00	0.00	-	0.00	0.00	-	-	-	-	0.08	
15時		0.05	0.81	-	0.00	0.00	-	0.00	0.00	-	-	-	-	0.09	
16時		0.05	0.79	-	0.00	0.00	-	0.00	0.00	-	-	-	-	0.07	
17時		0.04	0.76	-	0.00	0.00	-	0.00	0.00	-	-	-	-	0.08	
18時		0.02	0.88	-	0.00	0.00	-	0.00	0.00	-	-	-	-	0.16	
19時		0.02	0.87	-	0.00	0.00	-	0.00	0.00	-	-	-	-	0.23	
20時		0.02	0.84	-	0.00	0.00	-	0.00	0.00	-	-	-	-	0.24	
21時		0.00	0.83	-	0.00	0.00	-	0.00	0.00	-	-	-	-	0.30	
22時		0.00	0.83	-	0.00	0.00	-	0.00	0.00	-	-	-	-	0.32	
23時		0.01	0.00	-	0.00	0.00	-	0.00	0.00	-	-	-	-	0.00	
24時		0.03	0.00	-	0.00	0.00	-	0.00	0.00	-	-	-	-	0.01	

表 40-3(3) 地域社会 9 の方向別交通量

	時間	方向別交通量												計	
		A→B	A→C	A→D	B→A	B→C	B→D	C→A	C→B	C→D	D→A	D→B	D→C		
平日	7時	183	0	20	388	173	0	0	170	292	43	0	321	1,676	
	8時	278	0	21	370	173	0	0	185	281	53	0	313	1,661	
	9時	288	0	19	322	185	0	0	190	289	40	0	293	1,486	
	10時	248	0	19	290	149	0	0	142	246	32	0	267	1,391	
	11時	237	0	18	287	133	0	0	130	220	26	0	243	1,282	
	12時	224	0	17	245	123	0	0	121	208	23	0	225	1,188	
	13時	238	0	18	297	131	0	0	129	229	23	0	240	1,260	
	14時	243	0	19	281	129	0	0	127	221	21	0	238	1,248	
	15時	267	0	22	288	139	0	0	137	236	22	0	254	1,344	
	16時	283	0	24	285	143	0	0	141	249	21	0	262	1,390	
	17時	317	0	27	296	162	0	0	160	281	24	0	296	1,566	
	18時	332	0	28	315	175	0	0	173	304	23	0	320	1,670	
	19時	269	0	23	280	144	0	0	143	252	19	0	265	1,371	
	20時	228	0	24	218	121	0	0	120	216	16	0	221	1,182	
	21時	172	0	22	170	94	0	0	94	174	14	0	173	914	
	22時	123	0	19	121	66	0	0	67	127	11	0	122	654	
	23時	55	0	6	56	31	0	0	31	55	5	0	56	295	
	24時	38	0	4	40	22	0	0	22	39	3	0	41	209	
	休日	7時	115	0	10	194	72	0	0	88	120	48	0	132	757
		8時	185	0	17	286	109	0	0	102	178	64	0	196	1,133
		9時	237	0	20	343	133	0	0	130	226	55	0	247	1,390
		10時	289	0	23	350	160	0	0	158	233	44	0	290	1,596
		11時	304	0	25	350	169	0	0	183	283	38	0	304	1,637
		12時	298	0	24	328	158	0	0	184	288	32	0	298	1,546
13時		317	0	25	342	168	0	0	186	287	33	0	309	1,642	
14時		307	0	27	314	154	0	0	183	287	29	0	287	1,533	
15時		372	0	28	318	157	0	0	156	275	28	0	289	1,563	
16時		376	0	34	350	180	0	0	179	315	30	0	331	1,801	
17時		310	0	31	304	153	0	0	182	273	28	0	282	1,540	
18時		316	0	32	308	160	0	0	180	287	26	0	284	1,583	
19時		272	0	23	317	172	0	0	172	283	19	0	280	1,407	
20時		186	0	27	181	98	0	0	100	182	16	0	182	988	
21時		143	0	26	142	77	0	0	78	154	14	0	141	776	
22時		145	0	26	145	79	0	0	80	156	14	0	146	791	
23時		74	0	8	79	43	0	0	43	77	7	0	76	410	
24時		54	0	5	58	32	0	0	32	56	5	0	56	300	

表 40-3(4) 地域社会 9 の大型車混入率

	時間	大型車混入率												計	
		A→B	A→C	A→D	B→A	B→C	B→D	C→A	C→B	C→D	D→A	D→B	D→C		
平日	7時	0.12	-	0.13	0.10	0.02	-	-	0.03	0.38	0.06	-	0.38	0.19	
	8時	0.12	-	0.12	0.09	0.02	-	-	0.03	0.30	0.05	-	0.37	0.16	
	9時	0.11	-	0.12	0.10	0.02	-	-	0.03	0.29	0.05	-	0.33	0.19	
	10時	0.11	-	0.11	0.10	0.02	-	-	0.03	0.28	0.06	-	0.28	0.19	
	11時	0.11	-	0.11	0.10	0.02	-	-	0.03	0.30	0.07	-	0.33	0.19	
	12時	0.11	-	0.10	0.10	0.02	-	-	0.03	0.28	0.08	-	0.28	0.19	
	13時	0.11	-	0.11	0.10	0.02	-	-	0.03	0.38	0.08	-	0.38	0.19	
	14時	0.10	-	0.10	0.10	0.02	-	-	0.03	0.28	0.09	-	0.28	0.19	
	15時	0.10	-	0.09	0.11	0.02	-	-	0.03	0.38	0.09	-	0.38	0.19	
	16時	0.10	-	0.09	0.11	0.02	-	-	0.03	0.38	0.10	-	0.37	0.19	
	17時	0.10	-	0.09	0.11	0.02	-	-	0.03	0.38	0.10	-	0.38	0.19	
	18時	0.10	-	0.09	0.11	0.02	-	-	0.03	0.38	0.11	-	0.38	0.19	
	19時	0.10	-	0.09	0.11	0.02	-	-	0.03	0.38	0.11	-	0.38	0.19	
	20時	0.10	-	0.08	0.11	0.02	-	-	0.03	0.27	0.10	-	0.28	0.19	
	21時	0.10	-	0.08	0.11	0.02	-	-	0.03	0.36	0.10	-	0.28	0.19	
	22時	0.10	-	0.05	0.11	0.02	-	-	0.03	0.35	0.09	-	0.28	0.16	
	23時	0.10	-	0.08	0.11	0.02	-	-	0.03	0.27	0.09	-	0.28	0.19	
	24時	0.11	-	0.09	0.11	0.02	-	-	0.03	0.38	0.09	-	0.28	0.19	
	休日	7時	0.12	-	0.10	0.07	0.02	-	-	0.03	0.38	0.02	-	0.37	0.17
		8時	0.11	-	0.09	0.07	0.02	-	-	0.03	0.28	0.02	-	0.27	0.17
		9時	0.11	-	0.10	0.08	0.02	-	-	0.03	0.36	0.02	-	0.37	0.17
		10時	0.11	-	0.10	0.09	0.02	-	-	0.03	0.30	0.05	-	0.28	0.16
		11時	0.10	-	0.10	0.09	0.02	-	-	0.03	0.38	0.06	-	0.38	0.16
		12時	0.10	-	0.09	0.10	0.02	-	-	0.03	0.29	0.07	-	0.28	0.16
13時		0.10	-	0.10	0.10	0.02	-	-	0.03	0.30	0.07	-	0.38	0.16	
14時		0.09	-	0.09	0.10	0.02	-	-	0.03	0.38	0.08	-	0.28	0.16	
15時		0.09	-	0.08	0.10	0.02	-	-	0.03	0.38	0.08	-	0.28	0.16	
16時		0.09	-	0.08	0.10	0.02	-	-	0.03	0.38	0.09	-	0.28	0.16	
17時		0.09	-	0.07	0.10	0.02	-	-	0.03	0.37	0.08	-	0.28	0.16	
18時		0.09	-	0.07	0.10	0.02	-	-	0.03	0.37	0.09	-	0.28	0.16	
19時		0.10	-	0.07	0.10	0.02	-	-	0.03	0.36	0.08	-	0.28	0.16	
20時		0.09	-	0.05	0.11	0.02	-	-	0.03	0.35	0.09	-	0.28	0.16	
21時		0.10	-	0.04	0.11	0.02	-	-	0.03	0.33	0.08	-	0.28	0.16	
22時		0.10	-	0.05	0.11	0.02	-	-	0.03	0.34	0.08	-	0.28	0.16	
23時		0.11	-	0.08	0.11	0.02	-	-	0.03	0.37	0.09	-	0.28	0.19	
24時		0.11	-	0.09	0.11	0.02	-	-	0.03	0.38	0.09	-	0.28	0.19	

41. モニタリングについて（継続）

前回審査会の補足資料 26 のうち、「④水質－水の汚れ」、「⑤地下水の水質」を以下のとおり修正します。

④ 水質－水の汚れ（準備書 P. 9. 4-30（表 9. 4-21）に示す事後調査の項目）

a 仮設調整池出口及び放流先河川

各仮設調整池の出口及び放流先河川（水の濁りの調査と同じ場所）において、年間 4 回の調査を行います。（図 6-1 参照）

なお、水の汚れ（健康項目及びダイオキシン類に限る。）について、万一、環境基準値を超過するような結果となった場合は、当該河川において底質の調査も行います。

注： 準備書の現地調査や横浜市で行われている中小河川の調査が豊水期 1 回、渇水期 1 回の年間 2 回程度となっていますが、水質等の調査を年間 4 回とした理由は、工事工程の変化を把握できる調査とし、かつ、四季の各季 1 回程度調査を行うのが妥当と判断したためです。なお、調整池排出口での濁度は連続観測の予定です。

また、準備書 P. 9. 4-30（表 9. 4-21）を以下のとおり修正します。関連する準備書 P. 11-2（表 11-1(1)）の「水質－水の汚れ」の「事後調査の項目」欄も同様に修正します。

表 9. 4-21 事後調査の項目等（水の汚れ）

環境影響評価項目			事後調査の 時期及び頻度	事後調査を行うこ ととした理由	事後調査の項目	事後調査の手法
環境要素	影響要因					
水 環 境	水 質 － 水 の 汚 れ	雨水の排水	工事中、工事の完了後における適切な時期・頻度とします。	予測結果に不確実性を伴うため。	「水質汚濁に係る環境基準について」別表 1 に掲げる 27 項目及び同別表 2 の 1（1）河川（湖沼を除く。）に掲げる 8 項目、電気伝導率等、並びにダイオキシン類	現地調査による確認。

⑤ 地下水の水質

地下水の水質については、対象事業実施区域内及びその周辺の帯水層が南方向に傾いており、地下水の流れも北から南に向かうと推察されることから、対象事業実施区域の南端部に接する箇所のうち、GL-8, 9m で鉛の土壤溶出量が指定基準を超過した地点近傍及びその南側で地下水の利用がある場所として、図 2 に示す 2 ヶ所においてモニタリングを行います。その際、鉛等の比重の特性を踏まえて、複数の深度の帯水層にて採水を行います。調査頻度は「地下水質モニタリングの手引き」（環境省、平成 20 年 8 月）では、継続監視調査の場合は年 1 回以上とされていますが、水質（水の汚れ）の調査と同様な理由で年 4 回とし、汚染がみられない場合は、竣工 1 年後までで調査を終了します。なお、参考として地下水位についてもこの間、継続的に観測します。

旧上瀬谷通信施設地区土地区画整理事業 環境影響評価に関する補足資料

<補足資料内容>

- 42. 工事中車両運行に伴う地域社会への影響低減について（継続）
- 43. 地点No.7における将来交通量の内訳について
- 44. 瀬谷地内線における交差点需要率について（継続）
- 45. 防衛省による土壤汚染調査結果について

令和3年10月

横浜市

42. 工事用車両の運行に伴う地域社会への影響低減について（継続）

前回の審査会では、運行ルート分散による地域社会（交差点需要率）への影響低減について検討（下記、検討A～検討C）を行い、予測評価について説明を行いました。今回は、更に運行時間の分散（下記、検討D）を追加して、検討を行いました。

(1) 影響を低減させるための検討内容

準備書で想定した工事用車両の運行では、目黒交番前交差点に工事用車両が集中していたため、以下のとおり工事用車両の運行について分散の検討を行いました。

なお、検討は平日で行いましたが、評価書では平日と休日の両方で再予測計算を行い、その予測結果を掲載します。

検討A：運行ルートの検討

対象事業実施区域北東側の八王子街道に面している所において、左折 in、左折 out が可能な工事用車両専用の出入口を設けます。

検討B：運行ルートの検討

西側方面への発生的小型車を、目黒交番前交差点を通過することを避けて旧海軍道路へ分散します。なお、西側方面へは通勤用車両の走行しか想定していないため、本分散ルートを走行する工事用車両は、17 時台、18 時台となります。

検討C：運行ルートの検討

目黒交番前交差点は負荷をかけないように、海軍道路を南北に直進するルートをメインとします。

検討D：運行時間（退勤時間）の検討

退勤車両は17時台の1時間と設定していましたが、この時間帯の交通量が最も多い（17時台が予測対象時間）ため、退勤車両を17時台と18時台に2等分します。なお、通勤車両を2等分することで、交通量が最も多くなる時間帯（予測対象時間）が、出勤時である7時台となる可能性がありますので、再予測計算は7時台、17時台、18時台で行いました。

検討A～検討Cの工事用車両の運行ルートは図42-1～4に示すとおりです。

図42-1は、通勤用の工事用車両が対象事業実施区域へ集中するルートです。対象時間は7時台となります。

図42-2は、運搬用の工事用車両が対象事業実施区域から外へ発生するルートです。対象時間は、8時台～16時台です。

図42-3は、運搬用の工事用車両が対象事業実施区域へ集中するルートです。対象時間は、8時台～16時台です。

図42-4は、通勤用の工事用車両が対象事業実施区域から外へ発生するルートです。対象時間は17時台と18時台になります。



図 42-1 工事用車両（通勤車両）の運行ルート（集中）



図 42-2 工事用車両（運搬車両）の運行ルート（発生）

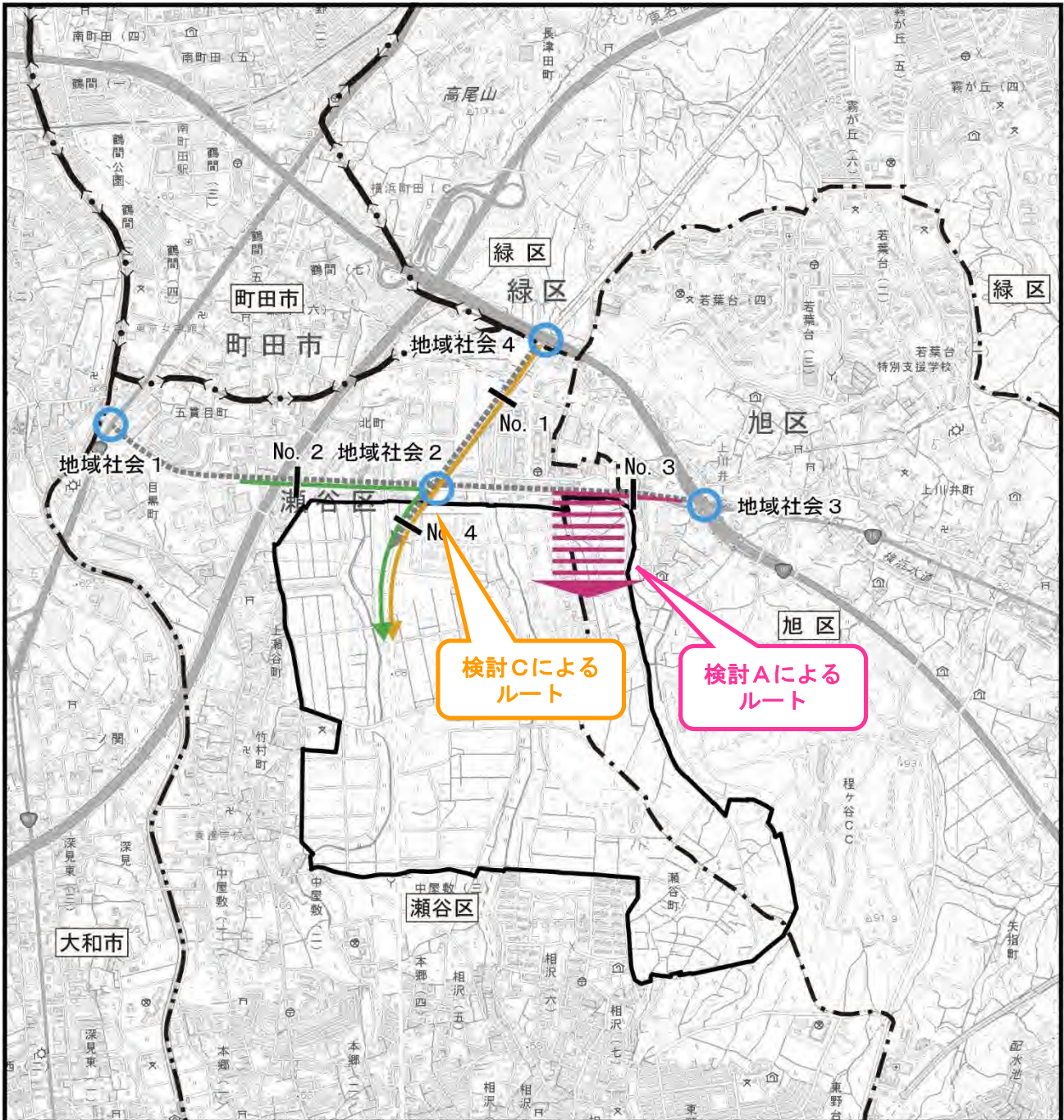

図 42-3 工事用車両（運搬車両）の運行ルート（集中）

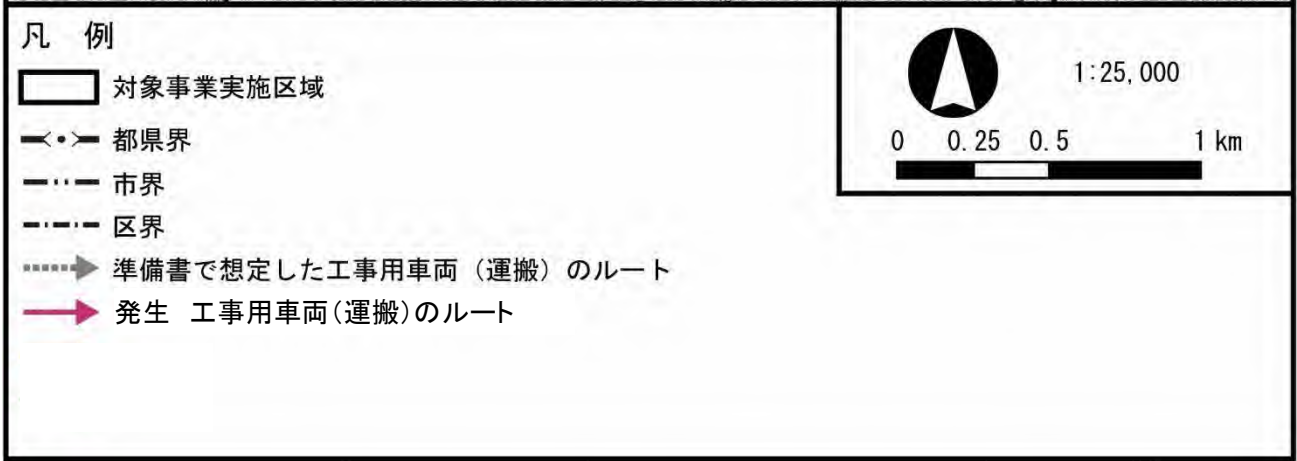
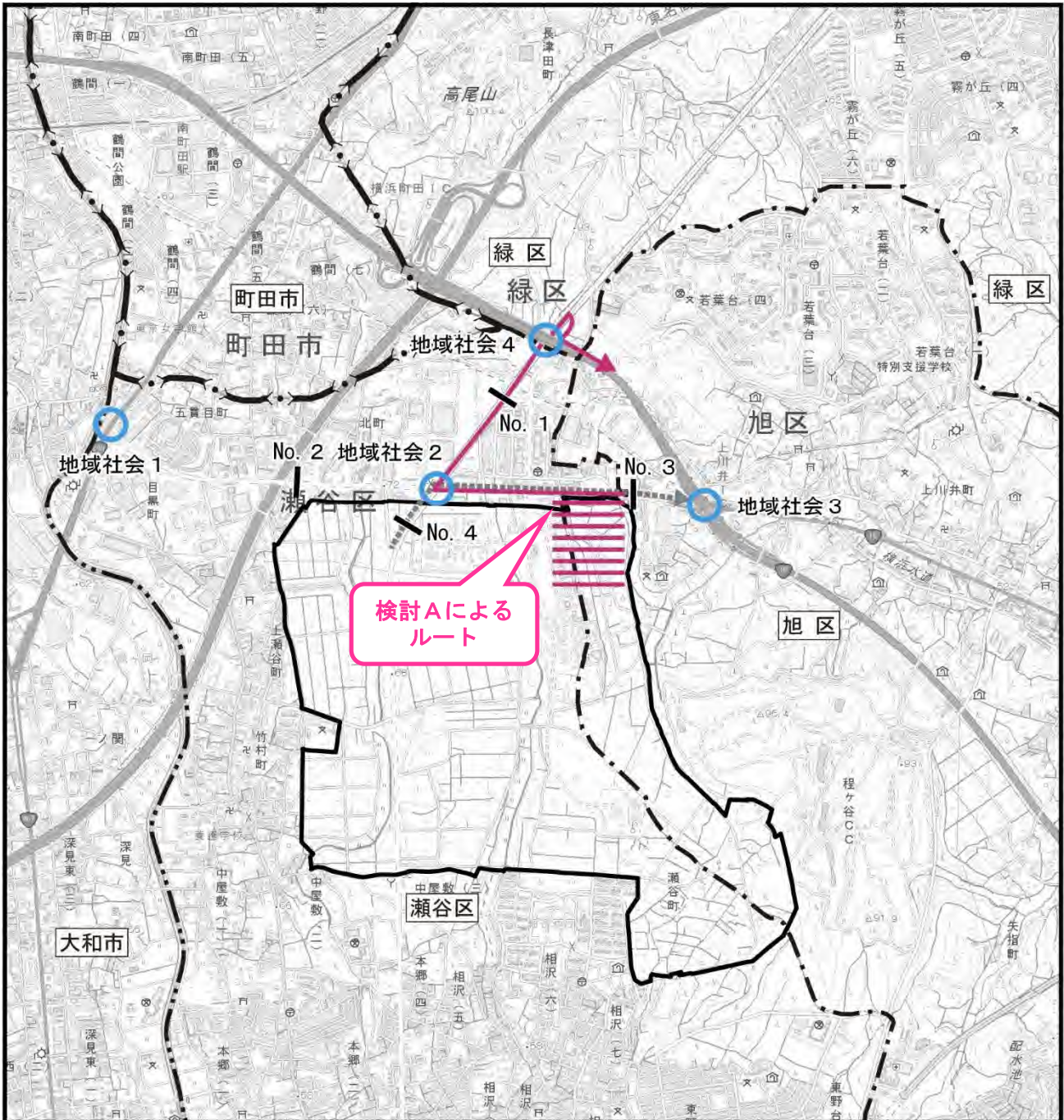

図 42-4 工事用車両（通勤車両）の運行ルート（発生）

(2) 検討後の地域社会（交通混雑）の予測評価

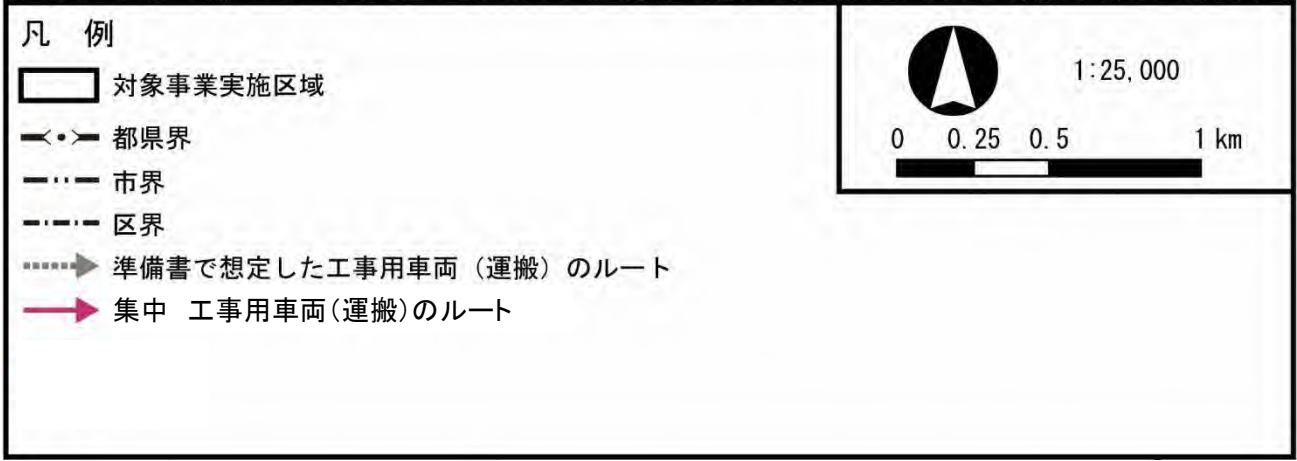
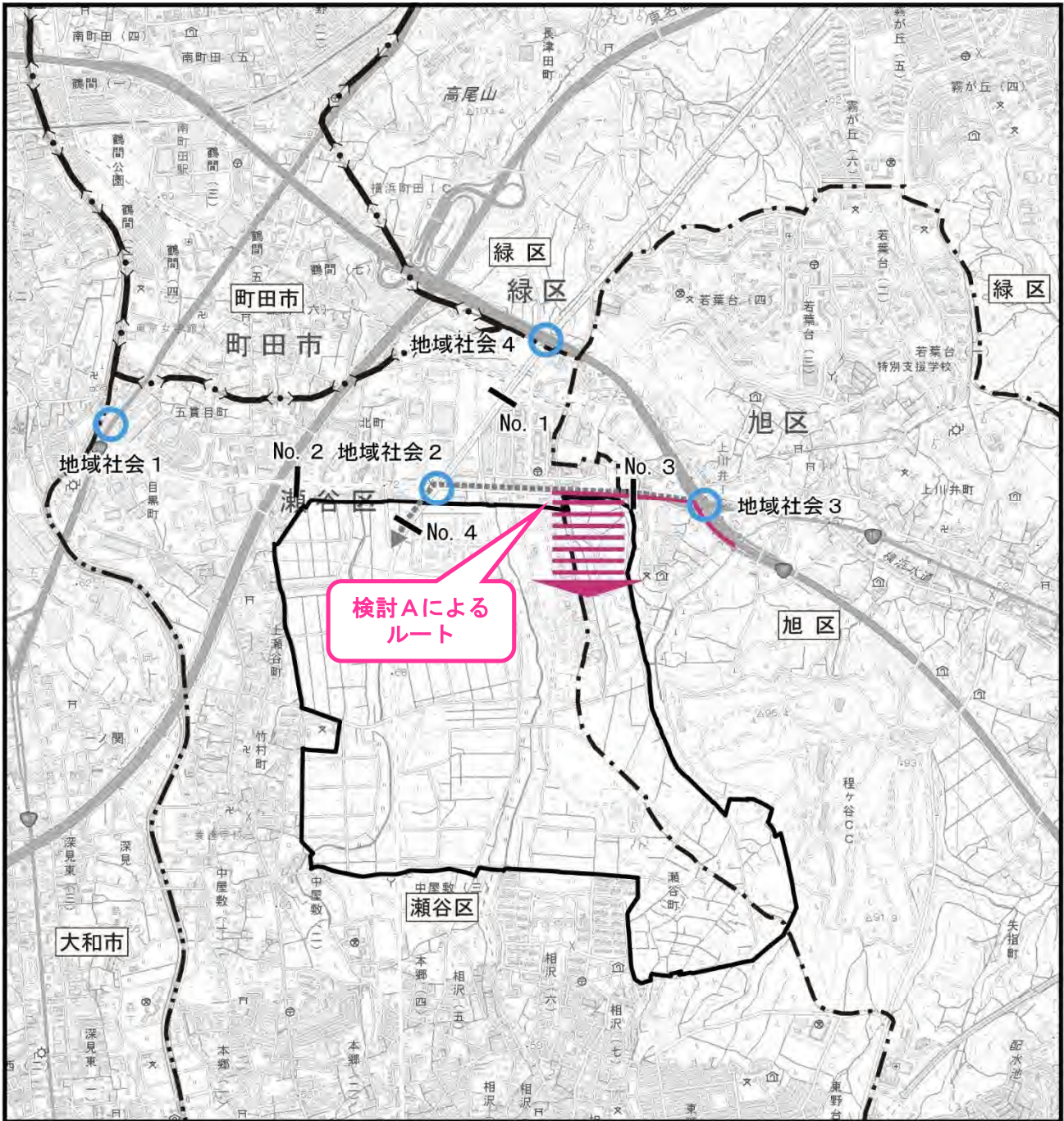
① 交差点需要率

準備書に記載した予測に用いた工事用車両の台数と、検討後の工事用車両の台数を表 42-1 に示します。

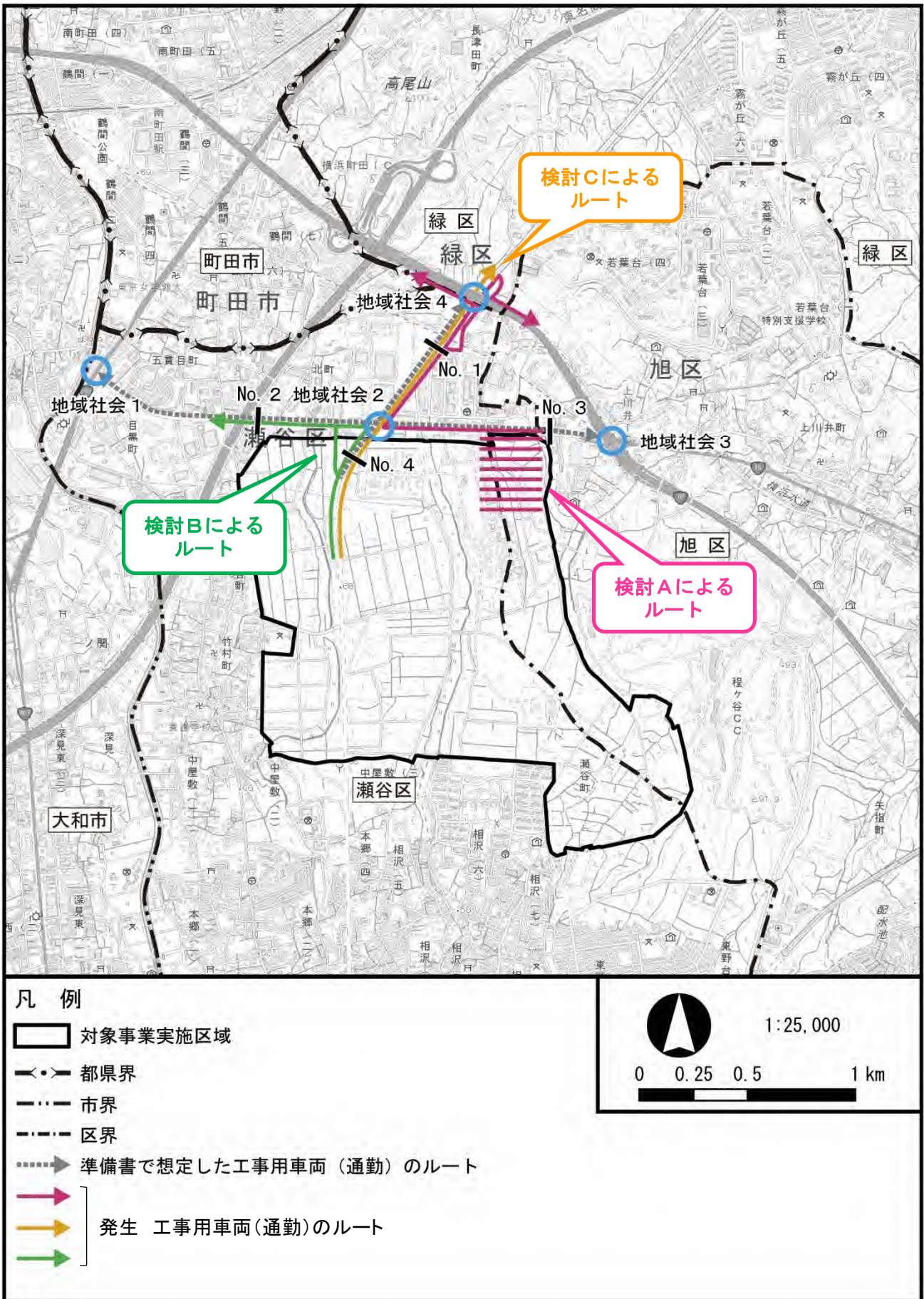
交差点需要率の予測対象時間は、予測する交差点へ流入する現況の交通量と工事用車両の合計台数が最も多い時間とします。準備書の時は、地域社会 1 から地域社会 4 の全ての交差点で 17 時台でしたが、今回は検討 D を行うことによって、地域社会 1（目黒）は 7 時台、地域社会 4（滝沢）は 18 時台、地域社会 4（瀬谷土橋公園入口）は 7 時台に予測対象時間が変わりました。

地域社会 1 から地域社会 4 までの交差点需要率の予測結果を表 42-2 に示します。なお、前述のとおり、現況、準備書、ケース 1 の予測対象時間は 17 時台、ケース 2 の予測対象時間は、各交差点への流入交通量が最も多くなる時間となっています。

ケース 2 での各交差点の交差点需要率の予測結果は、地域社会 1（目黒交差点）は 0.806（7 時台）、準備書及びケース 1 の時には限界需要率を超えていた地域社会 2（目黒交番前交差点）は 0.856（17 時台）、地域社会 3（上川井 IC 交差点）は 0.715（17 時台）、地域社会 4（滝沢交差点）は 0.490（18 時台）、地域社会 4（瀬谷土橋公園入口交差点）は 0.601（7 時台）となり、いずれの交差点も限界需要率は超えませんでした。

表 42-1 準備書及び検討後の予測に用いた工事用車両の台数

予測地点	検討時間	準備書 ^{※1}			ケース1 ^{※2}			ケース2 ^{※3}		
		方向	1時間あたり		方向	1時間あたり		方向	1時間あたり	
			大型車	小型車		大型車	小型車		大型車	小型車
地域社会1 (目黒)	7時台	A→C	31台	43台	A→C	31台	43台	A→C	31台	43台
		B→C	31台	43台	B→C	31台	43台	B→C	31台	43台
		D→C	31台	43台	D→C	31台	43台	D→C	31台	43台
	17時台	C→A	31台	43台	C→A	31台	43台	C→A	16台	22台
		C→B	31台	43台	C→B	31台	43台	C→B	15台	21台
		C→D	31台	43台	C→D	31台	43台	C→D	16台	22台
	18時台	C→A	0台	0台	C→A	0台	0台	C→A	15台	21台
		C→B	0台	0台	C→B	0台	0台	C→B	16台	22台
		C→D	0台	0台	C→D	0台	0台	C→D	15台	21台
地域社会2 (目黒交番前)	7時台	A→C	93台	129台	A→C	93台	129台	A→C	93台	129台
		B→C	93台	129台	B→C	93台	129台	B→C	93台	129台
		D→C	94台	129台	D→C	0台	0台	D→C	0台	0台
	17時台	C→A	93台	129台	C→A	93台	129台	C→A	47台	65台
		C→B	93台	129台	C→B	93台	0台	C→B	47台	0台
		C→D	94台	129台	C→D	0台	0台	C→D	0台	0台
	18時台	D→A	0台	0台	D→A	94台	129台	D→A	47台	65台
		C→A	0台	0台	C→A	0台	0台	C→A	46台	64台
		C→B	0台	0台	C→B	0台	0台	C→B	46台	0台
	18時台	C→D	0台	0台	C→D	0台	0台	C→D	0台	0台
		D→A	0台	0台	D→A	0台	0台	D→A	47台	64台
		C→A	0台	0台	C→A	0台	0台	C→A	46台	64台
C→B		0台	0台	C→B	0台	0台	C→B	46台	0台	
地域社会3 (上川井 IC)	7時台	A→B	31台	43台	A→B	31台	43台	A→B	31台	43台
		C→B	32台	43台	C→B	32台	43台	C→B	32台	43台
		D→B	31台	43台	D→B	31台	43台	D→B	31台	43台
	17時台	B→A	31台	43台	B→A	0台	0台	B→A	0台	0台
		B→C	32台	43台	B→C	0台	0台	B→C	0台	0台
		B→D	31台	43台	B→D	0台	0台	B→D	0台	0台
	18時台	A→D	0台	0台	A→D	31台	43台	A→D	16台	22台
		B→A	0台	0台	B→A	0台	0台	B→A	0台	0台
		B→C	0台	0台	B→C	0台	0台	B→C	0台	0台
		B→D	0台	0台	B→D	0台	0台	B→D	0台	0台
	18時台	A→D	0台	0台	A→D	0台	0台	A→D	15台	21台
		B→A	0台	0台	B→A	0台	0台	B→A	0台	0台
B→C		0台	0台	B→C	0台	0台	B→C	0台	0台	
B→D		0台	0台	B→D	0台	0台	B→D	0台	0台	
地域社会4 (滝沢)	7時台	A→B	93台	129台	A→B	93台	129台	A→B	93台	129台
	17時台	B→A	93台	129台	B→A	93台	129台	B→A	47台	65台
		B→C	0台	0台	B→C	63台	86台	B→C	31台	43台
	18時台	B→A	0台	0台	B→A	0台	0台	B→A	46台	64台
		B→C	0台	0台	B→C	0台	0台	B→C	32台	43台
地域社会4 (瀬谷土橋公園入口)	7時台	A→B	93台	129台	A→B	93台	129台	A→B	93台	129台
	17時台	B→A	93台	129台	B→A	156台	215台	B→A	78台	108台
		B→C	0台	0台	B→C	31台	43台	B→C	16台	22台
	18時台	B→A	0台	0台	B→A	0台	0台	B→A	78台	107台
		B→C	0台	0台	B→C	0台	0台	B→C	15台	21台

注：1. 検討時間の網掛けは、ケース2により、交差点への流入交通量が最も多くなる時間を示します。(=予測対象時間)

2. 準備書、ケース1、ケース2の網掛けは、準備書の時と比べて工事用車両の台数が変わったことを示します。

3. 「方向」は、後掲図42-5と対応しています。

※1：「準備書」は、準備書の時に設定した工事用車両の台数を示します。

※2：「ケース1」は、前述の検討A～検討Cを行い、予測計算に用いた台数を示します。

※3：「ケース2」は、前述の検討A～検討Dを行い、予測計算に用いた台数を示します。

表 42-2 準備書及び検討後の交差点需要率の予測結果

交差点名		交差点需要率（平日）				限界 需要率
		現況	準備書※1	ケース 1 ※2	ケース 2 ※3	
地域社会 1	目黒	0.633	0.686 (17 時台)	0.686 (17 時台)	0.806 (7 時台)	0.889 (17 時台)
						0.894 (7 時台)
地域社会 2	目黒交番前	0.793	1.114 (17 時台)	0.929 (17 時台)	0.856 (17 時台)	0.900 (17 時台)
地域社会 3	上川井 IC	0.680	0.807 (17 時台)	0.763 (17 時台)	0.715 (17 時台)	0.847 (17 時台)
地域社会 4	滝沢	0.457	0.532 (17 時台)	0.532 (17 時台)	0.490 (18 時台)	0.904 (17 時台)
						0.878 (18 時台)
	瀬谷土橋 公園入口	0.502	0.513 (17 時台)	0.591 (17 時台)	0.601 (7 時台)	0.913 (17 時台)
						0.909 (7 時台)

注：1. 網掛けは、限界需要率を上回ったことを示します。

2. () 内の時間は、予測対象時間を示します。

※1：「準備書」は、準備書に記載された交差点需要率を示します。

※2：「ケース 1」は、前述の検討 A～検討 C までで予測計算を行った結果を示します。

※3：「ケース 2」は、前述の検討 A～検討 D までで予測計算を行った結果を示します。

なお、地域社会 1 から地域社会 4 の交差点の中で、交差点需要率が最も大きい“目黒交番前交差点”において、工事用車両が運行される 7 時から 18 時までの 1 時間ごとの交差点需要率を予測計算したところ、表 42-3 に示すとおり、全ての時間で交差点需要率は限界需要率よりも下回る値となりました。

表 42-3 目黒交番前交差点における交差点需要率と限界需要率

時間	交差点需要率 ^{※1}	限界需要率 ^{※2}
7 時台	0.813	0.900
8 時台	0.736	0.900
9 時台	0.752	0.900
10 時台	0.772	0.900
11 時台	0.734	0.900
12 時台	0.696	0.900
13 時台	0.735	0.892
14 時台	0.737	0.892
15 時台	0.693	0.892
16 時台	0.770	0.900
17 時台	0.856	0.900
18 時台	0.796	0.900

※1：交差点の混雑の程度を評価する指標です。対象の交差点の車線ごとに 1 時間で通せる最大交通量を計算し、全部の車線での交通量を足し合わせた全体最大交通量を 1 とした時に、交差点に進入する交通量の割合を言います。よって、1 に近いほど交通量が多い交差点といえます。

※2：対象の交差点が 1 時間に通せる全体最大交通量を 1 とした時に、捌ききれぬ最大の交通量の割合を言います。信号交差点の場合、青信号から赤信号に切り替わる時に黄色信号や全赤信号があり、どの方向からも自動車が進められない時間があるので 1 にはなりません。

なお、限界需要率よりも交差点需要率の方が大きい数値になると、その時の交差点では捌け残りが発生します。

② 車線の交通容量比

準備書と分散後の車線の交通容量比を表 42-4 に示します。なお、車線の交通容量比を予測計算した時間は、交差点需要率の時間と同じとしました。

検討Aから検討Dまでを行うことにより、車線の交通容量比は小さくなり改善がみられます。特に目黒交番前交差点のC断面の右折車線は、準備書の時には2.631であったのが検討Aから検討Dを行うことによって0.737へと1.0を下回る改善が見られました。

一方、地域社会1（目黒交差点）、地域社会2（目黒交番前交差点）では、一部の車線において車線の交通容量比が1.0を上回る予測結果となりました。

これらについては、準備書に記載した環境保全措置を実施することで、影響を低減していきます。

表 42-4(1) 準備書及び検討後の車線の交通容量比の予測結果

交差点名		断面※1	流入車線構成	車線の交通容量比（平日）					
				現況	準備書※2	ケース1※3	ケース2※4		
地域社会 1	目黒	A	左折・直進	0.889	0.889 (17 時台)	0.889 (17 時台)	1.111 (7 時台)		
			右折	0.245	0.343 (17 時台)	0.343 (17 時台)	0.335 (7 時台)		
		B	左折・直進	0.533	0.533 (17 時台)	0.533 (17 時台)	0.540 (7 時台)		
			右折	0.766	0.766 (17 時台)	0.766 (17 時台)	1.013 (7 時台)		
		C	左折	0.773	0.952 (17 時台)	0.952 (17 時台)	0.783 (7 時台)		
			直進	0.855	1.017 (17 時台)	1.017 (17 時台)	0.950 (7 時台)		
			右折	0.257	0.460 (17 時台)	0.460 (17 時台)	0.375 (7 時台)		
		D	左折・直進	0.495	0.495 (17 時台)	0.495 (17 時台)	0.675 (7 時台)		
			右折	0.701	0.701 (17 時台)	0.701 (17 時台)	0.547 (7 時台)		
		地域社会 2	目黒 交番前	A	左折・直進	0.603	0.603 (17 時台)	0.603 (17 時台)	0.603 (17 時台)
					直進	0.603	0.603 (17 時台)	0.603 (17 時台)	0.603 (17 時台)
					右折	1.116	1.116 (17 時台)	1.116 (17 時台)	1.116 (17 時台)
B	左折			0.279	0.279 (17 時台)	0.279 (17 時台)	0.279 (17 時台)		
	直進			0.815	0.815 (17 時台)	0.815 (17 時台)	0.815 (17 時台)		
	右折			0.287	0.287 (17 時台)	0.287 (17 時台)	0.287 (17 時台)		
C	左折・直進			0.524	1.735 (17 時台)	1.427 (17 時台)	0.981 (17 時台)		
	直進			0.524	1.735 (17 時台)	1.427 (17 時台)	0.981 (17 時台)		
	右折			0.737	2.631 (17 時台)	0.737 (17 時台)	0.737 (17 時台)		
D	左折・直進			0.984	0.984 (17 時台)	0.984 (17 時台)	0.984 (17 時台)		
	右折			0.031	0.031 (17 時台)	0.759 (17 時台)	0.396 (17 時台)		

注：1. 網掛けは、交通容量比が 1.0 を上回ったことを示します。

2. () 内の時間は、予測対象時間を示します。

※1：「断面」は、図 42-5 と対応しています。

※2：「準備書」は、準備書に記載された交通容量比を示します。

※3：「ケース1」は、前述の検討A～検討Cを行い、予測計算を行った結果を示します。

※4：「ケース2」は、前述の検討A～検討Dを行い、予測計算を行った結果を示します。

表 42-4(2) 準備書及び検討後の車線の交通容量比の予測結果

交差点名		断面※1	流入車線構成	車線の交通容量比（平日）					
				現況	準備書※2	ケース1※3	ケース2※4		
地域社会3	上川井 IC	A	左折・右折	0.748	0.748 (17時台)	1.154 (17時台)	0.959 (17時台)		
			直進	0.865	1.122 (17時台)	0.865 (17時台)	0.865 (17時台)		
		B	右折	0.786	0.932 (17時台)	0.819 (17時台)	0.786 (17時台)		
			C	右折	0.609	0.609 (17時台)	0.609 (17時台)	0.609 (17時台)	
		D	直進	0.626	0.626 (17時台)	0.626 (17時台)	0.626 (17時台)		
			右折	0.319	0.319 (17時台)	0.319 (17時台)	0.319 (17時台)		
		地域社会4	滝沢	A	左折・直進	0.453	0.453 (17時台)	0.453 (17時台)	0.506 (18時台)
					直進	0.453	0.453 (17時台)	0.453 (17時台)	0.506 (18時台)
B	直進			0.403	0.559 (17時台)	0.559 (17時台)	0.498 (18時台)		
	右折			0.056	0.056 (17時台)	0.378 (17時台)	0.213 (18時台)		
C	左折・右折			0.639	0.639 (17時台)	0.639 (17時台)	0.632 (18時台)		
	右折			0.631	0.631 (17時台)	0.631 (17時台)	0.652 (18時台)		
瀬谷土橋公園入口	A			左折・直進	0.636	0.636 (17時台)	0.636 (17時台)	0.724 (7時台)	
				直進	0.636	0.636 (17時台)	0.636 (17時台)	0.724 (7時台)	
	B		直進	0.300	0.490 (17時台)	0.618 (17時台)	0.357 (7時台)		
			右折	0.389	0.389 (17時台)	1.008 (17時台)	0.599 (7時台)		
	C		左折	0.274	0.274 (17時台)	0.274 (17時台)	0.176 (7時台)		
			右折	0.568	0.568 (17時台)	0.568 (17時台)	0.691 (7時台)		

注：1. 網掛けは、交通容量比が1.0を上回ったことを示します。

2. () 内の時間は、予測対象時間を示します。

※1：「断面」は、図42-5と対応しています。

※2：「準備書」は、準備書に記載された交通容量比を示します。

※3：「ケース1」は、前述の検討A～検討Cを行い、予測計算を行った結果を示します。

※4：「ケース2」は、前述の検討A～検討Dを行い、予測計算を行った結果を示します。



図 42-5 交差点の断面の位置

(3) モニタリングについて

第3回審査会（8月31日開催）にて補足資料26にて説明させていただいたように、工事用車両に係る交通混雑の予測を行った4交差点（図42-1～図42-4の地域社会1～地域社会4）において、車両の運行台数がピークとなる時期（平日及び土曜日）に調査を行うことにより、モニタリングを行います。併せて、工事用車両、一般車両の車種別台数についても調査を行います。また、渋滞等の状況についてもその有無や滞留長、渋滞長について観測します。

43. 地点No.7における将来交通量の内訳について

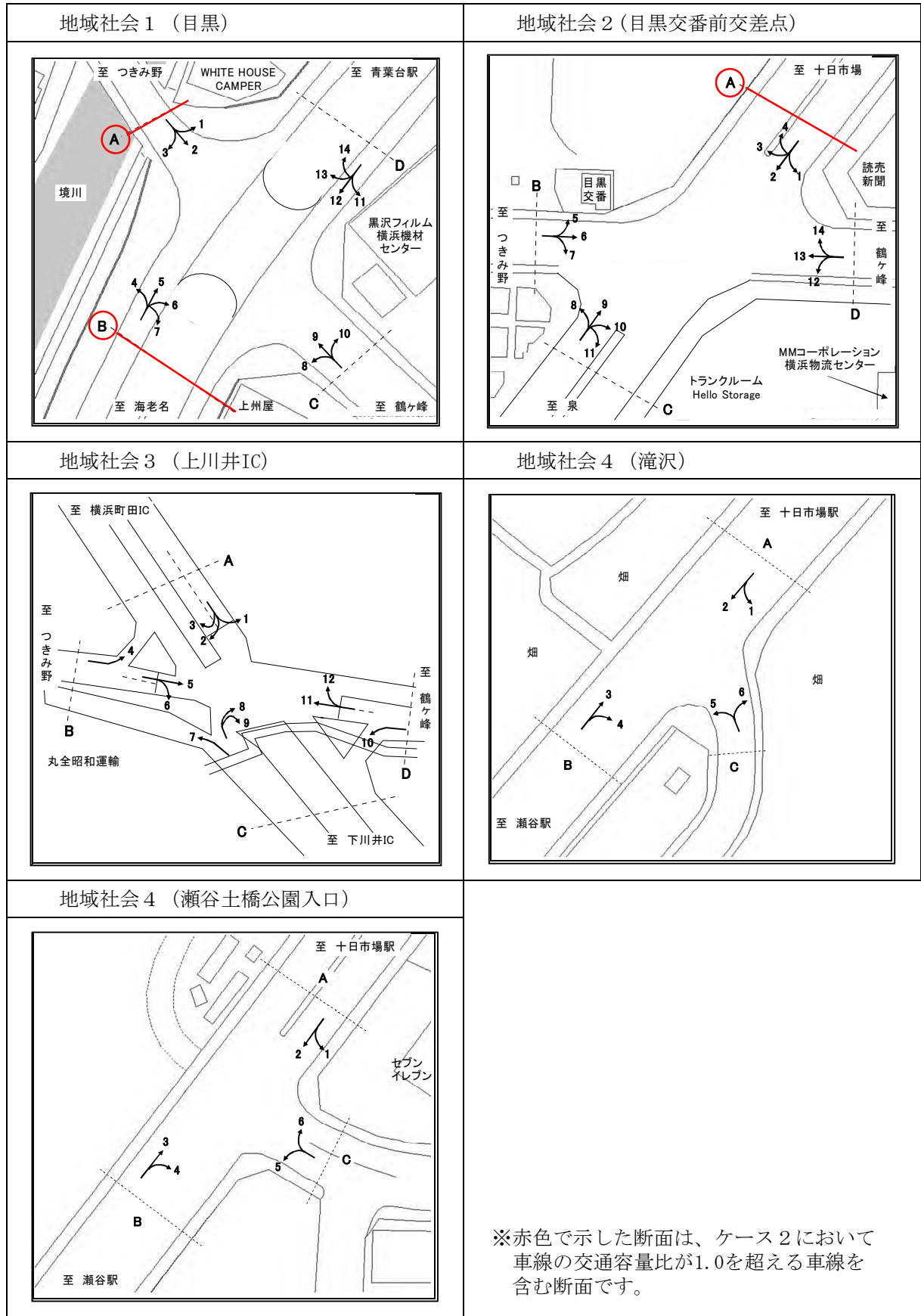
対象事業実施区域南東側の瀬谷地内線上の No. 7 の断面における将来交通量の内訳について、「①観光・賑わい地区」、「②物流地区」、「③公益的施設用地（公園・防災等用地）」の開発事業と開発事業にはよらない「④一般」の4種類に分けたものを、表 43-1、図 43-1 に示します。

昼間、夜間とは、騒音の環境基準の時間帯に合わせて、昼間は6時から22時まで、夜間は22時から翌朝6時までとしています。

昼間、夜間の北行き、南行きともに「④一般」の交通量が多くを占めているため、「④一般」のみが走行した場合の騒音を予測した結果、昼間は、西側 64.5dB、東側 64.1dB、夜間は、西側 56.8dB、東側 57.0dB となり、いずれも環境基準（昼間 60dB 以下、夜間 55dB 以下）を超える予測結果となりました。（表 43-2 参照）

一般の走行車による影響については、本区画整理事業に関する影響ではありますが、本区画整理事業では対応が困難なところもありますので、横浜市として対応していきます。今回の予測結果については、関係部局に引き継いでいくとともに、供用時におけるモニタリングの実施を検討していきます。

なお、区画整理事業の事業者としては、開発事業者に対して、「公共交通機関の利用促進」、「車両の効率的な利用促進」を促し、騒音の低減に努めていきます。

表 43-1(1) No.7 を通過する自動車交通量（昼間）

内訳	北行き（台）		南行き（台）	
	小型車	大型車	小型車	大型車
①観光・賑わい地区	143	0	372	0
②物流地区	253	170	31	0
③公益的施設用地	408	0	0	0
④一般	3,303	543	2,788	516
合計	4,107	713	3,191	516

表 43-1(2) No.7 を通過する自動車交通量（夜間）

内訳	北行き（台）		南行き（台）	
	小型車	大型車	小型車	大型車
①観光・賑わい地区	7	0	80	0
②物流地区	10	20	4	0
③公益的施設用地	0	0	0	0
④一般	205	17	221	28
合計	222	37	305	28



図 43-1(1) No. 7 を通過する自動車交通量（昼間）



図 43-1(2) No. 7 を通過する自動車交通量（夜間）

表 43-2 No. 7 における予測結果と環境基準

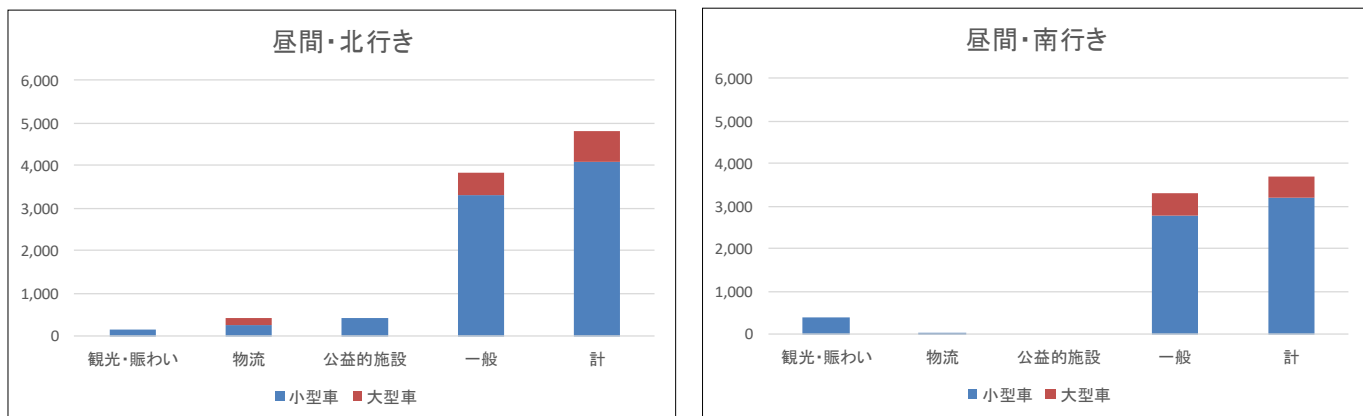
単位：dB

予測 時間帯	方向	予測結果		環境基準	
		将来交通量 ^{※1}	④一般 ^{※2}	環境基準	地域累計
昼間	西側	65.4 (×)	64.5 (×)	60 以下	A (道路)
	東側	64.7 (×)	64.1 (×)		
夜間	西側	58.1 (×)	56.8 (×)	55 以下	
	東側	58.0 (×)	57.0 (×)		

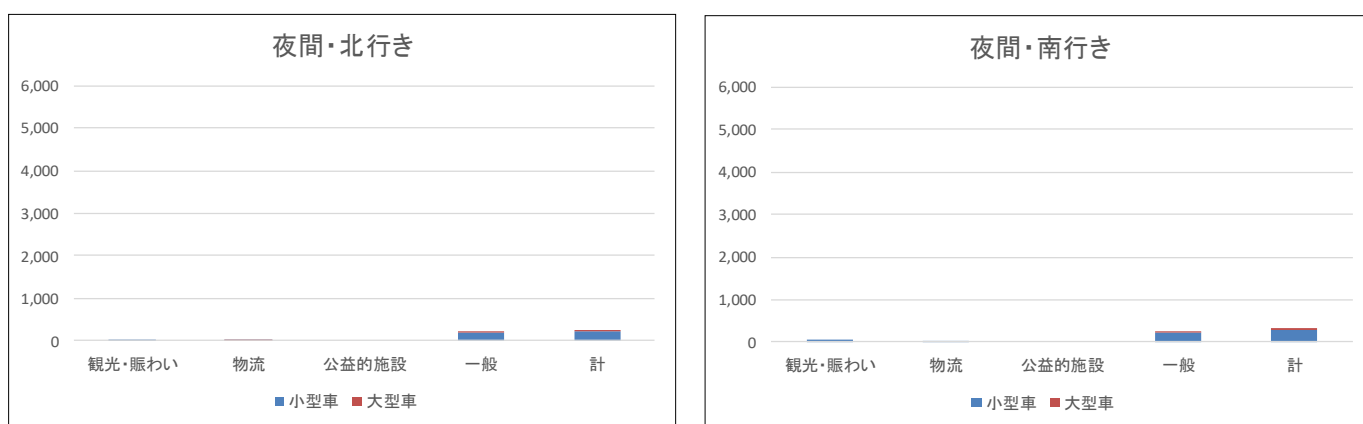
注：×印は、環境基準を上回ることを示します。

※1：開発事業（前述①～③）と一般（前述④）の合計台数による予測結果で、準備書に記載した数値です。

※2：一般（前述④）の車両だけによる予測結果です。

44. 瀬谷地内線における交差点需要率について（継続）

前回の審査会で提示した地域社会8、9の交差点需要率及び方向別交通量の表について、方向の表記方法が統一されていないため、下記の通り統一しました。



図 44-1 新設される2つの交差点の位置

表 44-1(1) 地域社会8の交差点需要率(平日:8時台)

流入部	A		B	C		
	直進	右折	左折・直進	左折	右折	
車線の種類	1	1	1	1	1	
車線数	1	1	1	1	1	
飽和交通流率の基本値 S B	2000	1800	2000	1800	1800	
車線幅員による補正率 (車線幅員)	α_w m	1.000 (3.25)	1.000 (3.00)	1.000 (3.25)	1.000 (3.00)	
縦断勾配による補正率 (縦断勾配)	α_G %	1.000 (0.00)	1.000 (0.00)	1.000 (0.00)	1.000 (0.00)	
大型車混入による補正率 (大型車混入率)	α_T %	0.840 (27.27)	0.598 (96.00)	1.000 (0.00)	1.000 (0.00)	
左折車混入による補正率 (左折率)	α_{LT} L %		1.000 (0.0)			
(歩行者による低減率)	f p		0.50	0.50		
(有効青時間)	秒		52	30		
(歩行者用青時間)	秒		47	25		
横断歩行者による補正率	α_L			0.583		
右折車混入による補正率 (右折率)	α_{RT} R %					
(右折車の通過確率)	f		0.899			
(有効青時間)	秒		52			
(現示変り目のさげ台数増分)			2(80)			
KER:台/サイクル (交差点内滞留台数)						
K:台/サイクル						
飽和交通流率 S A	1680	*616	2000	1049	1800	
設計交通量 q	11	25	106 (0+106)	32	6	
右折補正交通量 q R - N						
交差点流入部の需要率 ρ	0.007	-	0.053	0.031	0.003	現示の 需要率
必要現示率	1 ϕ	0.007	-	0.053		0.053
	2 ϕ				0.031	0.031
有効青時間(秒)	1 ϕ	52	52	52		サイクル長(秒)
	2 ϕ				30	30
信号青時間比 G/C	52/90	52/90	52/90	30/90	30/90	90
可能交通容量 C i	971	616	1156	350	600	
交通容量比 q/C i	0.011	0.041	0.092	0.091	0.010	

* $N = KER \times \frac{3600}{C}$

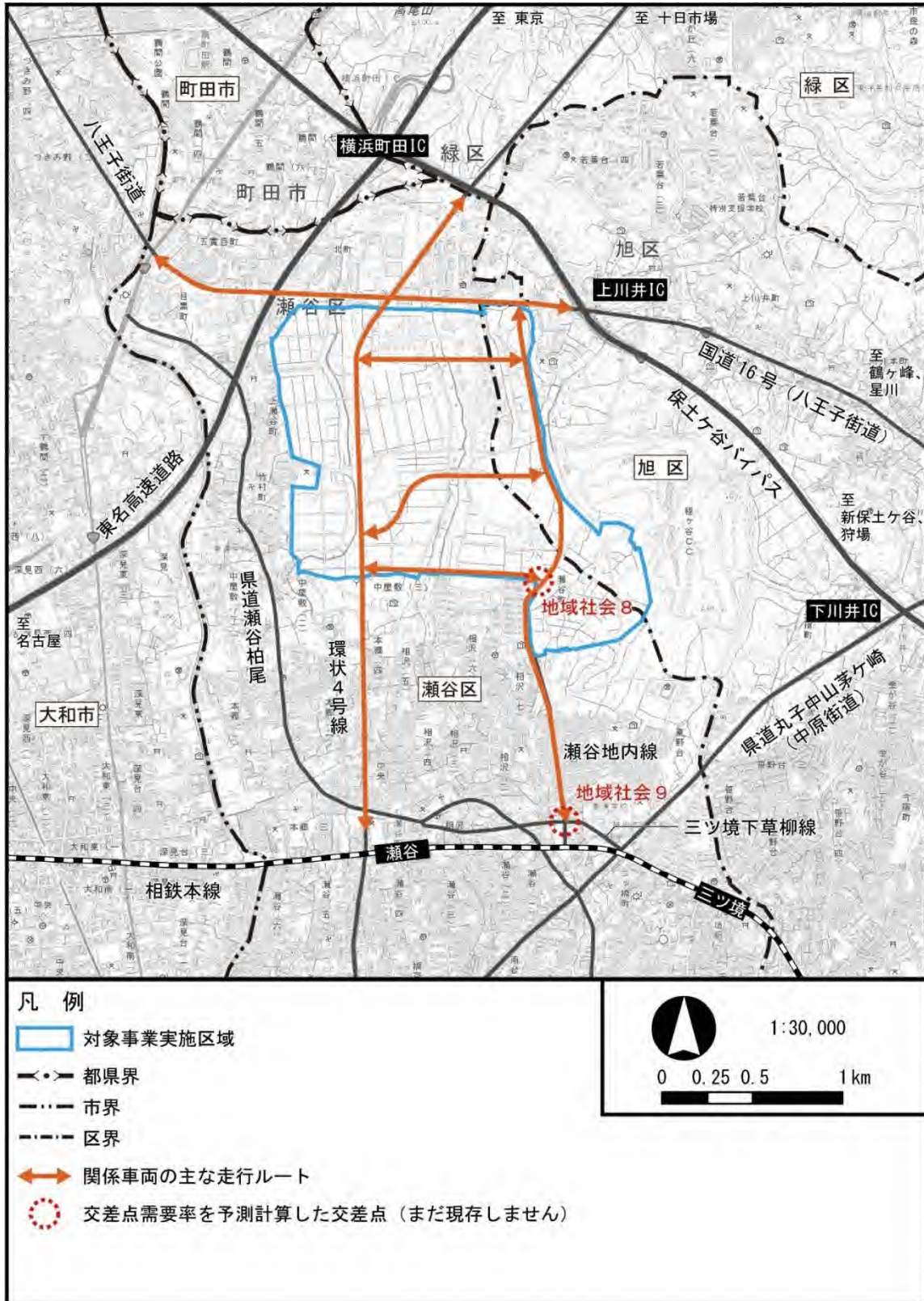
N : 1時間で右折車が交差点内に滞留する台数
* : 交通容量 (実1時間)

A : 至 八王子街道
B : 至 細谷戸ハイツ
C : 至 環状4号線

現示方式の図示

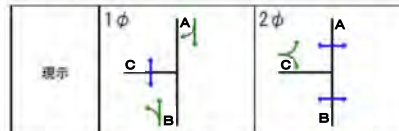

交差点概略図

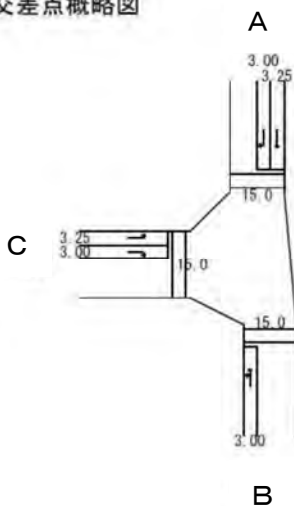

交通量図

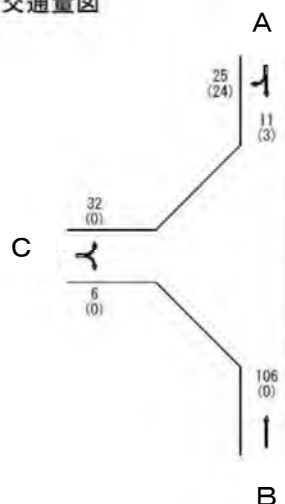

上段: 方向別合計交通量[台/時]
下段: (大型車混入台数)[台/時]

表 44-1 (2) 地域社会8の交差点需要率(休日:8時台)

流入部	A		B		C	
	直進	右折	左折・直進	左折	右折	
車線の種類	1	1	1	1	1	
車線数	1	1	1	1	1	
飽和交通流率の基本値	S B	2000	1800	2000	1800	1800
車線幅員による補正率 (車線幅員)	α_w m	1.000 (3.25)	1.000 (3.00)	1.000 (3.00)	1.000 (3.25)	1.000 (3.00)
縦断勾配による補正率 (縦断勾配)	α_G %	1.000 (0.00)	1.000 (0.00)	1.000 (0.00)	1.000 (0.00)	1.000 (0.00)
大型車混入による補正率 (大型車混入率)	α_T %	0.920 (12.50)	0.598 (96.00)	1.000 (0.00)	1.000 (0.00)	1.000 (0.00)
左折車混入による補正率 (左折率)	α_{LT} L %			0.994 (0.6)		
(歩行者による低減率)	f p			0.50	0.50	
(有効青時間)	秒			52	30	
(歩行者用青時間)	秒			47	25	
横断歩行者による補正率	α_L				0.583	
右折車混入による補正率 (右折率)	α_{RT} R %					
(右折車の通過確率)	f		0.848			
(有効青時間)	秒		52			
(現示変り目のさげ台数増分)	KER ; 台/サイクル (交差点内滞留台数)		2(80)			
K ; 台/サイクル						
飽和交通流率	S A	1840	4574	1988	1049	1800
設計交通量	q	8	25	161 (1+160)	48	22
右折補正交通量	q R - N					
交差点流入部の需要率	ρ	0.004	-	0.081	0.046	0.012
必要現示率	1 ϕ	0.004	-	0.081		0.081
	2 ϕ				0.046	0.046
有効青時間(秒)	1 ϕ	52	52	52		90
	2 ϕ				30	30
信号青時間比	G / C	52 / 90	52 / 90	52 / 90	30 / 90	30 / 90
可能交通容量	C i	1063	574	1149	350	600
交通容量比	q / C i	0.008	0.044	0.140	0.137	0.037

$$N = KER \times \frac{3600}{C}$$

N : 1時間で右折車が交差点内に滞留する台数
 ※ * : 交通容量 (実1時間)

A : 至 八王子街道
 B : 至 細谷戸ハイツ
 C : 至 環状4号線

現示方式の図示

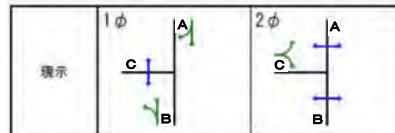

交差点概略図

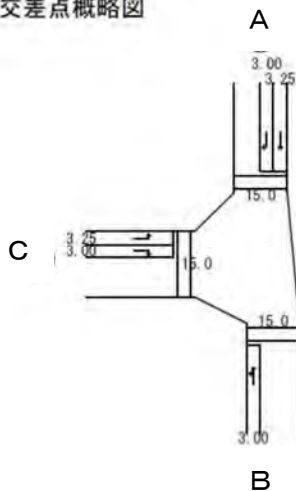

交通量図

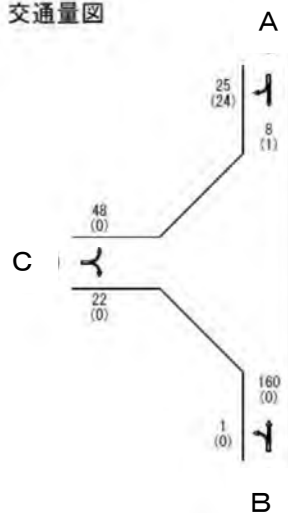

上段: 方向別合計交通量[台/時]
 下段: (大型車混入台数)[台/時]

表 44-1(3) 地域社会9の交差点需要率(平日:7時台)

流入部	C		A		D		B		現示の 需要率	交差点の 需要率
	左折・直進	右折	左折・直進	右折	左折・直進	右折	左折・直進	右折		
車線の種類	1	1	1	1	1	1	1	1		
車線数	1	1	1	1	1	1	1	1		
飽和交通流率の基本値 S _B	2000	1800	2000	1800	2000	1800	2000	1800		
車線幅員による補正率 α _w (車線幅員)	1.000 (3.00)	1.000 (3.00)	1.000 (3.00)	1.000 (3.00)	1.000 (3.00)	1.000 (3.00)	1.000 (3.00)	1.000 (3.00)		
縦断勾配による補正率 α _G (縦断勾配)	1.000 (0.00)	1.000 (0.00)	1.000 (0.00)	1.000 (0.00)	1.000 (0.00)	1.000 (0.00)	1.000 (0.00)	1.000 (0.00)		
大型車混入による補正率 α _T (大型車混入率)	0.785 (39.04)	0.980 (2.94)	0.923 (11.88)	1.000 (0.00)	0.791 (37.69)	0.968 (4.65)	0.952 (7.13)	1.000 (0.00)		
左折車混入による補正率 α _{L T} (左折率)	1.000 (0.0)		0.936 (6.6)		1.000 (0.0)		0.749 (32.5)			
(歩行者による低減率) f _p	0.50		0.50		0.50		0.50			
(有効青時間) 秒	33		58		33		58			
(歩行者用青時間) 秒	28		53		28		53			
横断歩行者による補正率 α _L										
右折車混入による補正率 α _{R T} (右折率)										
R % (右折車の通過確率)				0.675						0.744
f (有効青時間) 秒				58						58
(現示変り目のさげ台数増分) KER:台/サイクル (交差点内滞留台数) K:台/サイクル		2(60)			2(60)					2(60)
飽和交通流率 S _A	1570	1764	1728	*505	1582	1742	1426	*593		
設計交通量 q	292 (0+292)	170	303 (20+283)	0	321 (0+321)	43	547 (178+369)	0		
右折補正交通量 q _{R-N}		110				0				
交差点流入部の需要率 ρ	0.186	0.062	0.175	-	0.203	-	0.384	-		
必要現示率	1φ 0.186				0.203				0.203	0.649
	2φ	0.062				-			0.062	
	3φ		0.175	-			0.384	-	0.384	
有効青時間(秒)	1φ 33				33					サイクル長(秒)
	2φ	19				19				120
	3φ		58	58			58	58		
信号青時間比 G/C	33/120	19/120	58/120	58/120	33/120	19/120	58/120	58/120		
可能交通容量 C _i	432	339	835	505	435	336	689	593		
交通容量比 q/C _i	0.676	0.501	0.363	0.000	0.738	0.128	0.794	0.000		

$$* N = KER \times \frac{3600}{C}$$

N : 1時間で右折車が交差点内に滞留する台数
* : 交通容量 (実1時間)

- C : 至 環状4号線
- A : 至 跡地
- D : 至 中原街道
- B : 至 ニツ上橋交差点

現示方式の図示

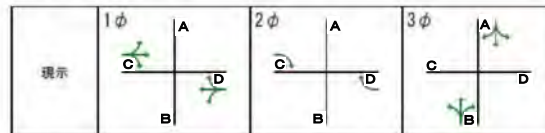

交差点概略図

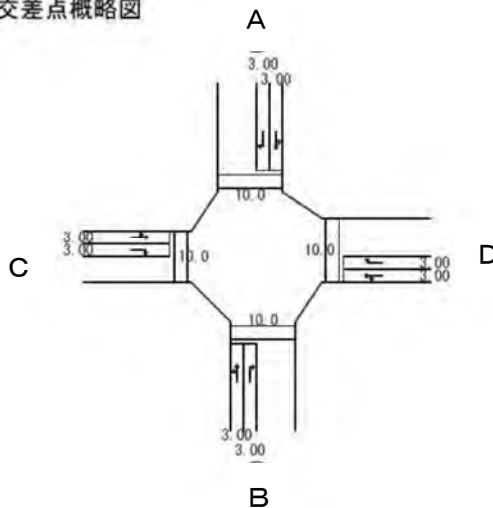

交通量図

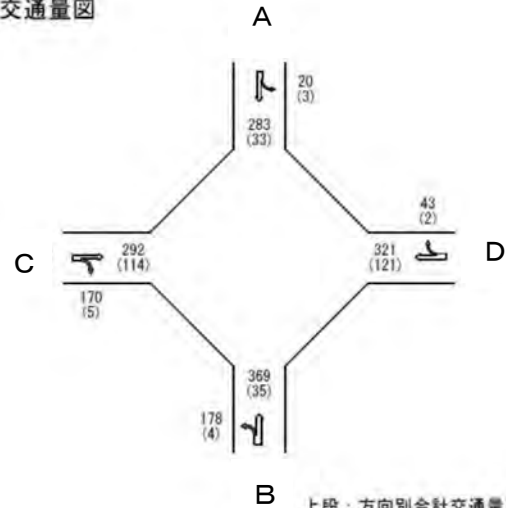

上段: 方向別合計交通量[台/時]
下段: (大型車混入台数)[台/時]

表 44-1 (4) 地域社会9の交差点需要率(休日:16時台)

流入部	C		A		D		B		
	左折・直進	右折	左折・直進	右折	左折・直進	右折	左折・直進	右折	
車線の種類	1	1	1	1	1	1	1	1	
車線数	1	1	1	1	1	1	1	1	
飽和交通流率の基本値	S B	2000	1800	2000	1800	2000	1800	2000	1800
車線幅員による補正率 (車線幅員)	αw	1.000 (3.00)	1.000 (3.00)	1.000 (3.00)	1.000 (3.00)	1.000 (3.00)	1.000 (3.00)	1.000 (3.00)	1.000 (3.00)
縦断勾配による補正率 (縦断勾配)	αG	1.000 (0.00)	1.000 (0.00)	1.000 (0.00)	1.000 (0.00)	1.000 (0.00)	1.000 (0.00)	1.000 (0.00)	1.000 (0.00)
大型車混入による補正率 (大型車混入率)	αT	0.791 (37.78)	0.981 (2.79)	0.941 (9.02)	1.000 (0.00)	0.790 (38.07)	0.935 (10.00)	0.950 (7.46)	1.000 (0.00)
左折車混入による補正率 (左折率)	$\alpha L T$	1.000 (0.0)		0.922 (8.3)		1.000 (0.0)		0.745 (33.6)	
(歩行者による低減率)	L%								
(有効青時間)	f p	0.50		0.50		0.50		0.50	
(歩行者用青時間)	秒	34		57		34		57	
横断歩行者による補正率	αL			52		29		52	
右折車混入による補正率 (右折率)	$\alpha R T$								
(右折車の通過確率)	R%				0.685				0.669
(有効青時間)	f				57				57
(現示変り目のさげ台数増分)			2(60)				2(60)		
KER: 台/サイクル (交差点内滞留台数)					2(60)				2(60)
K: 台/サイクル									
飽和交通流率	S A	1582	1766	1735	*506	1580	1683	1416	*486
設計交通量	q	315 (0+315)	179	410 (34+376)	0	331 (0+331)	30	536 (180+356)	0
右折補正交通量	q R-N		119			0			
交差点流入部の需要率	ρ	0.199	0.067	0.236	-	0.209	-	0.379	-
必要現示率	1 ϕ	0.199				0.209			0.209
	2 ϕ		0.067						0.067
	3 ϕ			0.236				0.379	0.379
有効青時間(秒)	1 ϕ	34				34			サイクル長(秒)
	2 ϕ		19				19		120
	3 ϕ			57	57			57	
信号青時間比	G/C	34/120	19/120	57/120	57/120	34/120	19/120	57/120	57/120
可能交通容量	C i	448	340	824	506	448	326	673	486
交通容量比	q/C i	0.703	0.526	0.498	0.000	0.739	0.092	0.796	0.000

$$N = KER \times \frac{3600}{C}$$

N: 1時間で右折車が交差点内に滞留する台数

*: 交通容量(実1時間)

- C: 至 環状4号線
- A: 至 跡地
- D: 至 中原街道
- B: 至 ニッ上橋交差点

現示方式の図示

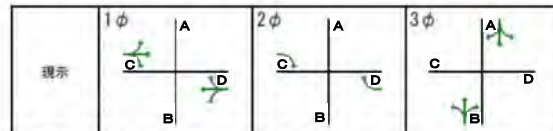

交差点概略図

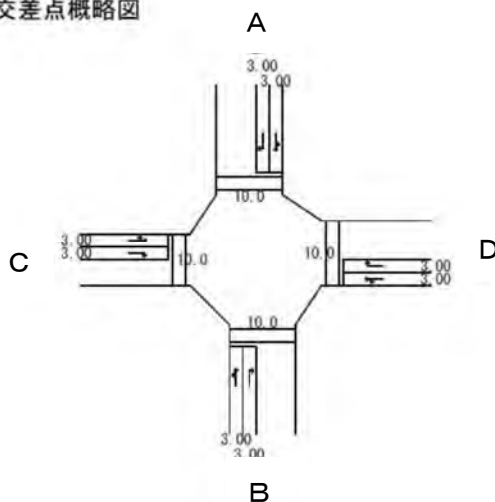

交通量図

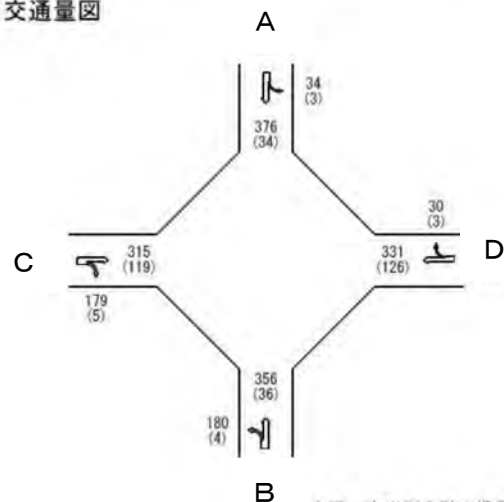

上段: 方向別合計交通量[台/時]
下段: (大型車混入台数)[台/時]

表 44-2(1) 地域社会 8 の方向別交通量

		A→B	A→C	A→D	B→A	B→C	B→D	C→A	C→B	C→D	D→A	D→B	D→C	計
平日	7時	9	25	0	77	0	0	24	1	0	0	0	0	136
	8時	11	25	0	108	0	0	32	6	0	0	0	0	181
	9時	14	25	0	78	0	0	18	9	0	0	0	0	141
	10時	16	25	0	55	0	0	11	10	0	0	0	0	118
	11時	23	26	0	44	0	0	7	16	0	0	0	0	117
	12時	19	14	0	36	0	0	5	21	0	0	0	0	96
	13時	18	14	0	33	0	0	5	24	0	0	0	0	94
	14時	27	15	0	29	0	0	4	27	0	0	0	0	102
	15時	36	16	0	26	0	0	4	31	0	0	0	0	112
	16時	36	16	0	22	0	0	3	42	0	0	0	0	120
	17時	47	16	0	22	0	0	4	38	0	0	0	0	128
	18時	49	30	0	16	0	0	3	27	0	0	0	0	125
	19時	40	29	0	12	0	0	3	10	0	0	0	0	94
	20時	34	29	0	11	0	0	3	18	0	0	0	0	94
	21時	27	29	0	12	0	0	3	5	0	0	0	0	76
	22時	21	28	0	10	0	0	3	4	0	0	0	0	67
23時	8	1	0	5	0	0	1	1	0	0	0	0	17	
24時	3	1	0	3	0	0	1	1	0	0	0	0	8	
休日	7時	6	25	0	111	0	0	36	1	0	0	0	0	179
	8時	8	29	0	190	1	0	48	22	0	0	0	0	265
	9時	9	25	0	141	1	0	27	30	0	0	0	0	232
	10時	10	25	0	95	0	0	16	32	0	0	0	0	180
	11時	13	26	0	77	0	0	11	44	0	0	0	0	171
	12時	11	14	0	59	0	0	8	56	0	0	0	0	148
	13時	10	14	0	56	0	0	8	62	0	0	0	0	140
	14時	15	14	0	48	0	0	6	69	0	0	0	0	153
	15時	20	15	0	46	0	0	5	65	0	0	0	0	151
	16時	21	15	0	44	0	0	5	101	0	0	0	0	186
	17時	26	16	0	43	0	0	6	73	0	0	0	0	163
	18時	27	28	0	33	0	0	5	56	0	0	0	0	150
	19時	23	28	0	26	0	0	4	27	0	0	0	0	108
	20時	23	29	0	16	0	0	4	30	0	0	0	0	102
	21時	23	29	0	19	0	0	5	7	0	0	0	0	82
	22時	19	29	0	15	0	0	4	7	0	0	0	0	74
23時	6	1	0	8	0	0	2	1	0	0	0	0	18	
24時	3	1	0	4	0	0	1	1	0	0	0	0	10	

表 44-2(2) 地域社会 8 の大型車混入率

		A→B	A→C	A→D	B→A	B→C	B→D	C→A	C→B	C→D	D→A	D→B	D→C	計
平日	7時	0.30	0.97	-	0.00	0.00	0.00	0.00	0.00	-	-	-	-	0.20
	8時	0.24	0.95	-	0.00	0.00	0.00	0.00	0.00	-	-	-	-	0.15
	9時	0.25	0.95	-	0.00	0.00	0.00	0.00	0.00	-	-	-	-	0.20
	10時	0.22	0.94	-	0.00	0.00	0.00	0.00	0.00	-	-	-	-	0.23
	11時	0.15	0.92	-	0.00	0.00	0.00	0.00	0.00	-	-	-	-	0.24
	12時	0.11	0.85	-	0.00	0.00	0.00	0.00	0.00	-	-	-	-	0.15
	13時	0.12	0.86	-	0.00	0.00	0.00	0.00	0.00	-	-	-	-	0.15
	14時	0.08	0.80	-	0.00	0.00	0.00	0.00	0.00	-	-	-	-	0.14
	15時	0.06	0.74	-	0.00	0.00	0.00	0.00	0.00	-	-	-	-	0.13
	16時	0.06	0.73	-	0.00	0.00	0.00	0.00	0.00	-	-	-	-	0.12
	17時	0.05	0.68	-	0.00	0.00	0.00	0.00	0.00	-	-	-	-	0.11
	18時	0.02	0.78	-	0.00	0.00	0.00	0.00	0.00	-	-	-	-	0.20
	19時	0.03	0.63	-	0.00	0.00	0.00	0.00	0.00	-	-	-	-	0.27
	20時	0.03	0.63	-	0.00	0.00	0.00	0.00	0.00	-	-	-	-	0.27
	21時	0.01	0.63	-	0.00	0.00	0.00	0.00	0.00	-	-	-	-	0.32
	22時	0.01	0.65	-	0.00	0.00	0.00	0.00	0.00	-	-	-	-	0.36
23時	0.02	0.00	-	0.00	0.00	0.00	0.00	0.00	-	-	-	-	0.01	
24時	0.05	0.00	-	0.00	0.00	0.00	0.00	0.00	-	-	-	-	0.02	
休日	7時	0.20	0.98	-	0.00	0.00	0.00	0.00	0.00	-	-	-	-	0.14
	8時	0.15	0.94	-	0.00	0.00	0.00	0.00	0.00	-	-	-	-	0.10
	9時	0.13	0.95	-	0.00	0.00	0.00	0.00	0.00	-	-	-	-	0.11
	10時	0.18	0.94	-	0.00	0.00	0.00	0.00	0.00	-	-	-	-	0.14
	11時	0.12	0.97	-	0.00	0.00	0.00	0.00	0.00	-	-	-	-	0.15
	12時	0.09	0.89	-	0.00	0.00	0.00	0.00	0.00	-	-	-	-	0.09
	13時	0.09	0.88	-	0.00	0.00	0.00	0.00	0.00	-	-	-	-	0.09
	14時	0.06	0.84	-	0.00	0.00	0.00	0.00	0.00	-	-	-	-	0.08
	15時	0.05	0.81	-	0.00	0.00	0.00	0.00	0.00	-	-	-	-	0.09
	16時	0.05	0.79	-	0.00	0.00	0.00	0.00	0.00	-	-	-	-	0.07
	17時	0.04	0.75	-	0.00	0.00	0.00	0.00	0.00	-	-	-	-	0.08
	18時	0.02	0.65	-	0.00	0.00	0.00	0.00	0.00	-	-	-	-	0.16
	19時	0.02	0.67	-	0.00	0.00	0.00	0.00	0.00	-	-	-	-	0.23
	20時	0.02	0.64	-	0.00	0.00	0.00	0.00	0.00	-	-	-	-	0.24
	21時	0.00	0.62	-	0.00	0.00	0.00	0.00	0.00	-	-	-	-	0.30
	22時	0.00	0.63	-	0.00	0.00	0.00	0.00	0.00	-	-	-	-	0.32
23時	0.01	0.00	-	0.00	0.00	0.00	0.00	0.00	-	-	-	-	0.00	
24時	0.03	0.00	-	0.00	0.00	0.00	0.00	0.00	-	-	-	-	0.01	

表 44-2(3) 地域社会 9 の方向別交通量

		A→B	A→C	A→D	B→A	B→C	B→D	C→A	C→B	C→D	D→A	D→B	D→C	計
平日	7時	283	0	20	269	179	0	0	170	292	43	0	321	1,676
	8時	278	0	21	299	173	0	0	185	283	53	0	312	1,661
	9時	258	0	19	332	155	0	0	150	290	40	0	283	1,486
	10時	248	0	19	293	146	0	0	142	245	32	0	267	1,391
	11時	237	0	18	267	133	0	0	130	228	26	0	243	1,282
	12時	224	0	17	245	123	0	0	121	206	23	0	225	1,188
	13時	238	0	18	257	131	0	0	128	223	23	0	240	1,260
	14時	243	0	19	281	129	0	0	127	221	21	0	236	1,248
	15時	267	0	22	295	130	0	0	137	239	22	0	254	1,344
	16時	293	0	24	268	143	0	0	141	243	21	0	262	1,390
	17時	317	0	27	299	182	0	0	160	281	24	0	298	1,566
	18時	332	0	28	316	175	0	0	173	304	23	0	320	1,670
	19時	265	0	23	260	144	0	0	145	252	19	0	288	1,371
	20時	228	0	24	215	121	0	0	120	215	16	0	221	1,162
	21時	172	0	22	170	84	0	0	84	174	14	0	173	914
	22時	123	0	19	121	86	0	0	87	127	11	0	122	654
23時	55	0	6	56	31	0	0	31	55	5	0	56	298	
24時	38	0	4	40	22	0	0	22	39	3	0	41	209	
休日	7時	115	0	10	184	72	0	0	68	120	45	0	132	757
	8時	189	0	17	256	106	0	0	102	178	64	0	196	1,133
	9時	237	0	20	343	133	0	0	130	228	56	0	247	1,390
	10時	235	0	23	355	160	0	0	158	273	44	0	298	1,596
	11時	304	0	25	352	185	0	0	183	283	35	0	304	1,637
	12時	298	0	24	325	156	0	0	154	268	32	0	289	1,546
	13時	313	0	25	342	188	0	0	186	287	23	0	309	1,642
	14時	307	0	27	314	154	0	0	152	287	29	0	283	1,533
	15時	312	0	28	318	157	0	0	156	275	28	0	285	1,563
	16時	376	0	34	365	180	0	0	178	315	30	0	331	1,801
	17時	316	0	31	304	153	0	0	152	273	28	0	282	1,540
	18時	318	0	32	308	160	0	0	160	287	26	0	294	1,583
	19時	215	0	23	217	112	0	0	112	203	19	0	206	1,107
	20時	196	0	27	181	99	0	0	100	187	16	0	182	988
	21時	143	0	26	142	77	0	0	78	154	14	0	141	776
	22時	145	0	25	145	79	0	0	80	158	14	0	146	791
23時	74	0	8	79	43	0	0	43	77	7	0	79	410	
24時	54	0	5	59	32	0	0	32	56	5	0	59	300	

表 44-2(4) 地域社会 9 の大型車混入率

		A→B	A→C	A→D	B→A	B→C	B→D	C→A	C→B	C→D	D→A	D→B	D→C	計
平日	7時	0.12		0.13	0.10	0.02	-		0.03	0.29	0.06	-	0.38	0.19
	8時	0.12		0.12	0.09	0.02	-		0.03	0.29	0.05	-	0.37	0.18
	9時	0.11		0.12	0.10	0.03	-		0.03	0.29	0.05	-	0.38	0.19
	10時	0.11		0.11	0.10	0.03	-		0.03	0.29	0.05	-	0.38	0.19
	11時	0.11		0.11	0.10	0.03	-		0.03	0.29	0.07	-	0.38	0.19
	12時	0.11		0.10	0.10	0.03	-		0.03	0.29	0.08	-	0.38	0.19
	13時	0.11		0.11	0.10	0.03	-		0.03	0.29	0.08	-	0.38	0.19
	14時	0.10		0.10	0.10	0.03	-		0.03	0.29	0.09	-	0.38	0.19
	15時	0.10		0.09	0.11	0.03	-		0.03	0.29	0.09	-	0.38	0.19
	16時	0.10		0.09	0.11	0.03	-		0.03	0.29	0.10	-	0.38	0.19
	17時	0.10		0.09	0.11	0.03	-		0.03	0.29	0.10	-	0.38	0.19
	18時	0.10		0.09	0.11	0.02	-		0.03	0.29	0.11	-	0.38	0.19
	19時	0.10		0.08	0.11	0.02	-		0.03	0.29	0.11	-	0.38	0.19
	20時	0.10		0.08	0.11	0.02	-		0.03	0.27	0.10	-	0.38	0.19
	21時	0.10		0.06	0.11	0.02	-		0.03	0.28	0.10	-	0.38	0.19
	22時	0.10		0.05	0.11	0.02	-		0.03	0.25	0.09	-	0.38	0.18
23時	0.10		0.08	0.11	0.02	-		0.03	0.27	0.09	-	0.38	0.19	
24時	0.11		0.09	0.11	0.02	-		0.03	0.25	0.09	-	0.38	0.19	
休日	7時	0.12		0.10	0.07	0.02	-		0.03	0.28	0.02	-	0.37	0.17
	8時	0.11		0.09	0.07	0.02	-		0.03	0.28	0.02	-	0.37	0.17
	9時	0.11		0.10	0.08	0.02	-		0.03	0.28	0.03	-	0.37	0.17
	10時	0.11		0.10	0.09	0.02	-		0.03	0.29	0.05	-	0.38	0.18
	11時	0.10		0.10	0.09	0.02	-		0.03	0.28	0.06	-	0.38	0.18
	12時	0.10		0.09	0.10	0.02	-		0.03	0.29	0.07	-	0.38	0.18
	13時	0.10		0.10	0.10	0.02	-		0.03	0.28	0.07	-	0.38	0.19
	14時	0.09		0.09	0.10	0.02	-		0.03	0.28	0.08	-	0.38	0.18
	15時	0.09		0.08	0.10	0.02	-		0.03	0.28	0.08	-	0.38	0.18
	16時	0.09		0.08	0.10	0.02	-		0.03	0.28	0.09	-	0.38	0.18
	17時	0.09		0.07	0.10	0.02	-		0.03	0.27	0.08	-	0.38	0.18
	18時	0.08		0.07	0.10	0.02	-		0.03	0.27	0.09	-	0.38	0.18
	19時	0.10		0.07	0.10	0.02	-		0.03	0.25	0.08	-	0.38	0.18
	20時	0.09		0.05	0.11	0.02	-		0.03	0.25	0.09	-	0.38	0.18
	21時	0.10		0.04	0.11	0.02	-		0.03	0.23	0.08	-	0.38	0.18
	22時	0.10		0.05	0.11	0.02	-		0.03	0.24	0.08	-	0.38	0.18
23時	0.11		0.06	0.11	0.02	-		0.03	0.27	0.09	-	0.38	0.19	
24時	0.11		0.09	0.11	0.02	-		0.03	0.26	0.09	-	0.38	0.19	

45. 防衛省による土壤汚染調査結果について

防衛省が、土壤汚染対策法のガイドラインの実施方法（深度方向 0～0.5m）に基づいて実施した概況調査及び詳細調査の結果、国有地において指定基準値超過が確認された区画を準備書では 56 区画としていました。

今回、国有地の一部にあたるウド室の撤去工事に伴い、土地の形質変更が一定規模以上となることにより、横浜市から国に対し、土壤汚染対策法に基づく土壤汚染調査が命じられました。この命令に伴い、防衛省が実施した調査結果に基づき、深度方向 0.5m～1.0m において基準値調査が確認された 10 区画について詳細調査が完了した旨、防衛省から情報提供がされたため、これを踏まえ、準備書の該当箇所を（3）に記載のとおり、更新します。

また、準備書で「旧地盤」と記載していたものについて、一部、深さに誤りがありましたので、併せて修正させていただきます。（太字、下線部分を更新）

なお、汚染土壤の掘削除去を行う際の対応については、7月27日審査会での補足資料 10 のとおりとし、汚染土壤の掘削除去に際しての河川水質対策は、8月31日審査会での補足資料 20 に示したとおりとします。

また、今回追加された 10 区画についても、他の区画と同様に、汚染土壤が確認された範囲は地表面付近であり、洪積砂礫層内に分布すると推定される GL-15m 以下の帯水層には影響が及ぶことはないと考えています。

従って、掘削除去後の地下水の水質の影響については、9月30日審査会の補足資料 41 「⑤地下水の水質」に示すモニタリングを実施することとします。なお、採水は、鉛等の比重の特性を踏まえて、複数の深度の帯水層で行います。

（1）防衛省による調査結果

鉛及びその化合物（土壤溶出量）：1 区画にて基準値超過（深度方向 0.5m～1.0m）

ふっ素及びその化合物（土壤溶出量）：9 区画にて基準値超過（深度方向 0.5m～1.0m）

※地下水が確認された調査区画については地下水の分析を実施し、いずれも基準に適合

（2）土壤汚染対策法に基づく形質変更時要届出区域への指定

指定年月日：令和 3 年 9 月 24 日

所在地：瀬谷区瀬谷町 7745 番の一部（ウド室部分）

面積：834.56 m²

詳細は、下記の形質変更時要届出区域台帳の通りです。

(形質変更要届出区域台帳より)

様式第二十三(第五十八条第五項関係)
形質変更要届出区域台帳

整理番号	整-R03-7	指定年月日・指定番号	令和3年9月24日・指-197	所在地	瀬谷区瀬谷町7745番の一部	横浜市
調製・訂正年月日	令和3年10月6日調製(新規指定)					
形質変更要届出区域の概況	未利用地	面積	834.56平方メートル			
法第14条第3項の規定に基づき指定された形質変更要届出区域にあつては、その旨	<p>最大形質変更深さより1メートルを超える深さの位置について試料採取等の対象としなかつた土壌汚染状況調査の結果により指定された形質変更要届出区域にあつては、その旨、当該試料採取等の対象としなかつた深さの位置及び特定有害物質の種類土壌汚染のおそれの把握等、試料採取等を行う区画の選定等又は試料採取等を省略した土壌汚染状況調査の結果により指定された形質変更要届出区域にあつては、その旨及び当該省略の理由</p> <p>汚染の除去等の措置が講じられた形質変更要届出区域にあつては、その旨及び当該汚染の除去等の措置</p> <p>第58条第5項第10号から第13号までに該当する区域にあつては、その旨</p>					
形質変更要届出区域内の土壌汚染状態	報告受理年月日	指定に係る特定有害物質の種類	適合しない基準項目	指定調査機関の名称		
	令和3年6月29日	鉛及びその化合物、ふっ素及びその化合物	含有量基準・溶出量基準	中央開発株式会社		
			含有量基準・溶出量基準・第二溶出量基準			
			含有量基準・溶出量基準・第二溶出量基準			
			含有量基準・溶出量基準・第二溶出量基準			
			含有量基準・溶出量基準・第二溶出量基準			
土地の形質の変更の実施状況	届出(着手)時期	完了時期	実施者	汚染土壌の処理方法		
			土壌搬出	汚染土壌の処理方法		
			有・無			
			有・無			
			有・無			
			有・無			

備考1 この用紙の大きさは、日本産業規格A4とすること。
 2 「形質変更要届出区域内の土壌の汚染状態」については、土壌その他の試料の採取を行った日、当該試料の測定の結果等を記載した書類を添付すること。

(形質変更要届出区域台帳より)



瀬谷区区民生活マップ

Copyright(C) City of Yokohama. All rights reserved.

(形質変更要届出区域台帳より)

調査結果

土壤分析結果一覧表を表 に、調査結果平面図を図 に示す。

調査の結果、ふっ素及びその化合物、鉛及びその化合物の土壤溶出量基準不適合が確認された。

ふっ素及びその化合物、鉛及びその化合物の土壤含有量は、全地点で基準に適合した。

表 土壤分析結果一覧表

地点名	土壤採取深度 (GL-m)	土壤含有量		土壤溶出量	
		鉛及び その化合物	ふっ素及び その化合物	鉛及び その化合物	ふっ素及び その化合物
1 E12-7	0.5-1.0	—	<100	—	0.89
2 E12-8	0.5-1.0	—	<100	—	0.85
3 E13-3	0.5-1.0	—	<100	—	0.92
4 E14-8	0.5-1.0	—	130	—	0.92
5 F13-7	0.5-1.0	<5	—	0.014	—
6 G12-5	0.5-1.0	—	350	—	1.1
7 G12-9	0.5-1.0	—	360	—	1.0
8 G14-2	0.5-1.0	—	<200	—	0.84
9 G14-5	0.5-1.0	—	<200	—	1.4
基準値		150	4000	0.01	0.8
		mg/kg	mg/kg	ng/L	mg/L
土壤汚染対策法					

※赤字：基準不適合箇所

：「上瀬谷（28）土壤調査 報告書 平成29年3月」より

採取日：平成29年1月10日～平成29年1月13日、令和3年4月13日

分析日：平成29年1月16日～平成29年3月16日、令和3年4月14日～令和3年6月23日

分析方法：平成15年環境省告示第18号（土壤溶出量調査）

平成15年環境省告示第19号（土壤含有量調査）

(形質変更要届出区域台帳より)

【鉛及びその化合物】

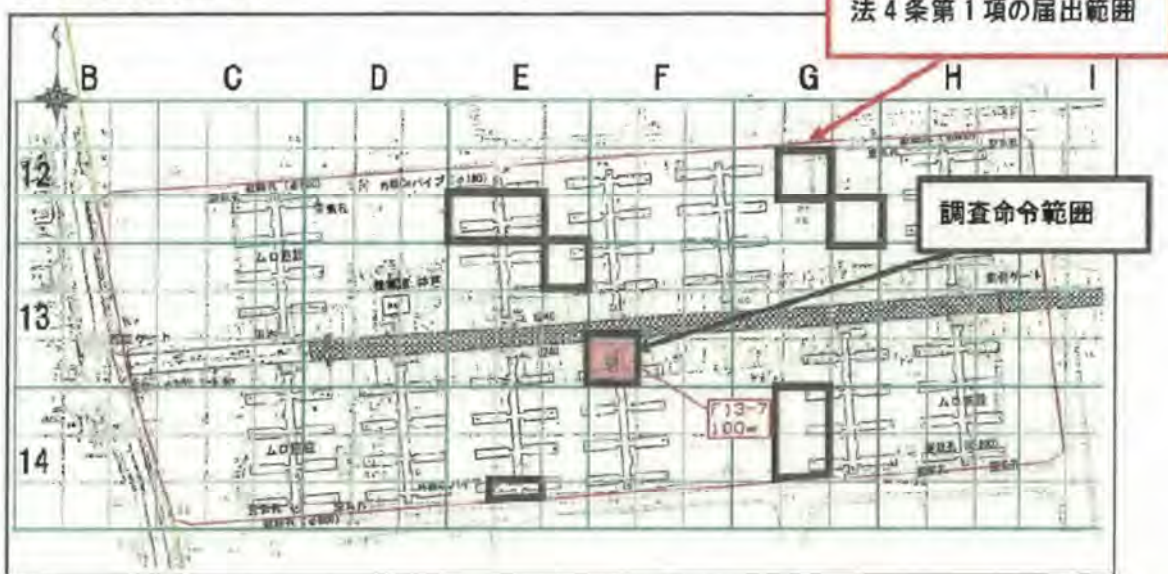

【ふっ素及びその化合物】



図 調査結果平面図

(3) 準備書の更新箇所について

9.9 土壤汚染

9.9.1 調査結果の概要

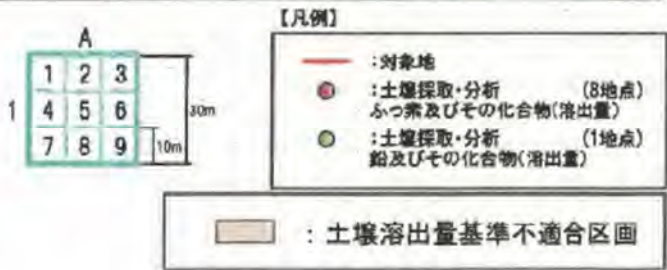
(6) 調査結果

② 土壤汚染の状況

ア. 文献その他の資料調査

c. 調査結果 (国有地)

(a) 特定有害物質

返還国有地約 110ha のうち、土壤汚染対策法に基づく指定基準値超過が確認された計 **66 調査区画** で詳細調査が行われており、その結果の概要は表 9.9-2 及び図 9.9-3 に示すとおりです。

表 9.9-2 防衛省における土壤汚染調査結果の概要 (国有地)

物質	項目	指定基準 超過区画数	最大 検出値	指定 基準値	深度方向の指定基準超過状況
鉛及びその化合物 (土壤溶出量、mg/L)		<u>22</u>	0.069	0.01	㊦深度方向 0~0.5m のみ 20 調査区画 ㊧深度方向 0~0.5m 及び 8m、9m にて 1 調査区画 ㊨深度方向 <u>0.5~1m のみ 1 調査区画</u> (㊦㊧㊨の合計 22 調査区画)
鉛及びその化合物 (土壤含有量、mg/kg)		36	1,600	150	㊰深度方向 0~0.5m のみ <u>29</u> 調査区画 ㊱深度方向 0~0.5m 及び旧地盤 (GL-0.85~GL- <u>1.35m</u>) にて 1 調査区画 ㊲深度方向 0~0.5m 及び 1m にて 1 調査区画 ㊳深度方向 <u>0~0.5m 及び 0.5~1m にて 1 調査区画</u> ㊴旧地盤 (GL-2.0~GL-2.5m) のみ 2 調査区画 ㊵旧地盤 (GL-2.0~GL-2.5m) 及び深度方向 2m に て 1 調査区画 ㊶旧地盤 (GL-2.0~GL-2.5m) 及び深度方向 1m、2 m にて 1 調査区画 (㊰から㊶の合計 36 調査区画)
ひ素及びその化合物 (土壤溶出量、mg/L)		1	0.017	0.01	深度方向 0~0.5m にて 1 調査区画
ふっ素及びその化合物 (土壤溶出量、mg/L)		<u>10</u>	<u>1.4</u>	0.8	㊷深度方向 0~0.5m にて 1 調査区画 ㊸深度方向 <u>0.5~1m にて 9 調査区画</u> (㊷㊸の合計 <u>10 調査区画</u>)

注：1. 鉛については、土壤溶出量、土壤含有量のいずれも基準不適合になった区画が3箇所あったため、指定基準調査区画数の合計が **66 調査区画** になりません。
 2. 第二溶出量基準値 (いずれも土壤溶出量として、鉛及びその化合物 (0.3mg/L 以下)、ひ素及びその化合物 (0.3mg/L 以下)、ふっ素及びその化合物 (24mg/L 以下)) を超える値は検出されていません。
 3. 上記、土壤溶出量基準不適合区画のうち、地下水が確認された調査区画について、以下に示す要領にて採取し、平成 15 年 3 月 6 日環境省告示第 17 号に準拠して、地下水の分析を実施した結果、いずれも基準に適合していました。(全ての調査地点において定量下限値未満で検出されていません。)

【地下水採取方法】

機械ボーリング (φ 86mm) 完了後に、孔内に簡易観測井戸を設置
 簡易観測井戸の構造は、各観測地点のボーリング時の土質及び孔内水位等により決定
 地下水採取は、掘削底面と地下水水位の中間水位にて採取

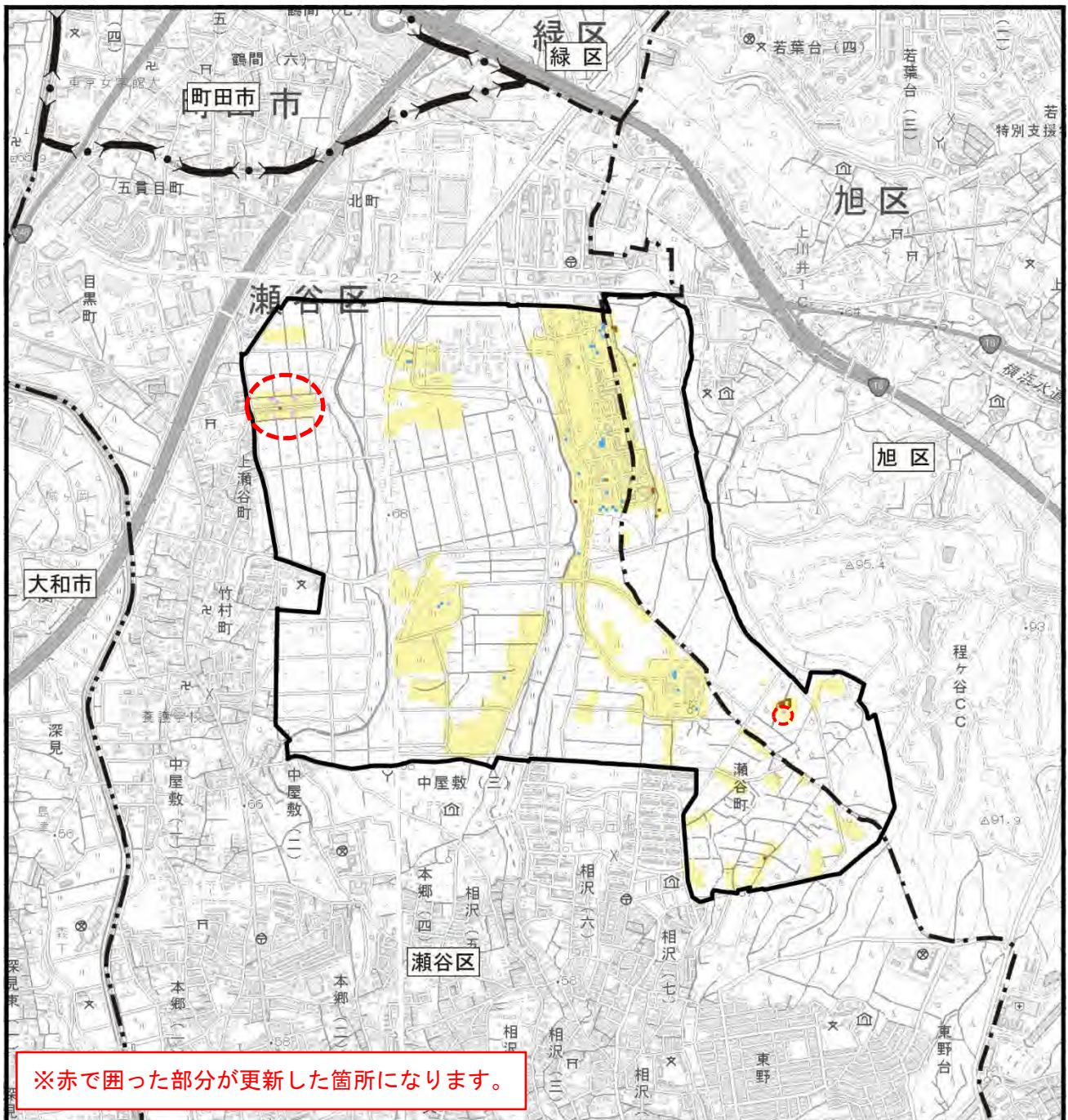

※赤で囲った部分が更新した箇所になります。

凡例

- 対象事業実施区域
◀・▶
都県界
- - -
市界
- · - · -
区界
- 調査区画
- 鉛（溶出量）基準点超過地点
- 鉛（含有量）基準点超過地点
- 鉛（溶出量及び含有量）基準点超過地点
- ひ素（溶出量）基準点超過地点
- ふっ素（溶出量）基準点超過地点



図 9.9-3 国有地における土壤汚染調査区画及び基準超過区画の位置

9.9.2 予測及び評価の結果

(1) 予測

⑤ 予測結果

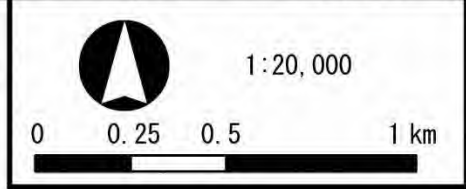
イ. 予測結果



図 9.9-3 国有地における土壌汚染調査区画及び基準超過区画の位置

掘削除去を行う場合に場外搬出される土量については、仮に現時点で防衛省の調査により確認されている表層及び深度方向2mまでの範囲における汚染土壌を全量場外搬出するものと想定（既に国により除去されている民有地の鉛による汚染確認区画（2区画）は除きます。）して、以下のように算出しました。なお、算出にあたっては、対象事業実施区域の南東部において深さ8m、9mの位置で鉛（土壌溶出量）の基準を超過している地点については、公益的施設用地で、土地の改変が最小限に抑えられるため、この深度付近に至る土地の改変が想定されず、かつ、現状で地下水汚染もみられないことから、掘削除去による措置は行わない計画としました。

【掘削除去の対象となる区画数】

- ・表層0.5mまで（国有地）の汚染…1mまで掘削
 国有地49区画（鉛47区画（前掲表9.9-2（P.9.9-6）㊶㊷㊸の合計-3）、ひ素1区画、ふっ素1区画、土壌溶出量、土壌含有量のいずれも指定基準値を超過する3区画は、各区画とも表層0.5mまでにおける超過であるため、3を減じています。）
 - ・表層0.5～1mでの汚染…2mまで掘削
国有地11区画（鉛2区画（前掲表9.9-2（P.9.9-6）㊶㊷）、ふっ素9区画（同㊸））
 民有地19区画（ふっ素19区画）
 - ・表層1mまで又は旧地盤（GL-0.85～GL-1.35m）での汚染…2mまで掘削
 国有地2区画（鉛2区画）（前掲表9.9-2（P.9.9-6）㊶㊷の合計）
 民有地では該当区画はありません。
 - ・表層2mまで又は旧地盤（GL-2.0～GL-2.5m）での汚染…3mまで掘削
 国有地4区画（鉛4区画（前掲表9.9-2（P.9.9-6）㊶㊷㊸の合計）、
 民有地1区画（ふっ素1区画）
- ※1mでは汚染が見られず2mのみで汚染が確認された区画を含みます。

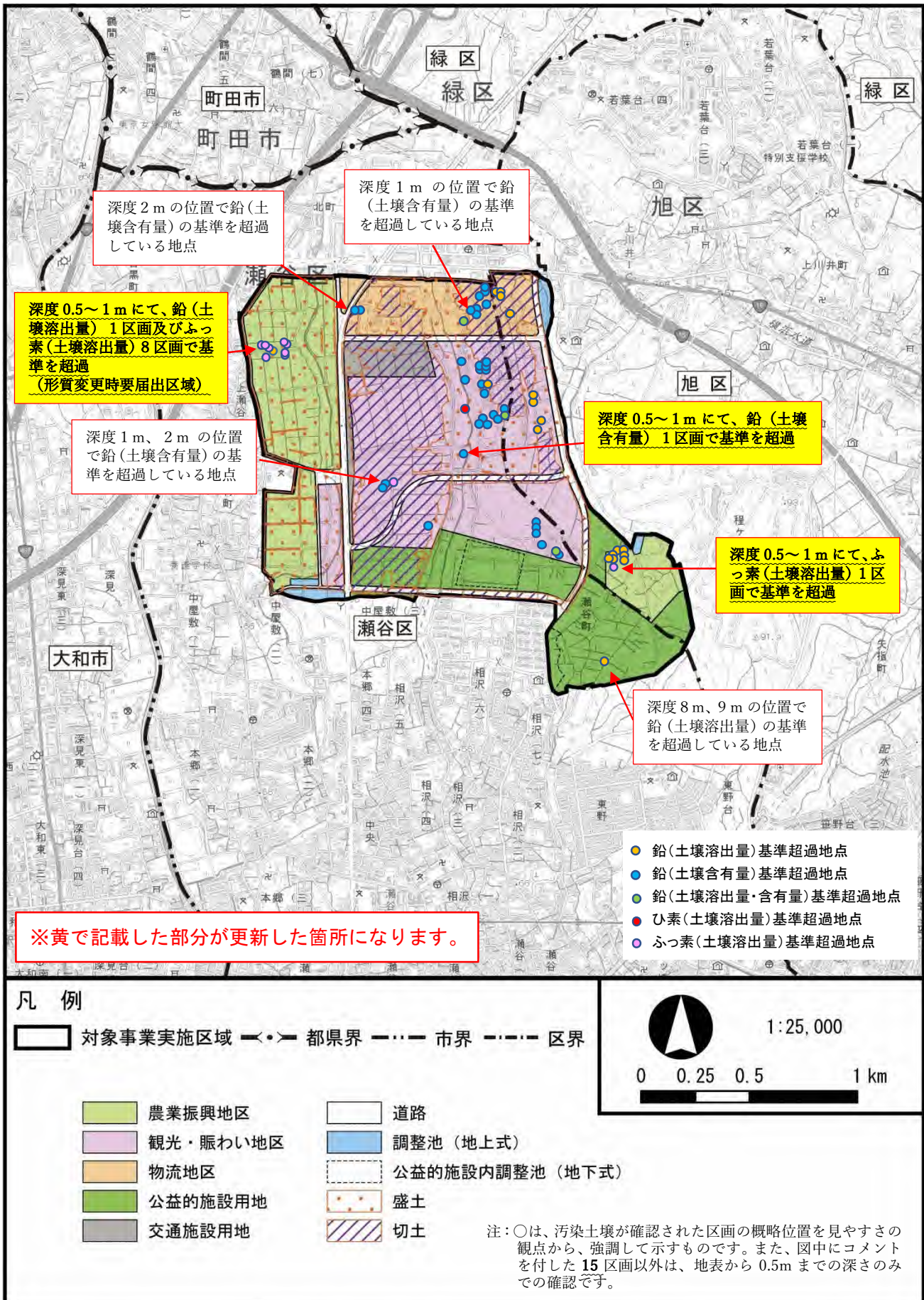
【掘削除去により生じる汚染土壌の量】

$$\begin{aligned} \text{汚染土壌場外搬出量} &= 10\text{m} \times 10\text{m} \times ((49+0) \times 1\text{m} + (19+11) \times 2\text{m} + (2+0) \times 2\text{m} + (4+1) \times 3\text{m}) \\ &= 12800\text{m}^3 \end{aligned}$$

ほぐした土量に換算するための変化率Lは、「施工パッケージ型積算基準（令和2年度4月適用分）」（国土交通省）により、対象事業実施区域の表層地質は武蔵野ローム層が主体であることから1.25とすると、ほぐした状態での土量は以下ようになります。

$$\text{汚染土壌のほぐした状態の土量} = 12800 \times 1.25 = 16000\text{m}^3$$

これを、前掲表2.3-5（P.2-16）に示す土工事の期間に施工エリアごとに段階的に場外搬出することになりますが、着工後の1年間（実稼働日数300日）で集中的に搬出するものとして、1日当たりの汚染土壌掘削土砂搬出に係る台数は以下のようになり、1日当たり9台の発生（発生集中交通量としては、18台・TE/日程度）となります。

1日当たり場外搬出車両台数 = 汚染土壌の量 / 1台当たりの積載量 / 実稼働日数

$$= 16000 (\text{m}^3) / 6 (\text{m}^3/\text{台}) / 300 (\text{日}) = 9.0 (\text{台}/\text{日})$$

備考：1台当たりの積載量は容積約1.5m³のフレキシブルコンテナ※を4袋積載と想定しました。



※：フレキシブルコンテナの例

旧上瀬谷通信施設地区土地区画整理事業 環境影響評価に関する補足資料

＜補足資料内容＞

46. 建設発生土の指定処分について
47. 公益的施設用地における防災機能について
48. 桜並木の景観について
49. 鎌倉古道の一部改変に伴う人と自然との触れ合いの活動の場への影響について
50. 後背地との連続性に配慮した調整池について
51. 鳥類のねぐら調査の時間帯について
52. 大門川と相沢川を暗渠化した理由及び経緯
53. 国内における暗渠化の事例について
54. 相沢川の谷戸環境について

令和3年11月

横浜市

46. 建設発生土の指定処分について

第12回審査会(2021年9月30日開催)の補足資料38について、表9.15-9及び表9.15-10の、「産業廃棄物、建設発生土の適正な管理」の欄を以下のように修正します。

表 9.15-9 環境保全措置の検討の状況

環境保全措置	実施の適否	適否の理由
産業廃棄物、建設発生土の適正な管理	適	廃棄物の処理及び清掃に関する法律、神奈川県土砂の適正処理に関する条例等を遵守するとともに指定処分を前提とすることにより、産業廃棄物や建設発生土の適正処理が図られます。

表 9.15-10 環境保全措置の実施の内容

影響要因	影響	検討の視点	環境保全措置			実施主体	効果の不確実性	他の環境への影響
			内容	効果	区分			
工事の実施	造成工事の実施	へ廃棄物の負荷等による環境	産業廃棄物、建設発生土の適正な管理	廃棄物の処理及び清掃に関する法律、神奈川県土砂の適正処理に関する条例等を遵守するとともに、指定処分を前提とすることにより、産業廃棄物や建設発生土の適正処理が図られます。	低減	事業者	なし	なし

47. 公益的施設用地における防災機能について

本地区の公益的施設用地では、大規模災害発生時には広域応援活動拠点としての機能や広域避難場所として機能の確保に向けた検討を進めています。

広域応援活動拠点は、「横浜市防災計画（震災対策編）」にある通り、防衛省、緊急消防援助隊、広域緊急援助隊（警察）の応援部隊が円滑に救助・救出活動を行うための拠点であり、部隊の集結に便の良い交通要所に位置するとともに、想定される派遣人数の宿営及びヘリコプターの発着が可能な広い場所が必要になります。

具体的な規模については、今後、検討していきますが、公益的施設用地の中央付近については、これらの施設や機能を十分に確保していきたいと考えているため、調整池3については上部利用の出来る地下式調整池としています。



広域応援活動拠点のイメージ

（「旧上瀬谷通信施設土地利用基本計画（2020年3月）」より）

48. 桜並木の景観について

海軍道路の桜並木は、対象事業実施区域内に存在する景観資源として準備書で予測を行っています(準備書 p. 9. 13-23)が、新たに海軍道路の桜並木が眺望できる地点を設定し、遠景の眺望景観としての影響の予測評価を行いました。

1) 新たに設定する予測評価の地点選定

新たに設定する海軍道路の桜並木が眺望できる地点は、選定する際に以下の点に留意しました。

- ・ 予測評価を行う地点と海軍道路の間に障害物等がなく、長い区間の海軍道路を望める地点を選定しました。
- ・ 不特定多数の人が眺望できる地点を選定しました。

以上の観点から現地踏査を行った結果、対象事業実施区域西側の道路上の地点である地点⑦を選定しました。(位置は、図 48-1 に示すとおりです。)

地点⑦についての予測結果、環境保全措置、評価は、「2) 環境影響評価の予測及び評価の結果」(p. 5～8)に記載したとおりです。



図 48-1 予測評価地点

2) 環境影響評価の予測及び評価の結果

(1) 予測結果

本地点は、対象事業実施区域西側の道路上に位置します。

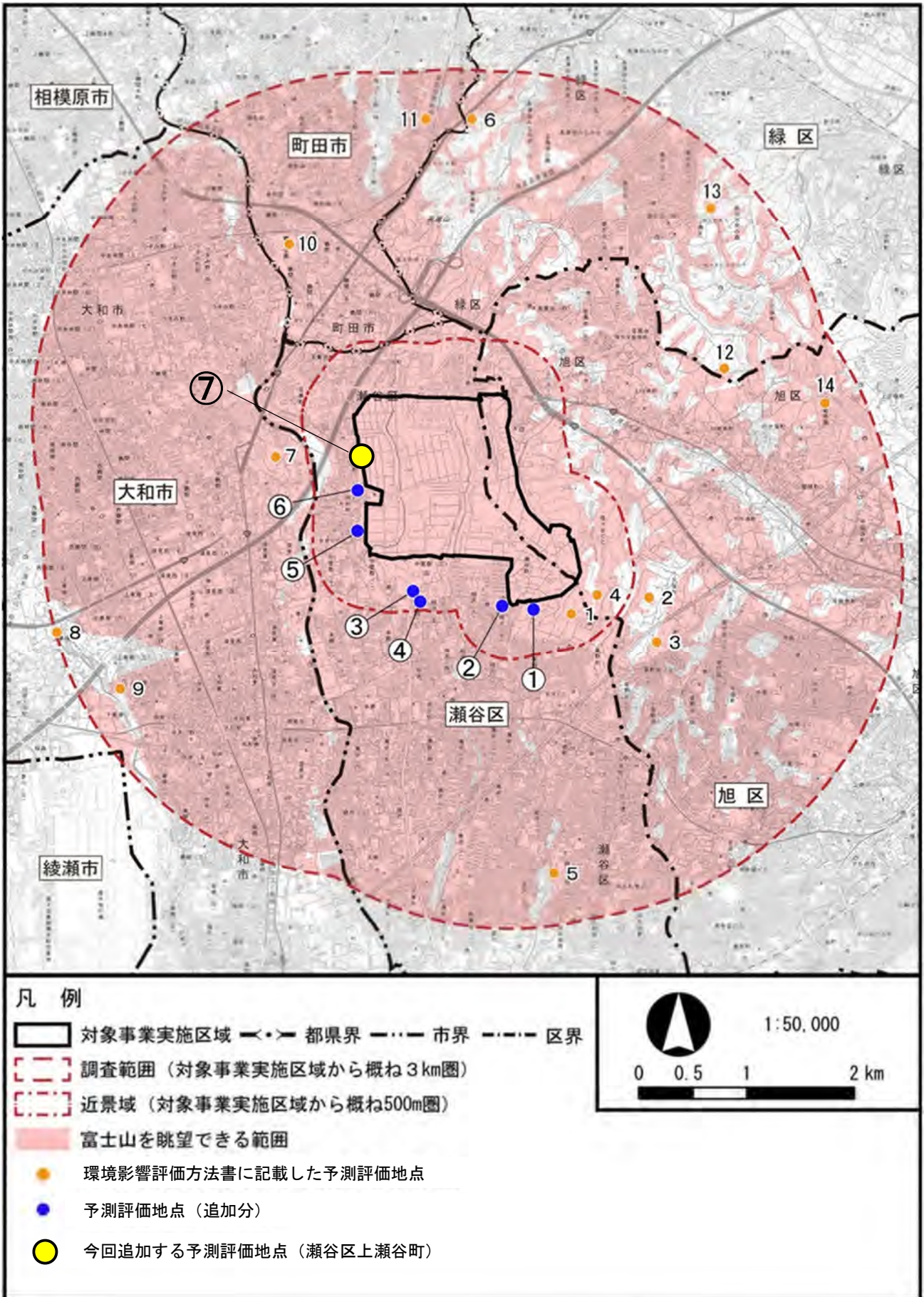
本地点からは、写真 48-1(1)に示すように、対象事業実施区域が眺望できます。対象事業実施区域内は正面に農道が通っており、その左右に畑が広がっています。また農道の突き当りには海軍道路の桜並木、そして更にその奥には、対象事業実施区域内の樹木が眺望できます。なお、現況写真は2021年10月に撮影を行いましたので、海軍道路の桜並木が分かる様に加工を行っています。

敷地の存在時においては、写真 48-1(2)に示すように、本地点から視認できる範囲は農業振興地区として改変しますが、視野に入るほとんどは道路と擁壁になります。それ以外は、海軍道路の桜並木や奥の樹木が伐採され、対象事業実施区域の東側に建っている建築物や樹木を望む眺望景観となり、大きく変化するものと予測します。

構造物の存在時においては、写真 48-1(3)に示すように、本地点からは区域内道路、調整池等の構造物は視認できないため、眺望としては敷地の存在時と同じであり、眺望景観が大きく変化するものと予測します。



写真 48-1(1) No. 7 瀬谷区上瀬谷町（現況：海軍道路の桜並木が分かる様に加工済）



写真 48-1(2) No. 7 瀬谷区上瀬谷町 (敷地の存在)



写真 48-1(3) No. 7 瀬谷区上瀬谷町 (構造物の存在)

(2) 環境保全措置

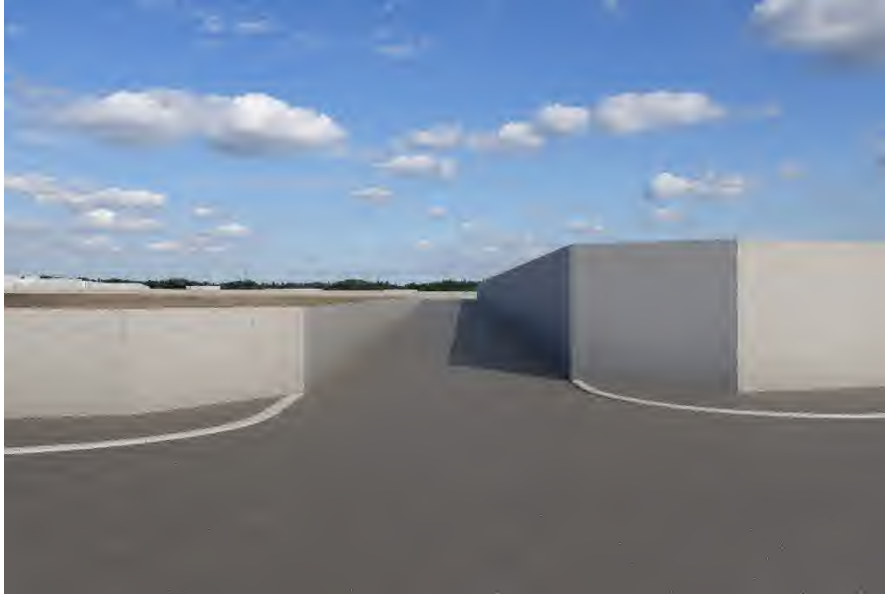
③ 環境保全措置の検討の状況

事業者の実行可能な範囲内でできる限り、環境影響を回避、低減又は代償することを目的として行った環境保全措置の検討の状況を、表 48-3 に示します。

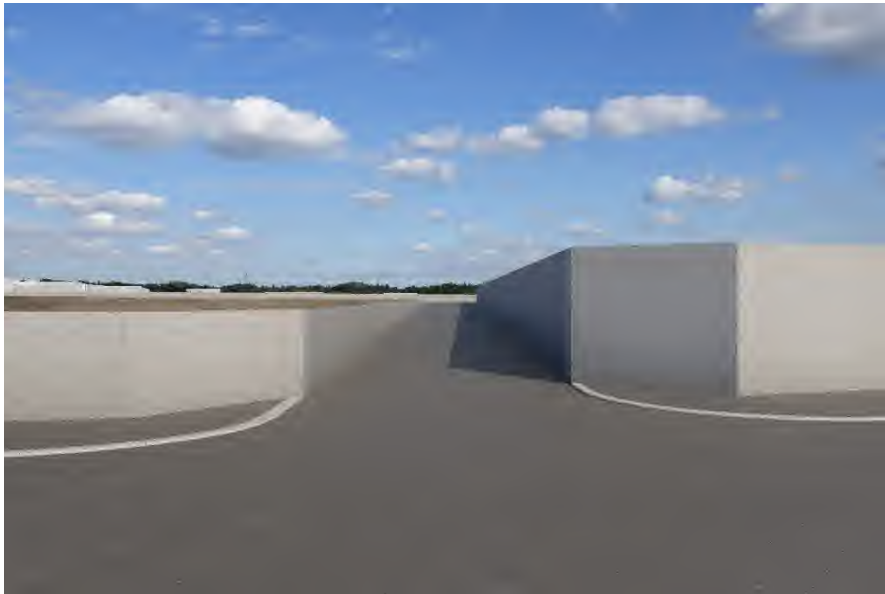
表 48-3 環境保全措置の検討の状況

環境保全措置	実施の適否	適否の理由
桜並木等の創出	適	消失する桜並木等の代償として、新たな桜並木等を創出することにより、景観への影響を低減できるため、適正な環境保全措置であると考えて採用します。
遠景の眺望に配慮した土地利用計画	適	丹沢山地や富士山が眺望できるように配慮した将来の土地利用計画を促し、景観への影響を軽減できるため、適正な環境保全措置であると考えて採用します。

④ 環境保全措置の実施主体、内容、効果の不確実性、他への影響

敷地の存在及び構造物の存在に伴う眺望点からの影響を低減させるため、表 48-4 に示すとりの環境保全措置を実施します。

表 48-4 環境保全措置の実施の内容

影響要因	影響	検討の視点	環境保全措置			実施主体	効果の不確実性	他の環境への影響
			内容	効果	区分			
在土及び地及び又は供は用工作物の存在	在敷存地の存在・構造物の景観への影響	緑地及び地形の保全	桜並木等の創出*	眺望景観、圍繞景観への影響が代償できます。	代償	事業者	なし	なし
			遠景の眺望に配慮した土地利用計画	眺望景観、圍繞景観への影響の低減が見込まれます。	低減	事業者	なし	なし

(3) 評価

① 環境保全措置の検討の状況

景観に係る環境影響が、事業者の実行可能な範囲内でできる限り回避され、又は低減されており、必要に応じその他の方法により環境の保全についての配慮が適正になされているかどうかについて、見解を明らかにすることにより、評価を行いました。

② 環境保全措置の検討の状況

眺望景観への影響の低減の適切な環境保全措置を講じることから、事業者の実行可能な範囲内でできる限り、環境影響の低減が図られると評価します。

なお、準備書 p.2-59にも記載のとおり、海軍道路の桜並木については、海軍道路の沿道関係者及び区民の方で構成する「海軍道路の桜並木に関する懇談会」を立ち上げ、現存する桜の残置や移植、伐採の考え方、新たに樹木を移植する場合の樹種の選定などについて、意見交換を行っています。

令和3年7月30日に「第1回 海軍道路の桜並木に関する懇談会」を開催し、海軍道路の桜並木の現状や課題、今後の方向性などについて、参加者と意見交換を行いました。「第2回 海軍道路の桜並木に関する懇談会」は現地説明会を実施しており、第3回以降では、具体的な樹種や整備イメージなどについて、参加者と意見交換を行っていく予定です。

また、地区全体で、土地利用計画の特性を活かした、対象事業実施区域及びその周辺部の緑・環境・景観に関する基本方針を検討していく中で、ご指摘をいただきました桜並木などの景観資源を含め、地区内道路からの新たな景観などについても考えていきたいと思えます。

49. 鎌倉古道の一部改変に伴う人と自然との触れ合いの活動の場への影響について

鎌倉古道については、「瀬谷ふるさと歴史さんぽ道ガイドマップ」で紹介されているハイキングコースのうち、「鎌倉古道 北コース」について予測評価を行っています。

「鎌倉古道 北コース」は、準備書 p.9.14-3「図 9.14-1 人と自然との触れ合いの活動の場の調査地点」又は本資料 11 ページの図 49-1 に示すように、海軍道路の桜並木や上瀬谷小学校周辺の道路、鎌倉古道・上道沿道にある神社仏閣等を巡るコースとなっています。

前回のご指摘も踏まえ、海軍道路の桜並木及びレクリエーション行動の変化への影響について、次のとおり予測評価を行いました。

(1) 予測・評価

a. 主要な人と自然との触れ合いの活動の場の改変の程度

「鎌倉古道 北コース」のうち、海軍道路の桜並木や上瀬谷小学校周辺の道路については対象事業実施区域に含まれています。そのため、海軍道路の桜並木の消滅や「鎌倉古道 北コース」の一部が変更される可能性があり、それにより活動の場の改変が起こり、レクリエーション行動への影響が生じると予測します。

b. 利用性の変化の程度

「鎌倉古道 北コース」のうち、海軍道路の桜並木や上瀬谷小学校周辺の道路については対象事業実施区域に含まれています。特に海軍道路は工事用車両及び関係車両が通行する予定ですが、工事中の海軍道路は歩道の整備が完了していない可能性があることや「鎌倉古道 北コース」の一部が変更される可能性があり、それにより利用性の変化が起こり、レクリエーション行動への影響が生じると予測します。

c. 快適性の変化の程度

「鎌倉古道 北コース」のうち、海軍道路の桜並木や上瀬谷小学校周辺の道路については対象事業実施区域に含まれています。そのため、海軍道路の桜並木の消滅や「鎌倉古道 北コース」の一部が変更される可能性があり、それにより快適性の変化が起こり、レクリエーション行動への影響が生じると予測します。

なお、「鎌倉古道 北コース」のうち、瀬谷駅や境川周辺のコースについては、工事用車両の主な運行ルート及び関係車両の主な走行ルートとなっていないため、「a. 主要な人と自然との触れ合いの活動の場の改変の程度」、「b. 利用性の変化の程度」、「c. 快適性の変化の程度」については、いずれも影響はないと予測します。

(2) 環境保全措置

環境保全措置としては、前述の“No. 48 桜並木の景観について”と同じように、海軍道路の桜並木が消滅することに対して“桜並木等の創出”を挙げています。(準備書 p. 9. 14-31 「表 9. 14-12 環境保全措置の実施の内容」)

桜並木等の創出時期については、今後、施工計画と併せて検討していきますが、なるべく早い時期に創出する計画とします。

なお、準備書 p. 2-59 にも記載の通り、海軍道路の桜並木については、海軍道路の沿道関係者及び区民の方で構成する「海軍道路の桜並木に関する懇談会」を立ち上げ、現存する桜の残置や移植、伐採の考え方、新たに樹木を移植する場合の樹種の選定などについて、意見交換を行っています。

令和3年7月30日に「第1回 海軍道路の桜並木に関する懇談会」を開催し、海軍道路の桜並木の現状や課題、今後の方向性などについて、参加者と意見交換を行いました。「第2回 海軍道路の桜並木に関する懇談会」は現地説明会を実施しており、第3回以降では、具体的な樹種や整備イメージなどについて、参加者と意見交換を行っていく予定です。

工事中に鎌倉古道 北コースの一部が変更されることに対しては、新たに“工事計画等の周辺住民への周知”を追加し、詳細な施工計画が決定した時や、工事期間中に施工計画の内容が変更になった時には、工事の内容や作業期間、アクセス路等について周辺住民の方へ周知を行い、影響が低減されるように、可能な限り情報公開を行っていきます。



図 49-1 工事用車両の主な運行ルート、関係車両の主な走行ルートとの重ね合わせ

50. 後背地との連続性に配慮した調整池について

地上式の調整池のうち、調整池1、5については、周辺を道路で囲まれた位置に配置することから、後背地との連続性に配慮した調整池とすることは困難であると考えています。

また、調整池2、6については、農業振興地区内に配置しますが、具体的な土地利用が決まっていないため、地権者と調整を図りながら検討していきます。

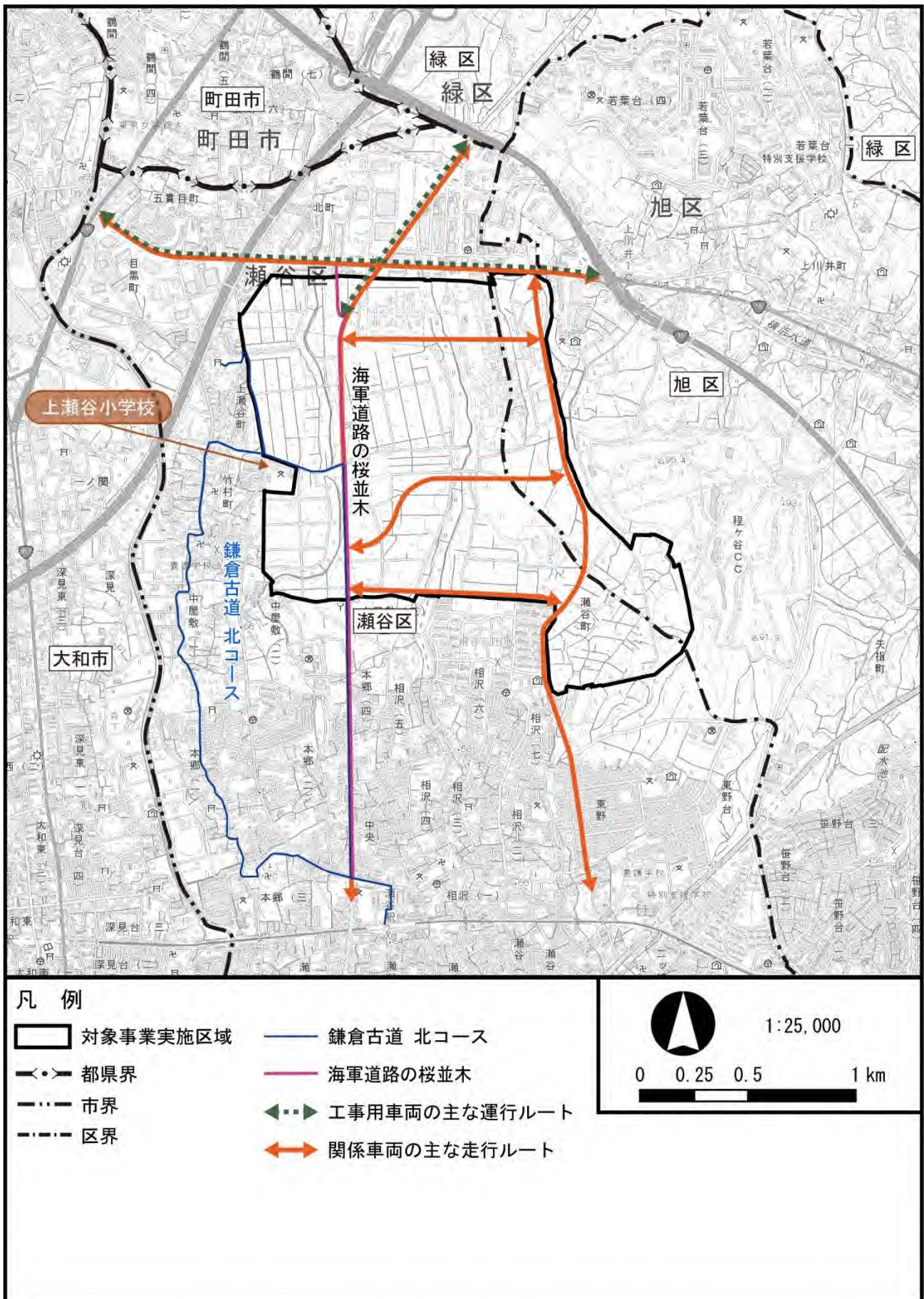
一方、公園区域内に整備する調整池4については、ホトケドジョウの生息環境と同じ和泉川流域において計画していることから、今後、公園整備事業等と調整を図りながら、現地形や自然豊かな環境をいかし、生息環境の創出に寄与するような調整池を検討していきます。

上記の考えを踏まえ、前回の審査会資料「27. 公益的施設用地内の調整池について」のうち、調整池4に係る記載を次の通り、見直しました。

<修正前>

地形や自然豊かな環境をいかし、環境に負荷の少ない調整池を検討

<修正後>

地形や自然豊かな環境をいかし、生息環境の創出に寄与するような調整池を検討

51. 鳥類のねぐら調査の時間帯について

鳥類のねぐら調査に係る調査日及び調査時間は、下表に示す通りです。

調査時間については、鳥類のねぐら入りは日の入り前後に行われることが多いこと、日の入り前に周辺の鳥類の群れの有無を把握することから、日の入りの概ね1時間半前から完全に日が暮れる時間帯となる日の入り30分後まで実施しました。

表 51-1 ねぐら調査の調査時期及び時間帯

調査時期	調査日	日の入り時刻	調査時間
秋季	令和2年11月2日	16:46	15:15～17:15
冬季	令和3年2月20日	17:28	15:45～18:00

調査結果について、審査会でのご指摘の通り、「秋季は群れの確認が早い時間帯であることから、ねぐらの位置は確認出来なかった。冬季は夕暮れ前後に群れを確認したが、滞留後に東方向に飛去していることから、ねぐらの位置は特定できなかった。」と修正します。

準備書表 9.10-9 (P9.10-25) の確認状況は以下の通り修正し、図 9.10-3 (P9.10-26) は削除します。

<修正前>

調査時期	確認日時	個体数	確認状況
秋季	11/2 (月) 15:18～ 15:20	100 個体程度	現地調査の結果、ムクドリ <small>の</small> 群れを1群確認した。 確認位置は、上瀬谷旧通信施設北西側の畑の上空であり、100 個体程度の群れが上空を数回旋回し、その後、大門川沿いの樹林と草本の茂み方向に飛翔し、見失った。 <u>その後、再度飛翔する群れは見られなかったことから、大門川沿いの樹林をねぐらとして利用しているものと考えられる。</u> なお、旧通信施設中央部及び東側では、ねぐら入りする鳥類の集団は確認できなかった。
冬季	2/20 (土) 17:00～ 17:34	80 個体程度	現地調査の結果、ムクドリ <small>の</small> 群れ1群を確認した。 ムクドリ <small>の</small> 群れの確認位置は、海軍道路沿いの桜並木であり、樹上に泊まっている80 個体程度のムクドリ <small>の</small> 群れを確認した。その後、日の入り時刻まで桜並木に滞留した後、東方向に飛翔し、見失った。 なお、旧通信施設中央部及び東側では、ねぐら入りする鳥類の集団は確認できなかった。

<修正後>

調査時期/時間	確認日時	個体数	確認状況
秋季 15:15～ 17:15	11/2 (月) 15:18～ 15:20	100 個体程度	現地調査の結果、昼間の時間帯にムクドリ <small>の</small> 群れを1群確認した。 確認位置は、上瀬谷旧通信施設北西側の畑の上空であり、100 個体程度の群れが上空を数回旋回し、その後、大門川沿いの樹林と草本の茂み方向に飛翔し、見失った。 <u>夕暮れ前後には群れを確認することが出来なかったため、ねぐらの位置は確認できなかった。</u>
冬季 15:45～ 18:00	2/20 (土) 17:00～ 17:34	80 個体程度	現地調査の結果、ムクドリ <small>の</small> 群れ1群を確認した。 ムクドリ <small>の</small> 群れの確認位置は、海軍道路沿いの桜並木であり、樹上に泊まっている80 個体程度のムクドリ <small>の</small> 群れを確認した。その後、日の入り時刻まで桜並木に滞留した後、東方向に飛翔し、見失った。 <u>夕暮れ前後に群れを確認したが、ねぐらの位置は特定できなかった。</u>

52. 大門川及び相沢川を暗渠化した理由及び経緯

<暗渠化した理由>

地区内の大門川については、農業振興地区の勾配をできる限り少なくし、効率的に農地を利用できるよう暗渠化し切り回しを行い、また地区内の相沢川については、観光・賑わい地区と物流地区の一体的な宅地としての利用を促進するために、暗渠化し切り回しを行う予定です。

暗渠化計画にあたっての環境保全としては、大門川と相沢川ともに、水の汚れのモニタリングを行い、環境基準に適合しない結果となった場合には、適切な環境保全措置を講じることとしています。また動植物や生態系における環境保全措置である「保全対象種の生息環境の創出」について、対象事業実施区域北部の相沢川沿いの環境をモデルに、南側の公園区域内に、概ね 1.5ha のエリアで、現在の土地利用や現地形をいかし、湿地、草地、水路、樹林等を確保する計画としています。

暗渠化計画にあたっての経済性については、農業振興地区内の農地の傾斜改善や、観光・賑わい地区と物流地区の一体的な宅地としての利用により、現在よりも土地の利用価値は上がると考えられます。

暗渠化計画にあたっての地域社会への影響については、暗渠化した水路を活用することは難しいですが、保全対象種の生息環境を創出する場において、地域の方々や子供たちの環境学習の場としての活用していくことなどについて、今後検討を行っていきます。

なお、農業振興地区においては、賑わい施設などと連携した農作物の収穫体験や、滞りながら農の魅力を楽しむ農体験など、新たな都市農業モデルとなる拠点の形成を図ることとしていますが、環境学習の場や市民菜園などといった具体的な活用方法は、今後、地権者との話し合いの中で決まっていくこととなります。

<経緯>

方法書段階では、本事業が農業振興と都市的土地利用を行う土地を集約し、農業基盤や道路などの都市基盤の整備を一体的に推進するため、対象事業実施区域全域について土地の改変を行う計画だったため、大門川及び相沢川は、改修等が行われる可能性がある旨、ご説明をさせていただきました。

その後、土地利用の検討を進めていく中で、地権者の意向を踏まえ、まとまった土地利用の実現や平坦な農地環境の創出に向け、相沢川及び大門川については、道路の下に切り回し、暗渠化する計画となったため、準備書にその旨、記載をさせていただきました。

従って、方法書段階では、環境影響評価項目として、「公共用水域の底質」「河川の形態、流量」を選定し、準備書段階では、河川改修の手法として、切り回しを行い暗渠化する計画である旨、記載し、予測及び評価を行いました。

53. 国内における暗渠化の事例について

①長久手中央土地区画整理事業（愛知県長久手市）

長久手市では、2005年に自然の叡智をテーマとした愛・地球博が開催され、それに伴う東部丘陵線（リニモ）の開通等により交通の利便性が向上しました。長久手中央土地区画整理事業は、その沿線にある長久手古戦場駅周辺に立地しています。

事業名 長久手中央土地区画整理事業

場所 愛知県長久手市

最寄り駅 愛知高速交通株式会社

東部丘陵線（リニモ）

長久手古戦場駅

施工面積 27.4ha

河川の暗渠化範囲

右図の「河川改修」として
いる範囲（L=約0.4km）

経過 2010年7月組合設立

2011年4月着工

2012年10月仮換地指定

2021年度中に換地処分予定



②帷子川プロムナード計画

帷子川の上流部(日影橋～前山橋)に位置する横浜市旭区において、地域の要望もあり、河川改修に伴い廃川となった延長約1km、幅8～10mの旧河道を活用したプロムナード整備を進めています。

旧河道には、地先排水雨水管からの流入があるため、それらを流す機能を有する下水道管(ボックスカルバート)を河床レベルに設置したうえで、旧河道全体を周辺地盤と同程度の高さまで埋め戻すことで、プロムナードの基盤を生成し、その後、上部を公園(緑道)として整備する計画です。



54. 相沢川の谷戸環境について

相沢川の切り回し及び暗渠化に伴い、北側の谷戸環境については、図 54-1 に示すとおり造成工事を行う予定です。

量的に相沢川沿いの現環境を確保することは困難であるため、相沢川沿いのうち、水田、休耕田、水路及び樹林が一体となった対象事業実施区域北部の環境をモデル地域として、同様の谷戸地域である対象事業実施区域の南側を動植物などにおける環境保全措置である「保全対象種の生息環境の創出」を行うエリアとし、現況の地形及び土地利用をいかし、新たに湿地、草地、水路、樹林等を創出する計画です。

また、図 54-3 に示したとおり、水路、草地、湿地、樹林という環境区分を連続的に推移させることで、様々なハビタットタイプの保全対象種が生息・生育できる環境を創出します。

なお、農業振興地区は、将来も営農継続を希望している地権者を中心に、新たな都市農業を行うエリアであり、営農継続を希望している地権者全員の換地先が農業振興地区となる様、調整を進めているところです。ただし、相沢川の谷戸環境にある水田を含め、対象事業実施区域内の全ての水田については、地権者との話し合いを踏まえ、将来残さない方向で検討が進められています。



図 54-1 切土・盛土の状況



図 54-2 土地利用現況図

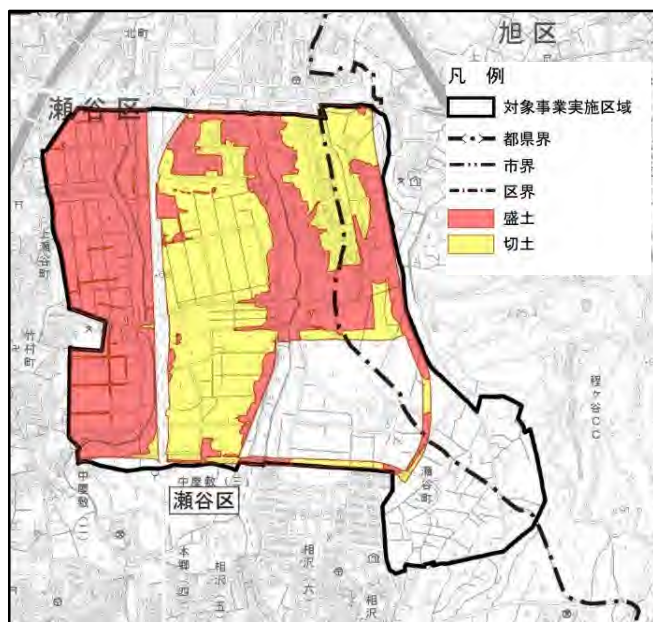

図 54-3 環境保全措置のイメージ

旧上瀬谷通信施設地区土地区画整理事業 環境影響評価に関する補足資料

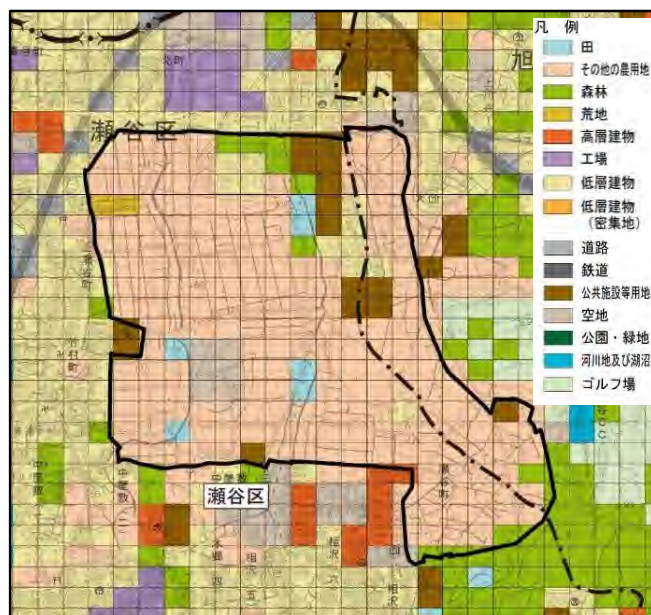
<補足資料内容>

55. 動植物の調査方法、調査地点について
56. 農業振興地区の生態系機能を踏まえた予測評価について
57. 大門川の暗渠化による影響等について
58. 桜並木の景観について（継続）
59. 鎌倉古道の一部改変に伴う人と自然との触れ合いの活動の場への影響について（継続）
60. 盛土の高さについて
61. 調整池4を地上式とした場合の影響について
62. 公益的施設用地における防災機能について

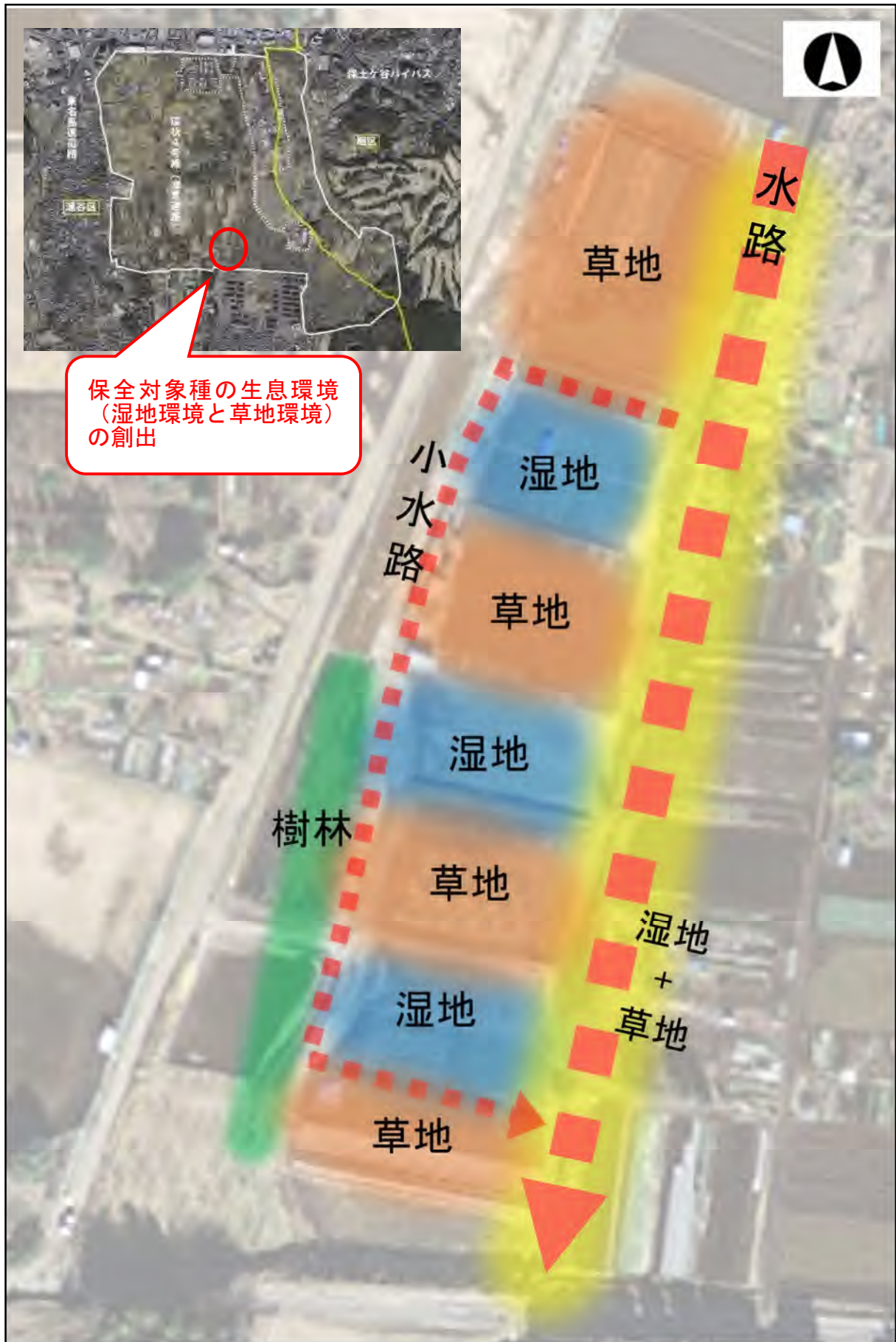
令和3年11月

横浜市

55. 動植物の調査方法、調査地点について

動物の調査手法については、事業特性及び地域特性を踏まえて「面整備事業環境影響評価技術マニュアルⅡ」（面整備事業環境影響評価研究会 平成11年11月）及び「横浜市環境影響評価技術指針」（横浜市 平成23年6月）を参考に選定し、方法書及び準備書に示すとおり実施しました。

調査にあたっては、文献調査等の事前調査により把握した環境条件及び生息・生育が想定される動物・植物の確認に十分留意するとともに、調査方法や調査地点等については、平成31年1月、4月、令和2年6月に実施した有識者ヒアリングを踏まえて、設定しました。

動物の踏査ルートは、動物の生息状況を把握できるように調査範囲内を網羅的に踏査することを基本に、分類群ごとの生息好適環境を踏まえ、効率的なルートを設定しました。また、調査地点は、調査地域の環境条件や調査結果を踏まえ、代表的な環境であると考えられる地点に設定しました。

植物の踏査ルートは、調査範囲内を網羅的に踏査することを基本に、林内・林縁部、河川、草地、低地の水田周辺等において重要種が確認される可能性が高いと考えられたことから、これらの環境に着目して調査を実施しました。

準備書の作成にあたっては、第14回審査会（令和3年10月27日）で意見陳述をされた市民団体の方々に、令和2年10月には活動内容や瀬谷の環境、確認された動植物等について情報をいただくとともに、11月には相沢川周辺を中心に現地を案内いただきました。

その結果からも、調査方法や調査地点については問題ないと考えたため、準備書を作成し、有識者からのヒアリング内容として、準備書表8.3-1（p.8-80～82）、表9.10-30(1)～(5)（p.9.10-94～98）及び表9.11-14（p.9.11-33）に記載し、市民団体からのヒアリング内容として、準備書表9.10-30(6)（p.9.10-99）に記載しています。

調査は方法書に記載した内容を踏まえて適切に実施したと考えていますが、意見陳述人から提供された種（写真）のうち、これまでに実施した現地調査で確認されていない種も対象事業実施区域及びその周辺に生息・生育する可能性があるかと認識しています。今後の事後調査において、意見陳述人から提供された種にも留意して工事中に調査を実施するとともに、意見陳述人から提供されて調査で確認されていない重要な種が確認された場合には、準備書に示した環境保全措置により適切に対応します。

意見陳述人より写真及び確認位置の情報提供があった哺乳類、鳥類、両生類及び爬虫類、底生動物、植物の調査方法及び調査地点の考え方は次ページ以降に示すとおりです。

また、意見陳述人より提供された環境の写真撮影位置は、図55-8に示すとおりで、動植物の踏査ルートに含まれています。

①哺乳類

哺乳類の現地調査は、準備書 表 9.10-1 (p.9.10-1) に示すとおり、任意観察及びフィールドサイン法、トラップ法、無人撮影法、夜間調査により実施しました。

トラップ法及び無人撮影法の調査地点と選定理由は、表 55-1 及び図 55-1 に示すとおりです。

調査にあたっては、以下の環境において重要な種が確認される可能性が高いと考えられるため、これらの環境に着目して調査を実施しました。

- 市民の森から連続する樹林及び調査地内に点在する広葉樹林の林内、林縁部（キツネ・イタチ等）、樹林及び囲障区域建物周辺（コウモリ類）
- 畑地及び周辺の高径草地（モグラ・カヤネズミ・ハタネズミ）

カヤネズミについては、調査範囲内に畑地及び周辺の高茎草地がみられることから、確認される可能性が高いと考え、任意に調査を実施しました。調査方法は、任意観察法によるフィールドサイン（球巣）の確認をしましたが、現地調査では確認されませんでした。

なお、評価書にカヤネズミに留意して調査を実施した旨、記載します。

表 55-1 調査地点の選定理由(哺乳類)

調査地点	位置・環境	選定理由
哺乳類 1	対象事業実施区域北側 耕作地・湿地	対象事業実施区域北側の耕作地・草地・湿地の分布する調査地点であり、近傍には相沢川が流下している。湿性環境は主に河川沿いの水田及び休耕地が分布している。 調査地域北側の河川周辺の耕作地、谷戸の湿性環境を代表する地点として選定。
哺乳類 2	対象事業実施区域北側 樹林地	対象事業実施区域北側の樹林（落葉広葉樹林）に位置する調査地点であり、対象事業実施区域の樹林のうち、哺乳類の生息環境として比較的良好な環境を形成している樹林であり、調査地域の樹林地を代表する地点として選定。
哺乳類 3	対象事業実施区域西側 耕作地	対象事業実施区域西側の耕作地に位置する調査地点である。 果樹園に近接しており、哺乳類が採餌環境として利用することも考えられる。 調査地域西側の耕作地環境を代表する地点として選定。
哺乳類 4	対象事業実施区域南側 草地	対象事業実施区域南側の草地の分布する地点であり、近傍では植木の栽培等が行われている。 調査地域の草地環境を代表する地点として選定。
哺乳類 5	対象事業実施区域西側 草地	対象事業実施区域西側の草地の広く分布する地点である。 草地が広く分布しており、調査地域の草地環境を代表する地点として選定。
哺乳類 6	対象事業実施区域南東側 樹林	対象事業実施区域南東側の樹林（スギ植林）に位置する地点であり、上瀬谷市民の森と連続した樹林環境を形成している。 調査地域の樹林地を代表する地点として選定。
哺乳類 7	対象事業実施区域北側 囲障区域内	対象事業実施区域北側の旧米軍宿舎の存在する地点である。 宿舎が利用されなくなり、長期間が経過していること、植栽地には草本が繁茂していることから、小・中型哺乳類の生息も考えられる。



図 55-1 現地調査地点及びルートと意見陳述人提供写真の位置関係(哺乳類)

②鳥類

鳥類の現地調査は、準備書 表 9.10-1 (p.9.10-2) に示すとおり、任意観察法、ラインセンサス法、定点観察法、ねぐら調査、夜間調査（フクロウ類・夜行性鳥類）、定点観察法（猛禽類）により実施しました。

ラインセンサスルート、定点調査、猛禽類調査の対象事業実施区域内の調査地点と選定理由は、表 55-2～55-4 及び図 55-2 に示すとおりです。

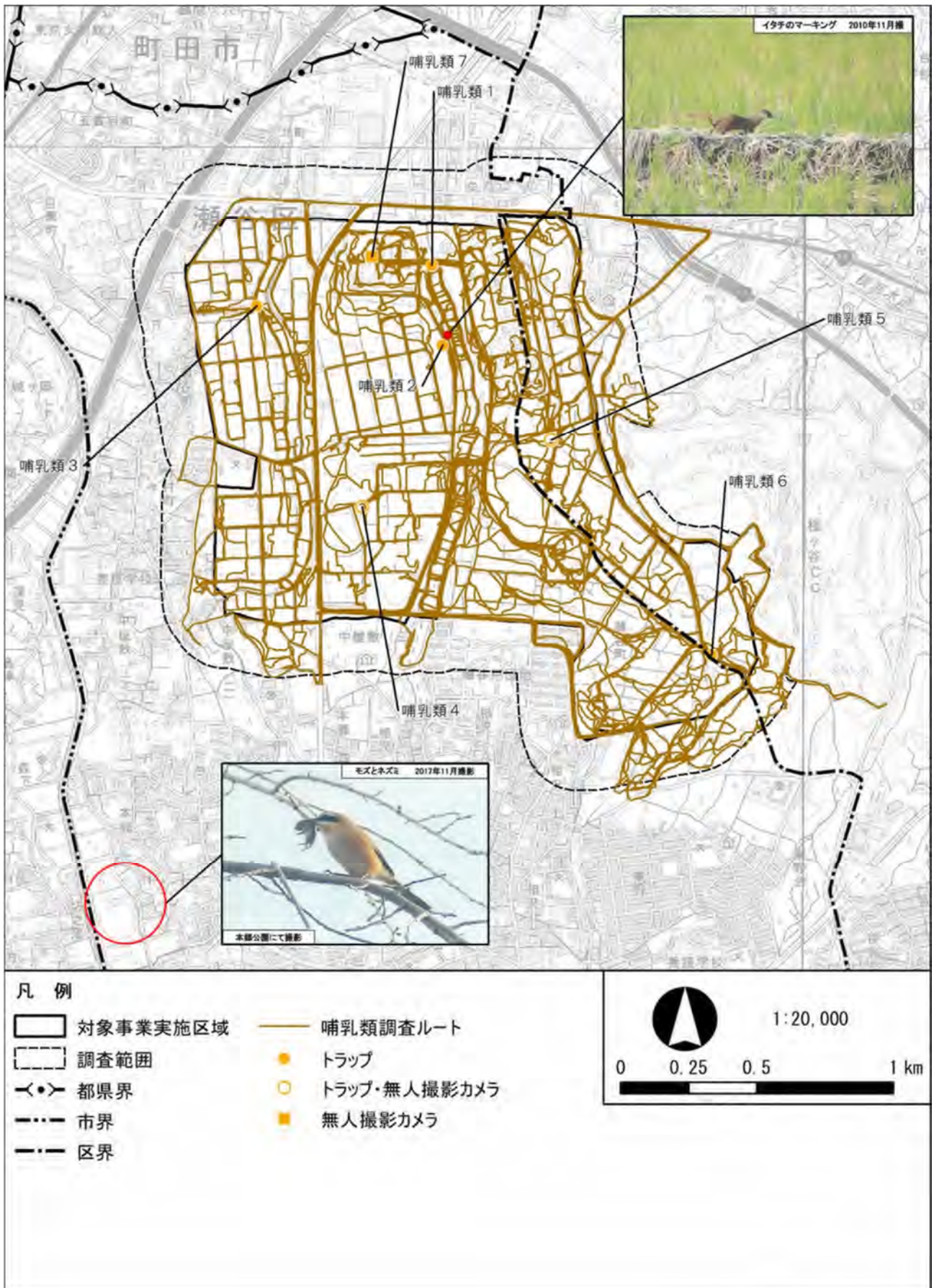
調査にあたっては、以下の環境において重要な種が確認される可能性が高いと考えられるため、これらの環境に着目して調査を実施しました。

- 市民の森から連続する樹林（猛禽類、フクロウ類、アカハラ等）
- 調査地内に点在する広葉樹林、困障区域内的の樹林（フクロウ類、キビタキ、ツグミ類等）
- 河川沿いの湿地（サギ類、シギ類）
- 畑地等（ヒバリ）
- 畑地周辺及び河川沿いの後継草地（オオヨシキリ、セッカ等）

表 55-2 ラインセンサスルートの選定理由（鳥類）

ルート	選定理由
対象事業実施区域南東ルート	対象事業実施区域南東側を巡回するルートであり、対象事業実施区域に広がる草地、耕作地及び上瀬谷市民の森に続く樹林（スギ植林）を通過する。草地・畑地性鳥類及び平地の樹林性鳥類の確認を主目的として設定。
対象事業実施区域縦断ルート	対象事業実施区域を南北に縦断するルートであり、対象事業実施区域内に点在する樹林（落葉広葉樹）、植栽樹群、河川沿いの水田、耕作地、河川や耕作地脇の高径草地を通過する。水鳥、草地・畑地性鳥類、平地の樹林性鳥類の確認を主目的として設定。
対象事業実施区域西ルート	対象事業実施区域西側を巡回するルートであり、西側に隣接した畑地環境を通過する。畑地性鳥類の確認を主目的として設定。

表 55-3 定点調査地点の選定理由（鳥類）

調査地点	位置	選定理由
一般鳥類 1	対象事業実施区域北側	対象事業実施区域の北側を見渡せる定点であり、定点南側の広葉樹林、河川及び河川沿いの水田・草地、困障区域の樹林に生息する鳥類の確認を主目的として設定。
一般鳥類 2	対象事業実施区域南西側	対象事業実施区域の南西側を見渡せる定点であり、定点南側の畑地、定点西側の草地及び畑地に生息する鳥類の確認を主目的として設定。
一般鳥類 3	対象事業実施区域南東側	対象事業実施区域の南東側及び瀬谷市民の森が見渡せる定点であり、定点西側の草地及び畑地、定点東側の樹林性鳥類の確認を主目的として設定。

表 55-4 猛禽類調査地点の選定理由(鳥類)

調査地点	位置	選定理由
猛禽類 1	対象事業実施区域北側	対象事業実施区域の北側を東西に見渡せる定点であり、定点東側の広葉樹林(繁殖地・餌場)や定点周辺の畑地等(餌場)に出現する猛禽類の確認を主目的として設定。
猛禽類 2	対象事業実施区域南西側	対象事業実施区域の南西側を見渡せる定点であり、定点周辺の畑地、草地等に出現する猛禽類の確認を主目的として設定。
猛禽類 3	対象事業実施区域南東側	対象事業実施区域の南東側及び瀬谷市民の森が見渡せる定点であり、定点西側の草地及び畑地、定点東側の樹林性鳥類の確認を主目的として設定。
猛禽類 4	対象事業実施区域東側	対象事業実施区域の東側及び南側を見渡せる定点であり、定点周辺の草地、畑地及び樹林地、対象事業実施区域外東側の樹林地から出現する猛禽類の確認を主目的として設定。



図 55-2 現地調査地点及びルートと意見陳述人提供写真の位置関係(鳥類)

③両生類及び爬虫類

両生類及び爬虫類の現地調査は、準備書 表 9.10-1 (p. 9.10-2) に示すとおり、任意観察及び任意採取法、夜間調査により実施しました。

調査にあたっては、以下の環境において重要な種が確認される可能性が高いと考えられるため、これらの環境に着目して調査を実施しました。

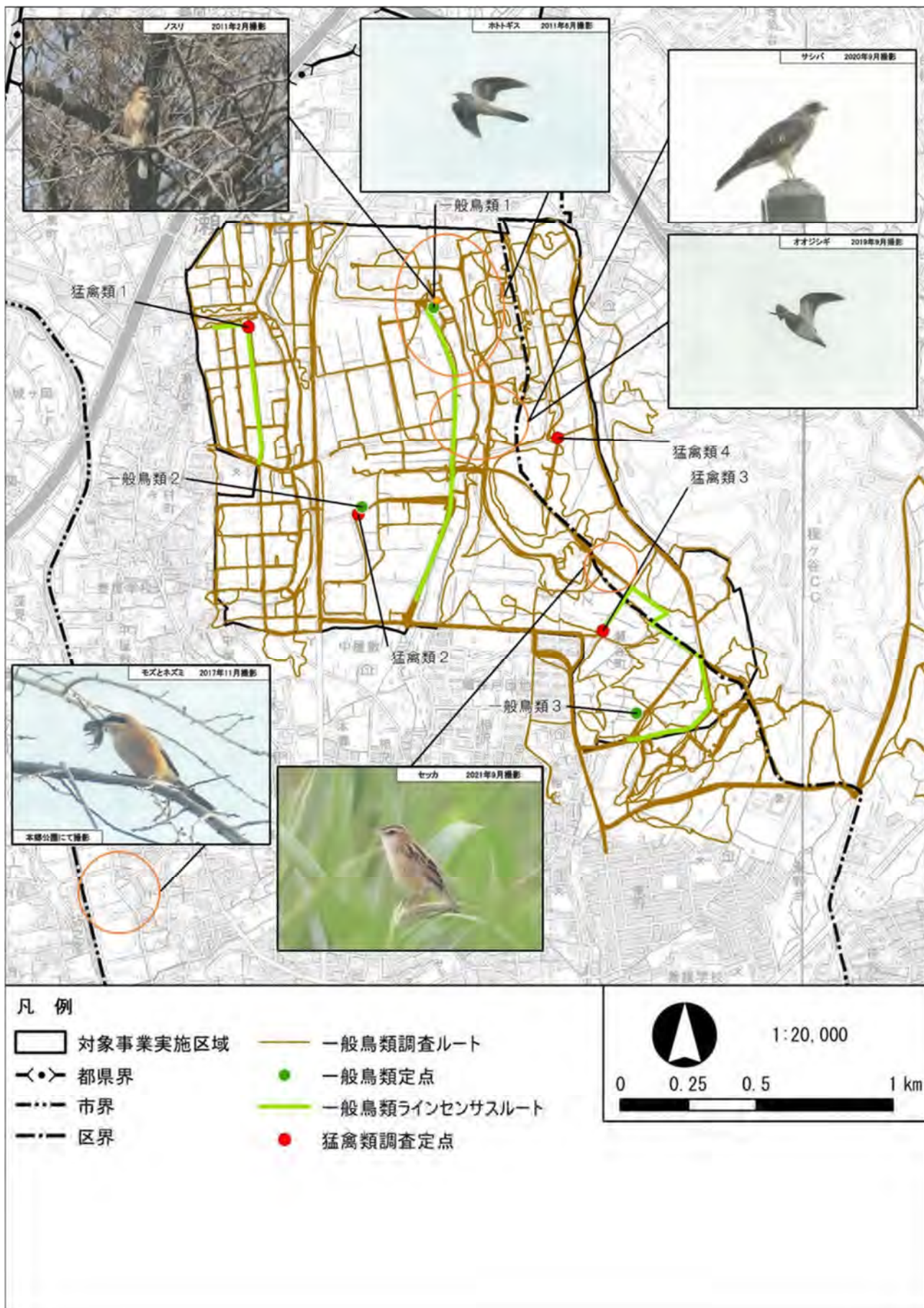
- 市民の森から連続する樹林（ニホンアカガエル、ヒキガエル、ヤマカガシ、マムシ等）
- 調査地内に点在する広葉樹林、困障区域内的の樹林（ヒキガエル、アオダイショウ等）
- 河川沿いの水田・湿地（イモリ、トノサマガエル、トウキョウダルマガエル、シマヘビ等）
- 畑地周辺及び河川沿いの後継草地（アオダイショウ等）



図 55-3 現地調査ルートと意見陳述人提供写真の位置関係(両生類及び爬虫類)

④底生動物

底生動物の現地調査は、準備書 表 9.10-1 (p. 9.10-3) に示すとおり、任意観察法及び任意採取法、定量調査により実施しました。

調査地点と選定理由は、表 55-5 及び図 55-4 に示すとおりです。

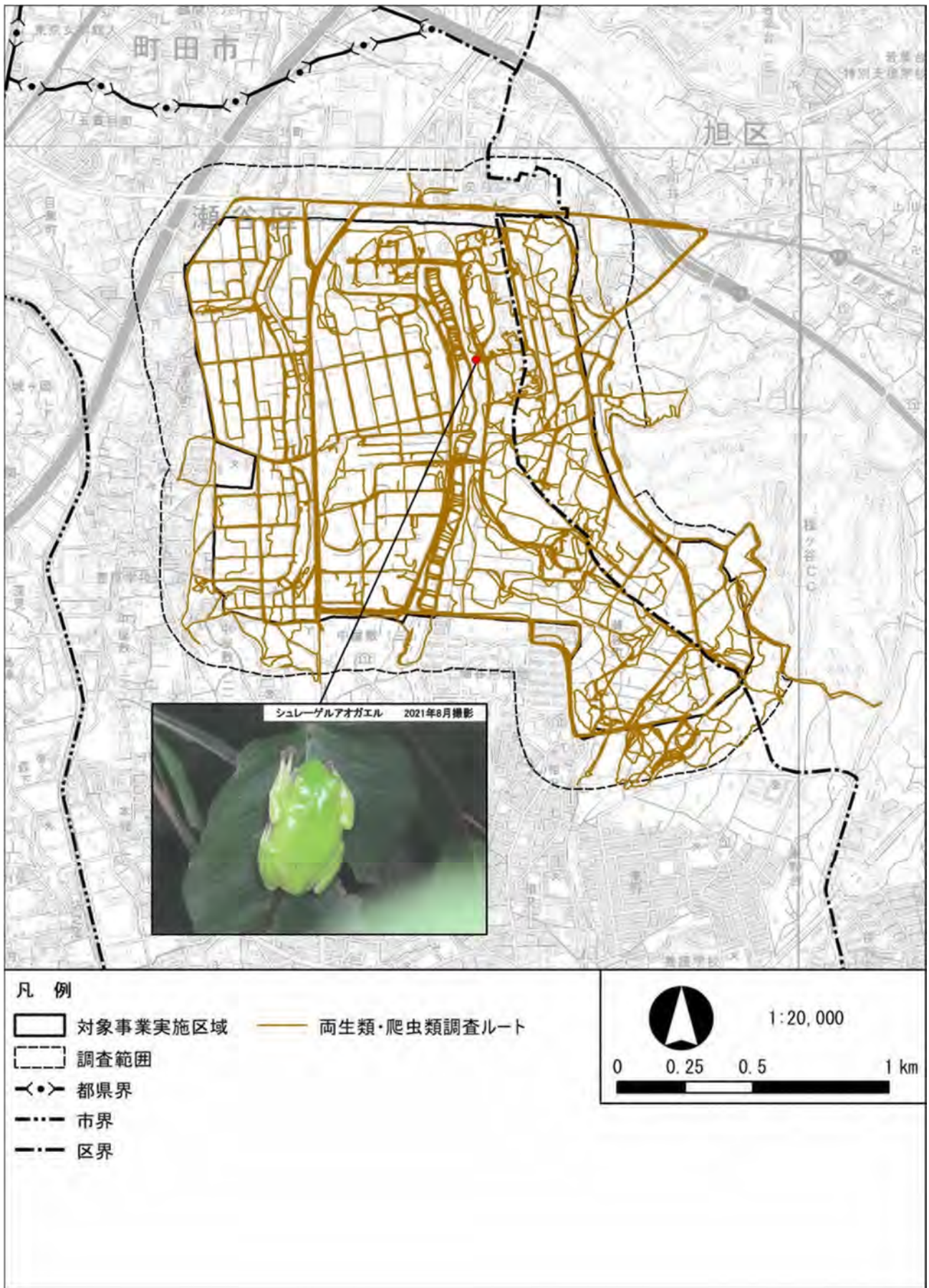
調査にあたっては、以下の環境において重要な種が確認される可能性が高いと考えられるため、これらの環境に着目して調査を実施しました。

○河川の緩流域・淀み（ゲンゴロウ類・モノアラガイ等）

○未護岸の比較的水質が良好な水域（ヘイケボタル）・湧水の源流付近（カゲロウ類・カワゲラ類・ゲンジボタル等）

表 55-5 調査地点の選定理由(底生動物)

調査地点	概略位置	選定理由
底生動物 1-1	大門川下流	対象事業実施区域内西側を北から南に流下する河川。調査地域に該当する水域の下流側を代表する地点として選定。調査地域内の水域のほぼ全域が三面張りのコンクリート護岸である。
底生動物 1-2	大門川上流	対象事業実施区域内西側を北から南に流下する河川。調査地域に該当する水域の上流側を代表する地点として選定。調査地域内の水域のほぼ全域が三面張りのコンクリート護岸である。
底生動物 2-1	相沢川下流	対象事業実施区域内東側を北から南に流下する河川。調査地域に該当する水域の下流側を代表する地点として選定。調査地域内の水域のほぼ全域が三面張りのコンクリート護岸である。
底生動物 2-2	相沢川上流	対象事業実施区域内東側を北から南に流下する河川。調査地域に該当する水域の上流側（水門より上流）を代表する地点として選定。調査地域内の水域のほぼ全域が三面張りのコンクリート護岸である。
底生動物 3-1	和泉川 源流部西	対象事業実施区域南東側の和泉川源流域のうち、西側にあたる水域である。 河川は護岸されておらず、比較的良好な自然環境である。
底生動物 3-2	和泉川 源流部東	対象事業実施区域南東側の和泉川源流域のうち、東側にあたる水域である。 河川は護岸されていないが、河川流量は少ない。
底生動物 4	堀谷戸川	対象事業実施区域の東側（計画地外：計画地から 200m 以内）を流下する河川。 三面張りのコンクリート護岸であり、水量も比較的少ない。



図 55-4 現地調査地点と意見陳述人提供写真の位置関係(底生動物)

⑤植物

植物（植物相）の現地調査は、準備書 表 9.11-1 (p.9.10-1) に示すとおり、維管束植物、付着藻類、蘚苔類及び植物群落について実施しました。調査方法は、主に任意観察及び採取により実施し、付着藻類については定量採集も実施しました。

維管束植物の現地調査ルートは、図 55-5 に示すとおりです。

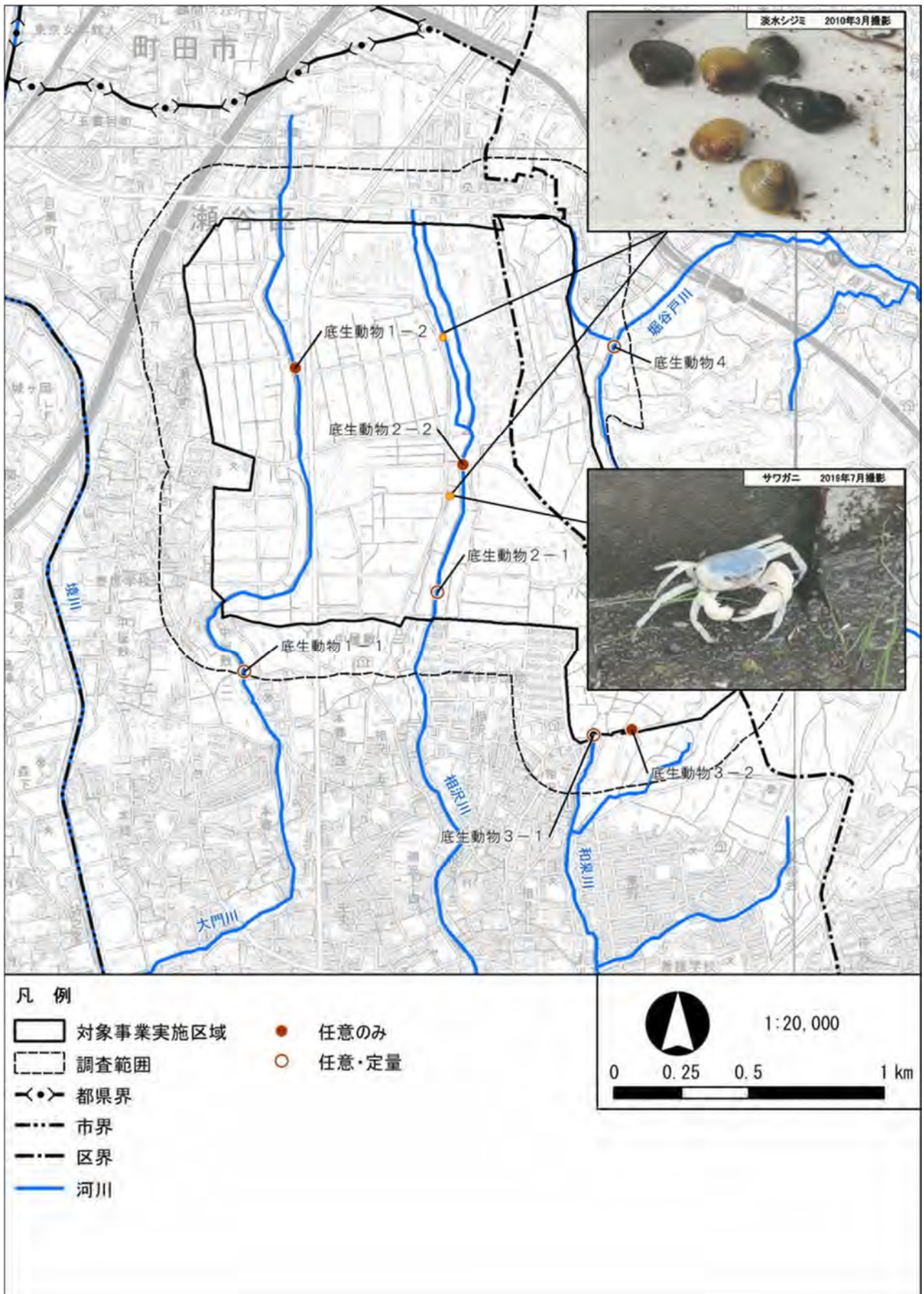
調査にあたっては、以下の環境において重要な種が確認される可能性が高いと考えられるため、これらの環境に着目して調査を実施しました。

- 林内、林縁部（ラン科植物、フクジュソウ等）
- 河川（抽水植物・湿性植物）
- 草地（スゲ・イネ科植物）
- 低地の水田周辺（ミゾコウジュ等水田雑草）

付着藻類の調査地点と選定理由は、表 55-6、図 55-5 及び図 55-7 に示すとおりです。

調査にあたっては、以下の環境において重要な種が確認される可能性が高いと考えられるため、これらの環境に着目して調査を実施しました。

- 河川源流部の湧水（和泉川・相沢川等）（カワモズク等の大型紅藻類）

表 55-6 調査地点の選定理由(付着藻類)

調査地点	位置	選定理由
付着藻類 1	大門川 下流	対象事業実施区域内西側を北から南に流下する河川。 調査地域に該当する水域を代表する地点として選定。 調査地域内の水域のほぼ全域が三面張りのコンクリート護岸である。
付着藻類 2	相沢川 下流	対象事業実施区域内東側を北から南に流下する河川。 調査地域に該当する水域を代表する地点として選定。 調査地域内の水域のほぼ全域が三面張りのコンクリート護岸である。
付着藻類 3	和泉川 源流部西	対象事業実施区域南東側の和泉川源流域のうち、西側にあたる水域である。 河川は護岸されておらず、比較的良好な自然環境である。
付着藻類 4	堀谷戸川	対象事業実施区域の東側（対象事業実施区域外：対象事業実施区域から 200m 以内）を流下する河川。 三面張りのコンクリート護岸であり、水量も比較的少ない。

蘚苔類の現地調査ルートは、図 55-5 に示すとおりです。

調査にあたっては、以下の環境において重要な種が確認される可能性が高いと考えられるため、これらの環境に着目して調査を実施しました。

- 日当たりの少ない湿潤な樹林地（蘚苔類生育の好適環境）
- 水田・ため池の周辺（同上）
- 農薬等の流入のない湿地（止水環境）（イチョウウキゴケ）

植物群落の調査地点は、図 55-5 及び図 55-7 に示すとおりです。

植物群落の現地調査は、準備書 表 9.11-2 (p. 9.10-1) に示すとおり、植物社会学的手法により実施し、調査地点は、既存の現存植生図及び航空写真等から、相観的な植物群落を区分し、これらの植生区分毎に、一定の方形枠(コドラート)を 1～数カ所設定しました。現地調査結果より作成した現存植生図は、図 55-6 に示すとおりです。

上記の調査より、重要な種が確認された現地での環境を水田、河川、休耕田、草地、樹林等に分類し、影響予測を行っています。

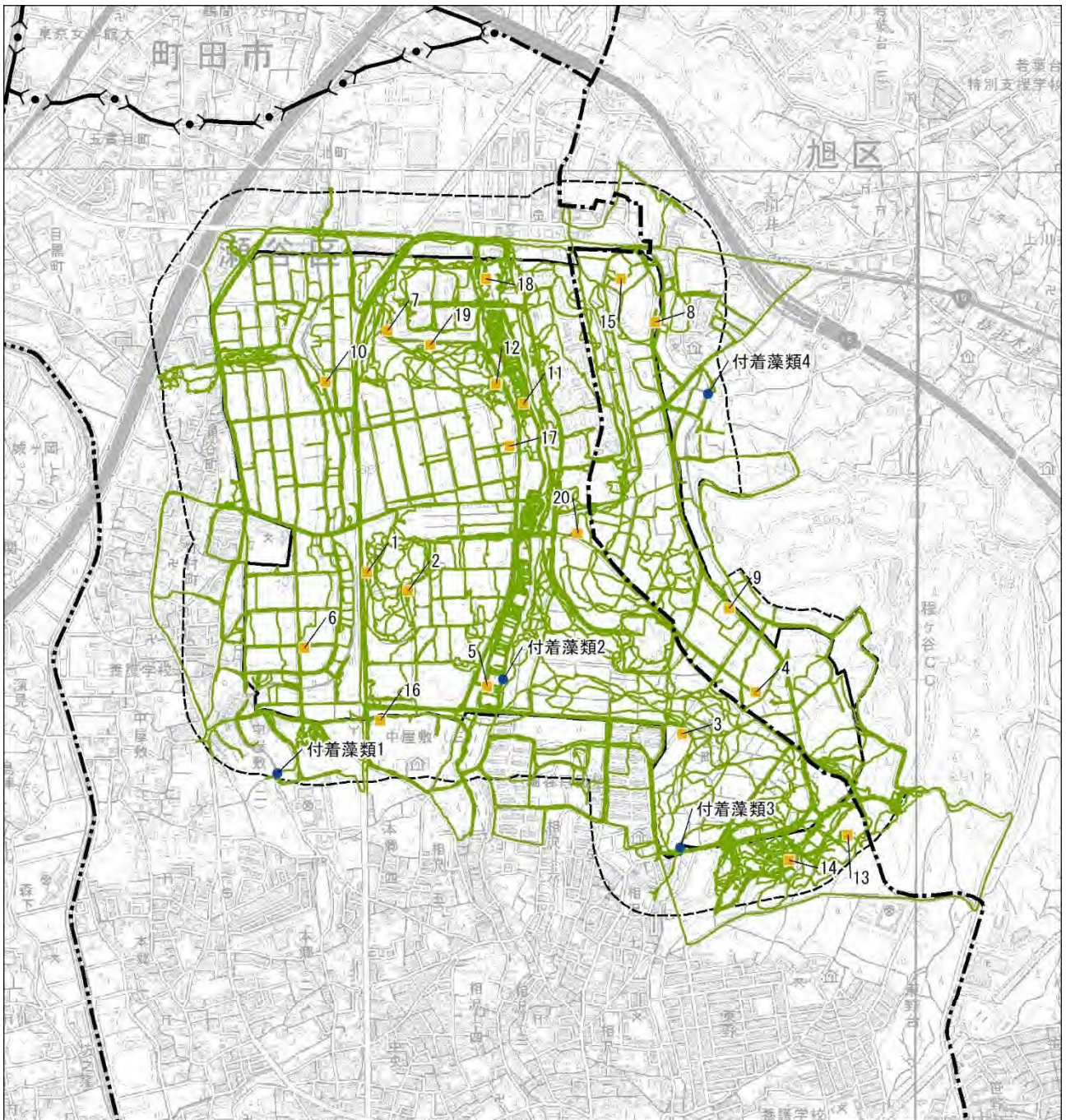

凡例

- 対象事業実施区域
- 調査範囲
- 都県界
- 市界
- 区界
- 植物踏査ルート
- 植物群落(コドラート)
- 付着藻類(任意・定量)



図 55-5 現地調査地点及び踏査ルート(植物)



凡例

- 対象事業実施区域
- 調査範囲
- 都県界
- 市界
- 区界

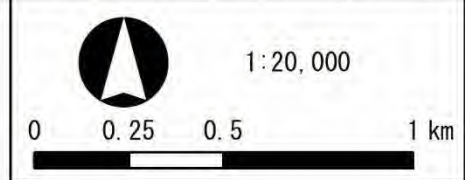
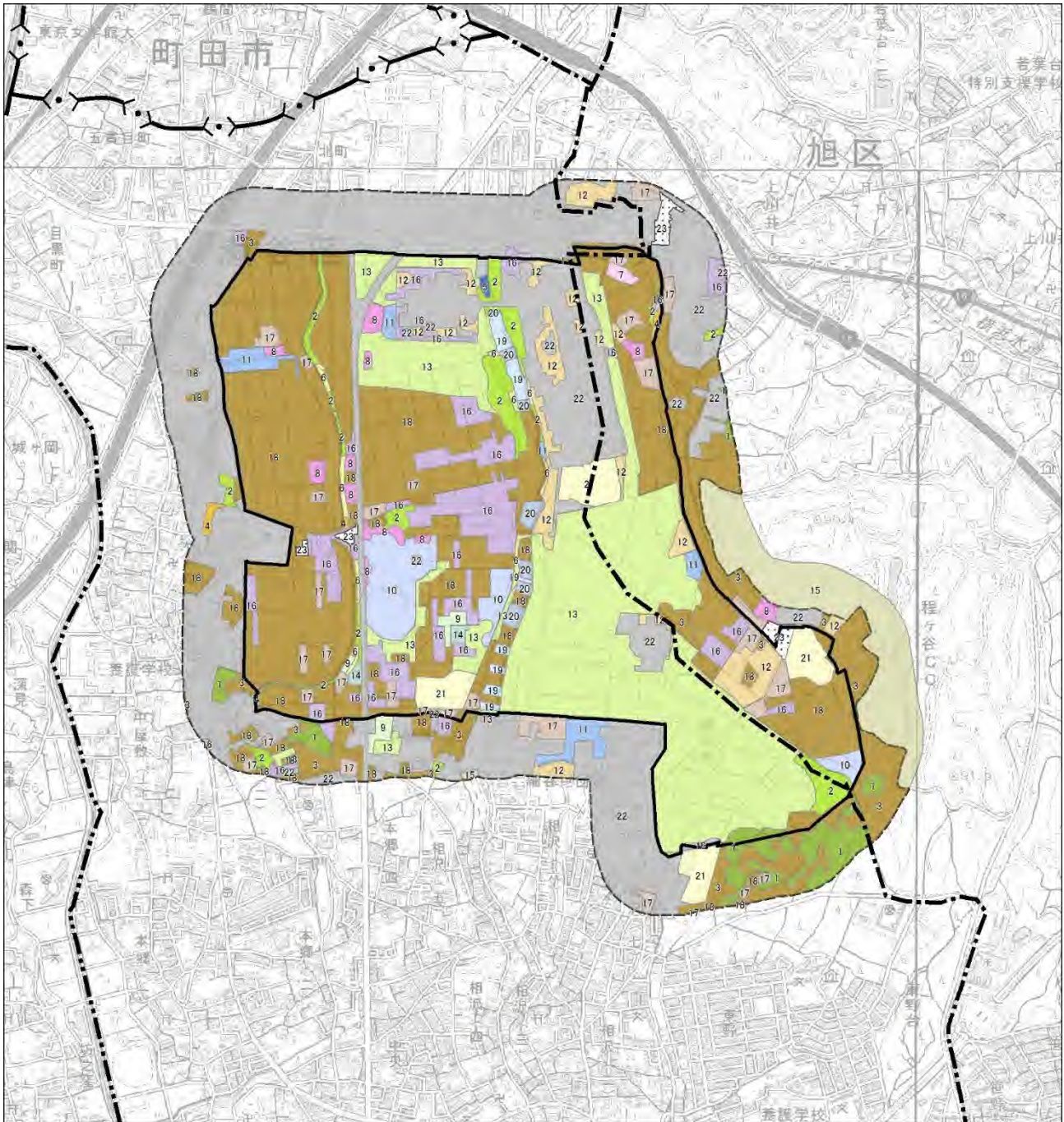
- | | |
|--|---|
| <ul style="list-style-type: none"> 1. コナラ群落 2. ムクノキ-エノキ群落 3. スギ・ヒノキ植林 4. 竹林 5. ヤナギ低木群落 6. アズマネザサ群落 7. ススキ群落 8. セイタカアワダチソウ群落 9. ヒメムカシヨモギ群落 10. イネ科草本群落 11. オギ群落 12. チガヤ群落 | <ul style="list-style-type: none"> 13. メヒバ-エノログサ群落 14. シバ草地 15. ゴルフ場 16. 植栽樹群 17. 果樹園 18. 畑地 19. 水田 20. 休耕地 21. グラウンド 22. 人工構造物 23. 造成地 |
|--|---|



図 55-6 現存植生図



図 55-7 植物調査地点と現存植生図の重ね合わせ図

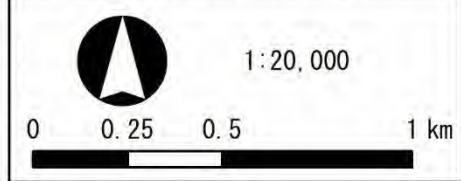

図 55-8 意見陳述人提供写真の撮影位置 (環境)

56. 農業振興地区の生態系機能を踏まえた予測評価について

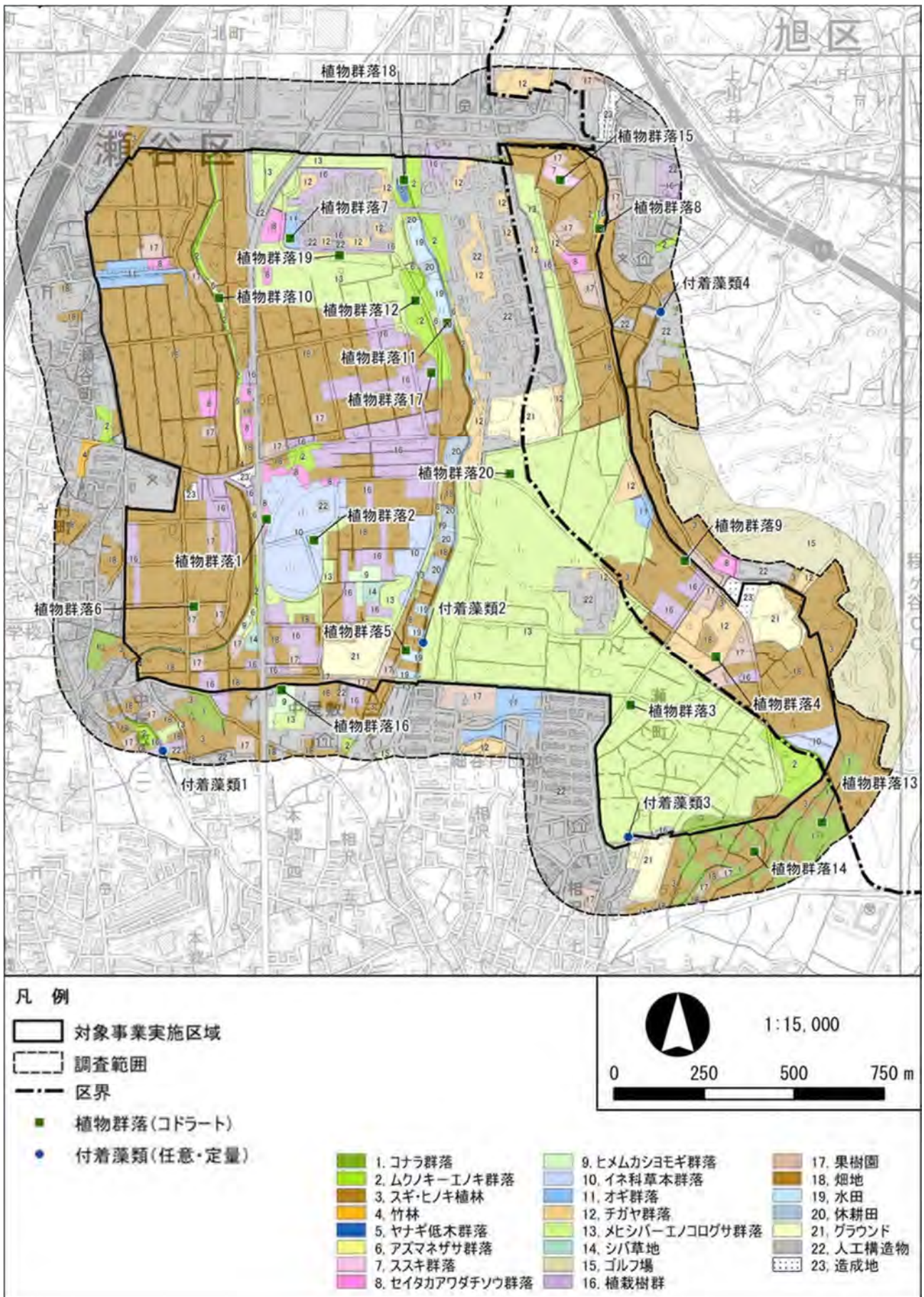
第15回審査会（令和3年11月11日）の補足資料48でお示した写真48-1に記載した擁壁は、道路と農地の境に土留めのために設置するものです。

農業振興地区の生態系機能については、第10回審査会（令和3年8月31日）の補足資料23及び第12回審査会（令和3年9月30日）の補足資料33でご説明したとおり、本事業が土地区画整理事業という特性上、具体的な農業振興地区の土地利用が決まっていますが、畦道等の農地間の空間や、農道と農地間の空間等は、農耕地周辺に生息する種にとって生息環境の代償となり得るような整備が行えるよう、地権者と調整を図りながら検討していきます。

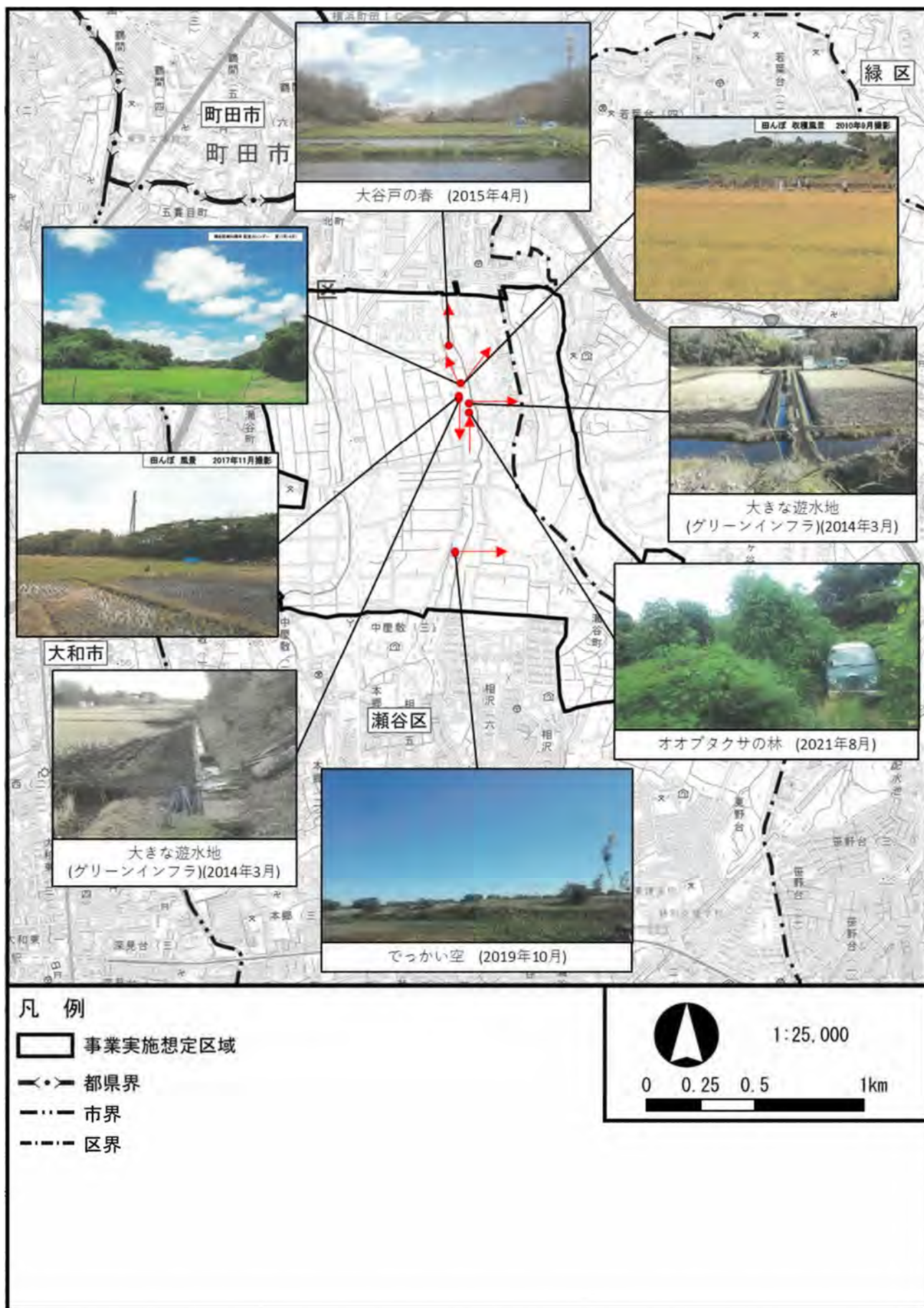
また、農業振興地区内の草地環境を周辺緑地と有機的に繋げられるように整備し、地域個体群の維持に努めます。

上記を踏まえて、以下のとおり、評価書に記載します。（準備書から変更する部分は、破線を引いた箇所になります。また、見出し番号、図番号、表番号、ページ数等は、準備書で使用した物を記載していますので、評価書では変わる可能性があります。）

9.10.2 予測及び評価の結果

(2) 環境保全措置の検討

②環境保全措置の検討の状況

表9.10-44(2) 環境保全措置の検討の状況（動物）

保全対象種	環境保全措置	実施の適否	適否の理由
モズ、カワラヒワ、アオジ、フクロウ、ハイタカ、オオタカ、ノスリ、ハヤブサ、ヒガシニホントカゲ、シマヘビ、アオダイショウ、クツワムシ、ミナミトゲヘリカメムシ、コシロシタバ	周辺の緑との連続性に配慮した緑地の創出	適	<u>周辺の緑との連続性や生物の移動、生物の生息・生育環境の繋がりに配慮して、できる限り緑地の創出を行います。</u> また、緑化には周辺樹林に生育する種から選定した樹種を植栽することから、適正な環境保全措置と考えて採用します。

③環境保全措置の実施主体、内容、効果の不確実性、他の環境への影響

表9.10-45(4) 環境保全措置の実施の内容（敷地の存在（土地の改変）－重要な種及び注目すべき生息地）

影響要因	保全対象種	影響	検討の視点	環境保全措置			実施主体	効果の不確実性	他の環境への影響
				内容	効果	区分			
土地又は工作物の存在及び供用	モズ、カワラヒワ、アオジ、フクロウ、ハイタカ、オオタカ、ノスリ、ハヤブサ、ヒガシニホントカゲ、シマヘビ、アオダイショウ、クツワムシ、ミナミトゲヘリカメムシ、コシロシタバ	重要な種の生息環境への影響	緑地及び地形の保全	周辺の緑との連続性に配慮した緑地の創出	<u>周辺の緑との連続性や生物の移動、生物の生息・生育環境の繋がりに配慮して、できる限り緑地を創出することにより重要な種の生息環境への影響の低減が見込まれます。</u>	代償	事業者	なし	なし

57. 大門川の暗渠化による影響等について

第12回審査会（令和3年9月30日）の補足資料31でお示しした内容を踏まえて、大門川の暗渠化による影響等について、評価書に次のとおり記載します。（準備書から変更する部分は、破線を引いた箇所になります。また、見出し番号、図番号、表番号、ページ数等は、準備書で使用した物を記載していますので、評価書では変わる可能性があります。）

なお、評価書では相沢川の暗渠化による影響についても記載しますが、補足資料上は大門川に係る内容を記載しています。

9.4.3 予測及び評価の結果（水の汚れ）

(1) 予測

③ 予測対象時期

「9.4.2 予測及び評価の結果（水の濁り）」と同じ時期及び河川の暗渠化に係る工事完了時としました。

④ 予測方法（以下の文章を追記します。）

河川の暗渠化による影響については、藻類による酸素供給の視点を踏まえ、水の濁りへの影響も含め、定性的に予測しました。

⑤ 予測結果

イ. 予測結果（以下の文章を追記します。）

都市計画対象事業の実施に伴い、大門川が暗渠化された場合、藻類による酸素供給ができなくなるため、好気性細菌による浄化機能は低下すると思われま

a 大門川について

大門川については、北町の工場地帯を流下してから対象事業実施区域内に入ることもあり、令和元年度の現地調査時の観測では、上流側（対象事業実施区域の北端部付近）では、豊水期、渇水期ともにBODや全亜鉛について環境基準値を超過しています。また、上流側の水質調査地点付近には川底に土砂が堆積しており、降雨がない場合においても水の濁りが目視で確認できる場合があります（表9.4-5（2）参照）。また、上流側の水質が悪いこともあり、pHを除くほぼ全ての水質項目で上流側よりも下流側の水質は良好となっており、濁り成分の沈降、吸着に加えて、下流側でBODが低下し、DOが上昇していることを踏まえると、川底の藻類等の光合成による酸素供給及び河床の従属栄養の好気性菌類（生物膜）による水質浄化機能を有していると考えられます。

水の汚れについては、上流側の工場地帯の排水がその要因になっていると考えられますが、暗渠化により、対象事業実施区域内におけるこれらの水の汚れの浄化機能は低下するものと思われま

一方、水の濁りについては、大門川上流側の水質調査地点である「水質1」(P.9.4-5 (図9.4-1)参照)付近において非耕作期にその周辺の農耕地が裸地状態になり、大門川に土砂が流れ込みやすくなっている状況であるため、暗渠化に併せて、暗渠入口周辺の舗装や土砂流出防止柵設置等により、「水質1」付近における河川への土砂流入を防ぐことで、水の濁りなどが低減されると考えられます。

(4) 事後調査

本予測項目で採用した予測手法は、アルカリ排水の処理や造成工事に先立って汚染土壌の拡散防止のための措置が講じられることを前提としたものですが、造成工事において予期せぬ廃棄物等に遭遇する可能性を完全には否定できないことなどから、予測の不確実性はあると考えられます。また、暗渠化による影響についても、不確実性があると考えられます。

したがって、本予測項目に対して、環境影響評価法に基づく事後調査を表9.4-22に示すように実施します。

なお、事後調査の結果、環境基準に適合しない結果となった場合など、都市計画対象事業による著しい影響がみられた場合は、多岐にわたる環境保全措置から当該汚染の状況を踏まえて効果的な対策を選定し、講じるものとします。

表 9.4-22 事後調査の項目等 (水の汚れ)

環境影響評価項目			事後調査の 時期及び頻度	事後調査を行う こととした理由	事後調査の項目	事後調査の手法
環境要素	影響要因					
水環境	水質 水の 汚れ	雨水の排水	工事中、工事の完了後における適切な時期・頻度とします。	予測結果に不確実性を伴うため。	「水質汚濁に係る環境基準について」別表1に掲げる27項目、及び同別表2の1(1)河川(湖沼を除く。)に掲げる8項目、電気伝導率等、並びにダイオキシン類	現地調査による確認。

また、大門川の流量については、準備書の表9.7-4(P.9.7-5)に記載したとおり、豊水期、渇水期ともに上流よりも下流で流量が多くなっています。

表 9.7-4 河川流量の現地調査結果

単位：m³/s

地点 時期	水質1 大門川 上流	水質2 大門川 下流	水質3 相沢川 上流	水質4 相沢川 下流	水質5 堀谷戸川	水質6 和泉川
豊水期	0.0163	0.0214	0.0071	0.0434	0.0144	0.0027
渇水期	0.0078	0.0166	0.0076	0.0262	0.0080	0.0023
降雨時1	0.2233	0.3329	0.0499	0.1813	0.0304	0.0110
降雨時2	3.0371	2.4686	0.4459	0.0851	0.4153	0.0608

また、準備書の表 9.7-11 (P.9.7-13) に記載しているとおり、事後調査を行うとともに、第 10 回審査会 (令和 3 年 8 月 31 日) の補足説明資料 26 でお示ししたとおり、準備書の現地調査を行った地点において、10mm 程度以上の降雨時に年間 4 回の測定を行うとともに、仮設調整池出口における放流量について連続的なデータを収集することでモニタリングを行うこととします。

なお、審査会でお示ししたモニタリングを実施する項目等については、評価書に記載します。

表 9.7-11 事後調査の項目等 (河川の形態、流量)

環境影響評価項目		事後調査の 時期及び頻度	事後調査を行うこと とした理由	事後調査の項目	事後調査の手法	
環境要素	影響要因					
水環境	その他の水環境 ―河川の形態・流量	敷地の存在 (土地の改変)	工事中、工事の完了後における適切な時期・頻度とします。	環境保全措置の効果の程度を定量的に把握するため。	河川の流量	水質の事後調査に合わせて現地調査により確認。

58. 桜並木の景観について（継続）

準備書の審査において、「遠方から見た海軍道路の桜並木の評価を行った方が良い。」というご指摘を受け、評価書では次のとおり記載します。（準備書から変更する部分は、波線を引いた箇所になります。また、見出し番号、図番号、表番号、ページ数等は、準備書で使用した物を記載していますので、評価書では変わる可能性があります。）

9.13.1 調査結果の概要

(3) 調査地域・調査地点

②調査地点

ウ. 主要な眺望景観、圍繞景観の状況

b. 現地調査（P. 9.13-3）

都市計画対象事業の環境影響評価方法書において、現地調査地点として記載された表 9.13-4 の 14 地点は、現地踏査により No. 1 「瀬谷市民の森」以外は対象事業実施区域を視認できませんでした。よって、対象事業実施区域が視認でき、かつ不特定多数の人が集まると想定される表 9.13-5 に示す 7 地点 を現地調査地点として追加しました。現地調査地点の位置は、図 9.13-1(1) に示すとおりです。

表 9.13-1 現地調査地点（追加分）

No.	名称	No.	名称
①	瀬谷市民の森	⑤	竹村町公園
②	瀬谷みはらし公園	⑥	上瀬谷町東公園
③	中屋敷三丁目公園	⑦	<u>瀬谷区上瀬谷町</u>
④	本郷四丁目第二公園		



図 9.13-1(1) 現地調査地点 (主要な眺望景観)

9.13.2 調査及び評価の結果

(1) 予測

⑤ 予測結果

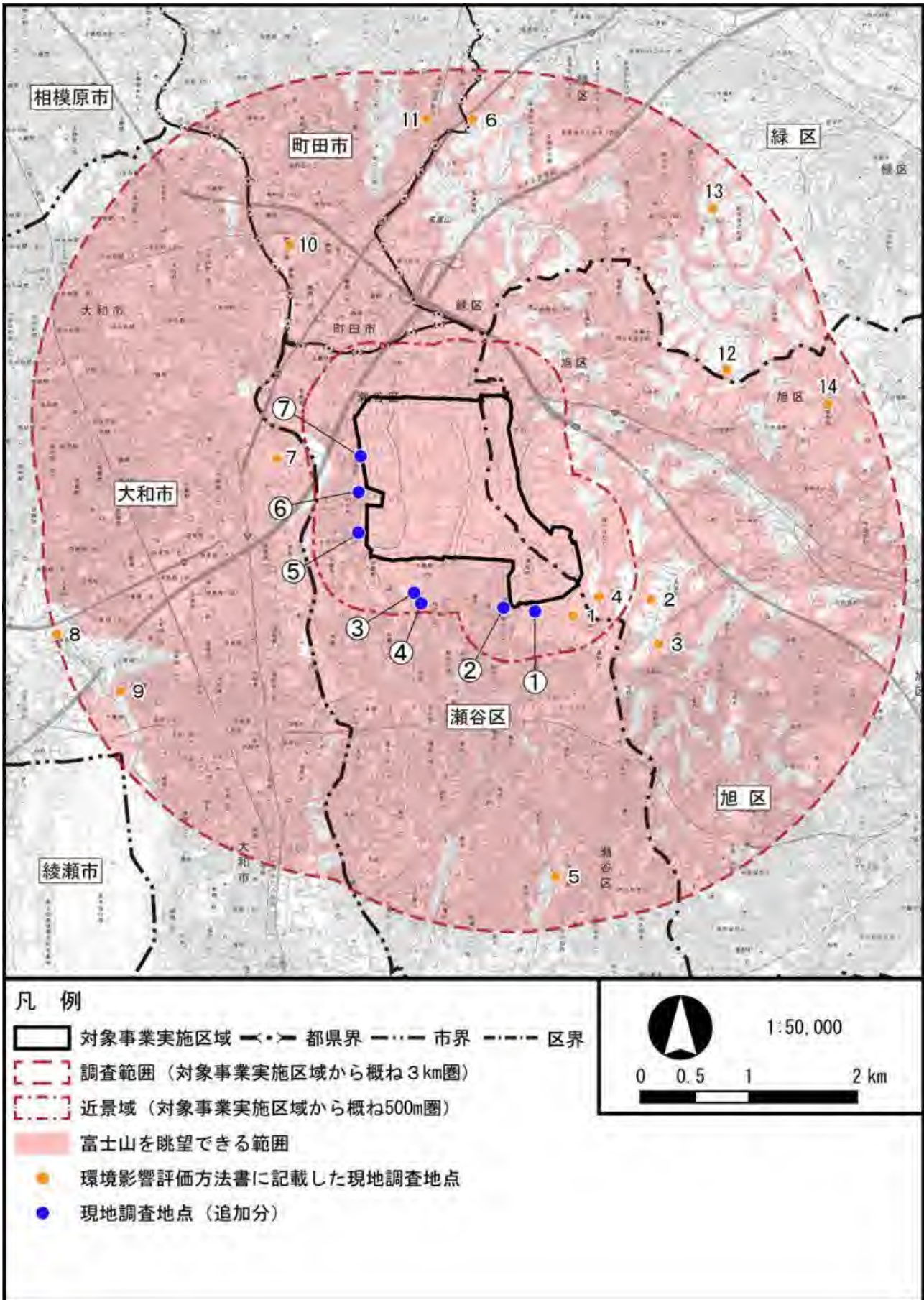
ウ. 主要な眺望景観の状況

g. No. 7 瀬谷区上瀬谷町

(P. 9. 13-36 の後ろに記載します。新規の地点なので、全部が準備書から追加です。)

本地点は対象事業実施区域の西側の道路上に位置します。

本地点からは、写真 9. 13-18(1) に示すように、正面に農道が東に向かって通っており、その左右に畑が広がっています。また農道の突き当りには海軍道路の桜並木、そして更にその奥には、対象事業実施区域内の樹木が眺望できます。なお、現況写真は 2021 年 10 月に撮影を行いました。海軍道路の桜並木が分かる様に加工を行っています。

敷地の存在時においては、写真 9. 13-18(2) に示すように、本地点から視認できる範囲は、農業振興地区として改変します。そのほとんどが道路と擁壁になり、それ以外は、海軍道路の桜並木や奥の樹木が伐採され対象事業実施区域の東側の樹木を望む眺望景観となり、大きく変化するものと予測します。

また、海軍道路の拡幅整備に伴い現在の桜並木は伐採しますが、拡幅整備後、「海軍道路の桜並木に関する懇談会」(P. 2-59 参照) での検討状況を踏まえ、新たな街路樹が創出され、本地点から眺望できると予測します。

構造物の存在時においては、写真 9. 13-18(3) に示すように、本地点からは区域内道路、調整池等の構造物は視認できませんが、敷地の存在時と同じく眺望景観が大きく変化するものと予測します。



写真 9. 13-18(1) No. 7 瀬谷区上瀬谷町(現況:海軍道路の桜並木が分かる様に加工済)



写真 9.13-18(2) No. 7 瀬谷区上瀬谷町 (敷地の存在)



写真 9.13-18(3) No. 7 瀬谷区上瀬谷町 (構造物の存在)

(2) 環境保全措置の検討

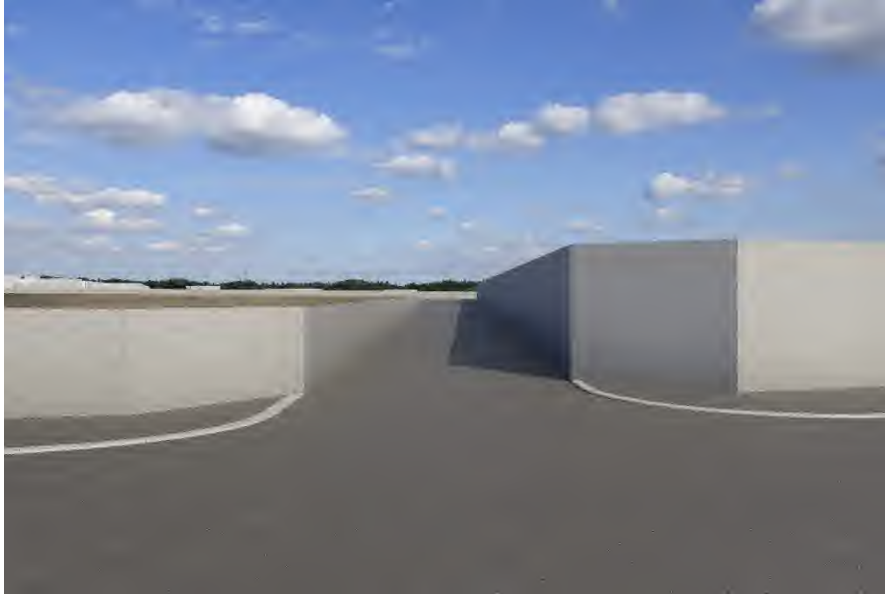
③ 環境保全措置の検討の状況 (P. 9. 13-48)

事業者の実行可能な範囲内でできる限り、環境影響を回避、低減又は代償することを目的として行った環境保全措置の検討の状況を、表 9. 13-18 に示します。

表 9. 13-18 環境保全措置の検討の状況

環境保全措置	実施の 適否	適否の理由
緑地等の保全に配慮した土地利用計画	適	農業振興地区、公益的施設用地等を適切に配置して緑地、農地の景観を保全することにより、景観への影響を低減できるため、適正な環境保全措置であると考えて採用します。
緑地の創出	適	改変部分にできる限り緑地を創出し、緑化に当たっては周辺構成種を植栽することにより、景観への影響を軽減できるため、適正な環境保全措置であると考えて採用します。
桜並木等の創出	適	消失する対象事業実施区域内の桜並木等（全長約 1.5km）の代償として、対象事業実施区域内の海軍道路（全長約 1.5km）や区域内道路（全長約 4.8km）に対して、新たな桜並木等を創出することにより、景観への影響を低減できるため、適正な環境保全措置であると考えて採用します。
遠景の眺望に配慮した土地利用計画	適	丹沢山地や富士山が眺望できるように配慮した将来の土地利用計画を促し、景観への影響を軽減できるため、適正な環境保全措置であると考えて採用します。

④ 環境保全措置の実施主体、内容、効果の不確実性、他への影響 (P. 9. 13-48)

敷地の存在及び構造物の存在に伴う主要な眺望点及び景観資源並びに主要な眺望景観及び囲繞景観への影響を低減させるため、表 9. 13-19 に示すとおり、環境保全措置を実施します。

表 9.13-19 環境保全措置の実施の内容

影響要因	影響	検討の視点	環境保全措置			実施主体	効果の不確実性	他の環境への影響	
			内容	効果	区分				
土地又は工作物の存在及び供用	敷地の存在・構造物の存在	景観への影響	緑地及び地形の保全	緑地等の保全に配慮した土地利用計画	眺望景観、圍繞景観への影響の低減が見込まれます。	低減	事業者	なし	なし
				緑地の創出	眺望景観、圍繞景観への影響を代償できます。	代償	事業者	なし	なし
				桜並木等の創出*	眺望景観、圍繞景観への影響が代償できます。	代償	事業者	なし	なし
				遠景の眺望に配慮した土地利用計画	眺望景観、圍繞景観への影響の低減が見込まれます。	低減	事業者	なし	なし

※：海軍道路の桜並木については、第2章 2.3.7 (4) ③イ.海軍道路の桜並木の検討状況 (P.2-61) 参照。

(3) 評価

① 評価手法

ア. 環境影響の回避、低減に係る評価 (P. 9.13-49)

景観に係る環境影響が、事業者の実行可能な範囲内でできる限り回避され、又は低減されており、必要に応じその他の方法により環境の保全についての配慮が適正になされているかどうかについて、見解を明らかにすることにより、評価を行いました。

② 評価結果

ア. 環境影響の回避、低減に係る評価 (P. 9.13-49)

眺望景観への影響の低減の適切な環境保全措置を講じることから、事業者の実行可能な範囲内でできる限り、環境影響の低減が図られると評価します。

59. 鎌倉古道の一部改変に伴う人と自然との触れ合いの活動の場への影響について（継続）

準備書の審査において、「鎌倉古道 北コースについて、どこでどの程度影響があるという情報がない。」というご指摘を受け、評価書では次のとおり記載します。（準備書から変更する部分は、波線を引いた箇所になります。また、見出し番号、図番号、表番号、ページ数等は、準備書で使用したものを記載していますので、評価書では変わる可能性があります。）

9.14.1 調査結果の概要

(5) 調査結果

②主要な人と自然との触れ合いの活動の場の分布、利用の状況及び利用環境の状況

オ. 鎌倉古道 北コース (P.9.14-11)

鎌倉古道 北コースの現況は、写真 9.14-5 に示すとおりです。

鎌倉古道 北コースとは、瀬谷区が配布を行っている「瀬谷ふるさと歴史さんぽ道ガイドマップ」の中の一つで、全5コースが用意されています。

鎌倉古道 北コースは、相鉄本線の北側の鎌倉古道・上道（かみのみち）沿道にある神社仏閣や、瀬谷最大の農業地である上瀬谷農業専用地区、環状4号線（海軍道路）を巡る約7.5kmのハイキングコースです。

北コースに沿って歩いていくと、途中には神社仏閣以外にも、かつての川口製絲株式會社の正門跡、市名木・古木指定のケヤキ、瀬谷銀行跡等を見ることができます。

なお、北コースに含まれる上瀬谷農業専用地区を東西に横断する道路と、環状4号線（海軍道路）の一部（約600m）は、対象事業実施区域内となっています。

また、瀬谷区では瀬谷の魅力を知らってもらう取組として、ふるさと歴史さんぽ道ウォーキング事業を行っており、参加者にはガイドマップの配布や「ウォーキングせやまるグッズ」の記念品をプレゼントしています。平成29年度から令和元年度の参加者数（利用者数）の延べ人数は681人となっています。

9.14.2 予測及び評価の結果

(1) 予測

④予測手法

ア. 主要な人と自然との触れ合いの活動の場の改変の程度 (P.9.14-22)

都市計画対象事業の事業計画と主要な人と自然との触れ合いの活動の場の位置を重ね合わせて、予測地点が敷地の存在時、構造物の存在時において、どの程度改変するのかを把握することで、影響の程度を定性的に予測します。

イ. 利用性の変化の程度 (P.9.14-22)

工事用車両の運行における計画、及び関係車両の走行における計画から、予測地点の利用性（人と自然との触れ合いの活動の場へのアクセス路）がどの程度変化するかを把握することで、影響の程度を定性的に予測します。

ウ. 快適性の変化の程度 (P. 9. 14-22)

都市計画対象事業の事業計画と主要な人と自然との触れ合いの活動の場の位置を重ね合わせて、予測地点が敷地の存在時、構造物の存在時において、快適性（景観の変化等）がどの程度変化するかを把握することで、影響の程度を定性的に予測します。

⑤ 予測結果

イ. 予測結果

a. 主要な人と自然との触れ合いの活動の場の改変の程度 (P. 9. 14-27)

敷地の存在（土地の改変）、構造物の存在による主要な人と自然との触れ合いの活動の場への改変の程度の予測結果は、表 9. 14-8 に示すとおりです。

海軍道路の桜並木と鎌倉古道 北コースに改変があると予測します。

表 9. 14-8 主要な人と自然との触れ合いの活動の場の改変の程度の予測結果

予測地点	改変の程度
鎌倉古道 北コース	鎌倉古道 北コースのうち、海軍道路の一部（約 600m）は対象事業実施区域に含まれ、海軍道路の一部の桜並木の消滅が考えられることから活動の場の改変が起こり、レクリエーション行動への影響が生じると予測します。一方、神社仏閣等が集まっている対象事業実施区域の南から西側部分のコースは、対象事業実施区域外のため、影響は生じないと予測します。

注：紙面の都合上、鎌倉古道 北コースのみ記載しました。

b. 利用性の変化の程度 (P. 9. 14-28)

工事用車両の運行及び関係車両の走行による主要な人と自然との触れ合いの活動の場への利用性の変化の程度の予測結果は、表 9. 14-9 に示すとおりです。

海軍道路の桜並木、鎌倉古道 北コース、武相国境・緑の森コース、及び瀬谷市民の森に利用性の変化があると予測します。

表 9. 14-9 利用性の変化の程度の予測結果

予測地点	変更の程度
鎌倉古道 北コース	<p>鎌倉古道 北コースのうち、上瀬谷農業専用地区を東西に横断する道路と海軍道路の一部（約 600m）は、対象事業実施区域に含まれているため、工事用車両及び関係車両が通行します。工事中は、上瀬谷農業専用地区を東西に横断する道路と海軍道路については、仮設道路を設ける可能性があることから、利用性の変化が起こり、レクリエーション行動への影響が生じると予測します。</p> <p>また、上瀬谷農業専用地区を東西に横断する道路は、現況は、歩道が整備されていませんが、将来、歩道が整備される計画です。</p> <p>一方、神社仏閣等が集まっている対象事業実施区域の南から西側部分のコースは、対象事業実施区域外のため、影響は生じないと予測します。</p>

注：紙面の都合上、鎌倉古道 北コースのみ記載しました。

c. 快適性の変化の程度（P. 9. 14-29）

主要な人と自然との触れ合いの活動の場への快適性の変化の程度の予測結果は、表 9. 14-10 に示すとおりです。

海軍道路の桜並木、鎌倉古道 北コース、瀬谷市民の森、及び上川井市民の森に快適性の変化があると予測します。

表 9. 14-10 快適性の変化の程度の予測結果

予測地点	変更の程度
鎌倉古道 北コース	<p>鎌倉古道 北コースのうち、海軍道路の一部（約 600m）は対象事業実施区域に含まれ、海軍道路の一部の桜並木の消滅が考えられることから快適性の変化が起こり、レクリエーション行動への影響が生じると予測します。</p> <p>一方、神社仏閣等が集まっている対象事業実施区域の南から西側部分のコースは、対象事業実施区域外のため、影響は生じないと予測します。</p>

注：紙面の都合上、鎌倉古道 北コースのみ記載しました。

(2) 環境保全措置の検討

①環境保全措置の検討の状況 (P. 9. 14-30)

事業者の実行可能な範囲内でできる限り、環境影響を回避、低減又は代償することを目的として行った環境保全措置の検討の状況を、表 9. 14-11 に示します。

表 9. 14-11 環境保全措置の検討の状況 (人と自然との触れ合いの活動の場)

環境保全措置	実施の適否	適否の理由
工事の内容等の 早期周知	適	工事の内容、作業期間、アクセス路等について、可能な限り早期に周知することで、人と自然との触れ合いの活動の場を利用される方への影響が低減されることから、適正な環境保全措置であると考えて採用します。
桜並木等の創出	適	拡幅整備する海軍道路又は対象事業実施区域内の道路の沿道に新しい桜並木等の創出を行うことで、現在の海軍道路の桜並木の代償になることから、適正な環境保全措置であると考えて採用します。
緑地の創出	適	対象事業実施区域の主に南東側に存在する市民の森との連続性や周辺からの眺望に配慮して、対象事業実施区域内には、できる限り緑地の創出をすることから適正な環境保全措置であると考えて採用します。
公共交通機関の 利用促進	適	将来の土地利用者に、来場の際、公共交通機関の利用を促進する活動を促すことにより、関係車両の台数が減少し、人と自然との触れ合いの活動の場の利用性への影響が低減されることから、適正な環境保全措置であると考えて採用します。
車両の効率的な 利用促進	適	将来の土地利用者に、車での来場の際の相乗りや、物流など関係車両の効率的な運行管理等による車両の効率的な利用を促進する活動を促すことにより、走行台数の削減や、走行時間帯の集中抑制を図ることができ、人と自然との触れ合いの活動の場の利用性への影響が低減できることから、適正な環境保全措置であると考えて採用します。
安全運転の啓蒙	適	工事車両や将来の土地利用者に関係車両へ安全な利用を促進する活動を行うことにより、人と自然との触れ合いの活動の場の利用性への影響の低減が図れることから、適正な環境保全措置であると考えて採用します。

②環境保全措置の実施主体、内容、高架の不確実性、他への影響 (P. 9. 14-30)

工事用車両の運行、敷地の存在 (土地の改変)、構造物の存在、及び関係車両の走行に伴う主要な人と自然との触れ合いの活動の場への影響を低減させるため、表 9. 14-12 に示すとおり、環境保全措置を実施します。

表 9.14-12 環境保全措置の実施の内容（人と自然との触れ合いの活動の場）

影響要因	影響	検討の視点	環境保全措置			実施主体	効果の不確実性	他の環境への影響
			内容	効果	区分			
工事の実施	工事用車両の運行	利用性快適性への影響	交通安全	安全運転の啓蒙 交通に伴う安全への配慮を促すことにより、人と自然との触れ合いの活動の場への影響が低減されます。	低減	事業者	なし	なし
				工事の内容等 の早期周知	工事の内容等を可能な限り早期に周知することで、利用者への影響が低減されます。	低減	事業者	なし
土地又は工作物の存在及び供用	敷地の存在 （土地の改変）	利用性快適性への影響	桜の再生	桜並木等の創出* 新しい桜並木等を創出することで、人と自然との触れ合いの活動の場への影響が代償されます。	代償	事業者	なし	なし
			緑地の連続確保	緑地の創出 市民の森との連続性や周辺からの眺望に配慮できます。	代償	事業者	なし	なし
	関係車両の走行	利用性快適性への影響	交通安全	公共交通機関の利用促進 人と自然との触れ合いの活動の場の利用性への影響が低減されます。	低減	事業者	なし	なし
				車両の効率的な利用促進 人と自然との触れ合いの活動の場の利用性への影響が低減されます。	低減	事業者	なし	なし
				安全運転の啓蒙 人と自然との触れ合いの活動の場の利用性への影響が低減されます。	低減	事業者	なし	なし

※：海軍道路の桜並木については、第2章 2.3.7 (4) ③イ.海軍道路の桜並木の検討状況（P.2-61）参照。

(3) 評価

②評価結果

ア. 環境影響の回避、低減に係る評価 (P. 9. 14-31)

主要な人と自然との触れ合いの活動の場の改変の程度については、瀬谷市民の森をはじめとする予測地点に対しては、都市計画対象事業による直接的な改変はありません。一方、都市計画対象事業により海軍道路の桜並木が消滅します。しかし幅~~整備~~された海軍道路又は対象事業実施区域内の道路の沿道に、新しい桜並木等を創出する計画としています。

利用性の変化の程度については、追分市民の森をはじめとする予測地点に対しては、工事車両及び関係車両は通行しないため、影響はないと予測します。一方、工事中は、対象事業実施区域に含まれている上瀬谷農業専用地区を東西に横断する道路と海軍道路については、仮設道路を設ける可能性があります。そのため、工事の内容等を可能な限り早期に周知することとします。関係車両が走行するルートは、歩道等を整備する予定ですので、利用性の変化は小さいと考えられます。

快適性への変化の程度については、追分市民の森をはじめとする予測地点に対しては、予測地点からは対象事業実施区域を望むことができず、瀬谷市民の森、上川井市民の森は対象事業実施区域に隣接しますが、公益的施設用地として計画されているため、快適性の変化はない又は小さいと予測します。一方、海軍道路の桜並木が消滅しますが、代償措置として新しい桜並木等が創出される計画となっています。

以上のことから、事業者の実行可能な範囲内でできる限り、環境影響の低減が図られると評価します。

60. 盛土の高さについて

準備書に示した4つの断面(図60-1)での、現況における標高と敷地の存在時、構造物の存在時における造成面の標高を描いた断面図及び最大となる盛土厚、切土厚は図60-2に示すとおりです。

盛土を行うことによる流量、湧水及び水の濁りについては、以下のように考えています。敷地の存在時における河川流量の予測に用いた流出係数は「横浜市開発事業の調整等に関する条例の手引き」により、 $f=0.85$ としており、「流出雨水量の最大値を算出する際に用いる土地利用形態ごとの流出係数を定める告示」に示される造成裸地の $f=0.5$ よりも、安全を見込んで設定しています。したがって、盛土を行うことによる河川流量への影響が準備書で示した結果を超えるようなことはないと考えます。

また、大門川流域については、湧水はなく、当該箇所での盛土による湧水への影響はないものと考えます。

造成工事中の雨水の排水による水の濁りへの影響については、国交省告示の造成裸地の区分の流出係数($f=0.5$)を設定しており、当該盛土に近い予測条件となっていることから、準備書における予測・評価結果に示すように、仮設調整池5、6で濁りを除去することにより日常的な降雨時においては、環境基準を超えるようなSS濃度にはならないと考えています。

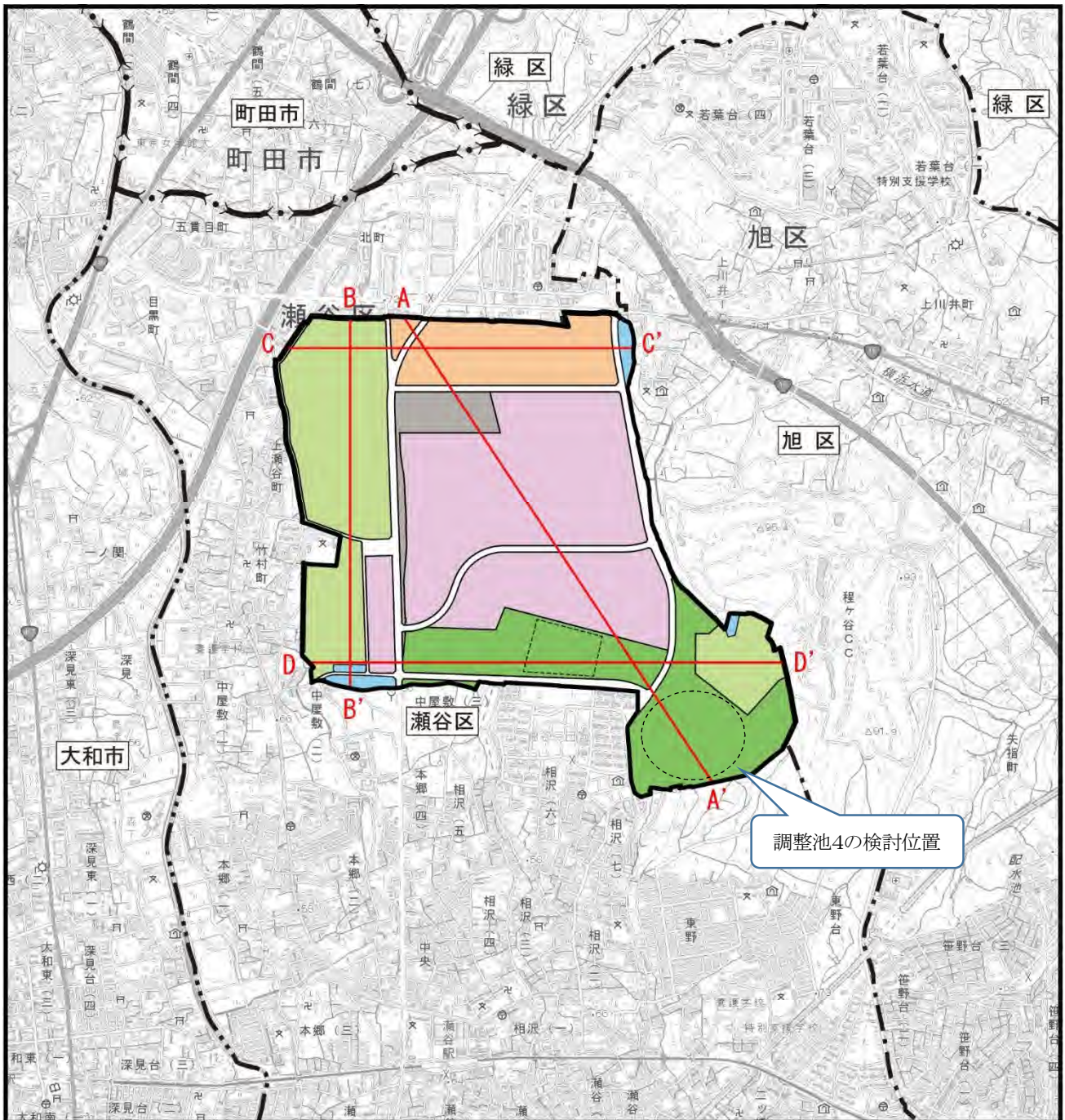

凡例

対象事業実施区域
 都県界
 市界
 区界

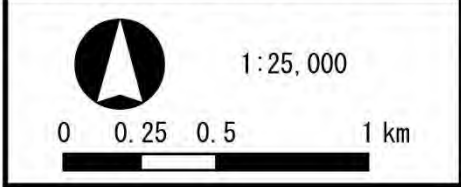

- | | |
|--|--|
| <ul style="list-style-type: none"> 農業振興地区 観光・賑わい地区 物流地区 公益的施設用地（公園・防災等用地） 交通施設用地 | <ul style="list-style-type: none"> 道路 調整池（地上式） 公益的施設内調整池（地下式） 断面線位置 |
|--|--|

※調整池4：生息環境の創出に寄与する調整池（地上式）について公園整備事業等と調整を図りながら検討

図 60-1 断面図を作成した位置



図 60-2(1) 模式断面図 (A - A' 断面)



図 60-2(2) 模式断面図 (B - B' 断面)

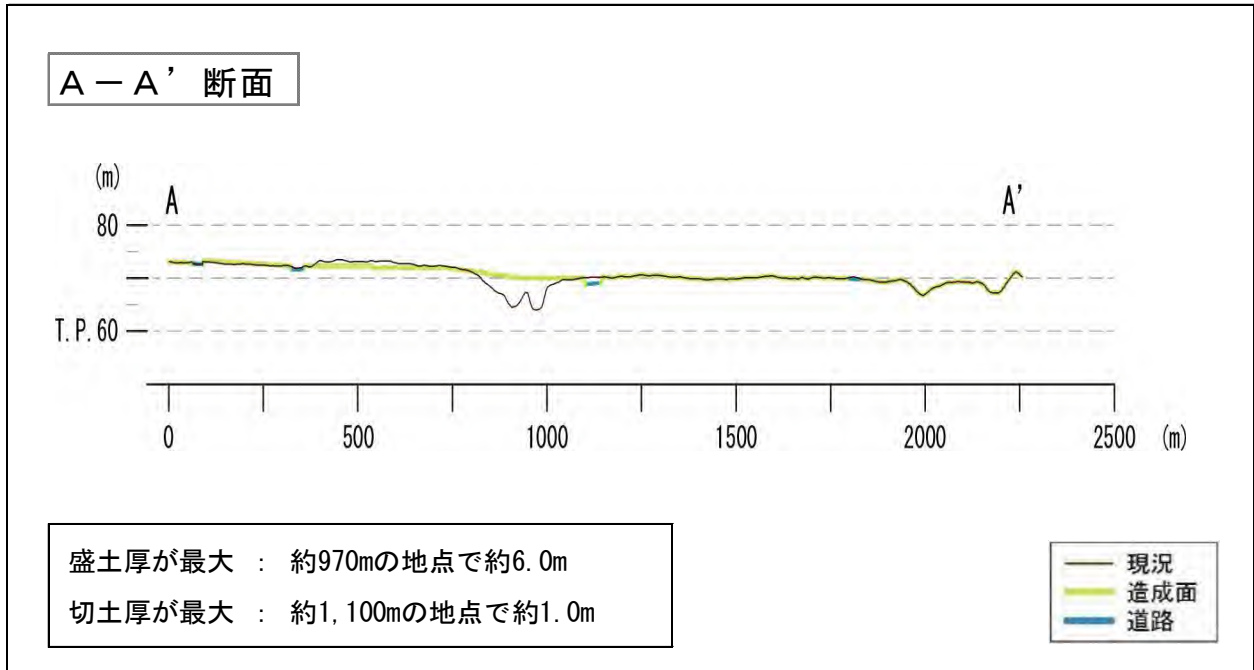

図 60-2 (3) 模式断面図 (C - C' 断面)

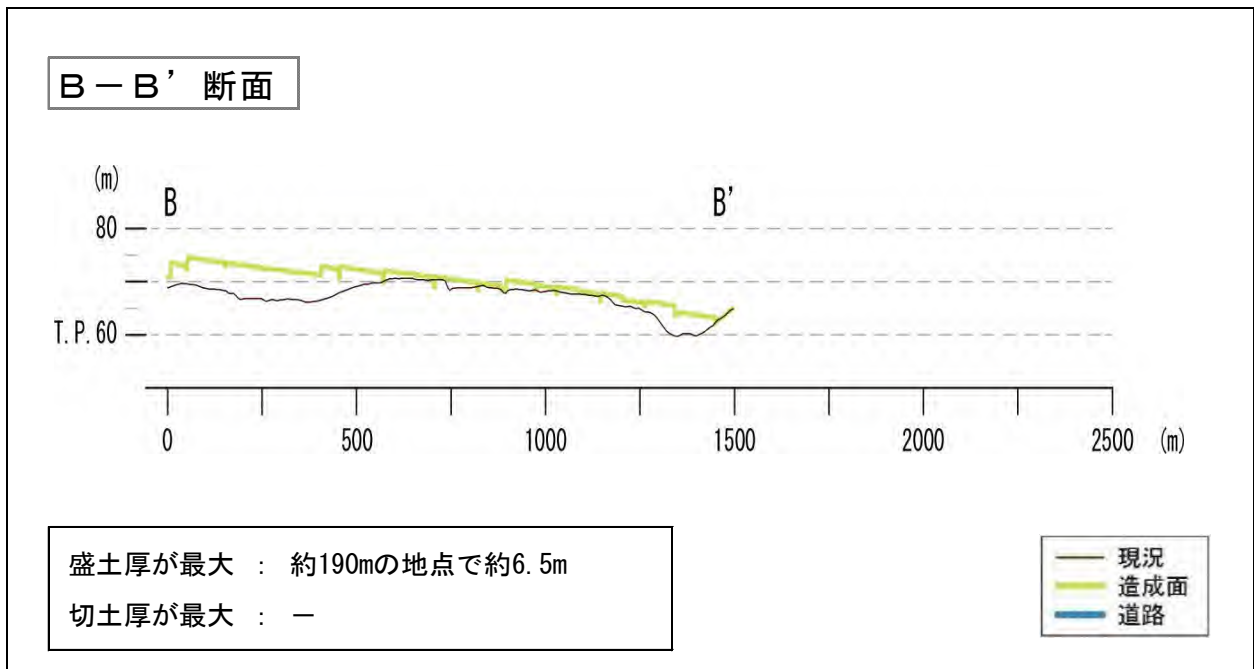

図 60-2 (4) 模式断面図 (D - D' 断面)

61. 調整池 4 を地上式とした場合の影響について

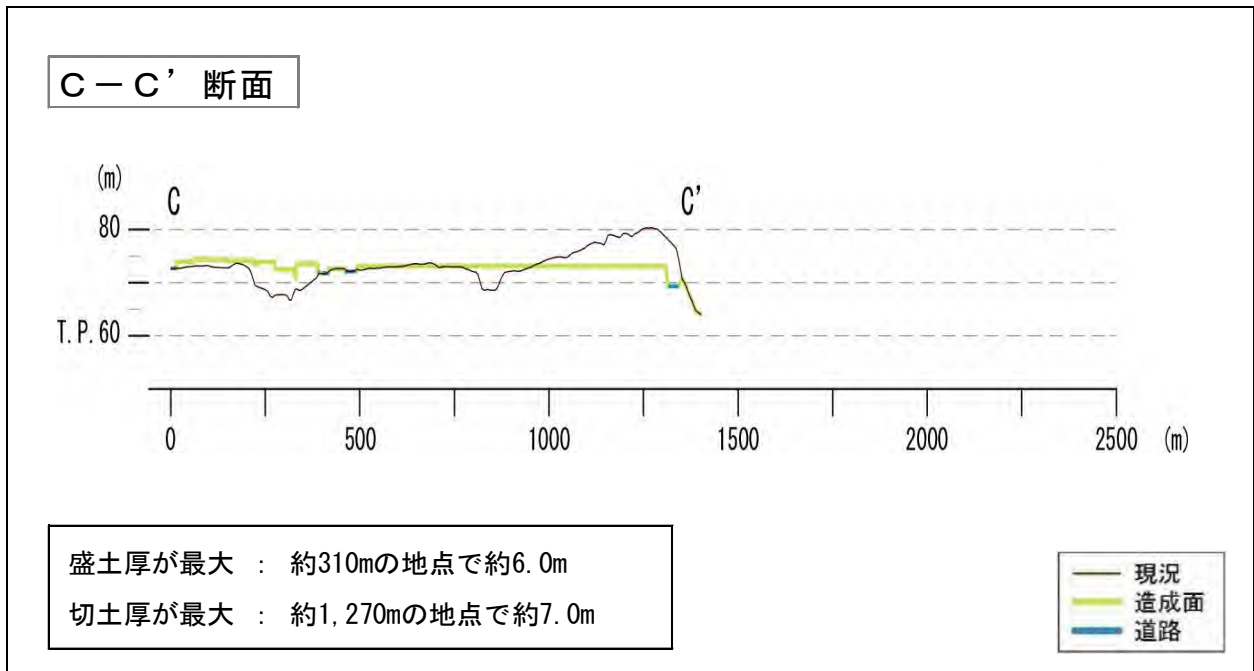
調整池放流口における SS の濃度については、濁り成分の沈降時間に左右されますが、沈降時間は流入量に対する調整池の容量で決まります。また、河川の流量についても調整池からの最大放流量が放流先河川の許容放流量以下になるように、貯留容量が計画されているかどうかで影響予測をしています。

調整池 4 については、審査会でのご指摘も踏まえ、今後、公園整備事業等と調整を図りながら、地形や自然豊かな環境をいかし、動植物の生息環境の創出に寄与するような調整池を検討する中で、面積についても検討していきますが、容量に変化はないため、土地区画整理事業の実施による水の濁り及び河川の流量における予測評価が変わることはありません。

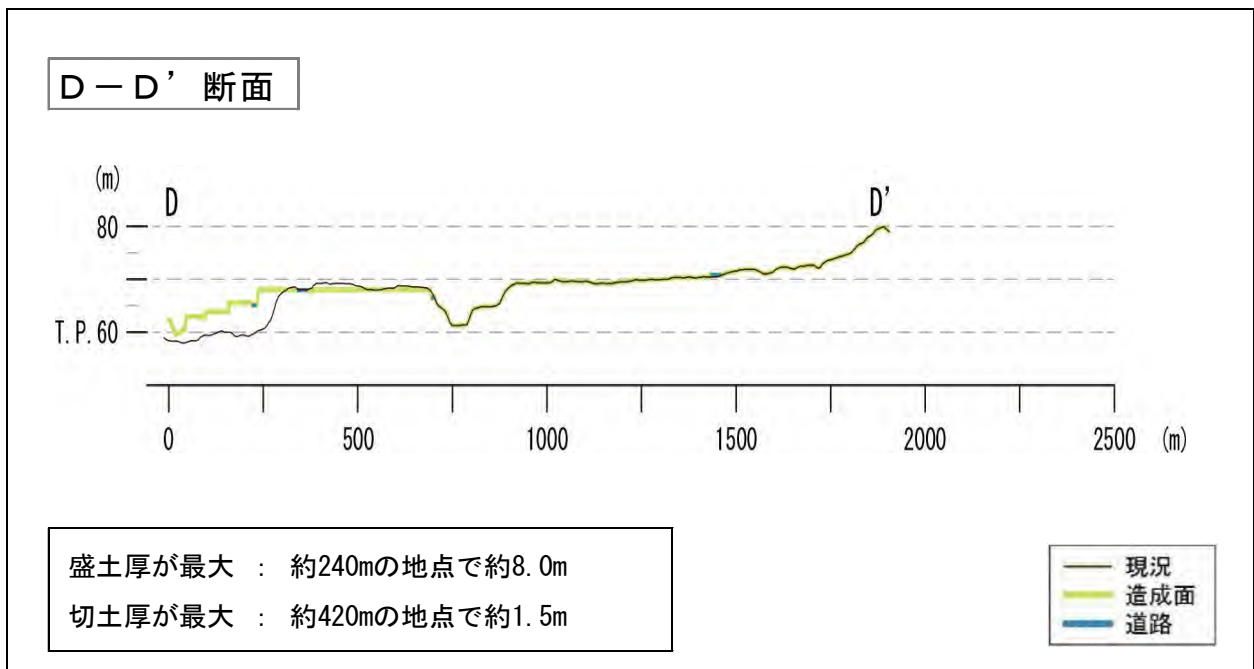
また、準備書でお示ししている「切土・盛土の状況」の図は、土地の造成に伴う切土・盛土を示したものになるため、調整池 4 が地上式となっても特に変更はありません。

なお、前回の審査会で公園整備事業から、「みどりの実践エリア」における公園整備と生態系の保全措置の両立のあり方は、「現在の湧水環境等に配慮した水辺空間」「生息環境の創出に寄与するような調整池」等を踏まえて具体的な施設配置計画の検討を行う旨、補足説明をさせていただいております。

62. 公益的施設用地における防災機能について

広域応援活動拠点とは、消防、警察、自衛隊などの応援部隊が被災地の近くで円滑に救助・救出活動を行うための活動拠点であり、部隊の指揮、資機材及び支援物質の集積、燃料の備蓄と補給、部隊の宿営のスペースが求められます。

土地区画整理事業は、土地の造成及び公共施設の整備を行うものです。本事業によって、対象事業実施区域全域を改変することとなるため、動植物・生態系への代償措置として、公益的施設用地内に保全対象種の生息環境を新たに創出していきます。

この生息環境以外で、広域応援活動拠点としての機能が位置付けられるよう、関係部署に引き継いでいきます。